

RADIO TEST REPORT

FCC 47 CFR PART 15 SUBPART C

INDUSTRY CANADA RSS-247

Test Standard	FCC Part 15.247 and IC RSS-247 issue 2
FCC ID	M82-AIM8I
ISED ID	9404A-AIM8I
Product name	Computer
Brand Name	ADVANTECH
FCC Model Name	AIM8I, AIM8Ixxxxxxxxxxxxxxxxxx, AIM-x5ATxxxxxxxxxxxxx (where "x" may be any alphanumeric character, "-" or blank for marketing purpose and no impact safety related critical components and constructions)
IC Model Name	AIM8I, AIM-25AT, AIM-35AT, AIM-55AT, AIM-65AT, AIM-75AT
Test Result	Pass

The test Result was tested by Compliance Certification Services Inc. The test data, data evaluation, test procedures, and equipment configurations shown in this report were given in ANSI C63.10: 2013 and compliance standards.

The test results of this report relate only to the tested sample (EUT) identified in this report.

The test Report of full or partial shall not copy. Without written approval of Compliance Certification Services Inc.(Wugu Laboratory)



Approved by:

A handwritten signature in black ink that reads "Sam Chuang".

Reviewed by:

A handwritten signature in black ink that reads "Ed Chiang".

Sam Chuang
Engineer

Ed Chiang
Engineer

Revision History

Rev.	Issue Date	Revisions	Revised By
00	May 28, 2017	Initial Issue	Angel Cheng
01	July 24, 2017	1. Modify section 4.3.4 in page 20.	Angel Cheng

Table of contents

1. GENERAL INFORMATION	4
1.1 EUT INFORMATION	4
1.2 EUT CHANNEL INFORMATION	5
1.3 ANTENNA INFORMATION	5
1.4 MEASUREMENT UNCERTAINTY.....	6
1.5 FACILITIES AND TEST LOCATION	7
1.6 INSTRUMENT CALIBRATION	7
1.7 SUPPORT AND EUT ACCESSORIES EQUIPMENT	8
2. TEST SUMMERY	9
3. DESCRIPTION OF TEST MODES	10
3.1 THE WORST MODE OF OPERATING CONDITION	10
3.2 THE WORST MODE OF MEASUREMENT	11
3.3 EUT DUTY CYCLE.....	12
4. TEST RESULT	13
4.1 AC POWER LINE CONDUCTED EMISSION	13
4.2 20DB BANDWIDTH AND OCCUPIED BANDWIDTH(99%)	16
4.3 OUTPUT POWER MEASUREMENT	19
4.4 FREQUENCY SEPARATION	21
4.5 NUMBER OF HOPPING.....	24
4.6 CONDUCTED BANDEGE AND SPURIOUS EMISSION.....	26
4.7 TIME OF OCCUPANCY (DWELL TIME)	31
4.8 RADIATION BANDEGE AND SPURIOUS EMISSION	33
APPENDIX 1 - PHOTOGRAPHS OF EUT	

1. GENERAL INFORMATION

1.1 EUT INFORMATION

Applicant	Advantech Co.Ltd. No.1, Alley 20, Lane 26, Rueiguang Road, Neihu District, Taipei 114, Taiwan, R.O.C.
Equipment	Computer
FCC Model No.	AIM8I, AIM8Ixxxxxxxxxxxxxxxx, AIM-x5ATxxxxxxxxxxxx (where "x" may be any alphanumeric character, "-" or blank for marketing purpose and no impact safety related critical components and constructions)
IC Model No.	AIM8I, AIM-25AT, AIM-35AT, AIM-55AT, AIM-65AT, AIM-75AT
Model Discrepancy	All models are electrically identical, different model names are for marketing purpose
Received Date	March 17, 2017
Date of Test	April 9 ~ 13, 2017
Output Power(W)	GFSK : 0.0029 (EIRP : 0.0033) 8DPSK :0.0041 (EIRP : 0.0050)
Power Supply	1. VDC from Power Adapter Chicony / A16-018N1A I/P: 100-240Vac, 1A, 50-60Hz O/P: 5.15Vdc, 3A, 9.1Vdc, 2A, 18W 2. Battery ADVANTECH / AIM-BAT-8 Rating: 3.8V, 4900, 18.62Wh

1.2 EUT CHANNEL INFORMATION

Frequency Range	2402MHz-2480MHz
Modulation Type	1. GFSK for BR-1Mbps 2. $\pi/4$ -DQPSK for EDR-2Mbps 3. 8DPSK for EDR-3Mbps
Number of channel	79 Channels

Remark:

Refer as ANSI 63.10:2013 clause 5.6.1 Table 4 and RSS-GEN Table A1 for test channels

Number of frequencies to be tested		
Frequency range in which device operates	Number of frequencies	Location in frequency range of operation
<input type="checkbox"/> 1 MHz or less	1	Middle
<input type="checkbox"/> 1 MHz to 10 MHz	2	1 near top and 1 near bottom
<input checked="" type="checkbox"/> More than 10 MHz	3	1 near top, 1 near middle, and 1 near bottom

1.3 ANTENNA INFORMATION

Antenna Type	<input checked="" type="checkbox"/> PIFA <input type="checkbox"/> PCB <input type="checkbox"/> Dipole <input type="checkbox"/> Coils
Antenna Gain	Gain: 0.89dBi

1.4 MEASUREMENT UNCERTAINTY

PARAMETER	UNCERTAINTY
AC Powerline Conducted Emission	+/- 1.2575
Emission bandwidth, 20dB bandwidth	+/- 1.4003
RF output power, conducted	+/- 1.1372
Power density, conducted	+/- 1.4003
3M Semi Anechoic Chamber / 30M~200M	+/- 4.0138
3M Semi Anechoic Chamber / 200M~1000M	+/- 3.9483
3M Semi Anechoic Chamber / 1G~8G	+/- 2.5975
3M Semi Anechoic Chamber / 8G~18G	+/- 2.6112
3M Semi Anechoic Chamber / 18G~26G	+/- 2.7389
3M Semi Anechoic Chamber / 26G~40G	+/- 2.9683
3M Semi Anechoic Chamber / 40G~60G	+/- 1.8509
3M Semi Anechoic Chamber / 60G~75G	+/- 1.9869
3M Semi Anechoic Chamber / 75G~110G	+/- 2.9651
3M Semi Anechoic Chamber / 110G~170G	+/- 2.7807
3M Semi Anechoic Chamber / 170G~220G	+/- 3.6437
3M Semi Anechoic Chamber / 220G~325G	+/- 4.2982

Remark:

1. This uncertainty represents an expanded uncertainty expressed at approximately the 95% confidence level using a coverage factor of $k=2$
2. ISO/IEC 17025 requires that an estimate of the measurement uncertainties associated with the emissions test results be included in the report.

1.5 FACILITIES AND TEST LOCATION

All measurement facilities used to collect the measurement data are located at No.11, Wugong 6th Rd., Wugu Dist., New Taipei City 24891, Taiwan. (R.O.C.)

Test site	Test Engineer	Remark
AC Conduction Room	Eric Lee	
Radiation	Ed Chiang	
RF Conducted	Eric Lee	

Remark: The sites are constructed in conformance with the requirements of ANSI C63.7, ANSI C63.4 and CISPR Publication 22.

1.6 INSTRUMENT CALIBRATION

RF Conducted Test Site					
Equipment	Manufacturer	Model	S/N	Cal Date	Cal Due
Power Meter	Anritsu	ML2495A	1012009	07/04/2016	07/03/2017
Power Sensor	Anritsu	MA2411B	917072	07/04/2016	07/03/2017
Spectrum Analyzer	R&S	FSV 40	101073	10/05/2016	10/04/2017

3M 966 Chamber Test Site					
Equipment	Manufacturer	Model	S/N	Cal Date	Cal Due
Bilog Antenna	Sunol Sciences	JB3	A030105	07/03/2016	07/02/2017
Horn Antenna	EMCO	3117	00055165	02/20/2017	02/19/2018
Pre-Amplifier	EMCI	EMC 012635	980151	06/23/2016	06/22/2017
Pre-Amplifier	EMEC	EM330	060609	06/08/2016	06/07/2017
Spectrum Analyzer	Agilent	E4446A	US42510252	12/05/2016	12/04/2017
Loop Ant	COM-POWER	AL-130	121051	03/02/2017	03/01/2018
Antenna Tower	CCS	CC-A-1F	N/A	N.C.R	N.C.R
Controller	CCS	CC-C-1F	N/A	N.C.R	N.C.R
Turn Table	CCS	CC-T-1F	N/A	N.C.R	N.C.R

AC Conducted Emissions Test Site					
Equipment	Manufacturer	Model	S/N	Cal Date	Cal Due
EMI Test Receiver	R&S	ESCI	101201	08/20/2016	08/19/2017
LISN	Schwarzbeck	NNLK 8129	8129-286	08/19/2016	08/18/2017
LISN(EUT)	Schwarzbeck	NSLK 8127	8127-527	08/19/2016	08/18/2017
Pulse Limiter	R&S	ESH3Z2	C3010026-2	08/21/2016	08/22/2017
Software	EZ-EMC				

Remark: Each piece of equipment is scheduled for calibration once a year.

1.7 SUPPORT AND EUT ACCESSORIES EQUIPMENT



EUT Accessories Equipment					
No.	Equipment	Brand	Model	Series No.	FCC ID
	N/A				

Support Equipment					
No.	Equipment	Brand	Model	Series No.	FCC ID
	N/A				

1.8 Test methodology and applied standards

The test methodology, setups and results comply with all requirements in accordance with ANSI C63.10:2013, FCC Part 2, FCC Part 15.247, KDB 558074 D01 v03r05, RSS-247 Issue 2 and RSS-GEN Issue 4.

1.9 Table of accreditations and listings

Country	Agency	Scope of Accreditation	Logo
USA	FCC	3M Semi Anechoic Chamber (FCC MRA: TW1039) to perform FCC Part 15 measurements	 FCC MRA: TW1039
Canada	Industry Canada	3M Semi Anechoic Chamber (IC 2324G-1 / IC 2324G-2) to perform	 IC 2324G-1 IC 2324G-2

2. TEST SUMMERY

FCC Standard Section	IC Standard Section	Report Section	Test Item	Result
15.203	-	1.2	Antenna Requirement	Pass
15.207(a)	RSS-GEN 8.8	4.1	AC Conducted Emission	Pass
15.247(a)(1)	RSS-247(5.2)(a)	4.2	20 dB Bandwidth	Pass
-	RSS-GEN 6.6	4.2	Occupied Bandwidth (99%)	Pass
15.247(b)(1)	RSS-247(5.4)(b)	4.3	Output Power Measurement	Pass
15.247(a)(1)	RSS-247(5.1)(b)	4.4	Frequency Separation	Pass
15.247(a)(1)(iii)	RSS-247(5.1)(d)	4.5	Number of Hopping	Pass
15.247(d)	RSS-247(5.5)	4.6	Conducted Band Edge	Pass
15.247(d)	RSS-247(5.5)	4.6	Conducted Emission	Pass
15.247(a)(1)(iii)	RSS-247(5.1)(d)	4.7	Time of Occupancy	Pass
15.247(d)	RSS-GEN 8.9, 8.10	4.8	Radiation Band Edge	Pass
15.247(d)	RSS-GEN 8.9, 8.10	4.8	Radiation Spurious Emission	Pass

3. DESCRIPTION OF TEST MODES

3.1 THE WORST MODE OF OPERATING CONDITION

Operation mode	GFSK for BR-1Mbps (DH5) $\pi/4$ -DQPSK for EDR-2Mbps (DH5) 8DPSK for EDR-3Mbps (DH5)
Test Channel Frequencies	<p>GFSK for BR-1Mbps: 1.Lowest Channel : 2402MHz 2.Middle Channel : 2441MHz 3.Highest Channel : 2480MHz</p> <p>$\pi/4$-DQPSK for EDR-2Mbps: 1.Lowest Channel : 2402MHz 2.Middle Channel : 2441MHz 3.Highest Channel : 2480MHz</p> <p>8DPSK for EDR-3Mbps: 1.Lowest Channel : 2402MHz 2.Middle Channel : 2441MHz 3.Highest Channel : 2480MHz</p>

Remark:

1. EUT pre-scanned data rate of output power for each mode, the worst data rate were recorded in this report.

3.2 THE WORST MODE OF MEASUREMENT

AC Power Line Conducted Emission	
Test Condition	AC Power line conducted emission for line and neutral
Voltage/Hz	120V/60Hz
Test Mode	Mode 1:EUT power by AC adapter via power cable. Mode 2:EUT power by Battery.
Worst Mode	<input checked="" type="checkbox"/> Mode 1 <input type="checkbox"/> Mode 2 <input type="checkbox"/> Mode 3 <input type="checkbox"/> Mode 4

Radiated Emission Measurement Above 1G	
Test Condition	Band edge, Emission for Unwanted and Fundamental
Voltage/Hz	120V/60Hz
Test Mode	Mode 1:EUT power by AC adapter via power cable. Mode 2:EUT power by Battery.
Worst Mode	<input checked="" type="checkbox"/> Mode 1 <input type="checkbox"/> Mode 2 <input type="checkbox"/> Mode 3 <input type="checkbox"/> Mode 4
Worst Position	<input type="checkbox"/> Placed in fixed position. <input type="checkbox"/> Placed in fixed position at X-Plane (E2-Plane) <input checked="" type="checkbox"/> Placed in fixed position at Y-Plane (E1-Plane) <input type="checkbox"/> Placed in fixed position at Z-Plane (H-Plane)
Worst Polarity	<input type="checkbox"/> Horizontal <input checked="" type="checkbox"/> Vertical

Radiated Emission Measurement Below 1G	
Test Condition	Radiated Emission Below 1G
Voltage/Hz	120V/60Hz
Test Mode	Mode 1:EUT power by AC adapter via power cable. Mode 2:EUT power by Battery.
Worst Mode	<input checked="" type="checkbox"/> Mode 1 <input type="checkbox"/> Mode 2 <input type="checkbox"/> Mode 3 <input type="checkbox"/> Mode 4

Remark:

1. The worst mode was record in this test report.
2. EUT pre-scanned in three axis ,X,Y, Z and two polarity, Horizontal and Vertical for radiated measurement. The worst case(Y-Plane and Vertical) were recorded in this report
3. AC power line conducted emission and for below 1G radiation emission were performed the EUT transmit at the highest output power channel as worse case.

3.3 EUT DUTY CYCLE

Duty Cycle				
Configuration	TX ON (ms)	TX ALL (ms)	Duty Cycle (%)	Duty Factor(dB)
BR-1Mbps	3.0435	3.7681	80.77%	0.93
EDR-3Mbps	3.1159	3.7681	82.69%	0.83

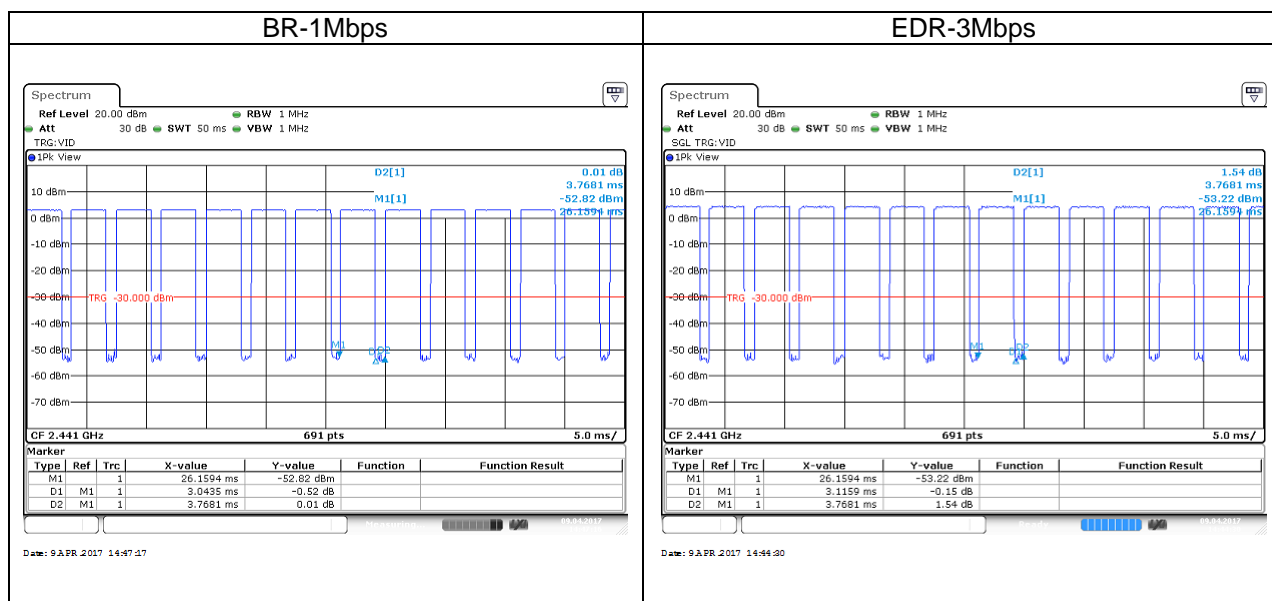

4. TEST RESULT

4.1 AC POWER LINE CONDUCTED EMISSION

4.1.1 Test Limit

According to §15.207(a) and RSS-GEN section 8.8,

Frequency Range (MHz)	Limits(dBμV)	
	Quasi-peak	Average
0.15 to 0.50	66 to 56*	56 to 46*
0.50 to 5	56	46
5 to 30	60	50

* Decreases with the logarithm of the frequency.

4.1.2 Test Procedure

Test method Refer as ANSI 63.10:2013 clause 6.2,

1. The EUT was placed on a non-conducted table, which is 0.8m above horizontal ground plane and 0.4m above vertical ground plane.
2. EUT connected to the line impedance stabilization network (LISN)
3. Receiver set RBW of 9kHz and Detector Peak, and note as quasi-peak and average.
4. Maximum procedure was performed on the six highest emissions to ensure EUT compliance.
5. Recorded Line for Neutral and Line.

4.1.3 Test Setup

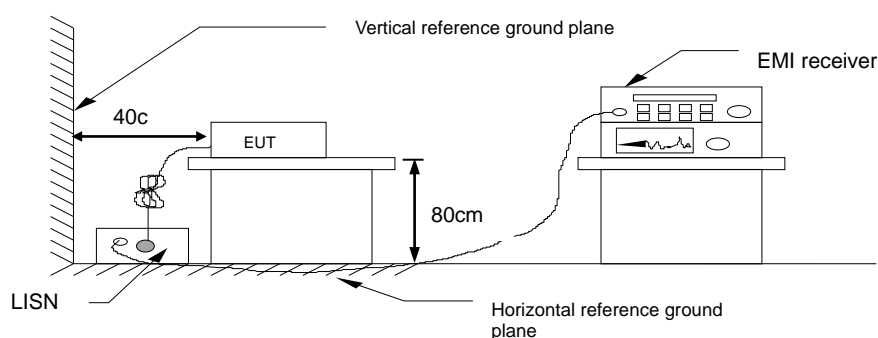

4.1.4 Test Result

PASS

Test Data

Test Mode:	Mode 1	Temp/Hum	24(°C)/ 50%RH
Test Voltage:	120Vac / 60Hz	Test Date	2017/4/28
Phase:	Line	Test Engineer	Eric Lee

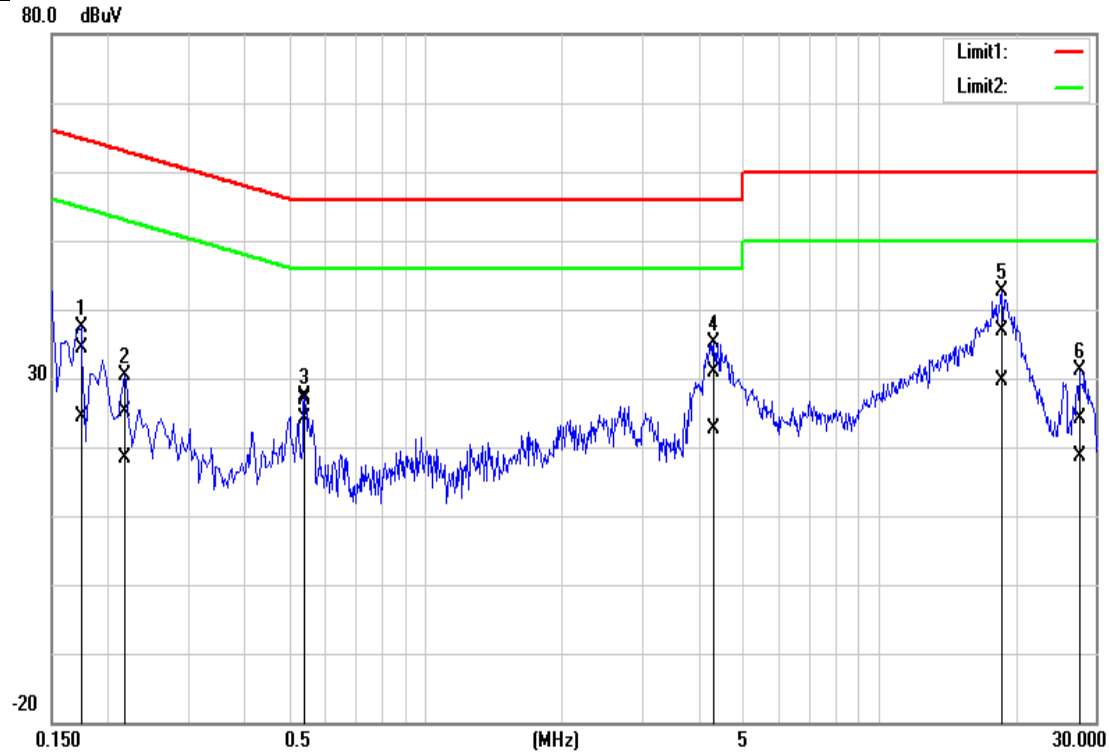

No.	Frequency (MHz)	QuasiPeak reading (dBuV)	Average reading (dBuV)	Correction factor (dB)	QuasiPeak result (dBuV)	Average result (dBuV)	QuasiPeak limit (dBuV)	Average limit (dBuV)	QuasiPeak margin (dB)	Average margin (dB)
1	0.1740	24.71	14.57	9.70	34.41	24.27	64.77	54.77	-30.36	-30.50
2	0.2180	15.50	8.65	9.69	25.19	18.34	62.89	52.89	-37.70	-34.55
3	0.5420	17.12	14.57	9.68	26.80	24.25	56.00	46.00	-29.20	-21.75
4	4.3260	21.17	13.01	9.71	30.88	22.72	56.00	46.00	-25.12	-23.28
5*	18.6300	27.11	19.67	9.85	36.96	29.52	60.00	50.00	-23.04	-20.48
6	27.7060	14.42	8.76	9.76	24.18	18.52	60.00	50.00	-35.82	-31.48

Test Mode:	Mode 1	Temp/Hum	27(°C)/ 53%RH
Test Voltage:	120Vac / 60Hz	Test Date	2017/4/28
Phase:	Neutral	Test Engineer	Eric Lee

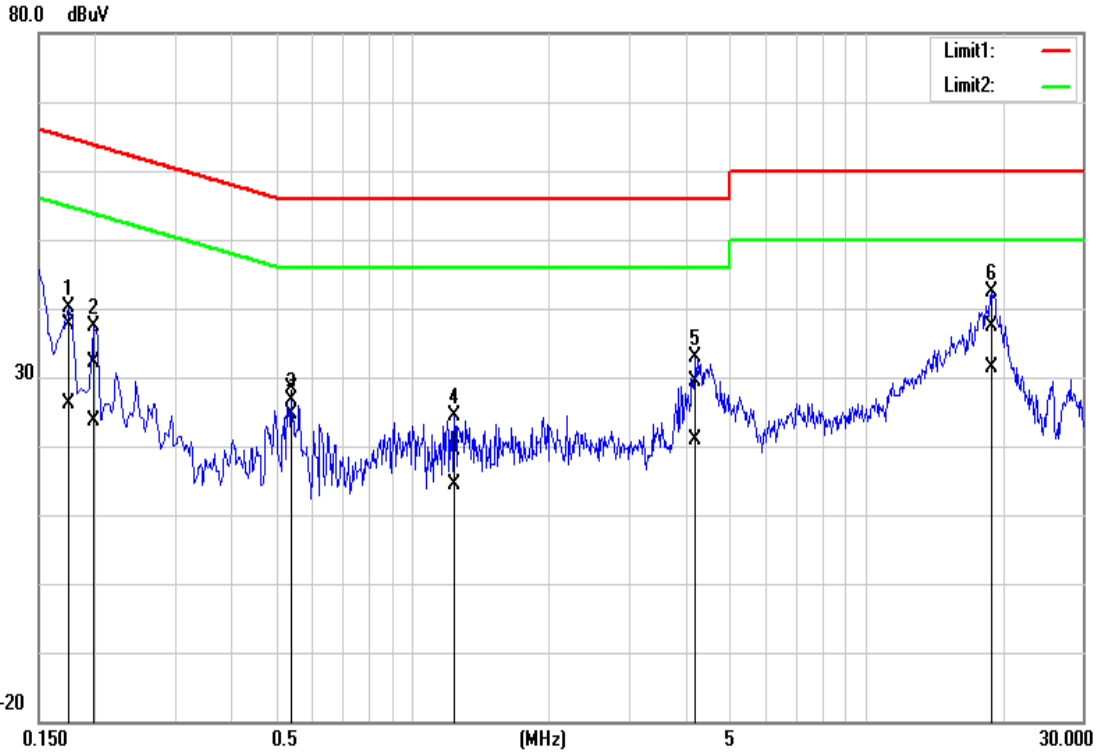

No.	Frequency (MHz)	QuasiPeak reading (dBuV)	Average reading (dBuV)	Correction factor (dB)	QuasiPeak result (dBuV)	Average result (dBuV)	QuasiPeak limit (dBuV)	Average limit (dBuV)	QuasiPeak margin (dB)	Average margin (dB)
1	0.1740	27.83	16.36	9.71	37.54	26.07	64.77	54.77	-27.23	-28.70
2	0.1980	22.41	13.93	9.70	32.11	23.63	63.69	53.69	-31.58	-30.06
3	0.5420	18.72	14.88	9.69	28.41	24.57	56.00	46.00	-27.59	-21.43
4	1.2420	9.81	4.72	9.69	19.50	14.41	56.00	46.00	-36.50	-31.59
5	4.2220	19.63	11.06	9.71	29.34	20.77	56.00	46.00	-26.66	-25.23
6*	18.9980	27.38	21.50	9.91	37.29	31.41	60.00	50.00	-22.71	-18.59

4.2 20DB BANDWIDTH AND OCCUPIED BANDWIDTH(99%)

4.2.1 Test Limit

According to §15.247(a) (1), RSS-247 section 5.1(a) and RSS-GEN 6.6,

20 dB Bandwidth : For reporting purposes only.

Occupied Bandwidth(99%) : For reporting purposes only.

4.2.2 Test Procedure

Test method Refer as ANSI 63.10:2013 clause 6.9.2 & 6.9.3.

1. The EUT RF output connected to the spectrum analyzer by RF cable.
2. Setting maximum power transmit of EUT
3. SA set RBW = 30kHz, VBW = 100kHz and Detector = Peak, to measurement 20 dB Bandwidth and 99% Bandwidth.
4. Measure and record the result of 20 dB Bandwidth and 99% Bandwidth. in the test report.

4.2.3 Test Setup

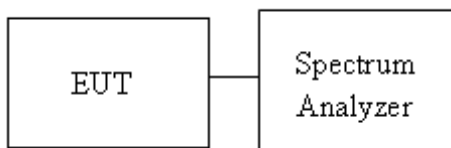

4.2.4 Test Result

Test mode: GFSK_BR-1Mbps mode / 2402-2480 MHz			
Channel	Frequency (MHz)	OBW(99%) (MHz)	20dB BW (MHz)
Low	2402	0.9638	1.1217
Mid	2441	0.9594	1.1217
High	2480	0.9638	1.1217

Test mode: 8DPSK_EDR-3Mbps mode / 2402-2480 MHz			
Channel	Frequency (MHz)	OBW(99%) (MHz)	20dB BW (MHz)
Low	2402	1.2503	1.4217
Mid	2441	1.2503	1.4260
High	2480	1.2503	1.4260

Test Data

GFSK BR-1Mbps mode

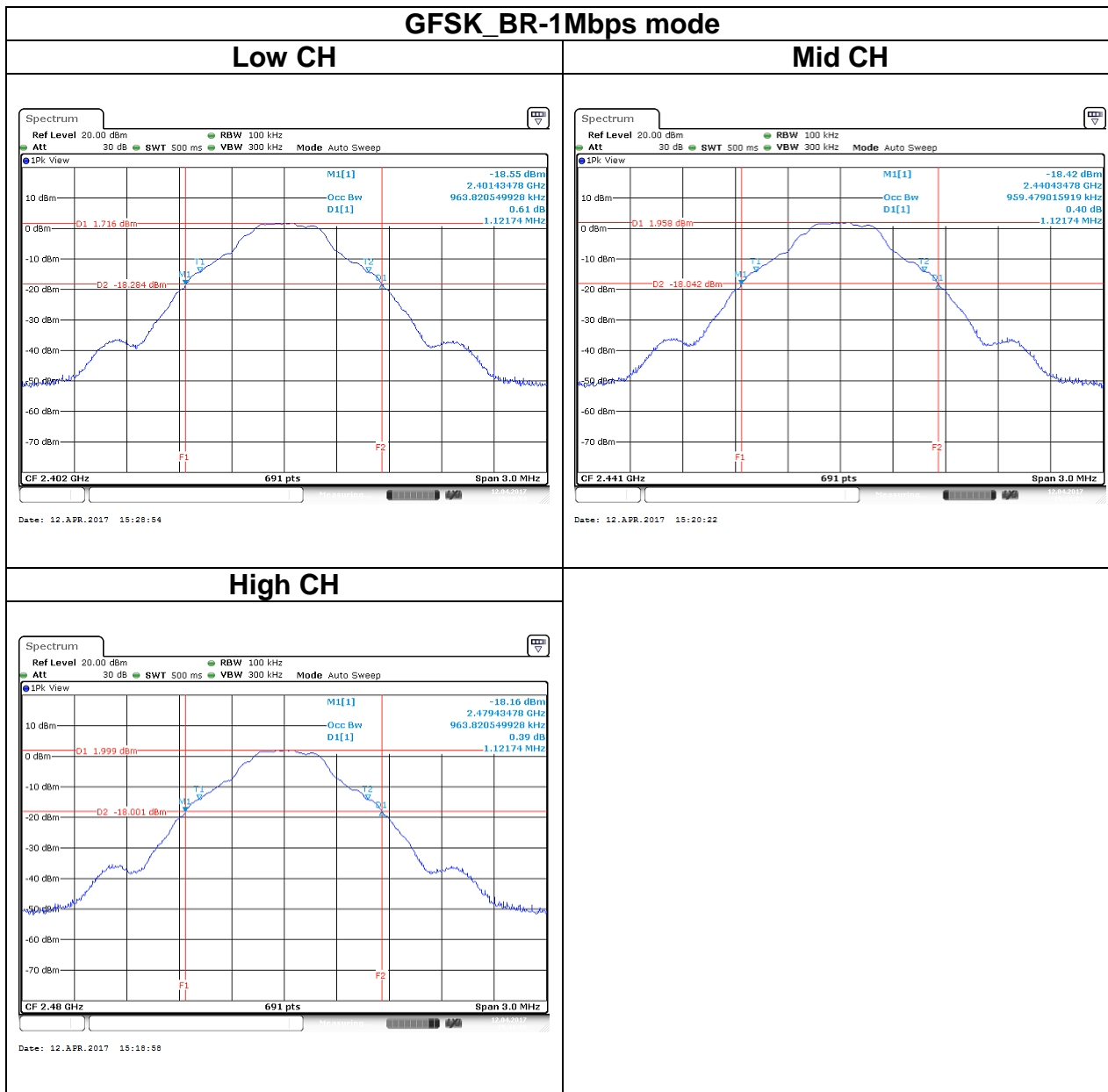

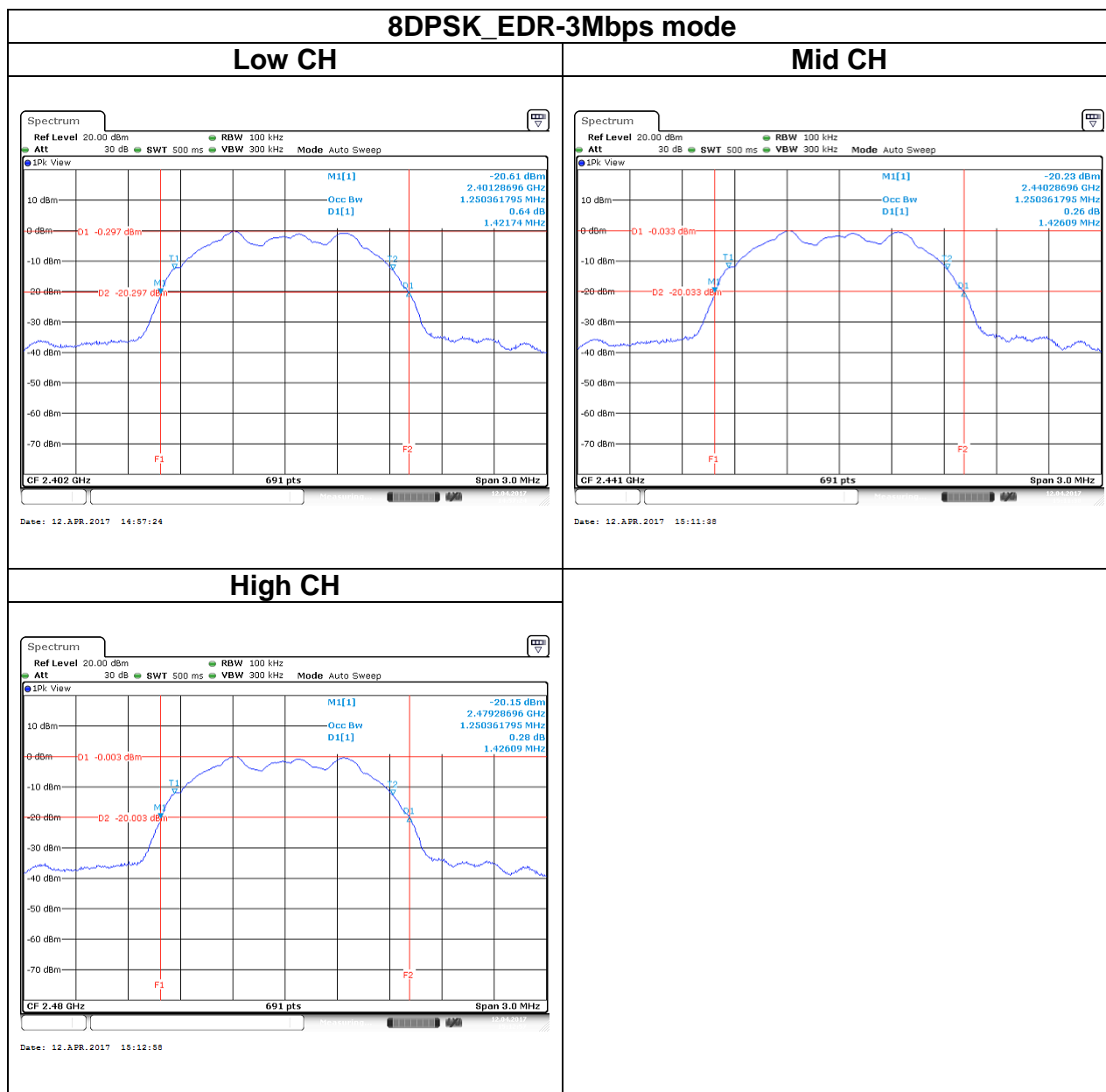

4.3 OUTPUT POWER MEASUREMENT

4.3.1 Test Limit

According to §15.247(b)(1) and RSS-247 section 5.4(b)

Peak output power :

FCC

For frequency hopping systems operating in the 2400-2483.5 MHz band employing at least 75 non-overlapping hopping channels, and all frequency hopping systems in the 5725-5850 MHz band: 1 watt. For all other frequency hopping systems in the 2400-2483.5 MHz band: 0.125 watts.

IC

For FHSs operating in the band 2400-2483.5 MHz, the maximum peak conducted output power shall not exceed 1.0 W and the e.i.r.p. shall not exceed 4 W if the hopset uses 75 or more hopping channels.

Limit	<input checked="" type="checkbox"/> Antenna not exceed 6 dBi : 21dBm <input type="checkbox"/> Antenna with DG greater than 6 dBi : 21dBm [Limit = 30 – (DG – 6)]
-------	---

Average output power : For reporting purposes only.

4.3.2 Test Procedure

1. The EUT RF output connected to the power meter by RF cable.
2. Setting maximum power transmit of EUT.
3. The path loss was compensated to the results for each measurement.
4. Measure and record the result of Peak output power and Average output power. in the test report.

4.3.3 Test Setup

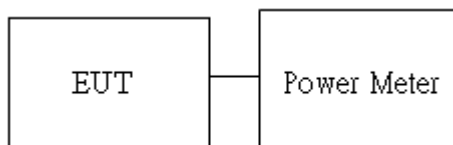

4.3.4 Test Result

Peak output power :

BT								
Config.	CH	Freq. (MHz)	PK Power (dBm)	EIRP PK Power (dBm)	PK Power (W)	EIRP PK Power (W)	FCC/IC Limit (dBm)	IC EIRP Limit (dBm)
GFSK BR-1Mbps (DH5)	0	2402	4.26	5.15	0.0027	0.0033	21	36
	39	2441	4.54	5.43	0.0028	0.0035		
	78	2480	4.66	5.55	0.0029	0.0036		
8DPSK EDR-3Mbps (DH5)	0	2402	5.75	6.64	0.0038	0.0046		
	39	2441	6.05	6.94	0.0040	0.0049		
	78	2480	6.13	7.02	0.0041	0.0050		

Average output power :

BT			
Config.	CH	Freq. (MHz)	AV Power (dBm)
GFSK BR-1Mbps (DH5)	0	2402	3.80
	39	2441	4.02
	78	2480	4.07
8DPSK EDR-3Mbps (DH5)	0	2402	3.06
	39	2441	3.26
	78	2480	3.31

4.4 FREQUENCY SEPARATION

4.4.1 Test Limit

According to §15.247(a)(1) and RSS-247 section 5.1(b)

Frequency hopping systems shall have hopping channel carrier frequencies separated by a minimum of 25 kHz or the 20 dB bandwidth of the hopping channel, whichever is greater.

Alternatively, frequency hopping systems operating in the 2400-2483.5 MHz band may have hopping channel carrier frequencies that are separated by 25 kHz or two-thirds of the 20 dB bandwidth of the hopping channel, whichever is greater, provided the systems operate with an output power no greater than 125 mW.

Limit	> two-thirds of the 20 dB bandwidth
-------	-------------------------------------

4.4.2 Test Procedure

1. Place the EUT on the table and set it in transmitting mode.
2. EUT RF output port connected to the SA by RF cable.
3. Set the spectrum analyzer as RBW = 100kHz, VBW = 300kHz, Sweep = auto.
Max hold, mark 3 peaks of hopping channel and record the 3 peaks frequency

4.4.3 Test Setup

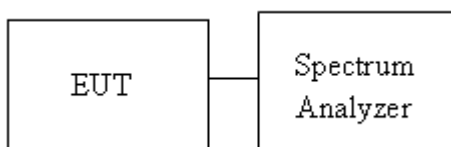

4.4.4 Test Result

Test mode: GFSK_BR-1Mbps mode / 2402-2480 MHz				
Channel	Frequency (MHz)	Channel Separation (MHz)	Channel Separation Limits (MHz)	Result
Low	2402	0.9986	0.748	PASS
Mid	2441	0.9986	0.748	PASS
High	2480	0.9986	0.748	PASS

Test mode: 8DPSK_EDR-3Mbps mode / 2402-2480 MHz				
Channel	Frequency (MHz)	Channel Separation (MHz)	Channel Separation Limits (MHz)	Result
Low	2402	0.9986	0.948	PASS
Mid	2441	0.9986	0.951	PASS
High	2480	0.9986	0.951	PASS

Test Data

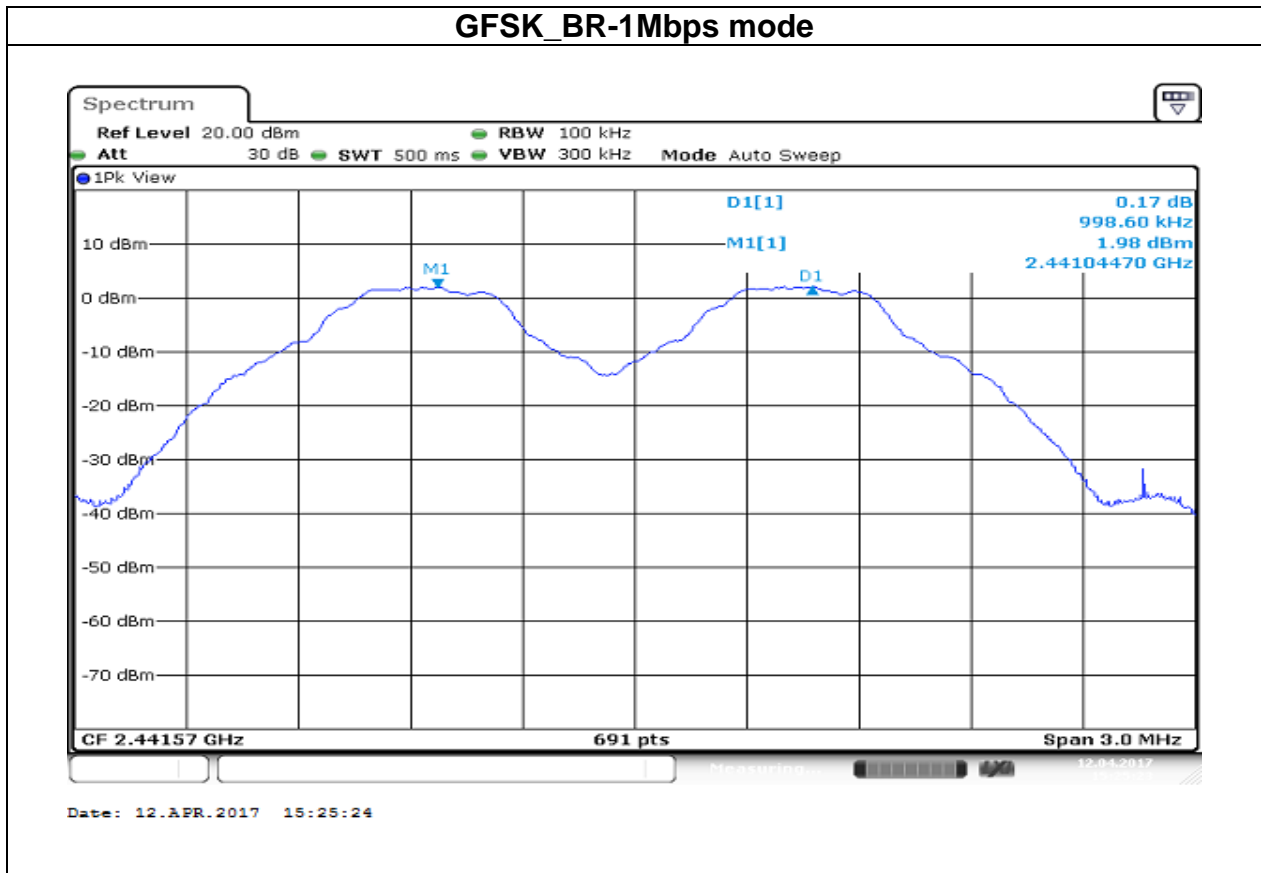

8DPSK_EDR-3Mbps mode

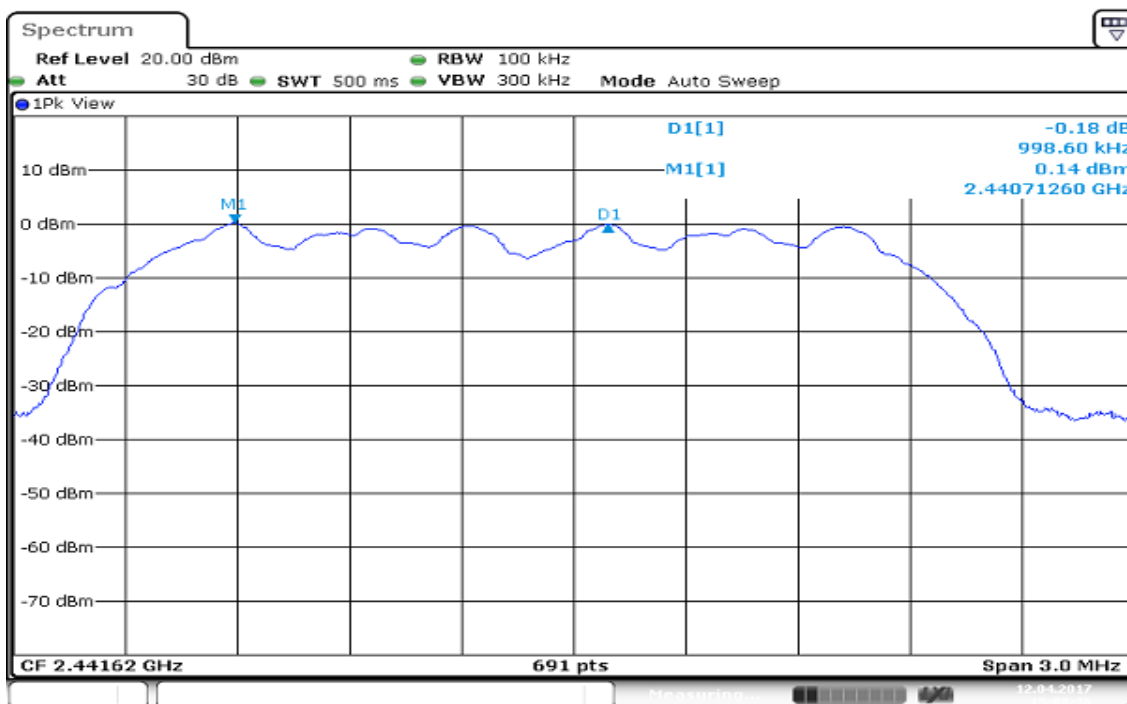

Date: 12.APR.2017 15:08:36

4.5 NUMBER OF HOPPING

4.5.1 Test Limit

According to §15.247(a)(1)(iii) and RSS-247 section 5.1(d)

Frequency hopping system in the 2400-2483.5MHz band shall use at least 15 channels.

4.5.2 Test Procedure

Test method Refer as ANSI 63.10:2013 clause 7.8.3

1. Place the EUT on the table and set it in transmitting mode.
2. EUT RF output port connected to the SA by RF cable.
3. Set spectrum analyzer Start Freq. = 2400 MHz, Stop Freq. = 2483.5 MHz, RBW = 100KHz, VBW = 300KHz.
4. Max hold, view and count how many channel in the band.

4.5.3 Test Setup

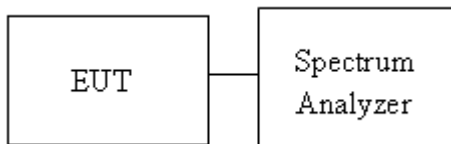

4.5.4 Test Result

Number of Hopping				
Mode	Frequency (MHz)	Hopping Channel Number	Hopping Channel Number Limits	Result
BR-1Mbps	2402-2480	79	15	Pass
EDR-3Mbps	2402-2480	79	15	

REMARK:

The frequency spectrum was broken up in to two sub-range to clearly show all of the hopping frequencies. In the AFH mode, this device operation was using 20 channels, so the requirement for minimum number of hopping channels is satisfied

Test Data

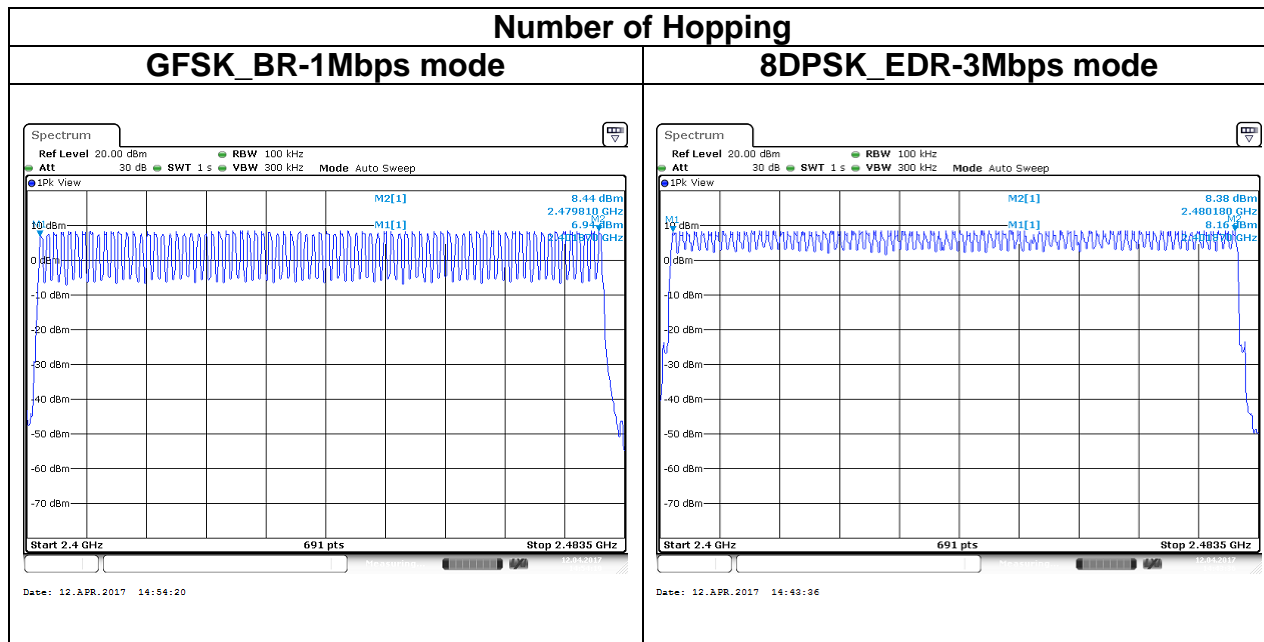

4.6 CONDUCTED BANDEDGE AND SPURIOUS EMISSION

4.6.1 Test Limit

According to §15.247(d) and RSS-247 section 5.5

Limit	-20 dBc
-------	---------

4.6.2 Test Procedure

1. EUT RF output port connected to the SA by RF cable, and the path loss was compensated to result.
2. SA setting, RBW=100kHz, VBW=300kHz, Detector=Peak, Trace mode = max hold, SWT = Auto.
3. The Band Edge at 2.4GHz and 2.4835GHz are investigated with normal hopping mode.

4.6.3 Test Setup

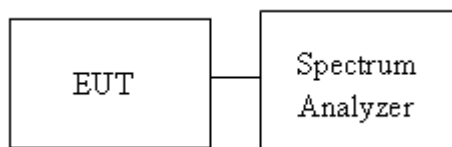

4.6.4 Test Result

Test Data

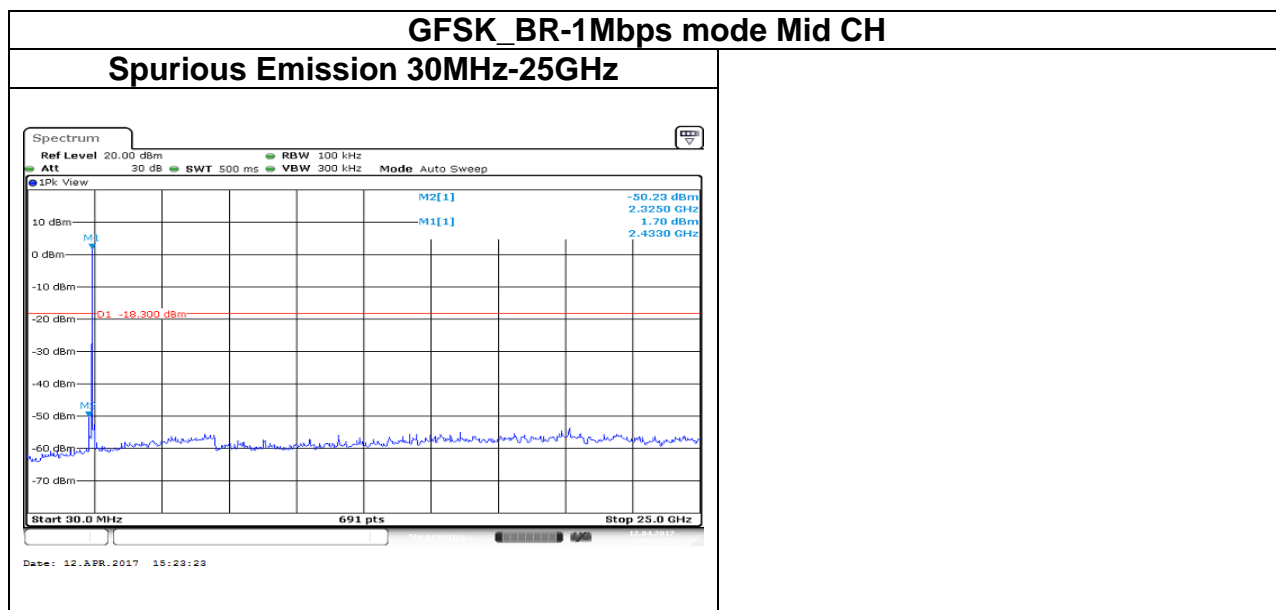
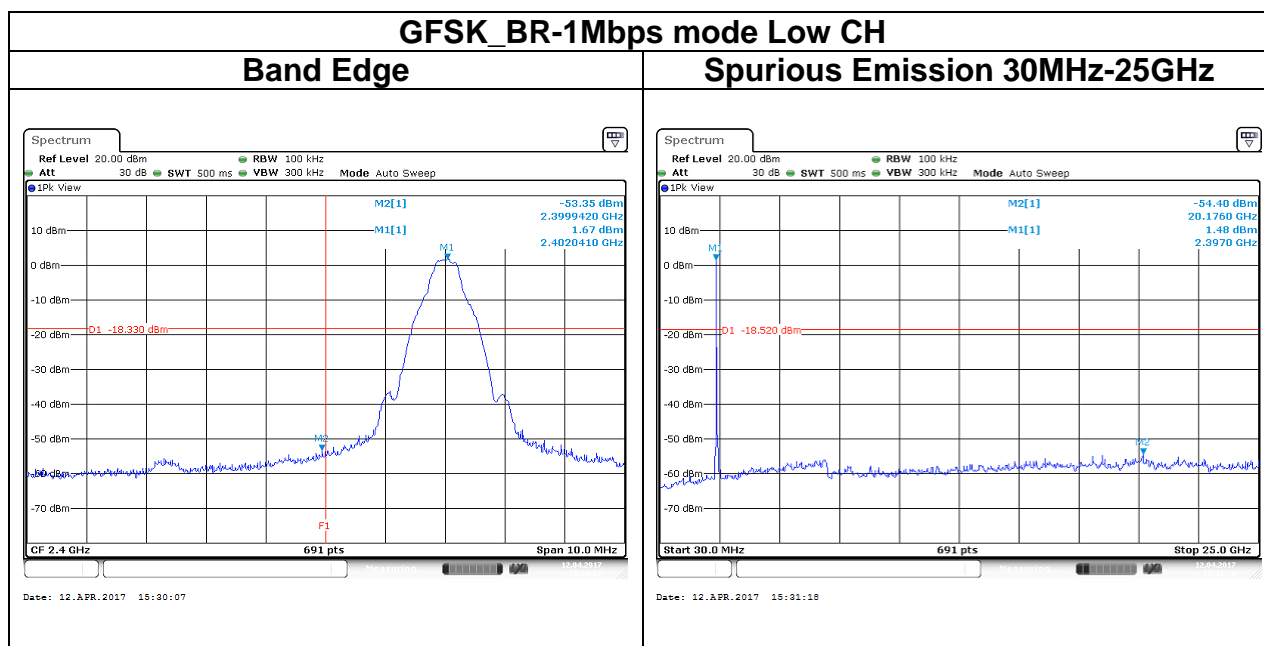

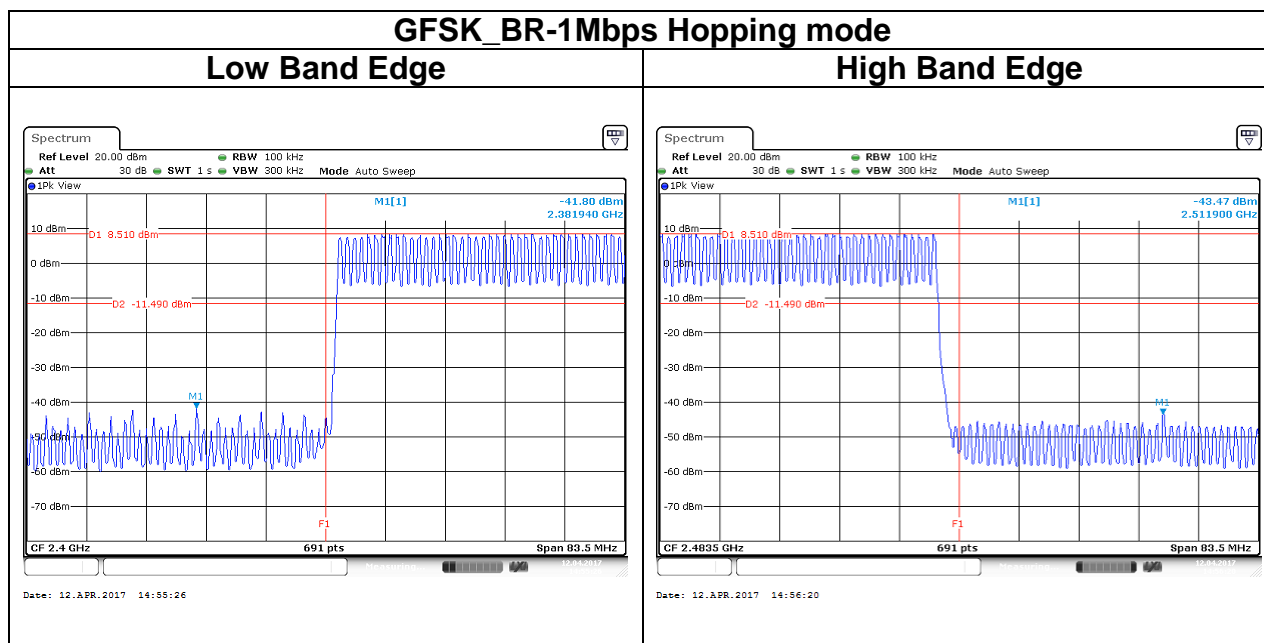
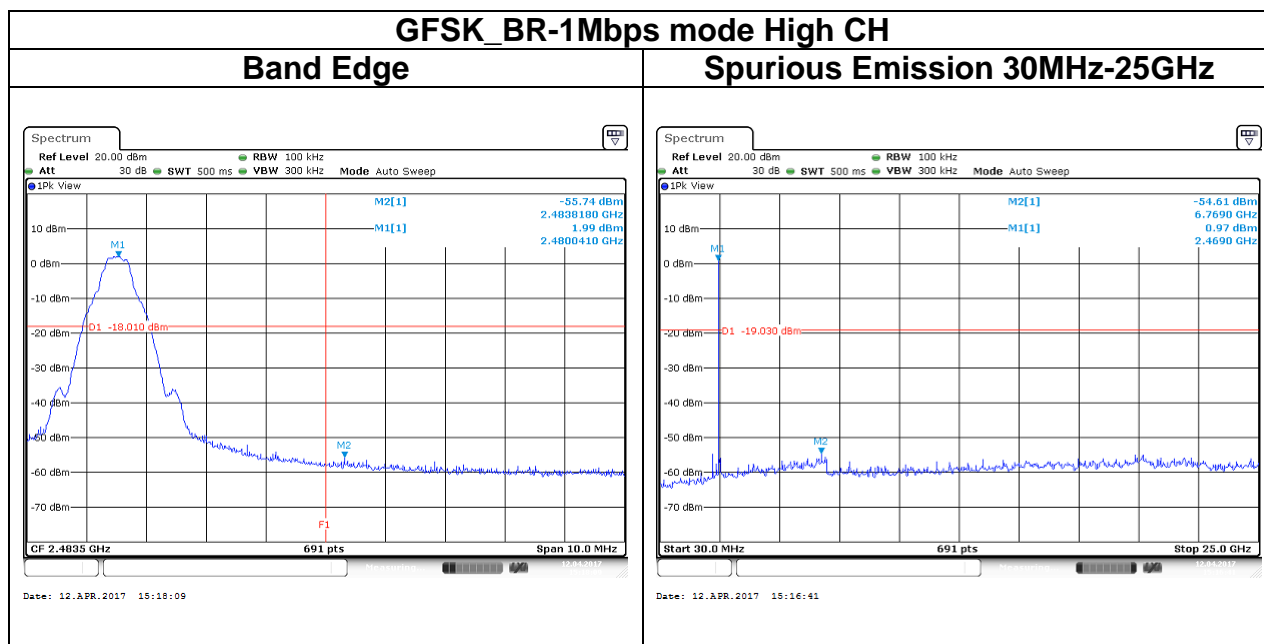

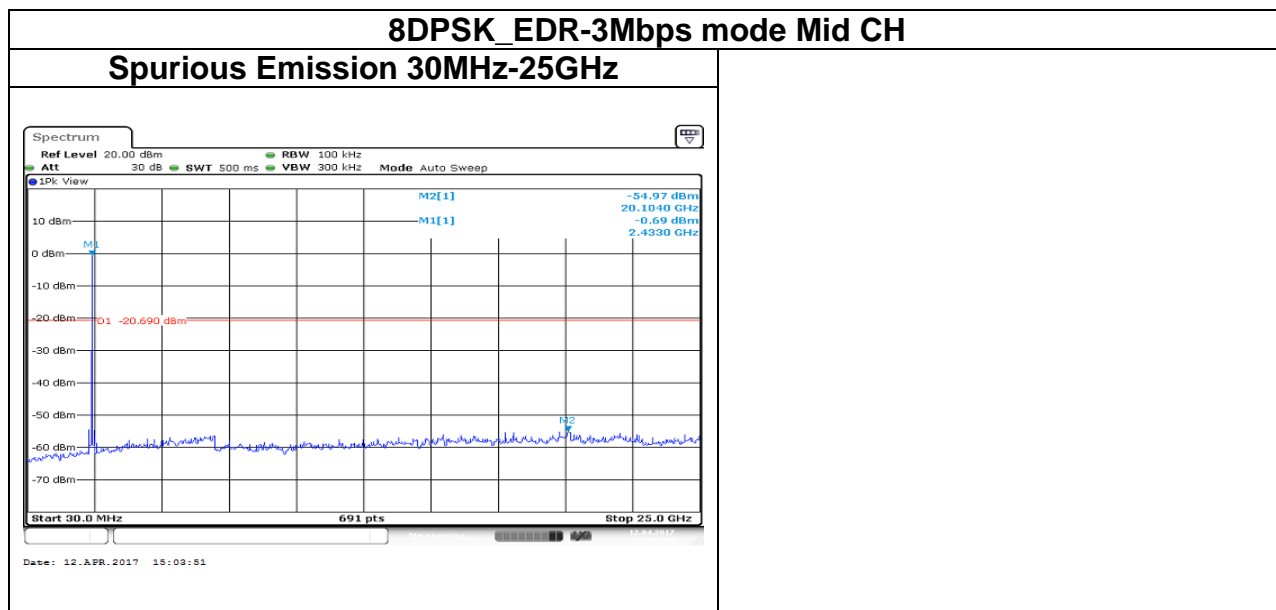
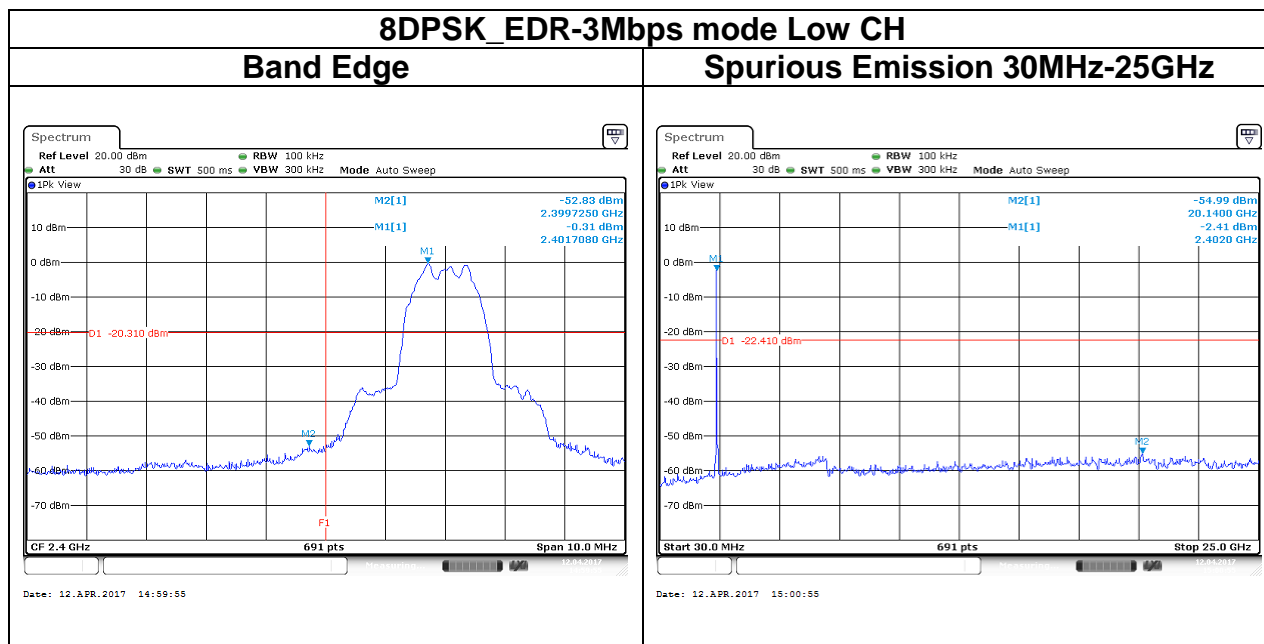

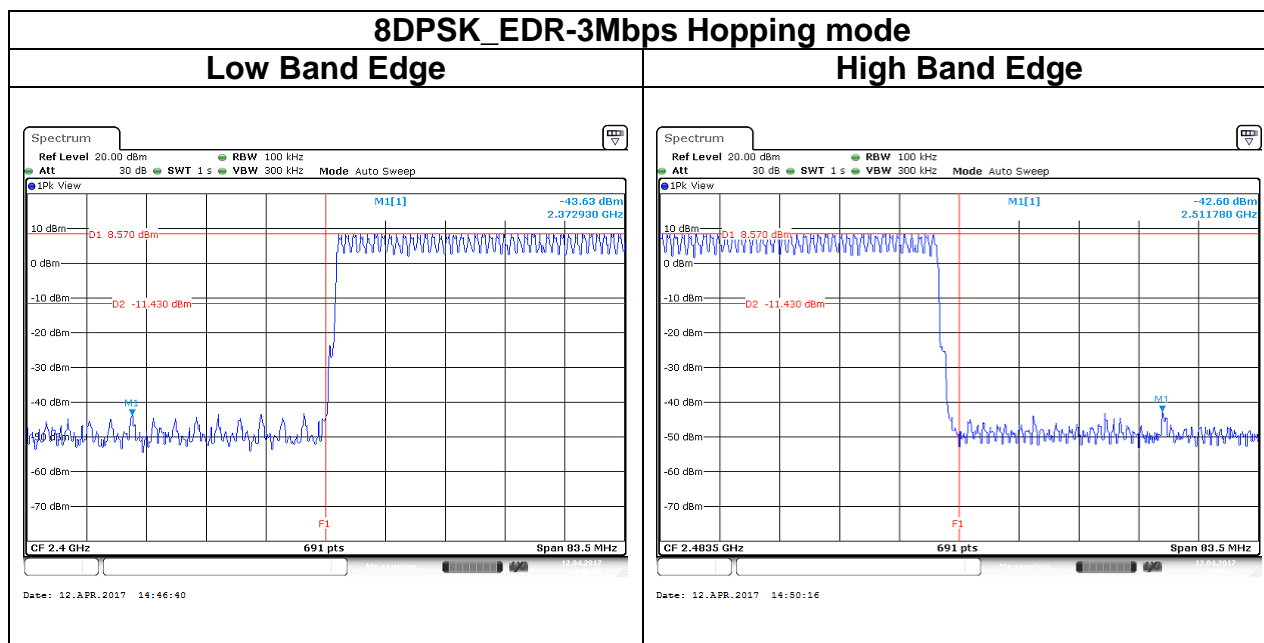
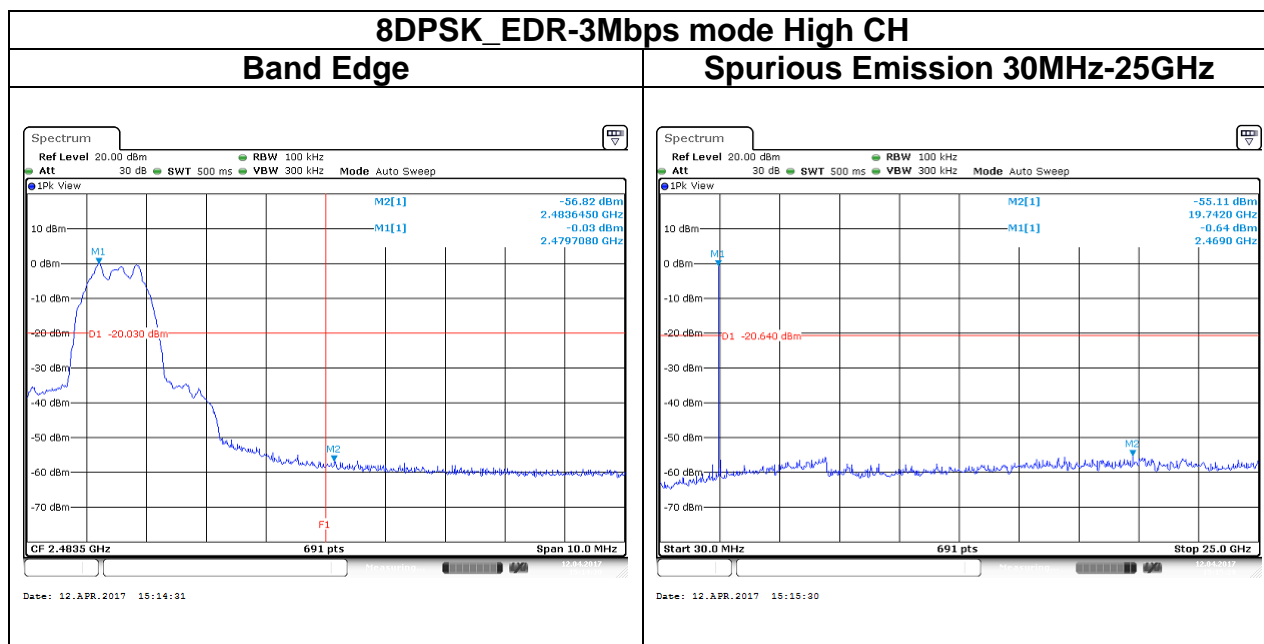

4.7 TIME OF OCCUPANCY (DWELL TIME)

4.7.1 Test Limit

According to §15.247(a)(1)(iii) and RSS-247 section 5.1(d)

The average time of occupancy on any channel shall not be greater than 0.4 seconds within a period of 0.4 seconds multiplied by the number of hopping channels employed.

4.7.2 Test Procedure

1. EUT RF output port connected to the SA by RF cable.
2. Set center frequency of spectrum analyzer = operating frequency.
3. Set the spectrum analyzer as RBW, VBW=1MHz, Sweep = 1 ms

4.7.3 Test Setup

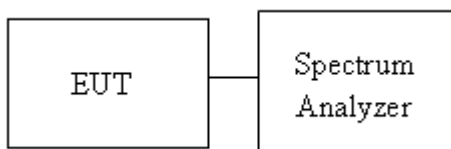

4.7.4 Test Result

Time of Occupancy (Dwell Time)							
Mode	Frequency (MHz)	Pulse Time Per Hopping (ms)	Minimum Number of Hopping Freq.	Number of pulse in	Dwell Time IN	Dwell Time Limits (s)	Result
				(0.4 * N sec)	(0.4 * N sec)		
BR-1Mbps	2441	2.9275	79	106.67	0.3246	0.4	Pass
EDR-3Mbps	2441	2.9275	79	106.67	0.3324	0.4	
Non-AFH: DH5 Packet permit maximum $1600 / 79 / 6 = 3.37$ hops per second in each channel (5 time slots RX, 1 time slot TX). So, the dwell time is the time duration of the pulse times $3.37 * 0.4 * 79 = 106.6$							
AFH: DH5 Packet permit maximum $800 / 20 / 6 = 6.666$ hops per second in each channel (5 time slots RX, 1 time slot TX). So, the dwell time is the time duration of the pulse times $6.666 * 0.4 * 20 = 53.33$							

Test Data

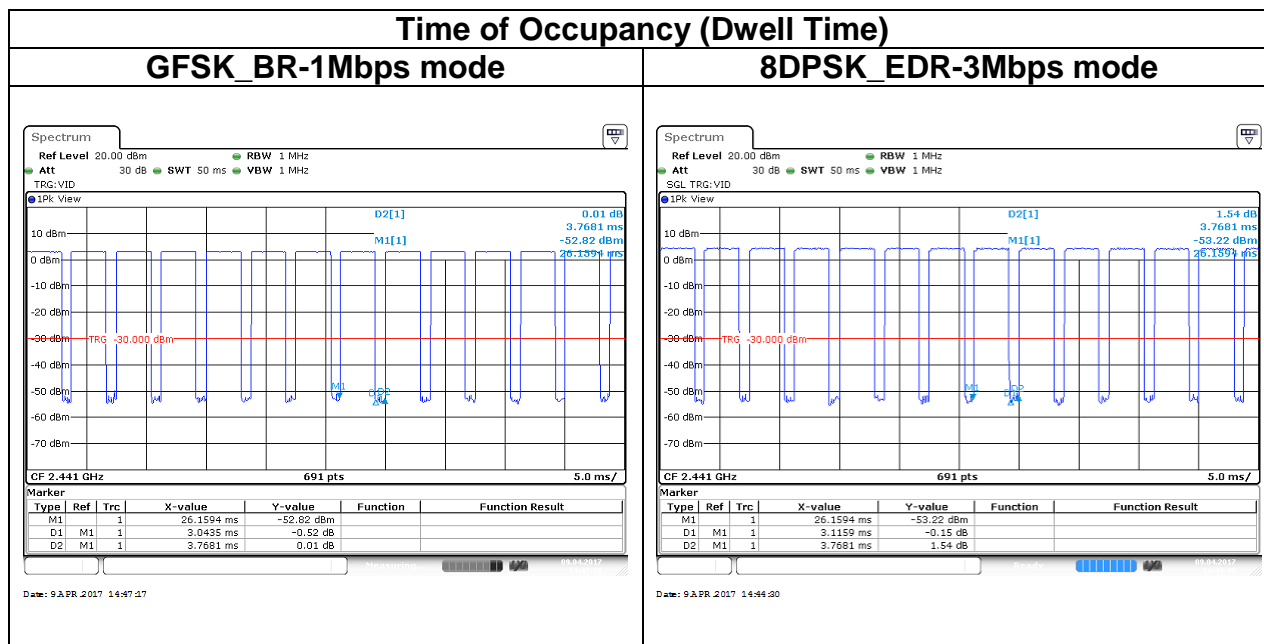

4.8 RADIATION BANDEGE AND SPURIOUS EMISSION

4.8.1 Test Limit

FCC according to §15.247(d), §15.209 and §15.205,

IC according to RSS-247 section 5.5, RSS-Gen, Section 8.9 and 8.10

In any 100 kHz bandwidth outside the authorized frequency band, all harmonic and spurious must be least 20 dB below the highest emission level with the authorized frequency band. Radiation emission which fall in the restricted bands must also follow the FCC section 15.209 as below limit in table.

Below 30 MHz

Frequency	Field Strength (microvolts/m)	Magnetic H-Field (microamperes/m)	Measurement Distance (metres)
9-490 kHz	2,400/F (F in kHz)	2,400/F (F in kHz)	300
490-1,705 kHz	24,000/F (F in kHz)	24,000/F (F in kHz)	30
1.705-30 MHz	30	N/A	30

Above 30 MHz

Frequency (MHz)	Field Strength microvolts/m at 3 metres (watts, e.i.r.p.)	
	Transmitters	Receivers
30-88	100 (3 nW)	100 (3 nW)
88-216	150 (6.8 nW)	150 (6.8 nW)
216-960	200 (12 nW)	200 (12 nW)
Above 960	500 (75 nW)	500 (75 nW)

Remark:

Although these tests were performed other than open area test site, adequate comparison measurements were confirmed against 30 m open are test site. Therefore sufficient tests were made to demonstrate that the alternative site produces results that correlate with the ones of tests made in an open field based on KDB 937606.

4.8.2 Test Procedure

Test method Refer as KDB 558074 D01 v03r05, Section 12.1.

1. The EUT is placed on a turntable, Above 1 GHz is 1.5m and below 1 GHz is 0.8m above ground plane. The EUT Configured un accordance with ANSI C63.10, and the EUT set in a continuous mode.
2. The turntable shall be rotated for 360 degrees to determine the position of maximum emission level. And EUT is set 3m away from the receiving antenna, which is scanned from 1m to 4m above the ground plane to find out the highest emissions. Measurement are made polarized in both the vertical and the horizontal positions with antenna.
3. Span shall wide enough to full capture the emission measured. The SA from 30MHz to 26.5GHz set to the low, Mid and High channels with the EUT transmit.
4. For harmonic, the worst case of output power was BR-1Mbps. Therefore only BR-1Mbps record in the report.
5. The SA setting following :
 - (1) Below 1G : RBW = 100kHz, VBW \geq 3 RBW, Sweep = Auto, Detector = Peak, Trace = Max hold.
 - (2) Above 1G :
 - (2.1) For Peak measurement : RBW = 1MHz, VBW \geq 3 RBW, Sweep = Auto, Detector = Peak, Trace = Max hold.
 - (2.2) For Average measurement : RBW = 1MHz, VBW
 - If Duty Cycle \geq 98%, VBW=10Hz.
 - If Duty Cycle < 98%, VBW=1/T.

Configuration	Duty Cycle (%)	T(ms)	1/T (Hz)	VBW setting
GFSK_BR-1Mbps	100%	100.0000	-	10Hz
8DPSK_EDR-3Mbps	100%	1.0000	-	10Hz

4.8.3 Test Setup

9kHz ~ 30MHz

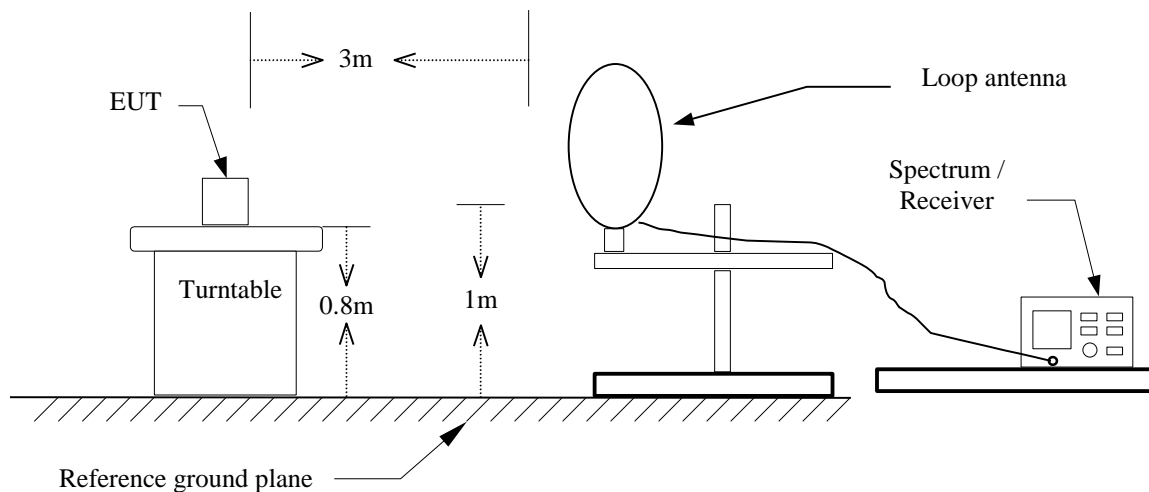

30MHz ~ 1GHz

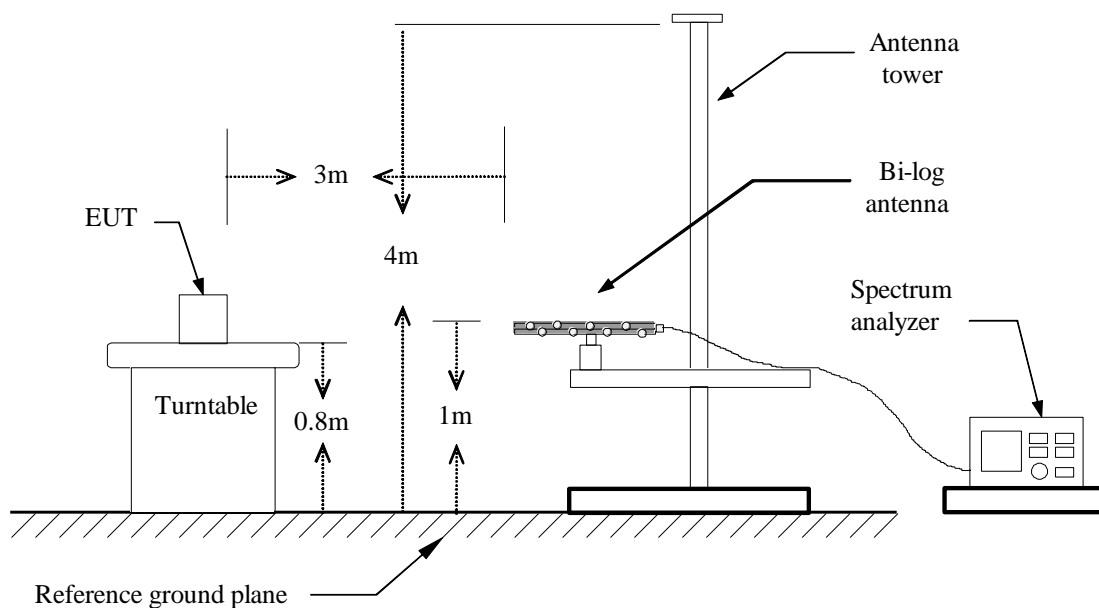

Above 1 GHz

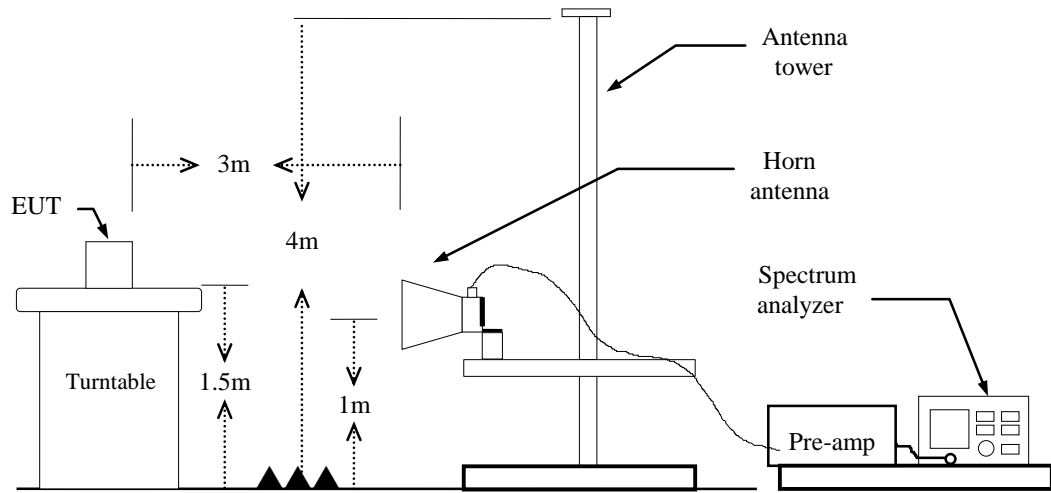

4.8.4 Test Result

Band Edge Test Data

Test Mode:	GFSK_BR-1Mbps Low CH	Temp/Hum	25(°C)/ 42%RH
Test Item	Band Edge	Test Date	April 13, 2017
Polarize	Horizontal	Test Engineer	Ed Chiang
Detector	Peak	Test Voltage:	120Vac / 60Hz

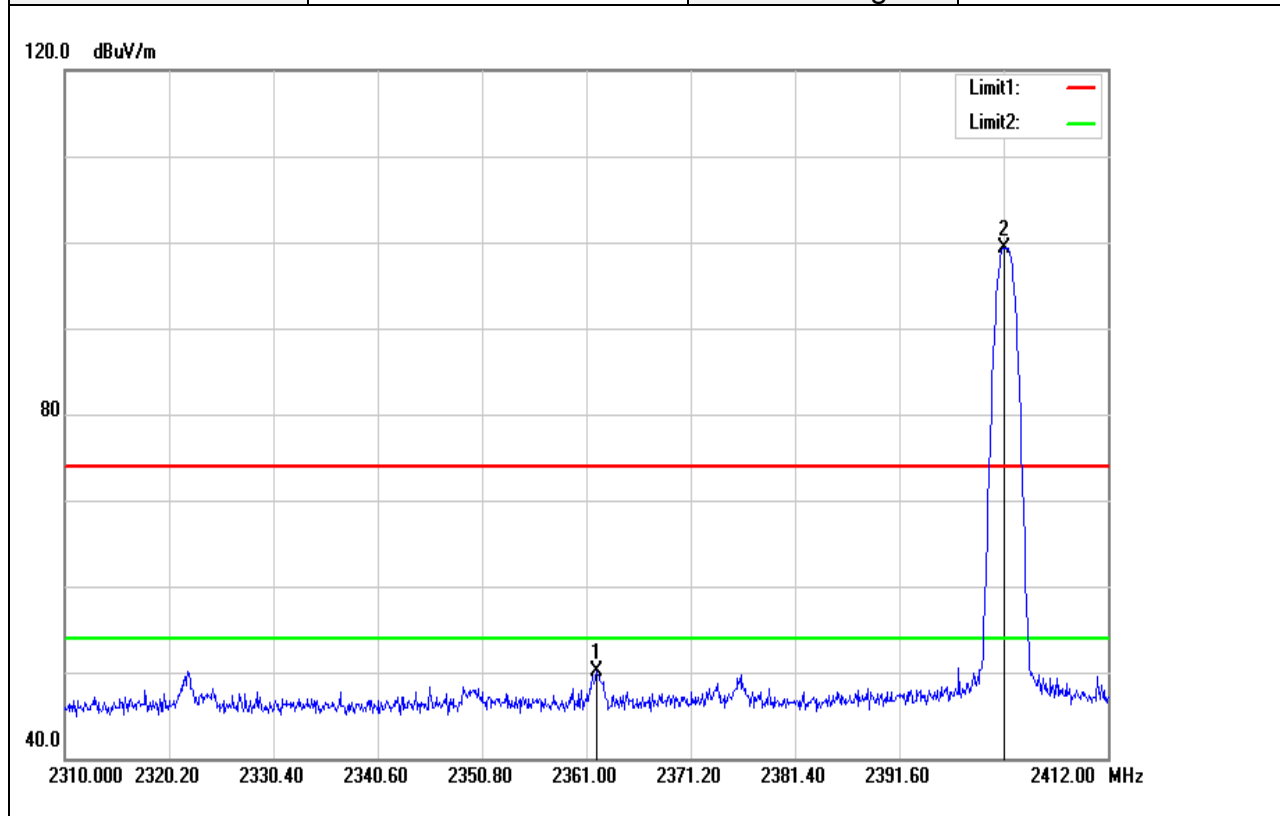

No.	Frequency (MHz)	Reading (dBuV)	Correct Factor(dB/m)	Result (dBuV/m)	Limit (dBuV/m)	Margin (dB)	Remark
1	2362.020	52.92	-2.78	50.14	74.00	-23.86	peak
2	2401.902	101.80	-2.41	99.39	-	-	peak

Test Mode:	GFSK_BR-1Mbps Low CH	Temp/Hum	25(°C)/ 42%RH
Test Item	Band Edge	Test Date	April 13, 2017
Polarize	Horizontal	Test Engineer	Ed Chiang
Detector	Average	Test Voltage:	120Vac / 60Hz

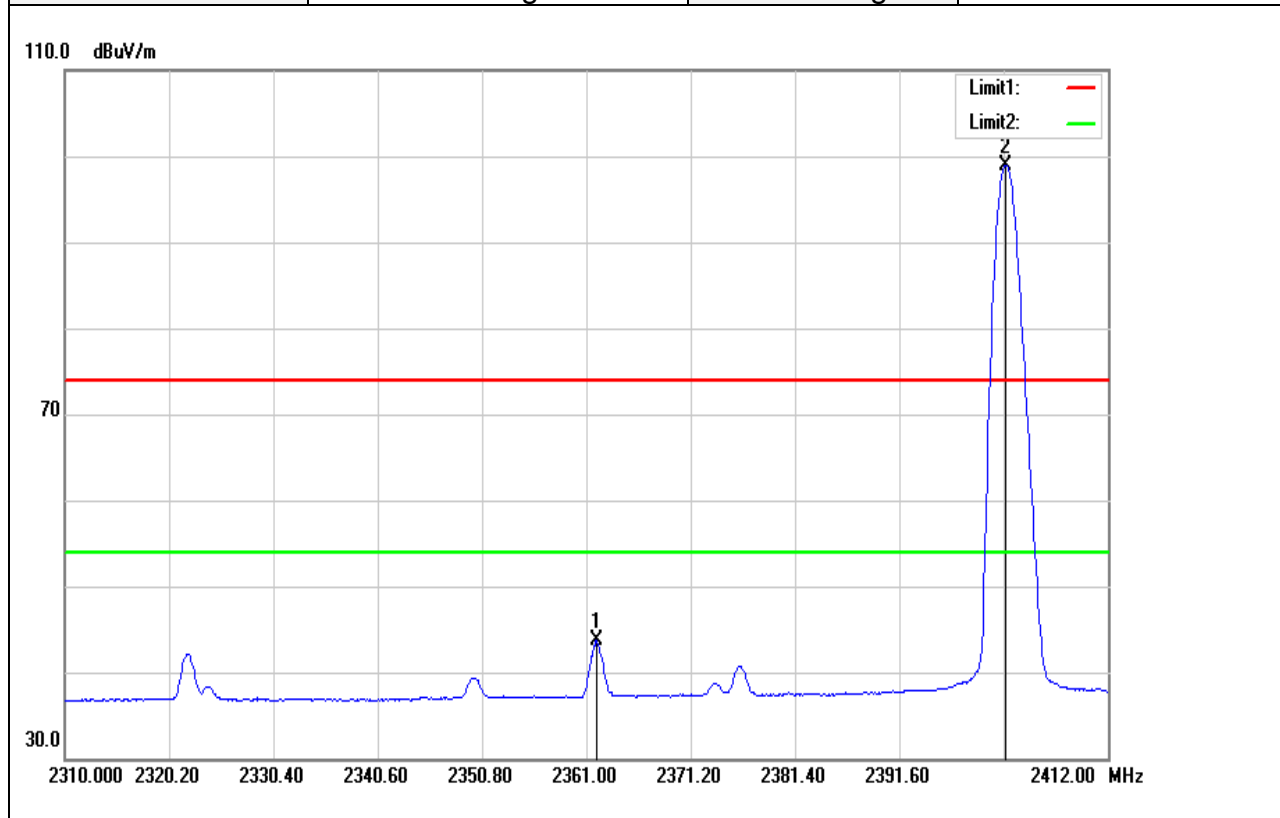

No.	Frequency (MHz)	Reading (dBuV)	Correct Factor(dB/m)	Result (dBuV/m)	Limit (dBuV/m)	Margin (dB)	Remark
1	2362.020	46.40	-2.78	43.62	54.00	-10.38	AVG
2	2402.004	101.38	-2.41	98.97	-	-	AVG

Test Mode:	GFSK_BR-1Mbps High CH	Temp/Hum	25(°C)/ 42%RH
Test Item	Band Edge	Test Date	April 13, 2017
Polarize	Horizontal	Test Engineer	Ed Chiang
Detector	Peak	Test Voltage:	120Vac / 60Hz

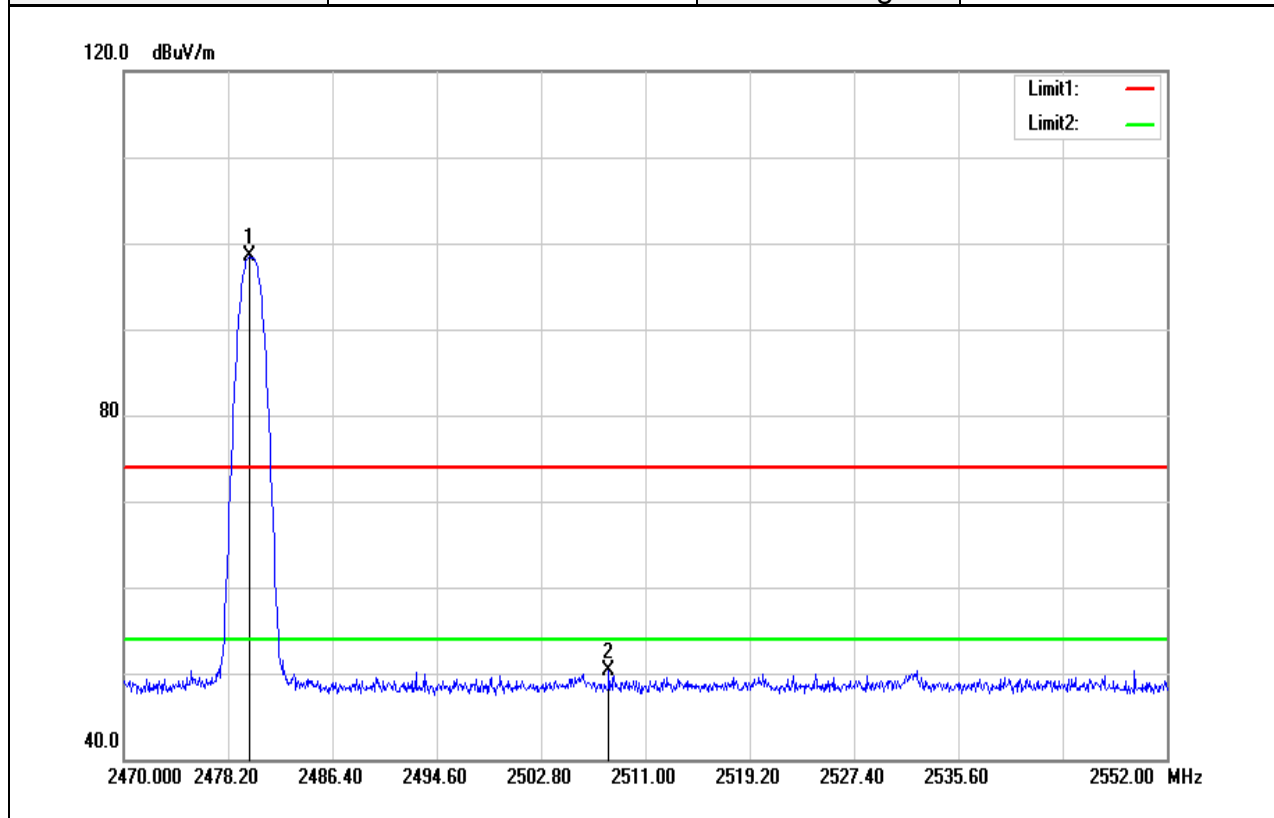

No.	Frequency (MHz)	Reading (dBuV)	Correct Factor(dB/m)	Result (dBuV/m)	Limit (dBuV/m)	Margin (dB)	Remark
1	2479.840	100.45	-2.03	98.42	-	-	peak
2	2508.130	52.20	-1.84	50.36	74.00	-23.64	peak

Test Mode:	GFSK_BR-1Mbps High CH	Temp/Hum	25(°C)/ 42%RH
Test Item	Band Edge	Test Date	April 13, 2017
Polarize	Horizontal	Test Engineer	Ed Chiang
Detector	Average	Test Voltage:	120Vac / 60Hz

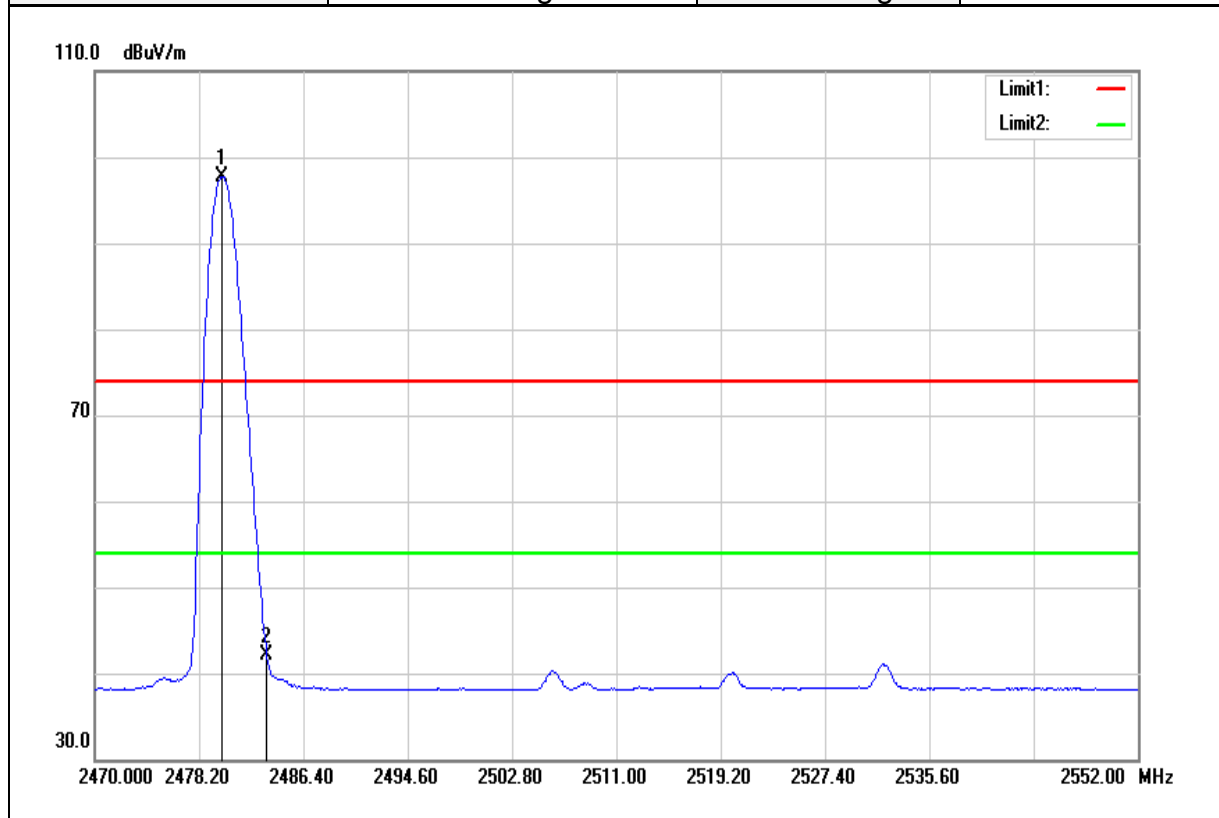

No.	Frequency (MHz)	Reading (dBuV)	Correct Factor(dB/m)	Result (dBuV/m)	Limit (dBuV/m)	Margin (dB)	Remark
1	2480.004	99.80	-2.03	97.77	-	-	AVG
2	2483.500	44.04	-1.99	42.05	54.00	-11.95	AVG

Test Mode:	8DPSK_EDR-3Mbps Low CH	Temp/Hum	25(°C)/ 42%RH
Test Item	Band Edge	Test Date	April 13, 2017
Polarize	Horizontal	Test Engineer	Ed Chiang
Detector	Peak	Test Voltage:	120Vac / 60Hz

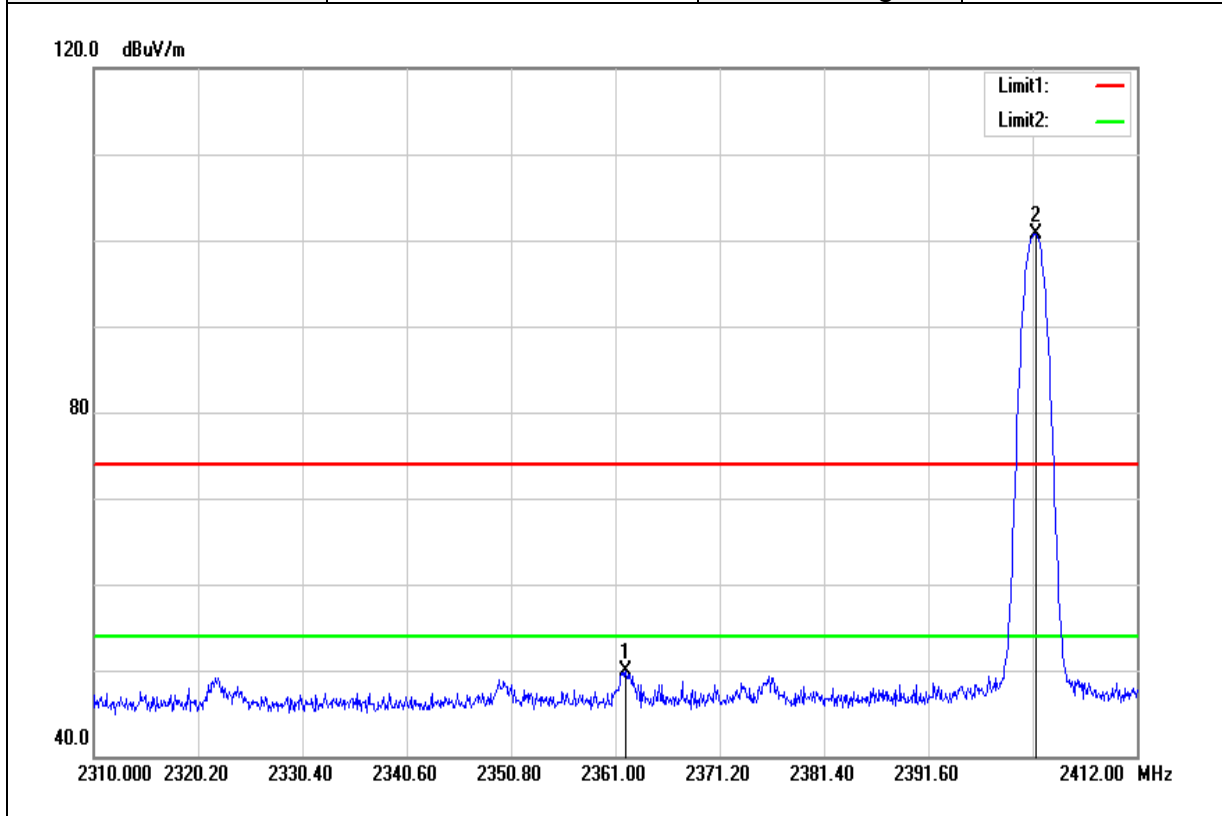

No.	Frequency (MHz)	Reading (dBuV)	Correct Factor(dB/m)	Result (dBuV/m)	Limit (dBuV/m)	Margin (dB)	Remark
1	2362.020	52.67	-2.78	49.89	74.00	-24.11	peak
2	2402.106	103.12	-2.41	100.71	-	-	peak

Test Mode:	8DPSK_EDR-3Mbps Low CH	Temp/Hum	25(°C)/ 42%RH
Test Item	Band Edge	Test Date	April 13, 2017
Polarize	Horizontal	Test Engineer	Ed Chiang
Detector	Average	Test Voltage:	120Vac / 60Hz

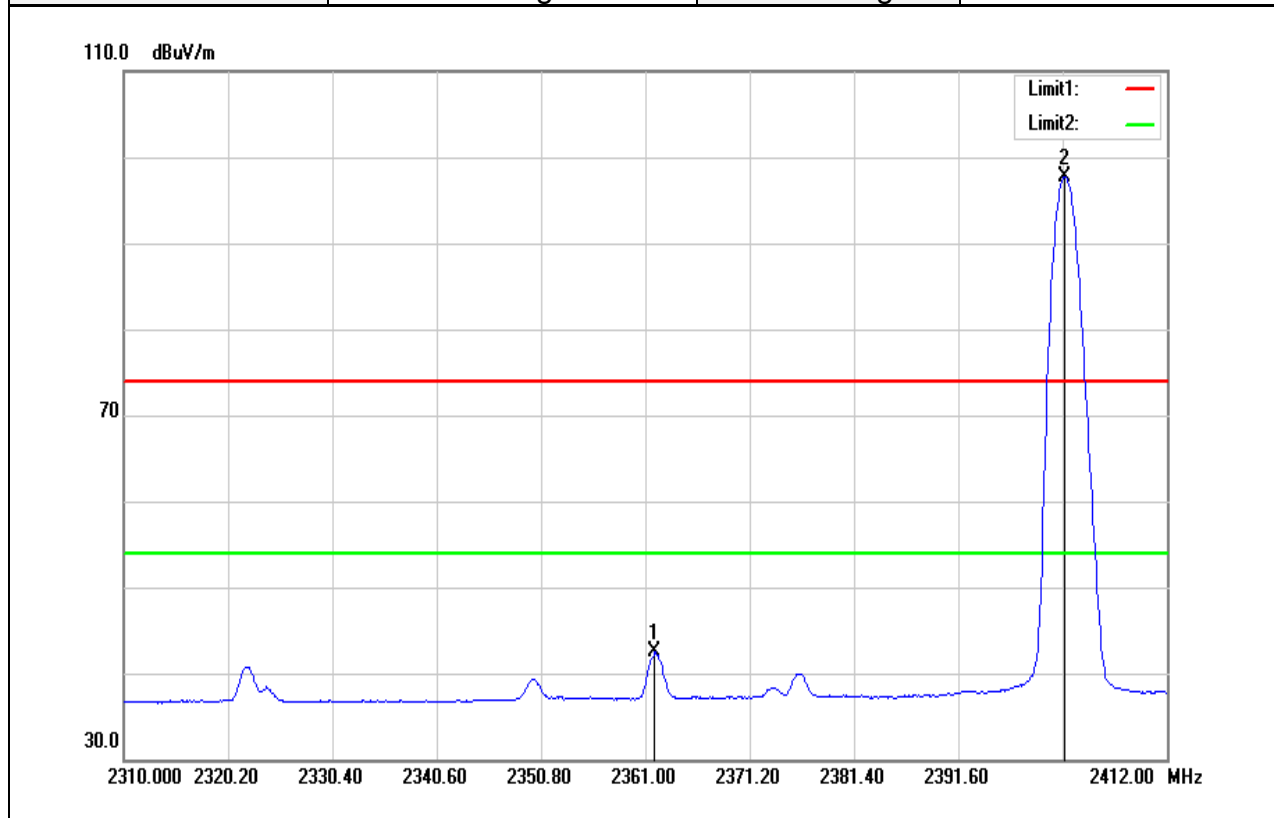

No.	Frequency (MHz)	Reading (dBuV)	Correct Factor(dB/m)	Result (dBuV/m)	Limit (dBuV/m)	Margin (dB)	Remark
1	2361.918	45.33	-2.78	42.55	54.00	-11.45	AVG
2	2402.004	100.09	-2.41	97.68	-	-	AVG

Test Mode:	8DPSK_EDR-3Mbps High CH	Temp/Hum	25(°C)/ 42%RH
Test Item	Band Edge	Test Date	April 13, 2017
Polarize	Horizontal	Test Engineer	Ed Chiang
Detector	Peak	Test Voltage:	120Vac / 60Hz

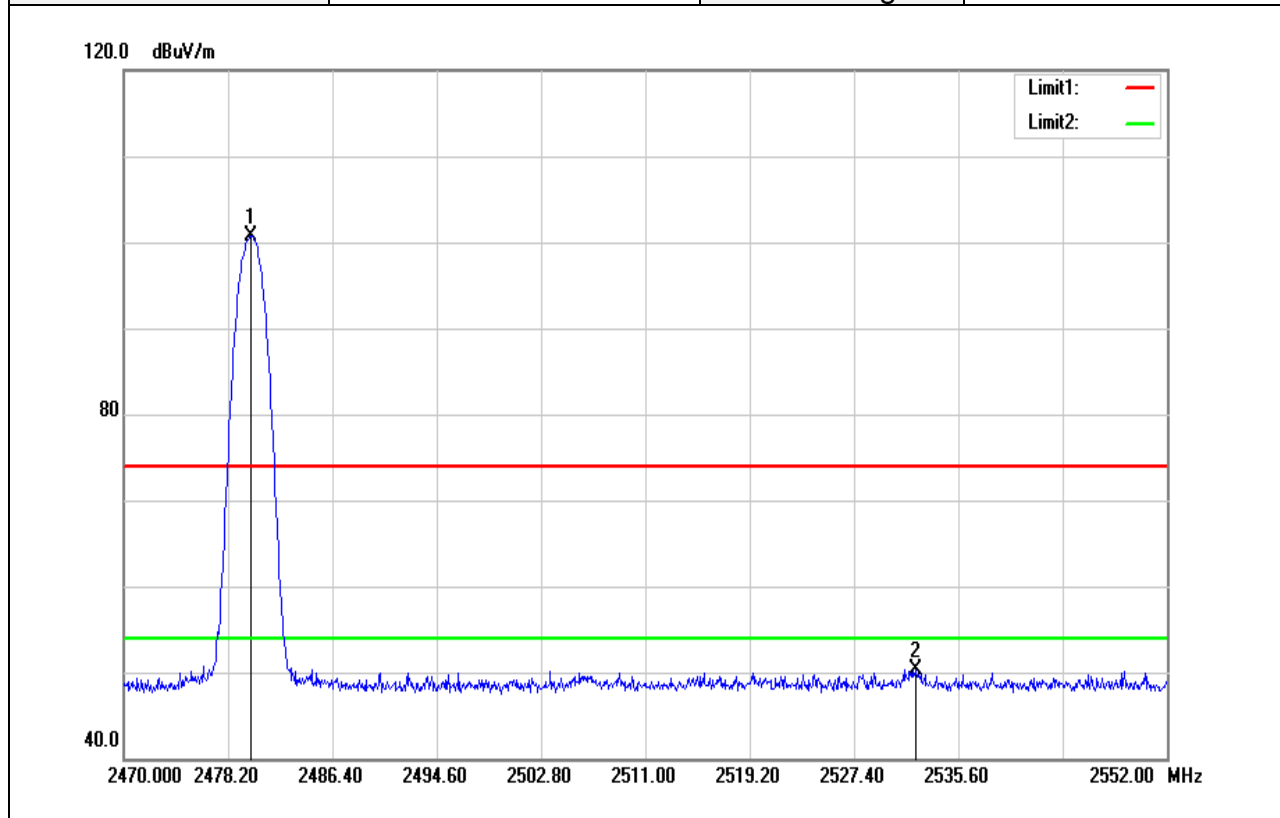

No.	Frequency (MHz)	Reading (dBuV)	Correct Factor(dB/m)	Result (dBuV/m)	Limit (dBuV/m)	Margin (dB)	Remark
1	2480.004	102.72	-2.03	100.69	-	-	peak
2	2532.238	52.05	-1.78	50.27	74.00	-23.73	peak

Test Mode:	8DPSK_EDR-3Mbps High CH	Temp/Hum	25(°C)/ 42%RH
Test Item	Band Edge	Test Date	April 13, 2017
Polarize	Horizontal	Test Engineer	Ed Chiang
Detector	Average	Test Voltage:	120Vac / 60Hz

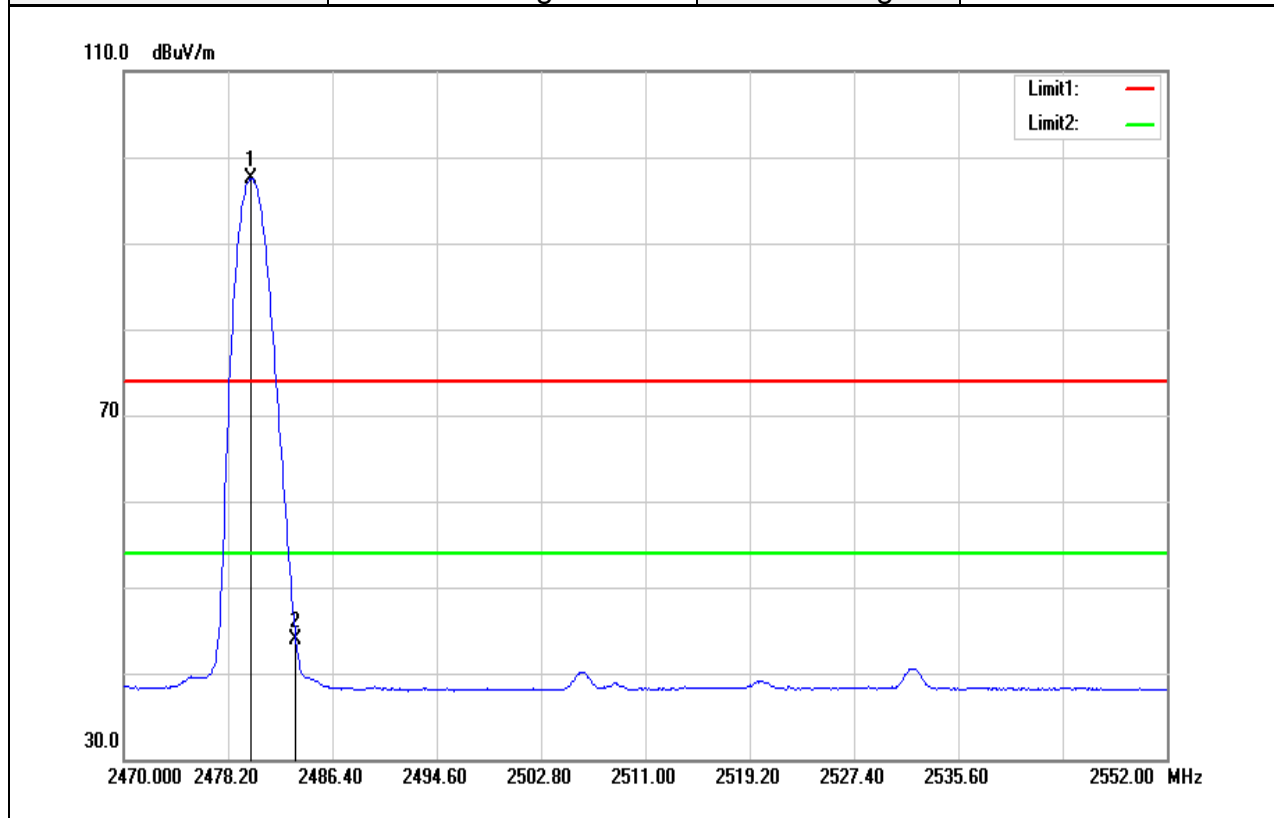

No.	Frequency (MHz)	Reading (dBuV)	Correct Factor(dB/m)	Result (dBuV/m)	Limit (dBuV/m)	Margin (dB)	Remark
1	2480.004	99.51	-2.03	97.48	-	-	AVG
2	2483.500	45.86	-1.99	43.87	54.00	-10.13	AVG

Above 1G Test Data

Test Mode:	GFSK_BR-1Mbps Low CH	Temp/Hum	25(°C)/ 42%RH
Test Item	Harmonic	Test Date	April 13, 2017
Polarize	Vertical	Test Engineer	Ed Chiang
Detector	Peak and Average	Test Voltage:	120Vac / 60Hz

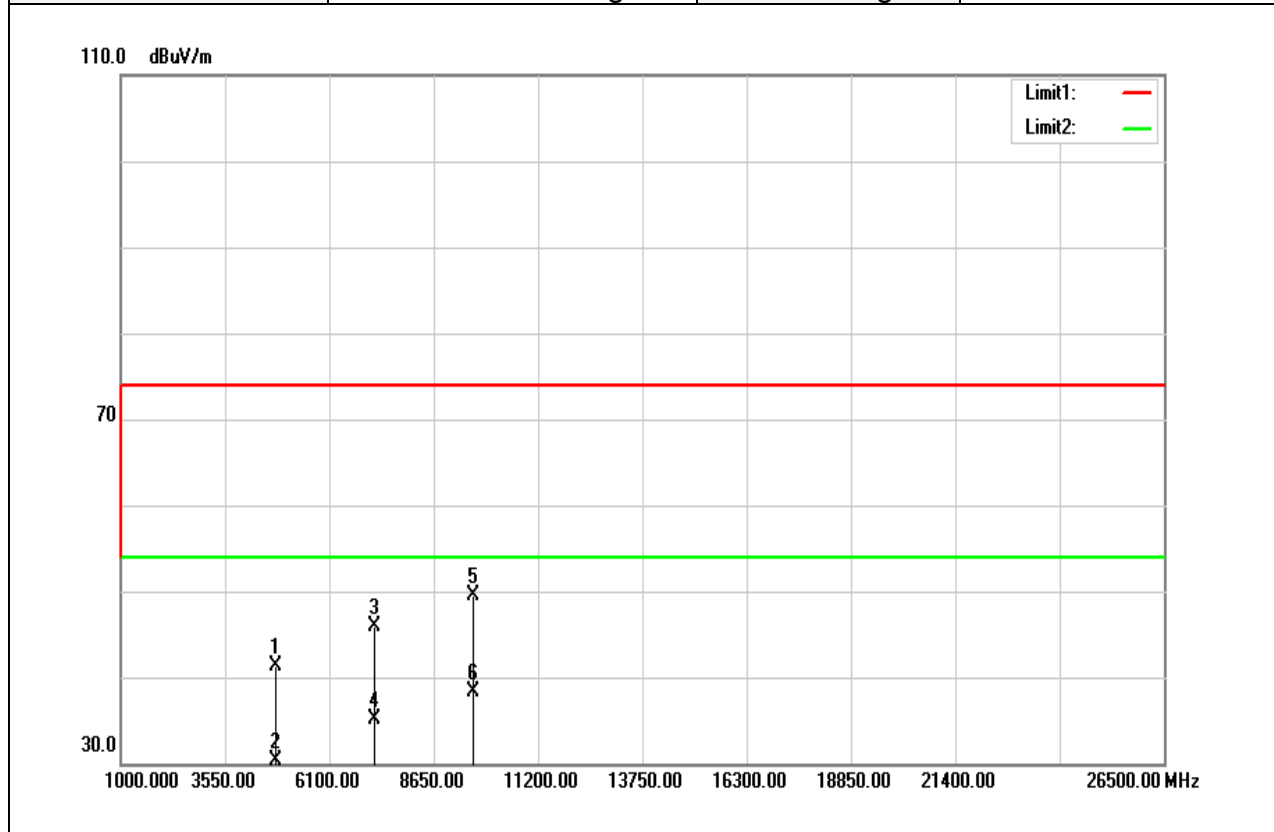

Frequency (MHz)	Reading (dBuV)	Correct Factor (dB/m)	Result (dBuV/m)	Limit (dBuV/m)	Margin (dB)	Remark
4804.000	36.35	5.04	41.39	74.00	-32.61	peak
4804.000	25.20	5.04	30.24	54.00	-23.76	AVG
7206.000	33.38	12.62	46.00	74.00	-28.00	peak
7206.000	22.55	12.62	35.17	54.00	-18.83	AVG
9608.000	31.93	17.60	49.53	74.00	-24.47	peak
9608.000	20.74	17.60	38.34	54.00	-15.66	AVG

Remark:

1. Measuring frequencies from 1 GHz to the 10th harmonic of highest fundamental frequency.
2. For above 1GHz, the EUT peak value was under average limit, therefore the Average value compliance with the average limit

Test Mode:	GFSK_BR-1Mbps Low CH	Temp/Hum	25(°C)/ 42%RH
Test Item	Harmonic	Test Date	April 13, 2017
Polarize	Horizontal	Test Engineer	Ed Chiang
Detector	Peak and Average	Test Voltage:	120Vac / 60Hz

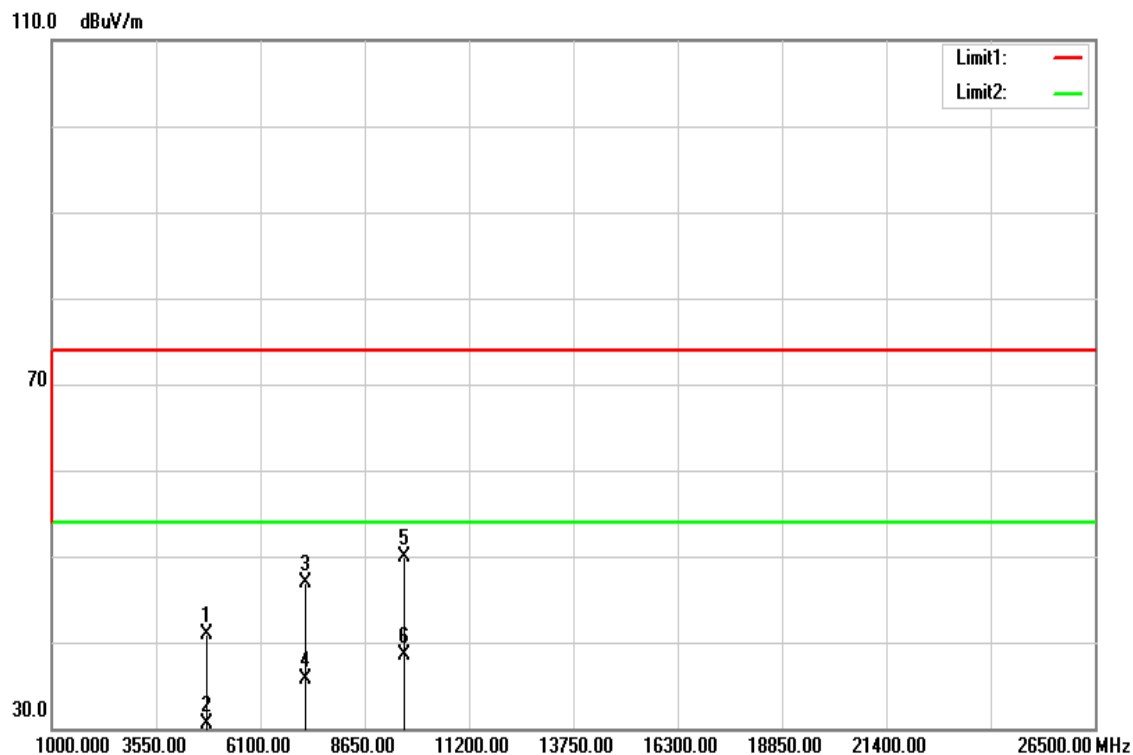

Frequency (MHz)	Reading (dBuV)	Correct Factor (dB/m)	Result (dBuV/m)	Limit (dBuV/m)	Margin (dB)	Remark
4804.000	35.77	5.04	40.81	74.00	-33.19	peak
4804.000	25.37	5.04	30.41	54.00	-23.59	AVG
7206.000	34.29	12.62	46.91	74.00	-27.09	peak
7206.000	23.04	12.62	35.66	54.00	-18.34	AVG
9608.000	32.38	17.60	49.98	74.00	-24.02	peak
9608.000	20.87	17.60	38.47	54.00	-15.53	AVG

Remark:

1. Measuring frequencies from 1 GHz to the 10th harmonic of highest fundamental frequency.
2. For above 1GHz, the EUT peak value was under average limit, therefore the Average value compliance with the average limit

Test Mode:	GFSK_BR-1Mbps Mid CH	Temp/Hum	25(°C)/ 42%RH
Test Item	Harmonic	Test Date	April 13, 2017
Polarize	Vertical	Test Engineer	Ed Chiang
Detector	Peak and Average	Test Voltage:	120Vac / 60Hz

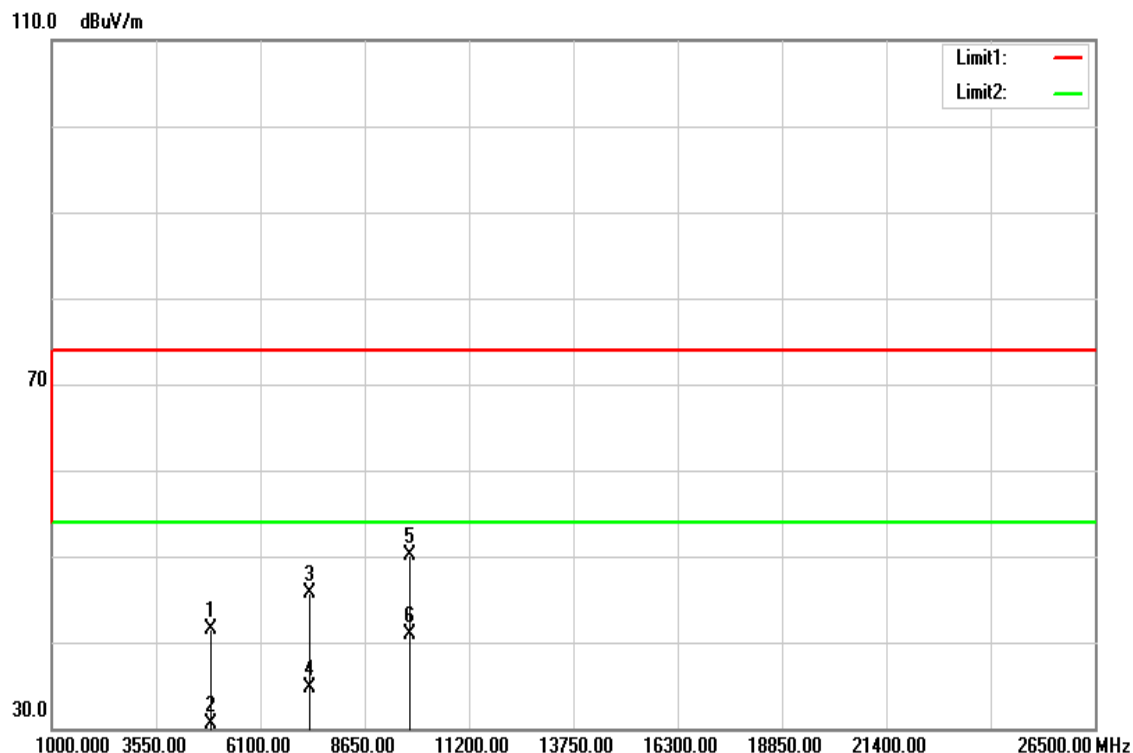

Frequency (MHz)	Reading (dBuV)	Correct Factor (dB/m)	Result (dBuV/m)	Limit (dBuV/m)	Margin (dB)	Remark
4882.000	36.16	5.25	41.41	74.00	-32.59	peak
4882.000	25.33	5.25	30.58	54.00	-23.42	AVG
7323.000	32.80	12.98	45.78	74.00	-28.22	peak
7323.000	21.64	12.98	34.62	54.00	-19.38	AVG
9764.000	32.53	17.60	50.13	74.00	-23.87	peak
9764.000	23.27	17.60	40.87	54.00	-13.13	AVG

Remark:

1. Measuring frequencies from 1 GHz to the 10th harmonic of highest fundamental frequency.
2. For above 1GHz, the EUT peak value was under average limit, therefore the Average value compliance with the average limit

Test Mode:	GFSK_BR-1Mbps Mid CH	Temp/Hum	25(°C)/ 42%RH
Test Item	Harmonic	Test Date	April 13, 2017
Polarize	Horizontal	Test Engineer	Ed Chiang
Detector	Peak and Average	Test Voltage:	120Vac / 60Hz

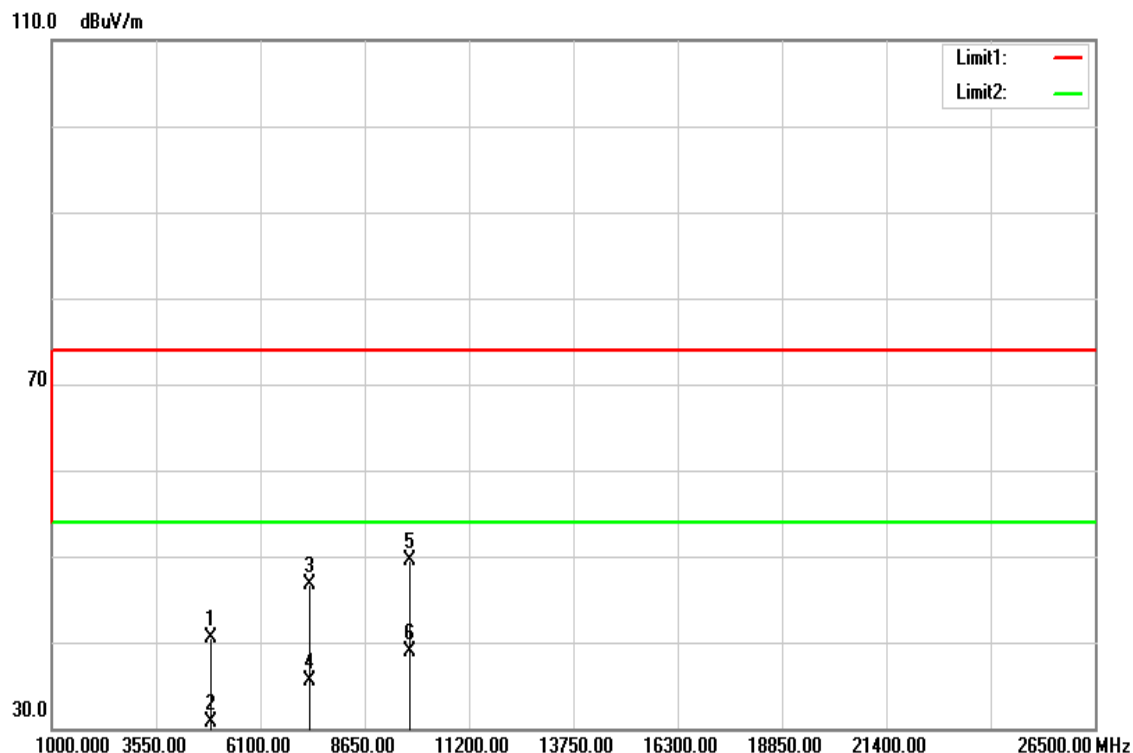

Frequency (MHz)	Reading (dBuV)	Correct Factor (dB/m)	Result (dBuV/m)	Limit (dBuV/m)	Margin (dB)	Remark
4882.000	35.26	5.25	40.51	74.00	-33.49	peak
4882.000	25.50	5.25	30.75	54.00	-23.25	AVG
7323.000	33.80	12.98	46.78	74.00	-27.22	peak
7323.000	22.43	12.98	35.41	54.00	-18.59	AVG
9764.000	31.91	17.60	49.51	74.00	-24.49	peak
9764.000	21.32	17.60	38.92	54.00	-15.08	AVG

Remark:

1. Measuring frequencies from 1 GHz to the 10th harmonic of highest fundamental frequency.
2. For above 1GHz, the EUT peak value was under average limit, therefore the Average value compliance with the average limit

Test Mode:	GFSK_BR-1Mbps High CH	Temp/Hum	25(°C)/ 42%RH
Test Item	Harmonic	Test Date	April 13, 2017
Polarize	Vertical	Test Engineer	Ed Chiang
Detector	Peak and Average	Test Voltage:	120Vac / 60Hz

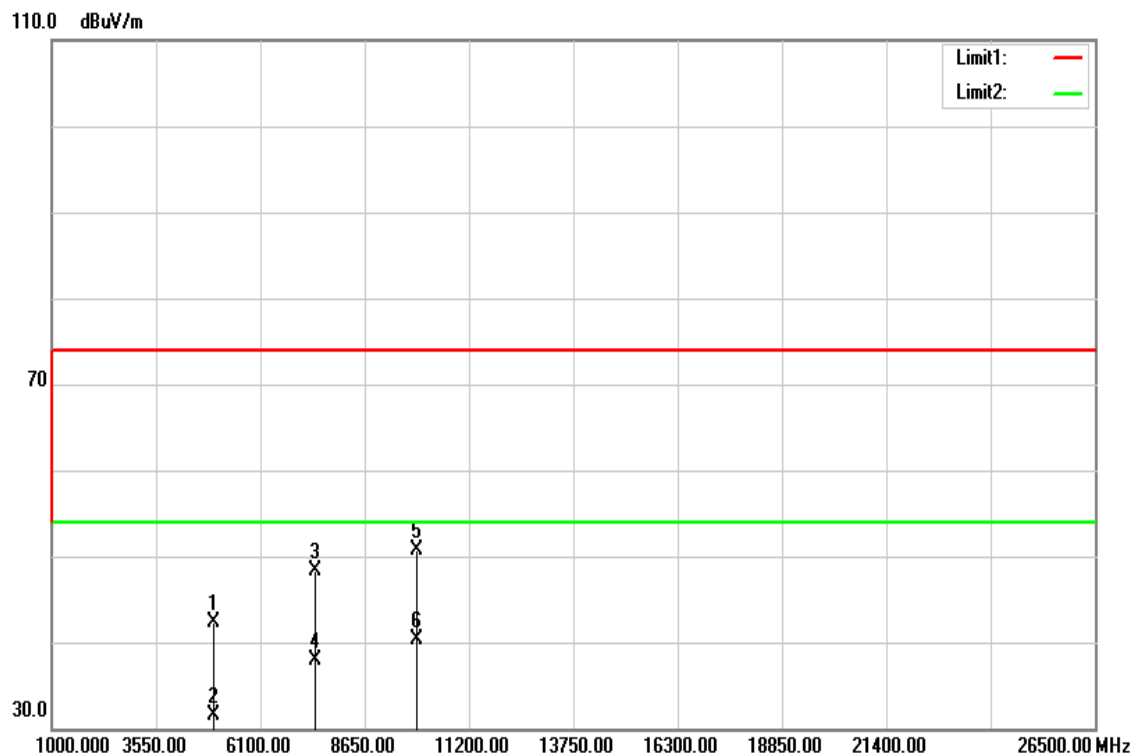

Frequency (MHz)	Reading (dBuV)	Correct Factor (dB/m)	Result (dBuV/m)	Limit (dBuV/m)	Margin (dB)	Remark
4960.000	36.81	5.46	42.27	74.00	-31.73	peak
4960.000	26.12	5.46	31.58	54.00	-22.42	AVG
7440.000	35.05	13.33	48.38	74.00	-25.62	peak
7440.000	24.55	13.33	37.88	54.00	-16.12	AVG
9920.000	33.09	17.60	50.69	74.00	-23.31	peak
9920.000	22.61	17.60	40.21	54.00	-13.79	AVG

Remark:

1. Measuring frequencies from 1 GHz to the 10th harmonic of highest fundamental frequency.
2. For above 1GHz, the EUT peak value was under average limit, therefore the Average value compliance with the average limit

Test Mode:	GFSK_BR-1Mbps High CH	Temp/Hum	25(°C)/ 42%RH
Test Item	Harmonic	Test Date	April 13, 2017
Polarize	Horizontal	Test Engineer	Ed Chiang
Detector	Peak and Average	Test Voltage:	120Vac / 60Hz

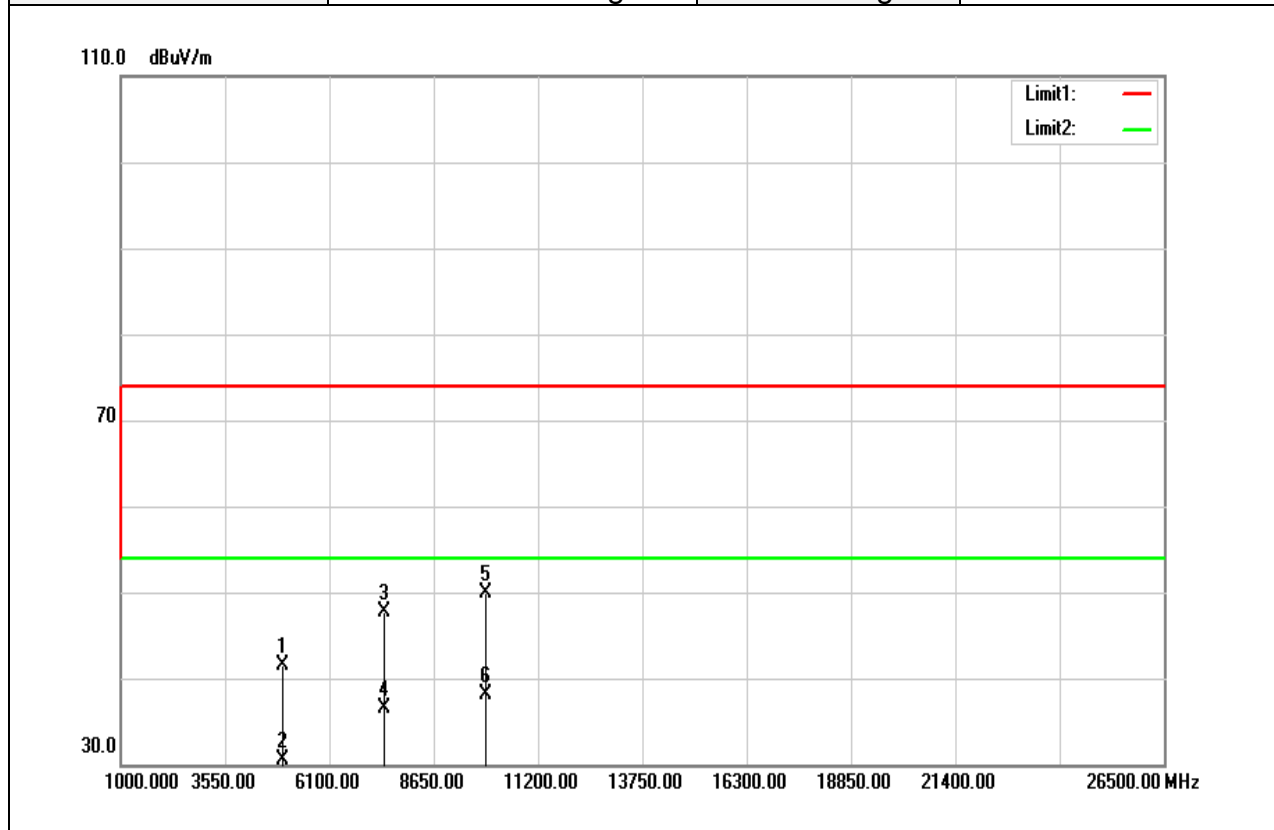

Frequency (MHz)	Reading (dBuV)	Correct Factor (dB/m)	Result (dBuV/m)	Limit (dBuV/m)	Margin (dB)	Remark
4960.000	35.99	5.46	41.45	74.00	-32.55	peak
4960.000	25.09	5.46	30.55	54.00	-23.45	AVG
7440.000	34.39	13.33	47.72	74.00	-26.28	peak
7440.000	23.14	13.33	36.47	54.00	-17.53	AVG
9920.000	32.22	17.60	49.82	74.00	-24.18	peak
9920.000	20.55	17.60	38.15	54.00	-15.85	AVG

Remark:

1. Measuring frequencies from 1 GHz to the 10th harmonic of highest fundamental frequency.
2. For above 1GHz, the EUT peak value was under average limit, therefore the Average value compliance with the average limit

Test Mode	8DPSK_EDR-3Mbps Low CH	Temp/Hum	25(°C)/ 42%RH
Test Item	Harmonic	Test Date	April 13, 2017
Polarize	Vertical	Test Engineer	Ed Chiang
Detector	Peak and Average		

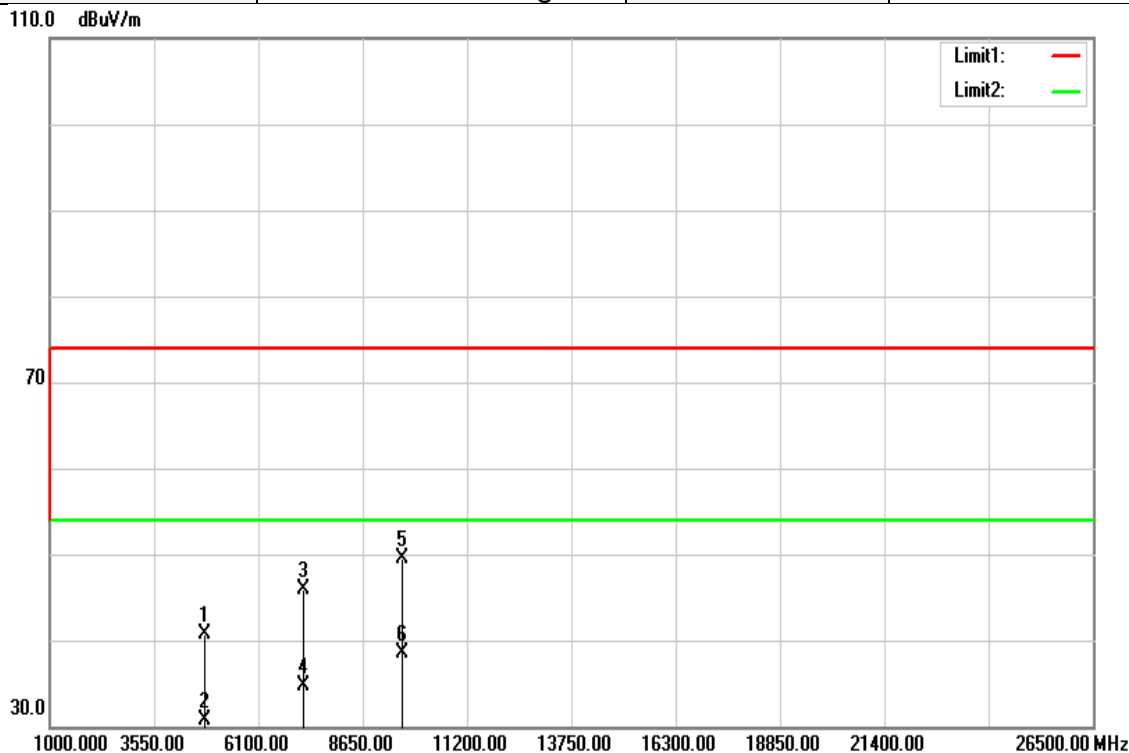

Frequency (MHz)	Reading (dBuV)	Correct Factor (dB/m)	Result (dBuV/m)	Limit (dBuV/m)	Margin (dB)	Remark
4804.000	35.63	5.04	40.67	74.00	-33.33	peak
4804.000	25.70	5.04	30.74	54.00	-23.26	AVG
7206.000	33.37	12.62	45.99	74.00	-28.01	peak
7206.000	22.06	12.62	34.68	54.00	-19.32	AVG
9608.000	32.00	17.60	49.60	74.00	-24.40	peak
9608.000	20.82	17.60	38.42	54.00	-15.58	AVG

Remark:

1. Measuring frequencies from 1 GHz to the 10th harmonic of highest fundamental frequency.
2. For above 1GHz, the EUT peak value was under average limit, therefore the Average value compliance with the average limit

Test Mode	8DPSK_EDR-3Mbps Low CH	Temp/Hum	25(°C)/ 42%RH
Test Item	Harmonic	Test Date	April 13, 2017
Polarize	Horizontal	Test Engineer	Ed Chiang
Detector	Peak and Average		

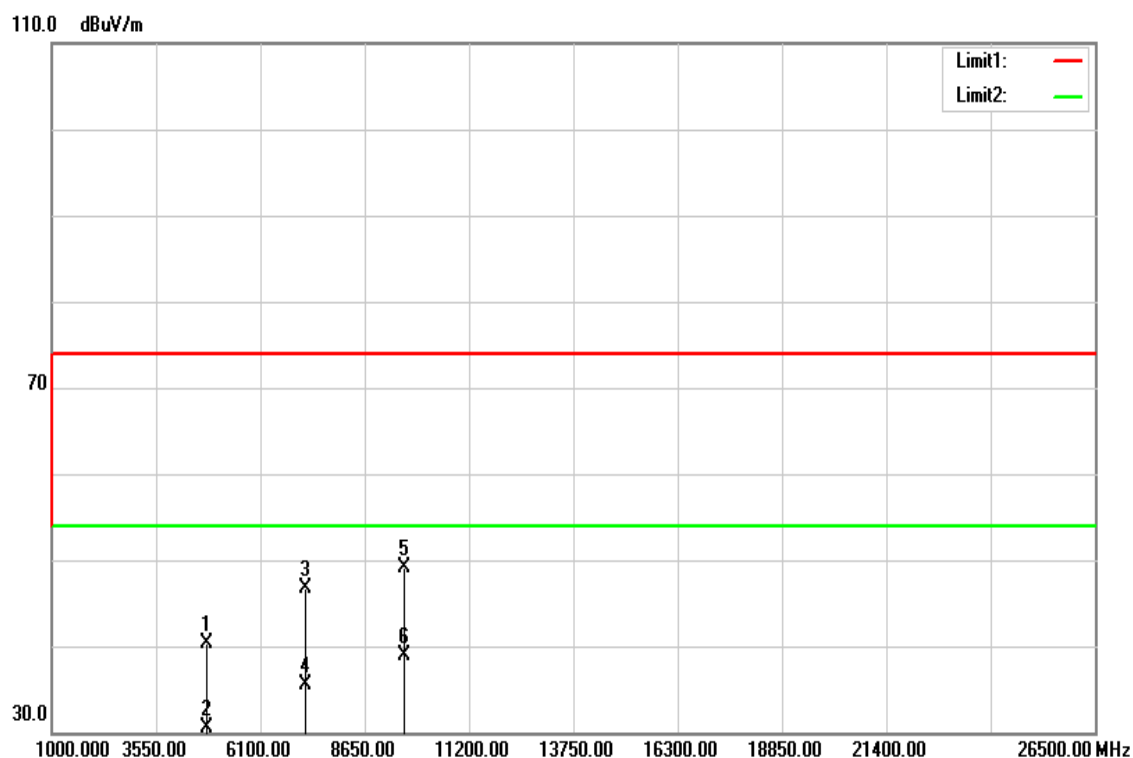

Frequency (MHz)	Reading (dBuV)	Correct Factor (dB/m)	Result (dBuV/m)	Limit (dBuV/m)	Margin (dB)	Remark
4804.000	35.22	5.04	40.26	74.00	-33.74	peak
4804.000	25.40	5.04	30.44	54.00	-23.56	AVG
7206.000	34.03	12.62	46.65	74.00	-27.35	peak
7206.000	22.85	12.62	35.47	54.00	-18.53	AVG
9608.000	31.46	17.60	49.06	74.00	-24.94	peak
9608.000	21.32	17.60	38.92	54.00	-15.08	AVG

Remark:

1. Measuring frequencies from 1 GHz to the 10th harmonic of highest fundamental frequency.
2. For above 1GHz, the EUT peak value was under average limit, therefore the Average value compliance with the average limit

Test Mode	8DPSK_EDR-3Mbps Mid CH	Temp/Hum	25(°C)/ 42%RH
Test Item	Harmonic	Test Date	April 13, 2017
Polarize	Vertical	Test Engineer	Ed Chiang
Detector	Peak and Average		

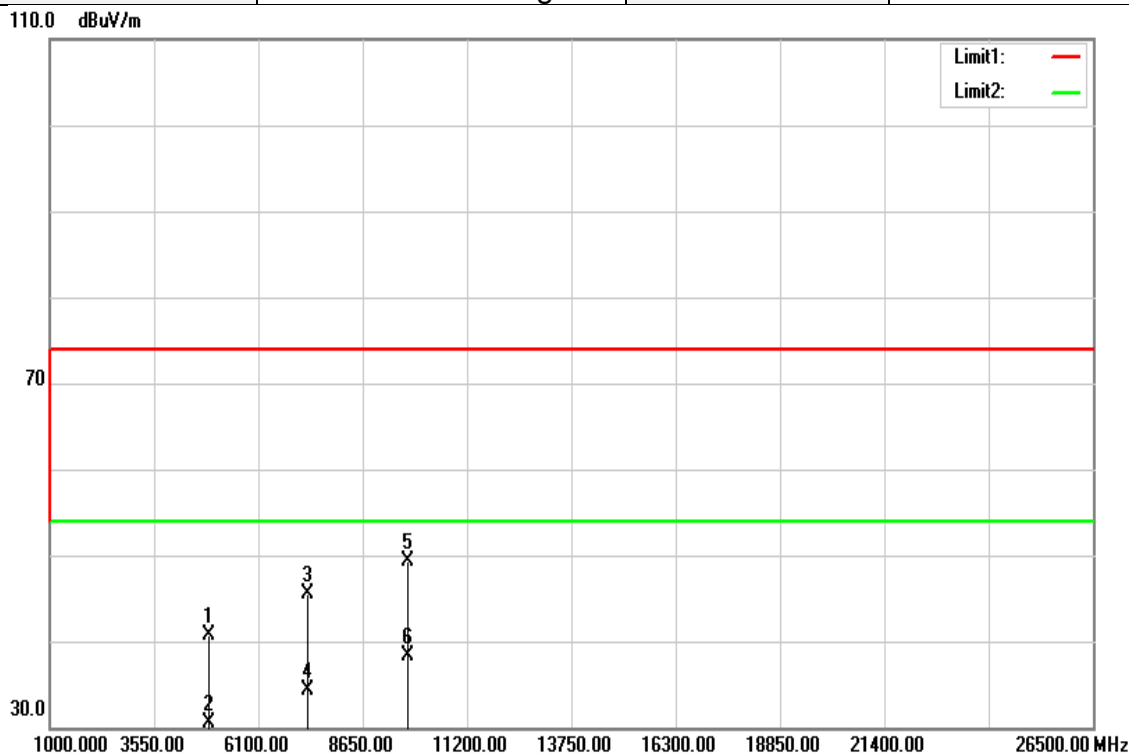

Frequency (MHz)	Reading (dBuV)	Correct Factor (dB/m)	Result (dBuV/m)	Limit (dBuV/m)	Margin (dB)	Remark
4882.000	35.50	5.25	40.75	74.00	-33.25	peak
4882.000	25.29	5.25	30.54	54.00	-23.46	AVG
7323.000	32.53	12.98	45.51	74.00	-28.49	peak
7323.000	21.40	12.98	34.38	54.00	-19.62	AVG
9764.000	31.63	17.60	49.23	74.00	-24.77	peak
9764.000	20.61	17.60	38.21	54.00	-15.79	AVG

Remark:

1. Measuring frequencies from 1 GHz to the 10th harmonic of highest fundamental frequency.
2. For above 1GHz, the EUT peak value was under average limit, therefore the Average value compliance with the average limit

Test Mode	8DPSK_EDR-3Mbps Mid CH	Temp/Hum	25(°C)/ 42%RH
Test Item	Harmonic	Test Date	April 13, 2017
Polarize	Horizontal	Test Engineer	Ed Chiang
Detector	Peak and Average		

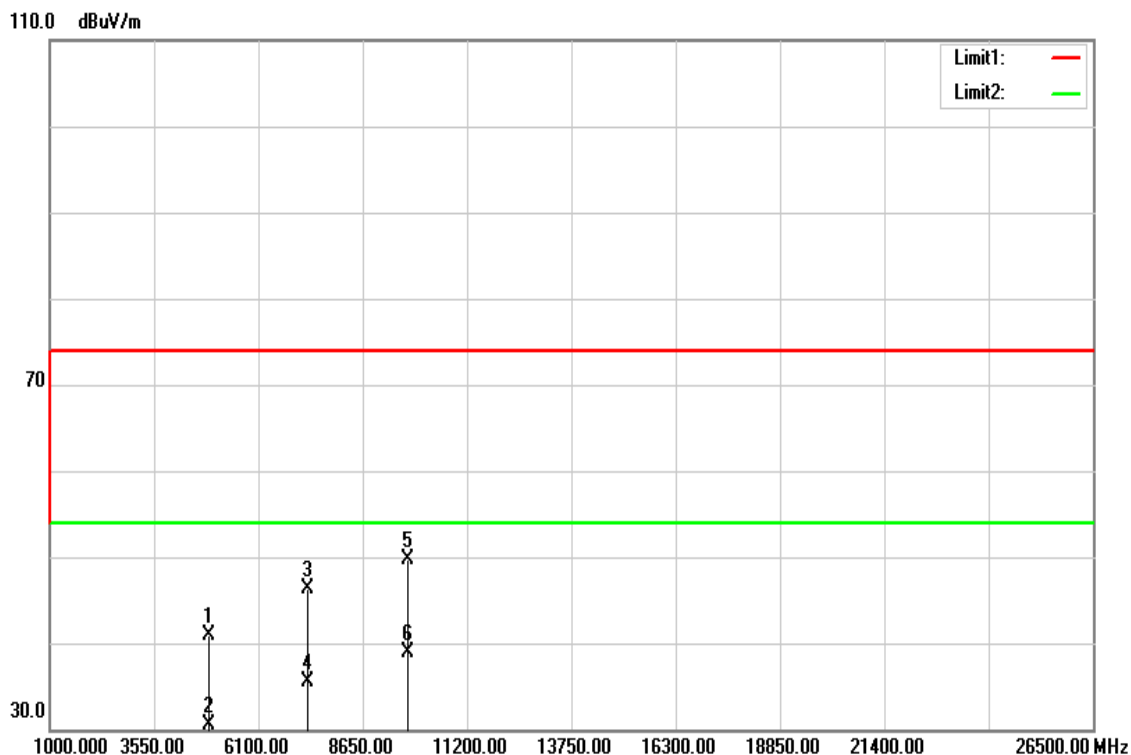

Frequency (MHz)	Reading (dBuV)	Correct Factor (dB/m)	Result (dBuV/m)	Limit (dBuV/m)	Margin (dB)	Remark
4882.000	35.59	5.25	40.84	74.00	-33.16	peak
4882.000	25.33	5.25	30.58	54.00	-23.42	AVG
7323.000	33.38	12.98	46.36	74.00	-27.64	peak
7323.000	22.43	12.98	35.41	54.00	-18.59	AVG
9764.000	32.15	17.60	49.75	74.00	-24.25	peak
9764.000	21.24	17.60	38.84	54.00	-15.16	AVG

Remark:

1. Measuring frequencies from 1 GHz to the 10th harmonic of highest fundamental frequency.
2. For above 1GHz, the EUT peak value was under average limit, therefore the Average value compliance with the average limit

Test Mode	8DPSK_EDR-3Mbps High CH	Temp/Hum	25(°C)/ 42%RH
Test Item	Harmonic	Test Date	April 13, 2017
Polarize	Vertical	Test Engineer	Ed Chiang
Detector	Peak and Average		

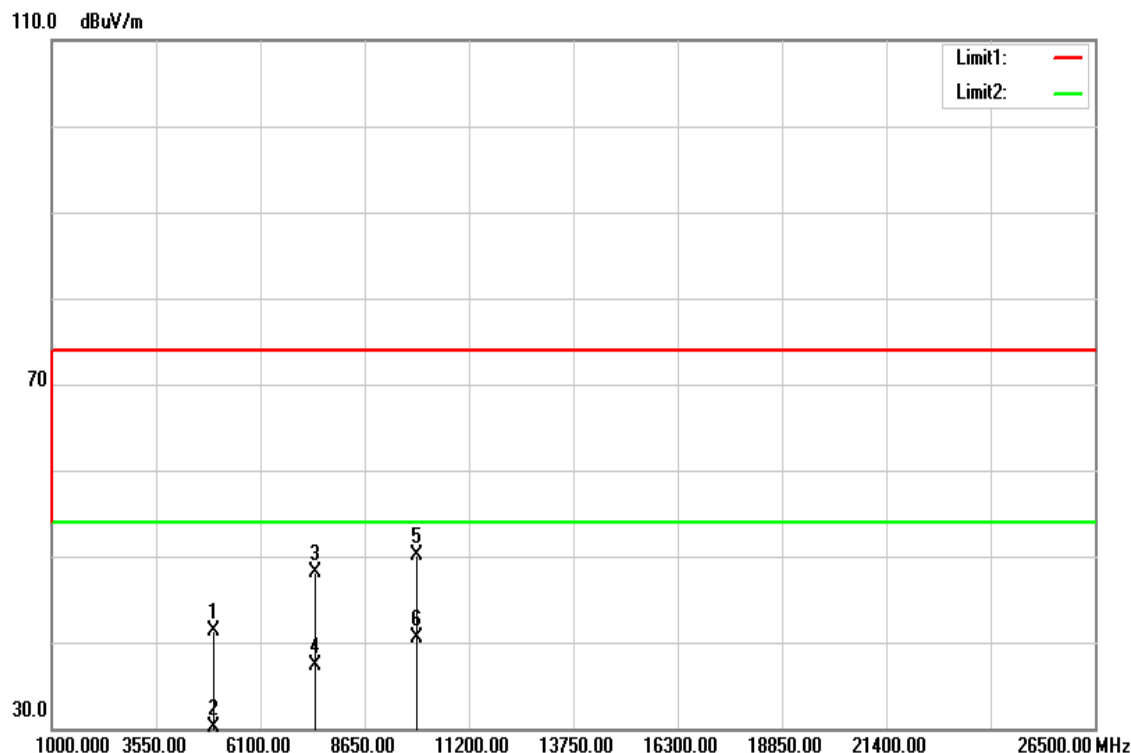

Frequency (MHz)	Reading (dBuV)	Correct Factor (dB/m)	Result (dBuV/m)	Limit (dBuV/m)	Margin (dB)	Remark
4960.000	35.75	5.46	41.21	74.00	-32.79	peak
4960.000	24.69	5.46	30.15	54.00	-23.85	AVG
7440.000	34.74	13.33	48.07	74.00	-25.93	peak
7440.000	24.01	13.33	37.34	54.00	-16.66	AVG
9920.000	32.55	17.60	50.15	74.00	-23.85	peak
9920.000	22.81	17.60	40.41	54.00	-13.59	AVG

Remark:

1. Measuring frequencies from 1 GHz to the 10th harmonic of highest fundamental frequency.
2. For above 1GHz, the EUT peak value was under average limit, therefore the Average value compliance with the average limit

Test Mode	8DPSK_EDR-3Mbps High CH	Temp/Hum	25(°C)/ 42%RH
Test Item	Harmonic	Test Date	April 13, 2017
Polarize	Horizontal	Test Engineer	Ed Chiang
Detector	Peak and Average		

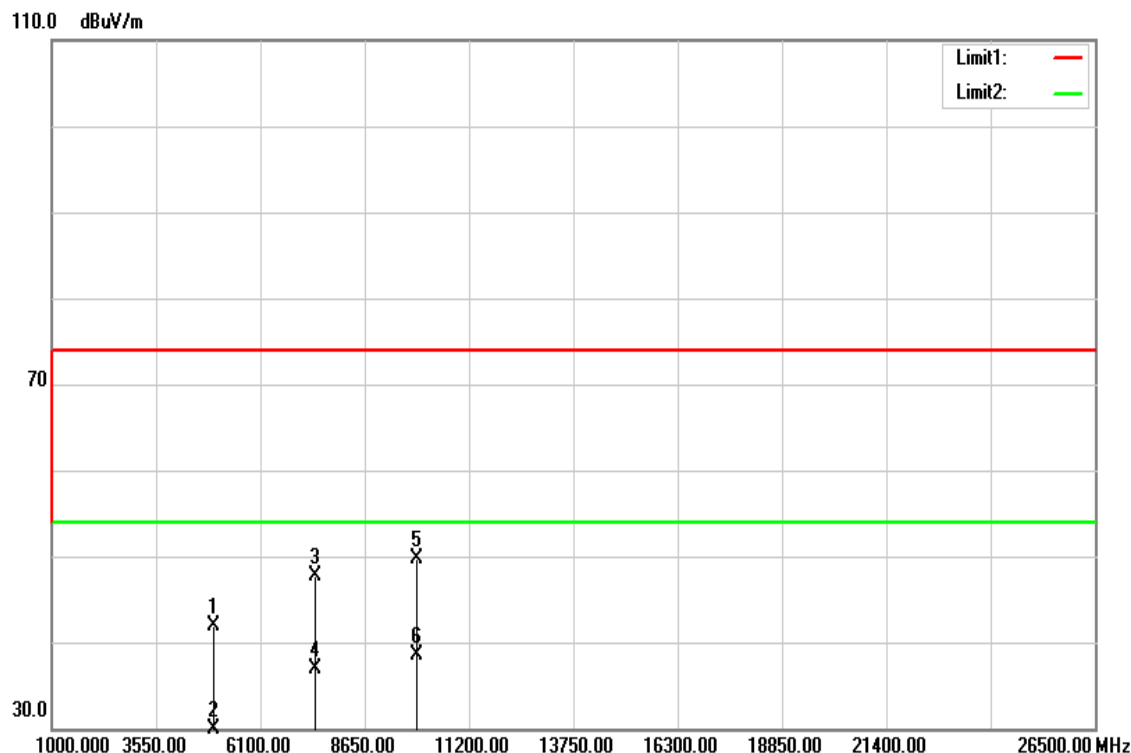

Frequency (MHz)	Reading (dBuV)	Correct Factor (dB/m)	Result (dBuV/m)	Limit (dBuV/m)	Margin (dB)	Remark
4960.000	36.36	5.46	41.82	74.00	-32.18	peak
4960.000	-4.77	5.46	30.69	54.00	-53.31	AVG
7440.000	34.41	13.33	47.74	74.00	-26.26	peak
7440.000	23.61	13.33	36.94	54.00	-17.06	AVG
9920.000	32.09	17.60	49.69	74.00	-24.31	peak
9920.000	20.87	17.60	38.47	54.00	-15.53	AVG

Remark:

1. Measuring frequencies from 1 GHz to the 10th harmonic of highest fundamental frequency.
2. For above 1GHz, the EUT peak value was under average limit, therefore the Average value compliance with the average limit

Below 1G Test Data

Test Mode:	Made 1	Temp/Hum	25(°C)/ 42%RH
Test Item	30MHz-1GHz	Test Date	April 13, 2017
Polarize	Vertical	Test Engineer	Ed Chiang
Detector	Peak and Qusi-peak	Test Voltage:	120Vac / 60Hz

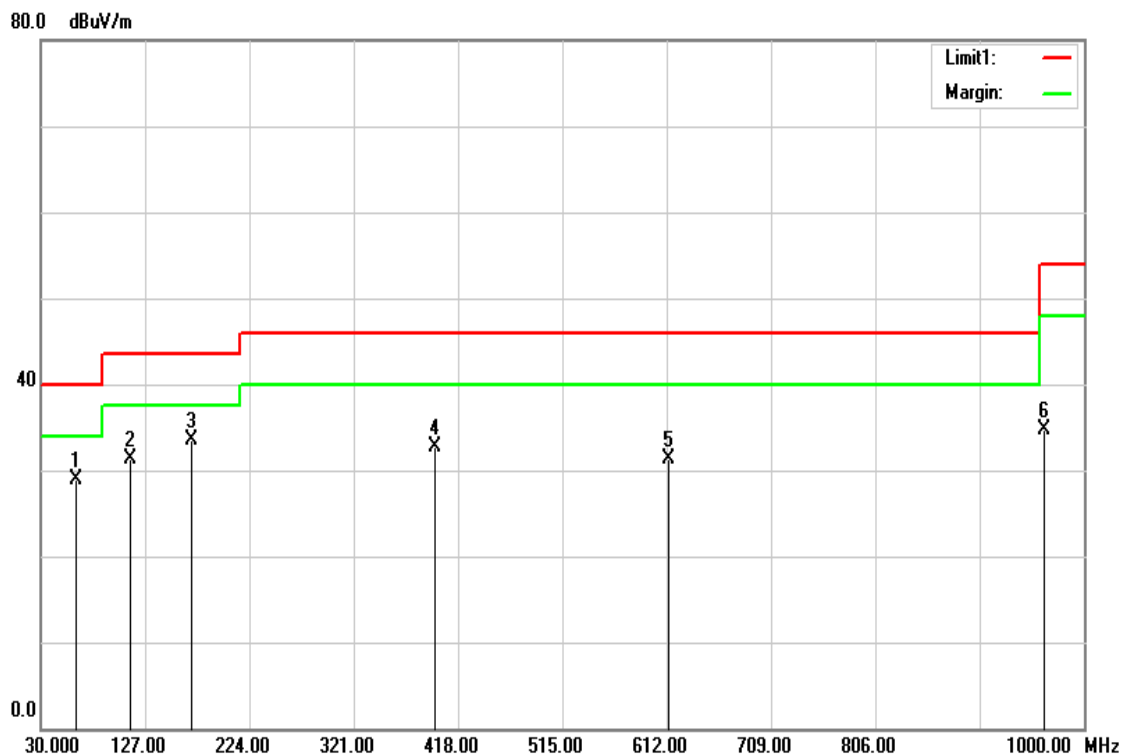

Frequency (MHz)	Reading (dBuV)	Correct Factor (dB/m)	Result (dBuV/m)	Limit (dBuV/m)	Margin (dB)	Remark
62.9800	50.64	-21.70	28.94	40.00	-11.06	peak
113.4200	47.95	-16.66	31.29	43.50	-12.21	peak
169.6800	50.25	-16.83	33.42	43.50	-10.08	peak
396.6600	44.56	-11.78	32.78	46.00	-13.22	peak
613.9400	38.75	-7.43	31.32	46.00	-14.68	peak
963.1400	36.89	-2.18	34.71	54.00	-19.29	peak

Test Mode:	Made 1	Temp/Hum	25(°C)/ 42%RH
Test Item	30MHz-1GHz	Test Date	April 13, 2017
Polarize	Horizontal	Test Engineer	Ed Chiang
Detector	Peak and Qusi-peak	Test Voltage:	120Vac / 60Hz

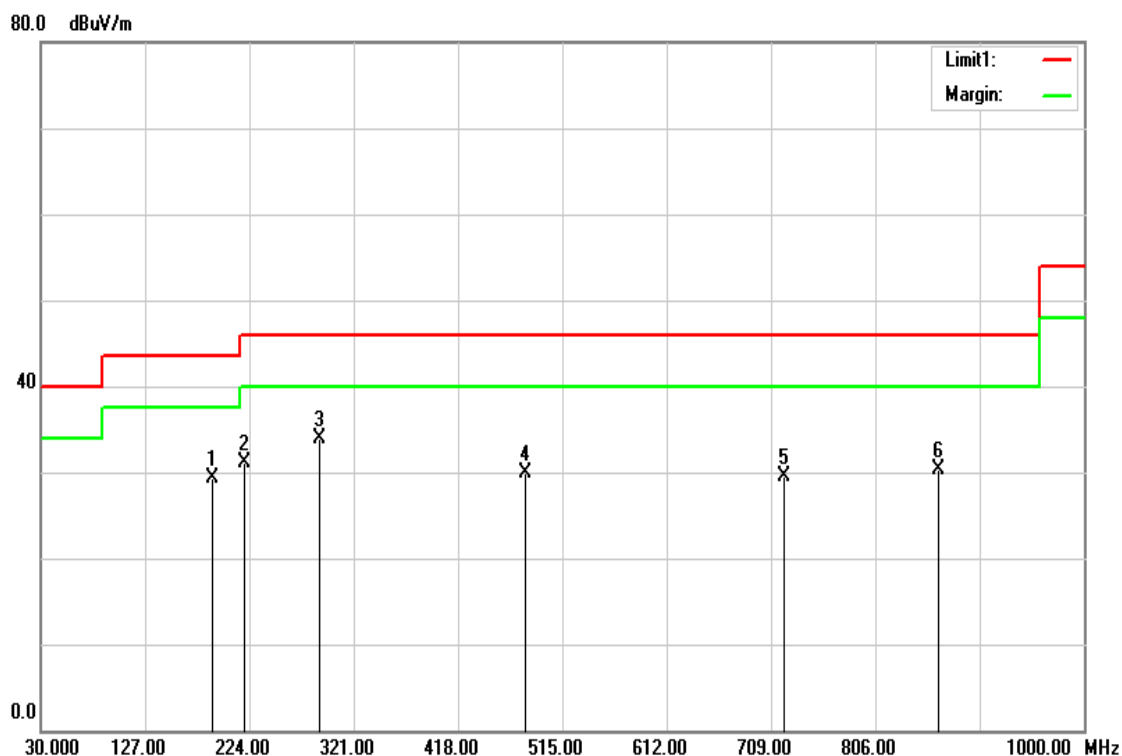

Frequency (MHz)	Reading (dBuV)	Correct Factor (dB/m)	Result (dBuV/m)	Limit (dBuV/m)	Margin (dB)	Remark
189.0800	45.78	-16.53	29.25	43.50	-14.25	peak
219.1500	48.08	-16.90	31.18	46.00	-14.82	peak
288.9900	48.36	-14.45	33.91	46.00	-12.09	peak
481.0500	39.53	-9.60	29.93	46.00	-16.07	peak
721.6100	35.07	-5.57	29.50	46.00	-16.50	peak
864.2000	33.89	-3.61	30.28	46.00	-15.72	peak

APPENDIX-A Test Photo Radiation (Below 1GHz)

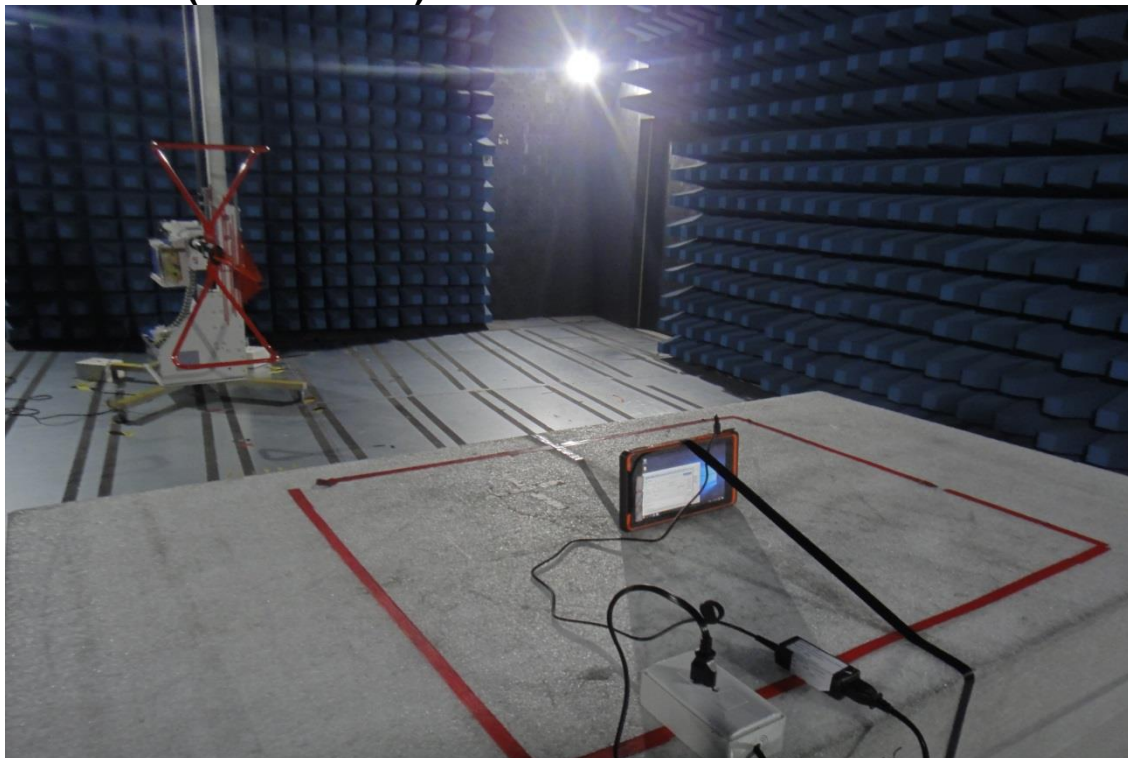

Radiation (Above 1GHz)

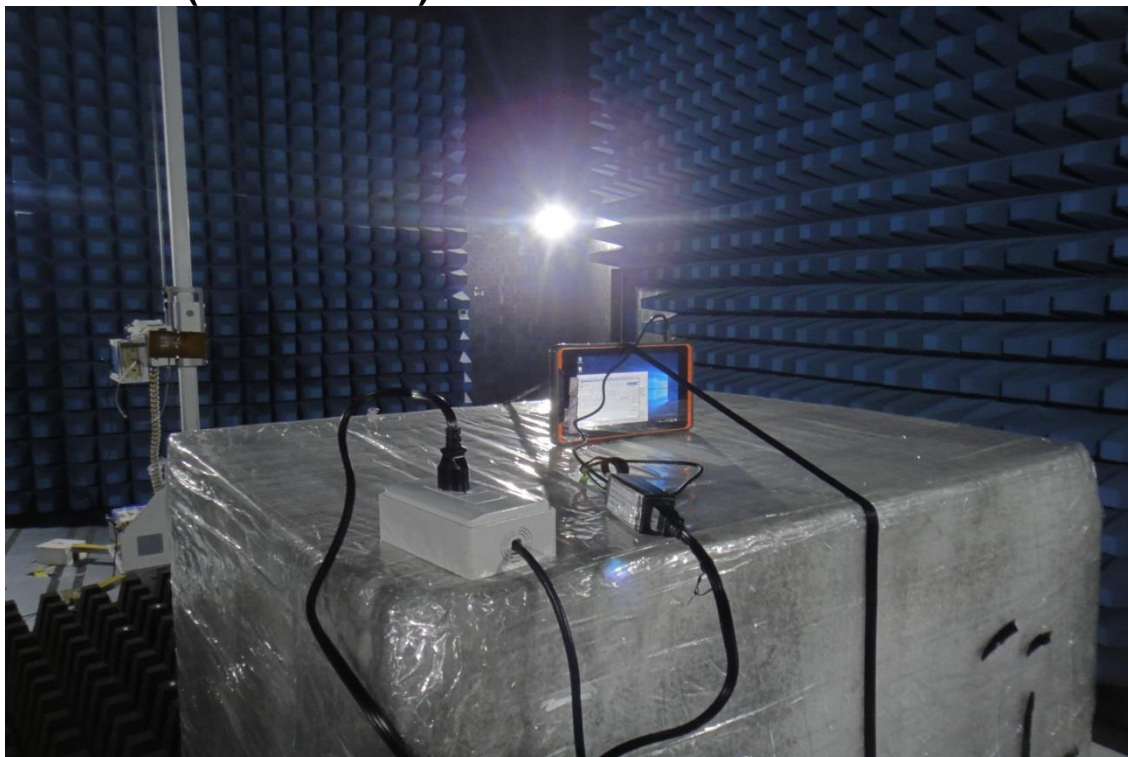

Conduction

