

**FCC 47 CFR PART 15 SUBPART C &
INDUSTRY CANADA RSS-210**

TEST REPORT

For

Computer

**FCC Model No.: AIM8I, AIM8Ixxxxxxxxxxxxxxxxxx,
AIM-x5ATxxxxxxxxxxxxx**

**(where "x" may be any alphanumeric character, "-" or blank for
marketing purpose and no impact safety related critical components
and constructions)**

**IC Model No.: AIM8I, AIM-25AT, AIM-35AT, AIM-55AT, AIM-65AT,
AIM-75AT**

Trade Name: ADVANTECH

Issued to

Advantech Co.Ltd.

**No.1, Alley 20, Lane 26, Rueiguang Road, Neihu District, Taipei 114,
Taiwan, R.O.C.**

Issued by

Compliance Certification Services Inc.

Wugu Laboratory

**No.11, Wugong 6th Rd., Wugu Dist.,
New Taipei City 24891, Taiwan. (R.O.C.)**

<http://www.ccsrf.com>

service@ccsrf.com

Issued Date: June 3, 2017



Note: This report shall not be reproduced except in full, without the written approval of Compliance Certification Services Inc. This document may be altered or revised by Compliance Certification Services Inc. personnel only, and shall be noted in the revision section of the document.

Revision History

Rev.	Issue Date	Revisions	Effect Page	Revised By
00	June 3, 2017	Initial Issue	ALL	Angel Cheng

TABLE OF CONTENTS

1. TEST RESULT CERTIFICATION.....	4
2. EUT DESCRIPTION.....	5
3. TEST METHODOLOGY.....	6
3.1 EUT CONFIGURATION.....	6
3.2 FCC PART 15.205 RESTRICTED BANDS OF OPERATIONS.....	6
3.3 DESCRIPTION OF TEST MODES.....	7
4. INSTRUMENT CALIBRATION.....	8
4.1 MEASURING INSTRUMENT CALIBRATION.....	8
4.2 MEASUREMENT EQUIPMENT USED.....	8
4.3 MEASUREMENT UNCERTAINTY.....	9
5. FACILITIES AND ACCREDITATIONS.....	10
5.1 FACILITIES.....	10
5.2 EQUIPMENT.....	10
5.3 TABLE OF ACCREDITATIONS AND LISTINGS.....	11
6. SETUP OF EQUIPMENT UNDER TEST.....	12
6.1 SETUP CONFIGURATION OF EUT.....	12
6.2 SUPPORT EQUIPMENT.....	12
7. FCC PART 15.225 REQUIREMENTS & RSS-210 REQUIREMENTS.....	13
7.1 OCCUPIED BANDWIDTH(99%) AND 20 DB BANDWIDTH.....	13
7.2 RADIATED EMISSIONS.....	15
7.3 FREQUENCY STABILITY.....	23
7.4 POWERLINE CONDUCTED EMISSIONS.....	25
APPENDIX I PHOTOGRAPHS OF TEST SETUP.....	28
APPENDIX 1 - PHOTOGRAPHS OF EUT	

1. TEST RESULT CERTIFICATION

Applicant: Advantech Co.Ltd.
No.1, Alley 20, Lane 26, Rueiguang Road, Neihu District,
Taipei 114, Taiwan, R.O.C.

Manufacturer: Advantech Co.Ltd.
No.1, Alley 20, Lane 26, Rueiguang Road, Neihu District,
Taipei 114, Taiwan, R.O.C.

Equipment Under Test: Computer

Trade Name: ADVANTECH

FCC Model No.: AIM8I, AIM8Ixxxxxxxxxxxxxxxx, AIM-x5ATxxxxxxxxxxxx
(where "x" may be any alphanumeric character, "-" or blank for
marketing purpose and no impact safety related critical
components and constructions)

IC Model No.: AIM8I, AIM-25AT, AIM-35AT, AIM-55AT, AIM-65AT, AIM-75AT

Date of Test: April 3 ~ June 3, 2017

APPLICABLE STANDARDS	
STANDARD	TEST RESULT
FCC 47 CFR Part 15 Subpart C & RSS-210 Issue 9	No non-compliance noted

We hereby certify that:

The above equipment was tested by Compliance Certification Services Inc. The test data, data evaluation, test procedures, and equipment configurations shown in this report were made in accordance with the procedures given in ANSI C63.10: 2013 and the energy emitted by the sample tested as described in this report is in compliance with the requirements of FCC Rules Part 15.225.

The test results of this report relate only to the tested sample identified in this report.

Approved by:

Tested by:

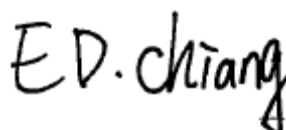
Sam Chuang
Manager
Compliance Certification Services Inc.

Ed Chiang
Engineer
Compliance Certification Services Inc.

2. EUT DESCRIPTION

Product	Computer
FCC Model No.	AIM8I, AIM8Ixxxxxxxxxxxxxxxx, AIM-x5ATxxxxxxxxxxxx (where "x" may be any alphanumeric character, "-" or blank for marketing purpose and no impact safety related critical components and constructions)
IC Model No.	AIM8I, AIM-25AT, AIM-35AT, AIM-55AT, AIM-65AT, AIM-75AT
Model Discrepancy	All models are electrically identical, different model names are for marketing purpose
Trade	ADVANTECH
Received Date	March 28, 2017
Power Supply	1. VDC from Power Adapter Chicony / A16-018N1A I/P: 100-240Vac, 1A, 50-60Hz O/P: 5.15Vdc, 3A, 9.1Vdc, 2A, 18W 2. Battery ADVANTECH / AIM-BAT-8 Rating: 3.8V, 4900, 18.62Wh
Frequency Range	13.56MHz
Modulation Technique	ASK
Number of Channels	1 Channel

Remark:

1. *The sample selected for test was engineering sample that approximated to production product and was provided by manufacturer.*

3. TEST METHODOLOGY

The tests documented in this report were performed in accordance with ANSI C63.10: 2013 and FCC CFR 47 Part 15.207, 15.209, 15.225.

The tests documented in this report were performed in accordance with IC RSS-210, IC RSS-Gen, IC RSS-102, IC RSS-212, and ANSI C63.10

This submittal(s) (test report) is intended for IC Certification with Industry Canada RSS-210..

3.1 EUT CONFIGURATION

The EUT configuration for testing is installed on RF field strength measurement to meet the Commissions requirement and operating in a manner that intends to maximize its emission characteristics in a continuous normal application.

3.2 FCC PART 15.205 RESTRICTED BANDS OF OPERATIONS

(a) Except as shown in paragraph (d) of this section, only spurious emissions are permitted in any of the frequency bands listed below:

MHz	MHz	MHz	GHz
0.090 - 0.110	16.42 - 16.423	399.9 - 410	4.5 - 5.15
¹ 0.495 - 0.505	16.69475 - 16.69525	608 - 614	5.35 - 5.46
2.1735 - 2.1905	16.80425 - 16.80475	960 - 1240	7.25 - 7.75
4.125 - 4.128	25.5 - 25.67	1300 - 1427	8.025 - 8.5
4.17725 - 4.17775	37.5 - 38.25	1435 - 1626.5	9.0 - 9.2
4.20725 - 4.20775	73 - 74.6	1645.5 - 1646.5	9.3 - 9.5
6.215 - 6.218	74.8 - 75.2	1660 - 1710	10.6 - 12.7
6.26775 - 6.26825	108 - 121.94	1718.8 - 1722.2	13.25 - 13.4
6.31175 - 6.31225	123 - 138	2200 - 2300	14.47 - 14.5
8.291 - 8.294	149.9 - 150.05	2310 - 2390	15.35 - 16.2
8.362 - 8.366	156.52475 -	2483.5 - 2500	17.7 - 21.4
8.37625 - 8.38675	156.52525	2655 - 2900	22.01 - 23.12
8.41425 - 8.41475	156.7 - 156.9	3260 - 3267	23.6 - 24.0
12.29 - 12.293	162.0125 - 167.17	3332 - 3339	31.2 - 31.8
12.51975 - 12.52025	167.72 - 173.2	3345.8 - 3358	36.43 - 36.5
12.57675 - 12.57725	240 - 285	3600 - 4400	(²)
13.36 - 13.41	322 - 335.4		

¹ Until February 1, 1999, this restricted band shall be 0.490-0.510 MHz.

² Above 38.6

(b) Except as provided in paragraphs (d) and (e), the field strength of emissions appearing within these frequency bands shall not exceed the limits shown in Section 15.209. At frequencies equal to or less than 1000 MHz, compliance with the limits in Section 15.209 shall be demonstrated using measurement instrumentation employing a CISPR quasi-peak detector. Above 1000 MHz, compliance with the emission limits in Section 15.209 shall be demonstrated based on the average value of the measured emissions. The provisions in Section 15.35 apply to these measurements.

3.3 DESCRIPTION OF TEST MODES

The EUT had been tested under engineering test mode condition and the EUT staying in continuous transmitting mode.

All modes and data rates were investigated and it was determined that ISO 14443A/B and ISO 18092 Type y, 106/212/424/848 kbps.

All data rates were investigated and it was determined that 106 Kbps was considered worst-case. Therefore, all testing was performed in 106 Kbps mode.

3.3.1 The worst mode of measurement

AC Power Line Conducted Emission	
Test Condition	AC Power line conducted emission for line and neutral
Voltage/Hz	120V/60Hz
Test Mode	Mode 1:EUT power by AC adapter via power cable. Mode 2:EUT power by Battery.
Worst Mode	<input checked="" type="checkbox"/> Mode 1 <input type="checkbox"/> Mode 2 <input type="checkbox"/> Mode 3 <input type="checkbox"/> Mode 4

Radiated Emission Measurement	
Test Condition	Band edge, Emission for Unwanted and Fundamental
Voltage/Hz	120V/60Hz
Test Mode	Mode 1:EUT power by AC adapter via power cable. Mode 2:EUT power by Battery.
Worst Mode	<input checked="" type="checkbox"/> Mode 1 <input type="checkbox"/> Mode 2 <input type="checkbox"/> Mode 3 <input type="checkbox"/> Mode 4
Position	<input type="checkbox"/> Placed in fixed position. <input type="checkbox"/> Placed in fixed position at X-Plane (E2-Plane) <input checked="" type="checkbox"/> Placed in fixed position at Y-Plane (E1-Plane) <input type="checkbox"/> Placed in fixed position at Z-Plane (H-Plane)

Radiated Emission Measurement Below 1G	
Test Condition	Radiated Emission Below 1G
Voltage/Hz	120V/60Hz
Test Mode	Mode 1:EUT power by AC adapter via power cable. Mode 2:EUT power by Battery.
Worst Mode	<input checked="" type="checkbox"/> Mode 1 <input type="checkbox"/> Mode 2 <input type="checkbox"/> Mode 3 <input type="checkbox"/> Mode 4

Remark:

1. The worst mode was record in this test report.
2. The EUT pre-scanned in three axis ,X, Y, Z for radiated measurement. The worst cases (Y-Plane) were recorded in this report.
3. AC power line conducted emission and for below 1G radiation emission were performed the EUT transmit at the highest output power channel as worse case.

4. INSTRUMENT CALIBRATION

4.1 MEASURING INSTRUMENT CALIBRATION

The measuring equipment, which was utilized in performing the tests documented herein, has been calibrated in accordance with the manufacturer's recommendations for utilizing calibration equipment, which is traceable to recognized national standards.

4.2 MEASUREMENT EQUIPMENT USED

Equipment Used for Emissions Measurement

Remark: Each piece of equipment is scheduled for calibration once a year

Conducted Emissions Test Site					
Name of Equipment	Manufacturer	Model	S/N	Calibration Date	Calibration Due
Power Meter	Anritsu	ML2495A	1012009	07/04/2016	07/03/2017
Power Sensor	Anritsu	MA2411B	917072	07/04/2016	07/03/2017
Spectrum Analyzer	R&S	FSV 40	101073	100/5/2016	10/04/2017
Power Meter	Anritsu	ML2495A	1012009	07/04/2016	07/03/2017
Power Sensor	Anritsu	MA2411B	917072	07/04/2016	07/03/2017

Wugu 966 Chamber A					
Name of Equipment	Manufacturer	Model	S/N	Calibration Date	Calibration Due
Bilog Antenna	Sunol Sciences	JB3	A030105	07/03/2016	07/02/2017
Horn Antenna	EMCO	3117	00055165	02/20/2017	02/19/2018
Pre-Amplifier	EMCI	EMC 012635	980151	06/23/2016	06/22/2017
Pre-Amplifier	EMEC	EM330	060609	06/08/2016	06/07/2017
Spectrum Analyzer	Agilent	E4446A	US42510252	12/05/2016	12/04/2017
Loop Ant	COM-POWER	AL-130	121051	03/02/2017	03/1/2018
Antenna Tower	CCS	CC-A-1F	N/A	N.C.R	N.C.R
Controller	CCS	CC-C-1F	N/A	N.C.R	N.C.R
Turn Table	CCS	CC-T-1F	N/A	N.C.R	N.C.R
Software	EZ-EMC (CCS-3A1RE)				

AC Conducted Emissions Test Site					
Equipment	Manufacturer	Model	S/N	Cal Date	Cal Due
EMI Test Receiver	R&S	ESCI	101201	08/20/2016	08/19/2017
LISN	Schwarzbeck	NNLK 8129	8129-286	08/19/2016	08/18/2017
LISN(EUT)	Schwarzbeck	NSLK 8127	8127-527	08/19/2016	08/18/2017
Pulse Limiter	R&S	ESH3Z2	C3010026-2	08/21/2016	08/22/2017
Software	EZ-EMC				

Remark:

- Each piece of equipment is scheduled for calibration once a year and Precision Dipole is scheduled for calibration once three years.
- N.C.R. = No Calibration Request.

4.3 MEASUREMENT UNCERTAINTY

PARAMETER	UNCERTAINTY
Powerline Conducted Emission	+/- 1.2159
3M Semi Anechoic Chamber / 30M~200M	+/- 4.0138
3M Semi Anechoic Chamber / 200M~1000M	+/- 3.9483
3M Semi Anechoic Chamber / 1G~8G	+/- 2.5975
3M Semi Anechoic Chamber / 8G~18G	+/- 2.6112
3M Semi Anechoic Chamber / 18G~26G	+/- 2.7389
3M Semi Anechoic Chamber / 26G~40G	+/- 2.9683

Remark: This uncertainty represents an expanded uncertainty expressed at approximately the 95% confidence level using a coverage factor of $k=2$.

5. FACILITIES AND ACCREDITATIONS

5.1 FACILITIES

All measurement facilities used to collect the measurement data are located at

- No.199, Chunghsen Road, Hsintien City, Taipei Hsien, Taiwan, R.O.C.
Tel: 886-2-2217-0894 / Fax: 886-2-2217-1029
- No.11, Wugong 6th Rd., Wugu Dist., New Taipei City 24891, Taiwan. (R.O.C.)
Tel: 886-2-2299-9720 / Fax: 886-2-2298-4045
- No.81-1, Lane 210, Bade 2nd Rd., Lujhu Township, Taoyuan County 33841,
TAIWAN, R.O.C.
Tel: 886-3-324-0332 / Fax: 886-3-324-5235

The sites are constructed in conformance with the requirements of ANSI C63.7, ANSI C63.10: 2013 and CISPR Publication 22.

5.2 EQUIPMENT



Radiated emissions are measured with one or more of the following types of linearly polarized antennas: tuned dipole, bucolical, log periodic, bi-log, and/or ridged waveguide, horn. Spectrum analyzers with pre-selectors and quasi-peak detectors are used to perform radiated measurements.

Conducted emissions are measured with Line Impedance Stabilization Networks and EMI Test Receivers.

Calibrated wideband preamplifiers, coaxial cables, and coaxial attenuators are also used for making measurements.

All receiving equipment conforms to CISPR Publication 16-1, "Radio Interference Measuring Apparatus and Measurement Methods."

5.3 TABLE OF ACCREDITATIONS AND LISTINGS

Country	Agency	Scope of Accreditation	Logo
USA	FCC	3M Semi Anechoic Chamber (FCC MRA: TW1039) to perform FCC Part 15 measurements	 FCC MRA: TW1039
Taiwan	TAF	LP0002, RTTE01, FCC Method-47 CFR Part 15 Subpart C, D, E, RSS-310 IDA TS SRD, AS/NZS 4268, AS/NZS 4771, TS 12.1 & 12.2, ETSI EN 300 440-1, ETSI EN 300 440-2, ETSI EN 300 328, ETSI EN 300 220-1, ETSI EN 300 220-2, ETSI EN 301 893, ETSI EN 301 489-1/3/7/17 FCC OET Bulletin 65 + Supplement C, EN 50360, EN 50361, EN 50371, RSS 102, EN 50383, EN 50385, EN 50392, IEC 62209, CNS 14958-1, CNS 14959 FCC Method -47 CFR Part 15 Subpart B IEC / EN 61000-3-2, IEC / EN 61000-3-3, IEC / EN 61000-4-2/3/4/5/6/8/11	
Canada	Industry Canada	3M Semi Anechoic Chamber (IC 2324G-1 / IC 2324G-2) to perform	 IC 2324G-1 IC 2324G-2

** No part of this report may be used to claim or imply product endorsement by A2LA or any agency of the US Government.*

6. SETUP OF EQUIPMENT UNDER TEST

6.1 SETUP CONFIGURATION OF EUT

See test photographs attached in Appendix I for the actual connections between EUT and support equipment.

6.2 SUPPORT EQUIPMENT

No.	Device Type	Brand	Model	Series No.	FCC ID	Data Cable	Power Cord
	N/A						

Remark:

1. *All the equipment/cables were placed in the worst-case configuration to maximize the emission during the test.*
2. *Grounding was established in accordance with the manufacturer's requirements and conditions for the intended use.*

7. FCC PART 15.225 REQUIREMENTS & RSS-210 REQUIREMENTS

7.1 OCCUPIED BANDWIDTH(99%) AND 20 DB BANDWIDTH TEST CONFIGURATION

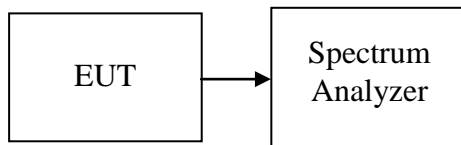

TEST PROCEDURE

1. Place the EUT on the table and set it in the transmitting mode.
2. Remove the antenna from the EUT and then connect a low loss RF cable from the antenna port to the spectrum analyzer.
3. Set the spectrum analyzer as RBW=1kHz, VBW = 3kHz, Span = 10kHz, Sweep = auto.
4. Record the max. reading.

TEST RESULTS

No non-compliance noted

Test Condition	Frequency(MHz)	Occupied Bandwidth 99% (kHz)	20 dB Bandwidth (kHz)
NFC	13.56	2.1128	2.4600

Test Plot

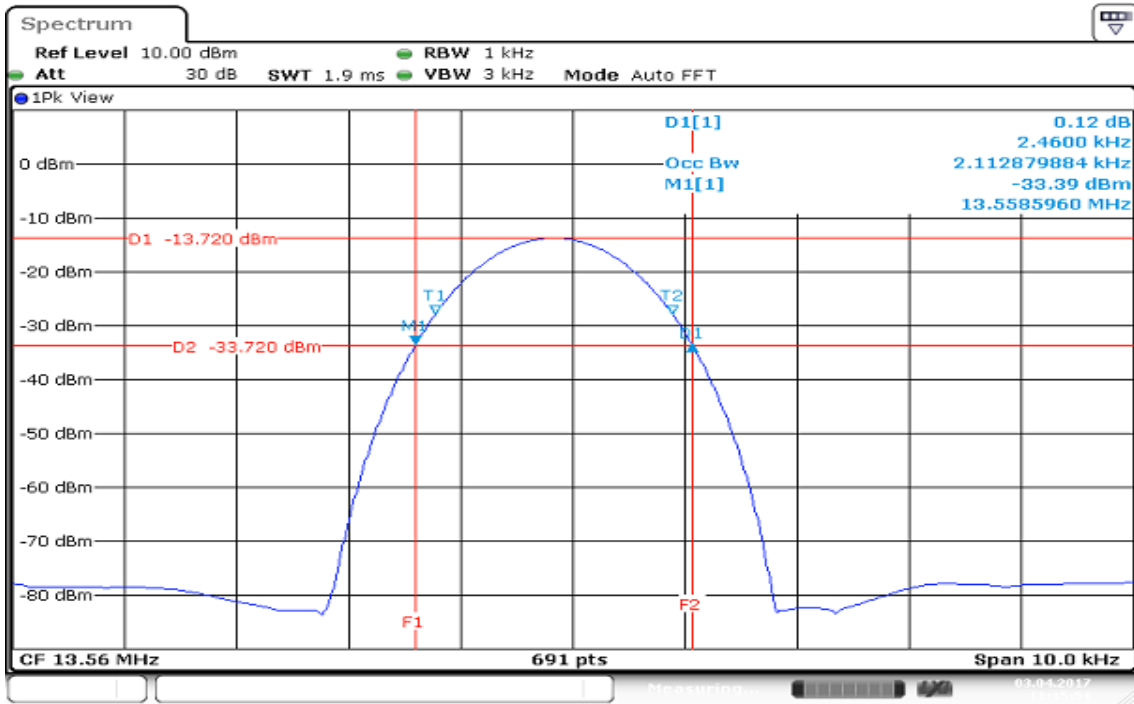

7.2 RADIATED EMISSIONS

LIMIT

According to §15.225

- (a) The field strength of any emissions within the band 13.553 – 13.567 MHz shall not exceed 15,848 microvolts / meter at 30 meters.
- (b) Within the bands 13.410 – 13.553 MHz and 13.567 -13.710 MHz, the field strength of any emissions shall not exceed 334 microvolts / meter at 30 meters.
- (c) Within the bands 13.110 – 13.410 MHz and 13.710 – 14.010 MHz the field strength of any emissions shall not exceed 106 microvolts / meter at 30 meters.
- (d) The field strength of any emissions appearing outside of the 13.110 – 14.010 MHz and shall not exceed the general radiated emission limits in §15.209.

According to §15.225, except as provided elsewhere in this Subpart, the emissions from an intentional radiator shall not exceed the field strength levels specified in the following table:

Frequency (MHz)	Field Strength ($\mu\text{V}/\text{m}$ at meter)	Measurement Distance (meter)
0.009 – 0.490	2400 / F (kHz)	300
0.490 – 1.705	24000 / F (kHz)	30
1.705 – 30.0	30	30
30 - 88	100**	3
88-216	150**	3
216-960	200**	3
Above 960	500	3

** Except as provided in paragraph (g), fundamental emissions from intentional radiators operating under this Section shall not be located in the frequency bands 54-72 MHz, 76-88 MHz, 174-216 MHz or 470-806 MHz. However, operation within these frequency bands is permitted under other sections of this Part, e.g., Sections 15.231 and 15.241.

Test Configuration

9kHz ~ 30MHz

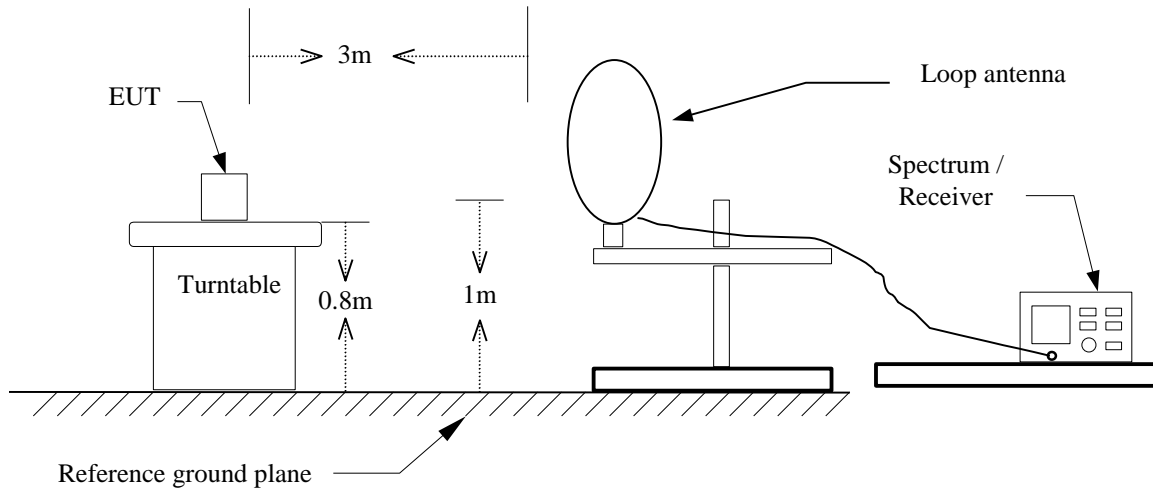

30MHz ~ 1GHz

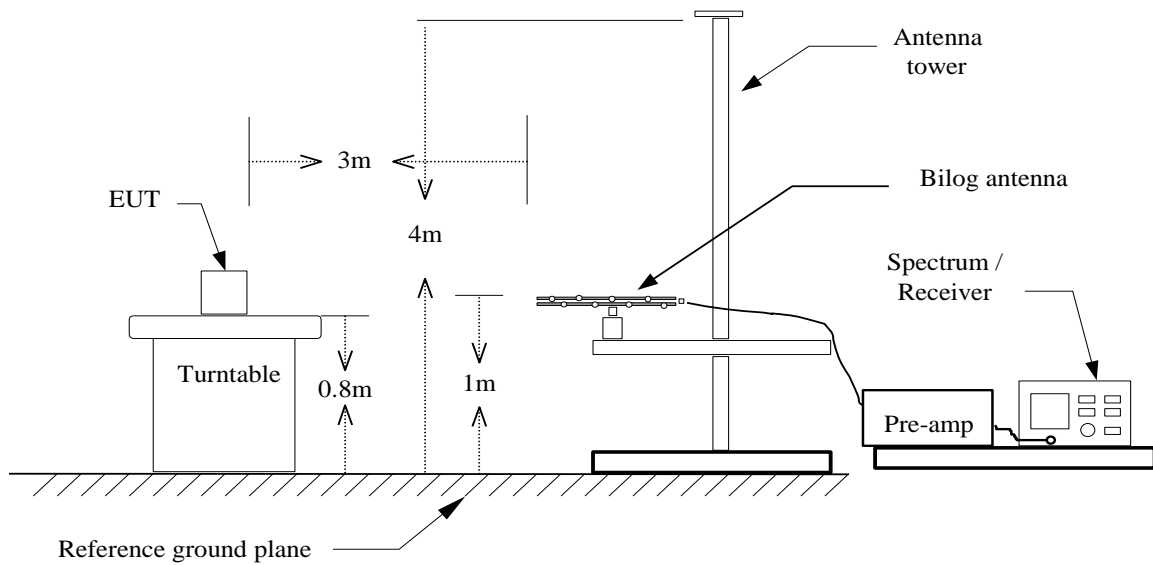

TEST PROCEDURE

For 9kHz ~ 30MHz

1. The EUT is placed on a turntable, which is 0.8m above ground plane.
2. The turntable shall be rotated for 360 degrees to determine the position of maximum emission level.
3. EUT is set 3m away from the receiving antenna, The center of the loop shall be 1 m above the ground then to find out the highest emissions.
4. Maximum procedure was performed on the six highest emissions to ensure EUT compliance.
5. Set the spectrum analyzer in the following setting as:
9KHz-490KHz : RBW=200Hz / VBW=1kHz / Sweep=AUTO
490KHz-30MHz : RBW=10kHz / VBW=30kHz / Sweep=AUTO
6. Repeat above procedures until the measurements for all frequencies are complete.

For 30MHz ~ 1GHz

1. The EUT is placed on a turntable, which is 0.8m above ground plane.
2. The turntable shall be rotated for 360 degrees to determine the position of maximum emission level.
3. EUT is set 3m away from the receiving antenna, which is varied from 1m to find out the highest emissions.
4. Maximum procedure was performed on the six highest emissions to ensure EUT compliance.
5. And also, each emission was to be maximized by changing the polarization of receiving antenna both horizontal and vertical.
6. Set the spectrum analyzer in the following setting as:
RBW=100kHz / VBW=300kHz / Sweep=AUTO
7. Repeat above procedures until the measurements for all frequencies are complete.

Remark :

Although these tests were performed other than open area test site, adequate comparison measurements were confirmed against 30 m open area test site. Therefore sufficient tests were made to demonstrate that the alternative site produces results that correlate with the ones of tests made in an open field based on KDB 937606.

Operation Mode: TX mode **Test Date:** April 5, 2017
Temperature: 27°C **Tested by:** Ed Chiang
Humidity: 53 % RH **Polarity:** Ver. / Hor.



No.	Frequency (MHz)	Reading (dBuV)	Correct Factor(dB/m)	Result (dBuV/m)	Limit (dBuV/m)	Margin (dB)	Remark
1	13.5600	34.90	14.66	49.56	124.00	-74.44	peak

Remark:

1. Radiated emissions measured were made with an instrument using peak/quasi-peak/average detector mode.
2. Measurements above show only up to 6 maximum emissions noted, or would be lesser, with " N/A " remark, if no specific emissions from the EUT are recorded (ie: margin>20dB from the applicable limit) and considered that's already beyond the background noise floor.
3. Margin (dB) = Result (dBuV/m) – Limit (dBuV/m).

9kHz ~ 490kHz

Operation Mode: TX mode
Temperature: 27°C
Humidity: 53 % RH

Test Date: April 5, 2017
Tested by: Ed Chiang

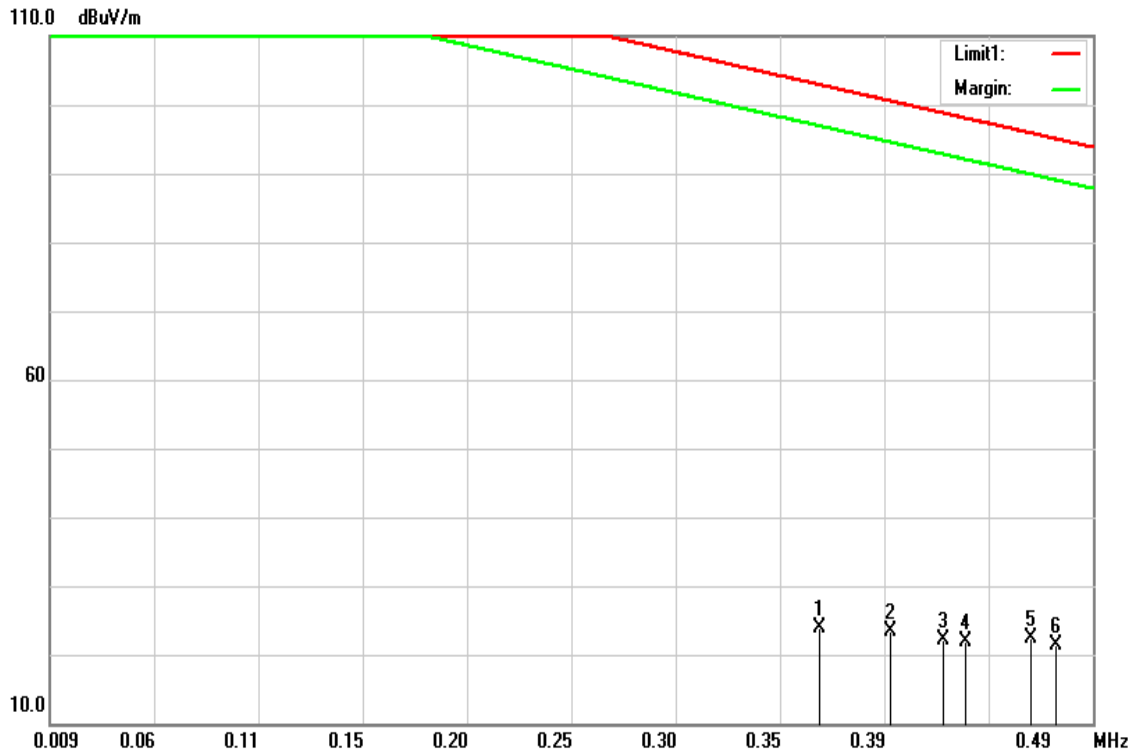

Frequency (MHz)	Reading (dBuV)	Correction Factor (dB/m)	Result (dBuV/m)	Limit (dBuV/m)	Margin (dB)	Detector Mode (PK/QP/AVG)
0.3640	41.27	-17.32	23.95	102.89	-78.94	peak
0.3967	40.78	-17.33	23.45	100.53	-77.08	peak
0.4212	39.37	-17.33	22.04	98.76	-76.72	peak
0.4313	39.12	-17.34	21.78	98.04	-76.26	peak
0.4611	39.70	-17.34	22.36	95.89	-73.53	peak
0.4732	38.64	-17.34	21.30	95.01	-73.71	peak

490kHz ~ 30MHz

Operation Mode: TX mode

Test Date: April 5, 2017

Temperature: 27°C

Tested by: Ed Chiang

Humidity: 53 % RH

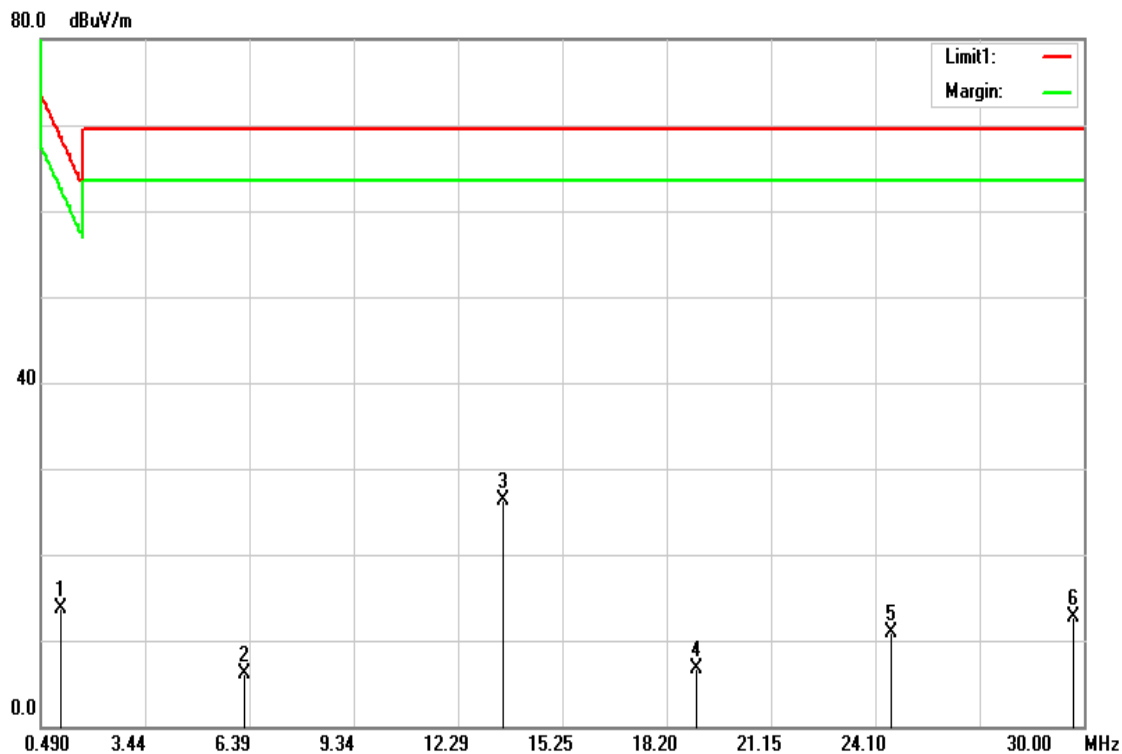

Frequency (MHz)	Reading (dBuV)	Correction Factor (dB/m)	Result (dBuV/m)	Limit (dBuV/m)	Margin (dB)	Detector Mode (PK/QP/AVG)
1.0506	30.84	-17.06	13.78	68.80	-55.02	peak
6.2443	19.66	-13.55	6.11	69.50	-63.39	peak
13.5630	34.67	-8.43	26.24	69.50	-43.26	peak
19.0518	11.57	-4.95	6.62	69.50	-62.88	peak
24.5406	12.67	-1.74	10.93	69.50	-58.57	peak
29.7048	12.51	0.19	12.70	69.50	-56.80	peak

30MHz ~ 1GHz

Operation Mode: TX mode **Test Date:** June 3, 2017
Temperature: 27°C **Tested by:** Ed Chiang
Humidity: 53 % RH

Frequency (MHz)	Reading (dBuV)	Correction Factor (dB/m)	Result (dBuV/m)	Limit 3m (dBuV/m)	Margin (dB)	Detector Mode (PK/QP/AVG)
64.9200	53.75	-21.43	32.32	40.00	-7.68	peak
169.6800	52.00	-16.83	35.17	43.50	-8.33	peak
390.8400	44.68	-11.92	32.76	46.00	-13.24	peak
452.9200	43.07	-10.13	32.94	46.00	-13.06	peak
613.9400	39.98	-7.43	32.55	46.00	-13.45	peak
963.1400	38.57	-2.18	36.39	54.00	-17.61	peak
111.4800	42.68	-17.00	25.68	43.50	-17.82	peak
166.7700	43.88	-16.69	27.19	43.50	-16.31	peak
199.7500	45.85	-15.57	30.28	43.50	-13.22	peak
240.4900	54.19	-16.50	37.69	46.00	-8.31	peak
291.9000	44.74	-14.39	30.35	46.00	-15.65	peak
864.2000	31.00	-3.61	27.39	46.00	-18.61	peak

Vertical

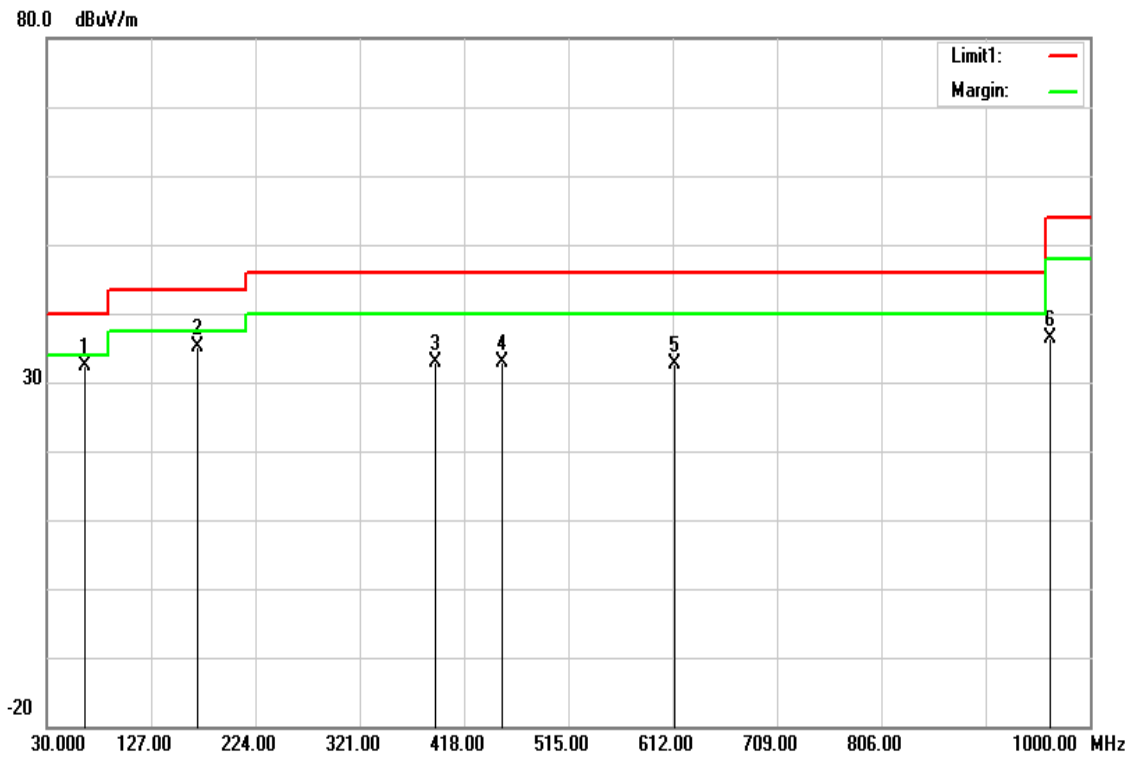

Horizontal

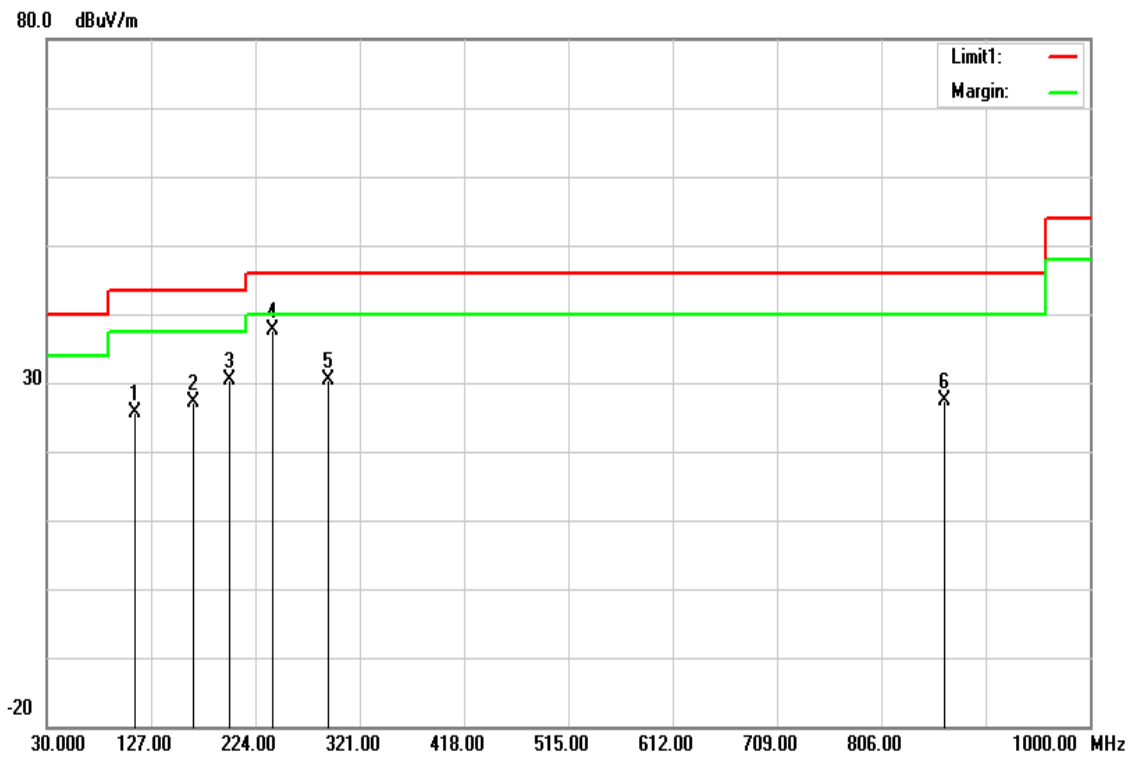

7.3 FREQUENCY STABILITY

LIMIT

According to §15.225(e), the frequency tolerance of the carrier signal shall be maintained within +/- 0.01% of the operating frequency over a temperature variation of -20 degrees to +50 degrees C at normal supply voltage, and for a variation in the primary supply voltage from 85% to 115% of the rated supply voltage at a temperature of 20 degrees C. For battery operated equipment, the equipment tests shall be performed using a new battery.

Test Configuration

Temperature and Voltage Measurement (under normal and extreme test conditions)

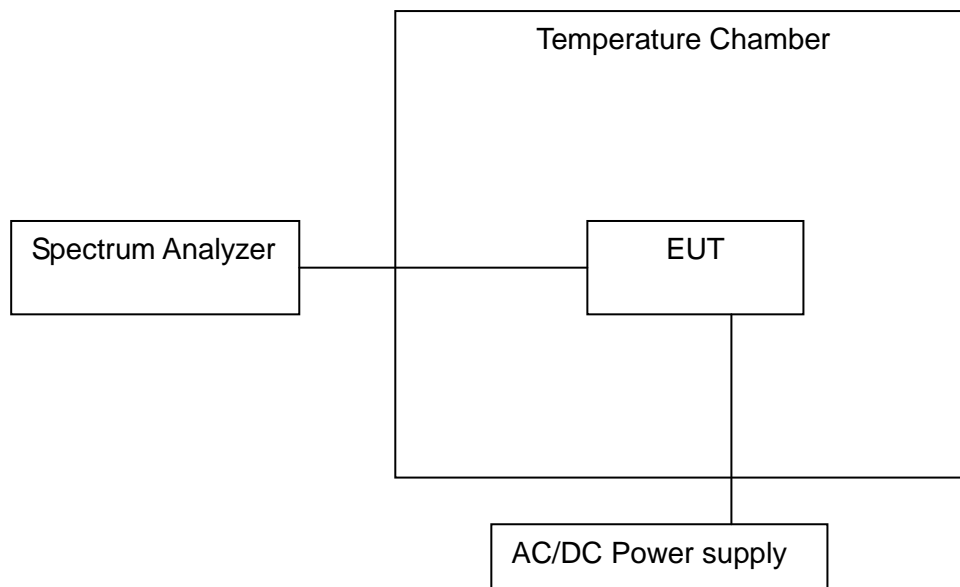

TEST PROCEDURE

1. Turn the EUT off, and place it inside the environmental temperature chamber.
2. Set the temperature control on the chamber to the highest specified in the regulatory requirements for the type of device and allow the oscillator heater and the chamber temperature to stabilize.
3. Set the spectrum analyzer as RBW=1kHz, VBW = RBW, Span = 200kHz, Sweep = auto.
4. Turn the EUT on and record the operating frequency at startup and two, five, and ten minutes after the EUT is energized.
5. Switch off the EUT and Lower the chamber temperature by not more than 10 °C and allow the temperature inside the chamber to stabilize.
6. Mark the peak frequency and measure the frequency tolerance using frequency counter function.
7. Repeat step 4 through step 6 down to the lowest specified temperature.

TEST RESULTS

No non-compliance noted.

TEST DATA

Condition			Frequency Error (ppm)										Limit (ppm)	Result
Temperature	Modulation Mode	Test Freq.	0 min	2 min	5 min	10 min	0 min	2 min	5 min	10 min				
Normal													100	Pass
T _{20°C} V _{max}	CW	13.56	13.559710	13.559710	13.559860	13.559710	-21.39	-21.39	-10.32	-21.39				
T _{20°C} V _{min}	CW	13.56	13.559710	13.559570	13.559570	13.559710	-21.39	-31.71	-31.71	-21.39				
Extreme													100	Pass
T _{50°C} V _{nom}	CW	13.56	13.559570	13.559570	13.559860	13.559710	-31.71	-31.71	-10.32	-21.39				
T _{40°C} V _{nom}	CW	13.56	13.559710	13.559860	13.559570	13.559710	-21.39	-10.32	-31.71	-21.39				
T _{30°C} V _{nom}	CW	13.56	13.559710	13.559860	13.559860	13.559860	-21.39	-10.32	-10.32	-10.32				
T _{20°C} V _{nom}	CW	13.56	13.559860	13.559860	13.559860	13.559710	-10.32	-10.32	-10.32	-21.39				
T _{10°C} V _{nom}	CW	13.56	13.559710	13.559710	13.559860	13.559860	-21.39	-21.39	-10.32	-10.32				
T _{0°C} V _{nom}	CW	13.56	13.559860	13.559710	13.559570	13.559860	-10.32	-21.39	-31.71	-10.32				
T _{-10°C} V _{nom}	CW	13.56	13.559860	13.559860	13.559860	13.559860	-10.32	-10.32	-10.32	-10.32				
T _{-20°C} V _{nom}	CW	13.56	13.559710	13.559710	13.559570	13.559710	-21.39	-21.39	-31.71	-21.39				

Remark: V_{nom}: 24
 V_{max}: 27.6
 V_{min}: 20.4

7.4 POWERLINE CONDUCTED EMISSIONS

LIMIT

According to §15.207(a), for an intentional radiator that is designed to be connected to the public utility (AC) power line, the radio frequency voltage that is conducted back onto the AC power line on any frequency or frequencies within the band 150 kHz to 30 MHz shall not exceed the limits in the following table, as measured using a 50 μ H/50 ohms line impedance stabilization network (LISN). Compliance with the provisions of this paragraph shall be based on the measurement of the radio frequency voltage between each power line and ground at the power terminal. The lower limit applies at the boundary between the frequency ranges.

Frequency Range (MHz)	Limits (dB μ V)	
	Quasi-peak	Average
0.15 to 0.50	66 to 56*	56 to 46*
0.50 to 5	56	46
5 to 30	60	50

* Decreases with the logarithm of the frequency.

TEST PROCEDURE

1. The EUT was placed on a table, which is 0.8m above ground plane.
2. Maximum procedure was performed on the six highest emissions to ensure EUT compliance.
3. Repeat above procedures until all frequency measured were complete.

Test Plots

Conducted emissions (Line 1)

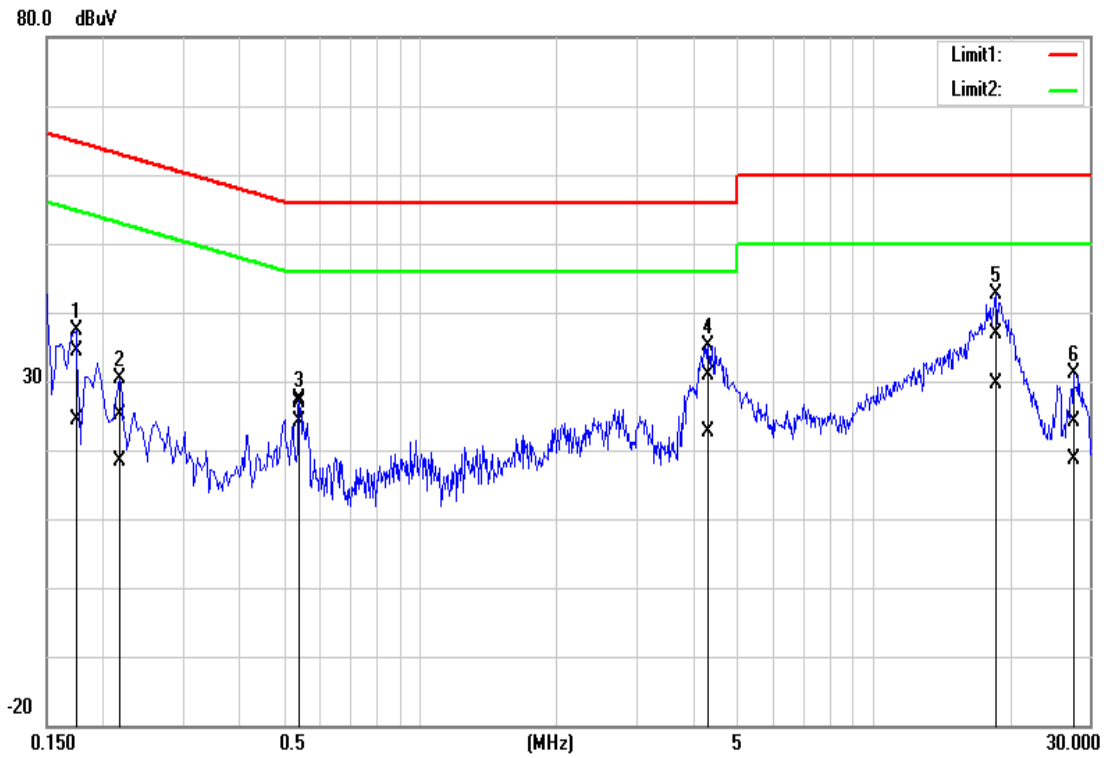

Conducted emissions (Line 2)

