

# FCC DFS Test Report

## FCC: M82-AIM10W

This report concerns (check one): Original Grant Class II Change

**Project No.** : 1710083  
**Equipment** : Computer  
**Test Model** : AIM 10W  
**Series Model** : AIM 10WXXXXXXXXXXXXXXXXXXXX (where X may be any alphanumeric character , blank or "-".)  
**Applicant** : Advantech Co., Ltd.  
**Address** : No.1, Alley 20, Lane 26, Rueiguang Road, Neihu District, Taipei 11491, Taiwan, R.O.C.

**Date of Receipt** : Nov. 13, 2017  
**Date of Test** : Nov. 13, 2017 ~ Mar. 20, 2018  
**Issued Date** : Mar. 20, 2018  
**Tested by** : BTL Inc.

**Testing Engineer** : Kenji Lin  
(Kenji Lin)

**Technical Manager** : James Chiu  
(James Chiu)

**Authorized Signatory** : Andy Chiu  
(Andy Chiu)

# B T L I N C .

No.18, Ln. 171, Sec. 2, Jiuzong Rd.,  
Neihu Dist., Taipei City, Taiwan (R.O.C.)  
TEL:+886-2-2657-3299 FAX: +886-2-2657-3331



**Declaration**

**BTL** represents to the client that testing is done in accordance with standard procedures as applicable and that test instruments used has been calibrated with standards traceable to international standard(s) and/or national standard(s).

**BTL's** reports apply only to the specific samples tested under conditions. It is manufacture's responsibility to ensure that additional production units of this model are manufactured with the identical electrical and mechanical components. **BTL** shall have no liability for any declarations, inferences or generalizations drawn by the client or others from **BTL** issued reports.

**BTL's** report must not be used by the client to claim product certification, approval, or endorsement by NVLAP, NIST, or any agency of the Federal Government.

This report is the confidential property of the client. As a mutual protection to the clients, the public and **BTL-self**, extracts from the test report shall not be reproduced except in full with **BTL's** authorized written approval.

**BTL's** laboratory quality assurance procedures are in compliance with the **ISO Guide 17025** requirements, and accredited by the conformity assessment authorities listed in this test report.

**Limitation**

For the use of the authority's logo is limited unless the Test Standard(s)/Scope(s)/Item(s) mentioned in this test report is (are) included in the conformity assessment authorities acceptance respective.

Table of Contents	Page
<b>1 . CERTIFICATION</b>	<b>5</b>
<b>2 . EUT INFORMATION</b>	<b>6</b>
2.1 EUT SPECIFICATION TABLE	6
<b>3 . U-NII DFS RULE REQUIREMENTS</b>	<b>7</b>
3.1 WORKING MODES AND REQUIRED TEST ITEMS	7
3.2 TEST LIMITS AND RADAR SIGNAL PARAMETERS	8
<b>4 . TEST INSTRUMENTS</b>	<b>12</b>
<b>5 . EMC EMISSION TEST</b>	<b>13</b>
5.1 DFS MEASUREMENT SYSTEM	13
5.2 CALIBRATION OF DFS DETECTION THRESHOLD LEVEL	16
5.3 DEVIATION FROM TEST STANDARD	16
<b>6 . TEST RESULTS</b>	<b>17</b>
6.1 SUMMARY OF TEST RESULT	17
6.2 DELETED TEST RESULTS	18
6.2.1 TEST MODE: DEVICE OPERATING IN MASTER MODE.	18
6.2.2 DFS DETECTION THRESHOLD	18
6.2.3 CHANNEL CLOSING TRANSMISSION AND CHANNEL MOVE TIME WLAN TRAFFIC	19
6.2.4 NON- OCCUPANCY PERIOD	21

### REPORT ISSUED HISTORY

Issued No.	Description	Issued Date
BTL-FCCP-5-1710083	Original Issue.	Mar. 20, 2018

## 1. CERTIFICATION

Equipment : Computer  
Brand Name : ADVANTECH  
Test Model : AIM 10W  
Series Model : AIM 10WXXXXXXXXXXXXXXXXXX (where X may be any alphanumeric character , blank or “-”.)  
Applicant : Advantech Co., Ltd.  
Manufacturer : Advantech Co., Ltd.  
Address : No.1, Alley 20, Lane 26, Rueiguang Road, Neihu District, Taipei 11491, Taiwan, R.O.C.  
Factory : N/A  
Address : N/A  
Date of Test: : Nov. 13, 2017 ~ Feb. 27, 2018  
Test Sample : Production Unit  
Standard(s) : FCC Part 15, Subpart E (Section 15.407)  
FCC KDB 789033 D02 General UNII Test Procedures New Rules v01r02  
905462 D02 UNII DFS Compliance Procedures New Rules v02

The above equipment has been tested and found in compliance with the requirement of the relative standards by BTL Inc.

The test data, data evaluation, and equipment configuration contained in our test report (Ref No. BTL-FCCP-5-1710083) were obtained utilizing the test procedures, test instruments, test sites that has been accredited by the Authority of TAF according to the ISO-17025 quality assessment standard and technical standard(s).

**Test result included in this report is only for the DFS Slave part.**

## 2. EUT INFORMATION

### 2.1 EUT SPECIFICATION TABLE

Table 1: Specification of EUT

<b>Product name</b>	Computer
<b>Brand Name</b>	ADVANTECH
<b>Test Model</b>	AIM 10W
<b>Series Model</b>	AIM 10WXXXXXXXXXXXXXXXXXX (where X may be any alphanumeric character , blank or “-”.)
<b>Operational Mode</b>	Slave
<b>Operating Frequency Range</b>	5250MHz~5350MHz&5470MHz~5725MHz
<b>Modulation</b>	OFDM

**Note:** This device was functioned as a  Master  Slave without radar detection device during the DFS

### 2.2 DESCRIPTION OF AVAILABLE ANTENNAS TO THE EUT

Antenna Specification:

Ant.	Brand	Model	Type	Connector	Frequency Range (MHz)	Gain w/ Cable loss (dBi) (peak)	Gain w/o Cable Loss (dBi) (peak)	Cable Loss (dBi) (peak)
MAIN	INPAQ	IEC 6036B0207601 WA-F-LB-02-113	PIFA	I-pex	2400-2500	0.65	1.32	0.67
					5150-5350	-0.69	0.32	1.01
					5470-5725	-0.16	0.88	1.04
					5725-5850	-0.04	1.05	1.09
AUX	INPAQ	IEC 6036B0207501 WA-F-LB-03-080-	PIFA	I-pex	2400-2500	-1.9	-1.68	0.22
					5150-5350	-0.05	0.28	0.33
					5470-5725	-0.3	0.04	0.34
					5725-5850	0.2	0.56	0.36

Note:

(1) The EUT incorporates a MIMO function. Physically, the EUT provides two completed transmitters and receivers (2T2R) and employs Cyclic Delay Diversity (CDD).

### 3. U-NII DFS RULE REQUIREMENTS

#### 3.1 WORKING MODES AND REQUIRED TEST ITEMS

The manufacturer shall state whether the UUT is capable of operating as a Master and/or a Client. If the UUT is capable of operating in more than one operating mode then each operating mode shall be tested separately. See tables 1 and 2 for the applicability of DFS requirements for each of the operational modes.

Table 2: Applicability of DFS requirements prior to use a channel

Requirement	Operational Mode		
	Master	Client without radar detection	Client with radar detection
Non-Occupancy Period	√	√	√
DFS Detection Threshold	√	Not required	√
Channel Availability Check Time	√	Not required	Not required
Uniform Spreading	√	Not required	Not required
U-NII Detection Bandwidth	√	Not required	√

Table 3: Applicability of DFS requirements during normal operation.

Requirement	Operational Mode		
	Master	Client without radar detection	Client with radar detection
DFS Detection Threshold	√	Not required	√
Channel Closing Transmission Time	√	√	√
Channel Move Time	√	√	√
U-NII Detection Bandwidth	√	Not required	√

### 3.2 TEST LIMITS AND RADAR SIGNAL PARAMETERS

#### DETECTION THRESHOLD VALUES

Table 4: DFS Detection Thresholds for Master Devices and Client Devices With Radar Detection.

Maximum Transmit Power	Value (See Notes 1 and 2)
$\geq 20$ milliwatt	-64 dBm
$< 200$ milliwatt	-62 dBm

Note 1: This is the level at the input of the receiver assuming a 0 dBi receive antenna.

Note 2: Throughout these test procedures an additional 1 dB has been added to the amplitude of the test transmission waveforms to account for variations in measurement equipment. This will ensure that the test signal is at or above the detection threshold level to trigger a DFS response.

Table 5: DFS Response Requirement Values

Parameter	Value
Non-occupancy period	Minimum 30 minutes
Channel Availability Check Time	60 seconds
Channel Move Time	10 seconds See Note 1.
Channel Closing Transmission Time	200 milliseconds + an aggregate of 60 milliseconds over remaining 10 second period. See Notes 1 and 2.
U-NII Detection Bandwidth	Minimum 80% of the UNII 99% transmission power bandwidth. See Note 3.

**Note 1:** The instant that the Channel Move Time and the Channel Closing Transmission Time begins is as follows:

- For the Short Pulse Radar Test Signals this instant is the end of the Burst.
- For the Frequency Hopping radar Test Signal, this instant is the end of the last radar Burst generated.
- For the Long Pulse Radar Test Signal this instant is the end of the 12 second period defining the Radar Waveform.

**Note 2:** The Channel Closing Transmission Time is comprised of 200 milliseconds starting at the beginning of the Channel Move Time plus any additional intermittent control signals required to facilitate a Channel move (an aggregate of 60 milliseconds) during the remainder of the 10 second period. The aggregate duration of control signals will not count quiet periods in between transmissions.

**Note 3:** During the U-NII Detection Bandwidth detection test, radar type 1 is used and for each frequency step the minimum percentage of detection is 90 percent. Measurements are performed with no data traffic.



**PARAMETERS OF DFS TEST SIGNALS**

Step intervals of 0.1 microsecond for Pulse Width, 1 microsecond for PRI, 1 MHz for chirp width and 1 for the number of pulses will be utilized for the random determination of specific test waveforms.

Table 6: Short Pulse Radar Test Waveforms.

Radar Type	Pulse Width (μsec)	PRI (μsec)	Number of Pulses	Minimum Percentage of Successful Detection	Minimum Number of Trials
0	1	1428	18	See Note 1	See Note 1
1	1	Test A: 15 unique PRI values randomly selected from the list of 23 PRI values in Table 5a	Roundup $\left\{ \begin{matrix} \left( \frac{1}{360} \right) \cdot \\ \left( \frac{19 \cdot 10^6}{\text{PRI}_{\mu\text{sec}}} \right) \end{matrix} \right\}$	60%	30
		Test B: 15 unique PRI values randomly selected within the range of 518-3066 μsec, with a minimum increment of 1 μsec, excluding PRI values selected in Test A			
2	1-5	150-230	23-29	60%	30
3	6-10	200-500	16-18	60%	30
4	11-20	200-500	12-16	60%	30
Aggregate (Radar Types 1-4)				80%	120
<p><b>Note 1:</b> Short Pulse Radar Type 0 shall only be used for the channel availability and detection bandwidth tests. It should be noted that any of the radar test waveforms 0 – 4 can be used for the channel availability and detection bandwidth tests.</p>					

Table 7: Long Pulse Radar Test Waveform

Radar Type	Pulse Width (μsec)	Chirp Width (MHz)	PRI (μsec)	Number of Pulses per Burst	Number of Bursts	Minimum Percentage of Successful Detection	Minimum Number of Trials
5	50-100	5-20	1000-2000	1-3	8-20	80%	30

Table 8: Frequency Hopping Radar Test Waveform

Radar Type	Pulse Width (μsec)	Chirp Width (MHz)	PRI (μsec)	Number of Pulses per Burst	Number of Bursts	Minimum Percentage of Successful Detection	Minimum Number of Trials
6	1	333	9	0.333	300	70%	30

Note:

**Table 5a - Pulse Repetition Intervals Values for Test A**

<b>Pulse Repetition Frequency Number</b>	<b>Pulse Repetition Frequency (Pulses Per Second)</b>	<b>Pulse Repetition Interval (Microseconds)</b>
1	1930.5	518
2	1858.7	538
3	1792.1	558
4	1730.1	578
5	1672.2	598
6	1618.1	618
7	1567.4	638
8	1519.8	658
9	1474.9	678
10	1432.7	698
11	1392.8	718
12	1355	738
13	1319.3	758
14	1285.3	778
15	1253.1	798
16	1222.5	818
17	1193.3	838
18	1165.6	858
19	1139	878
20	1113.6	898
21	1089.3	918
22	1066.1	938
23	326.2	3066

#### 4. TEST INSTRUMENTS

Table 9: Test instruments list.

DESCRIPTION	MANUFACTURER	MODEL NO.	Serial No	Calibration Until
Spectrum Analyzer	Keysight	N9010A	MY54200240	Aug. 27, 2018
MXG Vector Signal Generator	Agilent	N5182B	MY51350711	May 29, 2018
10dB Attenuators	Mini-Circuits	VAT-10+	N/A	May 15, 2018
10dB Attenuators	Mini-Circuits	VAT-10+	N/A	May 15, 2018
30dB Attenuators	Mini-Circuits	VAT-30+	N/A	May 15, 2018
30dB Attenuators	Mini-Circuits	VAT-30+	N/A	May 15, 2018
POWER SPLITTER	Mini-Circuits	ZFRSC-123-S+	N/A	May 15, 2018
POWER SPLITTER	Mini-Circuits	ZFRSC-123-S+	N/A	May 15, 2018

Note: Calibration interval of instruments listed above is one year.

## 5. EMC EMISSION TEST

### 5.1 DFS MEASUREMENT SYSTEM

#### Test Procedure

1. Master device and client device are set up by conduction method as the following configuration.
2. The client device is connected to notebook and to access a IP address on wireless connection with the master device.
3. Then the master device is connected to another notebook to access a IP address.
4. Finally, let the two IP addresses run traffic with each other through the Run flow software “Lan test” to reach 17% channel loading as below

#### Setup

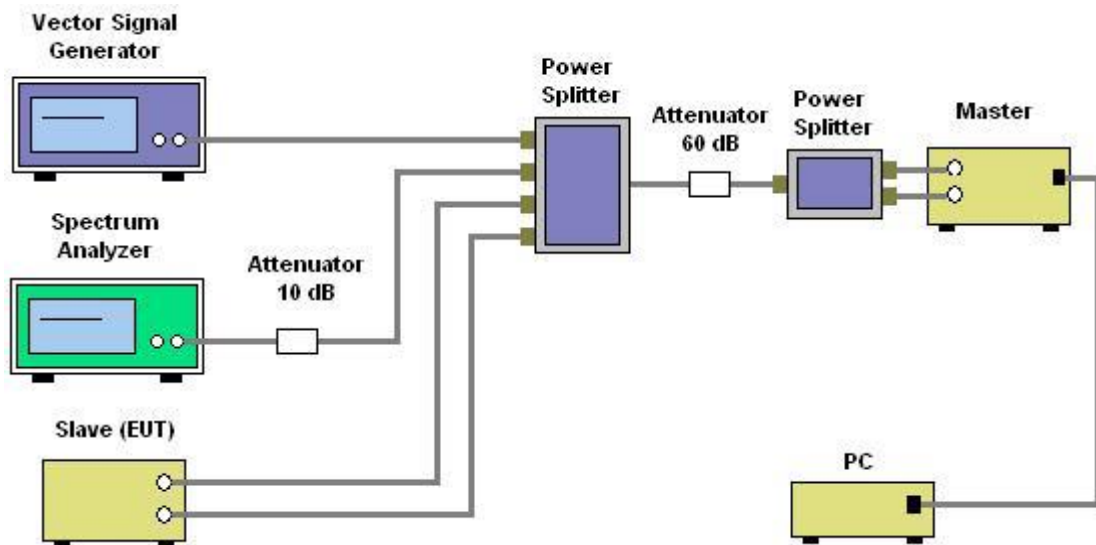

### Channel Loading

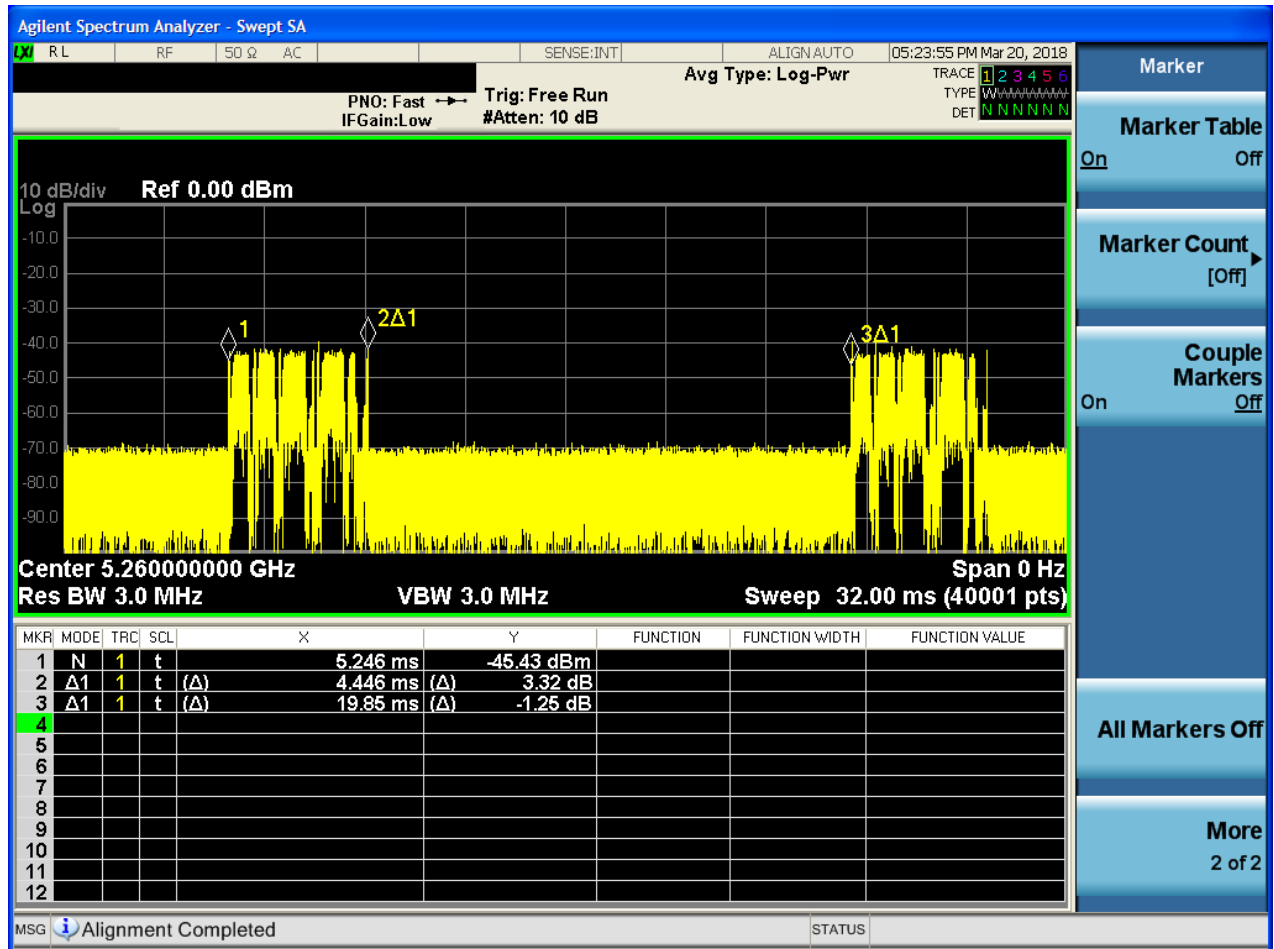

Time on (ms)	Time on+Time off (ms)	Percentage= Time on / (Time on+Time off) (%)
4.446	19.85	22.4%

The hopping type 6 pulse parameters are fixed while the hopping sequence is based on the August 2005 NTIA Hopping Frequency List. The initial starting point randomized at run-time and each subsequent starting point is incremented by 475. Each frequency in the 100-length segment is compared to the boundaries of the EUT Detection Bandwidth and the software creates a hopping burst pattern in accordance with Section 7.4.1.3 Method #2 Simulated Frequency Hopping Radar Waveform Generating Subsystem of FCC 06-96. The frequency of the signal generator is incremented in 1 MHz steps from FL to FH for each successive trial. This incremental sequence is repeated as required to generate a minimum of 30 total trials and to maintain a uniform frequency distribution over the entire Detection Bandwidth.

The signal monitoring equipment consists of a spectrum analyzer set to display 8001 bins on the horizontal axis. The time-domain resolution is 2 msec / bin with a 16 second sweep time, meeting the 10 second short pulse reporting criteria. The aggregate ON time is calculated by multiplying the number of bins above a threshold during a particular observation period by the dwell time per bin, with the analyzer set to peak detection and max hold.

Should multiple RF ports be utilized for the Master and/or Slave devices (for example, for diversity or MIMO implementations), additional combiner/dividers are inserted between the Master Combiner/Divider and the pad connected to the Master Device (and/or between the Slave Combiner/Divider and the pad connected to the Slave Device). Additional pads are utilized such that there is one pad at each RF port on each EUT.

### 5.2 CALIBRATION OF DFS DETECTION THRESHOLD LEVEL

A 50 ohm load is connected in place of the spectrum analyzer, and the spectrum analyzer is connected in place of the master device and the signal generator is set to CW mode. The amplitude of the signal generator is adjusted to yield a level of  $-62$  dBm as measured on the spectrum analyzer.

Without changing any of the instrument settings, the spectrum analyzer is reconnected to the Common port of the Spectrum Analyzer Combiner/Divider. Measure the amplitude and calculate the difference from  $-62$  dBm. Adjust the Reference Level Offset of the spectrum analyzer to this difference.

The spectrum analyzer displays the level of the signal generator as received at the antenna ports of the Master Device. The interference detection threshold may be varied from the calibrated value of  $-62$  dBm and the spectrum analyzer will still indicate the level as received by the Master Device.

Set the signal generator to produce a radar waveform, trigger a burst manually and measure the level on the spectrum analyzer. Readjust the amplitude of the signal generator as required so that the peak level of the waveform is at a displayed level equal to the required or desired interference detection threshold. Separate signal generator amplitude settings are determined as required for each radar type.

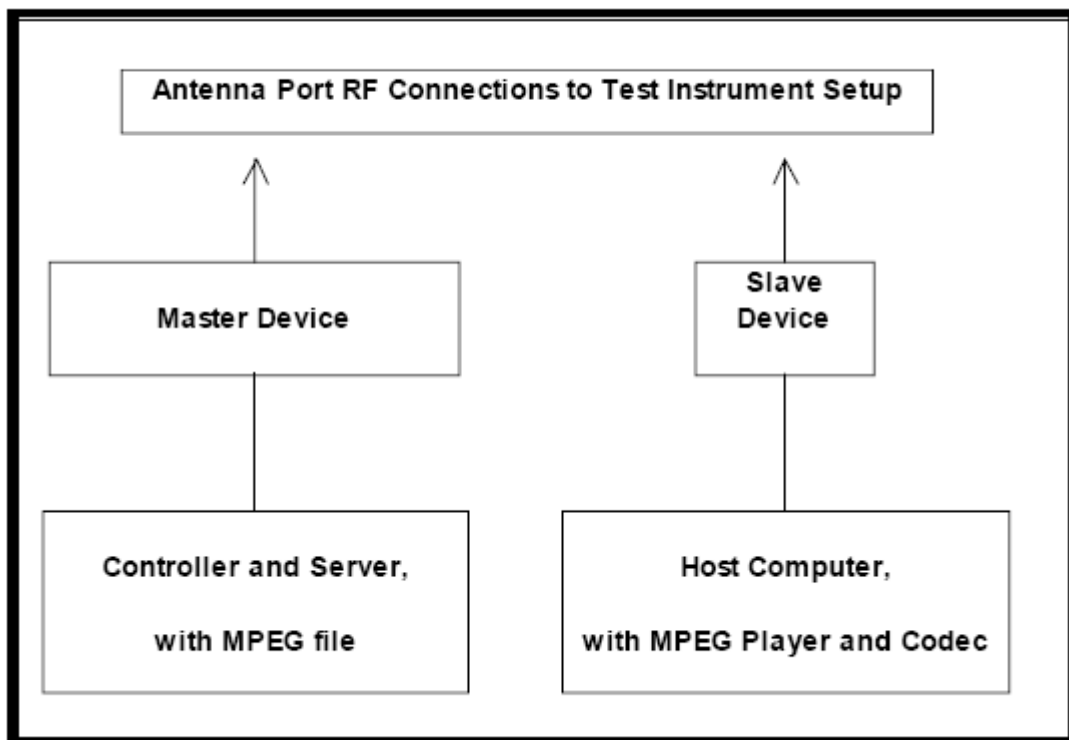

### 5.3 DEVIATION FROM TEST STANDARD

No deviation.



## 6. TEST RESULTS

### 6.1 SUMMARY OF TEST RESULT

Clause	Test Parameter	Remarks	Pass/Fail
15.407	DFS Detection Threshold	No Applicable	N/A
15.407	Channel Availability Check Time	Not Applicable	N/A
15.407	Channel Move Time	Applicable	Pass
15.407	Channel Closing Transmission Time	Applicable	Pass
15.407	Non- Occupancy Period	Applicable	Pass
15.407	Uniform Spreading	Not Applicable	N/A
15.407	U-NII Detection Bandwidth	Not Applicable	N/A

## 6.2 DETELED TEST RESULTS

Clause	Test Parameter	Remarks	Pass/Fail
15.407	DFS Detection Threshold	No Applicable	N/A
15.407	Channel Availability Check Time	Not Applicable	N/A
15.407	Channel Move Time	Applicable	Pass
15.407	Channel Closing Transmission Time	Applicable	Pass
15.407	Non- Occupancy Period	Applicable	Pass
15.407	Uniform Spreading	Not Applicable	N/A
15.407	U-NII Detection Bandwidth	Not Applicable	N/A

### 6.2.1 TEST MODE: DEVICE OPERATING IN MASTER MODE.

The EUT is slave equipment, it need a master device when testing.  
 Master with injection at the Master. (Radar Test Waveforms are injected into the Master)

### 6.2.2 DFS DETECTION THRESHOLD

Calibration:

The EUT is slave equipment and it with a max gain is -0.29 dBi.  
 For a detection threshold level of -64dBm and the master (Brand: Check Point, Model: L-71W, FCC ID: YHI-NW121) antenna gain is 1.99 dBi, required detection threshold is -62.01 dBm (-64+1.99).

Note: Maximum Transmit Power is less than 200 milliwatt in this report, so detection threshold level is -62dBm.

### 6.2.3 CHANNEL CLOSING TRANSMISSION AND CHANNEL MOVE TIME WLAN TRAFFIC

TX (11n 20 MHz Mode )

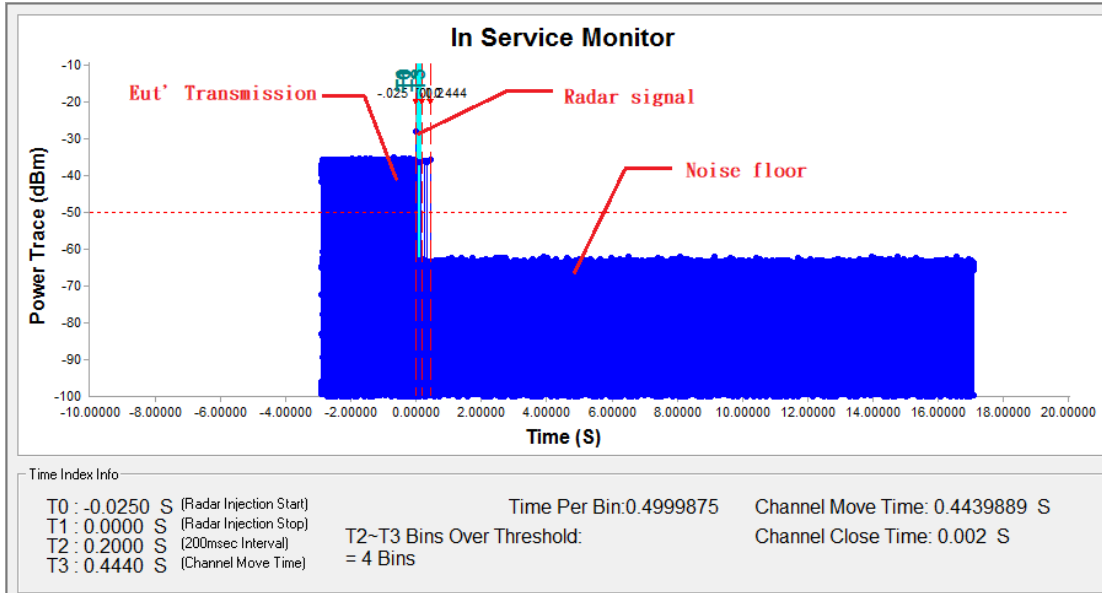

**Note:** T0 denotes the start of Channel Move Time upon the end of the last Radar burst.  
 T1 denotes the data transmission time of 200ms from T0.  
 T2 denotes the end of Channel Move Time.  
 T3 denotes the 0.444 second from T0 to observe the aggregate duration of transmissions.

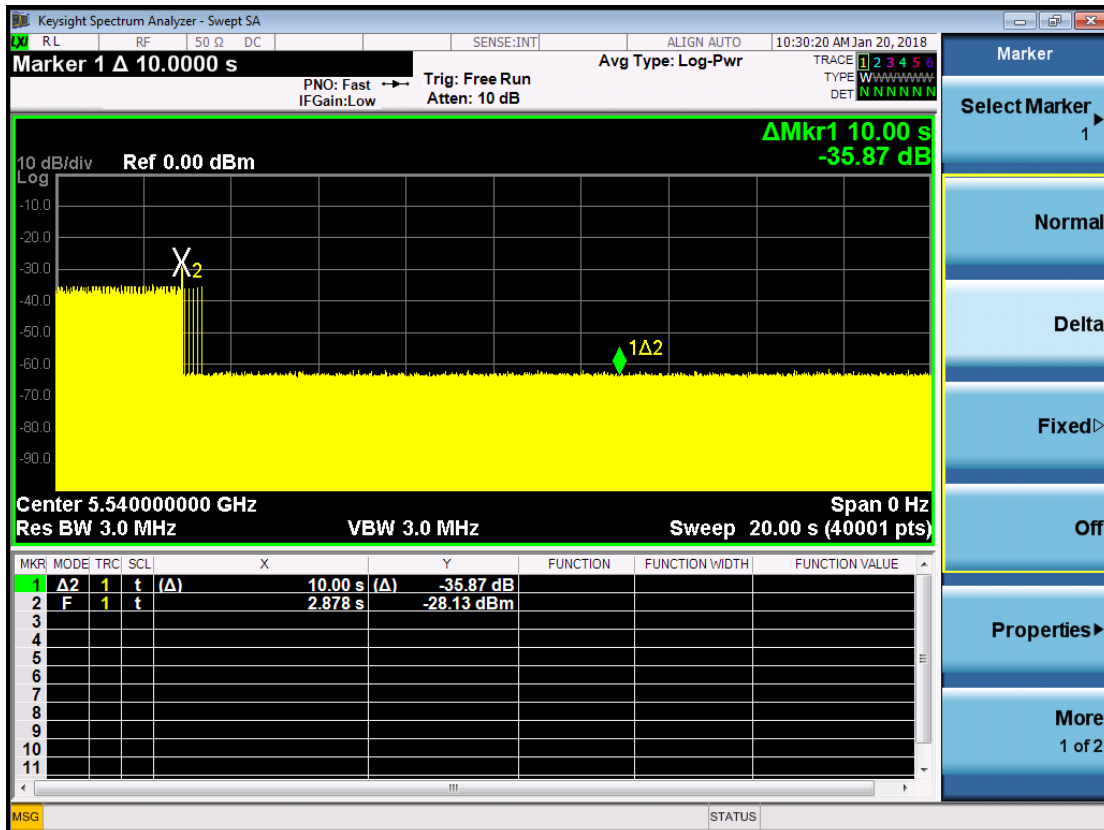

**Note:** An expanded plot for the device vacates the channel in the required 500ms

TX (11ac 80MHz Mode)

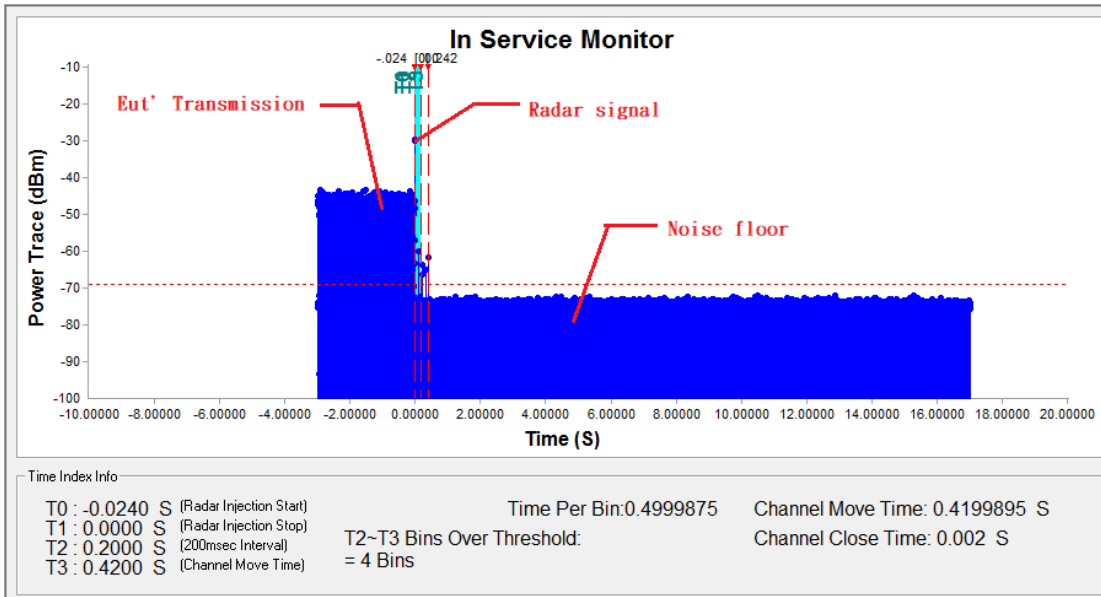

**Note:** T0 denotes the start of Channel Move Time upon the end of the last Radar burst.  
 T1 denotes the data transmission time of 200ms from T0.  
 T2 denotes the end of Channel Move Time.  
 T3 denotes the 0.484 second from T0 to observe the aggregate duration of transmissions.

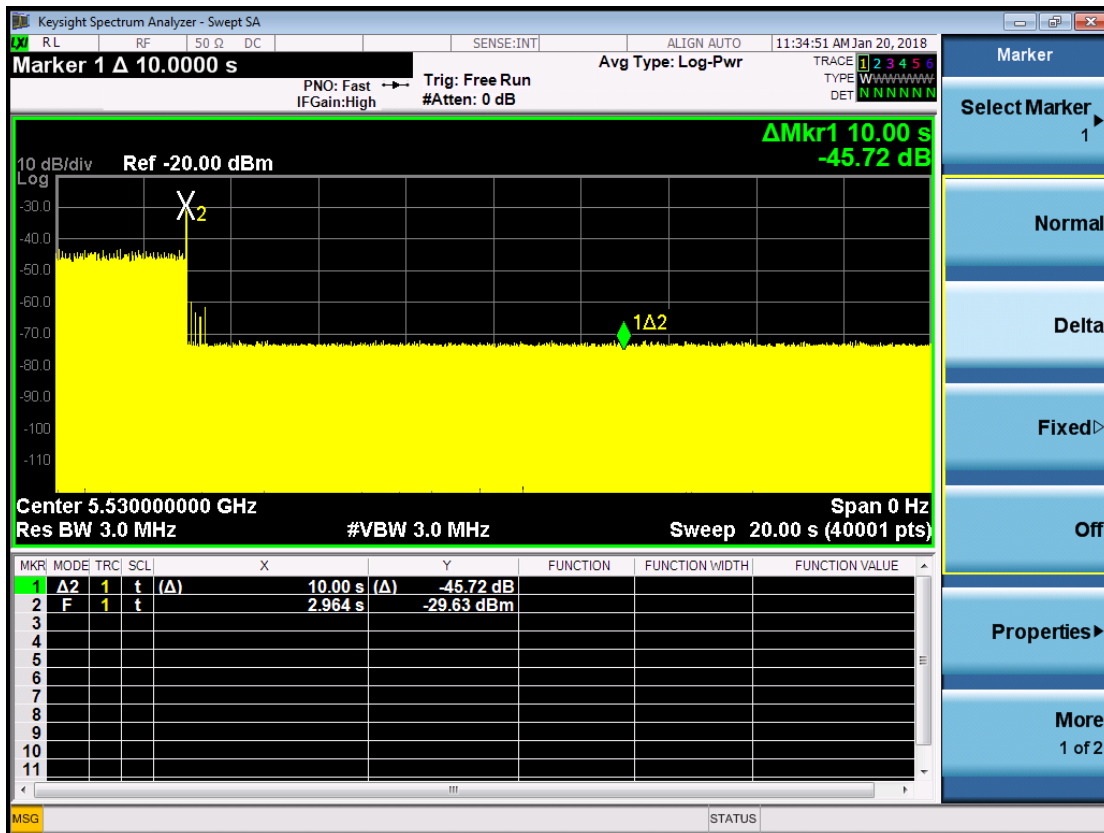

**Note:** An expanded plot for the device vacates the channel in the required 500ms

### 6.2.4 NON- OCCUPANCY PERIOD

During the 30 minutes observation time, UUT did not make any transmissions on a channel after a radar signal was detected on that channel by either the Channel Availability Check or the In-Service Monitoring.

TX (11n 20 MHz Mode)



TX (11ac 80 MHz Mode)

