

FCC/IC TEST REPORT
FOR
Hena Digital Technology (Shenzhen) Co., Ltd.
Netbook
Model No.: CW14Q7C
FCC ID: M7C-CW14Q7
Additional Model No.: Please refer to page 6

Prepared for : Hena Digital Technology (Shenzhen) Co., Ltd.
Address : 3F, South Tower, Jiuzhou Electric Building, Southern No, 12Rd,
High-tech Industrial Park, Nanshan District, Shenzhen, China

Prepared by : Shenzhen LCS Compliance Testing Laboratory Ltd.
Address : 1/F., Xingyuan Industrial Park, Tongda Road, Bao'an Avenue,
Bao'an District, Shenzhen, Guangdong, China

Tel : (+86)755-82591330
Fax : (+86)755-82591332
Web : www.LCS-cert.com
Mail : webmaster@LCS-cert.com

Date of receipt of test sample : March 29, 2017
Number of tested samples : 1
Serial number : Prototype
Date of Test : March 29, 2017~April 25, 2017
Date of Report : April 25, 2017

FCC/IC TEST REPORT

FCC CFR 47 PART 15 C(15.247): 2016 & RSS-247: Issue 1

Report Reference No. : LCS170329108AE

Date of Issue : April 25, 2017

Testing Laboratory Name : Shenzhen LCS Compliance Testing Laboratory Ltd.

Address : 1/F., Xingyuan Industrial Park, Tongda Road, Bao'an Avenue, Bao'an District, Shenzhen, Guangdong, China

Testing Location/ Procedure..... : Full application of Harmonised standards ■
Partial application of Harmonised standards □
Other standard testing method □

Applicant's Name..... : Hena Digital Technology (Shenzhen) Co., Ltd.

Address : 3F, South Tower, Jiuzhou Electric Building, Southern No, 12Rd, High-tech Industrial Park, Nanshan District, Shenzhen, China

Test Specification

Standard..... : FCC CFR 47 PART 15 C(15.247): 2016 & RSS-247: Issue 1

Test Report Form No. : LCSEMC-1.0

TRF Originator : Shenzhen LCS Compliance Testing Laboratory Ltd.

Master TRF : Dated 2011-03

Shenzhen LCS Compliance Testing Laboratory Ltd. All rights reserved.

This publication may be reproduced in whole or in part for non-commercial purposes as long as the Shenzhen LCS Compliance Testing Laboratory Ltd. is acknowledged as copyright owner and source of the material. Shenzhen LCS Compliance Testing Laboratory Ltd. takes no responsibility for and will not assume liability for damages resulting from the reader's interpretation of the reproduced material due to its placement and context.

Test Item Description. : Netbook

Trade Mark..... : HENA, Polaroid, Packard Bell

Model/ Type reference..... : CW14Q7C

Ratings : Input:AC 100~240V, 0.5A, 50/60Hz; Output:DC 5V, 2.5A

Result : Positive

Compiled by:

Kyle Yin

Kyle Yin/ File administrators

Supervised by:

Glin Lu

Glin Lu/ Technique principal

Approved by:

Gavin Liang

Gavin Liang/ Manager

FCC/IC -- TEST REPORT

Test Report No. : LCS170329108AE	April 25, 2017 Date of issue
---	---------------------------------

EUT.....	: Netbook
Type / Model.....	: CW14Q7C
Applicant.....	: Hena Digital Technology (Shenzhen) Co., Ltd.
Address.....	: 3F, South Tower, Jiuzhou Electric Building, Southern No, 12Rd, High-tech Industrial Park, Nanshan District, Shenzhen, China
Telephone.....	: /
Fax.....	: /
Manufacturer.....	: Hena Digital Technology (Shenzhen) Co., Ltd.
Address.....	: 3F, South Tower, Jiuzhou Electric Building, Southern No, 12Rd, High-tech Industrial Park, Nanshan District, Shenzhen, China
Telephone.....	: /
Fax.....	: /
Factory.....	: Hena Digital Technology (Shenzhen) Co., Ltd.
Address.....	: 3F, South Tower, Jiuzhou Electric Building, Southern No, 12Rd, High-tech Industrial Park, Nanshan District, Shenzhen, China
Telephone.....	: /
Fax.....	: /

Test Result	Positive
--------------------	-----------------

The test report merely corresponds to the test sample.
It is not permitted to copy extracts of these test result without the written permission of the test laboratory.

Revision History

Revision	Issue Date	Revisions	Revised By
00	2017-04-25	Initial Issue	Gavin Liang

TABLE OF CONTENTS

Description	Page
1. GENERAL INFORMATION	6
1.1 Description of Device (EUT)	6
1.2. Host System Configuration List and Details	6
1.3. External I/O Cable	6
1.4. Description of Test Facility	6
1.5. Statement of the Measurement Uncertainty	7
1.6. Measurement Uncertainty	7
1.7 Description of Test Modes	8
2. TEST METHODOLOGY	9
2.1 EUT Configuration.....	9
2.2 EUT Exercise	9
2.3 General Test Procedures.....	9
3. SYSTEM TEST CONFIGURATION	10
3.1 Justification.....	10
3.2 EUT Exercise Software	10
3.3 Special Accessories.....	10
3.4 Block Diagram/Schematics.....	10
3.5 Equipment Modifications	10
3.6 Test Setup	10
4. SUMMARY OF TEST RESULTS.....	11
5. SUMMARY OF TEST EQUIPMENT	12
6. ANTENNA PORT MEASUREMENT	13
6.1 Peak Power	13
6.2 Frequency Separation and 20 dB Bandwidth	17
6.3 Number of Hopping Frequency.....	24
6.4 Time of Occupancy (Dwell Time)	26
6.5 Conducted Spurious Emissions and Band Edges Test	30
7. RADIATED MEASUREMENT	37
8. POWER LINE CONDUCTED EMISSIONS	46
9. BAND-EDGE MEASUREMENTS FOR RADIATED EMISSIONS	49
10. ANTENNA REQUIREMENT.....	53
11. TEST SETUP PHOTOGRAPHS OF EUT.....	55
12. EXTERIOR PHOTOGRAPHS OF THE EUT.....	55
13. INTERIOR PHOTOGRAPHS OF THE EUT	55

1. GENERAL INFORMATION

1.1 Description of Device (EUT)

Name of EUT	Netbook
Model Number	CW14Q7C, CW14Q7B, N1400BK
Antenna Gain	2.0dBi (max.) For BT and WLAN
Hardware version	Windows 10
Software version	I5-Z8350LP
WLAN FCC Modulation Type	IEEE 802.11b: DSSS(CCK,DQPSK,DBPSK) IEEE 802.11g: OFDM(64QAM, 16QAM, QPSK, BPSK) IEEE 802.11n HT20: OFDM (64QAM, 16QAM, QPSK,BPSK) IEEE 802.11n HT40: OFDM (64QAM, 16QAM, QPSK,BPSK)
WLAN FCC Operation frequency	IEEE 802.11b:2412-2462MHz IEEE 802.11g:2412-2462MHz IEEE 802.11n HT20:2412-2462MHz IEEE 802.11n HT40:2422-2452MHz
Antenna Type	Integral Antenna
BT Modulation Type	GFSK, $\pi/4$ -DQPSK, 8-DPSK for Bluetooth V3.0(DSS) GFSK for Bluetooth V4.0(DTS)
Extreme temp. Tolerance	-30°C to +50°C
Extreme vol. Limits	3.40VDC to 4.20VDC (nominal: 3.70VDC)

1.2. Host System Configuration List and Details

Manufacturer	Description	Model	Serial Number	Certificate
SHENZHEN TEKA TECHNOLOGY CO., LTD.	Power Adapter	TEKA018-0502500UK	---	FCC VoC

1.3. External I/O Cable

I/O Port Description	Quantity	Cable
USB	2	N/A
Earphone	1	N/A
TF CARD	1	N/A
DC IN	1	N/A
HDMI	1	N/A

1.4. Description of Test Facility

CNAS Registration Number. is L4595.
 FCC Registration Number. is 899208.
 Industry Canada Registration Number. is 9642A-1.
 VCCI Registration Number. is C-4260 and R-3804.
 ESMD Registration Number. is ARCB0108.
 UL Registration Number. is 100571-492.
 TUV SUD Registration Number. is SCN1081.
 TUV RH Registration Number. is UA 50296516-001

The 3m-Semi anechoic test site fulfils CISPR 16-1-4 according to ANSI C63.4:2014 and CISPR 16-1-4:2010 SVSWR requirement for radiated emission above 1GHz.

1.5. Statement of the Measurement Uncertainty

The data and results referenced in this document are true and accurate. The reader is cautioned that there may be errors within the calibration limits of the equipment and facilities. The measurement uncertainty was calculated for all measurements listed in this test report acc. To CISPR 16 – 4 “Specification for radio disturbance and immunity measuring apparatus and methods – Part 4: Uncertainty in EMC Measurements” and is documented in the LCS quality system acc. To DIN EN ISO/IEC 17025. Furthermore, component and process variability of devices similar to that tested may result in additional deviation. The manufacturer has the sole responsibility of continued compliance of the device.

1.6. Measurement Uncertainty

Test Item	Frequency Range	Uncertainty	Note
Radiation Uncertainty	9KHz~30MHz	±3.10dB	(1)
	30MHz~200MHz	±2.96dB	(1)
	200MHz~1000MHz	±3.10dB	(1)
	1GHz~26.5GHz	±3.80dB	(1)
	26.5GHz~40GHz	±3.90dB	(1)
Conduction Uncertainty	150kHz~30MHz	±1.63dB	(1)
Power disturbance	30MHz~300MHz	±1.60dB	(1)

(1). This uncertainty represents an expanded uncertainty expressed at approximately the 95% confidence level using a coverage factor of k=2.

1.7 Description of Test Modes

Bluetooth operates in the unlicensed ISM Band at 2.4GHz. With basic data rate feature, the data rates can be up to 1 Mb/s by modulating the RF carrier using GFSK techniques. The EUT works in the X-axis, Y-axis, Z-axis. The following operating modes were applied for the related test items. All test modes were tested, only the result of the worst case was recorded in the report.

Mode of Operations	Frequency Range (MHz)	Data Rate (Mbps)
BT V 3.0	2402	1/2/3
	2441	1/2/3
	2480	1/2/3
For Conducted Emission		
Test Mode		TX Mode
For Radiated Emission		
Test Mode		TX Mode

Worst-case mode and channel used for 150 KHz-30 MHz power line conducted emissions was the mode and channel with the highest output power that was determined to be TX (1Mbps).

Worst-case mode and channel used for 9kHz-1000 MHz radiated emissions was the mode and channel with the highest output power, that was determined to be TX(1Mbps-Low Channel).

AC conducted emission pre-test at both at AC 120V/60Hz and AC 240V/50Hz modes, recorded worst case;

AC conducted emission pre-test at both at power adapter and power from PC modes, recorded worst case;

2. TEST METHODOLOGY

The tests documented in this report were performed in accordance with ANSI C63.10-2013, FCC CFR PART 15C 15.207, 15.209, 15.247, DA 00-705 and RSS-247.

2.1 EUT Configuration

The EUT configuration for testing is installed on RF field strength measurement to meet the Commissions requirement and operating in a manner that intends to maximize its emission characteristics in a continuous normal application.

2.2 EUT Exercise

The EUT was operated in the normal operating mode for Hopping Numbers and Dwell Time test and a continuous transmits mode for other tests.

According to its specifications, the EUT must comply with the requirements of the Section 15.207, 15.209, 15.247 under the FCC Rules Part 15 Subpart C.

2.3 General Test Procedures

2.3.1 Conducted Emissions

The EUT is directly placed on the ground. According to the requirements in Section 6.2.1 of ANSI C63.10-2013 Conducted emissions from the EUT measured in the frequency range between 0.15 MHz and 30MHz using Quasi-peak and average detector modes.

2.3.2 Radiated Emissions

The EUT is placed on a turntable, which is directly placed on the ground. The turntable shall rotate 360 degrees to determine the position of maximum emission level. EUT is set 3m away from the receiving antenna, which varied from 1m to 4m to find out the highest emission. And also, each emission was to be maximized by changing the polarization of receiving antenna both horizontal and vertical. In order to find out the maximum emissions, exploratory radiated emission measurements were made according to the requirements in Section 6.3 of ANSI C63.10-2013

2.4. Test Sample

The application provides 2 samples to meet requirement;

Sample Number	Description
Sample 1	Engineer sample – continuous transmit
Sample 2	Normal sample – Intermittent transmit

3. SYSTEM TEST CONFIGURATION

3.1 Justification

The system was configured for testing in a continuous transmits condition.

3.2 EUT Exercise Software

The sample will control by special test software (RF Test Tool) to control sample change channel, modulation provided by application;

3.3 Special Accessories

No.	Equipment	Manufacturer	Model No.	Serial No.	Length	shielded/ unshielded	Notes
1	PC	Lenovo	Ideapad	A13110155 0	/	/	DOC
2	Power adapter	Lenovo	CPA-A090	36200414	1.00m	unshielded	DOC

3.4 Block Diagram/Schematics

Please refer to the related document.

3.5 Equipment Modifications

Shenzhen LCS Compliance Testing Laboratory Ltd. has not done any modification on the EUT.

3.6 Test Setup

Please refer to the test setup photo.

4. SUMMARY OF TEST RESULTS

Applied Standard: FCC Part 15 Subpart C & RSS-247 / RSS-Gen			
FCC Rules	Description of Test	Test Sample	Result
§15.247(b)(1) & RSS-247§5.4 (2)	Maximum Conducted Output Power	Sample 1	Compliant
§15.247(c) & RSS-247§5.1 (2)	Frequency Separation And 20 dB Bandwidth	Sample 1	Compliant
§15.247(a)(1)(ii) & RSS-247§5.1 (4)	Number Of Hopping Frequency	Sample 2	Compliant
§15.247(a)(1)(iii) & RSS-247§5.1 (4)	Time Of Occupancy (Dwell Time)	Sample 2	Compliant
§15.209, §15.205 & RSS-247§5.5, RSS-Gen	Conducted Spurious Emissions and Band Edges Test	Sample 1	Compliant
§15.209, §15.247(d) & RSS-247§5.5, RSS-Gen	Radiated and Conducted Spurious Emissions	Sample 1	Compliant
§15.205 & RSS-Gen	Emissions at Restricted Band	Sample 1	Compliant
§15.207(a) & RSS-Gen	Conducted Emissions	Sample 1	Compliant
§15.203 & RSS-Gen	Antenna Requirements	Sample 1	Compliant
§15.247(i)§2.1093 & RSS-102	RF Exposure	N/A	Compliant

5. SUMMARY OF TEST EQUIPMENT

Item	Equipment	Manufacturer	Model No.	Serial No.	Last Cal.	Next Cal.
1	Power Sensor	R&S	NRV-Z51	100458	2016-06-18	2017-06-17
2	Power Sensor	R&S	NRV-Z32	10057	2016-06-18	2017-06-17
3	Power Meter	R&S	NRVS	100444	2016-06-18	2017-06-17
4	DC Filter	MPE	23872C	N/A	2016-06-18	2017-06-17
5	RF Cable	Harbour Industries	1452	N/A	2016-06-18	2017-06-17
6	SMA Connector	Harbour Industries	9625	N/A	2016-06-18	2017-06-17
7	Spectrum Analyzer	Agilent	N9020A	MY50510140	2016-10-27	2017-10-26
8	Signal analyzer	Agilent	E4448A(External mixers to 40GHz)	US44300469	2016-06-16	2017-06-15
9	RF Cable	Hubersuhne	Sucoflex104	FP2RX2	2016-06-18	2017-06-17
10	3m Semi Anechoic Chamber	SIDT FRANKONIA	SAC-3M	03CH03-HY	2016-06-18	2017-06-17
11	Amplifier	SCHAFFNER	COA9231A	18667	2016-06-18	2017-06-17
12	Amplifier	Agilent	8449B	3008A02120	2016-06-16	2017-06-15
13	Amplifier	MITEQ	AMF-6F-260400	9121372	2016-06-16	2017-06-15
14	Loop Antenna	R&S	HFH2-Z2	860004/001	2016-06-18	2017-06-17
15	By-log Antenna	SCHWARZBECK	VULB9163	9163-470	2016-06-10	2017-06-09
16	Horn Antenna	EMCO	3115	6741	2016-06-10	2017-06-09
17	Horn Antenna	SCHWARZBECK	BBHA9170	BBHA9170154	2016-06-10	2017-06-09
18	RF Cable-R03m	Jye Bao	RG142	CB021	2016-06-18	2017-06-17
19	RF Cable-HIGH	SUHNER	SUCOFLEX 106	03CH03-HY	2016-06-18	2017-06-17
20	EMI Test Receiver	R&S	ESCI	101142	2016-06-18	2017-06-17
21	Artificial Mains	R&S	ENV216	101288	2016-06-18	2017-06-17
22	EMI Test Software	AUDIX	E3	N/A	2016-06-18	2017-06-17

6. ANTENNA PORT MEASUREMENT

6.1 Peak Power

6.1.1 Block Diagram of Test Setup

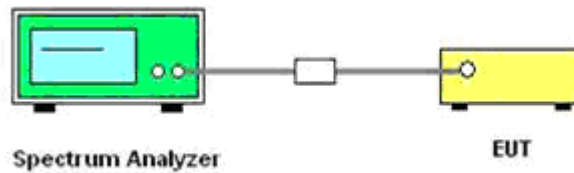

6.1.2 Limit

According to §15.247(b)(1), For frequency hopping systems operating in the 2400–2483.5 MHz band employing at least 75 non-overlapping hopping channels, and all frequency hopping systems in the 5725–5850 MHz band: 1 watt. For all other frequency hopping systems in the 2400–2483.5 MHz band: 0.125 watts.

According to RSS-247§5.4(2), For FHSs operating in the band 2400-2483.5 MHz, the maximum peak conducted output power shall not exceed 1.0 W and the e.i.r.p. shall not exceed 4 W if the hopset uses 75 or more hopping channels; the maximum peak conducted output power shall not exceed 0.125 W and the e.i.r.p. shall not exceed 0.5 W if the hopset uses less than 75 hopping channels.

6.1.3 Test Procedure

Use the following spectrum analyzer settings:

Span = approximately 5 times the 20 dB bandwidth, centered on a hopping channel

RBW > the 20 dB bandwidth of the emission being measured

VBW \geq RBW

Sweep = auto

Detector function = peak

Trace = max hold

Allow the trace to stabilize. Use the marker-to-peak function to set the marker to the peak of the emission. The indicated level is the peak output power

6.1.4 Test Results

Test Mode	Channel	Frequency (MHz)	Measured Maximum Power (dBm)	Limits (dBm)	Verdict
GFSK	0	2402	0.984	21.00	PASS
	39	2441	1.343		
	78	2480	1.439		
$\pi/4$ -DQPSK	0	2402	2.593	21.00	PASS
	39	2441	2.904		
	78	2480	3.022		
8-DPSK	0	2402	2.872	21.00	PASS
	39	2441	3.172		
	78	2480	3.273		

Remark:

1. Test results including cable loss;
2. Measured output power at difference Packet Type for each mode and recorded worst case for each mode.
3. Worst case data at DH1 for GFSK, 2DH1 for $\pi/4$ -DQPSK, 3DH1 for 8-DPSK modulation type;

Peak Output Power

GFSK

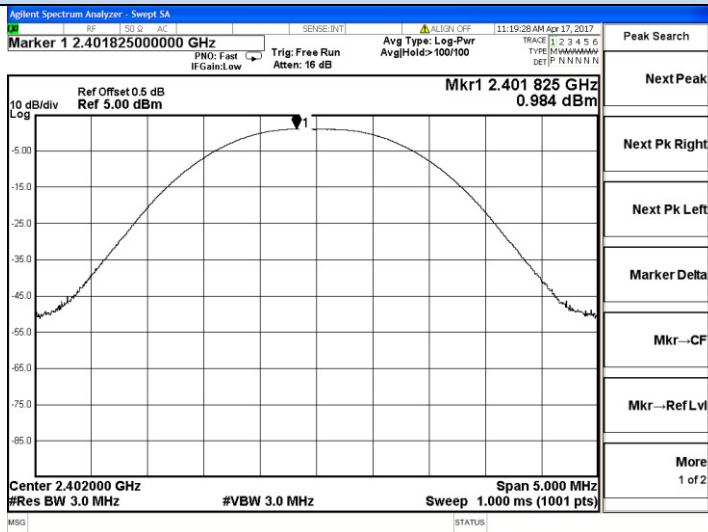

$\pi/4$ -DQPSK

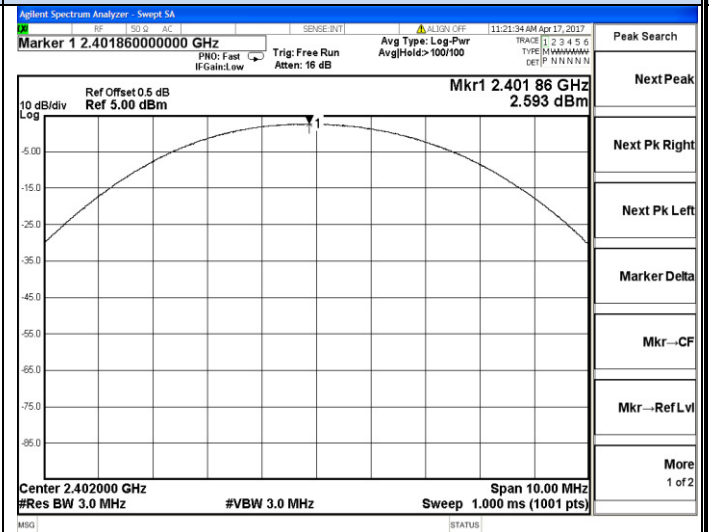

Channel 0 / 2402 MHz

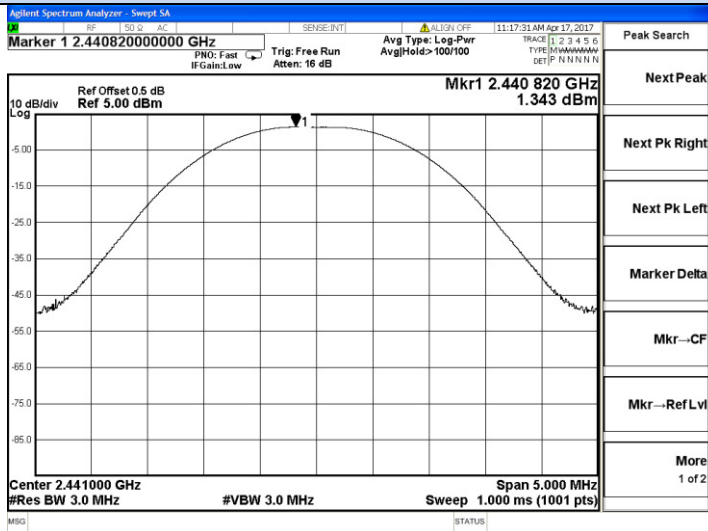

Channel 0 / 2402 MHz

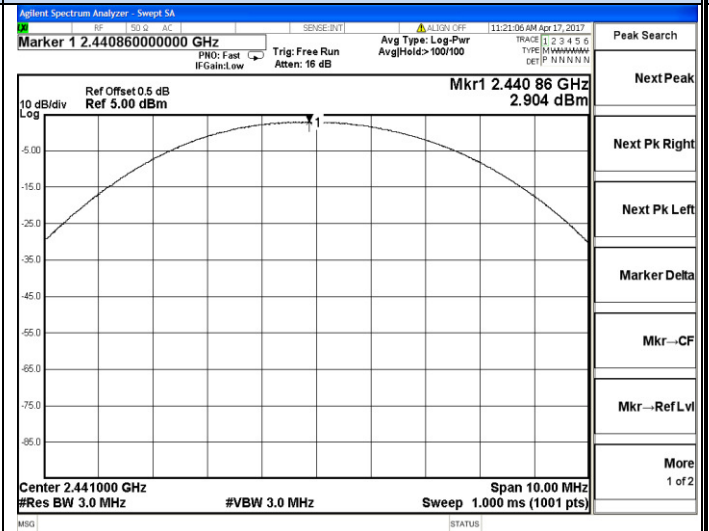

Channel 39 / 2441 MHz

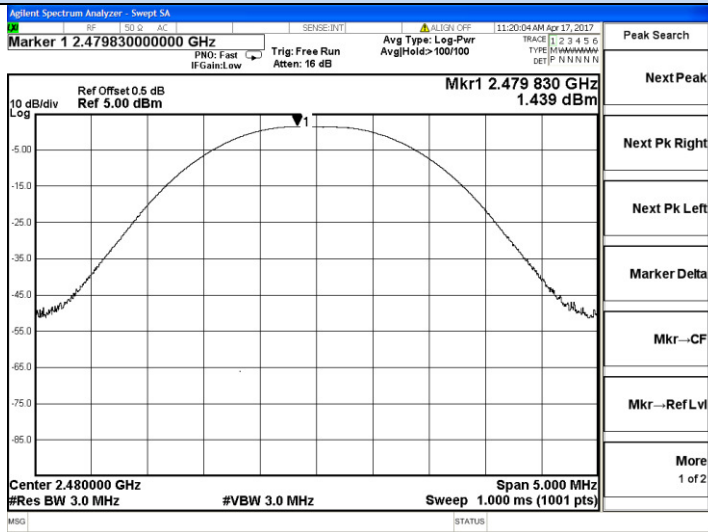

Channel 39 / 2441 MHz

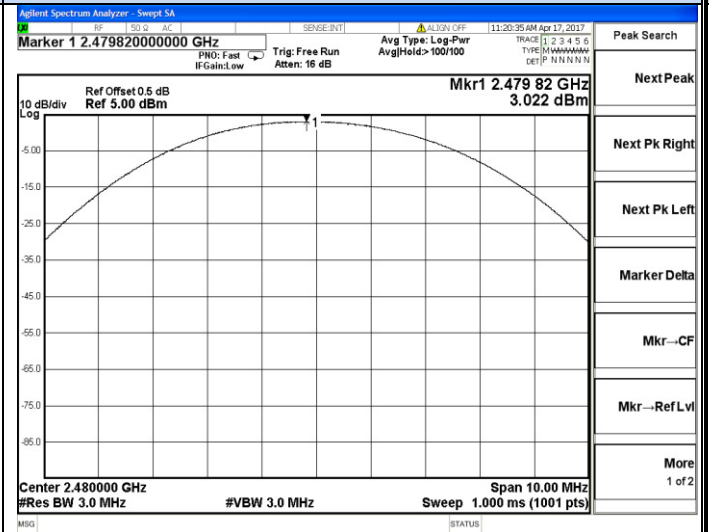

Channel 78 / 2480 MHz

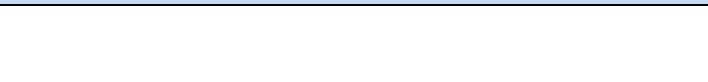

Channel 78 / 2480 MHz

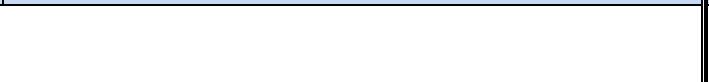

Peak Output Power

8-DPSK

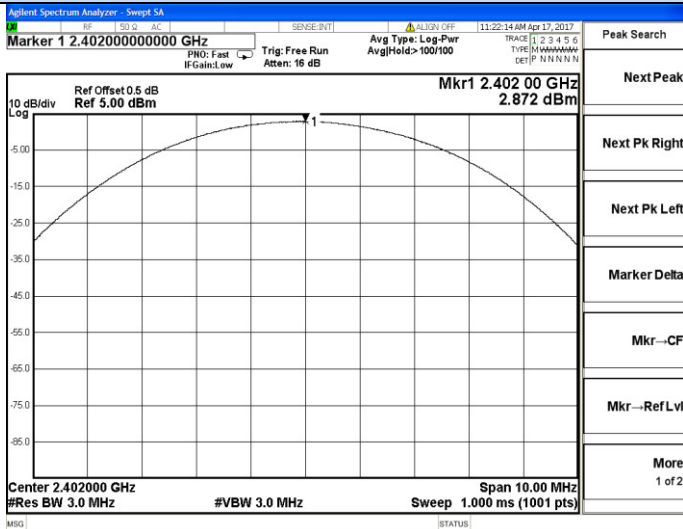

- Peak Search
- Next Peak
- Next Pk Right
- Next Pk Left
- Marker Delta
- Mkr--CF
- Mkr--Ref Lvl
- More
- 1 of 2

Channel 0 / 2402 MHz

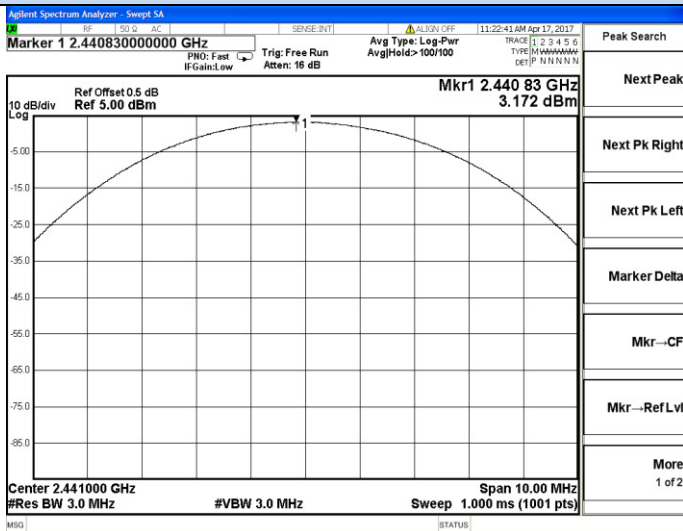

- Peak Search
- Next Peak
- Next Pk Right
- Next Pk Left
- Marker Delta
- Mkr--CF
- Mkr--Ref Lvl
- More
- 1 of 2

Channel 39 / 2441 MHz

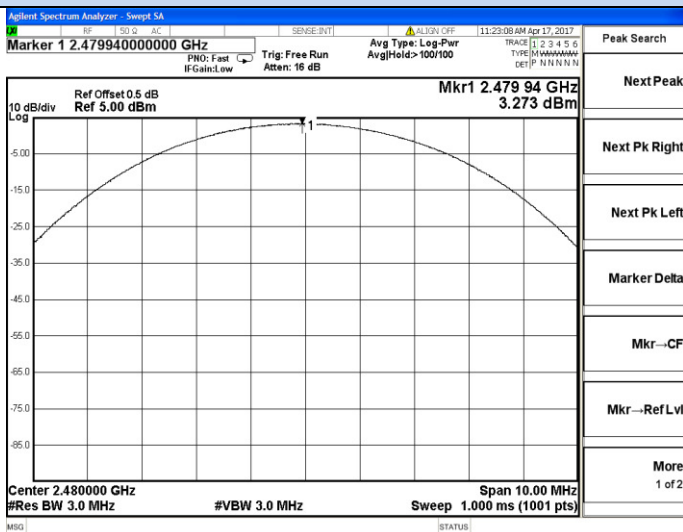

- Peak Search
- Next Peak
- Next Pk Right
- Next Pk Left
- Marker Delta
- Mkr--CF
- Mkr--Ref Lvl
- More
- 1 of 2

Channel 78 / 2480 MHz

6.2 Frequency Separation and 20 dB Bandwidth

6.2.1 Limit

According to §15.247(c) or A8.1(a), in any 100 kHz bandwidth outside the frequency bands in which the spread spectrum intentional radiator is operating, the radio frequency power that is produced by the intentional radiator shall be at least 20dB below that in the 100kHz bandwidth within the band that contains the highest level of the desired power. In addition, radiated emissions which fall in the restricted bands, as defined in §15.205(a), must also comply with the radiated emission limits specified in §15.209(a).

According to section RSS-247§5.4(2), FHSs shall have hopping channel carrier frequencies separated by a minimum of 25 kHz or the -20 dB bandwidth of the hopping channel, whichever is greater. Alternatively, FHSs operating in the band 2400-2483.5 MHz may have hopping channel carrier frequencies that are separated by 25 kHz or two thirds of the -20 dB bandwidth of the hopping channel, whichever is greater, provided that the systems operate with an output power no greater than 0.125 W. The system receivers shall have input bandwidths that match the hopping channel bandwidths of their corresponding transmitters and shall shift frequencies in synchronization with the transmitted signals.

6.2.2 Block Diagram of Test Setup

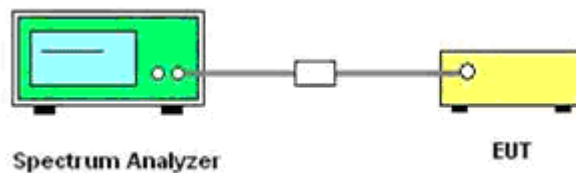

6.2.3 Test Procedure

Frequency separation test procedure :

- 1). Place the EUT on the table and set it in transmitting mode.
- 2). Remove the antenna from the EUT and then connect a low loss RF cable from the antenna port to the Spectrum Analyzer.
- 3). Set center frequency of Spectrum Analyzer = middle of hopping channel.
- 4). Set the Spectrum Analyzer as RBW = 100 KHz, VBW = 300 KHz, Span = wide enough to capture the peaks of two adjacent channels, Sweep = auto.
- 5). Max hold, mark 2 peaks of hopping channel and record the 2 peaks frequency.

20dB bandwidth test procedure :

- 1). Span = approximately 2 to 3 times the 20 dB bandwidth, centered on a hopping channel.
- 2). RBW = 30 KHz, VBW = 100 KHz.
- 3). Detector function = peak.
- 4). Trace = max hold.

6.2.4 Test Results

6.2.4.1 20dB Bandwidth

Test Mode	Channel	Frequency (MHz)	Measured Bandwidth (KHz)		Limits (KHz)	Verdict
			99%	20dB		
GFSK	0	2402	920.49	1042.00	No Limits	PASS
	39	2441	914.39	1040.00		
	78	2480	913.48	1039.00		
$\pi/4$ -DQPSK	0	2402	1188.70	1342.00	No Limits	PASS
	39	2441	1189.40	1343.00		
	78	2480	1190.80	1343.00		
8-DPSK	0	2402	1230.30	1363.00	No Limits	PASS
	39	2441	1230.50	1366.00		
	78	2480	1230.70	1362.00		

Remark:

1. Test results including cable loss;
2. Measured output power at difference Packet Type for each mode and recorded worst case for each mode.
3. Worst case data at DH1 for GFSK, 2DH1 for $\pi/4$ -DQPSK, 3DH1 for 8-DPSK modulation type;
4. Please refer following test plots;

20dB Bandwidth and 99% Bandwidth

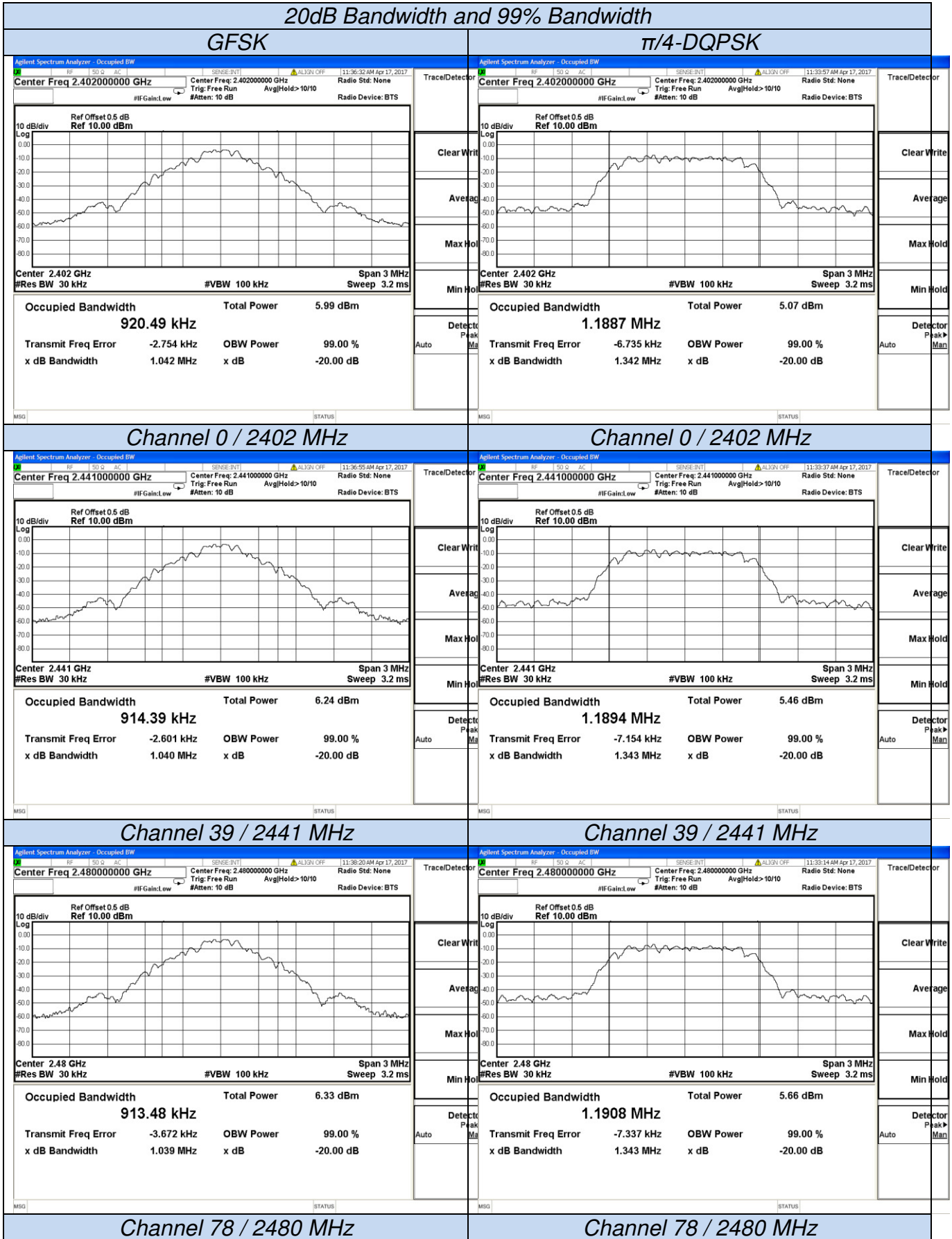

20dB Bandwidth and 99% Bandwidth

8-DPSK

Agilent Spectrum Analyzer - Occupied BW

Center Freq: 2.402000000 GHz
 Trig: Free Run
 #Atten: 10 dB
 Radio Std: None
 Radio Device: BTS

10 dB/Div
 Log
 Ref Offset 0.5 dB
 Ref 10.00 dBm

Center 2.402 GHz Span 3 MHz
 #Res BW 30 kHz #VBW 100 kHz Sweep 3.2 ms

Occupied Bandwidth	Total Power	4.96 dBm
1.2303 MHz		
Transmit Freq Error	OBW Power	99.00 %
-18.734 kHz		
x dB Bandwidth	x dB	-20.00 dB
1.363 MHz		

Trace/Detector
 Clear Write
 Average
 Max Hold
 Min Hold
 Detector Peak Man
 Auto

Channel 0 / 2402 MHz

Agilent Spectrum Analyzer - Occupied BW

Center Freq: 2.441000000 GHz
 Trig: Free Run
 #Atten: 10 dB
 Radio Std: None
 Radio Device: BTS

10 dB/Div
 Log
 Ref Offset 0.5 dB
 Ref 10.00 dBm

Center 2.441 GHz Span 3 MHz
 #Res BW 30 kHz #VBW 100 kHz Sweep 3.2 ms

Occupied Bandwidth	Total Power	5.36 dBm
1.2305 MHz		
Transmit Freq Error	OBW Power	99.00 %
-18.684 kHz		
x dB Bandwidth	x dB	-20.00 dB
1.366 MHz		

Trace/Detector
 Clear Write
 Average
 Max Hold
 Min Hold
 Detector Peak Man
 Auto

Channel 39 / 2441 MHz

Agilent Spectrum Analyzer - Occupied BW

Center Freq: 2.480000000 GHz
 Trig: Free Run
 #Atten: 10 dB
 Radio Std: None
 Radio Device: BTS

10 dB/Div
 Log
 Ref Offset 0.5 dB
 Ref 10.00 dBm

Center 2.48 GHz Span 3 MHz
 #Res BW 30 kHz #VBW 100 kHz Sweep 3.2 ms

Occupied Bandwidth	Total Power	5.53 dBm
1.2307 MHz		
Transmit Freq Error	OBW Power	99.00 %
-18.698 kHz		
x dB Bandwidth	x dB	-20.00 dB
1.362 MHz		

Trace/Detector
 Clear Write
 Average
 Max Hold
 Min Hold
 Detector Peak Man
 Auto

Channel 78 / 2480 MHz

6.2.4.2 Frequency Separation

The Measurement Result With 1Mbps For GFSK Modulation				
Channel	20dB Bandwidth (KHz)	Channel Separation (MHz)	Limit (KHz)	Result
Low	694.67	1.000	1000.00	Pass
Middle	693.33		1000.00	Pass
High	692.67		1000.00	Pass
The Measurement Result With 2Mbps For $\pi/4$ -DQPSK Modulation				
Channel	20dB Bandwidth (KHz)	Channel Separation (MHz)	Limit (KHz)	Result
Low	894.67	1.000	1000.00	Pass
Middle	895.33		1000.00	Pass
High	895.33		1000.00	Pass
The Measurement Result With 3Mbps For 8-DPSK Modulation				
Channel	20dB Bandwidth (KHz)	Channel Separation (MHz)	Limit (KHz)	Result
Low	908.67	1.000	1000.00	Pass
Middle	910.67		1000.00	Pass
High	908.00		1000.00	Pass

Remark:

1. Test results including cable loss;
2. Please refer to following plots;
3. Measured at difference Packet Type for each mode and recorded worst case for each mode.
4. Worst case data at DH1 for GFSK, 2DH1 for $\pi/4$ -DQPSK, 3DH1 for 8-DPSK modulation type;

Frequency Separation

GFSK

$\pi/4$ -DQPSK

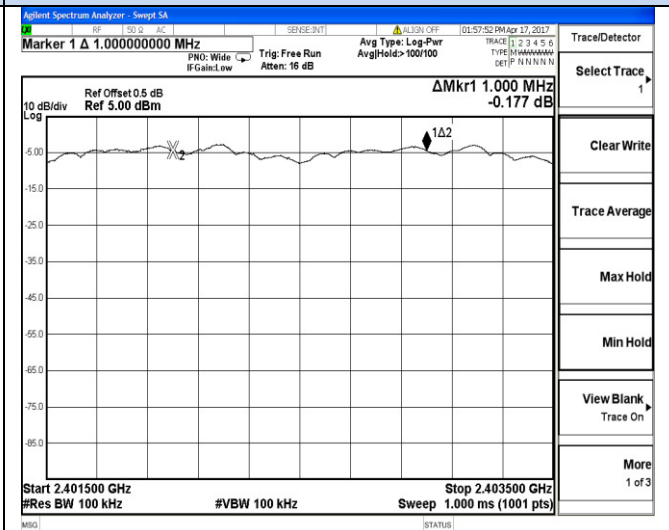
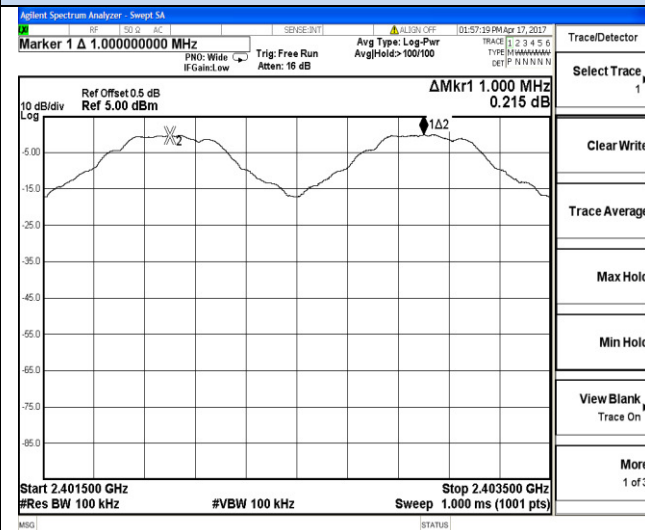

Channel 0 / 2402 MHz

Channel 0 / 2402 MHz

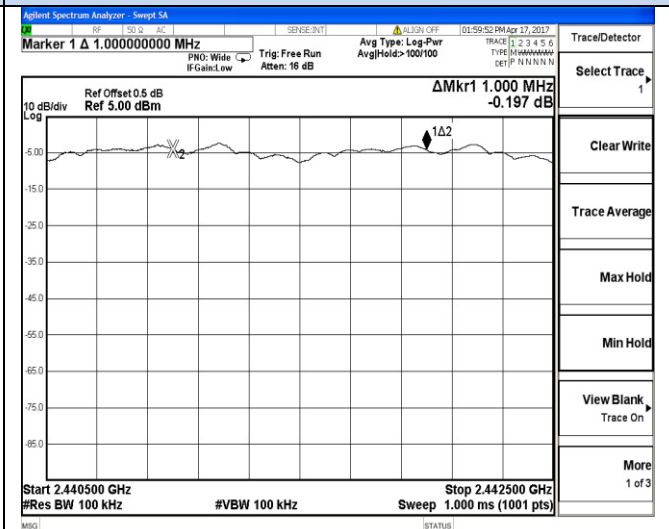
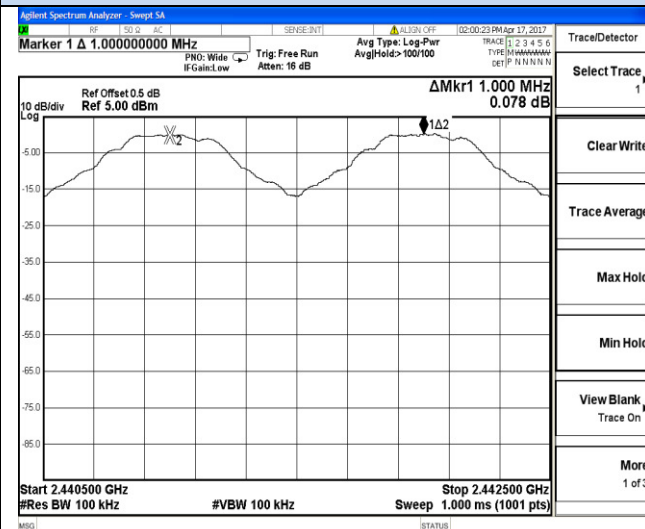

Channel 39 / 2441 MHz

Channel 39 / 2441 MHz

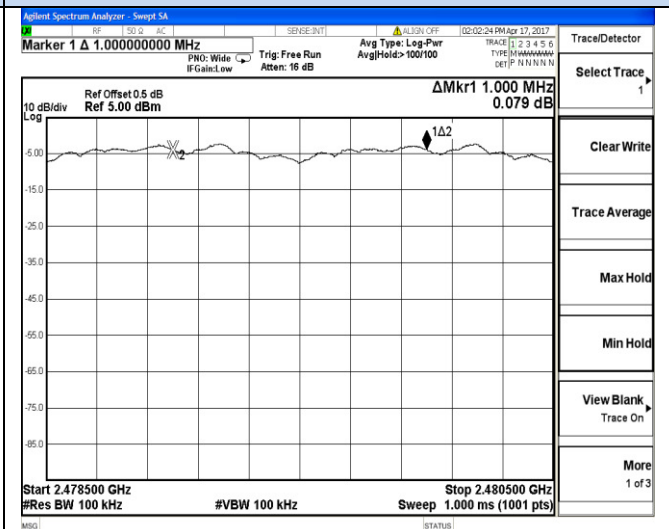
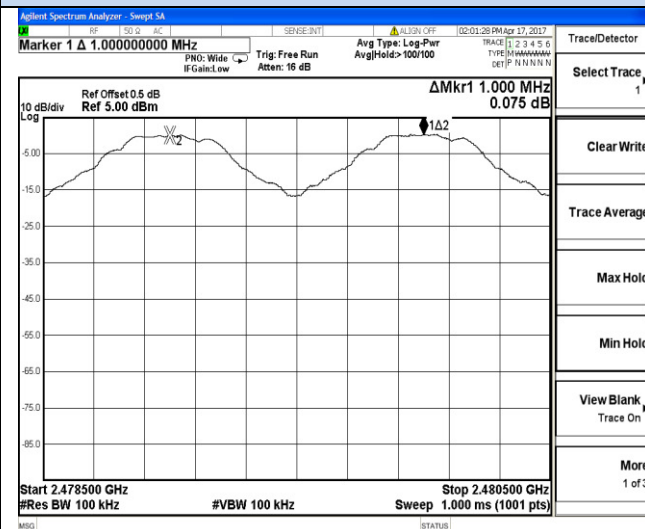

Channel 78 / 2480 MHz

Channel 78 / 2480 MHz

Frequency Separation

8-DPSK

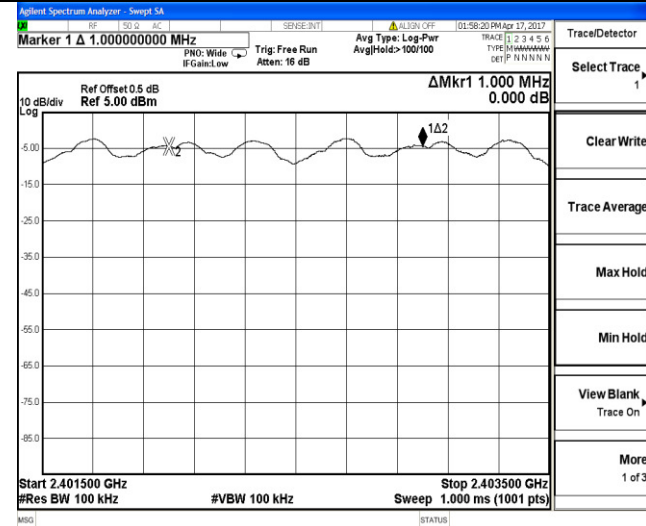

Channel 0 / 2402 MHz

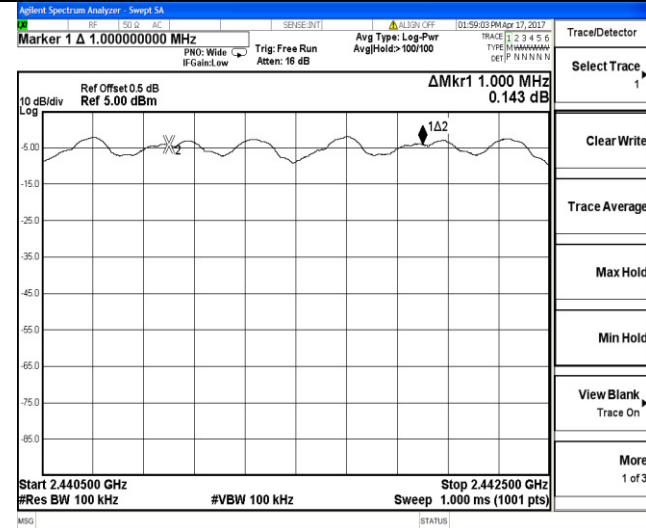

Channel 39 / 2441 MHz

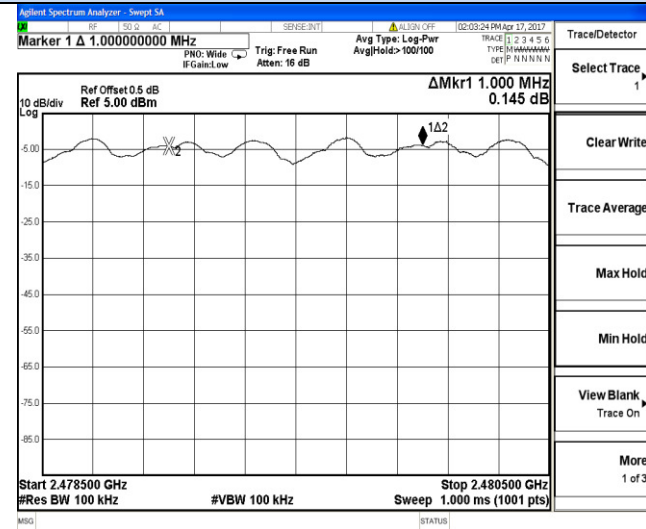

Channel 78 / 2480 MHz

6.3 Number of Hopping Frequency

6.3.1 Limit

According to §15.247(a)(1)(ii) or A8.1 (d), Frequency hopping systems operating in the band 2400-2483.5 MHz shall use at least 15 hopping channels.

According to section RSS-247§5.1 (4), FHSs operating in the band 2400-2483.5 MHz shall use at least 15 hopping channels.

6.3.2 Block Diagram of Test Setup

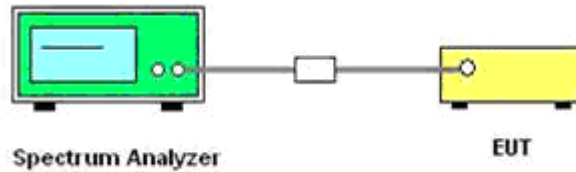

6.3.3 Test Procedure

- 1). Place the EUT on the table and set it in transmitting mode.
- 2). Remove the antenna from the EUT and then connect a low loss RF cable from the antenna port to the Spectrum Analyzer.
- 3). Set Spectrum Analyzer Start=2400MHz, Stop = 2483.5MHz, Sweep = auto.
- 4). Set the Spectrum Analyzer as RBW = 1 MHz, VBW=1MHz.
- 5). Max hold, view and count how many channel in the band.

6.3.4 Test Results

Test Mode	Measurement Result (No. of Channels)	Limit (No. of Channels)	Result
GFSK	79	≥15	PASS
$\pi/4$ -DQPSK	79	≥15	PASS
8-DPSK	79	≥15	PASS

Remark:

1. Test results including cable loss;
2. Measured output power at difference Packet Type for each mode and recorded worst case for each mode.
3. Worst case data at DH1 for GFSK, 2DH1 for $\pi/4$ -DQPSK, 3DH1 for 8-DPSK modulation type;
4. Record test plots only for GFSK;
5. Please refer following test plots;

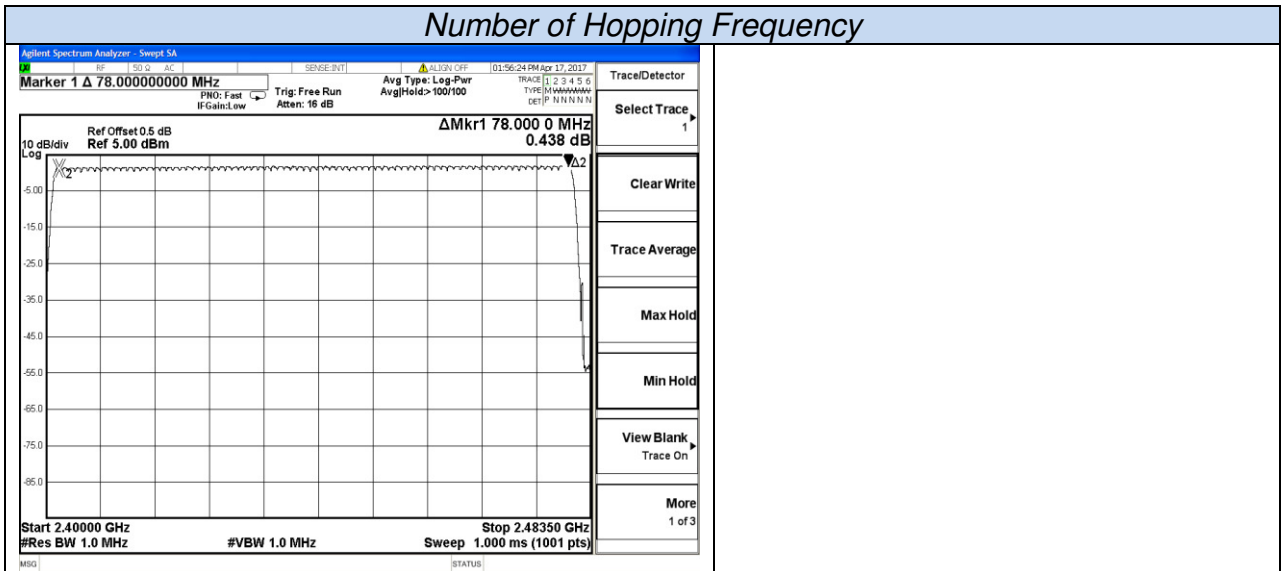

6.4 Time of Occupancy (Dwell Time)

6.4.1 Limit

According to §15.247(a)(1)(iii) or A8.1 (d), Frequency hopping systems operating in the 2400MHz-2483.5 MHz bands. The average time of occupancy on any channels shall not greater than 0.4 s within a period 0.4 s multiplied by the number of hopping channels employed.

According to section RSS-247§5.1 (4), The average time of occupancy on any channel shall not be greater than 0.4 seconds within a period of 0.4 seconds, multiplied by the number of hopping channels employed. Transmissions on particular hopping frequencies may be avoided or suppressed provided that at least 15 hopping channels are used.

6.4.2 Block Diagram of Test Setup

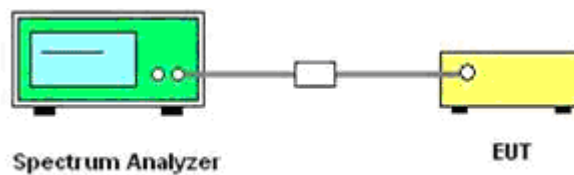

6.4.3 Test Procedure

- 1). Place the EUT on the table and set it in transmitting mode.
- 2). Remove the antenna from the EUT and then connect a low loss RF cable from the antenna port to the Spectrum Analyzer.
- 3). Set center frequency of Spectrum Analyzer = operating frequency.
- 4). Set the Spectrum Analyzer as RBW, VBW=1MHz, Span = 0Hz, Sweep = auto.
- 5). Repeat above procedures until all frequency measured was complete.

6.4.4 Test Results

The Dwell Time=Burst Width*Total Hops. The detailed calculations are showed as follows:

The duration for dwell time calculation: $0.4[s]*\text{hopping number}=0.4[s]*79[\text{ch}]=31.6[s*\text{ch}]$;

The burst width [ms/hop/ch], which is directly measured, refers to the duration on one channel hop.

The hops per second for all channels: The selected EUT Conf uses a slot type of 5-Tx&1-Rx and a hopping rate of 1600 [ch*hop/s] for all channels. So the final hopping rate for all channels is $1600/6=266.67$ [ch*hop/s]

The hops per second on one channel: $266.67 [\text{ch}*hops/s]/79 [\text{ch}]=3.38 [\text{hop/s}]$;

The total hops for all channels within the dwell time calculation duration: $3.38 [\text{hop/s}]*31.6[s*\text{ch}]=106.67$ [hop*ch];

The dwell time for all channels hopping: $106.67 [\text{hop}*\text{ch}]*\text{Burst Width} [\text{ms}/\text{hop}/\text{ch}]$.

Mode	Frequency (MHz)	Burst Type	Pulse Width (ms)	Dwell Time (S)	Limit (S)	Verdict
GFSK	2441	DH1	0.394	0.1261	0.4	PASS
		DH3	1.645	0.2632	0.4	PASS
		DH5	2.895	0.3088	0.4	PASS
π/4-DQPSK	2441	2DH1	0.398	0.1274	0.4	PASS
		2DH3	1.649	0.2638	0.4	PASS
		2DH5	2.902	0.3095	0.4	PASS
8-DPSK	2441	3DH1	0.394	0.1261	0.4	PASS
		3DH3	1.646	0.2634	0.4	PASS
		3DH5	2.906	0.3100	0.4	PASS

Remark:

1. Test results including cable loss;
2. Please refer to following plots;
3. Measured at difference Packet Type for each mode and recorded worst case for each mode.
4. Dwell Time Calculate formula:
 DH1: Dwell time=Pulse time (ms) × (1600 ÷ 2 ÷ 79) ×31.6 Second
 DH3: Dwell time=Pulse time (ms) × (1600 ÷ 4 ÷ 79) ×31.6 Second
 DH5: Dwell time=Pulse Time (ms) × (1600 ÷ 6 ÷ 79) ×31.6 Second
5. Measured at low, middle and high channel, recorded worst at middle channel;

Dwell time

GFSK

$\pi/4$ -DQPSK

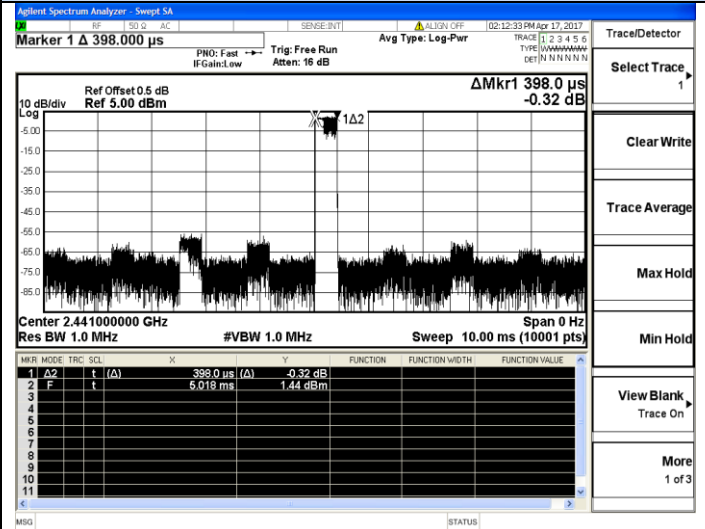
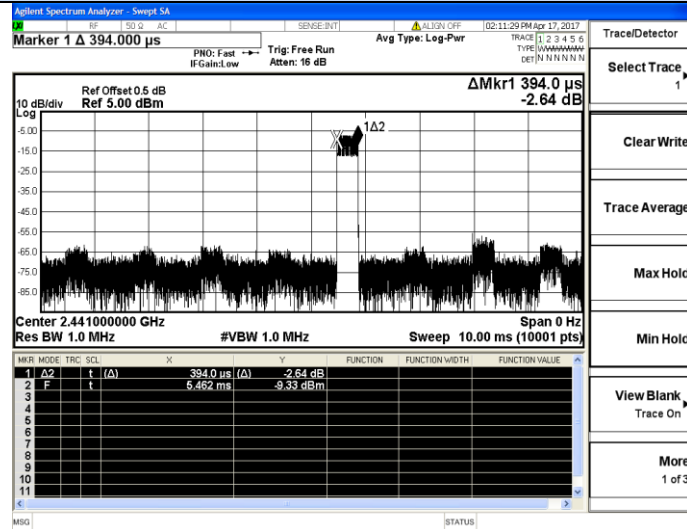

Channel 39 / 2441 MHz – DH1

Channel 39 / 2441 MHz - 2DH1

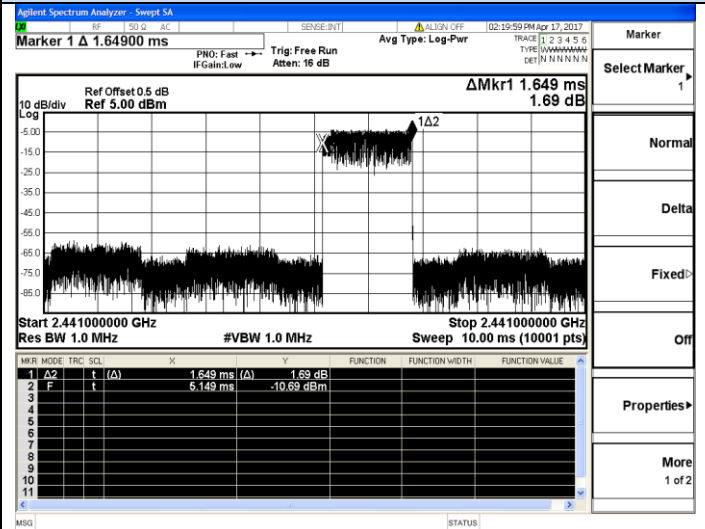
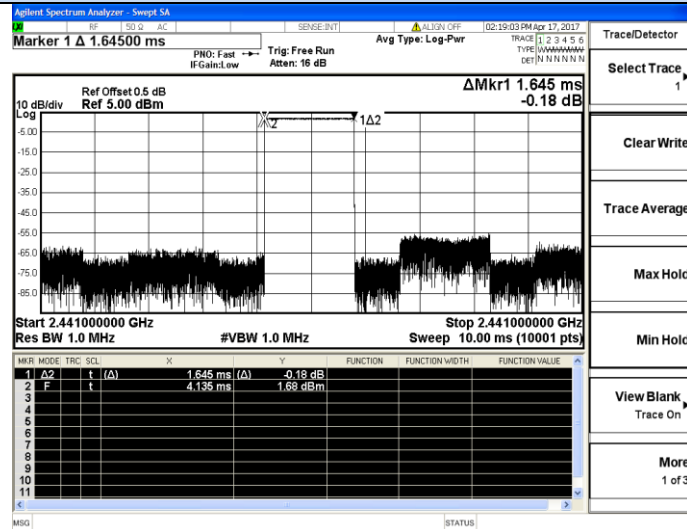

Channel 39 / 2441 MHz – DH3

Channel 39 / 2441 MHz - 2DH3

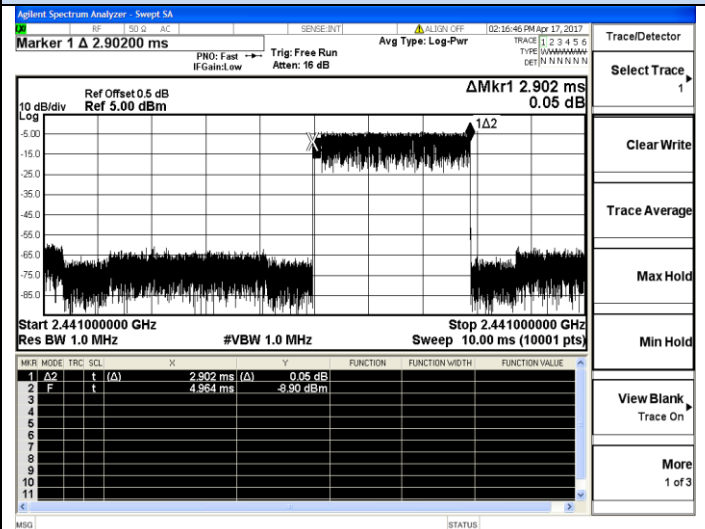
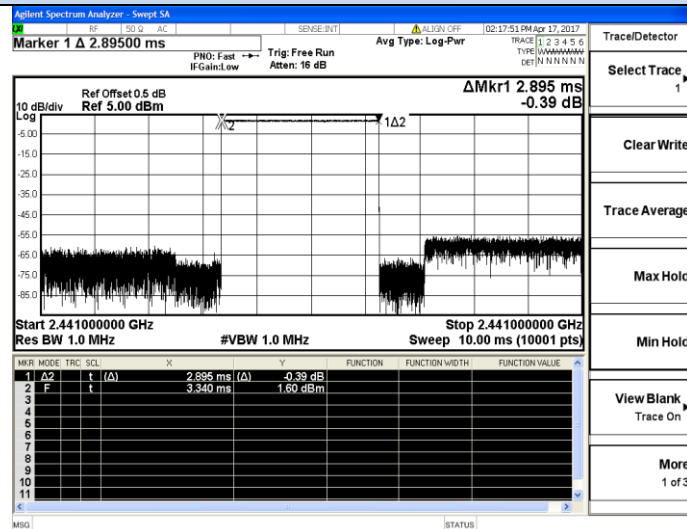

Channel 39 / 2441 MHz – DH5

Channel 39 / 2441 MHz - 2DH5

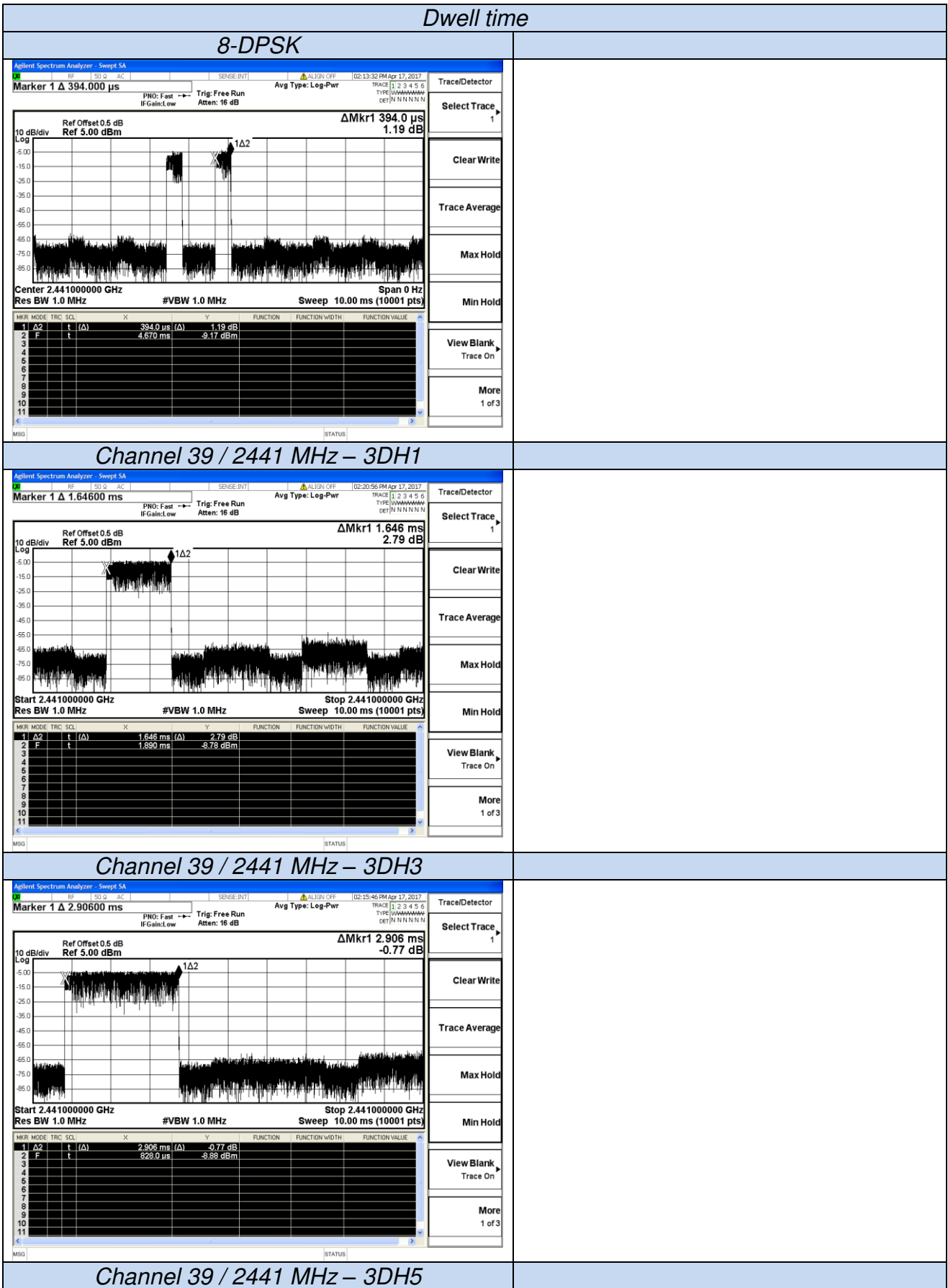

6.5 Conducted Spurious Emissions and Band Edges Test

6.5.1 Limit

In any 100 kHz bandwidth outside the frequency band in which the spread spectrum or digitally modulated intentional radiator is operating, the radio frequency power that is produced by the intentional radiator shall be at least 20 dB below that in the 100 kHz bandwidth within the band that contains the highest level of the desired power, based on either an RF conducted or a radiated measurement. Attenuation below the general limits specified in Section 15.209(a) is not required.

If the transmitter complies with the conducted power limits based on the use of root-mean-square averaging over a time interval, as permitted under Section RSS-247§5.4 (4), the attenuation required shall be 30 dB instead of 20 dB. Attenuation below the general field strength limits specified in RSS-Gen is not required.

6.5.2 Block Diagram of Test Setup

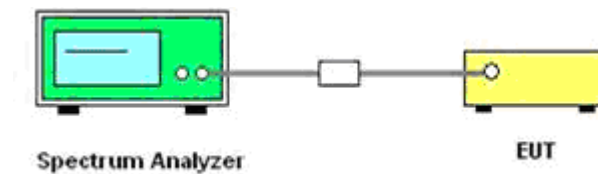

6.5.3 Test Procedure

Conducted RF measurements of the transmitter output were made to confirm that the EUT antenna port conducted emissions meet the specified limit and to identify any spurious signals that require further investigation or measurements on the radiated emissions site.

The transmitter output is connected to the spectrum analyzer. The resolution bandwidth is set to 100 KHz. The video bandwidth is set to 300 KHz.

Measurements are made over the 9 KHz to 26.5GHz range with the transmitter set to the lowest, middle, and highest channels

6.5.4 Test Results of Conducted Spurious Emissions

No non-compliance noted. Only record the worst test result (TX-GFSK) in this report. The test data refer to the following page.

Test Mode	Channel	Frequency (MHz)	Spurious RF Conducted Emission (dBc)	Limits (dBc)	Verdict
GFSK	0	2402	<-20	-20	PASS
	39	2441	<-20		
	78	2480	<-20		
$\pi/4$ -DQPSK	0	2402	<-20	-20	PASS
	39	2441	<-20		
	78	2480	<-20		
8-DPSK	0	2402	<-20	-20	PASS
	39	2441	<-20		
	78	2480	<-20		

Remark:

1. Test results including cable loss;
2. Please refer to following plots;
3. Measured at difference Packet Type for each mode and recorded worst case for each mode.
4. Worst case data at DH1 for GFSK, 2DH1 for $\pi/4$ -DQPSK, 3DH1 for 8-DPSK modulation type;