

poly

Model: BANYF Vares Commodity A Control

NOT FOR RESALE



PN: 2201-87813-001
S/N: RG34885CCCMZ
REV: 00000000
REV: 00000000

Manufacturer: HP Inc
Made in Laos
EU: HP REG 22018 0028 8018000A 0001
UK: HP Inc UK Ltd, Regulatory Services, Earley West, 300 Thomas Valley Park Drive, RG6 1PT

2668-06416-463 REV 26

poly



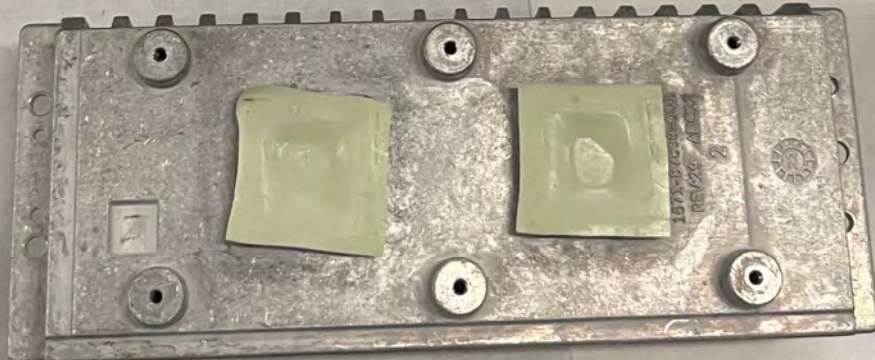
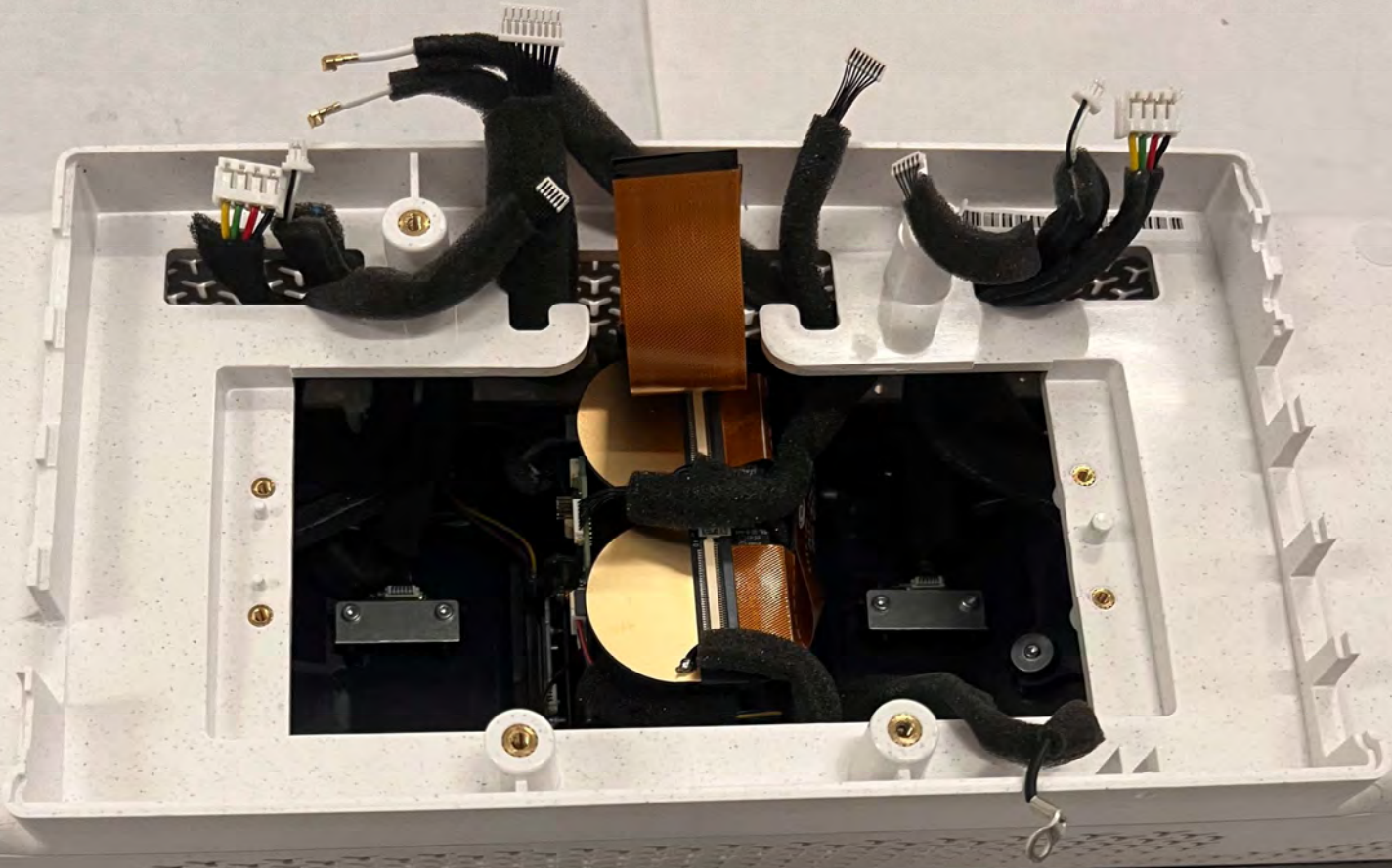

for reference only

WESTCOTT

STAINLESS STEEL

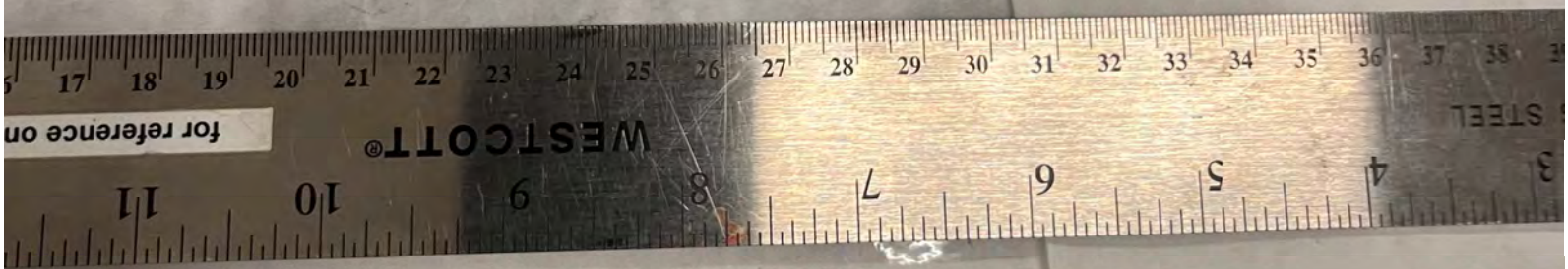

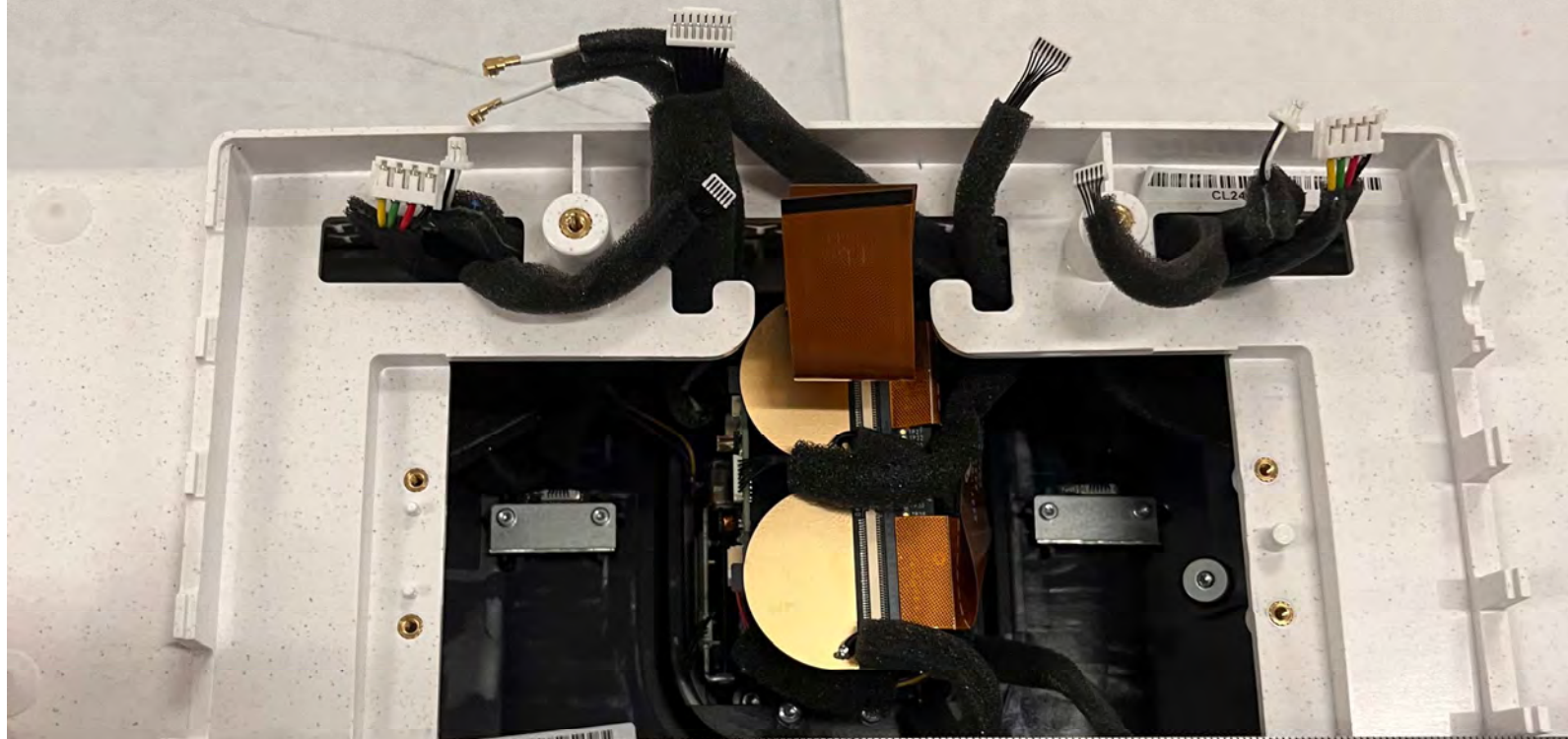

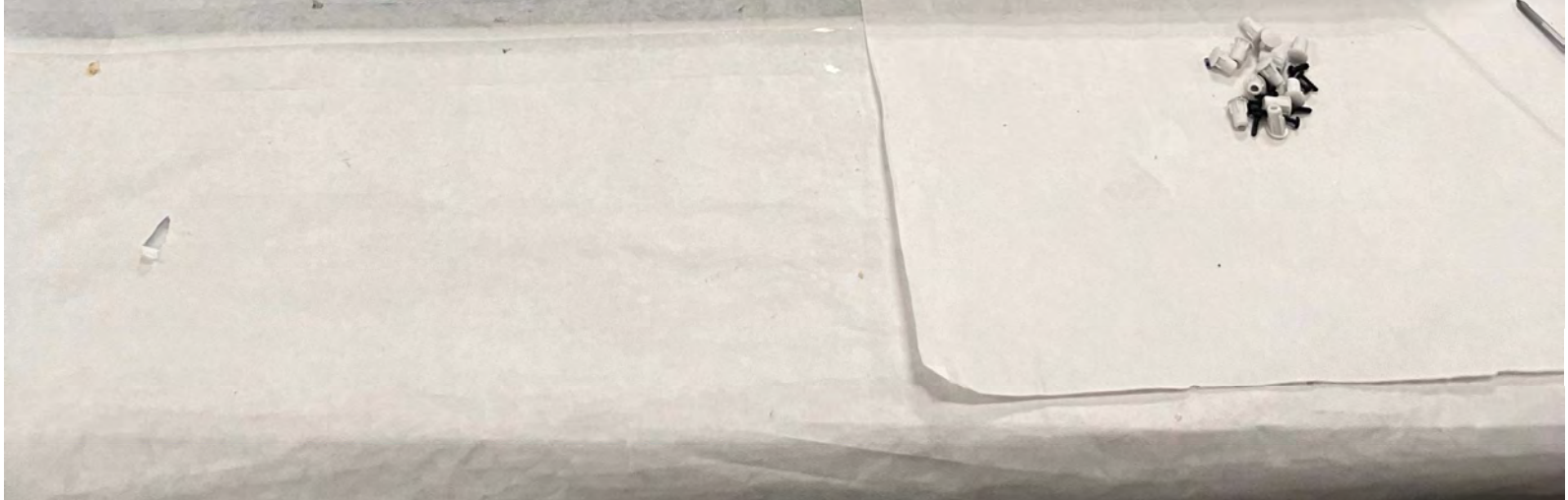
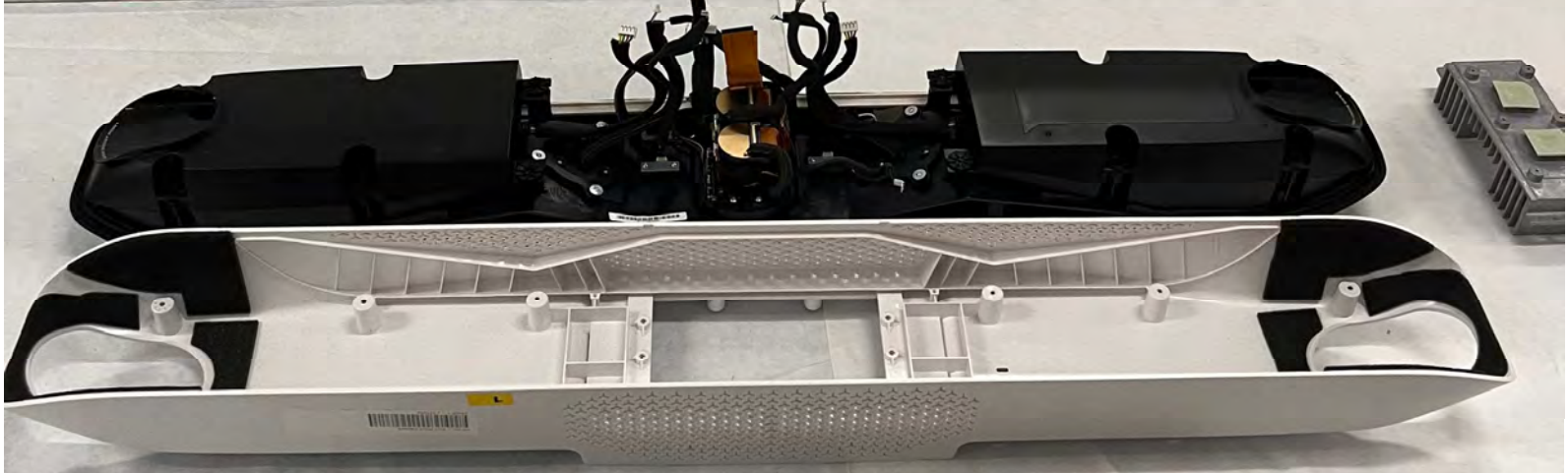

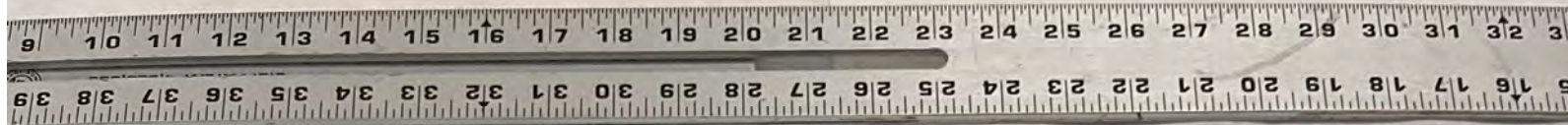

18 19 20 21 22 23 24 25 26 27 28 29 30 31 32 33 34 35 36
U.S. PATENT

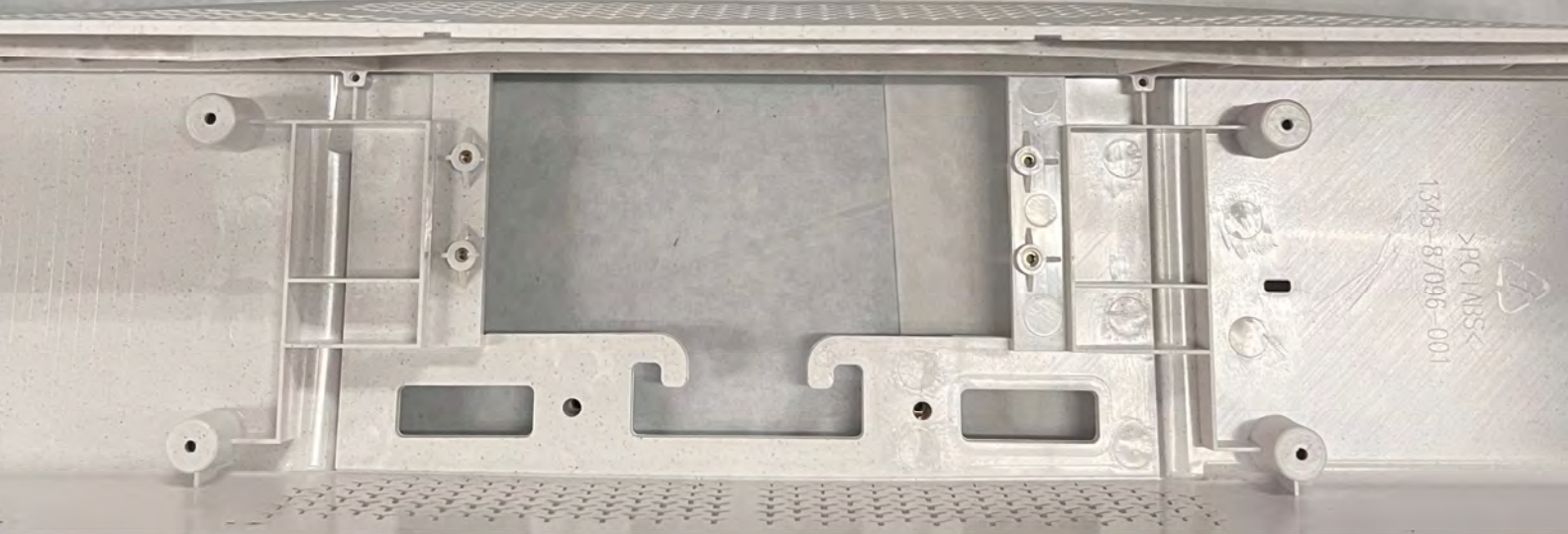

WESTCOTT
STAINLESS STEEL
for reference only
2 3 4 5 6 7 8 9 10 11 12 13 14 15 16 17



U.S. PATENT & TRADEMARK OFFICE
31 32 33 34 35 36 37 38 39 40 41 42 43 44 45 46



WESTCOTT®
for reference only
3 4 5 6 7 8 9 10 11 12 13 14 15
36 38 37 35 34 33 32 30 29 28 27 26 25 24 23 22 21 20 19 18 17 16 15 14 13 12 11 10 9 8 7 6 5 4 3
SS STEEL

10 11 12 13 14 15 16 17 18 19 20 21 22 23 24 25



WESTCOTT®
STAINLESS STEEL
for reference only

2 3 4 5 6 7 8 9 10 11 12 13 14



CL24088M00Y



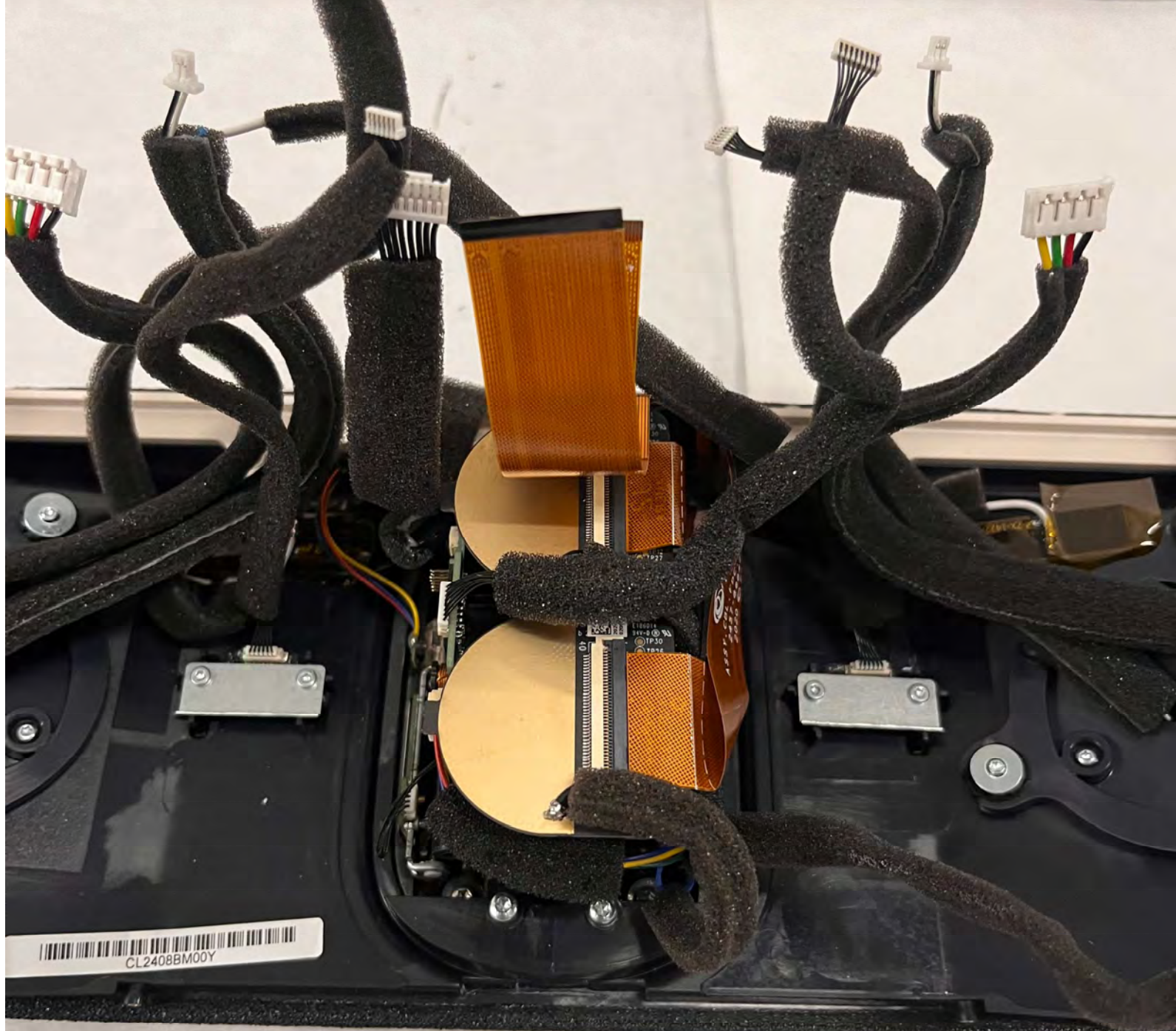



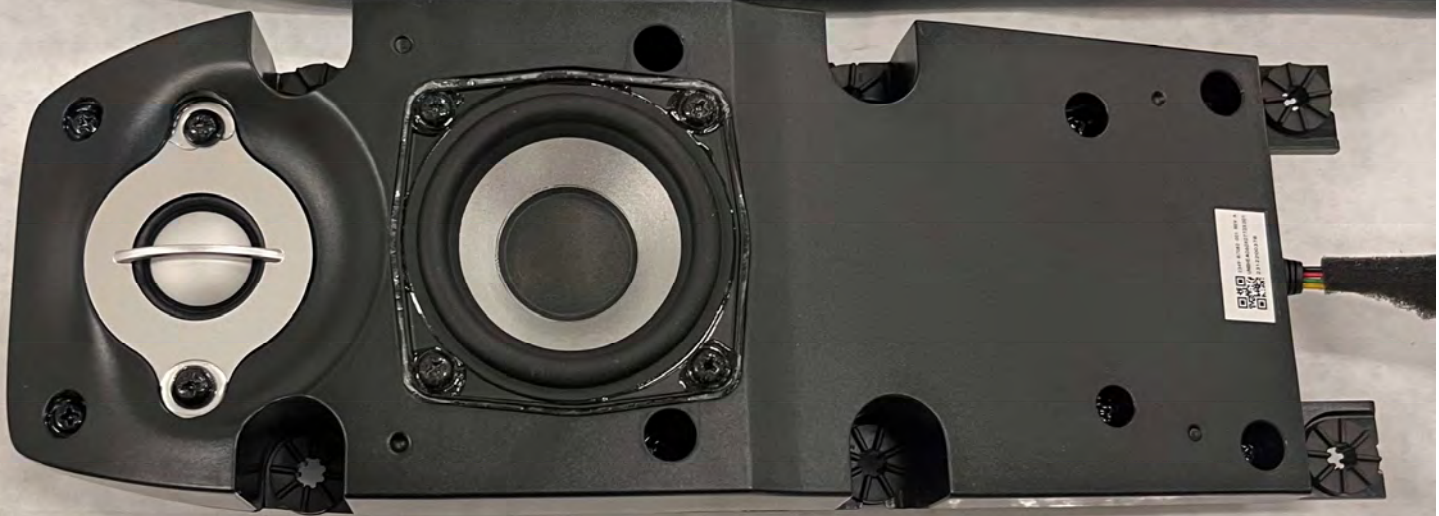

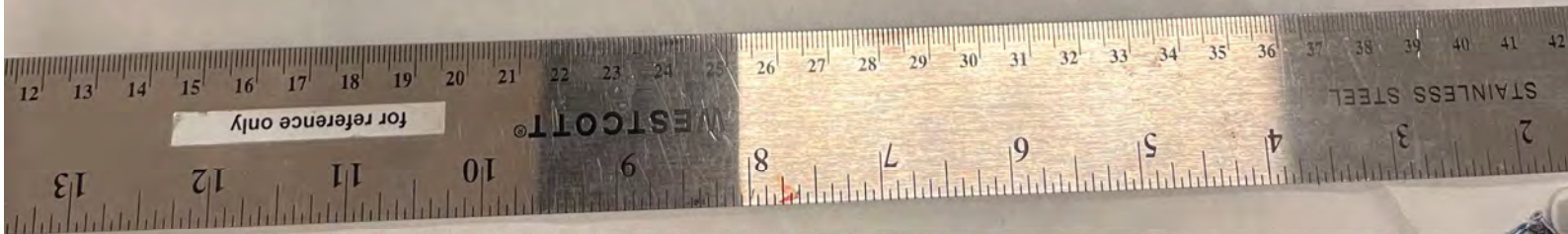

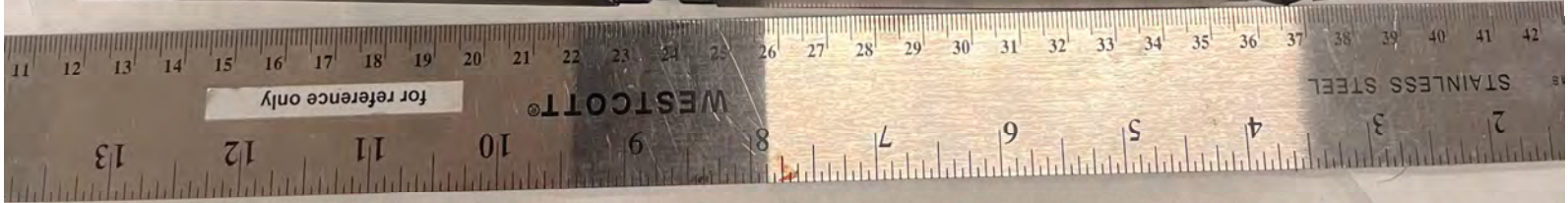



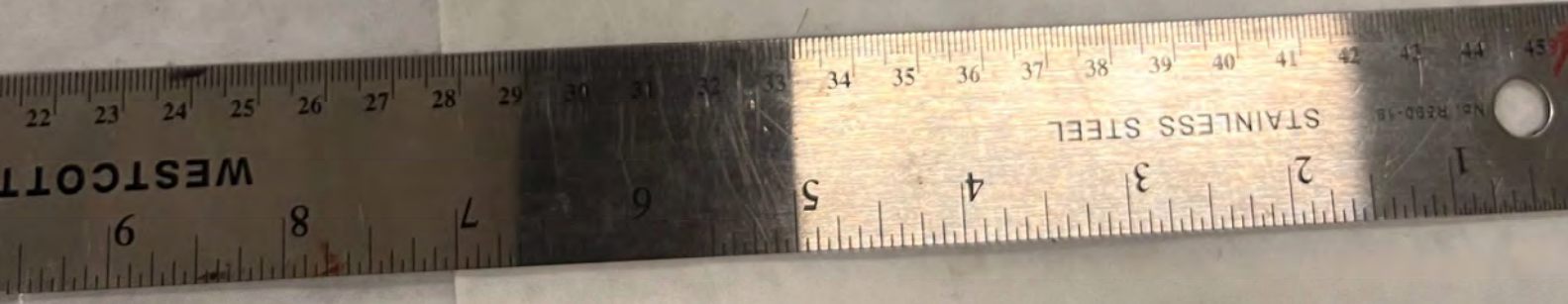





for reference on

STAINLESS STEEL

16:9 Dual Lens ASPH NFOV EPTZ system

STUDIO X72

16:9 Dual Lens ASPH NFOV EPTZ system



for reference only

WESTCOTT

STEEL