



FCC 47 CFR PART 15 SUBPART C

TEST REPORT

For

Applicant : Graco Children's Products, Inc.
Address : OAKLANDS BOULEVARD, EXTON, Pennsylvania 19341, United States
Product Name : Video Baby Monitor
Model Name : PD170766
Brand Name : Graco
FCC ID : M6YPD170766
Report No. : MOST110418F2
Date of Issue : May. 20, 2011

Issued by : Most Technology Service Co., Ltd.
Address : No.5, Langshan 2nd Road, North District, Hi-tech Industrial Park, Lanshan, Shenzhen, Guangdong, China
Tel : 86-755-8617 0306
Fax : 86-755-8617 0310

The report consists 44 pages in total. It may be duplicated completely for legal use with the approval of the applicant. It should not be reproduced except in full, without the written approval of our laboratory. The client should not use it to claim product endorsement by MOST. The test results in the report only apply to the tested sample. The test report shall be invalid without all the signatures of testing engineers, reviewer and approver.

TABLE OF CONTENTS

1. VERIFICATION OF CONFORMITY	3
2. GENERAL INFORMATION.....	4
2.1 Product Information.....	4
2.2 Objective.....	5
2.3 Test Standards and Results	5
2.4 Environmental Conditions.....	5
3. TEST FACILITY	6
3.1 TEST FACILITY	6
3.2 GENERAL TEST PROCEDURES	6
3.3 FCC PART 15.205 RESTRICTED BANDS OF OPERATIONS.....	7
4. TEST EQUIPMENT LIST	8
5. 47 CFR Part 15 C 15.247 Requirements.....	9
5.1 6dB Bandwidth	9
5.1.1 Definition	9
5.1.2 Test Description	9
5.1.3 Test Result.....	9
5.2 Peak Output Power.....	14
5.2.1 Definition	14
5.2.2 Test Description	14
5.2.3 Test Result.....	14
5.3 Conducted Spurious Emission	16
5.3.1 Definition	16
5.3.2 Test Description	16
5.3.3 Test Result.....	16
5.4 Power Spectral Density (PSD).....	18
5.4.1 Definition	18
5.4.2 Test Description	18
5.4.3 Test Result.....	18
5.5 Conducted Emission.....	20
5.5.1 Definition	20
5.5.2 Test Description	20
5.5.3 Test Result.....	20
5.6 Radiated Emission	23
5.6.1 Definition	23
5.6.2 Test Description	24
5.6.3 Test Result.....	26
APPENDIX 1	31
PHOTOGRAPHS OF TEST SETUP	31
APPENDIX 2.....	34
PHOTOGRAPHS OF EUT	34

1. VERIFICATION OF CONFORMITY

Equipment Under Test: Video Baby Monitor
Brand Name: Graco
Model Number: PD170766
Series Model Name: N/A
Series Model Difference Description: N/A
FCC ID: M6YPD170766
Applicant: Graco Children’s Products, Inc.
OAKLANDS BOULEVARD, EXTON, Pennsylvania 19341, United States.
Manufacturer: Honor Tone Ltd.
Lot No. 15-16, Western District of Science & Technology Park, Daya Bay Economy and Technology Development District, Huizhou City, Guangdong Province, PRC.
Technical Standards: 47 CFR Part 15 Subpart C
File Number: MOST110418F2
Date of test: May. 16 ~ May. 18, 2011
Deviation: None
Condition of Test Sample: Normal
Test Result: PASS

The above equipment was tested by *MOST* for compliance with the requirements set forth in FCC rules and the Technical Standards mentioned above. This said equipment in the configuration described in this report shows the maximum emission levels emanating from equipment and the level of the immunity endurance of the equipment are within the compliance requirements.

The test results of this report relate only to the tested sample identified in this report.

Tested by (+ signature): Petter Ping
Petter Ping May. 20, 2011

Review by (+ signature): July Wen
July Wen May. 20, 2011

Approved by (+ signature): Terry Yang
Terry Yang May. 20, 2011

2. GENERAL INFORMATION

2.1 Product Information

EUT- GSM Mobile Phone	
Description:	Video Baby Monitor
Brand Name:	Graco
Model Name:	PD170766
Power Supply:	DC 5V by AC/DC adapter 100~240V 50/60Hz DC 2.4V by Battery
Frequency Range:	2402MHz – 2478MHz
Number of Channels:	18(CH LOW:2402MHz, CH MID:2440, CH HIGH:2478)
Modulation Technique:	FSK
Antenna Gain:	0 dBi
Temperature Range:	-20°C ~ +50°C

NOTE:

1. For a more detailed features description about the EUT, please refer to User's Manual.

2.2 Objective

The objective of the report is to perform tests according to 47 CFR Part 15 Subpart C for the EUT FCC ID Certification:

No.	Identity	Document Title
1	47 CFR Part 15(10-1-05 Edition)	Radio Frequency Devices

2.3 Test Standards and Results

Test items and the results are as bellow:

No.	Section	Description	Result	Date of Test
1	15.247(a)(2)	6dB Bandwidth	PASS	2011-05-18
2	15.247(b)(3)	Peak Output Power	PASS	2011-05-18
3	15.247(d)	conducted spurious emission	PASS	2011-05-18
4	15.247(e)	Power Spectral Density	PASS	2011-05-18
5	15.207	Conducted Emission	PASS	2011-05-16
6	15.247(d) 15.209	Radiated Emission	PASS	2011-05-16

Note: 1. The test result judgment is decided by the limit of measurement standard
 2. The information of measurement uncertainty is available upon the customer's request.

2.4 Environmental Conditions

During the measurement the environmental conditions were within the listed ranges:

- Temperature: 15-35°C
- Humidity: 30-60 %
- Atmospheric pressure: 86-106 kPa

3. TEST FACILITY

3.1 TEST FACILITY

Test Site:	Most Technology Service Co., Ltd.
Location:	No.5, Nangshan 2nd Rd., North Hi-Tech Industrial park, Nanshan, Shenzhen, Guangdong, China
Description:	<p>There is one 3m semi-anechoic an area test sites and two line conducted labs for final test. The Open Area Test Sites and the Line Conducted labs are constructed and calibrated to meet the FCC requirements in documents ANSI C63.4:2009and CISPR 16 requirements.</p> <p>The FCC Registration Number is 490827.</p>
Site Filing:	The site description is on file with the Federal Communications Commission, 7435 Oakland Mills Road, Columbia, MD 21046.
Instrument Tolerance:	All measuring equipment is in accord with ANSI C63.4:2009 and CISPR 16 requirements that meet industry regulatory agency and accreditation agency requirement.
Ground Plane:	Two conductive reference ground planes were used during the Line Conducted Emission, one in vertical and the other in horizontal. The dimensions of these ground planes are as below. The vertical ground plane was placed distancing 40 cm to the rear of the wooden test table on where the EUT and the support equipment were placed during test. The horizontal ground plane projected 50 cm beyond the footprint of the EUT system and distanced 80 cm to the wooden test table. For Radiated Emission Test, one horizontal conductive ground plane extended at least 1m beyond the periphery of the EUT and the largest measuring antenna, and covered the entire area between the EUT and the antenna. It has no holes or gaps having longitudinal dimensions larger than one-tenth of a wavelength at the highest frequency of measurement up to 1GHz.

3.2 GENERAL TEST PROCEDURES

EUT Function and Test Mode

The EUT has been tested under normal operating (TX) and standby (RX) condition.

The field strength of radiation emission was measured in the following position: EUT stand-up position (Y axis), lie-down position (X, Z axis).

The following data show only with the worst case setup.

The worst case of Y axis was reported.

Based on client request, all normal using modes of the normal function were tested but only the worst test data of the worst mode is recorded by this report.

Conducted Emissions

The EUT is placed on the turntable, which is 0.8 m above ground plane. According to the requirements in Section 13.1.4.1 of ANSI C63.4:2009, Conducted emissions from the EUT measured in the frequency range between 0.15 MHz and 30MHz using CISPR Quasi-peak and average detector modes.

Radiated Emissions

The EUT is placed on a turn table, which is 0.8 m above ground plane. The turntable shall rotate 360 degrees to determine the position of maximum emission level. EUT is set 3m away from the receiving antenna, which varied from 1m to 4m to find out the highest emission. And also, each emission was to be maximized by changing the polarization of receiving antenna both horizontal and vertical. In order to find out the maximum emissions, exploratory radiated emission measurements were made according to the requirements in Section 13.1.4.1 of ANSI C63.4:2009.

3.3 FCC PART 15.205 RESTRICTED BANDS OF OPERATIONS

(a) Except as shown in paragraph (d) of this section, only spurious emissions are permitted in any of the frequency bands listed below:

MHz	MHz	MHz	GHz
0.090 - 0.110	16.42 - 16.423	399.9 - 410	4.5 - 5.15
¹ 0.495 - 0.505	16.69475 - 16.69525	608 - 614	5.35 - 5.46
2.1735 - 2.1905	16.80425 - 16.80475	960 - 1240	7.25 - 7.75
4.125 - 4.128	25.5 - 25.67	1300 - 1427	8.025 - 8.5
4.17725 - 4.17775	37.5 - 38.25	1435 - 1626.5	9.0 - 9.2
4.20725 - 4.20775	73 - 74.6	1645.5 - 1646.5	9.3 - 9.5
6.215 - 6.218	74.8 - 75.2	1660 - 1710	10.6 - 12.7
6.26775 - 6.26825	108 - 121.94	1718.8 - 1722.2	13.25 - 13.4
6.31175 - 6.31225	123 - 138	2200 - 2300	14.47 - 14.5
8.291 - 8.294	149.9 - 150.05	2310 - 2390	15.35 - 16.2
8.362 - 8.366	156.52475 - 156.52525	2483.5 - 2500	17.7 - 21.4
8.37625 - 8.38675	156.7 - 156.9	2655 - 2900	22.01 - 23.12
8.41425 - 8.41475	162.0125 - 167.17	3260 - 3267	23.6 - 24.0
12.29 - 12.293	167.72 - 173.2	3332 - 3339	31.2 - 31.8
12.51975 - 12.52025	240 - 285	3345.8 - 3358	36.43 - 36.5
12.57675 - 12.57725	322 - 335.4	3600 - 4400	(²)
13.36 - 13.41			

¹ Until February 1, 1999, this restricted band shall be 0.490-0.510 MHz.

² Above 38.6

(b) Except as provided in paragraphs (d) and (e), the field strength of emissions appearing within these frequency bands shall not exceed the limits shown in Section 15.209. At frequencies equal to or less than 1000 MHz, compliance with the limits in Section 15.209 shall be demonstrated using measurement instrumentation employing a CISPR quasi-peak detector. Above 1000 MHz, compliance with the emission limits in Section 15.209 shall be demonstrated based on the average value of the measured emissions. The provisions in Section 15.35 apply to these measurements.

4. TEST EQUIPMENT LIST

Instrumentation: The following list contains equipment used at MOST for testing. The equipment conforms to the CISPR 16-1/ANSI C63.2 Specifications for Electromagnetic Interference and Field Strength Instrumentation from 10 kHz to 1.0 GHz or above.

No.	Equipment	Manufacturer	Model No.	S/N	Calibration due date
1	Test Receiver	Rohde & Schwarz	ESCI	100492	2012/03/14
2	Spectrum Analyzer	Agilent	E7405A	US44210471	2012/03/14
3	L.I.S.N.	Rohde & Schwarz	ENV216	100093	2012/03/14
4	Coaxial Switch	Anritsu Corp	MP59B	6200283933	2012/03/14
5	Terminator	Hubersuhner	50Ω	No.1	2012/03/14
6	RF Cable	SchwarzBeck	N/A	No.1	2012/03/14
7	Test Receiver	Rohde & Schwarz	ESPI	101202	2012/03/14
8	Bilog Antenna	Sunol	JB3	A121206	2012/03/14
9	Horn Antenna	TRC	N/A	N/A	2012/03/14
10	Cable	Resenberger	N/A	NO.1	2012/03/14
11	Cable	SchwarzBeck	N/A	NO.2	2012/03/14
12	Cable	SchwarzBeck	N/A	NO.3	2012/03/14
13	DC Power Filter	DuoJi	DL2×30B	N/A	2012/03/14
14	Single Phase Power Line Filter	DuoJi	FNF 202B30	N/A	2012/03/14
15	3 Phase Power Line Filter	DuoJi	FNF 402B30	N/A	2012/03/14
16	Test Receiver	Rohde & Schwarz	ESCI	100492	2012/03/14
17	Absorbing Clamp	Luthi	MDS21	3635	2012/03/14
18	Coaxial Switch	Anritsu Corp	MP59B	6200283933	2012/03/14
19	AC Power Source	Kikusui	AC40MA	LM003232	2012/03/14
20	Test Analyzer	Kikusui	KHA1000	LM003720	2012/03/14
21	Line Impedence Network	Kikusui	LIN40MA-PCR-L	LM002352	2012/03/14
22	ESD Tester	Kikusui	KES4021	LM003537	2012/03/14
23	EMC PRO System	EM Test	UCS-500-M4	V0648102026	2012/03/14
24	Signal Generator	IFR	2032	203002/100	2012/03/14
25	Amplifier	A&R	150W1000	301584	2012/03/14
26	CDN	FCC	FCC-801-M2-25	47	2012/03/14
27	CDN	FCC	FCC-801-M3-25	107	2012/03/14
28	EM Injection Clamp	FCC	F-203I-23mm	403	2012/03/14
29	RF Cable	MIYAZAKI	N/A	No.1/No.2	2012/03/14
30	Universal Radio Communication Tester	ROHDE&SCHWARZ	CMU200	0304789	2012/03/14
31	Telecommunication Antenna	European Antennas	PSA 75301R/170	0304213	2012/03/14

NOTE: Equipments listed above have been calibrated and are in the period of validation.

5. 47 CFR Part 15 C 15.247 Requirements

5.1 6dB Bandwidth

5.1.1 Definition

Systems using digital modulation techniques may operate in the 902–928 MHz, 2400–2483.5 MHz, and 5725–5850 MHz bands. The minimum 6 dB bandwidth shall be at least 500 kHz.

5.1.2 Test Description

The EUT is powered by AC/DC adapter, is coupled to the Spectrum Analyzer (SA) through the Attenuator/DC Block. The path loss as the factor is calibrated to correct the reading. During the measurement, the EUT is activated and is set to operate at maximum power. The RF load attached to the EUT antenna terminal is 50Ohm.

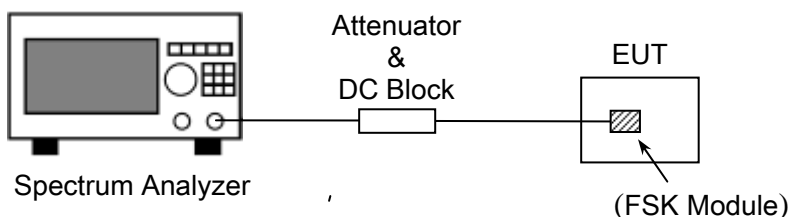

Figure 1: RF Test Setup

5.1.3 Test Result

The lowest, middle and highest channels are selected to perform testing to record the 6 dB bandwidth of the Module.

5.1.3.1 Test Mode

The minimum occupied bandwidth for the fundamental frequency 2478MHz is 505KHz>500KHz. This occupied bandwidth complies with the FCC requirement.

A. Test Verdict:

Channel	Frequency (MHz)	6 dB Bandwidth (KHz)	Limits (kHz)	Result
1	2402	515	≥ 500	PASS
9	2440	518	≥ 500	PASS
18	2478	505	≥ 500	PASS

B. Test Plot:

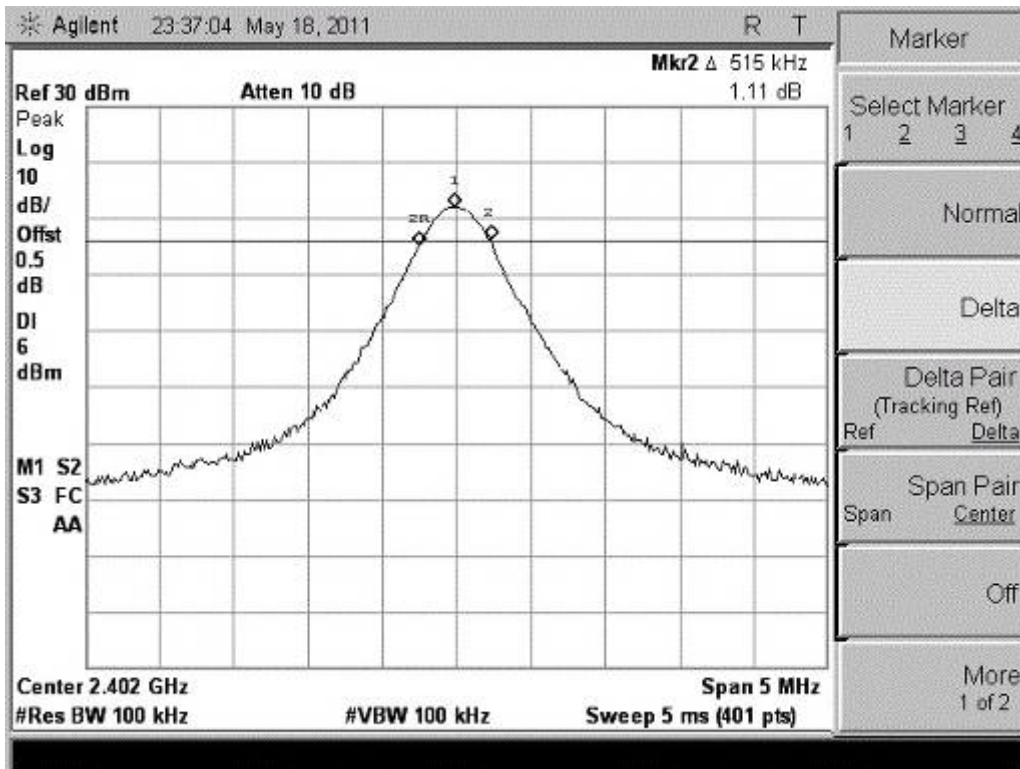

(CH Low)

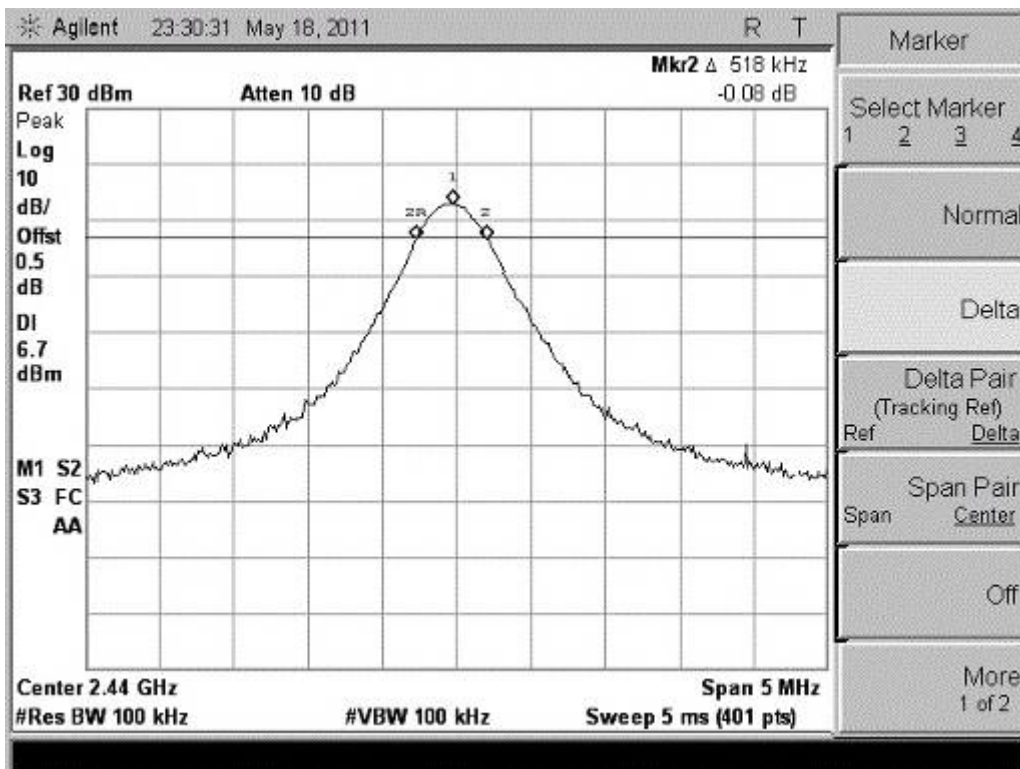

(CH Mid)

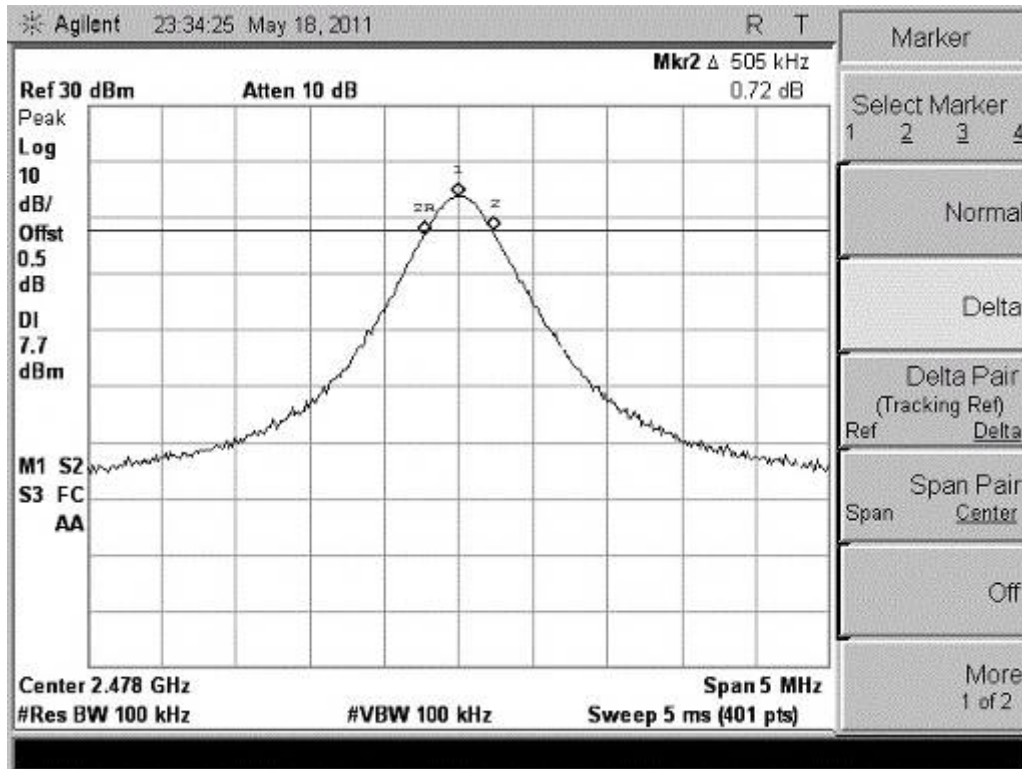

(CH High)

C. Band Edge:

Test Result:

Test Mode	Channel Marked Frequency	Test Result Highest Emission (dBuV/m)			
		Horizontal		Vertical	
		Peak	Average	Peak	Average
Low Channel	2300MHz	62.48	40.10	62.56	40.08
	2400MHz	62.52	40.11	62.58	40.12
High Channel	2483.5MHz	62.78	40.18	62.82	40.21
	2500MHz	62.76	40.21	62.86	40.28

Test Plots:

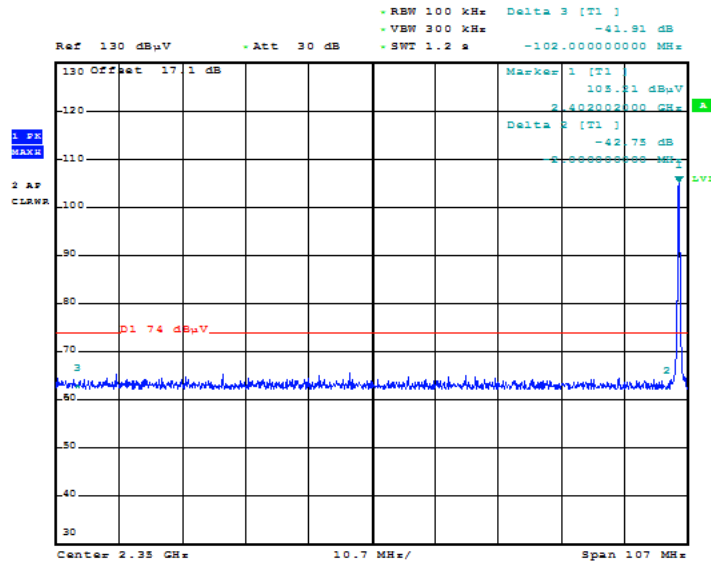

Date: 27.MAY.2011 18:49:00

(Low CH, Peak, Vertical)

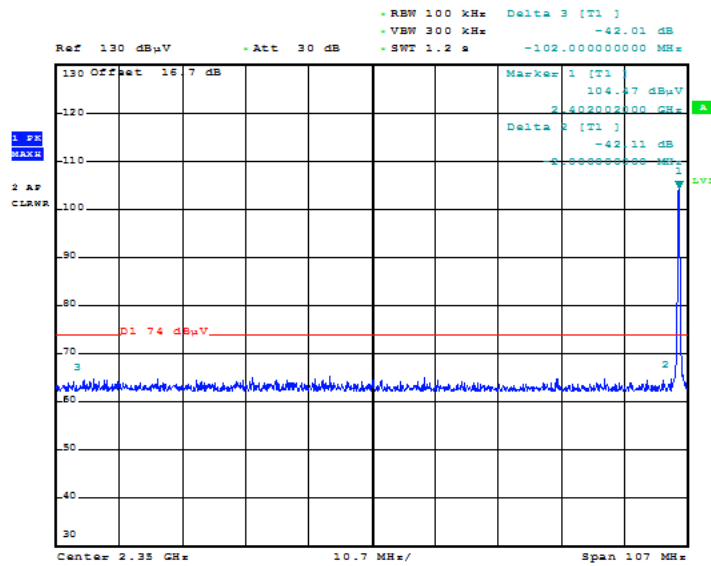

Date: 27.MAY.2011 18:50:23

(Low CH, Peak, Horizontal)

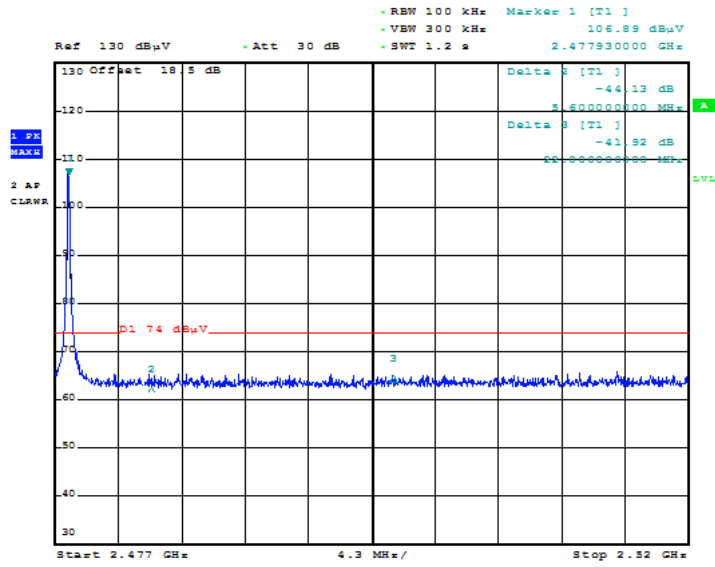

Date: 27.MAY.2011 18:39:20

(High CH, Peak, Vertical)

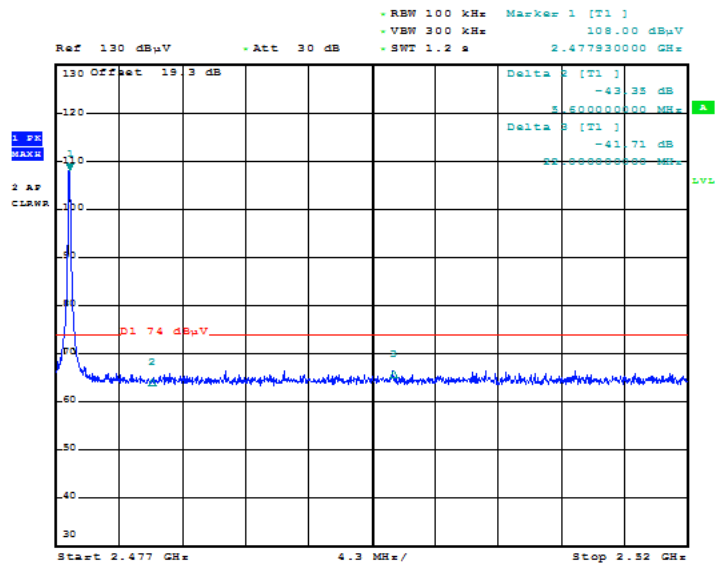

Date: 27.MAY.2011 18:38:07

(High CH, Peak, Horizontal)

Conclusion: PASS

5.2 Peak Output Power

5.2.1 Definition

For systems using digital modulation in the 902–928 MHz, 2400–2483.5 MHz, and 5725–5850 MHz bands: 1 Watt. As an alternative to a peak power measurement, compliance with the one Watt limit can be based on a measurement of the maximum conducted output power.

5.2.2 Test Description

See section 5.1.2 of this report.

5.2.3 Test Result

The EUT operates at maximum output power mode. The lowest, middle and highest channels are selected to perform testing to verify the conducted RF output peak power of the Module.

5.2.3.1 Test Mode

The maximum output power for the fundamental frequency 2478MHz is 14.25dBm. This power complies with the FCC requirement.

A. Test Verdict:

Channel	Frequency (MHz)	Measured Output Peak Power		Limit		Verdict
		dBm	W	dBm	W	
1	2402	11.13	0.0130	30	1	PASS
9	2440	11.07	0.0128			PASS
18	2478	11.25	0.0133			PASS

B. Test Plot:

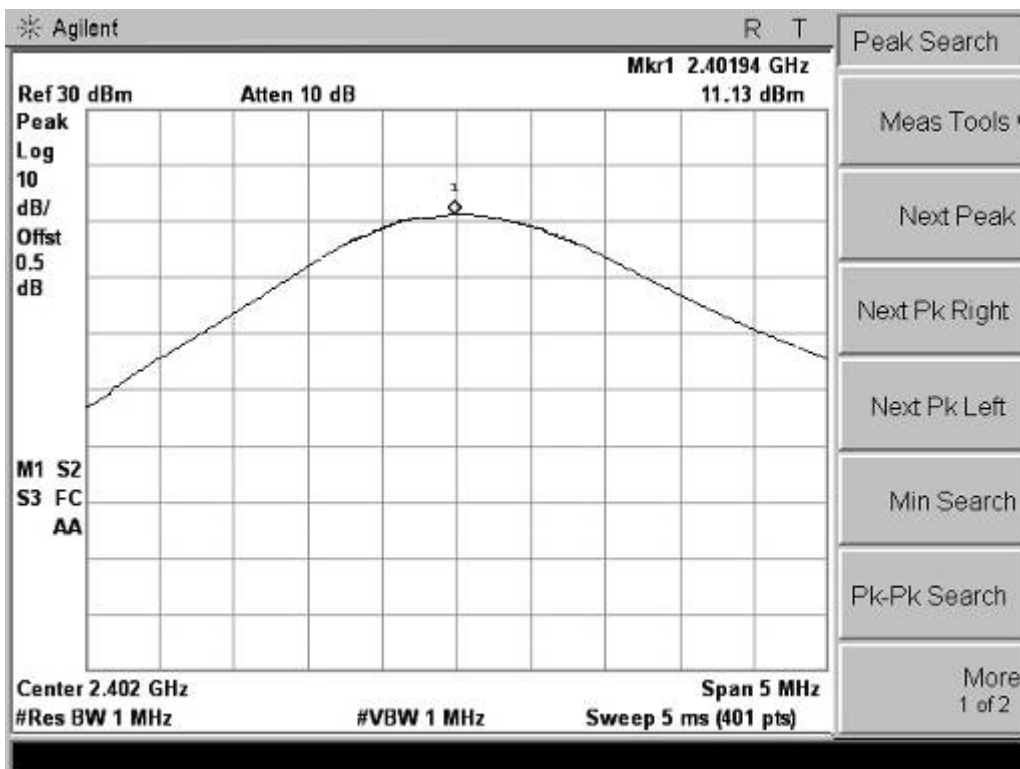

(CH Low)

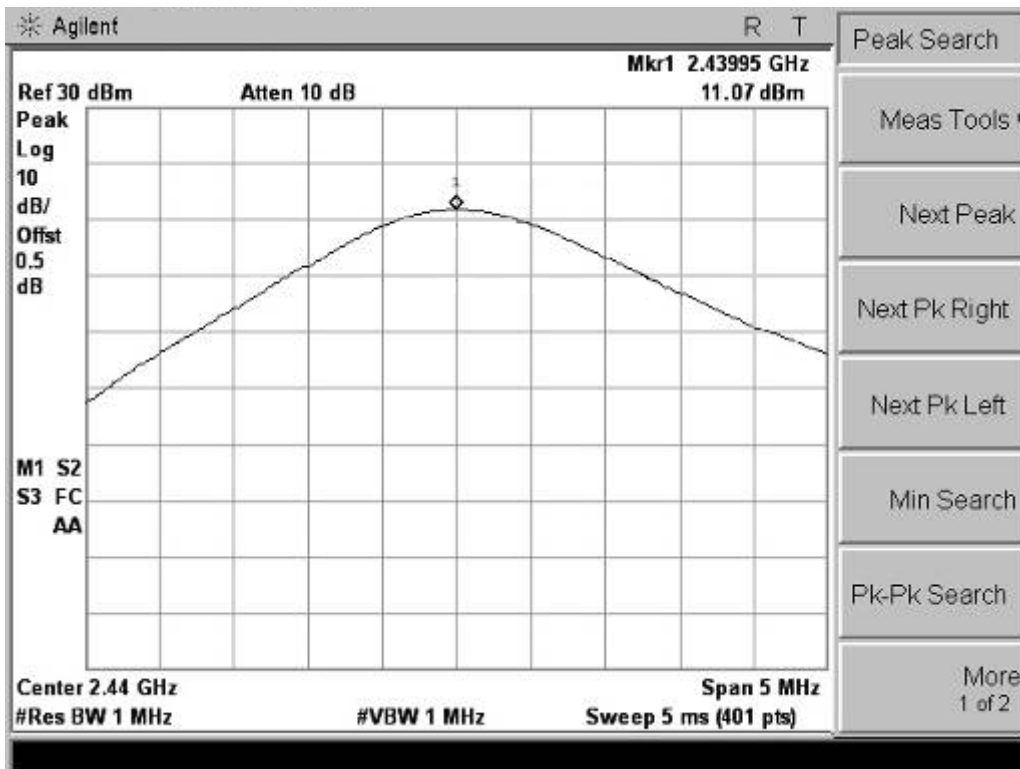

(CH Mid)

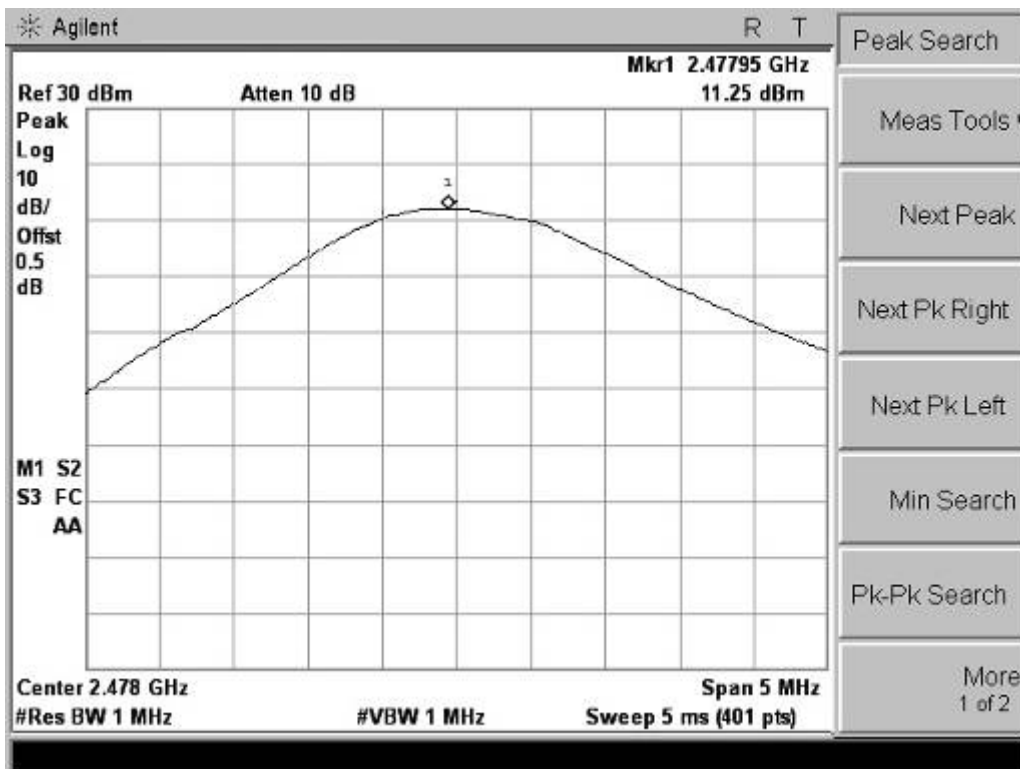

(CH High)

Conclusion: PASS

5.3 Conducted Spurious Emission

5.3.1 Definition

In any 100 kHz bandwidth outside the frequency band in which the spread spectrum or digitally modulated intentional radiator is operating, the radio frequency power that is produced by the intentional radiator shall be at least 20 dB below that in the 100 kHz bandwidth within the band that contains the highest level of the desired power, based on either an RF conducted or a radiated measurement, provided the transmitter demonstrates compliance with the peak conducted power limits.

5.3.2 Test Description

See section 5.1.2 of this report.

5.3.3 Test Result

The measurement frequency range is from 30MHz to the 10th harmonic of the fundamental frequency. The lowest, middle and highest channels are tested to verify the spurious emissions.

5.3.3.1 Test Mode

Test Plot:

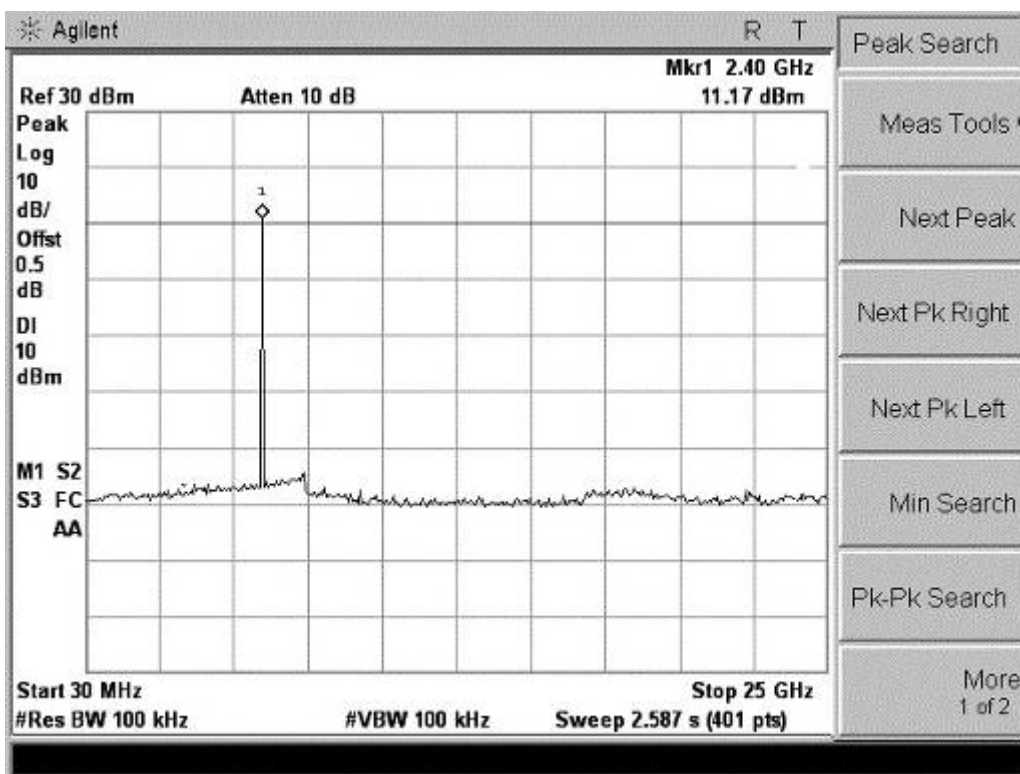

(CH Low, 30MHz to 25GHz)

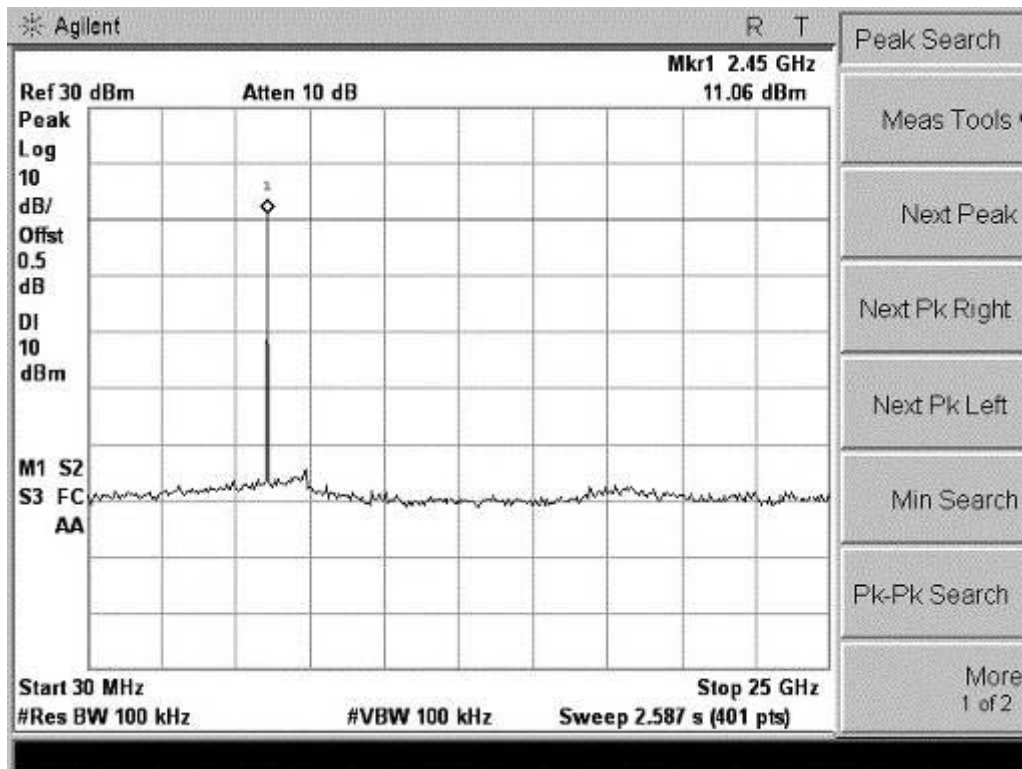

(CH Mid, 30MHz to 25GHz)

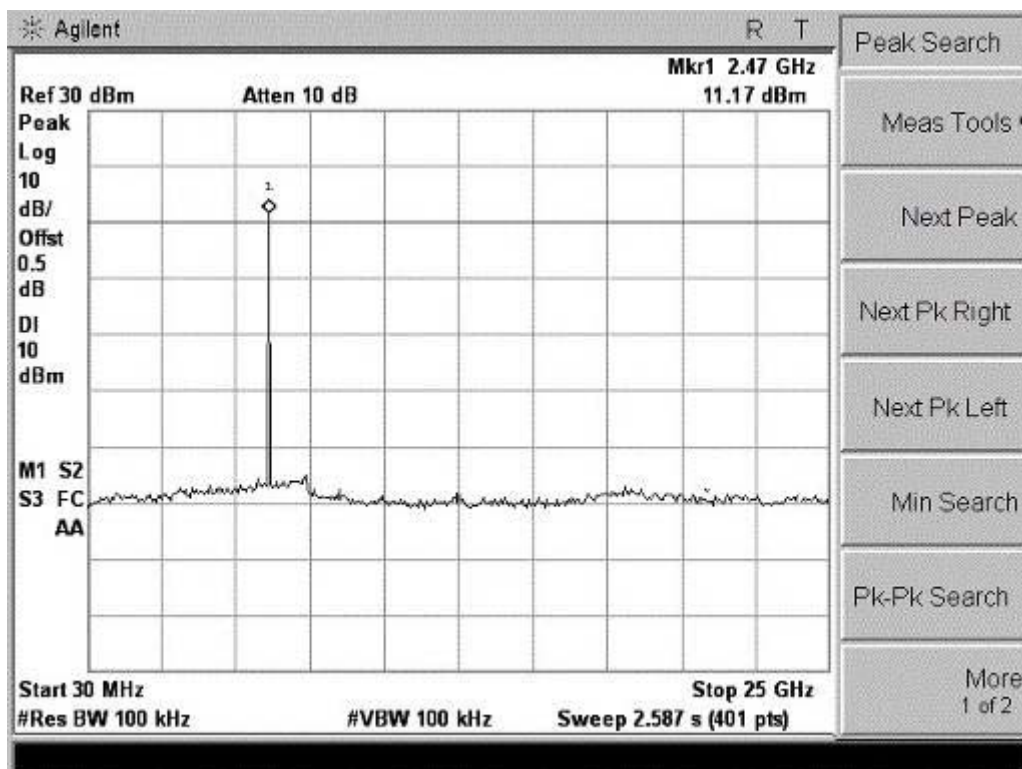

(CH High, 30MHz to 25GHz)

Note:

- 1. The power of the Module transmitting frequency should be ignored.

Conclusion: PASS

5.4 Power Spectral Density (PSD)

5.4.1 Definition

For digitally modulated systems, the power spectral density conducted from the intentional radiator to the antenna shall not be greater than 8 dBm in any 3 kHz band during any time interval of continuous transmission.

5.4.2 Test Description

See section 5.1.2 of this report.

5.4.3 Test Result

The lowest, middle and highest channels are tested to verify the power spectral density.

5.4.3.1 Test Mode

A. Test Verdict:

Channel	Frequency (MHz)	PSD (dBm)	Limits(dBm)	Result
1	2402	-24.68	≤8	PASS
9	2440	-24.02	≤8	PASS
18	2478	-23.51	≤8	PASS

B. Test Plot:

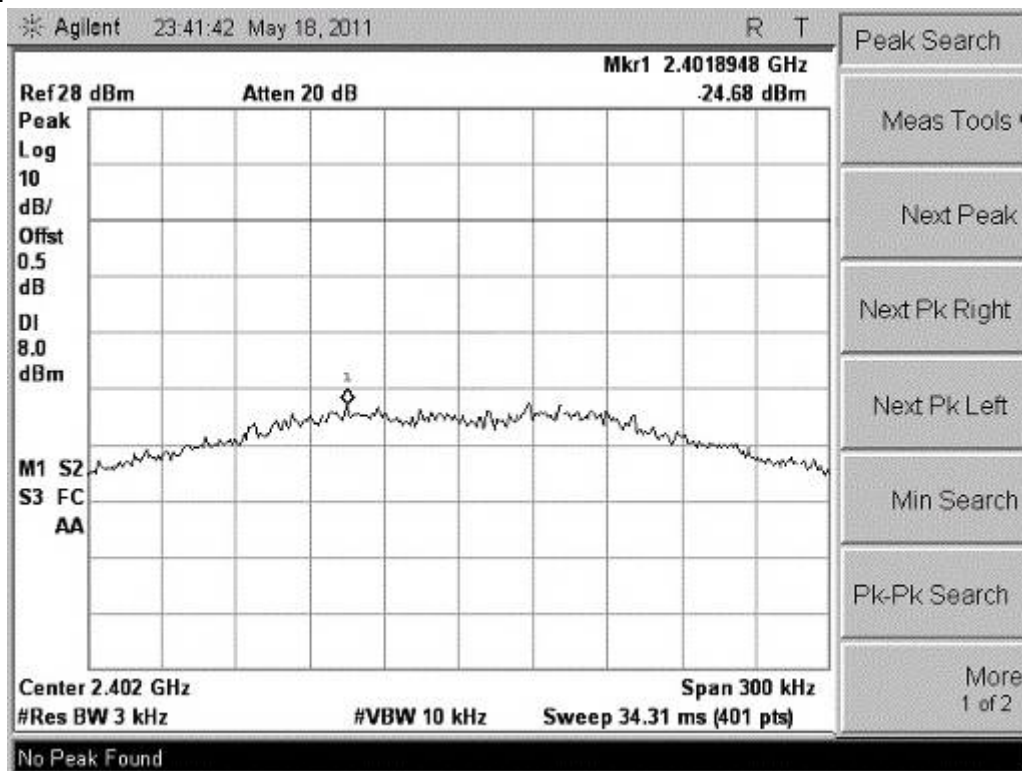

(CH Low)

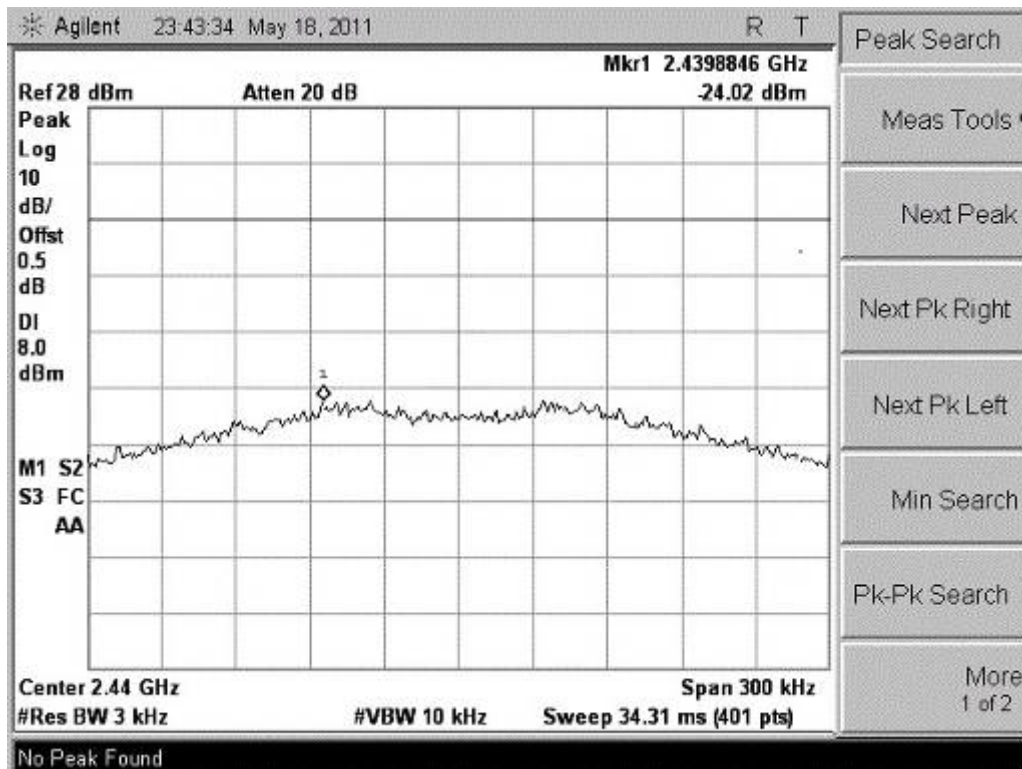

(CH Mid)

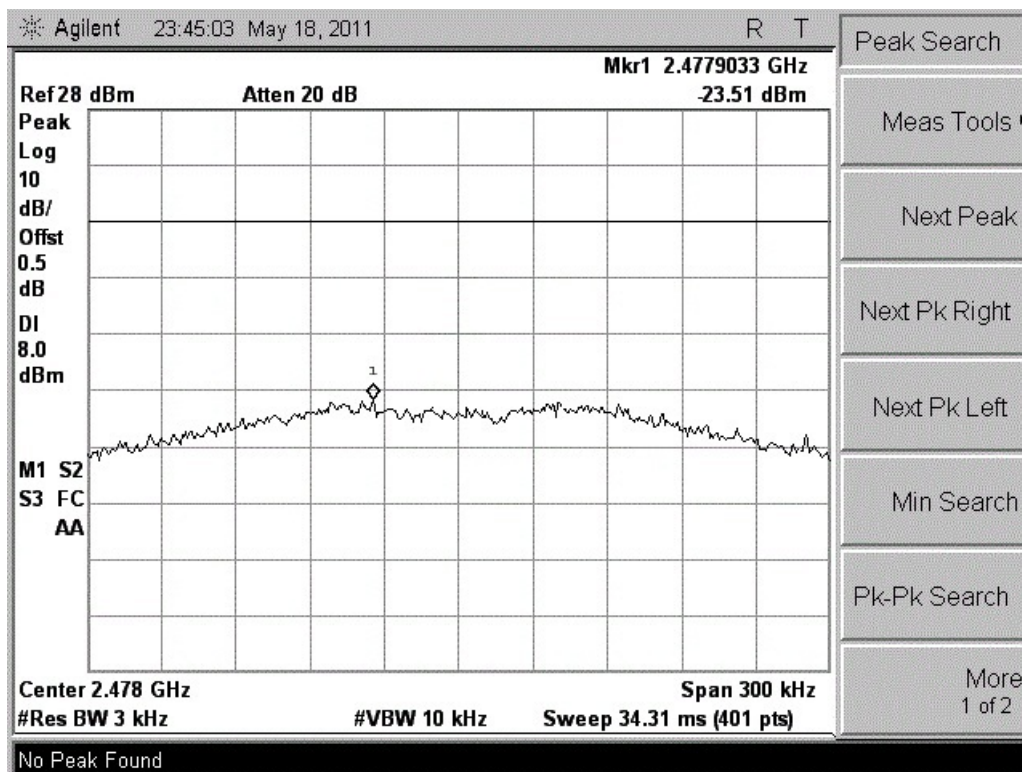

(CH High)

Conclusion: PASS

5.5 Conducted Emission

5.5.1 Definition

According to FCC section 15.207, for an intentional radiator that is designed to be connected to the public utility (AC) power line, the radio frequency voltage that is conducted back onto the AC power line on any frequency or frequencies, within the band 150 kHz to 30 MHz, shall not exceed the limits in the following table, as measured using a 50 μH/50 ohms line impedance stabilization network (LISN).

Frequency	Maximum RF Line Voltage	
	Q.P.(dBuV)	Average(dBuV)
150kHz-500kHz	66-56	56-46
500kHz-5MHz	56	46
5MHz-30MHz	60	50

Note:

1. The lower limit shall apply at the transition frequency.
2. The limit decreases linearly with the logarithm of the frequency in the range 0.15 MHz to 0.50 MHz

5.5.2 Test Description

The EUT is powered by the Battery charged with the AC Adapter which is powered by 120V, 60Hz AC mains supply. The path loss as the factor is calibrated to correct the reading. During the measurement, the EUT is activated and is set to operate at maximum power.

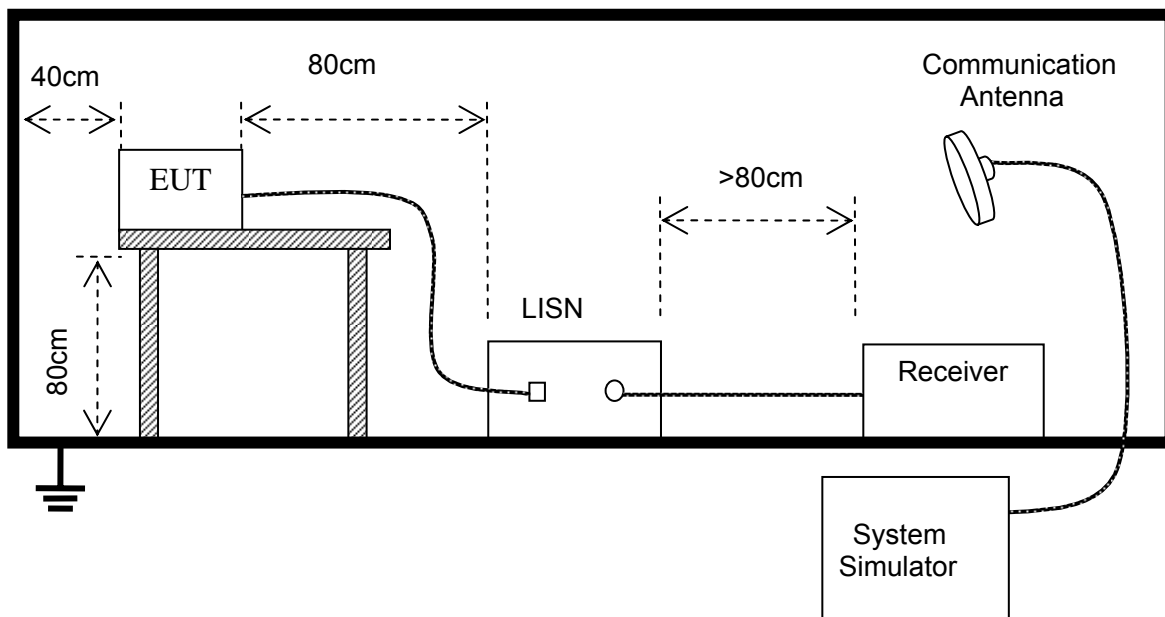

5.5.3 Test Result

A scan was taken on both power lines, Line 1 and Line 2, recording at least the six highest emissions. Emission frequency and amplitude were recorded into a computer in which correction factors were used to calculate the emission level and compare reading to the applicable limit. If EUT emission level was less -2dB to the A.V. limit in Peak mode, then the emission signal was re-checked using Q.P and Average detector.



Address: No.5, Langshan 2nd Rd., North Hi-Tech Industrial park
 Guangdong, China
 Tel: 0755-86170306 Fax: 0755-86170310

Conducted Emission Measurement

File: PD170766 Date: #1 Date: 2011.05/16 Time: 15:50:16

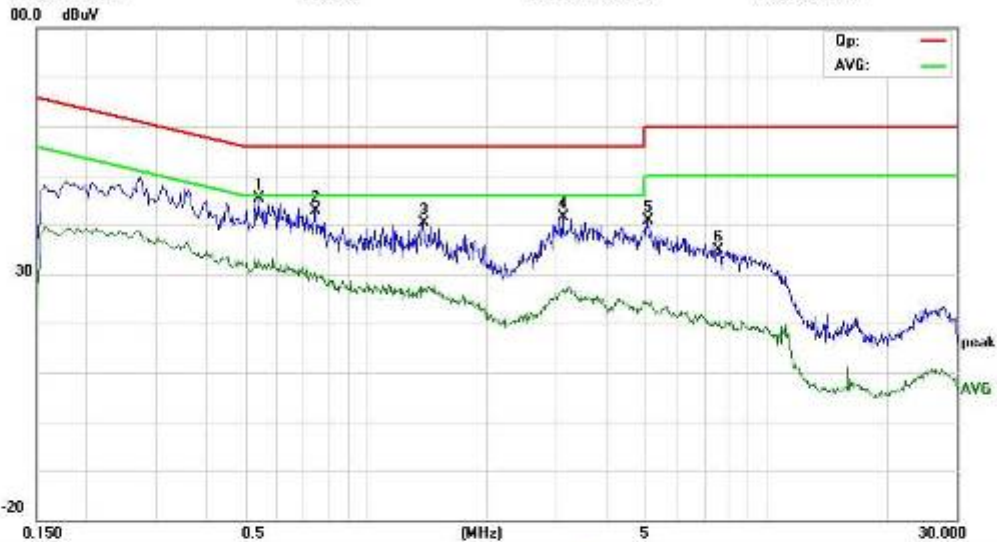

Site: site #1 Phase: **N** Temperature: 26
 Limit: FCC Part 15 B Class B QP Power: AC 120V/60Hz Humidity: 60 %
 EUT: VIDEO BABY MONITOR
 M/N: PD170766
 Mode: NORMAL WORKING
 Note:

No.	Mk.	Freq. MHz	Reading Level dBuV	Correct Factor dB	Measure- ment dBuV	Limit dBuV	Over dB	Detector	Comment
1	*	0.5380	35.27	10.00	45.27	58.00	-10.73	peak	
2		0.7460	32.98	10.00	42.98	58.00	-13.02	peak	
3		1.3820	30.76	9.62	40.38	58.00	-15.62	peak	
4		3.1140	31.52	10.11	41.63	58.00	-14.37	peak	
5		5.0380	28.85	11.98	40.83	60.00	-19.17	peak	
6		7.5820	24.38	10.45	34.83	60.00	-25.17	peak	

*Maximum data x:Over limit l:over margin



Address: No.5, Langshan 2nd Rd., North Hi-Tech Industrial park
 Guangdong, China
 Tel: 0755-86170306 Fax: 0755-86170310

Conducted Emission Measurement

File: PD170766 Date: #2 Date: 2011.05/16 Time: 15:52:48

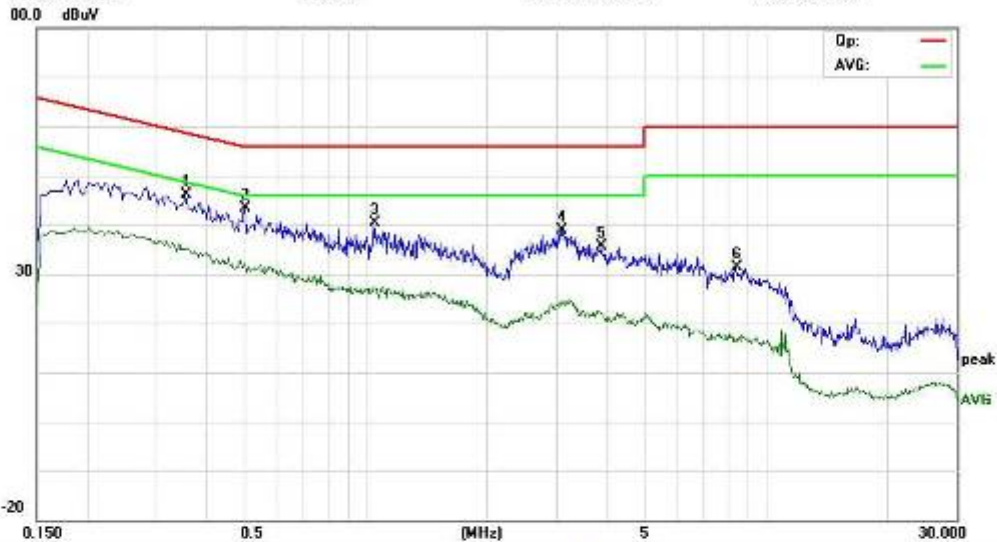

Site: site #1 Phase: L1 Temperature: 26
 Limit: FCC Part 15 B Class B QP Power: AC 120V/60Hz Humidity: 60 %
 EUT: VIDEO BABY MONITOR
 M/N: PD170766
 Mode: NORMAL WORKING
 Note:

No.	Mk.	Freq. MHz	Reading Level dBuV	Correct Factor dB	Measure- ment dBuV	Limit dBuV	Over dB	Detector	Comment
1		0.3540	35.04	10.97	46.01	58.87	-12.86	peak	
2	*	0.4980	33.47	10.01	43.48	58.03	-12.55	peak	
3		1.0460	30.38	9.95	40.33	56.00	-15.67	peak	
4		3.0820	28.80	10.08	38.88	56.00	-17.12	peak	
5		3.8700	24.69	10.87	35.56	56.00	-20.44	peak	
6		8.3780	21.42	9.97	31.39	60.00	-28.61	peak	

*:Maximum data x:Over limit l:over margin

Conclusion: PASS

5.6 Radiated Emission

5.6.1 Definition

According to FCC section 15.247(d), radiated emission outside the frequency band attenuation below the general limits specified in § 15.209(a) is not required. In addition, radiated emissions which fall in the restricted bands, as defined in § 15.205(a), must also comply with the radiated emission limits specified in § 15.209(a) (see § 15.205(c)).

According to FCC section 15.209 (a), except as provided elsewhere in this subpart, the emissions from an intentional radiator shall not exceed the field strength levels specified in the following table:

Frequency (MHz)	Field Strength ($\mu\text{V}/\text{m}$)	Measurement Distance (m)
0.009 - 0.490	2400/F(kHz)	300
0.490 - 1.705	24000/F(kHz)	30
1.705 - 30.0	30	30
30 - 88	100	3
88 - 216	150	3
216 - 960	200	3
Above 960	500	3

As shown in FCC section 15.35(b), for frequencies above 1000MHz, the field strength limits are based on average detector. When average radiated emission measurements are specified in this part, including emission measurements below 1000MHz, there also is a limit on the radio frequency emissions, as measured using instrumentation with a peak detector function, corresponding to 20dB above the maximum permitted average limit for the frequency being investigated unless a different peak emission limit is otherwise specified in the rules.

5.6.2 Test Description

A. Test Setup:

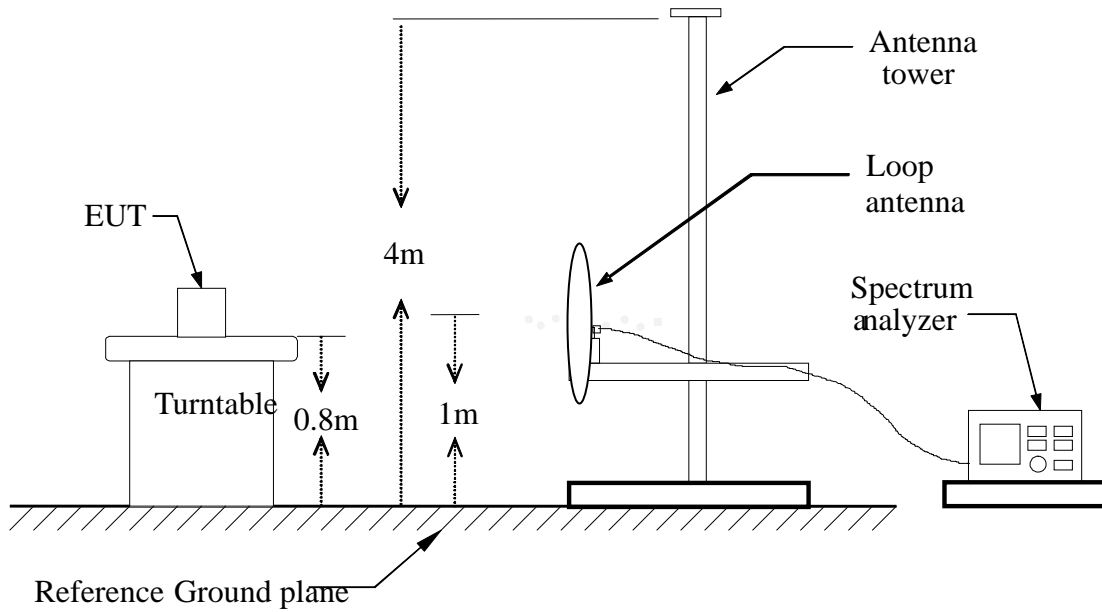

Blow 1GHz:

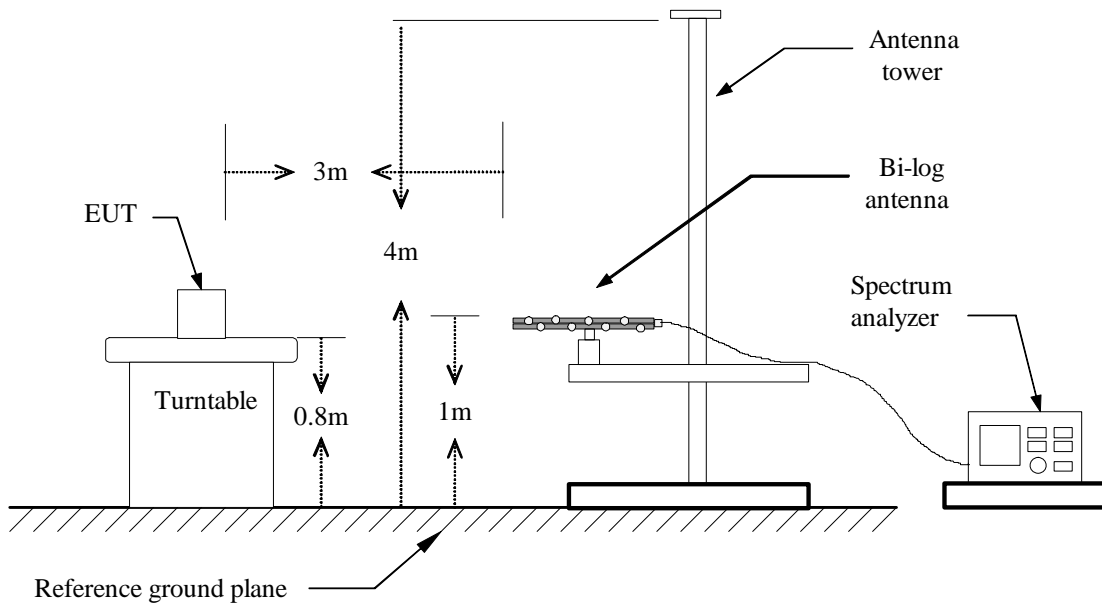

Above 1GHz:

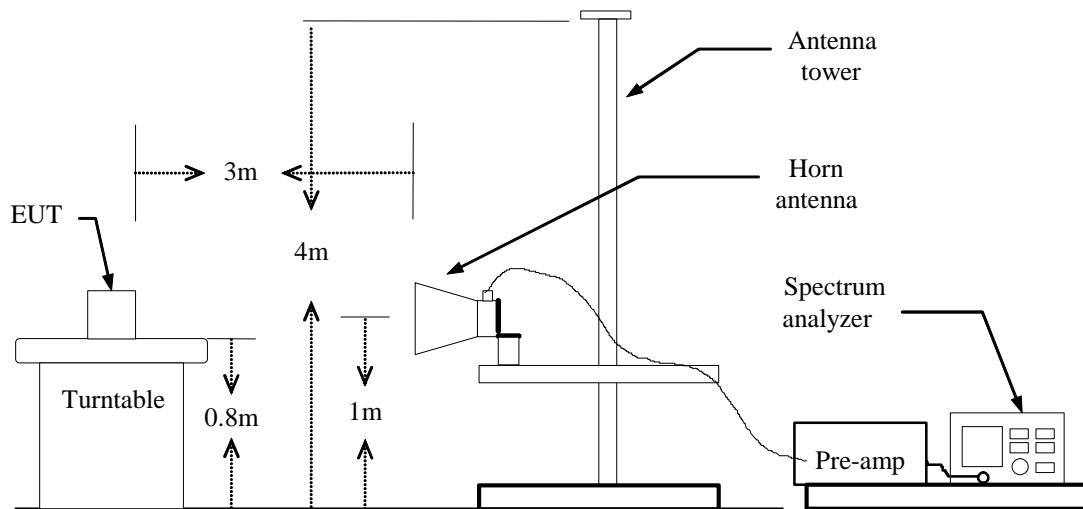

B. Test procedures

1. The EUT is placed on a turntable, which is 0.8m above ground plane.
2. The turntable shall be rotated for 360 degrees to determine the position of maximum emission level.
3. EUT is set 3m away from the receiving antenna, which is varied from 1m to 4m to find out the highest emissions.
4. Maximum procedure was performed on the six highest emissions to ensure EUT compliance.
5. And also, each emission was to be maximized by changing the polarization of receiving antenna both horizontal and vertical.
6. Set the spectrum analyzer in the following setting as:
 Below 1GHz: RBW=100 kHz / VBW=300 kHz / Sweep=AUTO
 Above 1GHz : (a) PEAK: RBW=VBW=1MHz / Sweep=AUTO
 (b) AVERAGE: RBW=1MHz / VBW=10Hz / Sweep=AUTO
7. Repeat above procedures until the measurements for all frequencies are complete.

5.6.3 Test Result

Below 1 GHz



Address No.5,Langshan 2nd Rd., North Hi-Tech Industrial park
Guangdong,China
Tel: 0755-86170306 Fax: 0755-86170310

Radiated Emission Measurement

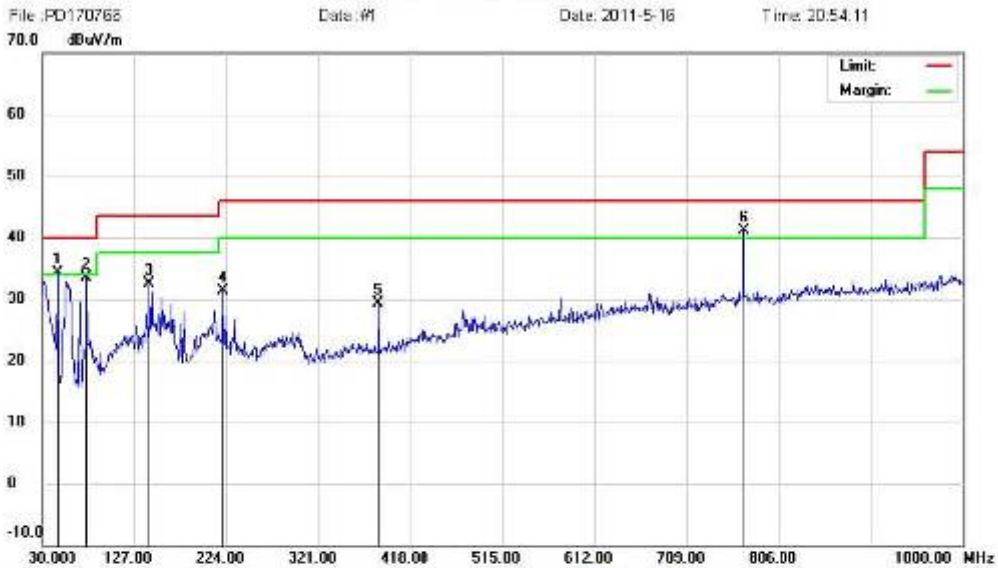

Site: site MOST 3M
Limit: FCC Part15 B 3M Radiation
EUT: VIDEO BABY MONITOR
MN: PD170766
Mode: NORMAL WORKING
Note:

Polarization: **Vertical**
Power: AC120V/60Hz
Temperature: 26
Humidity: 61 %
Distance:

No.	Mk.	Freq. MHz	Reading Level dBuV	Correct Factor dB	Measure- ment dBuV/m	Limit dBuV/m	Over dB	Detector	Antenna Height cm	Table Degree	Comment
1	I	46.4900	21.42	12.91	34.33	40.00	-5.67	peak			
2		77.5300	22.04	11.52	33.56	40.00	-6.44	peak			
3		143.4900	15.44	16.99	32.43	43.50	-11.07	peak			
4		220.1200	14.92	16.30	31.22	46.00	-14.78	peak			
5		384.0500	11.04	18.18	29.22	46.00	-16.78	peak			
6	*	788.1700	15.16	25.86	41.02	46.00	-4.98	peak			

*:Maximum data x:Over limit I:over margin



Address: No.5, Langshan 2nd Rd., North Hi-Tech Industrial park
 Guangdong, China
 Tel: 0755-86170306 Fax: 0755-86170310

Radiated Emission Measurement

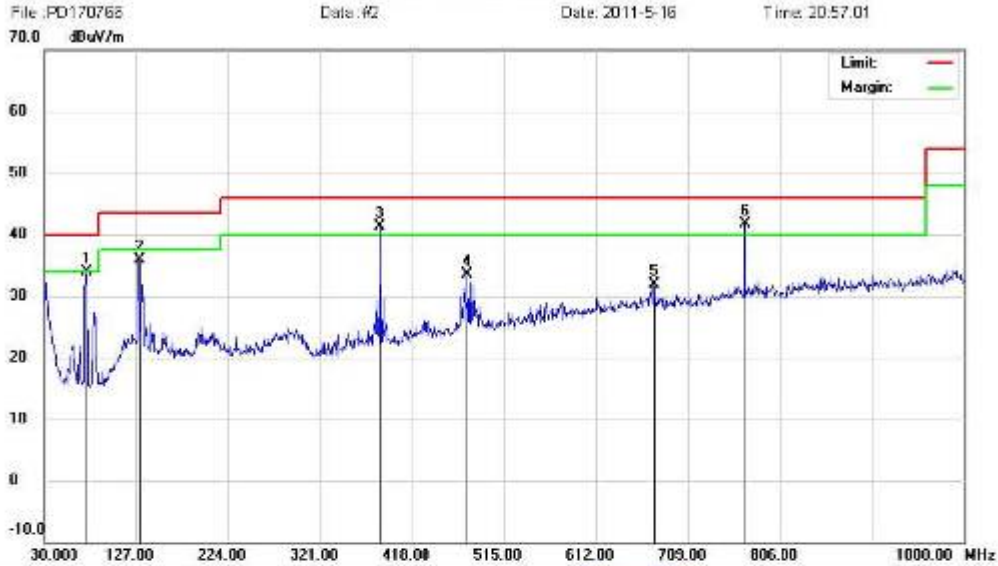

Site: site MOST 3M Polarization: **Horizontal** Temperature: 26
 Limit: FCC Part15 B 3M Radiation Power: AC 120V/60Hz Humidity: 61 %
 EUT: VIDEO BABY MONITOR Distance:
 MN: PD170766
 Mode: NORMAL WORKING
 Note:

No.	Mk.	Freq. MHz	Reading Level dBuV	Correct Factor dB	Measure- ment dBuV/m	Limit dBuV/m	Over dB	Detector	Antenna Height cm	Table Degree	Comment
1		75.5899	22.38	11.62	33.98	40.00	-6.02	peak			
2		129.9100	18.26	17.70	35.96	43.50	-7.54	peak			
3	I	384.0500	23.07	18.18	41.25	46.00	-4.75	peak			
4		477.1700	11.88	21.53	33.41	46.00	-12.59	peak			
5		672.1400	7.30	24.52	31.82	46.00	-14.18	peak			
6	*	788.1700	15.81	25.86	41.67	46.00	-4.33	peak			

*:Maximum data x:Over limit l:over margin

Operation Mode: TX/ CH Mid
Temperature: 20°C
Humidity: 70 % RH

Test Date: May. 16, 2011
Tested by: Petter Ping
Polarity: Ver. / Hor.

Freq. (MHz)	Ant. Pol H/V	Peak Reading (dBuV)	AV Reading (dBuV)	Ant. / CL CF (dB)	Actual Fs		Peak Limit (dBuV/m)	AV Limit (dBuV/m)	AV Margin (dB)
					Peak (dBuV/m)	AV (dBuV/m)			
4880.50	V	52.35	32.27	17.08	69.43	49.35	74.00	54.00	-4.65
N/A	V								
4880.50	H	46.13	26.65	23.98	70.11	50.63	74.00	54.00	-3.37
N/A	H								

Notes:

1. Measuring frequencies from 1 GHz to the 10th harmonic of highest fundamental frequency.
2. Radiated emissions measured in frequency above 1000MHz were made with an instrument using peak/average detector mode.
3. Average test would be performed if the peak result were greater than the average limit or as required by the applicant.
4. Data of measurement within this frequency range shown " --- " in the table above means the reading of emissions are attenuated more than 20dB below the permissible limits or the field strength is too small to be measured.
5. Measurements above show only up to 6 maximum emissions noted, or would be lesser, with " N/A " remark, if no specific emissions from the EUT are recorded (ie: margin>20dB from the applicable limit) and considered that's already beyond the background noise floor.
6. Margin (dB) = Remark result (dBuV/m) – Average limit (dBuV/m).

Operation Mode: TX/ CH High
Temperature: 20°C
Humidity: 70 % RH

Test Date: May. 16, 2011
Tested by: Petter Ping
Polarity: Ver. / Hor.

Freq. (MHz)	Ant. Pol H/V	Peak Reading (dBuV)	AV Reading (dBuV)	Ant. / CL CF (dB)	Actual Fs		Peak Limit (dBuV/m)	AV Limit (dBuV/m)	AV Margin (dB)
					Peak (dBuV/m)	AV (dBuV/m)			
4956.50	V	52.41	32.77	17.46	69.87	50.23	74.00	54.00	-3.77
N/A	V								
4956.50	H	52.69	33.03	17.46	70.15	50.49	74.00	54.00	-3.51
N/A	H								

Notes:

1. Measuring frequencies from 1 GHz to the 10th harmonic of highest fundamental frequency.
2. Radiated emissions measured in frequency above 1000MHz were made with an instrument using peak/average detector mode.
3. Average test would be performed if the peak result were greater than the average limit or as required by the applicant.
4. Data of measurement within this frequency range shown " --- " in the table above means the reading of emissions are attenuated more than 20dB below the permissible limits or the field strength is too small to be measured.
5. Measurements above show only up to 6 maximum emissions noted, or would be lesser, with " N/A " remark, if no specific emissions from the EUT are recorded (ie: margin>20dB from the applicable limit) and considered that's already beyond the background noise floor.
6. Margin (dB) = Remark result (dBuV/m) – Average limit (dBuV/m).

Conclusion: PASS

APPENDIX 1
PHOTOGRAPHS OF TEST SETUP

CE TEST SETUP



RE TEST SETUP

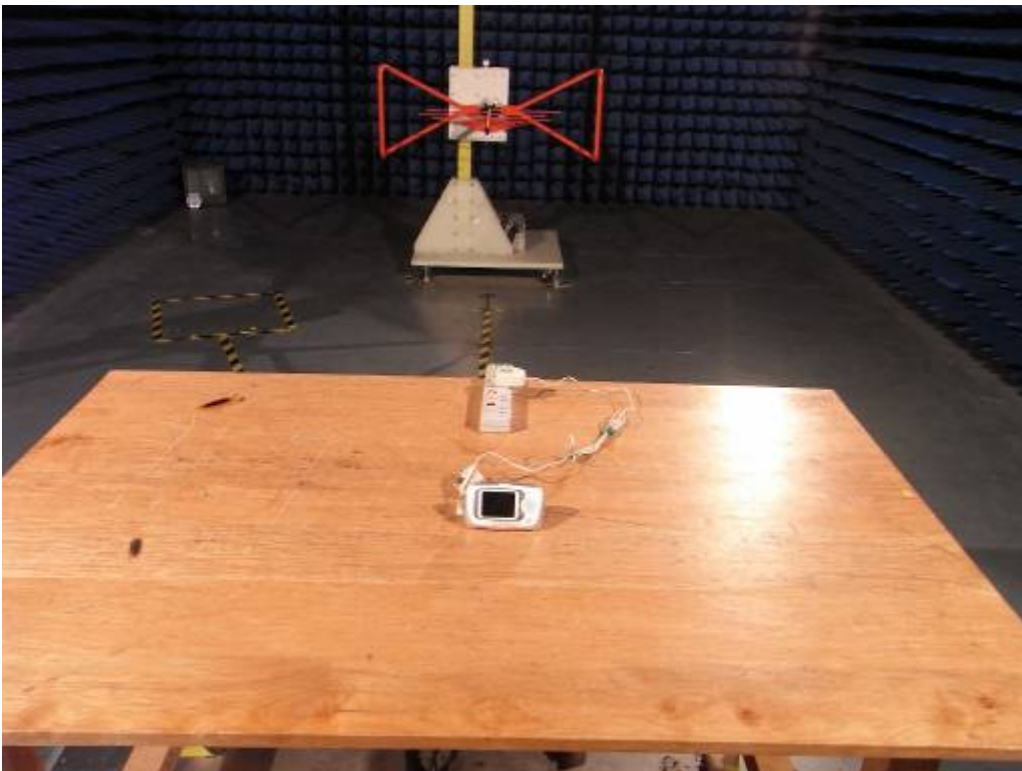

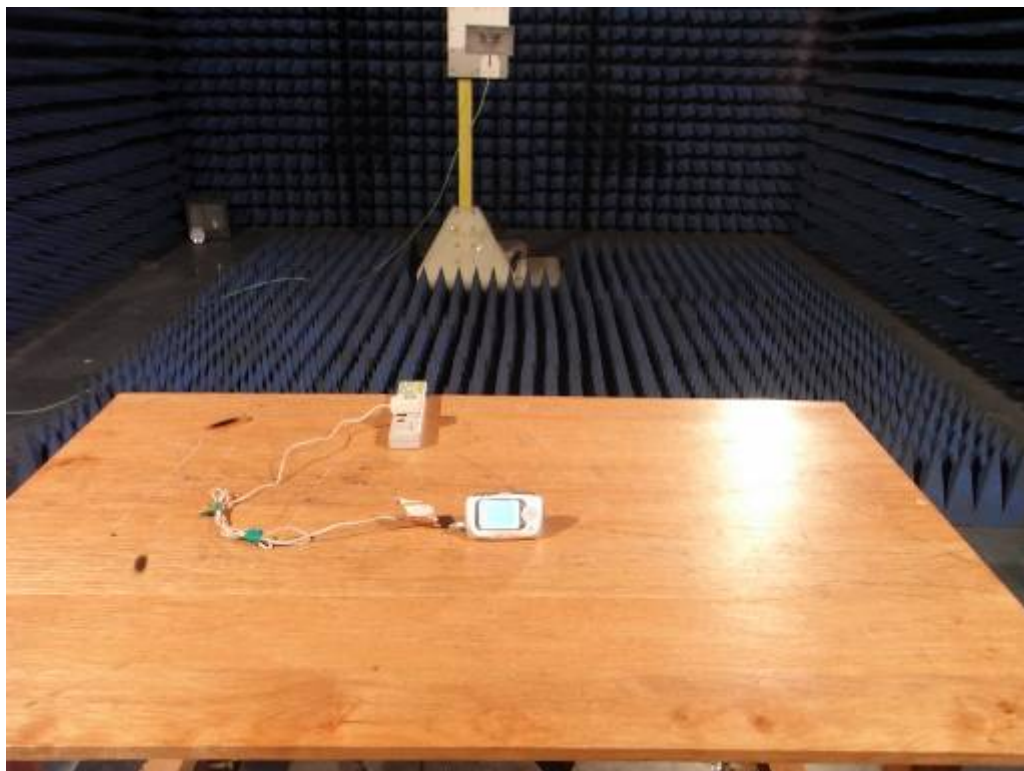

CONDUCTED SPURIOUS EMISSION TEST SETUP



APPENDIX 2
PHOTOGRAPHS OF EUT

FRONT VIEW OF SAMPLE



BACK VIEW OF SAMPLE



LEFT VIEW OF SAMPLE



RIGHT VIEW OF SAMPLE



TOP VIEW OF SAMPLE



BOTTOM VIEW OF SAMPLE



PHOTO OF POWER SUPPLY



PHOTO OF THE ENTIRE SAMPLE



PHOTO OF BATTERY



INTERNAL PHOTO OF SAMPLE - 1

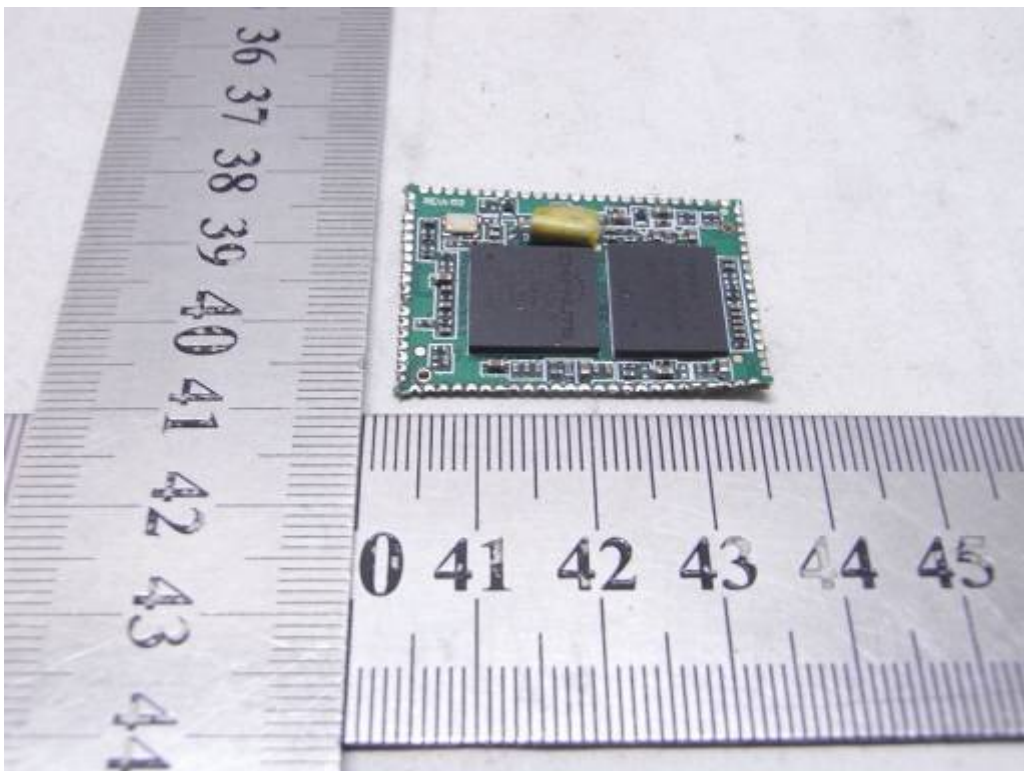

INTERNAL PHOTO OF SAMPLE – 2

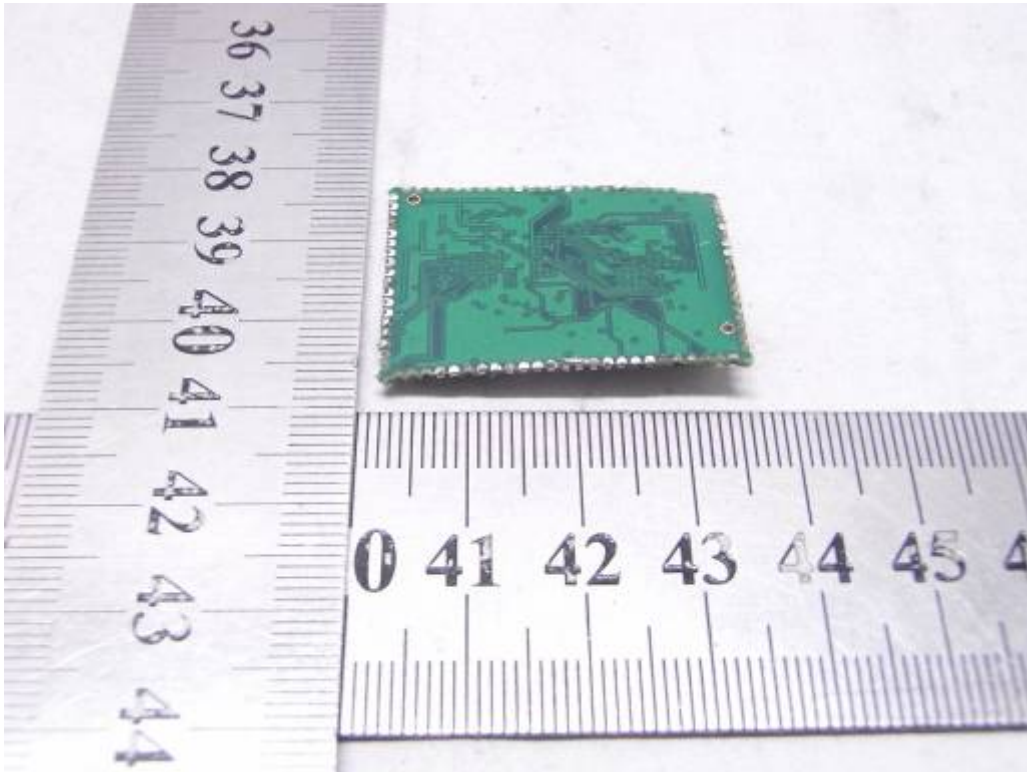

INTERNAL PHOTO OF SAMPLE –3

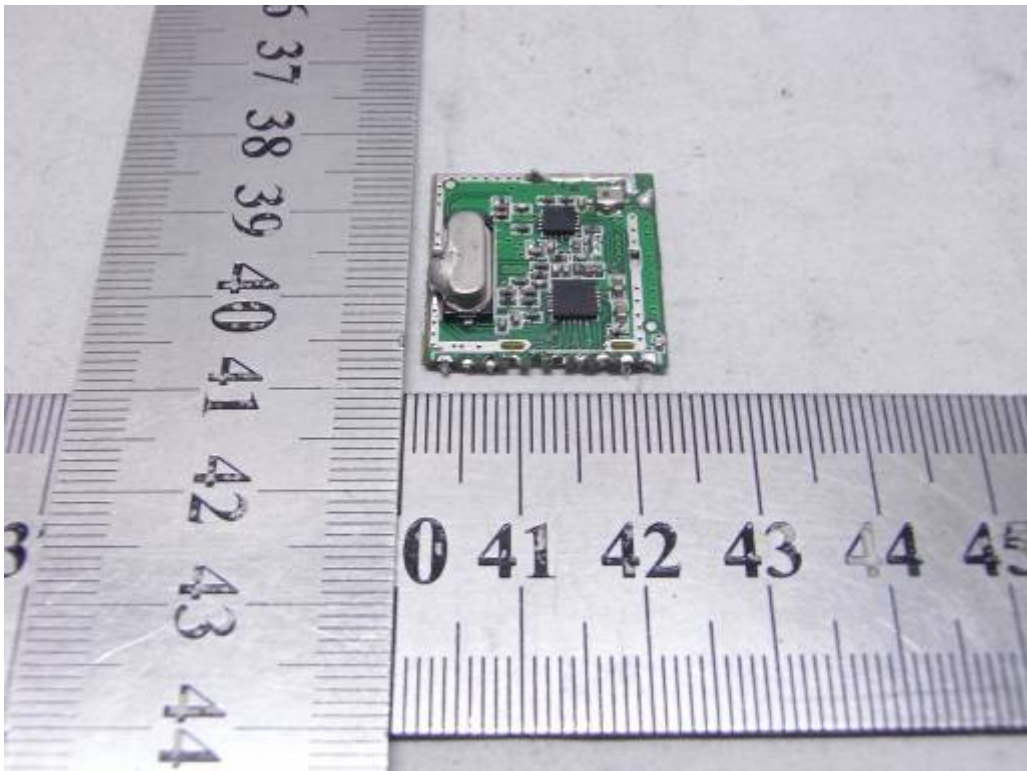

INTERNAL PHOTO OF SAMPLE -4

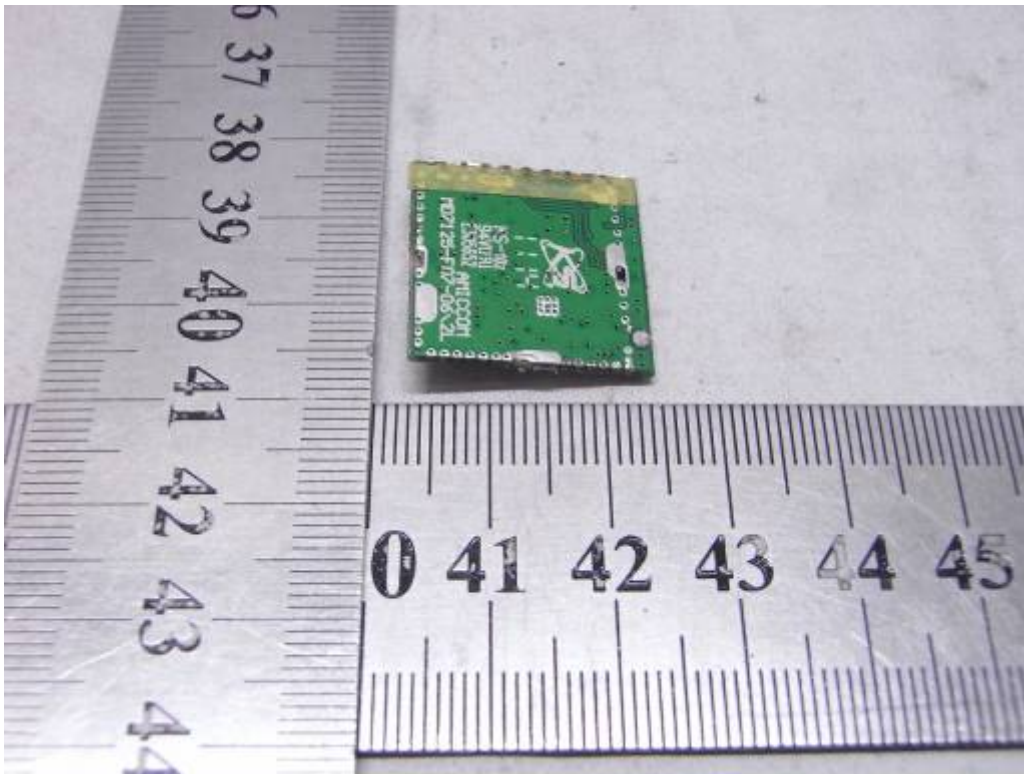

INTERNAL PHOTO OF SAMPLE -5

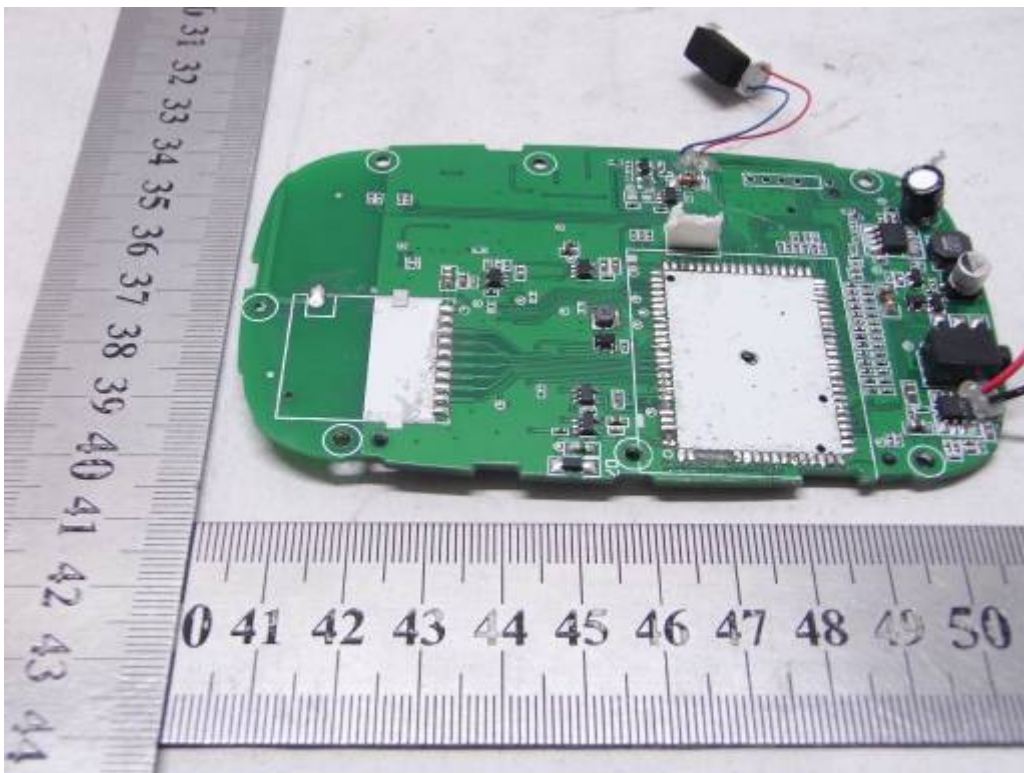

INTERNAL PHOTO OF SAMPLE -6

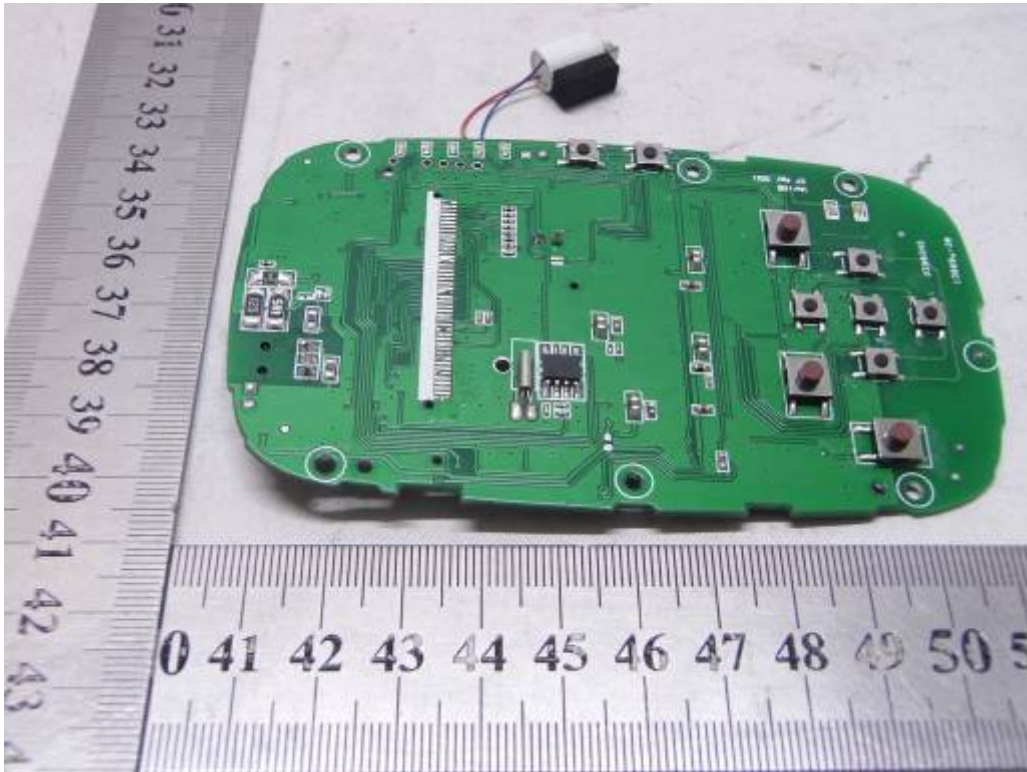

INTERNAL PHOTO OF SAMPLE -7

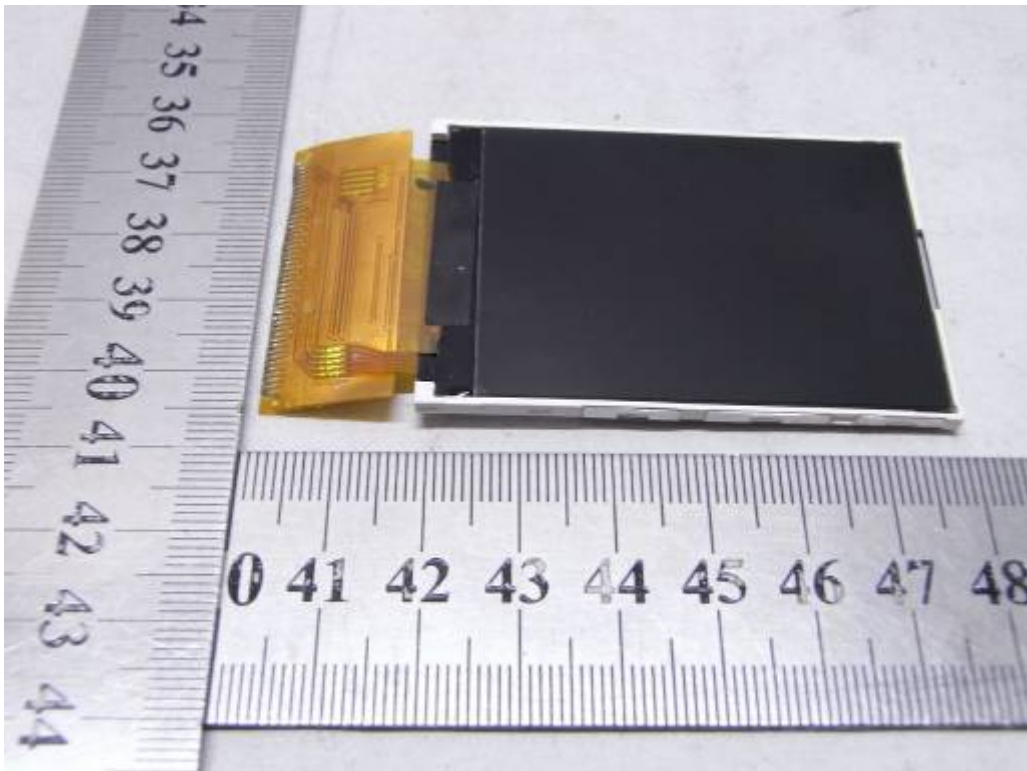

INTERNAL PHOTO OF SAMPLE -8

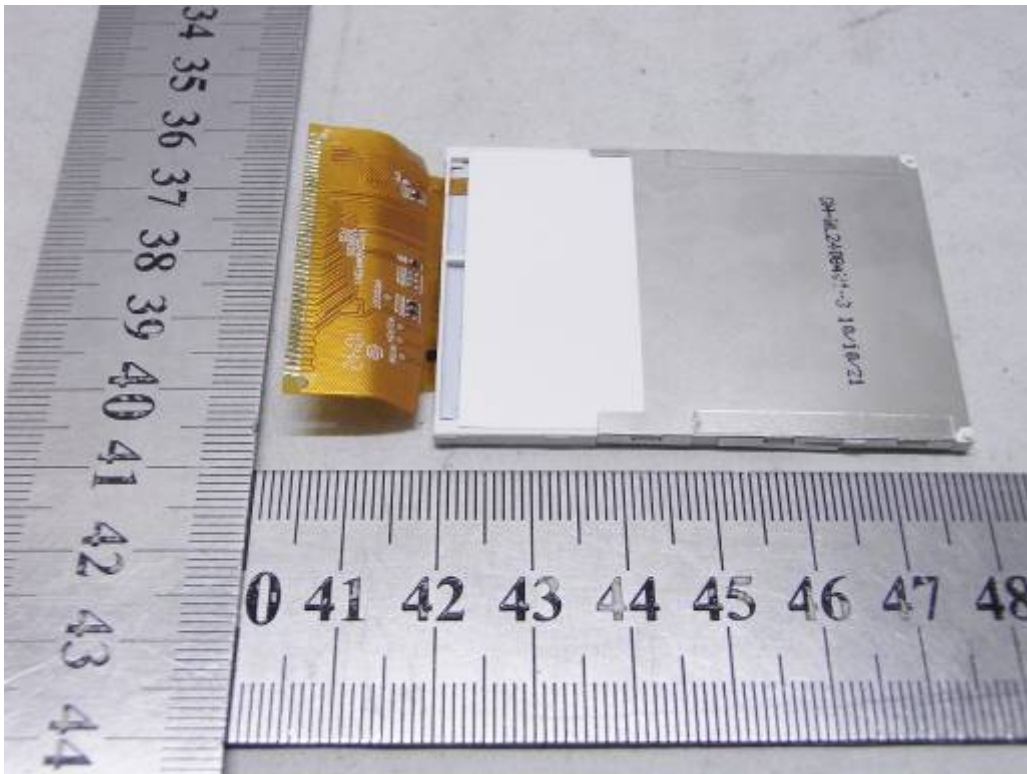

INTERNAL PHOTO OF POWER SUPPLY-1

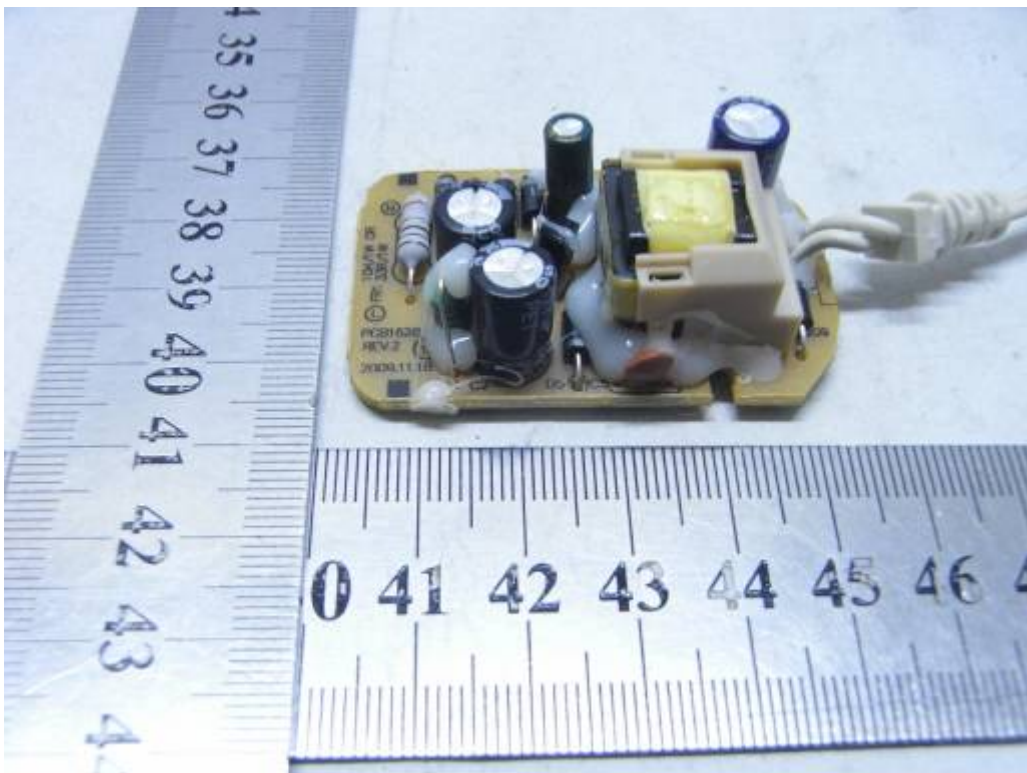

INTERNAL PHOTO OF POWER SUPPLY-2

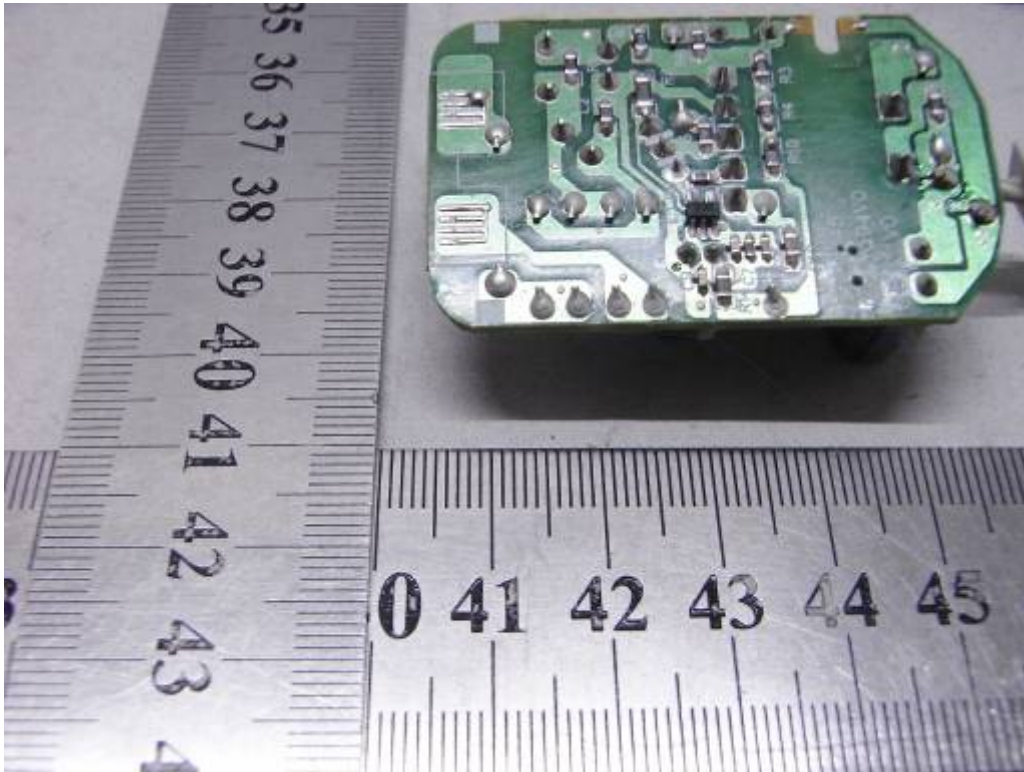

-----END OF REPORT-----