



MT-58 Digital Instrument Transmitter

User Guide

FOR "CERTIFICATION" ONLY



1. Transmitter Part Names:

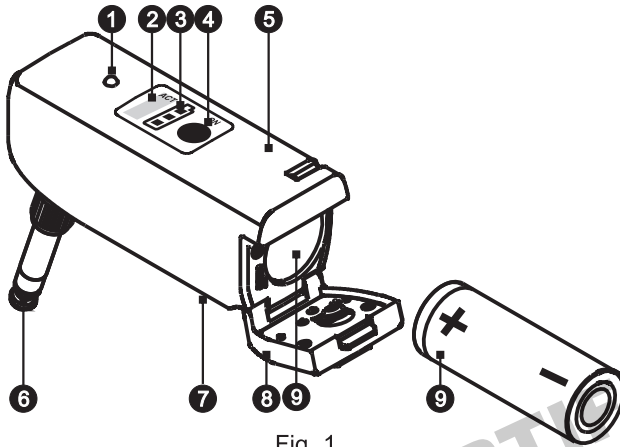

Fig. 1

- ❶ Auto Wakeup Indicator.
- ❷ ACT Sync Port.
- ❸ Battery Level Indicators.
- ❹ Power Button.
- ❺ Housing.
- ❻ 6.3 Ø Input Phone Plug.
- ❼ Battery Charging Contacts.
- ❽ Battery Cover and Battery Negative Pole.

- ❾ Battery Compartment and Rechargeable Battery. Insert plus positive (+) polarity battery towards inside of the compartment.

2. Operating Instructions:

- (A) Power on: Press the power button ❹ and battery indicators ❸ are lit.
- (B) Power off: Press the power button for two seconds and battery indicators are off.
- (C) Battery level indicators, Fig. 2.
- (D) Recommend charging or replace a fully-charged battery when single red indicator remains. Power shutdown automatically when battery voltage is too low.

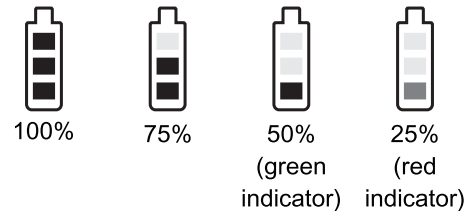

Fig. 2

(E) AutoWakeup, if enabled at the receiver, allows the transmitter to be muted automatically if a powered-on transmitter is idled for approx.10 seconds. Transmitter red indicator ❶ is lit indicates AutoWakeup is enabled. Transmitter red indicator is flashing indicates is idled and RF and audio are sent.

(F) Plug the 6.3 Ø phone plug into any guitar, keyboard or other musical instrument output jack, Fig. 3.



3. Battery Insertion and Replacement:

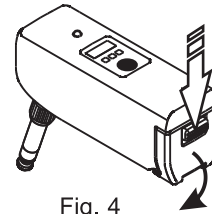

(A) Gently push down on the battery compartment latch and swing the battery compartment over open, Fig. 4.

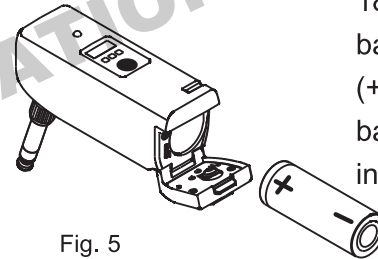

(B) Install a fully-charged 18500 rechargeable battery with positive (+) polarity end of battery towards inside, Fig. 5.

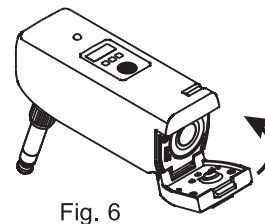

(C) Carefully close the battery cover until the hinge is properly locked and secured, Fig. 6.

- (D) Keep the transmitter power off to preserve battery power after each use. Remove the battery when it will not be used for an extended period of time.

4. MP-24 Charger Usage:

- (A) Insert MT-58 transmitter into the charger. Ascertain the charging contacts are aligned with correct polarity.
- (B) Plug-in both ends as shown in Fig. 7.
- (C) Charging Status: The indicator light displays the charging status of the battery, Fig. 8.
- (1) Still Red: The battery is charging.
 - (2) Still Green: The battery is fully charged.
 - (3) Light is off: No transmitter is inserted.

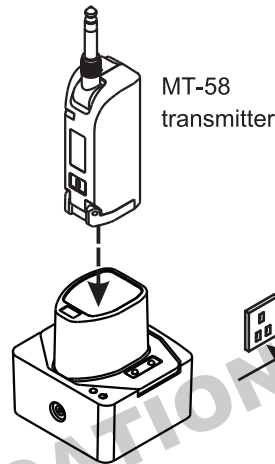
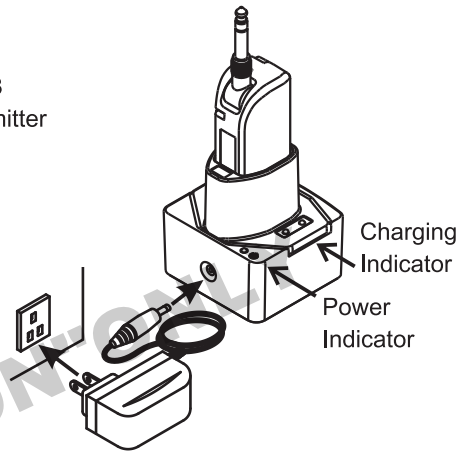

Fig. 7



(transformer is for reference only)

Fig. 8

(D) Charging Caution:

- (1) Use supplied charger only. Do not use other brands' charger to avoid voltage or current shortage as it can be dangerous. DC power input voltage specified value is 5V / 1A DC.
- (2) Turn off the transmitter power during charging to assure the battery is fully charged.

5. Transmitter Installation:

- (A) Remove the 6.3 Ø input phone plug adapter from MT-58, Fig. 9-1.
- (B) Connect the MJ-10E guitar cable to MT-58 and plug the other end to guitar output jack, Fig. 9-2.
- (C) Install the clip on MT-58, Fig. 9-3.
- (D) Clip the transmitter to the guitar strap for a secured fit, Fig. 9-4.



Fig. 9-1

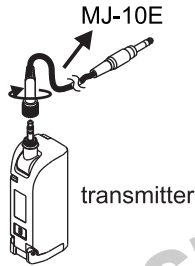

Fig. 9-2

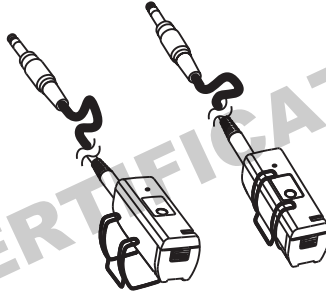

Fig. 9-3

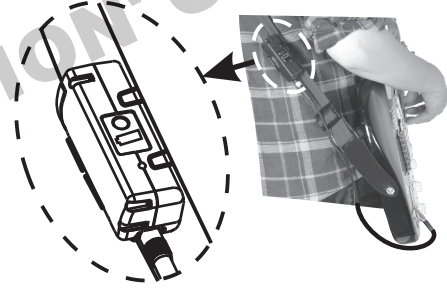

Fig. 9-4

V. Note

1. Design and specifications are subject to change without prior notice. Refer to actual product in the event of product discrepancy.
2. Frequency range, output power and maximum deviation to adhere to local telecom regulations.

FOR "CERTIFICATION" ONLY

Federal Communication Commission Interference Statement

This equipment has been tested and found to comply with the limits for a Class B digital device, pursuant to Part 15 of the FCC Rules. These limits are designed to provide reasonable protection against harmful interference in a residential installation. This equipment generates, uses and can radiate radio frequency energy and, if not installed and used in accordance with the instructions, may cause harmful interference to radio communications. However, there is no guarantee that interference will not occur in a particular installation. If this equipment does cause harmful interference to radio or television reception, which can be determined by turning the equipment off and on, the user is encouraged to try to correct the interference by one of the following measures:

- Reorient or relocate the receiving antenna.
- Increase the separation between the equipment and receiver.
- Connect the equipment into an outlet on a circuit different from that to which the receiver is connected.
- Consult the dealer or an experienced radio/TV technician for help.

FCC Caution: To assure continued compliance, any changes or modifications not expressly approved by the party responsible for compliance could void the user's authority to operate this equipment. (Example - use only shielded interface cables when connecting to computer or peripheral devices).

This device complies with Part 15 of the FCC Rules. Operation is subject to the following two conditions: (1) This device may not cause harmful interference, and (2) This device must accept any interference received, including interference that may cause undesired operation.

FCC Radiation Exposure Statement

This equipment complies with FCC RF radiation exposure limits set forth for an uncontrolled environment.

This transmitter must not be co-located or operating in conjunction with any other antenna or transmitter.

IC

This device complies with Industry Canada RSS-247 ISSUE1 standards. Operation is subject to the following two conditions:

- (1) this device may not cause interference, and
- (2) this device must accept any interference, including interference that may cause undesired operation of the device.

Le présent appareil est conforme aux CNR d'Industrie Canada applicables aux appareils radio exempts de licence. L'exploitation est autorisée aux deux conditions suivantes: (1) l'appareil ne doit pas produire de brouillage, et

- (2) l'utilisateur de l'appareil doit accepter tout brouillage radioélectrique subi, même si le brouillage est susceptible d'en compromettre le fonctionnement.

IC Radiation Exposure Statement:

This equipment complies with IC RSS-102 radiation exposure limit set forth for an uncontrolled environment.

Cet équipement est conforme aux CNR-102 d'Industrie Canada.

FOR "CERTIFICATION" ONLY

FOR "CERTIFICATION" ONLY

MIPRO[®]
MICROPHONE PROFESSIONALS

MIPRO Electronics Co., Ltd

Headquarters: 814 Pei-Kang Road, Chiayi, 60096, Taiwan

Tel : +886.5.238.0809

www.mipro.com.tw

Fax : +886.5.238.0803

mipro@mipro.com.tw



All rights reserved. MN 019/05

Do not copy or forward without prior approvals MIPRO.

Specifications and design subject to change without notice.