

MIPRO®

ACT-8Ha / ACT-8Ta

ACT-8H / ACT-8T

Digital Wireless Microphone Systems

User Guide



MIPRO MIPRO Electronics Co., Ltd.

Headquarters: 814 Pei-Kang Road, Chiayi, 60096, Taiwan.

Web: www.mipro.com.tw

E-mail: mipro@mipro.com.tw

Design and specifications are subject to change without prior notice



AS110520

! IMPORTANT SAFETY INSTRUCTIONS !

1. Read these instructions.
2. Keep these instructions.
3. Heed all warnings.
4. Follow all instructions.
5. Do not use this apparatus near water.
6. Clean only with a dry cloth.
7. Do not block any ventilation openings. Install in accordance with the manufacturer's instructions.
8. Do not install near any heat sources such as radiators, heat registers, stoves, or other apparatus (including amplifiers) that produce heat.
9. Do not defeat the safety purpose of the polarised or ground plug: A polarised plug has two blades with one wider than the other. The wide blade is provided for your safety. When the provided plug does not fit into your outlet, consult an electrician for replacement of the obsolete outlet.
10. Protect the power cord from being walked on or pinched particularly at plug, convenience receptacles, and the point where they exit from the apparatus.
11. Only use attachments/accessories specified by the manufacturer.
12. Use only with a cart, stand, tripod, bracket, or table specified by the manufacturer, or sold with the apparatus. When a cart is used, use caution when moving the cart/apparatus combination to avoid injury from tip-over.
13. Unplug this apparatus during lightning storms or when unused for long periods of time.
14. Refer all servicing to qualified service personnel. Servicing is required when the apparatus has been damaged in any way, such as power-supply cord or plug is damaged, liquid has been spilled or objects have fallen into the apparatus, the apparatus has been exposed to rain or moisture, does not operate normally, or has been dropped.
15. To reduce the risk of fire or electric shock, do not expose this apparatus to rain or moisture.
16. Apparatus should not be exposed to dripping or splashing and no objects filled with liquids, should be placed on the apparatus.
17. Use only with the battery which specified by manufacturer.
18. The power supply cord set is to be the main disconnected device.



WARNING

1. **FOR OUTDOOR USE:**
To reduce the risk of fire or electric shock, do not expose this apparatus to rain or moisture.
2. **UNDER WET LOCATION:**
Apparatus should not be exposed to dripping or splashing and no objects filled with liquids, such as vases should be placed on the apparatus.
3. **SERVICE INSTRUCTIONS:**
CAUTION - These servicing instructions are for use by qualified service personnel only. To reduce the risk of electric shock, do not perform any servicing other than that contained in the operating instructions unless you are qualified to do so.

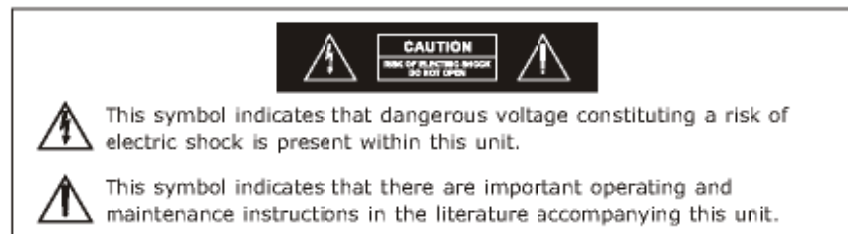

FC & IC - ID

THIS DEVICE COMPLIES WITH PART 74 OF THE FCC RULES AND RSS-123 ISSUE2 OF CANADA. OPERATION IS SUBJECT TO THE FOLLOWING TWO CONDITIONS:

- (1) This device may not cause interference.
- (2) This device must accept any interference, including interference that may cause undesired operation of the device. This equipment complies with FCC RF radiation exposure limits set forth for an uncontrolled environment.

Disposal

Dispose of any unusable devices or batteries responsibly and in accordance with any applicable regulations.



Disposing of used batteries with domestic waste is to be avoided!

Batteries / NiCad cells often contain heavy metals such as cadmium(Cd), mercury(Hg) and lead(Pb) that makes them unsuitable for disposal with domestic waste. You may return spent batteries/ accumulators free of charge to recycling centres or anywhere else batteries/accumulators are sold.

By doing so, you contribute to the conservation of our environment!

ACT-8Ha/ACT-8H DIGITAL WIRELESS HANDHELD MICROPHONE

- 1 MIPRO's Proprietary "ACT" Function & Operation
- 2 Key Features & Benefits
- 3 Part Names and Functions
- 4 Battery Removal and Installation
- 5 Rear Cap On/Off Switch Protection
- 6 LCD Panel Functions
- 16 Cautions

ACT-8Ta / ACT-8T DIGITAL BODYPACK TRANSMITTER

- 17 Key Features & Benefits
- 18 Part Names and Functions
- 19 Battery Removals and Installation
- 21 LCD Panel Functions
- 33 Cautions
- 34 AF Input Connection Methods
- 35 High Frequency Bypass



BATTERY CHARGER

- 36 Part Names and Functions
- 37 Battery Charger Instructions
- 37 Cautions





MIPRO'S PROPRIETARY "ACT" FUNCTION & OPERATION**What is ACT?**

'ACT' stands for 'Automatic Channel Targeting'. MIPRO developed and patented this innovative infrared (IR) sync technology in 2001. MIPRO was the first manufacturer in the industry to automatically synchronize the frequency selected on the receiver to any ACT handheld or bodypack transmitter on the same frequency band.

ACT Benefits:

-  No manual frequency adjusting needed, unlike traditional transmitters.
-  Simple, fast and precise frequency set-up without mechanical errors.
-  Once the frequency has been set, the data is stored in memory, meaning that the frequency is set until it is changed by performing the 'ACT' function again, even after powering off.

ACT Set-Up:

-  Ensure a receiver channel is set-up and transmitter batteries are fresh, installed correctly and powered-on.
-  Press the ACT button on the receiver to activate the ACT syncing function. Once activated, the group/channel and working frequency start blinking.
-  Bring ACT handheld or bodypack transmitter within 30cm (12") of the IR port on the receiver. The IR port is located between the 'ACT' and '▼' buttons and indicated by a round-shaped red color spot. The frequency will sync automatically.
-  When the frequencies are synchronized successfully between the receiver and transmitter, the RF meter cursor and working frequency stop blinking and the indicators

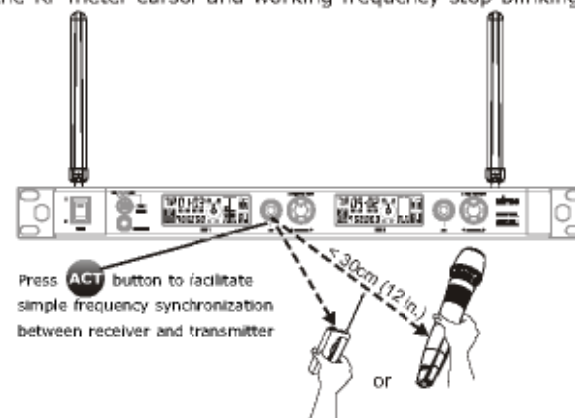

ACT-8Ha/ACT-8H DIGITAL WIRELESS HANDHELD MICROPHONE**KEY FEATURES AND BENEFITS**

1. Ergonomic, aesthetics design with durable magnesium alloy construction of single integrated metal housing.
2. MIPRO proprietary exterior steel windscreen design protects the capsule against impact and rolling, as well as the interior multi-layer fine copper mesh replaces conventional low-price sponge filter, provides an extra protection for microphone capsule and minimizes pop, wind noise and effectively preserves sound clarity, is able to be detached easily for cleaning and good hygiene practices.
3. Easily interchangeable of premium microphone capsules and battery pack. Optional vocal electret condenser microphone capsule, supercardioid dynamic microphone capsule are available.
4. Exhibits high fidelity, wide dynamic range, fast transient responses, low feedback howling, accurate sound image characteristics, transparent sound quality and extremely low handling noise.
5. User-friendly menu buttons.
6. Backlit LCD on the housing displays working channel, transmitter battery status, RF output level and AF input level.
7. Integrated high-efficiency antenna with fool-proof end cap to shield on/off switch and menu buttons for input sensitivity, limiter, low cut, output power and encrypted/unencrypted & channel status.
8. High performance lithium polymer rechargeable battery pack, easily removable for maintenance. No more worries for replacing batteries or drained disposable batteries. Rechargeable battery is environmentally friendly and saves a significant of battery money.
9. Optimal 8 hours continuous use from a single fast full charge.
10. Intelligent MP-88 8-slot battery charger recharges handheld or bodypack transmitters and spare battery simultaneously.
11. High-efficiency low spurious emissions PLL synthesized RF technology. An interference-free working channel can be synchronized quickly and precisely by MIPRO's proprietary ACT function.
12. High dynamic range sustains maximum SPL so performers can be confident it won't distort when singing loudly.

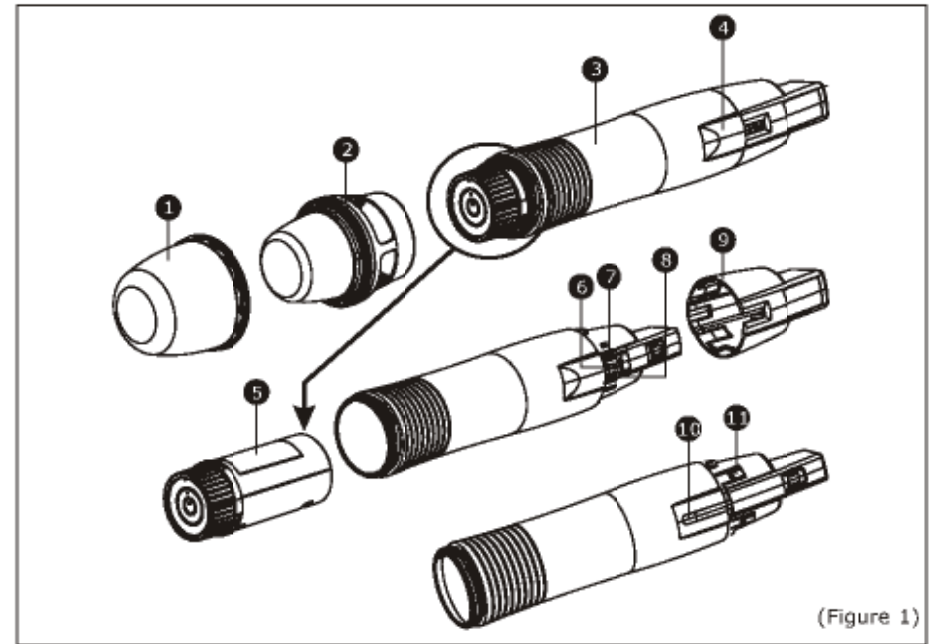
Part Names and Functions

(Figure 1)

- 1 **Upper Grille:** Provides access & protection to capsule.
- 2 **Capsule Module:** Integrated metal grille protects the capsule.
- 3 **Housing:** Houses the PCB and Li-Poly battery module.
- 4 **LCD Display Panel:** Displays group, frequency, gain, battery level, input SPL and error code.
- 5 **Lithium-Polymer Battery Pack:** Detachable Li-Poly battery module can be recharged alone or together with the transmitter; gives 8 hours continuous operation time.
- 6 **Power Switch:** Switch to "ON" position when using microphone and "OFF" when not.
- 7 **MODE:** Mode selection button.
- 8 **SET:** Parameter selection button.
- 9 **Color Rear Cap:** Designed to protect the ON/OFF switch to help prevent the user turning off the microphone during use.
- 10 **ACT Receptor:** Signal reception via the ACT function; automatically programs the frequency and the encryption code from the receiver.
- 11 **Battery Charging Contact:** For charging battery module.

Battery Removal and Installation

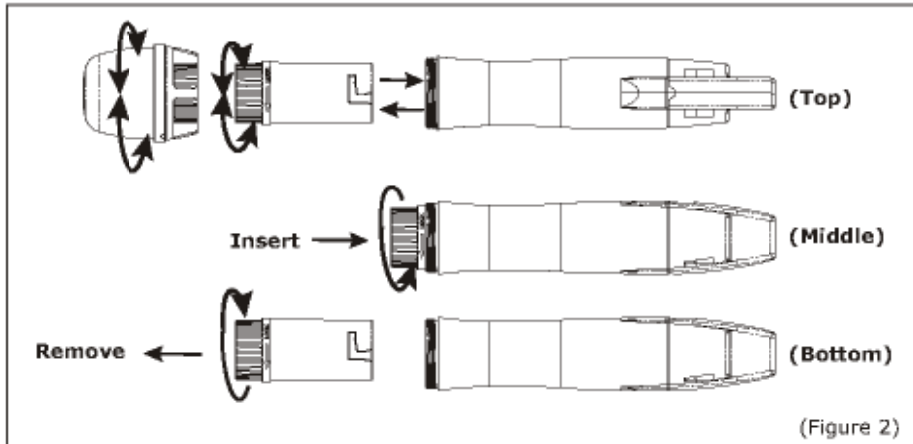

Open the upper grille and capsule module, then turn the battery pack in a counterclockwise direction in order to remove the battery module (see Figure 2). To re-install the battery module, simply load the new battery and turn it in a clockwise direction (see Figure 2).

Point "OPEN" to the pit on the housing to remove battery module



Point "LOCK" to the pit on the housing to secure battery module.



****NOTE:**

When the microphone is not in use, please turn the power off. The battery pack can be recharged while in the transmitter or can be removed from the transmitter and charged alone.

Rear Cap On/Off Switch Protection

The patented color rear cap serves two purposes; it provides easy channel identification and protects the on/off switch. It is designed to allow the on/off switch to either be exposed or concealed as desired. You can avoid unintended switching off of the microphone by rotating the color rear cap 180 degrees to cover the on/off switch completely. The cap can be removed by gripping it firmly and pulling; be sure to push it firmly into place when replacing it on the microphone.



Pull and remove rear cap



Turn rear cap 180 degree and re-install the cap

****NOTE:**

When using the microphone, the color rear cap must be in place.

LCD Panel Functions

Fully Lit LCD Display



Function Selection:

MODE button: gives access to 7 different functions of transmitter

The LCD panel has 7 functions which are displayed sequentially; their respective descriptions and operations are as follows:

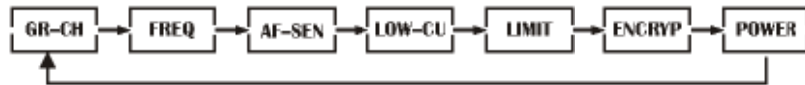

A. Operation Guide

- a. Press MODE (7) to access the 7 different functions. Once a function is selected, it starts flashing on the screen. If the parameter needs to be modified on the selected function, press SET (8) to modify the value while the display is still flashing. Once done, leave it for 5 seconds until it stops flashing and the selection will be programmed into the transmitter.

(1) GR-CH: Displays Group and Channel Information

Display shows GR-CH information by interchangeable blinking.



Display will stop blinking when no action was taken in 5 seconds.

A. Operate via the MODE Button.



B. Operation Guide:

- a. Press "MODE" and stop on the "GR-CH" function; the display showing the current group and channel will be flashing. After 5 seconds, the display will stop flashing and the current group and channel selection will be set.
- b. The group and channel information is now shown on the display. Changing the current group and channel must be done on the receiver.

****NOTE:** When programming a special frequency via monitoring software, the LCD screen cannot display the number. This is because this special channel is not in the preset group and channel. Therefore, the LCD panel will look like the illustration below.

Display shows GR-CH information by interchangeable blinking

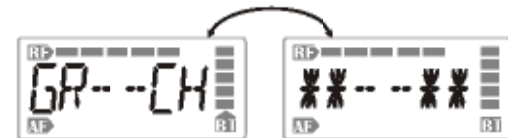

(2) FREQ: Displays Transmitter Frequency Information

Screen flashing alternatively

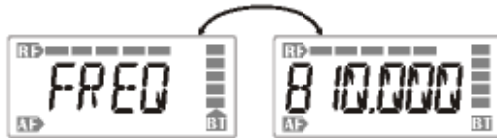

Display shows FREQ information by interchangeable blinking. (The frequency is displayed in "MHz")

A. Operate via the MODE Button.



B. Operation Guide:

- Press "MODE" and stop on the "FREQ" function; the display showing the current frequency will be flashing. After 5 seconds, the display will stop flashing.
- The frequency information is now shown on the display. Changing the current frequency must be done on the receiver.

****NOTE:** To modify the transmitter's group, channel and frequency, all three must be set at the receiver and the new setting transmitted to the transmitter via the ACT function.

(3) LOW-CU: Setup and Change of Low Frequency Cut Off

Screen flashing alternatively

Press "SET" for OFF & ON.



Flashing stops if no operation within 5 seconds.

A. Operate via the MODE Button.

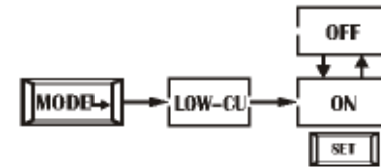

B. Operation Guide:

- Press "MODE" and stop on the "LOW-CU" function; the display showing the current status will be flashing and is ready to be modified.
- Press the "SET" button while the display is flashing to change to "ON" or "OFF" as desired.

****NOTE:** When the LOW-CU function is "ON", the frequency response below 100Hz will decrease about 4dB with a slope of -6dB/Octave.

(4) AF-SEN: Setup and Change of Input Sensitivity

Screen flashing alternatively

Press "SET" for +6dB steps.



Flashing stops if no operation within 5 seconds.

A. Operate via the MODE Button.

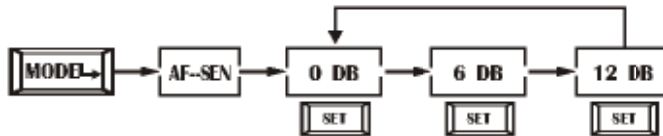

B. Operation Guide:

- Press "MODE" and stop on the "AF-SEN" function; the display showing the current status will be flashing and is ready to be modified.
- Every push of the "SET" button increases the dB value by 6dB to a maximum of 12dB.



****NOTE:**

- The higher the gains are set, the lower the dynamic range for signal input and the greater the danger of unwanted noises and feedback getting into the system.
- It is advisable to generally set the sensitivity to a level between 0dB-6dB.
- When set at 0 dB, the maximum SPL for a handheld microphone is 145dB.

(5) LIMIT: Setup and Change of Input Limit

Screen flashing alternatively

Press "SET" for OFF & ON.



Flashing stops if no operation within 5 seconds.

A. Operate via the MODE Button.

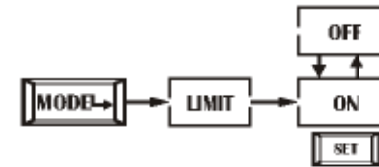

B. Operation Guide:

- Press "MODE" and stop on the "LIMIT" function; the display showing the current status will be flashing and is ready to be modified.
- Press "SET" while the display is flashing to change the setting to "ON" or "OFF".

****NOTE:**

When the LIMIT is 'ON', the maximum output of the receiver is limited to 1V.

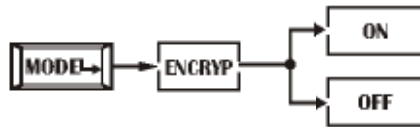
(6) ENCRYP: Displays Information of Encryption**A. Operate via the MODE Button****B. Operation Guide:**

- a. Press "MODE" and stop on the "ENCRYP" function; the display showing the current status will be flashing.

****NOTE:**

1. The "ENCRYP" function displays status information only. Changing of the current status must be done from the receiver via the ACT function.
2. The "ENCRYP" function must be set at receiver first then using ACT to program the transmitter.

(7) POWER : Power Selection

Screen flashing alternatively

Press SET button once for POW-LO: Power Low
 Press SET button again for POW-HI: Power High

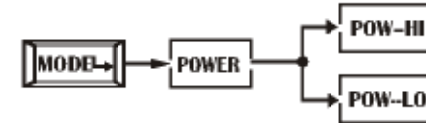

Flashing stops if no operation within 5 seconds.

A. Operate via the MODE Button.**B. Operation Guide:**

- a. Press MODE button for selection of Powers. Selection of POW-HI or POW-LO can be selected once the POWER LCD starts blinking.
- b. Press SET button to select and set POW-HI or POW-LO.

****NOTE:**

POW-HI has 50mW transmitting power. POW-LO has 10mW transmitting power. Set appropriate power to meet region/country regulations.

(8) BT: Displays Battery Level Information

When the battery level drops down to 10%, please replace or recharge the battery. If the battery continues to be used at a very low level, the LCD will display "PO-OFF" and then automatically switch off to avoid over-discharging the battery.

(9) ERR: Error Code

If the LCD displays "ERR" after turning on the power, it indicates the operation is not correct. The error codes are as follows:

- ROM-ER** → Transmitter does not have the initial data so the microphone is completely dead and cannot be programmed.
- ERROR1** → Failure on RF circuitry, frequency cannot be programmed.
- NO----OR3** → Frequency to be programmed into the transmitter exceeds the highest frequency of the designated frequency band of the transmitter.
- NO----OR4** → Frequency to be programmed into the transmitter exceeds the lowest frequency of the designated frequency band of the transmitter.

****NOTE:**

NO----OR3 and NO----OR4 will not change the transmitter's original frequency and the transmitter will still operate normally with the error message on display. To remove the error message from the display panel, please switch off the transmitter and switch it on again.

(10) PO-OFF: System Turning Off

When the power is turned off, the LCD displays "PO-OFF" indicating the system is in the process of shutting down and then the power automatically cuts off. The display panel will then display no further messages.

Cautions

1. Unless necessary, do not remove the battery module from the microphone when the microphone needs to be charged. The best way is to put the whole microphone into the charger for recharging; this prolongs the life of the contact spring on the capsule module.
2. Traditionally designed microphones have an antenna protruding on the bottom of the housing. Modern designs have a built-in antenna in the upper or lower housing. The antenna section of the ACT-8H is located on the end of the transmitter (where the color cap is). Users should avoid holding the microphone over or near the antenna section as this will deteriorate transmission efficiency; this deterioration gets even more severe if users hold the microphone directly above the antenna with both hands.
3. Many performers tend to hold the microphone by the grille. Unfortunately, this position seriously degrades both the sound quality and directionality of a microphone. Even the most expensive microphone will have its original sound quality compromised by this method. Grabbing a microphone by the grille will isolate the capsule's acoustic resonance circuit and or change the capsule resonator's frequency. This results in an inferior performance in both frequency response and the separation of directionality. In addition, a palm's sound-focusing effect will tend to strengthen resonances in certain frequencies and can cause unwanted echo.
4. A proper technique is required for using directional microphones because the distance between the microphone and your mouth has a significant impact on sensitivity and performance. There is an inverse relationship between microphone sensitivity and the distance from the mouth to the microphone. Consequently, performers with a "weaker" sound level cannot expect to hold the microphone too far away from their mouth and compensate by turning up the amplifier volume to increase the sound level as this can easily cause echo or feedback. In contrast, performers with a "louder" sound level should not hold the microphone too close as this can easily result in distortion by causing the amplifier system to be overloaded.
Furthermore, a large-diaphragm directional microphone has a very distinct proximity effect. When the microphone is close to the mouth, the bass response is strengthened as the distance gets closer. Therefore, if a performer's sound is insufficient in bass, they can hold the microphone closer and use the proximity effect to help compensate for the lower bass level. Conversely, if a performer's voice is too heavy in the bass register, increasing the distance between the microphone and their mouth will decrease the proximity effect and reduce the bass response, thus making their voice become clearer and brighter.
5. It is recommended to keep the grille and sponge windscreen clean to avoid any substance blocking the proximity effect of the microphone.

FCC ID: MSX-ACT8H

THIS DEVICE COMPLIES WITH PART 74 OF THE FCC RULES AND RSS-123 Issue1 OF CANADA.

OPERATION IS SUBJECT TO THE FOLLOWING TWO CONDITIONS:

- (1) This device may not cause interference.
- (2) This device must accept any interference, including interference that may cause undesired operation of the device.

This equipment complies with FCC RF radiation exposure limits set forth for an uncontrolled environment.

ACT-8Ta / ACT-8T DIGITAL BODYPACK TRANSMITTER**KEY FEATURES AND BENEFITS**

1. Industry's smallest and lightest digital bodypack transmitter with extremely rugged low-profile magnesium alloy housing.
2. Detachable antenna, mini power switch and XLR input socket.
3. Backlit LCD displays working channel, battery level, RF output level and AF input level.
4. User-friendly menu buttons with data setup and user-selectable lockout facility.
5. High performance lithium polymer rechargeable battery pack, easily removable for maintenance and powers 12 operating hours.
6. Intelligent charger recharges both transmitter and spare battery simultaneously.
7. Adjustable belt clip allows transmitter to be worn comfortably in various positions to suit the user.
8. An interference-free working channel can be synchronized quickly and precisely by MIPRO's proprietary ACT function.
9. Switchable RF power output.
10. Adjustable audio sensitivity.
11. Optional 3 pin LEMO connector.
12. Rugged mechanism for battery pack in case of the falling impact.

Part Names and Functions

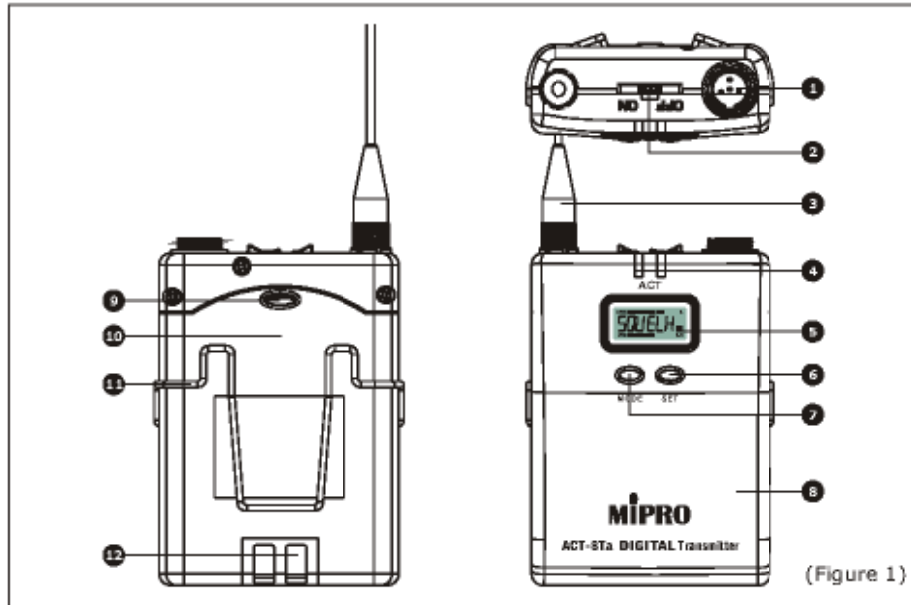

(Figure 1)

- 1 **AF Input:** Accepts 5 different connectors to connect the microphone. (see reference 3, page 21).
- 2 **Power Switch:** Switch to "ON" position for operation; switch to "OFF" when not in use.
- 3 **Transmitting Antenna:** Detachable $1/4\lambda$ antenna.
- 4 **ACT Receptor:** Signal reception via the ACT function; automatically programs the frequency and the encryption code from the receiver.
- 5 **LCD display panel:** Displays group, frequency, gain, battery level, input SPL and error messages.
- 6 **SET:** Parameter selection button.
- 7 **MODE:** Function selection button.
- 8 **Transmitter Housing:** Protects transmission PCB assembly, battery holder, LCD display and control switches.
- 9 **Battery Module Wedge:** To securely fix the battery module in place.
- 10 **Lithium Battery:** Lithium battery cartridge module is easy to pull out to charge separately or can be charged while installed in the transmitter as well. It can be continuously operated up to 8 hours on a full charge.
- 11 **Belt clip:** The special design of the spring clip enables users to wear the transmitter in any position according to their own preference.
- 12 **Battery Charging Contacts:** For battery module charging.

Battery Removals and Installation

Removing the Battery:

1. Push open the belt clip in the direction shown in step 1 to remove the belt clip.
2. Press the battery wedge (9) as shown in step 2, then push down as shown in step 3 to remove the lithium battery module.

Replacing the Battery:



1. Hook the battery module in position as shown in step 1.
2. Push the battery module upwards until it locks into position as shown in step 2.
3. Push open the belt clip as in step 1 on removing the battery. Then put the belt clip back as shown in step 3.

LCD Panel Functions

Fully Lit LCD Display



Function Selection:

MODE button: gives access to 9 different functions of transmitter

The LCD panel has 9 functions displayed sequentially; their respective descriptions and operations are as follows:

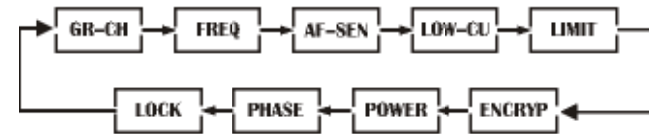

A. Operation Guide

- a. Press MODE (7) to access the 9 different functions. Once a function is selected, it starts flashing on the screen. If parameter needs to be modified on selected function, press SET (8) to modify the value while the display is still flashing. Once done, leave it for 5 seconds until it stops flashing and the selection will be programmed into the transmitter.

(1) GR-CH: Displays Group and Channel Information

Display shows GR-CH information by interchangeable blinking.



Display will stop blinking when no action was taken in 5 seconds.

A. Operate via the MODE Button.



B. Operation Guide:

- Press "MODE" and stop on the "GR-CH" function; the display showing the current group and channel will be flashing. After 5 seconds, the display will stop flashing and the current group and channel selection will be set.
- The group and channel information is now shown on the display. Changing the current group and channel must be done on the receiver.

****NOTE:** When programming a special frequency via monitoring software, the LCD screen cannot display the number. This is because this special channel is not in the preset group and channel. Therefore, the LCD panel will look like the illustration below.

Display shows GR-CH information by interchangeable blinking

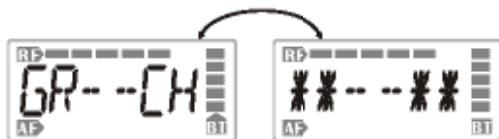

(2) FREQ: Displays Transmitter Frequency Information

Screen flashing alternatively

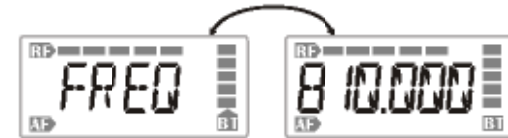

Display shows FREQ information by interchangeable blinking. (The frequency is displayed in "Mhz")

A. Operate via the MODE Button.



B. Operation Guide:

- Press "MODE" and stop on the "FREQ" function; the display showing the current frequency will be flashing. After 5 seconds, the display will stop flashing.
- The frequency information is now shown on the display. Changing the current frequency must be done on the receiver.

****NOTE:** To modify the transmitter's group, channel and frequency, all three must be set at the receiver and the new setting transmitted to the transmitter via the ACT function.

(3) LOW-CU: Setup and Change of Low Frequency Cut Off



Flashing stops if no operation within 5 seconds.

A. Operate via the MODE Button.



B. Operation Guide:

- Press "MODE" and stop on the "LOW-CU" function; the display showing the current status will be flashing and is ready to be modified.
- Press the "SET" button while the display is flashing to change to "ON" or "OFF" as desired.

****NOTE:**

When the LOW-CU function is "ON", the frequency response below 100Hz will decrease about 4dB with a slope of -6dB/Octave.

(4) AF-SEN: Setup and Change of Input Sensitivity



Flashing stops if no operation within 5 seconds.

A. Operate via the MODE Button.

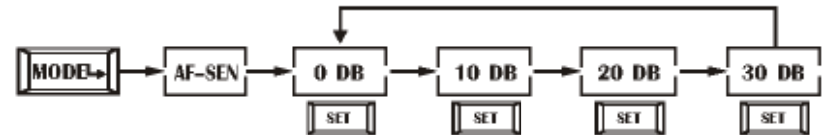

B. Operation Guide:

- Press "MODE" and stop on the "AF-SEN" function; the display showing the current status will be flashing and is ready to be modified.
- Every push of the "SET" button increases the dB value by 10dB to a maximum of 30dB.

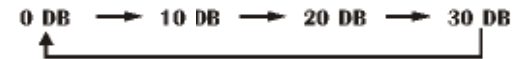

****NOTE:**

- The higher the gains are set, the lower the dynamic range for signal input and the greater the danger of unwanted noises and feedback getting into the system.
- When using electronic guitar, gain should set at 0 dB.
- Please make sure input signal strength does not exceed 1 Vrms (gain = 0 dB) as it is the maximum input strength allowed for transmitter without causing distortion.

(5) LIMIT: Setup and Change of Input Limit

Screen flashing alternatively

Press "SET" for OFF & ON.



Flashing stops if no operation within 5 seconds.

A. Operate via the MODE Button.

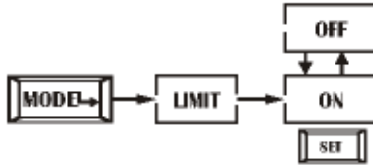

B. Operation Guide:

- a. Press "MODE" and stop on the "LIMIT" function; the display showing the current status will be flashing and is ready to be modified.
- b. Press "SET" while the display is flashing to change the setting to "ON" or "OFF".

****NOTE:**

When the LIMIT is "ON", the maximum output of the receiver is limited to 1V.

(6) ENCRYP: Displays Information of Encryption

A. Operate via the MODE Button



B. Operation Guide:

- a. Press "MODE" and stop on the "ENCRYP" function; the display showing the current status will be flashing.

****NOTE:**

1. The "ENCRYP" function displays status information only. Changing of the current status must be done from the receiver via the ACT function.
2. The "ENCRYP" function must be set at receiver first then using ACT to program the transmitter.

(7) POWER : Power Selection

Screen flashing alternatively

Press SET button once for POW-LO: Power Low
Press SET button again for POW-HI: Power High



Flashing stops if no operation within 5 seconds.

A. Operate via the MODE Button.

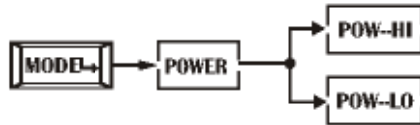

B. Operation Guide:

- Press MODE button for selection of Powers. Selection of POW-HI or POW-LO can be selected once the POWER LCD starts blinking.
- Press SET button to select and set POW-HI or POW-LO.

****NOTE:**

POW-HI has 50mW transmitting power. POW-LO has 10mW transmitting power. Set appropriate power to meet region/country regulations.

(8) PHASE : Phase Selection of AF inputs

Screen flashing alternatively

Press SET button once for AF--NEG: Power Low
Press SET button again for AF--POS: Power High



Flashing stops if no operation within 5 seconds.

A. Operate via the MODE Button.

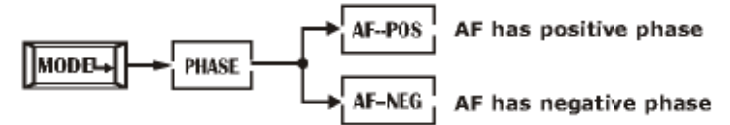

B. Operation Guide:

- Press MODE button for selection of Phase . Selection of AF--POS or AF--NEG can be selected once the PHASE LCD starts blinking.
- Press SET button to select and set AF--POS or AF--NEG.

****NOTE:**

Phase function provides users a phase selection for different condenser microphones. The normal setting is AF-POS, and AF-NEG might be selected if two-wire condenser microphone is used.

(9) LOCK : Setup and Change of Parameter Lock



Flashing stops if no operation within 5 seconds.

A. Operate via the MODE Button.

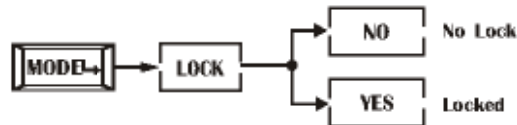

B. Operation Guide:

- Press MODE button once for LOCK display. Once LOCK display starts blinking it is ready for selection.
- Press SET button for NO or YES selection.

****NOTE:**

- When locked (LOCK--YES), receiver settings cannot be changed including the powering on & powering off. To power off it needs to be in unlock mode (LOCK-NO).
- A sudden lose of power will deactivate the LOCK Function.

(10) BT: Displays Battery Level Information

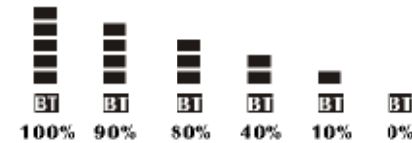

When the battery level drops down to 10%, please replace or recharge the battery. If the battery continues to be used at a very low level, the LCD will display "PO-OFF" and then automatically switch off to avoid over-discharging the battery.

(11) ERR: Error Code

If the LCD displays "ERR" after turning on the power, it indicates the operation is not correct. The error codes are as follows:

- ROM-ER** → Transmitter does not have the initial data so the microphone is completely dead and cannot be programmed.
- ERROR1** → Failure on RF circuitry, frequency cannot be programmed.
- NO----OR3** → Frequency to be programmed into the transmitter exceeds the highest frequency of the designated frequency band of the transmitter.
- NO----OR4** → Frequency to be programmed into the transmitter exceeds the lowest frequency of the designated frequency band of the transmitter.

****NOTE:**

Note: NO----OR3 and NO----OR4 will not change the transmitter's original frequency and the transmitter will still operate normally with the error message on display. To remove the error message from the display panel, please switch off the transmitter and switch it on again.

(12) PO-OFF: System Turning Off

When the power is turned off, the LCD displays "PO-OFF" indicating the system is in the process of shutting down and then the power automatically cuts off. The display panel will then display no further messages.

Cautions

1. Adjust the gain knob to the appropriate level (The gain level needs to be set at 0dB level when using an electric guitar).
2. Plug the microphone connector into the AF input (1) and then secure the connector by turning it in a clockwise direction, as shown in Figure 2.

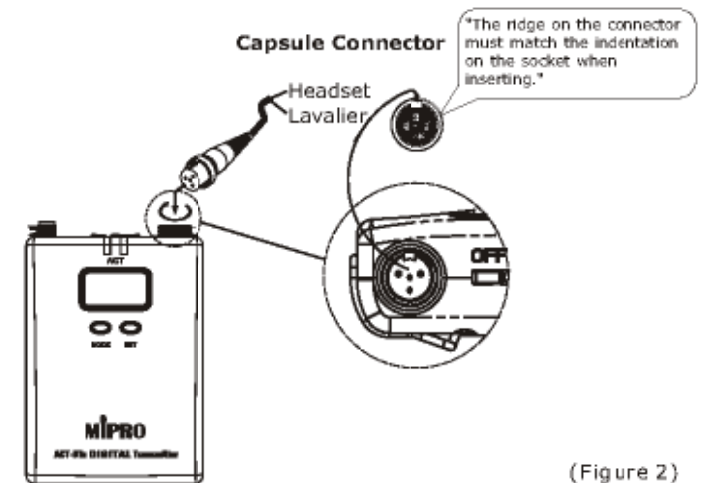

(Figure 2)

3. If the transmitter is on without any microphone connected to the AF input socket, the system may have unwanted noises of both high and low frequencies.
4. They will do no harm to the system, but will be annoying to the listener, so it would be best to switch off the transmitter when disconnecting the microphone.

AF Input Connection Methods

(1) 2-Wire Electret Condenser Microphone Capsule

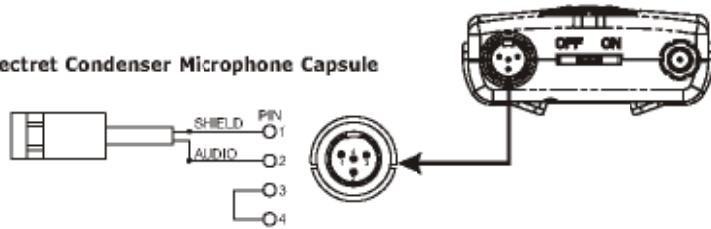

(2) 3-Wire Electret Condenser Microphone Capsule

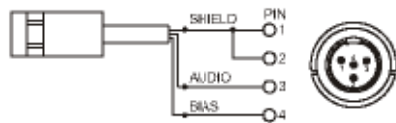

(3) Dynamic Microphone

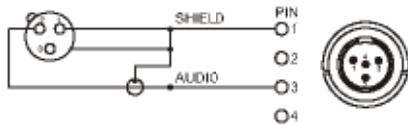

(4) Electric Guitar

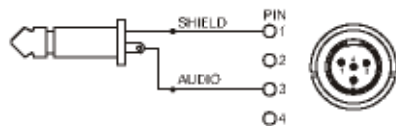

(5) Line-in (Impedance 8KΩ ATT. 10dB)

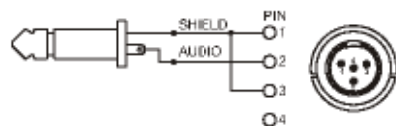

(Figure 3)

High Frequency Bypass

- When other microphones are in use, some changes may be needed to another microphone before adding it to the system in order to avoid high frequency interference, as illustrated in diagram (1).
- When a high frequency radio wave causes interference, it normally affects the system by generating a persistent noise or by deteriorating the frequency response. In an effort to ameliorate these problems, a 330PF bypass condenser can be added on the cartridge as shown in diagrams (1) and (2). If this method is not possible, another option is to add a bypass condenser on the 4-pin XLR connector as shown in diagrams (3) and (4).

**The Best Method

(1) Connect to two-wire condenser capsule

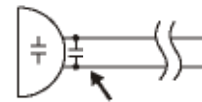

Add 330pF bypass capacitor

(2) Connect to three-wire condenser capsule



Add 330pF bypass capacitor

**Alternate Method

(3) Connect to two-wire condenser capsule

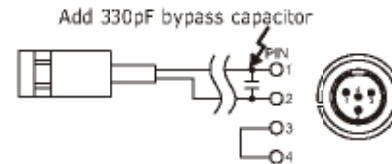

Add 330pF bypass capacitor

(4) Connect to three-wire condenser capsule

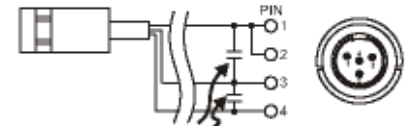

Add 330pF bypass capacitor

THIS DEVICE COMPLIES WITH PART 74 OF THE FCC RULES AND RSS-123 Issue1 OF CANADA.

OPERATION IS SUBJECT TO THE FOLLOWING TWO CONDITIONS:

- (1) This device may not cause interference.
- (2) This device must accept any interference, including interference that may cause undesired operation of the device.

This equipment complies with FCC RF radiation exposure limits set forth for an uncontrolled environment.

Part Names and Functions

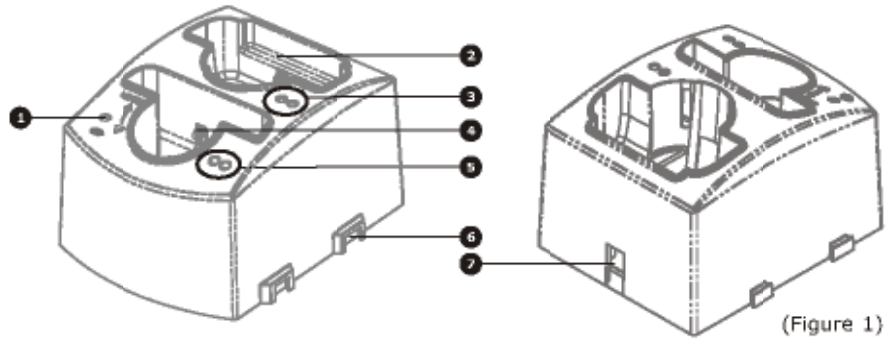

- ❶ **Power Indicator:** Green light indicates DC power is on.
- ❷ **Microphone Charger:** Accepts both handheld and body pack transmitters. (See Figure 2)
- ❸ **Microphone Charging Indicator:**
 - (a) Red light flashing indicates battery is in the process of charging.
 - (b) Green light flashing indicates battery is fully charged (requires maximum of 4 hours).
- ❹ **Charger for Lithium-Polymer Battery:** Accepts lithium-polymer battery module from handheld microphone as well as body pack transmitter. (See Figure 2)
- ❺ **Battery Module Charging Indicator:**
 - (a) Red light flashing indicates battery is in the process of charging.
 - (b) Green light flashing indicates battery is fully charged (requires maximum of 4 hours).



Transmitter Charging

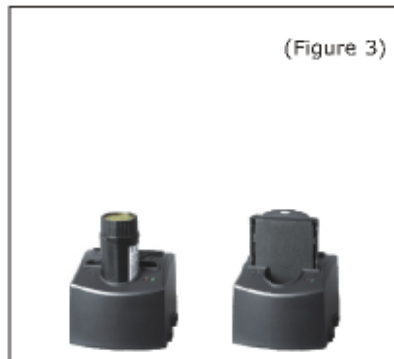

Module Charging

Battery Charger Instructions

1. Plug the provided DC power transformer into AC outlet and attach the battery charger as shown in diagram (Figure 4).
2. Insert the transmitter or battery module into the appropriate charging dock with correct polarity.

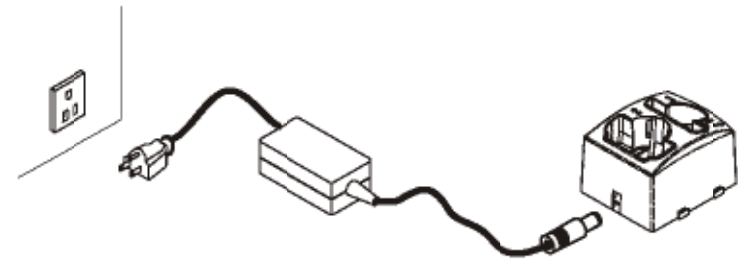

(Figure 4)

CAUTIONS

1. Please use only the specific type of transformer designed to work with the MIPRO charger to avoid voltage problems. If the voltage to the charger is too high, it will damage the charger, rechargeable battery and microphone at the same time. We recommend a 12V/1A DC power supply.
2. The transmitter must be switched off when it is charging.
3. Please do not use any other type of battery charger for safety reasons.