

# MIPRO<sup>®</sup>

## User Guide

### ACT-80TC DIGITAL TRANSMITTER



**MIPRO<sup>®</sup>**  
MICROPHONE PROFESSIONALS

**MIPRO Electronics Co., Ltd**

Headquarters : 814 Pei-Kang Road, Chiayi, 60096, Taiwan  
Tel : +886.5.238.0809 Fax : +886.5.238.0803  
www.mipro.com.tw mipro@mipro.com.tw

All rights reserved. MN 015/01

Do not copy or forward without prior approvals MIPRO.

Specifications and design subject to change without notice.



2 CE5 15 A

## Contents

- 1 Bodypack Controls and Indicators
- 4 Operating Instructions
- 5 LCD Display Screen
- 6 How to Setup Transmitter Parameters
- 19 Battery Status
- 21 MUTE Control Set-Up
- 25 AF Input Connections
- 26 Battery Removal and Installation

## Bodypack Controls and Indicators

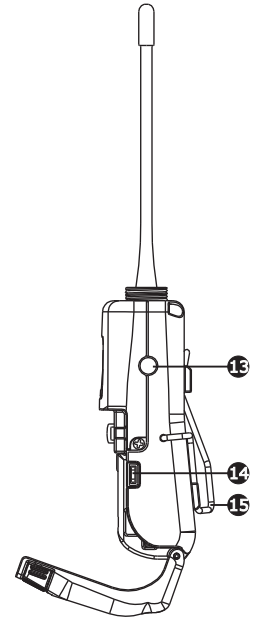
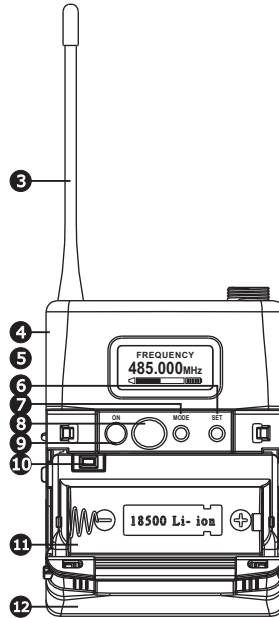
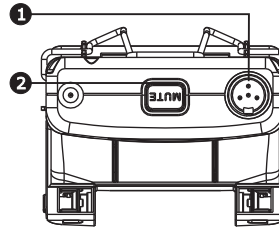

- 1 **Audio Input Connector:** TA4F mini 4-pin connector accepts any MIPRO lavalier, instrument and headset microphones and cables. (See 5 ways of connection on AF Input Connections)
- 2 **MUTE Button:** To mute and un-mute the audio signal temporary.
- 3 **Antenna:** Flexible 1/ 4 wave transmitting antenna.
- 4 **Transmitter Housing:** Holds PCB board and wires.
- 5 **LCD Panel:** Display transmitter parameters.
- 6 **SET Button:** Parameter selection button.
- 7 **MODE Button:** Allows access to available functions displaying in LCD panel.
- 8 **ACT IR Port:** Align and syncs the transmitter and receiver frequency automatically.
- 9 **Power Button:** Press and hold 2 seconds to power ON or OFF.
- 10 **Battery Circuitry Protection Reset Button**
- 11 **Battery Compartment:** Accommodates one 18500 rechargeable battery.
- 12 **Battery Cover:** Hinged cover opens to provide access to one 18500 rechargeable battery.
- 13 **External Mute Connector:** When an external mute switch cable, MJ-70 (optional) is connected , user can manually mute and un-mute the audio temporary.
- 14 **Battery Charging Contact:** Align contacts during charging.

- 15 **Belt Clip:** Detachable and reversible design allows the transmitter to be worn on a belt, waistband, or guitar strap (Figure 1).

(Positive Wear)

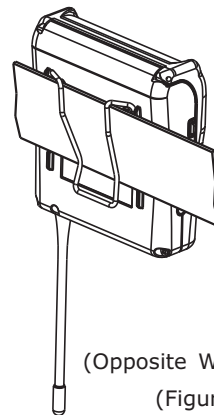
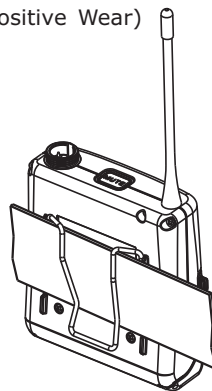
(Opposite Wear)  
(Figure 1)

## Operating Instructions

- Insert the lavalier, headset microphone or instrument cable into the audio input connector before power ON the transmitter.
- Tighten the connector screw clockwise direction as shown in (Figure 2) for a secured fit.
- Please make sure sensitivity level is set at proper level.

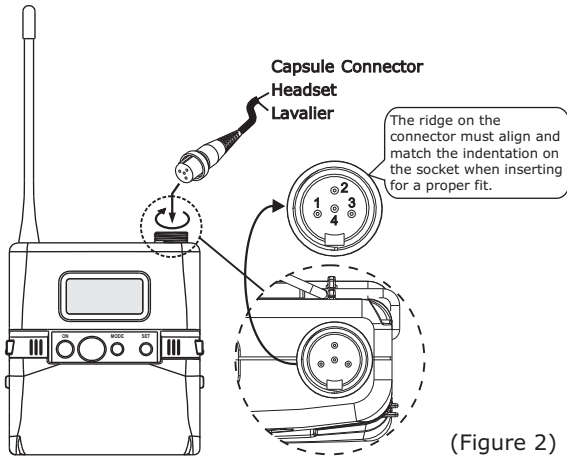

## LCD Display Screen

### Fully Lit LCD Display

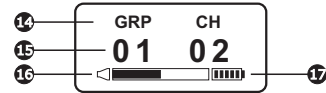

- ⑭ LCD Screen
- ⑮ Parameters Screen
- ⑯ AF (audio) MUTE
- ⑰ Transmitter Battery Meter

## How to Setup Transmitter Parameters

- **MODE** Button:

Press "**MODE**" button to access one of the NINE functions below.

- **SET** Button:

Press "**SET**" button and LCD will start flashing. During flashing, press SET button to change parameters.

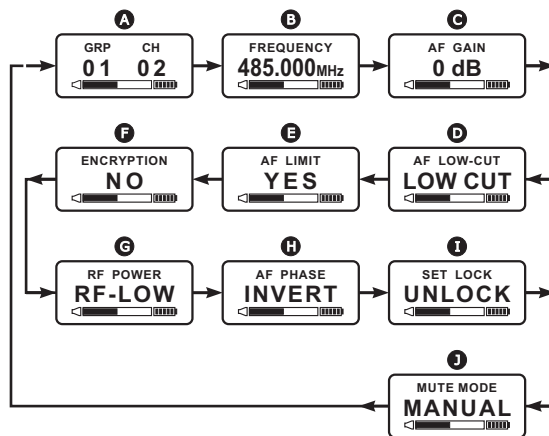
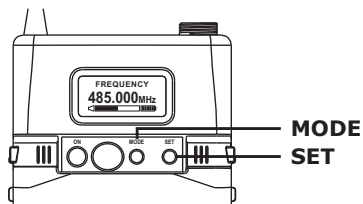

- **A** Group and Channel
- **B** Frequency
- **C** Sensitivity Level
- **D** AF Low Cut
- **E** AF Limit
- **F** Encryption
- **G** RF Output Power
- **H** AF Phase
- **I** Parameters Lock & Unlock Status
- **J** MUTE MODE

**GRP CH:** Displays Group and Channel Information

- Press **MODE** and stop on the **GRP CH** function; the display showing the current group and channel will be flashing. After 5 seconds, the display will stop flashing and the current group and channel selection will be set.
- The group and channel information is now shown on the display. Changing the current group and channel must be done on the receiver.

**\*\*Note:**

When programming a special frequency via monitoring software, the LCD screen cannot display the number. This is because this special channel is not in the preset group and channel. RF, the LCD panel will look like the illustration below.

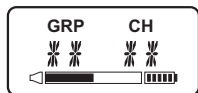
**FREQUENCY:** Displays Transmitter Frequency Information

- Press **MODE** and stop on the **FREQUENCY** function; the display showing the current frequency will be flashing. After 5 seconds, the display will stop flashing.
- The frequency information is now shown on the display. Changing the current frequency must be done on the receiver.

**\*\*Note:**

To modify the transmitter's group, channel and frequency, all three must be set at the receiver and the new setting transmitted to the transmitter via the ACT function.



**AF GAIN: Setup and Change of Input Sensitivity**

- Press **MODE** and stop on the **AF GAIN** function; the display showing the current status will be flashing and is ready to be modified.
- Every push of the **SET** button increases the dB value by 6dB to a maximum of 18dB.

**\*\*Note:**

- The higher the gains are set, the lower the dynamic range for signal input and the greater the danger of unwanted noises and feedback getting into the system.
- When using electronic guitar, gain should set at 0dB.
- Please make sure input signal strength does not exceed 2 Vrms (gain=6dB) as it is the maximum input strength allowed for transmitter without causing distortion.

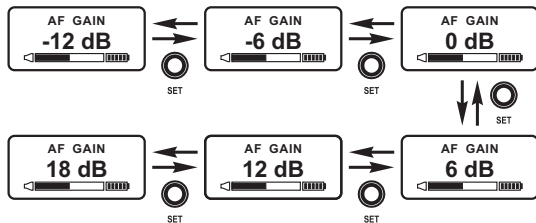
**AF LOW-CUT: Setup and Change of Low Frequency Cut Off**

- Press **MODE** and stop on the **AF LOW-CUT** function; the display showing the current status will be flashing and is ready to be modified.
- Press the **SET** button while the display is flashing to change to **LOW CUT** or **FLAT** as desired.

**\*\*Note:**

When the AF LOW-CUT function is LOW CUT, the frequency response below 100Hz will decrease about 3dB with a slope of -6dB/Octave.

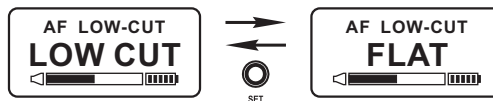

**AF LIMIT:** Setup and Change of Input Limit

- Press **MODE** and stop on the **AF LIMIT** function; the display showing the current status will be flashing and is ready to be modified.
- Press **SET** while the display is flashing to change the setting to **ON** or **OFF**.

**\*\*Note:**

When the LIMIT is ON, the maximum output of the receiver is limited to 1V.

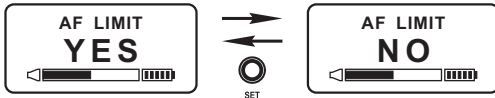
**ENCRYPTION:** Displays Information of Encryption

- Press **MODE** and stop on the **ENCRYPTION** function; the display showing the current status will be flashing.

**\*\*Note:**

- The ENCRYPTION function displays status information only. Changing of the current status must be done from the receiver via the ACT function.
- The ENCRYPTION function must be set at receiver first then using ACT to program the transmitter.





**RF POWER:** RF Power Selection

- Press **MODE** button for selection of **RF POWER**. Selection of **RF-HI** or **RF-LOW** can be selected once the RF POWER LCD starts blinking.
- Press **SET** button to select and set **RF-HI** or **RF-LOW**.

**\*\*Note:**

RF-HI has 50mW transmitting power. RF-LOW has 10mW transmitting power. Set appropriate power to meet region/country regulations.

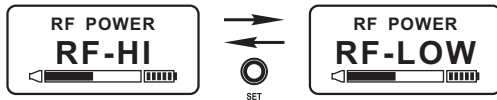
**AF PHASE:** Phase Selection of AF inputs

- Press **MODE** button for selection of **AF PHASE**. Selection of **NORMAL** or **INVERT** can be selected once the **AF PHASE** LCD starts blinking.
- Press **SET** button to select and set **NORMAL** or **INVERT**.

**\*\*Note:**

AF PHASE function provides users a phase selection for different condenser microphones. The normal setting is NORMAL, and INVERT might be selected if two-wire condenser microphone is used.

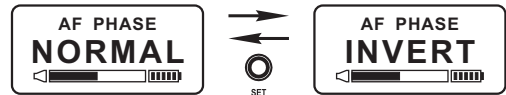

**SET LOCK:** Setup and Change of Parameter Lock

- a. Press **MODE** button once for **SET LOCK** display. Once **SET LOCK** display starts blinking it is ready for selection.
- b. Press **SET** button for **UNLOCK** or **LOCK** selection.

**\*\*NOTE:**

1. When locked (LOCK), receiver settings cannot be changed including the powering on & powering off. To power off it needs to be in unlock mode (UNLOCK).
2. A sudden lose of power will deactivate the LOCK Function.
3. MUTE function can be operated normally during LOCK mode.

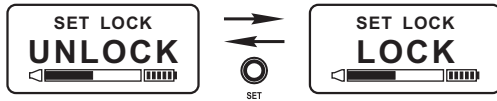

**MUTE MODE**

- a. Press **MODE** button until **MUTE MODE** icon appears and flashes.
- b. Press **SET** button to select **MANUAL**, **DISABLE** or **PUSH-OFF** setting.
- c. Setting needs to be completed within 5 seconds to be saved. Set again if flash stops before completion.



- d. **MANUAL:** Standard setting where mute function can be controlled by mute button.
  - Audio is muted when **MUTE** button is pressed and **AF MUTE** indicator starts flashing. Press **MUTE** button again to cancel.
  - **AF MUTE** cancels automatically when power off.

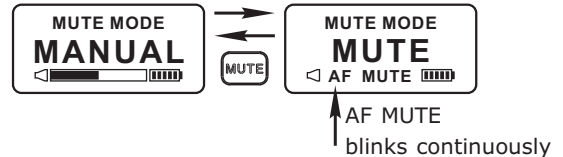

- e. **DISABLE:** **MUTE** button is disabled and mute function is cancelled.

f. **PUSH-OFF:**

- Press and hold MUTE button to mute continuously. Press and release MUTE button to un-mute.
- Under this mode, an optional MJ-70, Remote Mute Switch (not included), can be used to MUTE and un-mute externally.

MUTE ON audio is muted. MUTE OFF audio is on.  
MUTE ON MUTE OFF

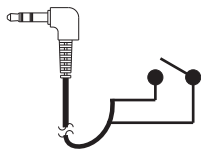
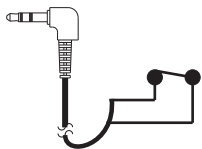
**Battery Status**

Indicates the power remaining in the transmitter battery. When the battery has less than 10% power remaining it must be replaced or recharged. If an under voltage condition continues, the LCD will show "OFF..." and the system will shut down to prevent being overly discharged.

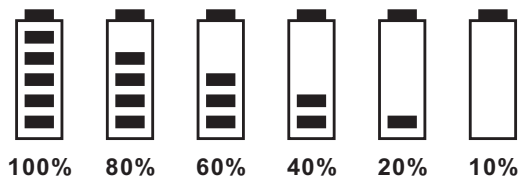
**"OFF..." : Power Off**

1. Press and hold power button for 2 seconds to power on & off.
2. When the power switch is turned off, the LCD will show "OFF..." (for Power Off) first and then the system will shut down and no further messages will be displayed.

**OFF...**

**ERR: Error Code**

If the LCD displays "ERR" after turning on the power, it indicates the operation is not correct. The error codes are as follows:

**ROM-ER** → Transmitter does not have the initial data so the microphone is completely dead and cannot be programmed.

**ERROR1** → Failure on RF circuitry, frequency cannot be programmed.

**NO----OR3** → Frequency to be programmed into the transmitter exceeds the highest frequency of the designated frequency band of the transmitter.

**NO----OR4** → Frequency to be programmed into the transmitter exceeds the lowest frequency band of the transmitter.

**\*\*Note:**

NO----OR3 and NO----OR4 will not change the transmitter's original frequency and the transmitter will still operate normally with the error message on display. To remove the error message from the display panel, please switch off the transmitter and switch it on again.

**MUTE Control Set-Up**

**MUTE** control enables audio to be muted or un-muted temporarily.

- Press **MUTE** button to mute audio temporarily. Parameter values can be changed and ACT sync activate during this **MUTE** mode.
- Press **MUTE** button to un-mute.

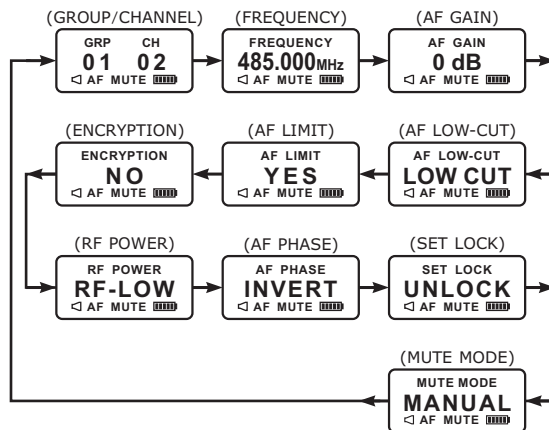
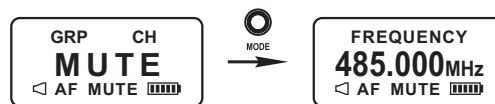
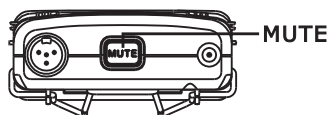

## External Mute Connector

- External mute connector is a 3.5mm jack. When an external mute switch cable, MJ-70 (optional) is connected, user can manually mute and un-mute the audio temporary.

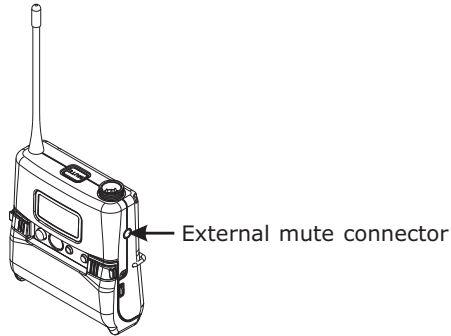

## MJ-70 External Mute Switch (optional)

- B1** 3.5mm jack.
- B2** External mute switch on/off button.

**NOTE:** Plug in the device before power on the bodypack transmitter.

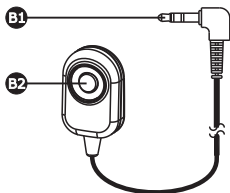

## High Frequency Bypass

- When other microphones are in use, some changes may be needed to another microphone before adding it to the system in order to avoid high frequency interference, as illustrated in diagram (1).
- When a high frequency radio wave causes interference, it normally affects the system by generating a persistent noise or by deteriorating the frequency response. In an effort to ameliorate these problems, a 330PF bypass condenser can be added on the cartridge as shown in diagrams (1) and (2). If this method is not possible, another option is to add a bypass condenser on the 4-pin XLR connector as shown in diagrams (3) and (4).

### \*\*The Best Method

#### (1) Connect to two-wire condenser capsule

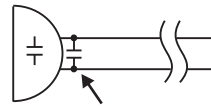

Add 330pF bypass capacitor

#### (2) Connect to three-wire condenser capsule

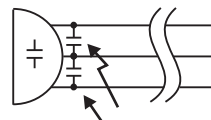

Add 330pF bypass capacitor

**\*\*Alternate Method**

**(3) Connect to two-wire condenser capsule**

Add 330pF bypass capacitor

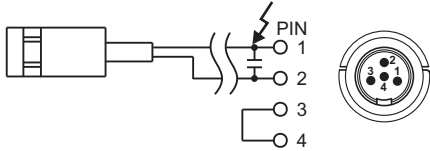

**(4) Connect to three-wire condenser capsule**

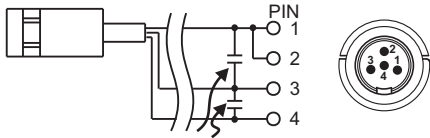

Add 330pF bypass capacitor

**AF Input Connections**

(1) 2-Wire Electret condenser microphone Capsule

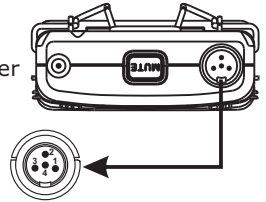
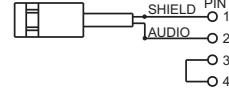

(2) 3-Wire Electret condenser microphone Capsule

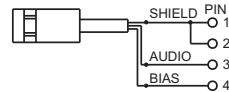

(3) Dynamic Microphone

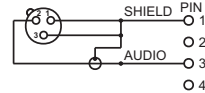

(4) Electric Guitar

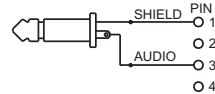

(5) Line-in (Impedance 8KΩ ATT. 10dB)

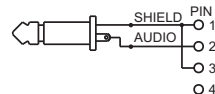

## Battery Removal and Installation

- Pushing down both snap locks on the sides to open battery compartment cover. Take out the one batteries. (Figure 3)
- Insert one charged 18500 rechargeable battery into the battery compartment according to the correct polarity (- and +) as shown in (Figure 4) . Then close the battery compartment cover tightly.

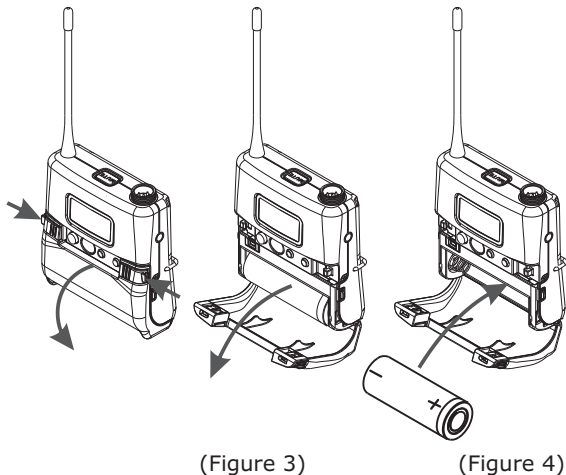

## Caution

Remove the batteries if unused for a long period of time to prevent battery leakage, corrosion and causes possible damage to electronics.

## Caution

Note: Transmitter cannot be powered on with charged battery.

Method 1:

- Ensure battery is inserted correctly with + top side.
- If battery is inserted correctly it could be due to self battery protection mechanism. Insert the transmitter into the charger to re-charge for 10-20 seconds to wake-up the battery. It should work.
- If charger cannot be used, reverse the battery insertion for 10-20 seconds, wake up the battery with correct polarity. It should work.

Method 2:

- Power off the transmitter before open the hinged cover. Press battery protection circuitry reset button once to wake-up battery. Power on the transmitter.

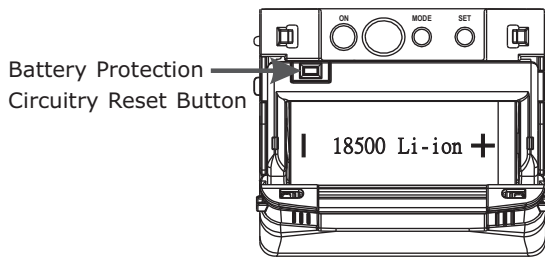

**MP-80 Battery Charger (Optional)**

MP-80 Charger charges both transmitters and 18500 rechargeable batteries.

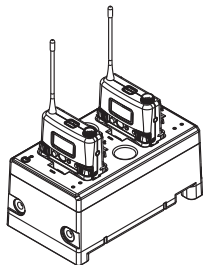

Transmitters Charging

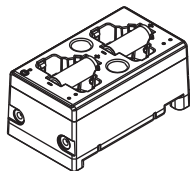

18500 Charging

## Notes

1. Refer to actual product in the event of product description discrepancy.
2. Frequency range and maximum deviation comply with the regulations of different countries.



## FCC

THIS DEVICE COMPLIES WITH PART 74 OF THE FCC RULES.

OPERATION IS SUBJECT TO THE FOLLOWING TWO CONDITIONS:

- (1) This device may not cause interference.
- (2) This device must accept any interference, including interference that may cause undesired operation of the device.

This equipment complies with FCC RF radiation exposure limits set forth for an uncontrolled environment.

## IC

This device complies with Industry Canada RSS-210 ISSUE 8 standards. Operation is subject to the following two conditions:

- (1) this device may not cause interference, and
- (2) this device must accept any interference, including interference that may cause undesired operation of the device.

Le présent appareil est conforme aux CNR d'Industrie Canada applicables aux appareils radio exempts de licence. L'exploitation est autorisée aux deux conditions suivantes:

- (1) l'appareil ne doit pas produire de brouillage, et
- (2) l'utilisateur de l'appareil doit accepter tout brouillage radioélectrique subi, même si le brouillage est susceptible d'en compromettre le fonctionnement.

## WARNING

1. **FOR OUTDOOR USE:**  
To reduce the risk of fire or electric shock, do not expose this apparatus to rain or moisture.
2. **UNDER WET LOCATION:**  
Apparatus should not be exposed to dripping or splashing and no objects filled with liquids, such as vases should be placed on the apparatus.
3. **SERVICE INSTRUCTIONS:**  
CAUTION - These servicing instructions are for use by qualified service personnel only. To reduce the risk of electric shock, do not perform any servicing other than that contained in the operating instructions unless you are qualified to do so.

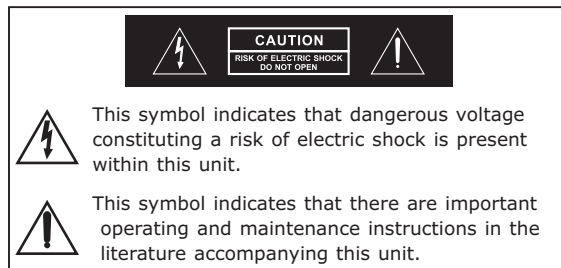

**Disposal** Dispose of any unusable devices or batteries responsibly and in accordance with any applicable regulations.



2006-08-10

Disposing of used batteries with domestic waste is to be avoided!

Batteries / NiCad cells often contain heavy metals such as cadmium(Cd), mercury(Hg) and lead(Pb) that makes them unsuitable for disposal with domestic waste. You may return spent batteries/accumulators free of charge to recycling centres or anywhere else batteries/accumulators are sold.

By doing so, you contribute to the conservation of our environment!