

MIPRO[®]

ACT-80T Wideband Digital Bodypack Transmitter

User Guide



MIPRO MIPRO Electronics Co., Ltd.

Headquarters: 814 Pei-Kang Road, Chiayi, 60096, Taiwan.

Web: www.mipro.com.tw

E-mail: mipro@mipro.com.tw

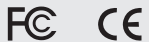

AS120901

Design and specifications are subject to change without prior notice

FCC

This device complies with Part 15 of the FCC Rules. Operation is subject to the following two conditions:

- (1) This device may not cause harmful interference, and
- (2) This device must accept any interference received, including interference that may cause undesired operation.

This device complied with FCC radiation exposure limits as set forth for an uncontrolled environment.

This device should be installed and operated so that its antenna(s) are not co-located or operating in conjunction with any other antenna or transmitter

FCC Caution: To assure continued compliance, any changes or modifications not expressly approved by the party responsible for compliance could void the user's authority to operate this equipment. (Example - use only shielded interface cables when connecting to computer or peripheral devices).

IC

This device complies with Industry Canada's RSSs. Operation is subject to the following two conditions:

- (1) This device may not cause interference; and
- (2) This device must accept any interference, including interference that may cause undesired operation of the device.

Le présent appareil est conforme aux CNR d'Industrie Canada applicables aux appareils radio. L'exploitation est autorisée aux deux conditions suivantes :

- (1) l'appareil ne doit pas produire de brouillage;
- (2) l'utilisateur de l'appareil doit accepter tout brouillage radioélectrique subi, même si le brouillage est susceptible d'en compromettre le fonctionnement.

Disposal

2005-08-13

Dispose of any unusable devices or batteries responsibly and in accordance with any applicable regulations.

Disposing of used batteries with domestic waste is to be avoided!

Batteries / NiCad cells often contain heavy metals such as cadmium(Cd), mercury(Hg) and lead(Pb) that makes them unsuitable for disposal with domestic waste. You may return spent batteries/ accumulators free of charge to recycling centres or anywhere else batteries/accumulators are sold.

By doing so, you contribute to the conservation of our environment!

Contents

1	Key Features
3	Bodypack Controls and Indicators
6	Operating Instructions
7	LCD Display Screen
8	How to Setup Transmitter Parameters
19	Battery Status
22	MUTE Control Set-Up
26	AF Input Connections
27	Battery Removal and Installation

Key Features

- Industry's smallest and lightest digital bodypack transmitter with extremely rugged low-profile metal housing.
- Detachable antenna, XLR input socket, mute button and remote mute control input.
- Backlit LCD displays working band-code, group channel, AF gain, limiter, low cut, phase, output power, mute, battery status, encryption status & error codes.
- Innovatively designed battery cover allows easy access to operate buttons and prevents accidental operation.
- Mute button and remote-control jack is equipped for easy activation of mute function.
- High efficiency, low power consumption and low spurious PLL synthesized circuit is applied.
- An interference-free working channel can be synchronized quickly and precisely by MIPRO's patented ACT™ function.
- Selectable AF input polarity for various microphone capsule modules.
- Mini-XLR input connector for quick screw lock with lavalier / headworn mics and guitar.
- 2 AA batteries for long operation time.
- Adjustable belt clip allows wearing transmitter in any position.

Furnished Accessories:

- USER GUIDE x1

Bodypack Controls and Indicators

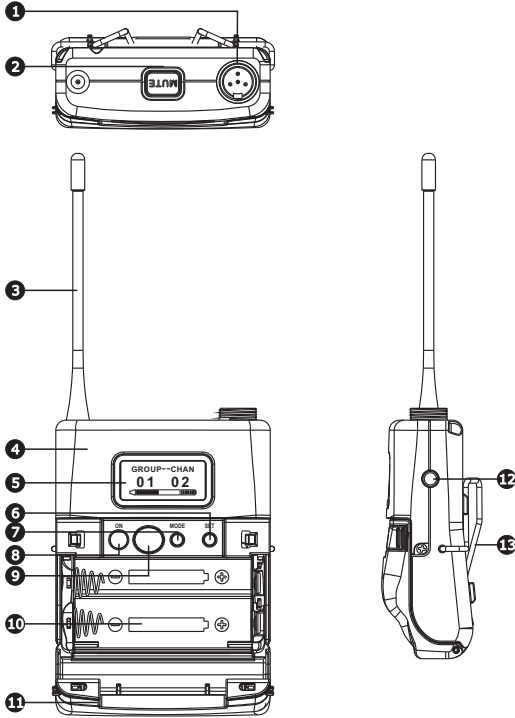

- 1 Audio Input Connector:** TA4F mini 4-pin connector accepts any MIPRO lavalier, instrument and headset microphones and cables. (See 5 ways of connection on AF Input Connections)
- 2 MUTE Button:** To mute and un-mute the audio signal temporary.

- 3 Antenna:** Flexible 1/ 4 wave transmitting antenna.
- 4 Transmitter Housing:** Holds PCB board and wires.
- 5 LCD Panel:** Display transmitter parameters.
- 6 SET Button:** Parameter selection button.
- 7 MODE Button:** Allows access to 9 available functions displaying in LCD panel.
- 8 Power Button:** Press and hold 2 seconds to power ON or OFF.
- 9 ACT IR Port:** Align and syncs the transmitter and receiver frequency automatically.
- 10 Battery Compartment:** Holds 2 'AA' batteries.
- 11 Battery Cover:** Hinged cover opens to provide access to 2 'AA' batteries.
- 12 External Mute Connector:** When an external mute switch cable, MJ-70 (optional) is connected, user can manually mute and un-mute the audio temporary.
- 13 Belt Clip:** Detachable and reversible design allows the transmitter to be worn on a belt, waistband, or guitar strap (Figure 1).

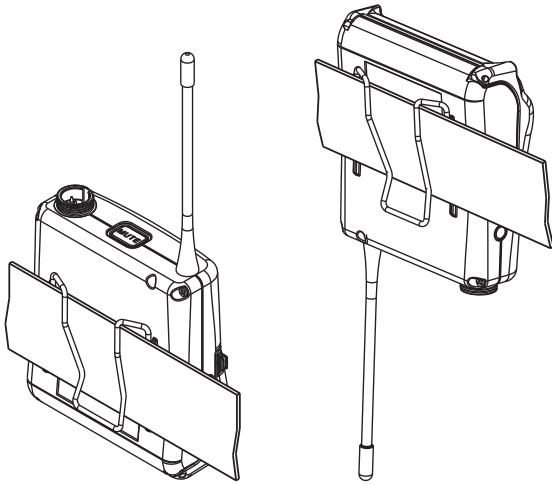

(Positive Wear)

(Opposite Wear)

(Figure 1)

Operating Instructions

- Please make sure sensitivity level is set at proper level.
- Guitar setting is recommended at LINE level.
- Insert the lavalier, headset microphone or instrument cable into the audio input connector before power ON the transmitter.
- Tighten the connector screw clockwise direction as shown in (Figure 2) for a secured fit.

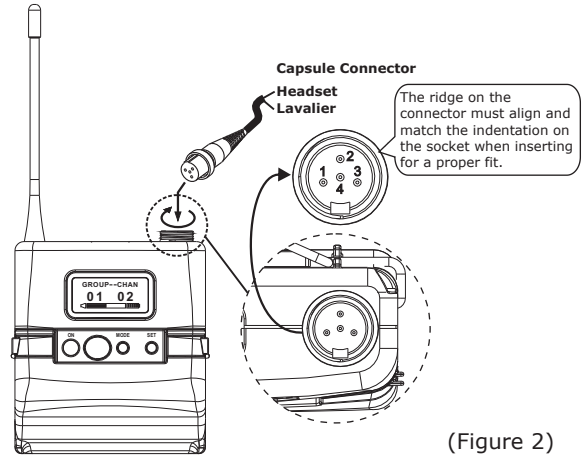

(Figure 2)

LCD Display Screen

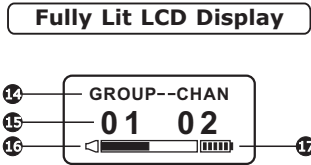

- 14 LCD Screen
- 15 Parameters Screen
- 16 AF (audio) MUTE
- 17 Transmitter Battery Meter

How to Setup Transmitter Parameters

- **MODE** Button:
Press "**MODE**" button to access one of the NINE functions below.
- **SET** Button:
Press "**SET**" button and LCD will start flashing. During flashing, press SET button to change parameters.

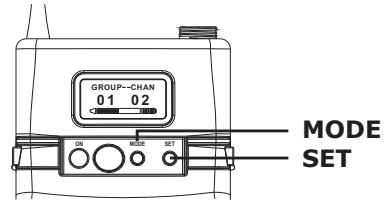

Digital Bodypack Transmitter

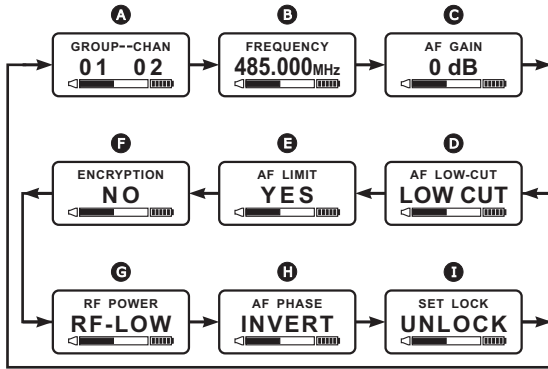

- A** Group and Channel
- B** Frequency
- C** Sensitivity Level
- D** AF Low Cut
- E** AF Limit
- F** Encryption
- G** RF Output Power
- H** AF Phase
- I** Parameters Lock & Unlock Status

Digital Bodypack Transmitter

GR-CH: Displays Group and Channel Information

- a. Press **MODE** and stop on the **GR-CH** function; the display showing the current group and channel will be flashing. After 5 seconds, the display will stop flashing and the current group and channel selection will be set.
- b. The group and channel information is now shown on the display. Changing the current group and channel must be done on the receiver.



**Note:

When programming a special frequency via monitoring software, the LCD screen cannot display the number. This is because this special channel is not in the preset group and channel. RF, the LCD panel will look like the illustration below.



FREQUENCY: Displays Transmitter Frequency Information

- a. Press **MODE** and stop on the **FREQUENCY** function; the display showing the current frequency will be flashing. After 5 seconds, the display will stop flashing.
- b. The frequency information is now shown on the display. Changing the current frequency must be done on the receiver.

****Note:**

To modify the transmitter's group, channel and frequency, all three must be set at the receiver and the new setting transmitted to the transmitter via the ACT function.



AF GAIN: Setup and Change of Input Sensitivity

- a. Press **MODE** and stop on the **AF GAIN** function; the display showing the current status will be flashing and is ready to be modified.
- b. Every push of the **SET** button increases the dB value by 6dB to a maximum of 18dB.

****Note:**

1. The higher the gains are set, the lower the dynamic range for signal input and the greater the danger of unwanted noises and feedback getting into the system.
2. When using electronic guitar, gain should set at 0dB.
3. Please make sure input signal strength does not exceed 2 Vrms (gain=6dB) as it is the maximum input strength allowed for transmitter without causing distortion.

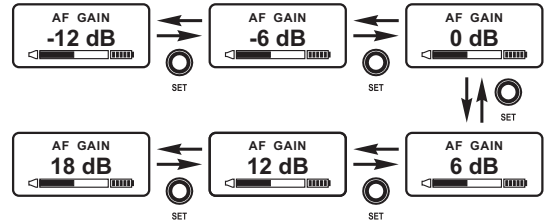

AF LOW-CUT: Setup and Change of Low Frequency Cut Off

- a. Press **MODE** and stop on the **AF LOW-CUT** function; the display showing the current status will be flashing and is ready to be modified.
- b. Press the **SET** button while the display is flashing to change to **LOW CUT** or **FLAT** as desired.

****Note:**

When the AF LOW-CUT function is LOW CUT, the frequency response below 100Hz will decrease about 3dB with a slope of -6dB/Octave.

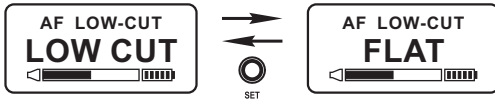

AF LIMIT: Setup and Change of Input Limit

- a. Press **MODE** and stop on the **AF LIMIT** function; the display showing the current status will be flashing and is ready to be modified.
- b. Press **SET** while the display is flashing to change the setting to **ON** or **OFF**.

****Note:**

When the LIMIT is ON, the maximum output of the receiver is limited to 1V.

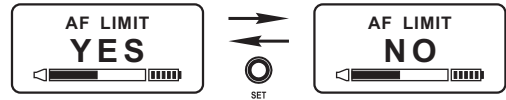

ENCRYPTION: Displays Information of Encryption

- a. Press **MODE** and stop on the **ENCRYPTION** function; the display showing the current status will be flashing.

****Note:**

1. The ENCRYPTION function displays status information only. Changing of the current status must be done from the receiver via the ACT function.
2. The ENCRYPTION function must be set at receiver first then using ACT to program the transmitter.



RF POWER: RF Power Selection

- a. Press **MODE** button for selection of **RF POWER**. Selection of **RF-HI** or **RF-LOW** can be selected once the RF POWER LCD starts blinking.
- b. Press **SET** button to select and set **RF-HI** or **RF-LOW**.

****Note:**

RF-HI has 50mW transmitting power. RF-LOW has 10mW transmitting power. Set appropriate power to meet region/country regulations.

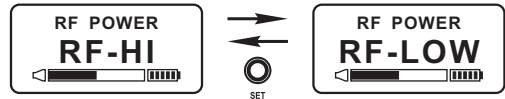

AF PHASE: Phase Selection of AF inputs

- a. Press **MODE** button for selection of **AF PHASE**. Selection of **NORMAL** or **INVERT** can be selected once the **AF PHASE** LCD starts blinking.
- b. Press **SET** button to select and set **NORMAL** or **INVERT**.

****Note:**

AF PHASE function provides users a phase selection for different condenser microphones. The normal setting is **NORMAL**, and **INVERT** might be selected if two-wire condenser microphone is used.

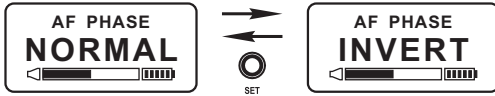

SET LOCK: Setup and Change of Parameter Lock

- a. Press **MODE** button once for **SET LOCK** display. Once **SET LOCK** display starts blinking it is ready for selection.
- b. Press **SET** button for **UNLOCK** or **LOCK** selection.

****NOTE:**

1. When locked (LOCK), receiver settings cannot be changed including the powering on & powering off. To power off it needs to be in unlock mode (UNLOCK).
2. A sudden lose of power will deactivate the LOCK Function.
3. MUTE function can be operated normally during LOCK mode.

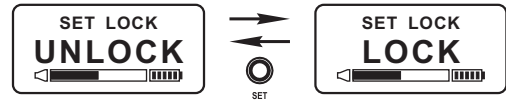

Battery Status

Indicates the power remaining in the transmitter battery. When the battery has less than 10% power remaining it must be replaced or recharged. If an under voltage condition continues, the LCD will show "OFF..." and the system will shut down to prevent being overly discharged.

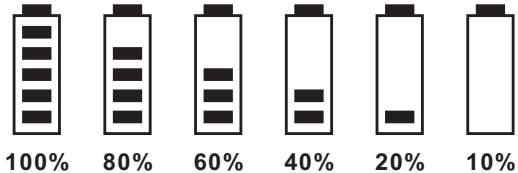
**"OFF..." : Power Off**

1. Press and hold power button for 2 seconds to power on & off.
2. When the power switch is turned off, the LCD will show "OFF..." (for Power Off) first and then the system will shut down and no further messages will be displayed.

OFF...

ERR: Error Code

If the LCD displays "ERR" after turning on the power, it indicates the operation is not correct. The error codes are as follows:

ROM-ER → Transmitter does not have the initial data so the microphone is completely dead and cannot be programmed.

ERROR1 → Failure on RF circuitry, frequency cannot be programmed.

NO----OR3 → Frequency to be programmed into the transmitter exceeds the highest frequency of the designated frequency band of the transmitter.

NO----OR4 → Frequency to be programmed into the transmitter exceeds the lowest frequency of the designated frequency band of the transmitter.

****Note:**

NO----OR3 and NO----OR4 will not change the transmitter's original frequency and the transmitter will still operate normally with the error message on display. To remove the error message from the display panel, please switch off the transmitter and switch it on again.

MUTE Control Set-Up

MUTE control enables audio to be muted or unmuted temporarily.

- Press **MUTE** button to mute audio temporarily. Parameter values can be changed and ACT sync activate during this **MUTE** mode.
- Press **MUTE** button to un-mute.

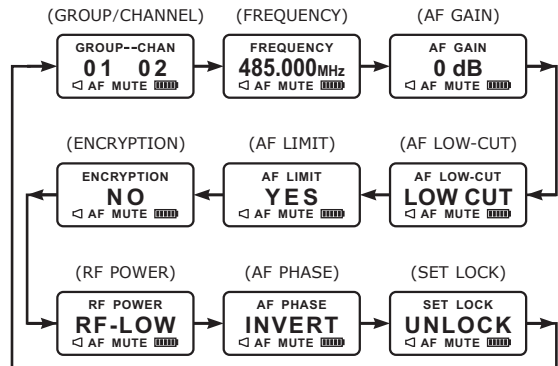
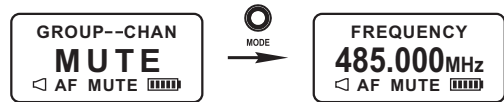

External Mute Connector

- External mute connector is a 3.5mm jack. When an external mute switch cable, MJ-70 (optional) is connected, user can manually mute and un-mute the audio temporary.

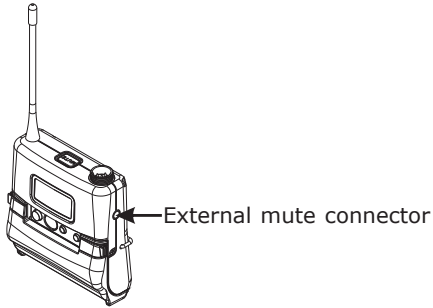

MJ-70 External Mute Switch (optional)

- 18 3.5mm jack.
- 19 External mute switch on/off button.

Note: Plug in the device before power on the bodypack transmitter.

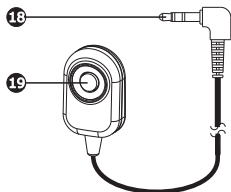

High Frequency Bypass

- When other microphones are in use, some changes may be needed to another microphone before adding it to the system in order to avoid high frequency interference, as illustrated in diagram (1).
- When a high frequency radio wave causes interference, it normally affects the system by generating a persistent noise or by deteriorating the frequency response. In an effort to ameliorate these problems, a 330PF bypass condenser can be added on the cartridge as shown in diagrams (1) and (2). If this method is not possible, another option is to add a bypass condenser on the 4-pin XLR connector as shown in diagrams (3) and (4).

**The Best Method

(1) Connect to two-wire condenser capsule

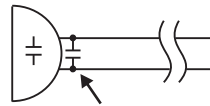

Add 330pF bypass capacitor

(2) Connect to three-wire condenser capsule

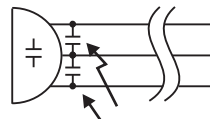

Add 330pF bypass capacitor

****Alternate Method**

(3) Connect to two-wire condenser capsule

Add 330pF bypass capacitor

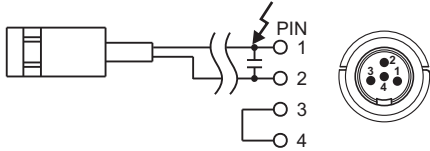

(4) Connect to three-wire condenser capsule

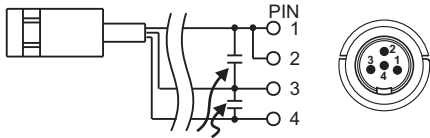

Add 330pF bypass capacitor

AF Input Connections

(1) 2-Wire Electret condenser microphone Capsule

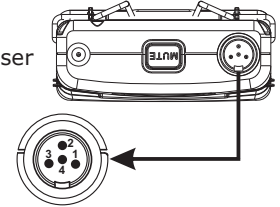
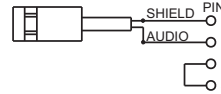

(2) 3-Wire Electret condenser microphone Capsule

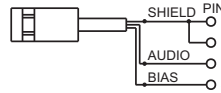

(3) Dynamic Microphone

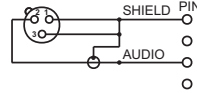

(4) Electric Guitar

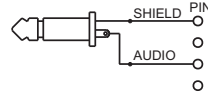

(5) Line-in (Impedance 8KΩ ATT. 10dB)

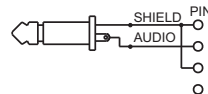

Battery Removal and Installation

- Pushing down both snap locks on the sides to open battery compartment cover. Take out the two batteries. (Figure 3)
- Insert two fresh AA batteries (alkaline type is recommended) into the battery compartment according to the correct polarity (- and +) as shown in (Figure 4). Then close the battery compartment cover tightly.

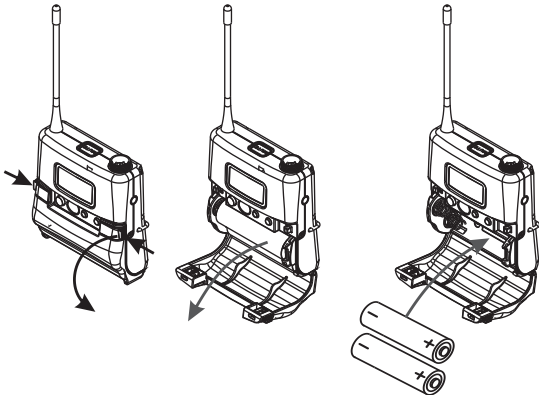

(Figure 3)

(Figure 4)

Caution:

Remove the batteries if unused for a long period of time to prevent battery leakage, corrosion and causes possible damage to electronics.

Disassemble the Belt Clip

- Turn the bodypack transmitter to the back side like the right diagram.



- Pull open one side of the belt clip and make it depart from the slot of the bodypack transmitter like the right diagram.

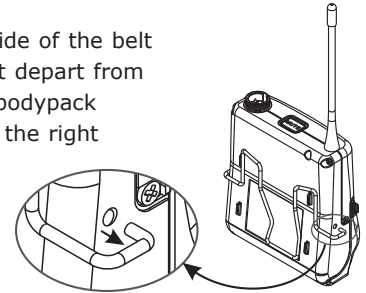

- Then the other side of the belt clip can be departed from the other slot easily. The whole belt clip is departed from the bodypack transmitter completely like the right diagram.

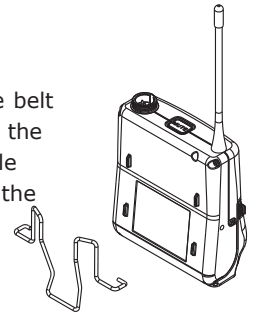

Assemble the Belt Clip

- Turn the bodypack transmitter to the back side. Put the belt clip to the right direction and aim the one side of the belt clip to the slot of the bodypack transmitter like the right diagram.

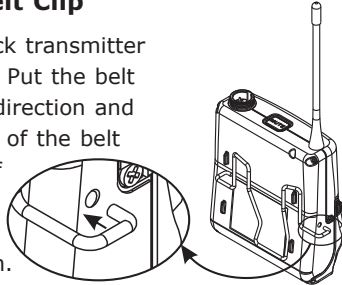

- For opposite wear of bodypack transmitter, just rotate the belt clip by 180°C like the right diagram.

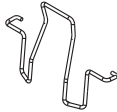

- Put one side of the belt clip to the slot of bodypack transmitter and fix it like the right diagram.



- Pull open the other side of the belt clip and put it to the other slot of bodypack transmitter and fix it like the right diagram.

