

MIPRO[®]

User Guide

ACT-80HC DIGITAL TRANSMITTER



MIPRO[®]
MICROPHONE PROFESSIONALS

MIPRO Electronics Co., Ltd

Headquarters : 814 Pei-Kang Road, Chiayi, 60096, Taiwan
Tel : +886.5.238.0809 Fax : +886.5.238.0803
www.mipro.com.tw mipro@mipro.com.tw

All rights reserved. MN 015/01

Do not copy or forward without prior approvals MIPRO.

Specifications and design subject to change without notice.



2 CE 5 0 9 A

Contents

- 1 Handheld Controls and Indicators
- 3 Operating Instructions for Insertion & Removing Battery
- 5 Patented Protection Cover
- 7 LCD Display Screen
- 8 How to Setup Transmitter Parameters
- 19 Battery Status
- 22 Setting MUTE
- 23 General Tips for Improving System Performance

Handheld Controls and Indicators

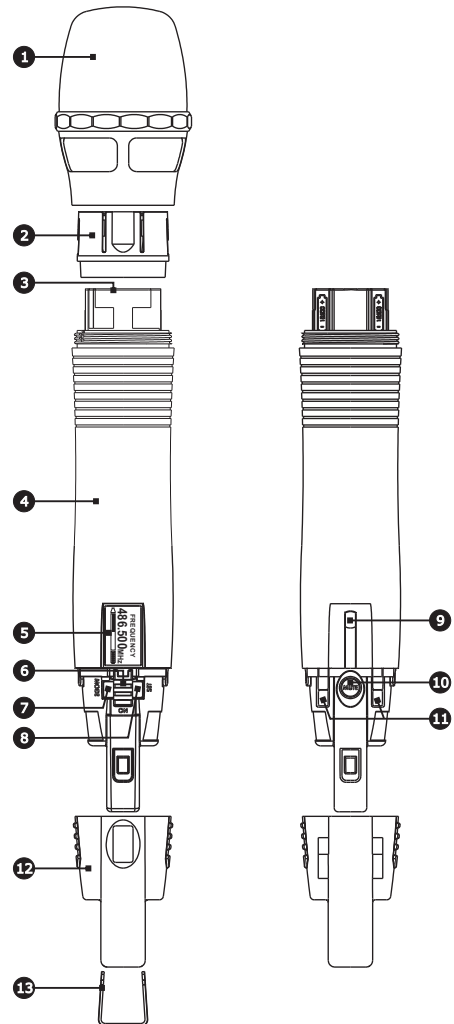

- ❶ **Capsule Module:** Protects detachable microphone capsule module and internal foam prevents breathing, wind and POP noises.
- ❷ **Fixed Ring**
- ❸ **Battery Compartment:** Accommodates one 18500 rechargeable battery.
- ❹ **Housing:** Protects transmitter PCB, battery compartment and batteries.
- ❺ **LCD Panel:** Displays transmitter parameters.
- ❻ **Power On/Off Switch:** Slides the power switch to the "ON" position for use or to the "OFF" position when not in use.
- ❼ **MODE Button:** Allows access to available functions displaying in LCD panel.
- ❽ **SET Button:** Changes parameters.
- ❾ **ACT Infrared (IR) Port:** Receives signals from receiver to synchronize frequencies.
- ❿ **MUTE Button:** To mute and un-mute the audio signal temporary.
- ⓫ **Battery Charging Contact:** Align contacts during charging.
- ⓬ **Protection Cover:** Protects power switch and prevents user has direct access to power switch.
- ⓭ **Channel ID Clip:** For channel identification (Optional)

Operating Instructions for Insertion & Removing Battery

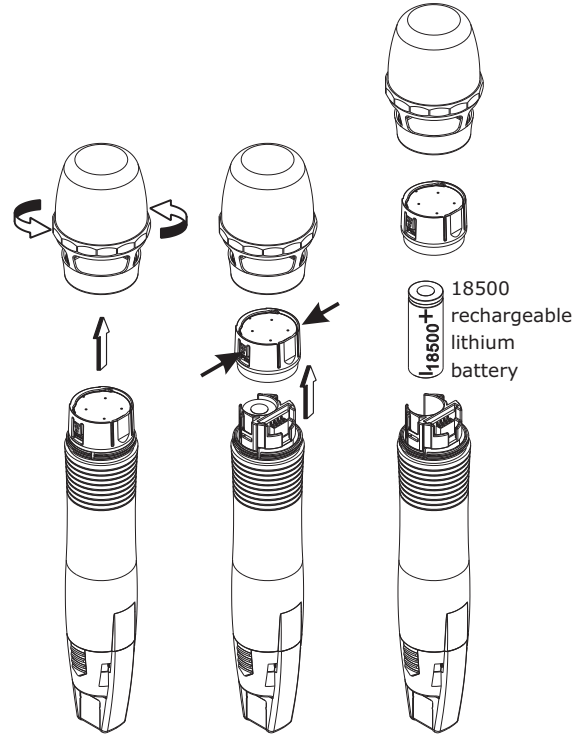

- Rotate and remove microphone grill counter clock direction.
- Press both sides of Fixed Ring to pull out Fixed Ring.
- Insert or remove battery accordingly. Insert battery according to its correct polarity for a proper fit. Wrong polarity will not fit properly.
- Power on the transmitter to check if battery is fresh and inserted correctly. LCD lit denotes battery inserted correctly.

Note: Transmitter cannot be powered on with charged battery.

- Ensure battery is inserted correctly with + top side.
- If battery is inserted correctly it could be due to self battery protection mechanism. Insert the transmitter into the charger to re-charge for 10-20 seconds to wake-up the battery. It should work.
- If charger cannot be used, reverse the battery insertion for 10-20 seconds, wake up the battery with correct polarity. It should work.
- Always power off after each use. Remove the internal battery if it will not be used for an extended period of time.

Patented Protection Cover

Protection cover's patented design protects accidental access to power switch and its rugged material and snug fit offer protection to both power switch and PCB during accidental drop.

Steps

- Remove protection cover.

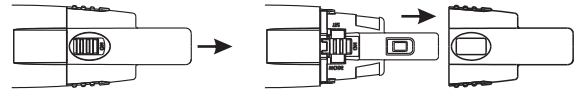

- Reverse protection cover.

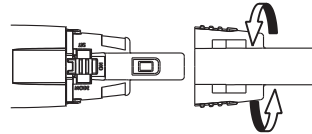

- Install protection cover to protect accidental power on/off.

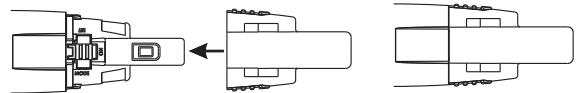

- Mute function is open for easy access.

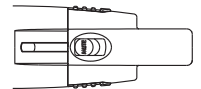

- When power is off, reverse-installation of protection cover will turn on the switch automatically. To turn off the system, remove the cover to turn off.
- Protection cover must be attached during operation for full protection.
- Color-coded channel identification clip can be attached to the bottom of protection cover.

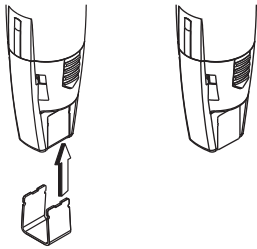

MP-80 Battery Charger (Optional)

MP-80 Charger charges both transmitters and 18500 rechargeable batteries.

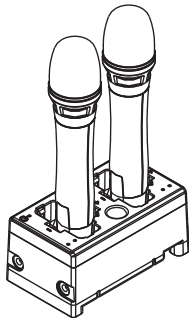

Transmitters Charging

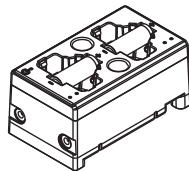

18500 Charging

LCD Display Screen

Fully Lit LCD Display

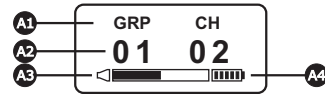

- A1 LCD Screen
- A2 Parameters Screen
- A3 AF (audio) MUTE
- A4 Transmitter Battery Meter

How to Setup Transmitter Parameters

- Remove protection cover to expose MODE button and SET button.
- MODE Button:**
Press "MODE" button to access one of the six functions below.
- SET Button:**
Press "SET" button and LCD will start flashing. During flashing, press SET button to change parameters.

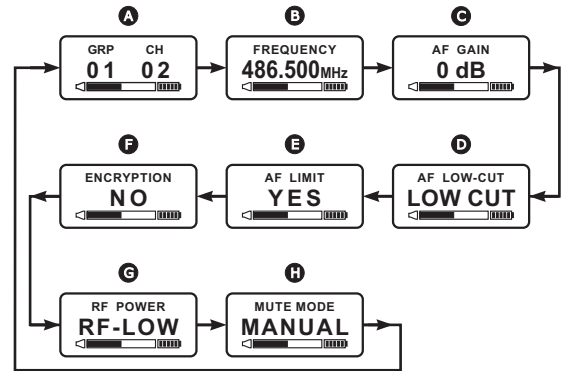
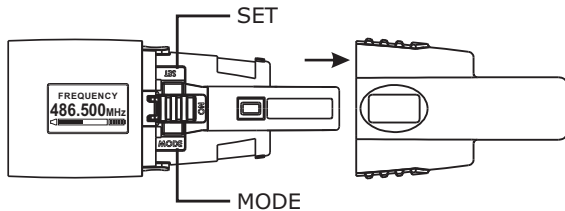

- A** Group and Channel
- B** Frequency
- C** Sensitivity Level
- D** AF Low Cut
- E** AF Limit
- F** Encryption
- G** RF Output Power
- H** MUTE Mode

GRP CH: Displays Group and Channel Information

- Press **MODE** and stop on the **GRP CH** function; the display showing the current group and channel will be flashing. After 5 seconds, the display will stop flashing and the current group and channel selection will be set.
- The group and channel information is now shown on the display. Changing the current group and channel must be done on the receiver.

****NOTE:**

When programming a special frequency via monitoring software, the LCD screen cannot display the number. This is because this special channel is not in the preset group and channel. RF, the LCD panel will look like the illustration below.

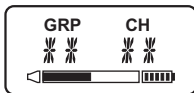
**FREQUENCY:** Displays Transmitter Frequency Information

- Press **MODE** and stop on the **FREQUENCY** function; the display showing the current frequency will be flashing. After 5 seconds, the display will stop flashing.
- The frequency information is now shown on the display. Changing the current frequency must be done on the receiver.

****NOTE:**

To modify the transmitter's group, channel and frequency, all three must be set at the receiver and the new setting transmitted to the transmitter via the ACT function.



AF GAIN: Setup and Change of Input Sensitivity

- Press **MODE** and stop on the **AF GAIN** function; the display showing the current status will be flashing and is ready to be modified.
- Every push of the **SET** button increases the dB value by 3dB to a maximum of 6dB.

****NOTE:**

- The higher the gains are set, the lower the dynamic range for signal input and the greater the danger of unwanted noises and feedback getting into the system.
- When using electronic guitar, gain should set at 0dB.
- Please make sure input signal strength does not exceed 2 Vrms (gain=6dB) as it is the maximum input strength allowed for transmitter without causing distortion.

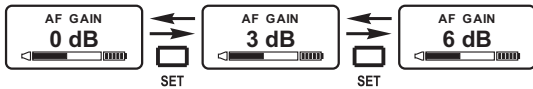
**AF LOW-CUT:** Setup and Change of Low Frequency Cut Off

- Press **MODE** and stop on the **AF LOW-CUT** function; the display showing the current status will be flashing and is ready to be modified.
- Press the **SET** button while the display is flashing to change to **LOW CUT** or **FLAT** as desired.

****NOTE:**

When the AF LOW-CUT function is LOW CUT, the frequency response below 100Hz will decrease about 3dB with a slope of -6dB/Octave.

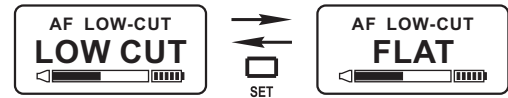

AF LIMIT: Setup and Change of Input Limit

- Press **MODE** and stop on the **AF LIMIT** function; the display showing the current status will be flashing and is ready to be modified.
- Press **SET** while the display is flashing to change the setting to **ON** or **OFF**.

****NOTE:**

When the LIMIT is ON, the maximum output of the receiver is limited to 1V.

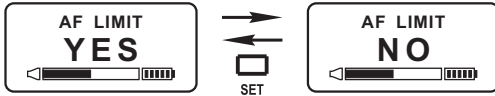
**ENCRYPTION:** Displays Information of Encryption

- Press **MODE** and stop on the **ENCRYPTION** function; the display showing the current status will be flashing.

****NOTE:**

- The ENCRYPTION function displays status information only. Changing of the current status must be done from the receiver via the ACT function.
- The ENCRYPTION function must be set at receiver first then using ACT to program the transmitter.



RF POWER: RF Power Selection

- a. Press **MODE** button for selection of **RF POWER**. Selection of **RF-HI** or **RF-LOW** can be selected once the RF POWER LCD starts blinking.
- b. Press **SET** button to select and set **RF-HI** or **RF-LOW**.

****NOTE:**

RF-HI has 50mW transmitting power. RF-LOW has 10mW transmitting power. Set appropriate power to meet region/country regulations.

**MUTE MODE:** Mute model selection

- a. Press **MODE** button for selection of **MUTE MODE**. Selection of **MANUAL** or **AUTO** or **DISABLE** can be selected once the **MUTE MODE** LCD starts blinking.
- b. Press **SET** button to select and set **MANUAL** or **AUTO** or **DISABLE**.
- c. LCD will stop blinking and change will not be saved if setting is not done within 5 seconds.
- d. **MANUAL: Mute** function is controlled by the **Mute** button at "**MANUAL**" mode.
 - Press **Mute** button to enter mute status. At mute status, AF indicators will become "**AF MUTE**" and blink continuously. Press **Mute** button again to release mute status.
 - **AF MUTE** status will be released automatically when turning off.
- e. **AUTO: Mute** button can not be activated at the **AUTO** mode. Mute function will be activated by the microphone itself automatically.
 - Microphone will enter mute status when positioning the capsule downward and the mute status will be released automatically when positioning the capsule upward.
 - Idle the microphone for 4 seconds to enter mute status automatically. Touch or use the microphone again to release the mute status.
- f. **DISABLE: MUTE** button is not operable.

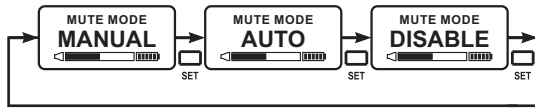

Battery Status

Indicates the power remaining in the transmitter battery. When the battery has less than 10% power remaining it must be replaced. If an under voltage condition continues, the LCD will show "OFF..." and the system will shut down to prevent being overly discharged.

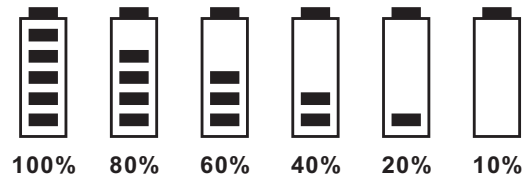

Power Button

- Turn the power switch to **ON** position where transmitter will be activated and LCD will lit up.
- Turn the power switch to **OFF** position to shut down the transmitter.
- When the power switch is turned off, the LCD will show "**OFF...**" (for Power Off) first and then the system will shut down and no further messages will be displayed.



OFF...

ERR: Error Code

If the LCD displays "ERR" after turning on the power, it indicates the operation is not correct. The error codes are as follows:

ROM-ER → Transmitter does not have the initial data so the microphone is completely dead and cannot be programmed.

ERROR1 → Failure on RF circuitry, frequency cannot be programmed.

NO----OR3 → Frequency to be programmed into the transmitter exceeds the highest frequency of the designated frequency band of the transmitter.

NO----OR4 → Frequency to be programmed into the transmitter exceeds the lowest frequency of the designated frequency band of the transmitter.

****NOTE:**

NO----OR3 and NO----OR4 will not change the transmitter's original frequency and the transmitter will still operate normally with the error message on display. To remove the error message from the display panel, please switch off the transmitter and switch it on again.

Setting MUTE

- Press **MUTE** button to enter mute status. At mute status, AF indicators will become "**AF MUTE**" and blink continuously. All the functions can be operated and ACT can be activated at the mute status. All the operations of functions are the same with the ones at regular status.
- Press **MUTE** button again to release mute status ; AF MUTE status will be released automatically when turning off.
- MUTE** button can be activated at "**MANUAL**" mode.

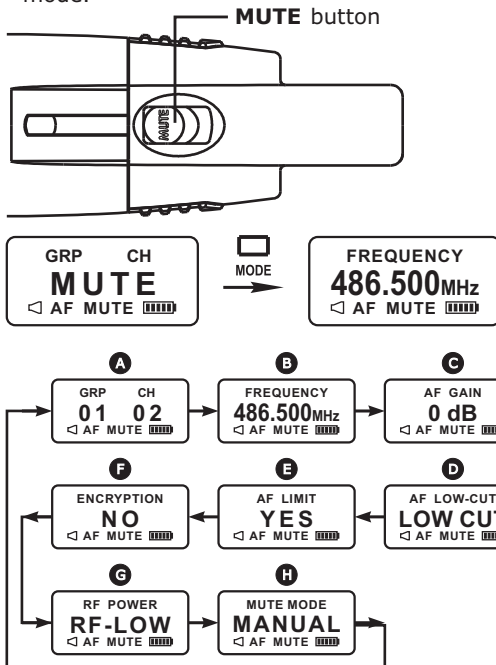

General Tips for Improving System Performance

1. Performer should avoid holding the microphone over or near the antenna section as this will deteriorate transmission efficiency. Severe deterioration if performer directly covers up the antenna section with both hands.
2. Many performers tend to hold the microphone by the top grille. Unfortunately, this position seriously degrades both the sound quality and directionality of a microphone. Even the most expensive microphones will have its original sound quality compromised by this method. Grabbing a microphone by the grille will isolate the capsule's acoustic resonance circuit and or change the capsule resonator's frequency. This results in an inferior performance in both frequency response and the separation of directionality. In addition, a palm's sound-focusing effect will tend to strengthen resonances in certain frequencies and can cause unwanted echo.
3. A proper technique is required for using directional microphones because the distance between the microphone and your mouth has a significant impact on sensitivity and performance. There is an inverse relationship between microphone sensitivity and the distance from the mouth to the microphone. Consequently, performers with a "weaker" sound level cannot expect to hold the microphone too far away from their mouth and compensate by turning up the amplifier volume to increase the sound level as this can easily cause echo or feedback. In contrast, performers with a "louder" sound level should not hold the microphone too close as this can easily result in distortion by causing the amplifier system to be overloaded.

4. Furthermore, a large-diaphragm directional microphone has a very distinct proximity effect. When the microphone is close to the mouth, the bass response is strengthened as the distance gets closer. Therefore, if a performer's sound is insufficient in bass, they can hold the microphone closer and use the proximity effect to help compensate for the lower bass level. Conversely, if a performer's voice is too heavy in the bass register, increasing the distance between the microphone and their mouth will decrease the proximity effect and reduce the bass response, thus making their voice become clearer and brighter.
5. It is recommended to keep the grille and sponge windscreen clean to avoid any substance blocking the proximity effect of the microphone.

Notes

1. Refer to actual product in the event of product description discrepancy.
2. Frequency range and maximum deviation comply with the regulations of different countries.

FCC

This device complies with Part 15 of the FCC Rules. Operation is subject to the following two conditions:

- (1) This device may not cause harmful interference, and
- (2) This device must accept any interference received, including interference that may cause undesired operation.

This device complied with FCC radiation exposure limits as set forth for an uncontrolled environment.

This device should be installed and operated so that its antenna(s) are not co-located or operating in conjunction with any other antenna or transmitter

FCC Caution: To assure continued compliance, any changes or modifications not expressly approved by the party responsible for compliance could void the user's authority to operate this equipment. (Example - use only shielded interface cables when connecting to computer or peripheral devices).

IC

This device complies with Industry Canada's RSSs. Operation is subject to the following two conditions:

- (1) This device may not cause interference; and
- (2) This device must accept any interference, including interference that may cause undesired operation of the device.

Le présent appareil est conforme aux CNR d'Industrie Canada applicables aux appareils radio. L'exploitation est autorisée aux deux conditions suivantes :

- (1) l'appareil ne doit pas produire de brouillage;
- (2) l'utilisateur de l'appareil doit accepter tout brouillage radioélectrique subi, même si le brouillage est susceptible d'en compromettre le fonctionnement.

WARNING**1. FOR OUTDOOR USE:**

To reduce the risk of fire or electric shock, do not expose this apparatus to rain or moisture.

2. UNDER WET LOCATION:

Apparatus should not be exposed to dripping or splashing and no objects filled with liquids, such as vases should be placed on the apparatus.

3. SERVICE INSTRUCTIONS:

CAUTION - These servicing instructions are for use by qualified service personnel only. To reduce the risk of electric shock, do not perform any servicing other than that contained in the operating instructions unless you are qualified to do so.



This symbol indicates that dangerous voltage constituting a risk of electric shock is present within this unit.



This symbol indicates that there are important operating and maintenance instructions in the literature accompanying this unit.

Disposal Dispose of any unusable devices or batteries responsibly and in accordance with any applicable regulations.



Disposing of used batteries with domestic waste is to be avoided!

2005-06-10

Batteries / NiCad cells often contain heavy metals such as cadmium(Cd), mercury(Hg) and lead(Pb) that makes them unsuitable for disposal with domestic waste. You may return spent batteries/accumulators free of charge to recycling centres or anywhere else batteries/accumulators are sold.

By doing so, you contribute to the conservation of our environment!