

FCC PART 74.861 TEST REPORT

for

Transmitter

Model No.: ACT-7T

FCC ID: M5X-ACT7T

of

Applicant: **MIPRO Electronics Co., Ltd.**

Address: **814 Pei-kang Road Chia-yi 600 Taiwan, R.O.C**

Tested and Prepared

by

Worldwide Testing Services (Taiwan) Co., Ltd.

FCC Registration No.: 930600

Industry Canada filed test laboratory Reg. No. IC 5679A-1

A2LA Accredited No.: 2732.01



Report No.: W6M20902-9587-C-1

6F, NO. 58, LANE 188, RUEY-KUANG RD., NEIHU TAIPEI 114, TAIWAN, R.O.C.
TEL: 886-2-66068877 FAX: 886-2-66068879 E-mail: wts@wts-lab.com



Registration number: W6M20902-9587-C-1
FCC ID: M5X-ACT7T

TABLE OF CONTENTS

1	GENERAL INFORMATION.....	3
1.1	NOTES.....	3
1.2	TESTING LABORATORY	4
1.2.1	Location	4
1.2.2	Details of accreditation status	4
1.3	DETAILS OF APPROVAL HOLDER.....	5
1.4	APPLICATION DETAILS	5
1.5	GENERAL INFORMATION OF TEST ITEM	5
1.6	TEST STANDARDS.....	6
2	TECHNICAL TEST	7
2.1	SUMMARY OF TEST RESULTS	7
2.2	TEST ENVIRONMENT	7
2.3	TEST EQUIPMENT LIST	8
2.4	GENERAL TEST PROCEDURE	10
3	TEST RESULTS (ENCLOSURE)	11
4	RF POWER OUTPUT (CONDUCTED) , FCC 2.1046 (A) ; 74.861 (E)	12
4.1	TEST PROCEDURE.....	12
4.2	TEST RESULTS	12
5	RADIATED POWER.....	13
5.1	TEST PROCEDURE	13
5.2	TEST RESULTS	14
6	MODULATION DEVIATION , FCC 2.1047 (B) ; 74.861(E).....	16
6.1	TEST PROCEDURE.....	16
6.2	TEST RESULTS.....	16
7	AUDIO FREQUENCY RESPONSE , FCC 2.1047 (A).....	17
7.1	TEST PROCEDURE.....	17
7.2	TEST RESULTS.....	17
8	OCCUPIED BANDWIDTH/EMISSION MASK, FCC 2.1049 (C) ; 74.861 (E)(5)	18
8.1	TEST PROCEDURE.....	18
8.2	TEST RESULTS	18
9	SPURIOUS EMISSIONS AT ANTENNA TERMINALS FCC2.1051 ; 74.861 (E)	19
9.1	TEST PROCEDURE.....	19
9.2	TEST RESULTS	19
9.3	LIMIT	19
10	RADIATED SPURIOUS EMISSION , FCC 2.1053 ; 74.861 (E).....	20



Worldwide Testing Services(Taiwan) Co., Ltd.

Registration number: W6M20902-9587-C-1

FCC ID: M5X-ACT7T

10.1	TEST PROCEDURE.....	20
10.2	TEST RESULTS	20
10.3	EXPLANATION OF TEST RESULT.....	22
10.4	LIMITS	23
11	LINE CONDUCTED EMISSION , FCC 15.207.....	24
11.1	TEST PROCEDURE.....	24
11.2	TEST RESULTS	24
12	FREQUENCY STABILITY VS. TEMPERATURE , FCC 2.1055 , 74.861 (E)	25
12.1	TEST PROCEDURE.....	25
12.2	TEST RESULTS	25
13	FREQUENCY STABILITY VS. VOLTAGE , FCC 2.1055 (D) ; 74.861 (E).....	27
13.1	TEST PROCEDURE.....	27
13.2	TEST RESULTS	27
APPENDIX		28



Worldwide Testing Services(Taiwan) Co., Ltd.

Registration number: W6M20902-9587-C-1
FCC ID: M5X-ACT7T

1 General Information

1.1 Notes

The purpose of conformity testing is to increase the probability of adherence to the essential requirements or conformity specifications, as appropriate.

The complexity of the technical specifications, however, means that full and thorough testing is impractical for both technical and economic reasons.

Furthermore, there is no guarantee that a test sample which has passed all the relevant tests conforms to a specification.

Neither is there any guarantee that such a test sample will interwork with other genuinely open systems. The existence of the tests nevertheless provides the confidence that the test sample possesses the qualities as maintained and that its performance generally conforms to representative cases of communications equipment.

The test results of this test report relate exclusively to the item tested as specified in 1.5.

The test report may only be reproduced or published in full.

Reproduction or publication of extracts from the report requires the prior written approval of the Worldwide Testing Services (Taiwan) Co., Ltd.

Tester:

April 3, 2009

Danny Sung

Date

WTS-Lab.

Name

Signature

Technical responsibility for area of testing:

April 3, 2009

Chang Tse-Ming

Date

WTS

Name

Signature



Worldwide Testing Services(Taiwan) Co., Ltd.

Registration number: W6M20902-9587-C-1
FCC ID: M5X-ACT7T

1.2 Testing laboratory

1.2.1 Location

OATS
No.5-1, Shuang Sing Village,
LiShuei Rd., Wanli Township,
Taipei County 207, Taiwan (R.O.C.)

Company
Worldwide Testing Services(Taiwan) Co., Ltd.
6F, NO. 58, LANE 188, RUEY-KUANG RD.
NEIHU, TAIPEI 114, TAIWAN R.O.C.
Tel : 886-2-66068877
Fax : 886-2-66068879

1.2.2 Details of accreditation status

Accredited testing laboratory

A2LA accredited number: 2732.01

FCC filed test laboratory Reg. No. 930600

Industry Canada filed test laboratory Reg. No. IC 5679A-1



Test location, where different from Worldwide Testing Services (Taiwan) Co., Ltd. :

Name: ./.
Accredited number: ./.
Street: ./.
Town: ./.
Country: ./.
Telephone: ./.
Fax: ./.



Worldwide Testing Services(Taiwan) Co., Ltd.

Registration number: W6M20902-9587-C-1

FCC ID: M5X-ACT7T

1.3 Details of approval holder

Name: MIPRO Electronics Co., Ltd.
Street: 814 Pei-kang Road
Town: Chia-yi, 600
Country: Taiwan, R.O.C.
Telephone: +886-5-238-0809
Fax: +886-5-238-0803

1.4 Application details

Date of receipt of test sample: February 27, 2009
Date of test: From February 28, 2009 to April 2, 2009

1.5 General information of Test item

Type of test item: Transmitter
Model Number: ACT-7T
Brand Name: MIPRO
Multi-listing model number: ./.
Photos: see Appendix

Technical data

Frequency band :

Frequency(MHz)	TV Band	Used Band
26.100-26.480	<input type="checkbox"/>	<input type="checkbox"/>
54.000-72.000	<input type="checkbox"/>	<input type="checkbox"/>
76.000-88.000	<input type="checkbox"/>	<input type="checkbox"/>
161.625-161.775	<input type="checkbox"/>	<input type="checkbox"/>
174.000-216.000	<input type="checkbox"/>	<input type="checkbox"/>
450.000-451.000	<input type="checkbox"/>	<input type="checkbox"/>
455.000-456.000	<input type="checkbox"/>	<input type="checkbox"/>
470.000-488.000	<input type="checkbox"/>	<input type="checkbox"/>
488.000-494.000	<input type="checkbox"/>	<input type="checkbox"/>
494.000-608.000	<input type="checkbox"/>	<input type="checkbox"/>
614.000-697.000	<input checked="" type="checkbox"/>	<input checked="" type="checkbox"/>
944.000-952.000	<input type="checkbox"/>	<input type="checkbox"/>

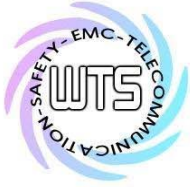

Worldwide Testing Services(Taiwan) Co., Ltd.

Registration number: W6M20902-9587-C-1
FCC ID: M5X-ACT7T

Frequency (ch A): 614.2 MHz
Frequency (ch B): 655.5 MHz
Frequency (ch C): 696.8 MHz

Antenna Type: internal (1/4 λ) antenna

Antenna Gain: 0 dBi

Power supply: Battery (3 VDC, AA*2)

Operation modes: Simplex

Additional information: The EUT is the portable device. So the EUT was tested on three different axes. The EUT uses the frequency range that are more than 10 MHz, so that was tested on low, middle, and high three different frequencies.

Manufacturer: (if different from approval holder)

Name: ./.
Street: ./.
Town: ./.
Country: ./.

1.6 Test standards

Technical standard: FCC Part 74 Subpart H , section 74.861 (2008-10)

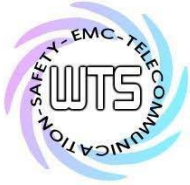

Registration number: W6M20902-9587-C-1

FCC ID: M5X-ACT7T

2 Technical test

2.1 Summary of test results

No deviations from the technical specification(s) were ascertained in the course of the tests performed.

or

The deviations as specified in 3 were ascertained in the course of the tests performed.

2.2 Test environment

Temperature: 23 °C

Relative humidity content: 20 ... 75 %

Air pressure: 86-103 KPa

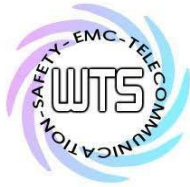

Worldwide Testing Services(Taiwan) Co., Ltd.

Registration number: W6M20902-9587-C-1

FCC ID: M5X-ACT7T

2.3 Test Equipment List

No.	Test equipment	Type	Serial No.	Manufacturer	Cal. Date	Next Cal. Date
ETSTW-CE 001	EMI TEST RECEIVER	ESHS10	842121/013	R&S	2008/9/18	2009/9/17
ETSTW-CE 002	PREREULATOR MODE DC POWER SUPPLY	None	None	None	Function Test	
ETSTW-CE 003	AC POWER SOURCE	APS-9102	D161137	GW	Function Test	
ETSTW-CE 004	ZWEILEITER-V-NETZNACHBILDUNG TWO-LINE V-NETWORK	ESH3-Z5	840731/011	R&S	2008/9/15	2009/9/14
ETSTW-CE 005	Line-Impedance Stabilisation Network	NNBM 8126D	137	Schwarzbeck	2008/9/15	2009/9/14
ETSTW-CE 006	IMPULSBEGRENZER PULSE LIMITER	ESH3-Z2	100226	R&S	2008/5/10	2009/5/9
ETSTW-CE 008	ABSORBING CLAMP	MDS 21	3469	Schwarzbeck	2008/9/18	2009/9/17
ETSTW-CE 009	TEMP.&HUMIDITY CHAMBER	GTH-225-40-1P-U	MAA0305-009	GIANT FORCE	2008/7/25	2009/7/24
ETSTW-CE 015	CISPR 22 TWO BALANCED TELECOM PAIRS IMPEDANCE STABILIZATION NETWORK	FCC-TLISN-T8-02	20307	FCC	2008/9/22	2009/9/21
ETSTW-CE 016	TWO-LINE V-NETWORK	ENV216	100050	R&S	2008/9/24	2009/9/23
ETSTW-RE 002	Function Generator	33220A	MY43004982	Agilent	2007/10/12	2009/10/11
ETSTW-RE 003	EMI TEST RECEIVER	ESI 26	831438/001	R&S	2008/10/8	2009/10/7
ETSTW-RE 004	EMI TEST RECEIVER	ESI 40	832427/004	R&S	2008/9/22	2009/9/21
ETSTW-RE 005	EMI TEST RECEIVER	ESVS10	843207/020	R&S	2008/9/18	2009/9/17
ETSTW-RE 011	PROGRAMMABLE LINEAR POWER SUPPLY	LPS-305	30503070165	MOTECH	Function Test	
ETSTW-RE 017	Log-Periodic Antenna	HL025	352886/001	R&S	2008/5/5	2009/5/4
ETSTW-RE 018	MICROWAVE HORN ANTENNA	AT4560	27212	AR	2008/10/27	2009/10/26
ETSTW-RE 020	MICROWAVE HORN ANTENNA	AT4002A	306915	AR	Function Test	
ETSTW-RE 021	SWEEP GENERATOR	SWM05	835130/010	R&S	2008/8/27	2009/8/26
ETSTW-RE 028	Log-Periodic Dipole Array Antenna	3148	34429	EMCO	2008/4/23	2009/4/22
ETSTW-RE 029	Biconical Antenna	3109	33524	EMCO	2008/4/23	2009/4/22
ETSTW-RE 030	Double-Ridged Guide Horn Antenna	3117	00035224	EMCO	2009/3/23	2010/3/22
ETSTW-RE 032	Millivoltmeter	URV 55	849086/013	R&S	2008/9/1	2009/8/31
ETSTW-RE 033	WaveRunner 6000A Serise Oscilloscope	WAVERUNNER 6100A	LCRY0604P14508	LeCroy	2008/6/27	2009/6/26
ETSTW-RE 034	Power Sensor	URV5-Z4	839313/006	R&S	2008/9/1	2009/8/31
ETSTW-RE 042	Biconical Antenna	HK116	100172	R&S	2009/1/8	2011/1/7
ETSTW-RE 043	Log-Periodic Dipole Antenna	HL223	100166	R&S	2008/5/2	2009/5/1
ETSTW-RE 044	Log-Periodic Antenna	HL050	100094	R&S	2008/5/22	2009/5/21
ETSTW-RE 047	ESA-E SERIES SPECTRUM ANALYZER	E4445A	MY46181369	Agilent	2008/6/26	2009/6/25
ETSTW-RE 048	Triple Loop Antenna	HXYZ 9170	HXYZ 9170-134	Schwarzbeck	2008/9/1	2009/8/31
ETSTW-RE 049	TRILOG Super Broadband test Antenna	VULB 9160	9160-3185	Schwarzbeck	2007/5/2	2009/5/1
ETSTW-RE 055	SPECTRUM ANALYZER	FSU 26	200074	R&S	2008/7/1	2009/6/30
ETSTW-RE 064	Bluetooth Test Set	MT8852B-042	6K00005709	Anritsu	2008/9/1	2009/8/31

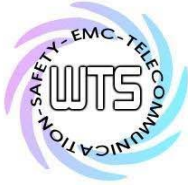

Worldwide Testing Services(Taiwan) Co., Ltd.

Registration number: W6M20902-9587-C-1

FCC ID: M5X-ACT7T

ETSTW-RE 072	CELL SITE TEST SET	8921A	3339A00375	HP	2008/10/28	2009/10/27
ETSTW-RE 073	Power Meter	N1911A	MY45100769	Agilent	2009/1/9	2011/1/8
ETSTW-RE 074	Power Sensor	N1921A	MY45241198	Agilent	2009/1/9	2011/1/8
ETSTW-RE 091	Match Pad	MDCS1500	None	WOKEN	2008/10/9	2009/10/8
ETSTW-RE 092	Match Pad	MDCS1510	None	WOKEN	2008/10/9	2009/10/8
ETSTW-RE 093	LUMPED ELEMENT POWER DIVIDER	PL2-10	146	MCLI	2009/3/6	2010/3/5
ETSTW-RE 094	Precision Coaxial Termination	HP 909F	03941	Agilent	2008/12/19	2009/12/18
ETSTW-RE 095	Digital Thermo-Hygro Meter	0410	01	WISEWIND	2009/3/24	2010/3/23
ETSTW-GSM 002	Universal Radio Communication Tester	CMU 200	109439	R&S	2008/9/23	2009/9/22
ETSTW-GSM 023	Power Divider	4901.19.A	None	SUHNER	2008/9/22	2009/9/21
ETSTW-Cable 001	Microwave Cable	SUCOFLEX 104	238094	HUBER+SUHNER	2008/9/22	2009/9/21
ETSTW-Cable 002	Microwave Cable	SUCOFLEX 104	238093	HUBER+SUHNER	2008/9/22	2009/9/21
ETSTW-Cable 003	Microwave Cable	SUCOFLEX 104	209953	HUBER+SUHNER	2008/9/22	2009/9/21
WTSTW-SW 001	EMI TEST SOFTWARE	Harmonics-1000	None	EMC PARTNER	HARCS Version 4.16 Firmware Version 2.18	
WTSTW-SW 002	EMI TEST SOFTWARE	EZ_EMG	None	Farad	Version ETS-03A1	
WTSTW-SW 003	EMI TEST SOFTWARE	i2	None	AUDIX	Version 3.2007-8-17b	



Registration number: W6M20902-9587-C-1
FCC ID: M5X-ACT7T

2.4 General Test Procedure

POWER LINE CONDUCTED INTERFERENCE: The procedure used was ANSI STANDARD C63.4-2003 using a 50 μ H LISN (if necessary). Both lines were observed. The bandwidth of the spectrum analyzer was 10 kHz with an appropriate sweep speed.

RADIATION INTERFERENCE: The test procedure used was according to ANSI STANDARD C63.4-2003 employing a spectrum analyzer. For investigated frequency is equal to or below 1GHz, the RBW and VBW of the spectrum analyzer was 100 kHz and 100 kHz respectively with an appropriate sweep speed. For investigated frequency is above 1GHz, both of RBW and VBW of the spectrum analyzer were 1 MHz with an appropriate sweep speed. The analyzer was calibrated in dB above a microvolt at the output of the antenna. The ambient temperature of the UUT was 23°C with a humidity of 40 %.

The table used for radiated measurements is capable of continuous rotation. The spectrum was scanned from 30 MHz to the frequency specified as follows:

- (1) If the intentional radiator operates below 10 GHz: to the tenth harmonic of the highest fundamental frequency or to 40 GHz, whichever is lower.
- (2) If the intentional radiator operates at or above 10 GHz and below 30 GHz: to the fifth harmonic of the highest fundamental frequency or to 100 GHz, whichever is lower.
- (3) If the intentional radiator operates at or above 30 GHz: to the fifth harmonic of the highest fundamental frequency or to 200 GHz, whichever is lower, unless specified otherwise elsewhere in the rules.
- (4) If the intentional radiator contains a digital device, regardless of whether this digital device controls the functions of the intentional radiator or the digital device is used for additional control or function purposes other than to enable the operation of the intentional radiator, the frequency range shall be investigated up to the range specified in paragraphs (a)(1)-(a)(3) of this section or the range applicable to the digital device, as shown in paragraph (b)(1) of this Section, whichever is the higher frequency range of investigation.

For hand-held devices, a exploratory test was performed with three (3) orthogonal planes to determine the highest emissions.

Measurements were made by at the registered open field test site located at The Registration Number:

When an emission was found, the table was rotated to produce the maximum signal strength. At this point, the antenna was raised and lowered from 1m to 4m. The antenna was placed in both the horizontal and vertical planes.



Worldwide Testing Services(Taiwan) Co., Ltd.

Registration number: W6M20902-9587-C-1
 FCC ID: M5X-ACT7T

3 Test results (enclosure)

Test case	Para. Number	Required	Test passed	Test failed
RF Power Output	2.1046 (a); 74.861 (e)(1)	<input checked="" type="checkbox"/>	<input checked="" type="checkbox"/>	<input type="checkbox"/>
Modulation Deviation	2.1047 (b); 74.861 (e)(2)	<input checked="" type="checkbox"/>	<input checked="" type="checkbox"/>	<input type="checkbox"/>
Audio Frequency Response	2.1047 (a)	<input checked="" type="checkbox"/>	<input checked="" type="checkbox"/>	<input type="checkbox"/>
Occupied Bandwidth / Emission Mask	2.1049 (c)(1); 74.861 (e)(5)	<input checked="" type="checkbox"/>	<input checked="" type="checkbox"/>	<input type="checkbox"/>
Spurious Emissions at Antenna Terminals	2.1051 74.861(e)(6)	<input type="checkbox"/>	<input type="checkbox"/>	<input type="checkbox"/>
Radiated Spurious Emission	2.1053 74.861(e)(6)	<input checked="" type="checkbox"/>	<input checked="" type="checkbox"/>	<input type="checkbox"/>
Line Conducted Emissions	15.207	<input type="checkbox"/>	<input type="checkbox"/>	<input type="checkbox"/>
Frequency Stability vs. Temperature	2.1055 (b); 74.861(e)(4)	<input checked="" type="checkbox"/>	<input checked="" type="checkbox"/>	<input type="checkbox"/>
Frequency Stability vs. Voltage	2.1055 (a)(1); 74.861 (e)(4)	<input checked="" type="checkbox"/>	<input checked="" type="checkbox"/>	<input type="checkbox"/>

The follows is intended to leave blank.



Registration number: W6M20902-9587-C-1
 FCC ID: M5X-ACT7T

4 RF Power Output (conducted) , FCC 2.1046 (a) ; 74.861 (e)

4.1 Test procedure

This transmitter output was connected to a calibrated coaxial attenuator, the other end of which was connected to a spectrum analyzer. Transmitter output was derived with the spectrum analyzer in dBm. The power output at the transmitter antenna port was determined by assign the value of the attenuator to the spectrum analyzer reading.

An HP power meter was also used to measure the RF power.

Tests were performed with an un-modulated carrier at three frequencies (low , middle and high channels) and on all power levels , which can be set-up on the transmitters.

4.2 Test Results

Frequency Channel	Peak Output Power (dBm)
614.2 MHz	--
655.5 MHz	--
696.8 MHz	--

Limits:

LPAS operating in TV bands	
Frequency [MHz]	Conducted output power [mW]
54 – 72 76 – 88 174 - 216	50 (17 dBm)
470 – 608 614 - 806	250 (24 dBm)

LPAS operating in other than TV bands	
Conducted power [W]	1

Test equipment used: ETSTW-RE 055

Explanation :This test is not required.



Registration number: W6M20902-9587-C-1
FCC ID: M5X-ACT7T

5 Radiated Power

5.1 Test Procedure

The EUT was positioned on a non-conductive turntable, 0.8m above the ground on an open test site. The radiated emission at the fundamental frequency was measured at 3m distance with a test antenna and spectrum analyzer.

Worst case emission was recorded with the rotation of the turntable and the raising and lowering of the test antenna.

Substitution RF power Measurement at ETS Taiwan

General :

The applied substitution method follows ANSI/TIA/EIA-603, ANSI/TIA/EIA-102.CAAA or the appropriate ETSI rules respectively.

The actual signal generated by the EUT can be determined by means of a substitution measurement in which a known signal source replaces the device to be measured.

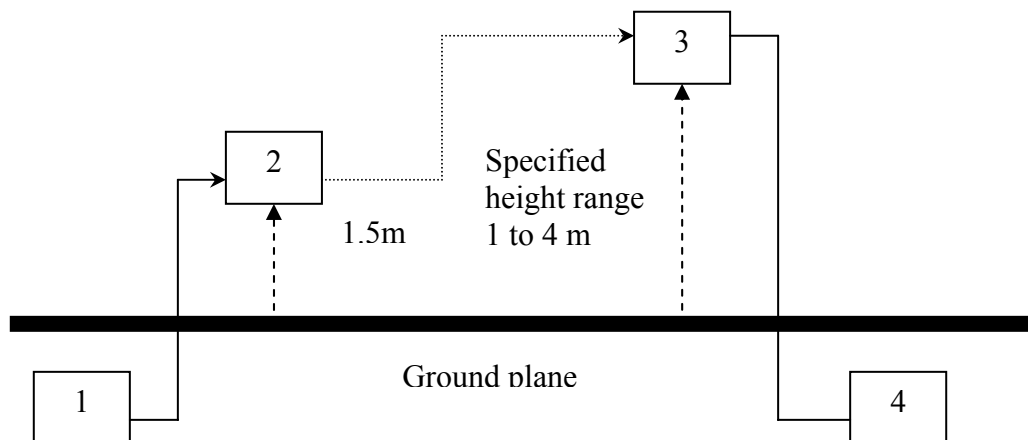

- 1) Signal generator ;
- 2) Substitution antenna ;
- 3) Test antenna ;
- 4) Spectrum analyzer or selective voltmeter.

The substitution antenna replaces the transmitter antenna at the same position and in vertical polarization. The frequency of the signal generator shall be adjusted to the measurement frequency.

The test antenna shall be raised or lowered, if necessary, to ensure that the maximum signal is still received. The input signal to the substitution antenna shall be adjusted in level until an equal or a known related level to that detected from the transmitter is obtained in the measurement receiver.

If a fully anechoic chamber is used as test site in order to provide free space conditions there is no need to change the height of the antenna.

The measurement will be repeated in horizontal position.



Worldwide Testing Services(Taiwan) Co., Ltd.

Registration number: W6M20902-9587-C-1
 FCC ID: M5X-ACT7T

Calibration :

In order to make this kind of measurement more effective and to avoid subjective measurement faults ETS has installed automatic computer controlled measurement procedures.

With the above described substitution method a test site is calibrated over the full frequency range which is used in suitable frequency steps. For a certain power level on the substitution antenna the received power over the whole frequency range is documented. All necessary antenna gains, cable losses, filter losses and amplifications of preamplifiers are taken in consideration. The summary of this calibration measurement performs a transducer factor that is related to the considered test site and a certain measurement distance. Differences of the radiated power levels of different test samples are determined by internal attenuation of measurement receiver . The proper function of such test site will be maintained by short term plausibility checks and periodical re-calibration.

Testing :

Now the test sample will be putted on the table at the defined position and the radiated power will be receiver and documented by the measurement receiver.

On test sites with ground plane the measurement antenna will be lowered and raised to maximum values at significant frequencies.

For peak power measurements the sample is turned by the turntable over 360 degree in order to find the direction with the maximum radiation or to document the max reading with the MAXHOLD function during the rotation.

5.2 Test results

Model: ACT-7T Date: 2009/3/24
 Mode: TX power 614.2MHz Temperature: 24 °C Engineer: Danny
 Polarization: Horizontal Humidity: 51 %

Frequency (MHz)	Reading (dBm) Peak	Factor (dB) Corr.	Result (dBm)	Limit (dBm)	Margin (dB)	Table Degree (Deg.)	Ant. High (cm)
614.197	-38.30	32.93	-5.37	24.00	-29.37	130	150

Polarization: Vertical

Frequency (MHz)	Reading (dBm) Peak	Factor (dB) Corr.	Result (dBm)	Limit (dBm)	Margin (dB)	Table Degree (Deg.)	Ant. High (cm)
614.195	-21.92	30.06	8.14	24.00	-15.86	125	150

Mode: TX power 655.5MHz
 Polarization: Horizontal

Frequency (MHz)	Reading (dBm) Peak	Factor (dB) Corr.	Result (dBm)	Limit (dBm)	Margin (dB)	Table Degree (Deg.)	Ant. High (cm)
655.493	-34.88	32.65	-2.23	24.00	-26.23	120	150



Worldwide Testing Services(Taiwan) Co., Ltd.

Registration number: W6M20902-9587-C-1

FCC ID: M5X-ACT7T

Polarization: Vertical

Frequency (MHz)	Reading (dBm) Peak	Factor (dB) Corr.	Result (dBm)	Limit (dBm)	Margin (dB)	Table Degree (Deg.)	Ant. High (cm)
655.485	-20.76	32.18	11.42	24.00	-12.58	130	150

Mode: TX power 696.8MHz

Polarization: Horizontal

Frequency (MHz)	Reading (dBm) Peak	Factor (dB) Corr.	Result (dBm)	Limit (dBm)	Margin (dB)	Table Degree (Deg.)	Ant. High (cm)
696.797	-28.94	32.70	3.76	24.00	-20.24	120	150

Polarization: Vertical

Frequency (MHz)	Reading (dBm) Peak	Factor (dB) Corr.	Result (dBm)	Limit (dBm)	Margin (dB)	Table Degree (Deg.)	Ant. High (cm)
696.789	-19.68	33.46	13.78	24.00	-10.22	130	150

Test equipment used: ETSTW-RE 003, ETSTW-RE 004, ETSTW-RE 021, ETSTW-RE 028, ETSTW-RE 029, ETSTW-RE 042, ETSTW-RE 043

Explanation: Please see attached diagrams as appendix.



Registration number: W6M20902-9587-C-1

FCC ID: M5X-ACT7T

6 Modulation Deviation , FCC 2.1047 (b) ; 74.861(e)

6.1 Test procedure

Modulation limiting is the transmitter circuit's ability to limit the transmitter from producing deviations in excess of rated system deviation.

The audio signal generator is connected to the audio input of the EUT with its full rating.

The modulation response is measured at certain modulation frequencies, related to 1000Hz reference signal. Tests are performed for positive and negative modulation.

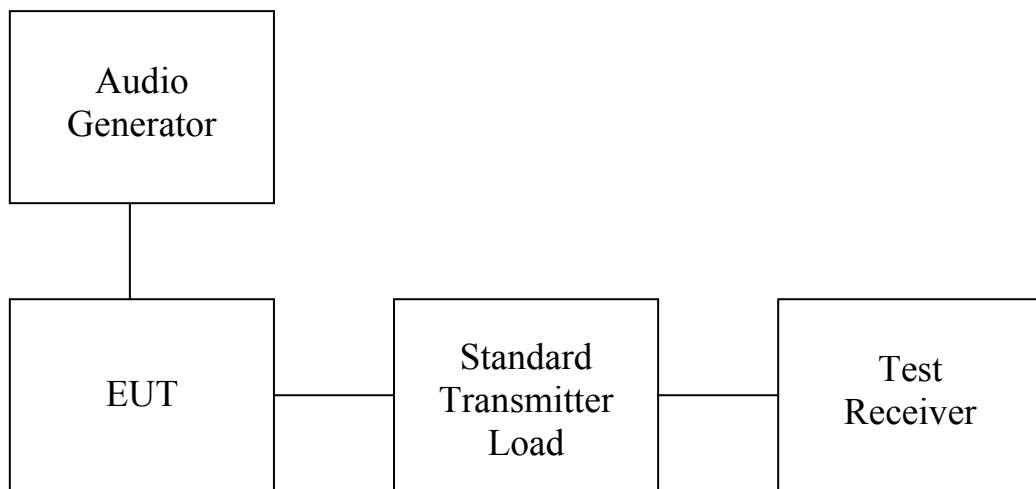

6.2 Test results

Explanation: Please see attached diagrams as appendix.

Limits : ± 75 kHz

Test equipment used: ETSTW-RE 002, ETSTW-RE 055

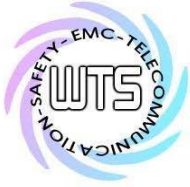

Registration number: W6M20902-9587-C-1

FCC ID: M5X-ACT7T

7 Audio frequency response , FCC 2.1047 (a)

7.1 Test procedure

The audio frequency response is the degree of closeness to which the frequency deviation of the transmitter follows a prescribed characteristic.

The frequency response of the audio modulation part is measured over a frequency range of 100 Hz to 5000 Hz.

For 1000 Hz tone reference signal the audio generator level is adjusted to get 20% of the rated system deviation.

The deviations obtained over the frequency range from 100 Hz to 5000 Hz are recorded and compared with the reference deviation as follows :

$$\text{Audio Frequency Response} = 20 \log [\text{DEV}_{\text{Freq}} / \text{DEV}_{\text{ref}}].$$

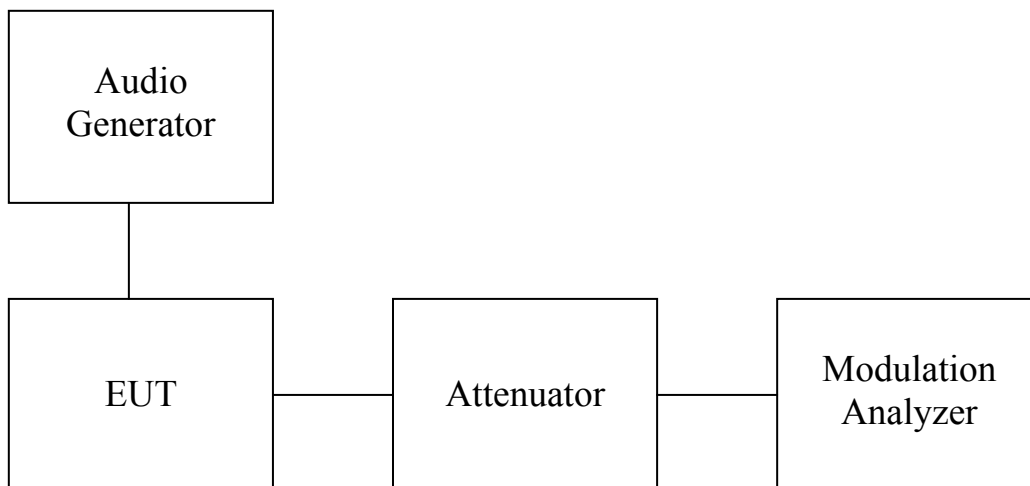

7.2 Test results

Explanation: Please see attached diagrams as appendix.

Test equipment used: ETSTW-RE 002

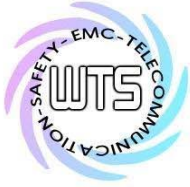

Registration number: W6M20902-9587-C-1

FCC ID: M5X-ACT7T

8 Occupied Bandwidth/Emission Mask, FCC 2.1049 (c) ; 74.861 (e)(5)

The occupied bandwidth, that is the frequency bandwidth such that, below its lower and above its upper frequency limits, the mean powers radiated are each equal to 0.5 percent of the total mean power. Near the carrier an Emission Mask is defined by the standard.

8.1 Test procedure

The RF output of the transceiver was connected to the input of the spectrum analyzer through sufficient attenuation.

Occupied Bandwidth was measured with a occupied bandwidth function of the analyzer.

The near the carrier emissions are measured by normal power measurement function of the analyzer.

8.2 Test Results

1000 Hz Modulation

Occupied Channel Bandwidth (kHz)	
Channel A	128.205128205
Channel B	129.807692308
Channel C	136.217948718

2500 Hz Modulation

Occupied Channel Bandwidth (kHz)	
Channel A	131.410256410
Channel B	129.807692308
Channel C	129.807692308

Test equipment used: ETSTW-RE 055

Explanation : Please see attached diagram as appendix .

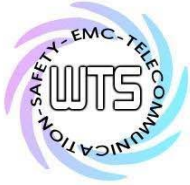

Registration number: W6M20902-9587-C-1

FCC ID: M5X-ACT7T

9 Spurious Emissions at Antenna Terminals FCC2.1051 ; 74.861 (e)

9.1 Test procedure

This transmitter output was connected to a calibrated coaxial attenuator, the other end of which was connected to a spectrum analyzer. Transmitter output was derived with the spectrum analyzer in dBm.

The Spurious Emissions at Antenna Terminals was measured by the spectrum analyzer with a suitable notch filter and high-pass filter.

Tests were performed with an un-modulated carrier at three frequencies (low , middle and high channels) and on all power levels , which can be set-up on the transmitters.

9.2 Test Results

Summary table with conducted data of the test plots for Carrier Test Frequency

Frequency Marker Indication [MHz]	Indication Power Level [dBm]	Compliance Limit [dBm]	Margin
--	--	--	--
--	--	--	--

9.3 Limit

Compliance with § 74.861 requires that any emission be attenuated below the transmitter power at least $43 + 10 \log_{10} P$ (P = transmitter power in Watts).

The compliance limit was calculated as an example per the following table :

Maximum transmitter output power	13.78 dBm
Required attenuation	$43 + 10 \log_{10} 0.023878 \text{ W} = 26.78 \text{ dB}$
Maximum transmitter output power	13.78 dBm
<u>Required attenuation</u>	<u>26.78 dB</u>
Compliance limit	-13 dBm

Test equipment used: ETSTW-RE 055

Explanation : This test is not applicable.



Registration number: W6M20902-9587-C-1

FCC ID: M5X-ACT7T

10 Radiated Spurious Emission , FCC 2.1053 ; 74.861 (e)

10.1 Test procedure

The EUT was positioned on a non-conductive turntable , 0.8m above the ground plane.

The radiated emission at the fundamental frequency was measured at 3 m distance with a test antenna and spectrum analyzer.

Worst case emission was recorded with the rotation of the turntable and the raising and lowering of the test antenna.

ERP was measured using a substitution method. The EUT was replaced by reference antenna connected to a signal generator.

The test of spurious radiated emission have been carried out with the ESK-Software from Rode & Schwarz. The measurements below 1GHz were performed with a measurement bandwidth of 100kHz, above 1GHz with a bandwidth of 1 MHz.

Spurious emission limits near the carrier are defined by a emission mask. This measurements are done in conducted mode.

10.2 Test Results

The measurements of the spurious emission at the upper , center and lower channel.

The measurement diagrams show that all significant spurs are well below the limit line.

Summary table with radiated data of the test plots for Carrier Test Frequency

Model: ACT-7T Date: 2009/3/19
Mode: TX 614.2MHz Temperature: 24 °C Engineer: Danny
Polarization: Horizontal Humidity: 51 %

Frequency (MHz)	Reading (dBm) Peak	Factor (dB) Corr.	Result (dBm)	Limit (dBm)	Margin (dB)	Table Degree (Deg.)	Ant. High (cm)
285.391	-100.94	29.68	-71.26	-13.00	-58.26	115	150
992.986	-101.69	36.12	-65.57	-13.00	-52.57	120	150
1228.457	-59.33	1.50	-57.83	-13.00	-44.83	130	150
1841.683	-55.26	3.84	-51.42	-13.00	-38.42	135	150
2454.910	-51.02	6.58	-44.44	-13.00	-31.44	140	150
5931.864	-60.32	14.52	-45.80	-13.00	-32.80	145	150



Worldwide Testing Services(Taiwan) Co., Ltd.

Registration number: W6M20902-9587-C-1

FCC ID: M5X-ACT7T

Polarization: Vertical

Frequency (MHz)	Reading (dBm) Peak	Factor (dB) Corr.	Result (dBm)	Limit (dBm)	Margin (dB)	Table Degree (Deg.)	Ant. High (cm)
78.697	-87.70	25.28	-62.42	-13.00	-49.42	110	150
918.637	-101.11	35.57	-65.54	-13.00	-52.54	130	150
1228.457	-55.75	0.84	-54.91	-13.00	-41.91	140	150
1841.683	-48.50	3.28	-45.22	-13.00	-32.22	135	150
2454.910	-49.90	4.61	-45.29	-13.00	-32.29	140	150
5931.864	-58.21	12.53	-45.68	-13.00	-32.68	135	150

Mode: TX 655.5MHz

Polarization: Horizontal

Frequency (MHz)	Reading (dBm) Peak	Factor (dB) Corr.	Result (dBm)	Limit (dBm)	Margin (dB)	Table Degree (Deg.)	Ant. High (cm)
299.459	-104.24	31.70	-72.54	-13.00	-59.54	115	150
995.792	-102.01	36.25	-65.76	-13.00	-52.76	120	150
1311.000	-61.88	3.04	-58.84	-13.00	-45.84	130	150
1967.936	-54.12	4.92	-49.20	-13.00	-36.20	140	150
2623.247	-49.82	9.42	-40.40	-13.00	-27.40	150	150
6893.788	-57.98	16.09	-41.89	-13.00	-28.89	130	150

Polarization: Vertical

Frequency (MHz)	Reading (dBm) Peak	Factor (dB) Corr.	Result (dBm)	Limit (dBm)	Margin (dB)	Table Degree (Deg.)	Ant. High (cm)
77.615	-89.52	25.06	-64.46	-13.00	-51.46	110	150
959.318	-101.14	35.26	-65.88	-13.00	-52.88	125	150
1306.613	-58.35	3.18	-55.17	-13.00	-42.17	130	150
1967.936	-53.34	3.70	-49.64	-13.00	-36.64	135	150
2623.247	-45.74	6.36	-39.38	-13.00	-26.38	130	150
7519.038	-54.65	11.33	-43.32	-13.00	-30.32	150	150



Registration number: W6M20902-9587-C-1
 FCC ID: M5X-ACT7T

Mode: TX 696.8MHz
 Polarization: Horizontal

Frequency (MHz)	Reading (dBm) Peak	Factor (dB) Corr.	Result (dBm)	Limit (dBm)	Margin (dB)	Table Degree (Deg.)	Ant. High (cm)
257.796	-103.85	31.55	-72.30	-13.00	-59.30	110	150
994.389	-101.20	36.19	-65.01	-13.00	-52.01	120	150
1390.782	-60.21	2.59	-57.62	-13.00	-44.62	140	150
2088.176	-56.61	4.49	-52.12	-13.00	-39.12	135	150
2785.571	-56.15	10.37	-45.78	-13.00	-32.78	135	150
6885.771	-57.37	15.97	-41.40	-13.00	-28.40	140	150

Polarization: Vertical

Frequency (MHz)	Reading (dBm) Peak	Factor (dB) Corr.	Result (dBm)	Limit (dBm)	Margin (dB)	Table Degree (Deg.)	Ant. High (cm)
77.615	-89.78	25.06	-64.72	-13.00	-51.72	120	150
950.902	-101.42	35.29	-66.13	-13.00	-53.13	125	150
1390.782	-59.60	1.16	-58.44	-13.00	-45.44	145	150
2088.176	-52.96	3.26	-49.70	-13.00	-36.70	135	150
2785.571	-58.73	6.16	-52.57	-13.00	-39.57	140	150
7511.022	-55.24	11.33	-43.91	-13.00	-30.91	140	150

- Note:**
1. Correction Factor = Antenna Gain + Cable Loss + Amplifier Gain
 2. The formula of measured value as: Test Result = Reading + Correction Factor
 3. Detector function in the form : PK = Peak, AV = Average
 4. All not in the table noted test results are more than 20 dB below the relevant limits.
 5. See the attached diagram as appendix.

10.3 Explanation of test result

The measurements of the spurious emissions at the equipment output terminals were performed pursuant to the test procedure above in order to verify that any emissions are below the limits given by § 74.861 (6).

Calculation of test results :

Such factors like antenna correction , cable loss , external attenuation etc. are already included in the provided measurement results. This is done by using validated test software and calibrated test system according the accreditation requirements.

In the Table being listed the critical peak and average value an exhibit the compliance with the above calculated Limits.

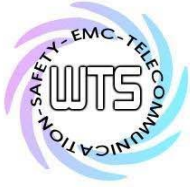

Registration number: W6M20902-9587-C-1
FCC ID: M5X-ACT7T

10.4 Limits

Compliance with § 74.861 requires that any emission be attenuated below the transmitter power at least $43 + 10 \log_{10} P$ (P = transmitter power in Watts).

The compliance limit was calculated as an example per the following table :

Maximum transmitter output power	13.78 dBm
Required attenuation	$43 + 10 \log_{10} 0.023878 \text{ W} = 26.78 \text{ dB}$
Maximum transmitter output power	13.78 dBm
<u>Required attenuation</u>	<u>26.78 dB</u>
Compliance limit	-13 dBm

Test equipment used: ETSTW-RE 003, ETSTW-RE 004, ETSTW-RE 017, ETSTW-RE 021,
ETSTW-RE 028, ETSTW-RE 029, ETSTW-RE 030, ETSTW-RE 042,
ETSTW-RE 043

Explanation : See attached diagrams in appendix.

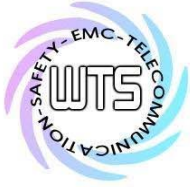

Registration number: W6M20902-9587-C-1
FCC ID: M5X-ACT7T

11 Line Conducted Emission , FCC 15.207

11.1 Test procedure

For an intentional radiator which is designed to be connected to the public utility (AC) power line, the radio frequency voltage that is conducted back onto the AC line on any frequency or frequencies within the band 150 kHz to 30 MHz shall not exceed the limits in the table bellows with this provision shall be based on the measurement of the radio frequency voltage between each power line and ground at the power terminals.

This measurement was transact first with instrumentation using an average and peak detector and a 10 kHz bandwidth. If the peak detector achieves a calculated level, the measurement is repeated by an instrumentation using a quasi-peak detector.

11.2 Test Results

Frequency	Max. Level (dB μ V)	
	quasi-peak	average
-- kHz	--	--

Limits:

Frequency of Emission (MHz)	Conducted Limit (dB μ V)	
	Quasi Peak	Average
0.15-0.5	66 to 56	56 to 46
0.5-5	56	46
5-30	60	50

Test equipment used: ETSTW-CE 001, ETSTW-CE 003, ETSTW-CE 004, ETSTW-CE 006

Explanation: For battery operated device, this test item is not applicable.



Registration number: W6M20902-9587-C-1

FCC ID: M5X-ACT7T

12 Frequency Stability vs. Temperature , FCC 2.1055 , 74.861 (e)

12.1 Test procedure

The equipment under test was connected to an external DC power supply and the RF output was connected to a frequency counter via feed through attenuators. The EUT was placed inside the temperature chamber. The DC leads and RF output cable, exited the chamber through an opening made for that purpose.

After the temperature stabilized the frequency output was recorded from the counter.

12.2 Test Results

614.2 MHz

°C	Frequency Error (kHz)	Frequency Error (ppm)
-30	5.372	8.747
-20	9.506	15.477
-10	8.167	13.298
0	5.794	9.434
10	2.794	4.549
20	1.058	1.722
30	-1.054	-1.716
40	-4.888	-7.958
50	-1.875	-3.053

25°C: 614.199459 MHz

Limit: 30.71 kHz(±0.005%)

655.5 MHz

°C	Frequency Error (kHz)	Frequency Error (ppm)
-30	4.762	7.264
-20	7.313	11.156
-10	6.897	10.521
0	5.300	8.085
10	2.992	4.564
20	-0.137	-0.209
30	-1.552	-2.367
40	-4.336	-6.614
50	-4.508	-6.876

25°C: 655.500488 MHz

Limit: 32.77 kHz(±0.005%)

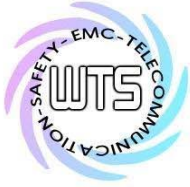

Worldwide Testing Services(Taiwan) Co., Ltd.

Registration number: W6M20902-9587-C-1
FCC ID: M5X-ACT7T

696.8 MHz

°C	Frequency Error (kHz)	Frequency Error (ppm)
-30	5.582	8.010
-20	8.754	12.563
-10	7.416	10.643
0	5.497	7.889
10	3.806	5.463
20	-0.018	-0.026
30	-2.101	-3.015
40	-3.831	-5.498
50	-2.527	-3.627

25°C: 696.799899 MHz

Limit: 34.84 kHz(±0.005%)

Test equipment used: ETSTW-RE 055, ETSTW-CE 009

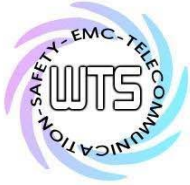

Registration number: W6M20902-9587-C-1
FCC ID: M5X-ACT7T

13 Frequency Stability vs. Voltage , FCC 2.1055 (d) ; 74.861 (e)

13.1 Test procedure

An external variable DC power supply was connected to the battery terminals of the equipment under test.

For hand carried , battery powered equipment primary supply voltage was reduced to the battery operating end point as specified by the manufacturer. The output frequency was recorded for each battery voltage.

13.2 Test Results

Frequency in Normal Condition (MHz)	Frequency in battery operating end point (MHz)	Frequency Error (kHz)	Frequency Error (ppm)
614.199459	614.199588	0.129	0.210
655.500488	655.500024	-0.464	-0.708
696.799899	699.799037	-0.862	-1.237

Limit : $\pm 0.005\%$

Test equipment used: ETSTW-RE 055, ETSTW-CE 003



Appendix

A Measurement diagrams

1. RF Power Output
2. Modulation Deviation and Audio frequency response
3. Occupied Bandwidth / Emission Mask
4. Spurious Emissions at Antenna Terminals
(This test is not applicable)
5. Radiation Spurious Emission
6. Line Conducted Emissions
(This is not required the sample is battery used.)
7. Frequency Stability vs. Temperature
No diagrams
Refer to point 12.2
8. Frequency Stability vs. Voltage
No diagrams
Refer to point 13.2

B Photos

1. External Photos
2. Internal Photos
3. Set Up Photo of Radiated Emission



Registration number: W6M20902-9587-C-1

FCC ID: M5X-ACT7T

RF Power Output

CH Low_614.2 MHz

Antenna Polarization H

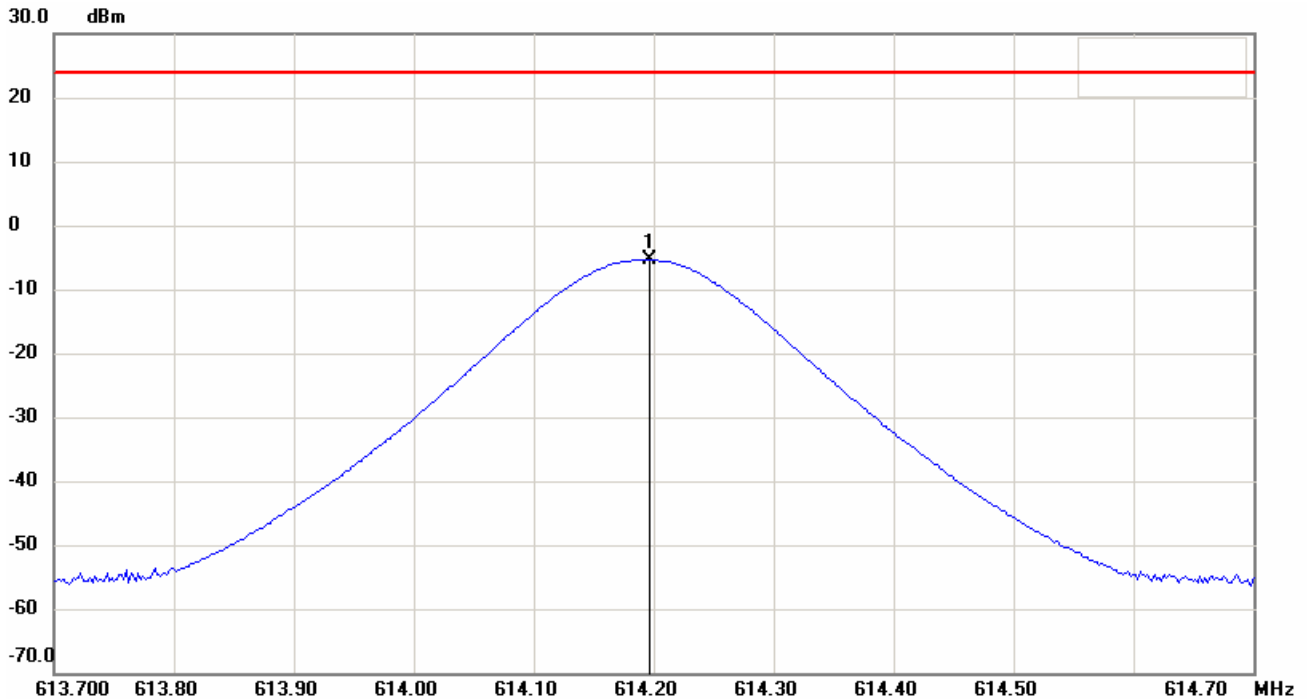

Antenna Polarization V

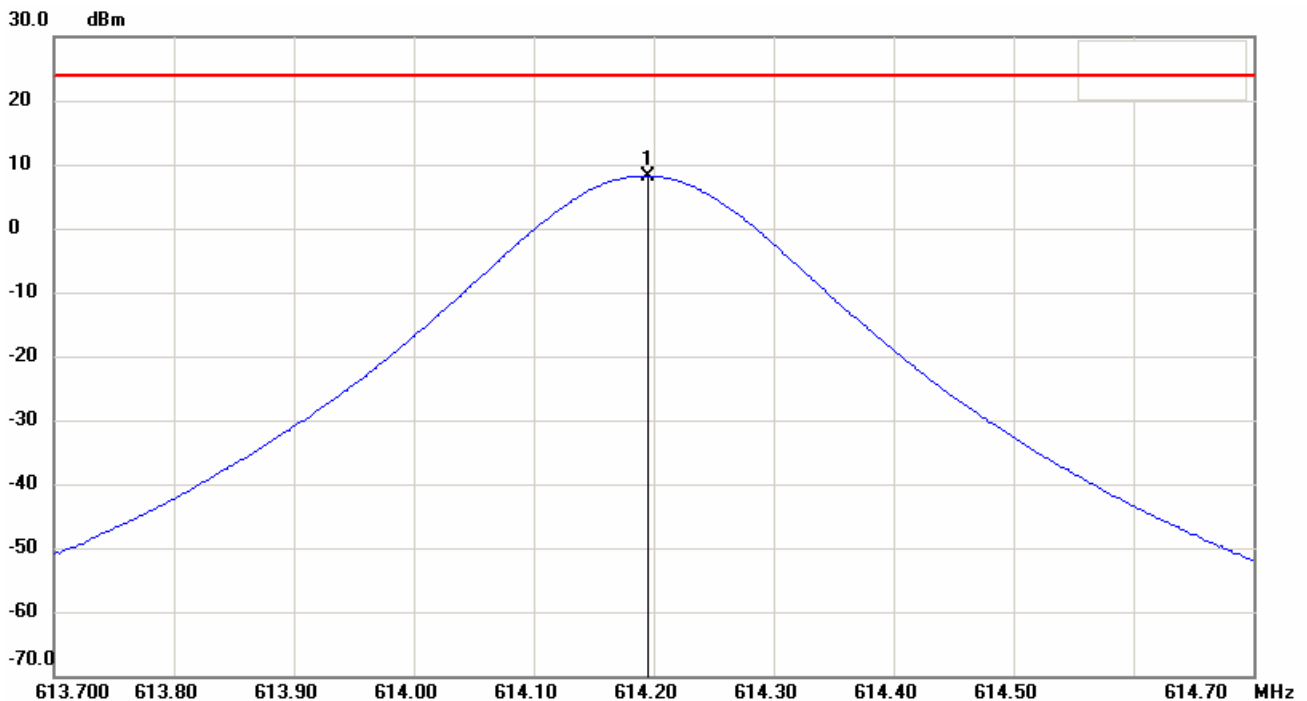

Note:

1. The attached measurement plots are preliminarily pre-scanned with peak detector for determining the final checking frequencies and are for reference only.
2. The some frequencies may exceed the limit line without the specified detectors, but that cannot present the results are failed to the specification of test standard.
3. For corrected test results are listed in the relevant table of radiated test data of this test report.



Registration number: W6M20902-9587-C-1

FCC ID: M5X-ACT7T

CH Low_655.5 MHz

Antenna Polarization H

30.0 dBm

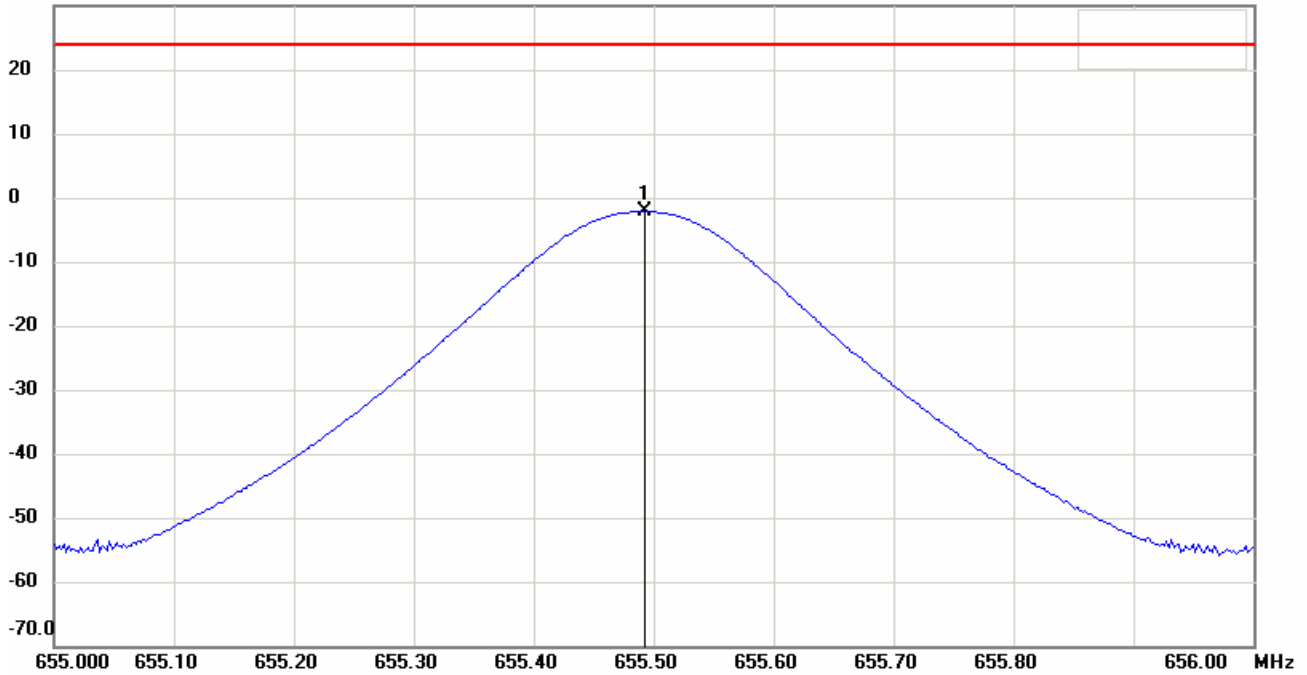

Antenna Polarization V

30.0 dBm

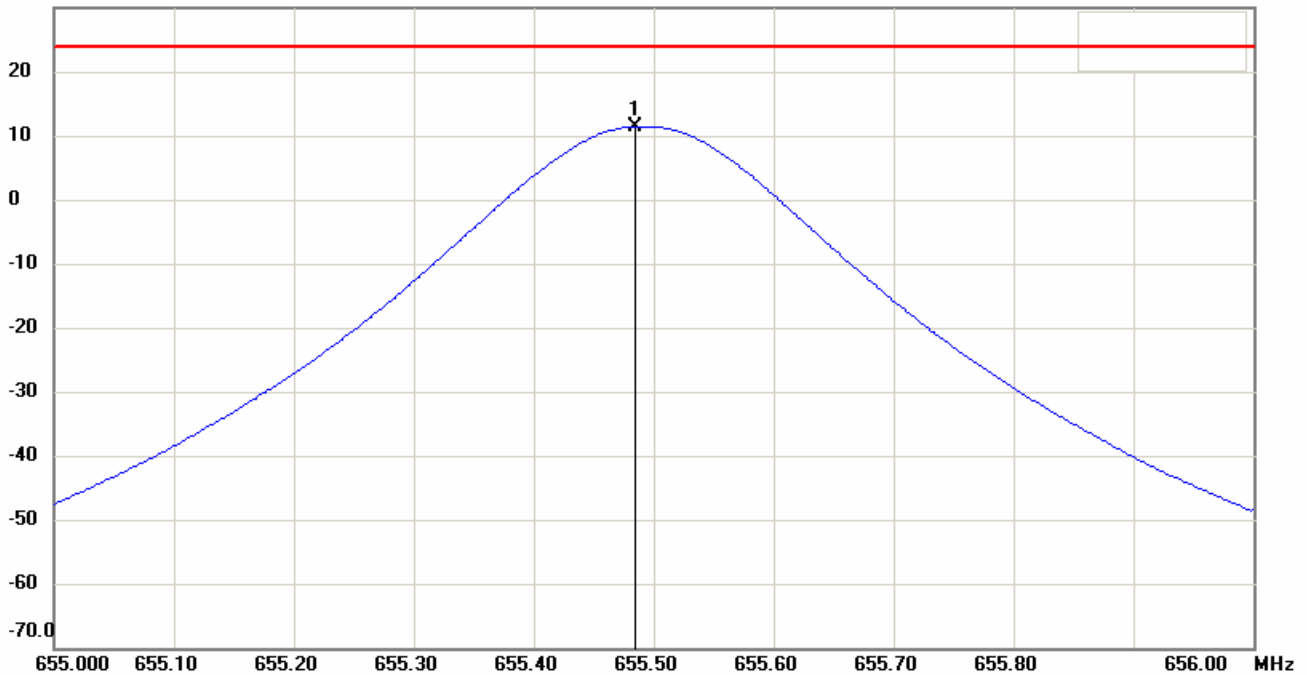

Note:

1. The attached measurement plots are preliminarily pre-scanned with peak detector for determining the final checking frequencies and are for reference only.
2. The some frequencies may exceed the limit line without the specified detectors, but that cannot present the results are failed to the specification of test standard.
3. For corrected test results are listed in the relevant table of radiated test data of this test report.

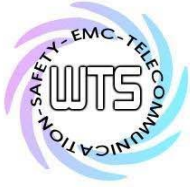

Registration number: W6M20902-9587-C-1

FCC ID: M5X-ACT7T

CH Low_696.8 MHz

Antenna Polarization H

30.0 dBm

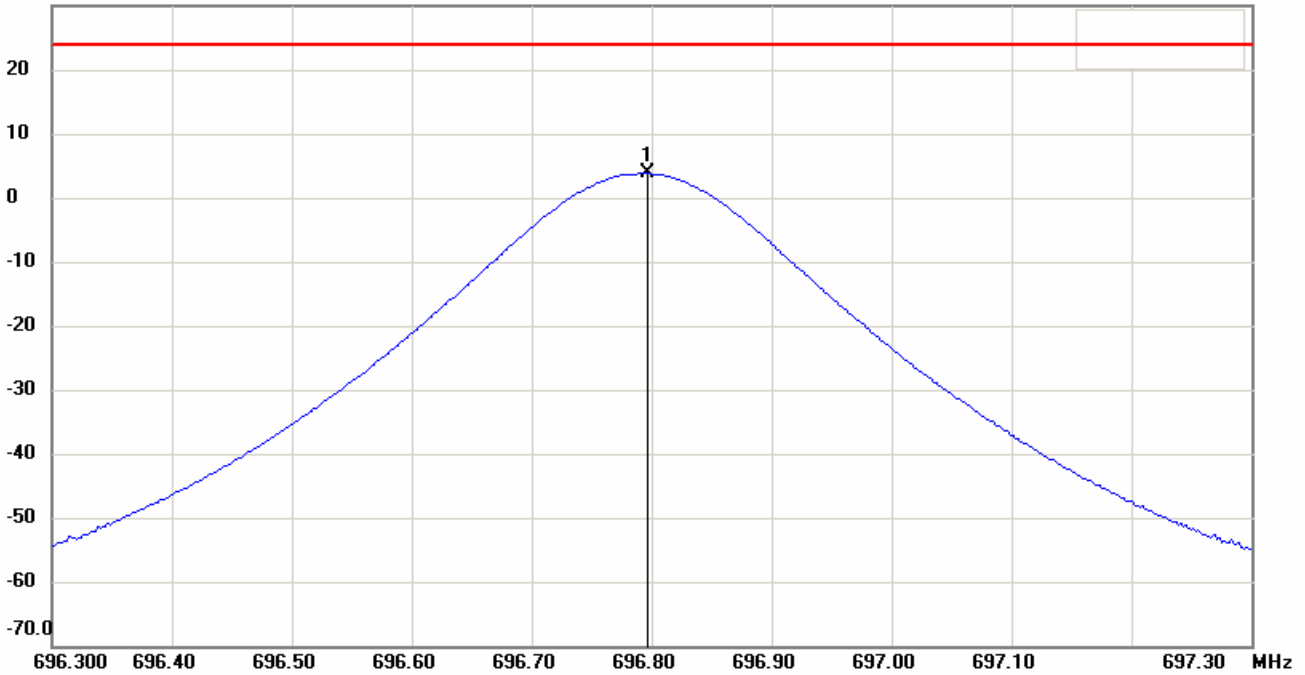

Antenna Polarization V

30.0 dBm

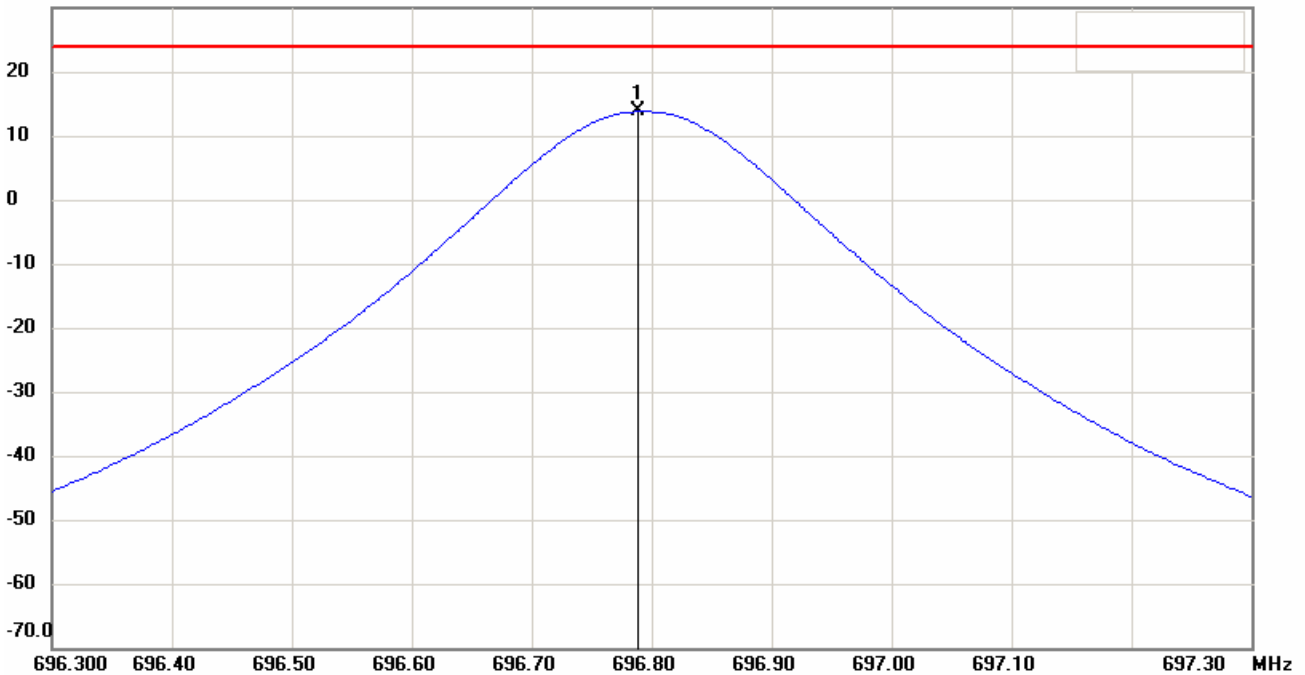

Note:

1. The attached measurement plots are preliminarily pre-scanned with peak detector for determining the final checking frequencies and are for reference only.
2. The some frequencies may exceed the limit line without the specified detectors, but that cannot present the results are failed to the specification of test standard.
3. For corrected test results are listed in the relevant table of radiated test data of this test report.



Registration number: W6M20902-9587-C-1

FCC ID: M5X-ACT7T

Modulation Deviation and Audio frequency response

614.2 MHz

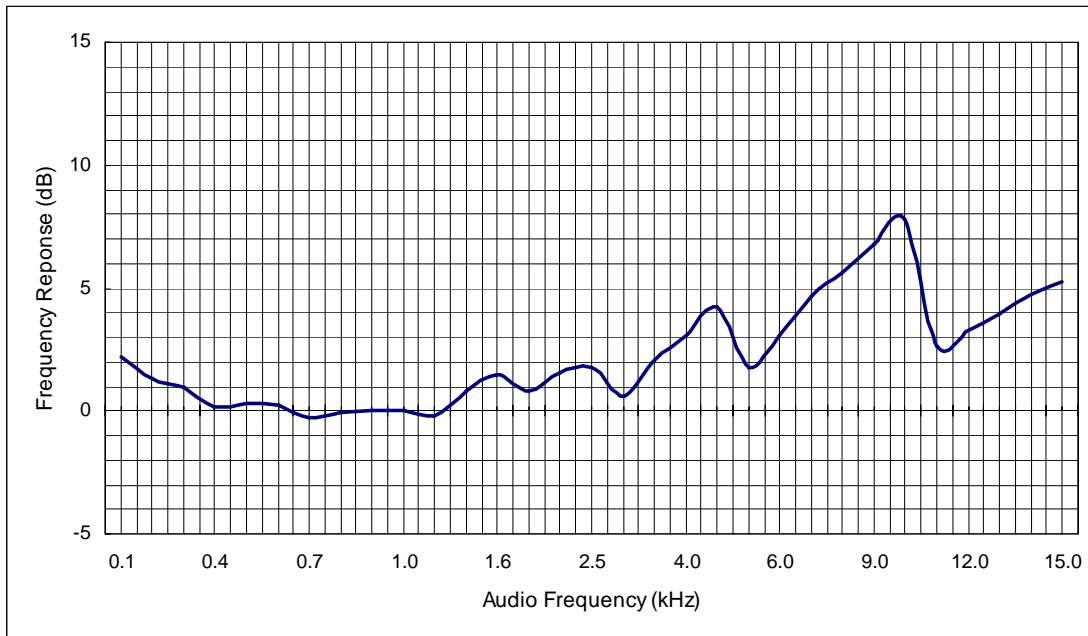
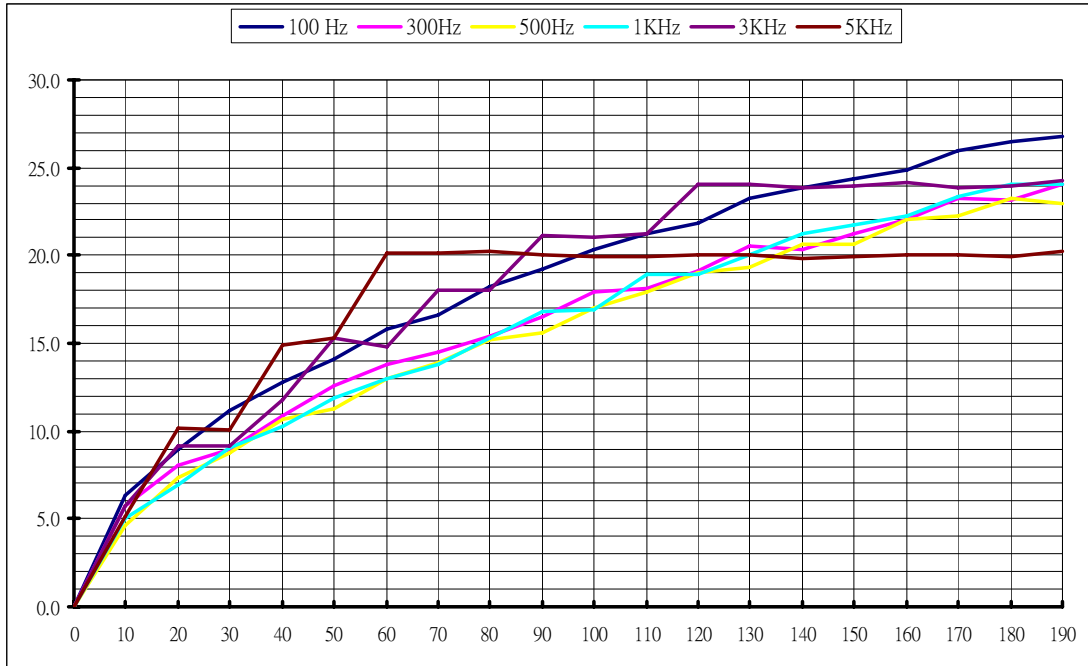



Registration number: W6M20902-9587-C-1

FCC ID: M5X-ACT7T

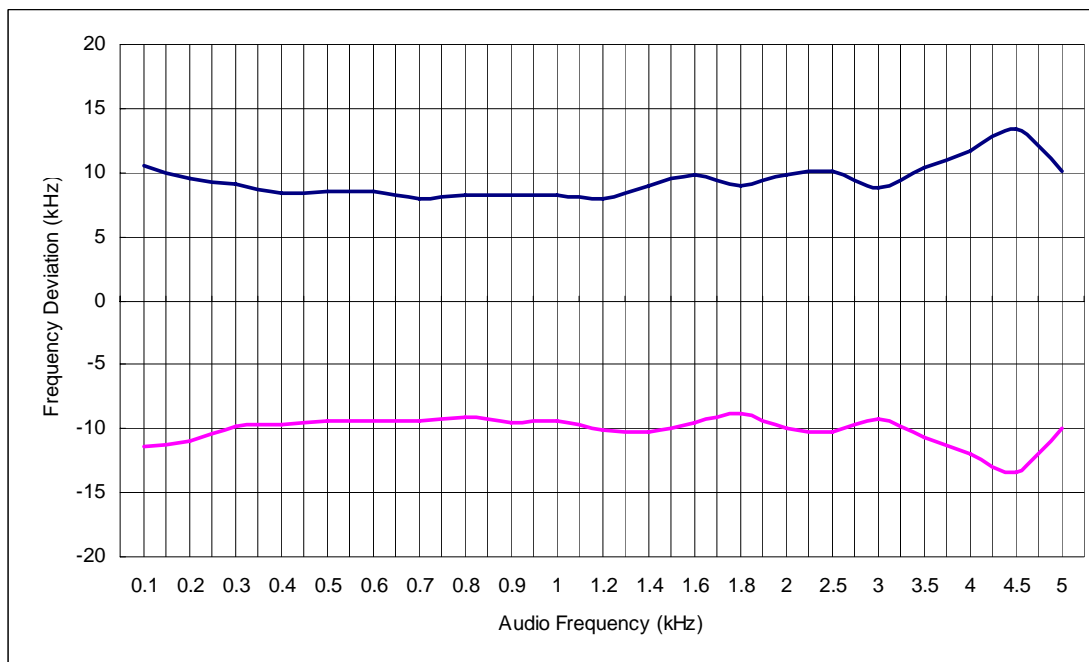
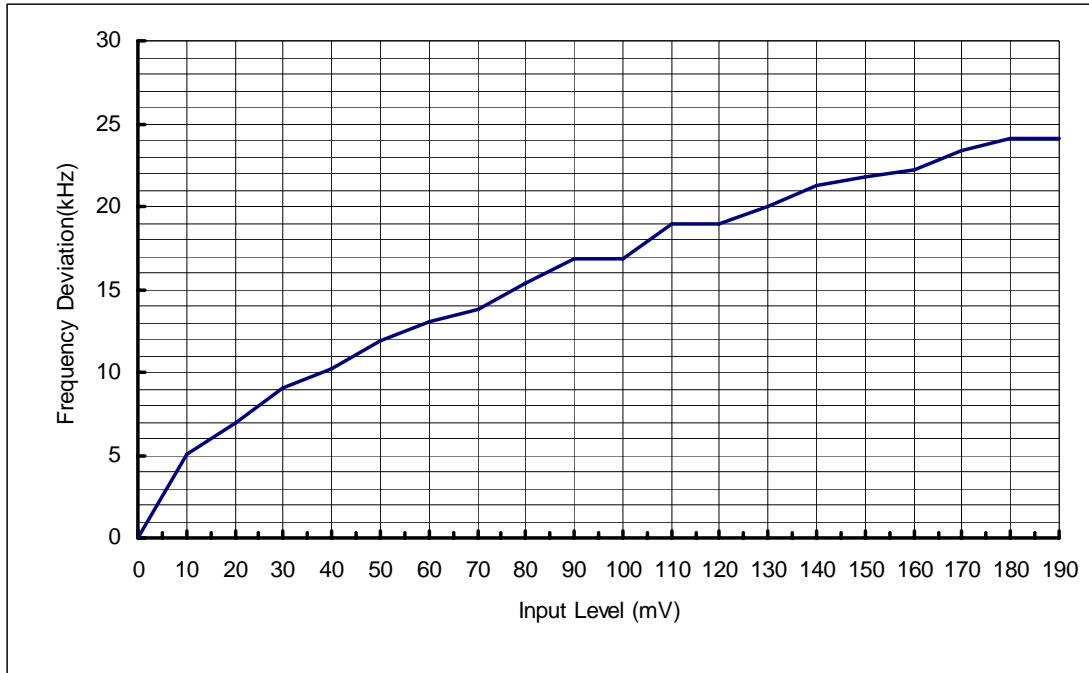



Registration number: W6M20902-9587-C-1

FCC ID: M5X-ACT7T

655.5 MHz

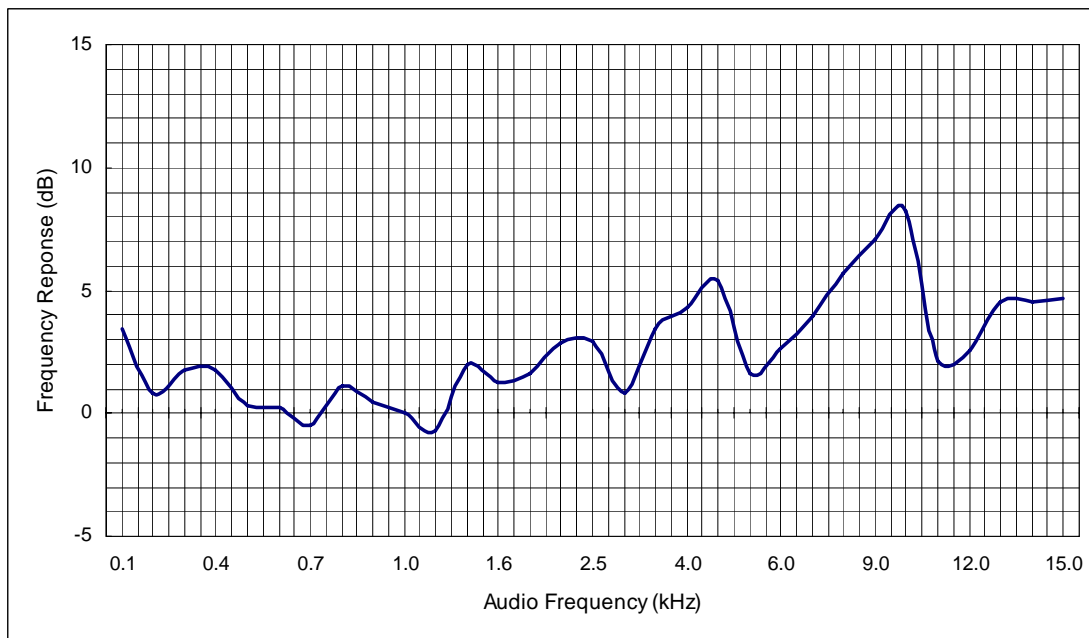
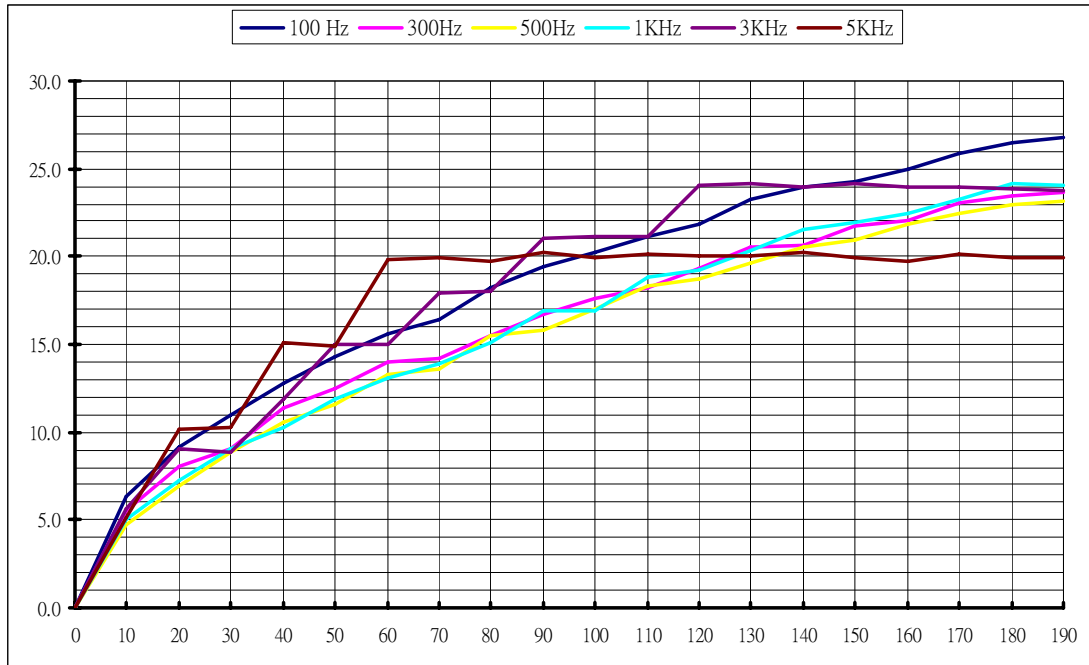



Registration number: W6M20902-9587-C-1

FCC ID: M5X-ACT7T

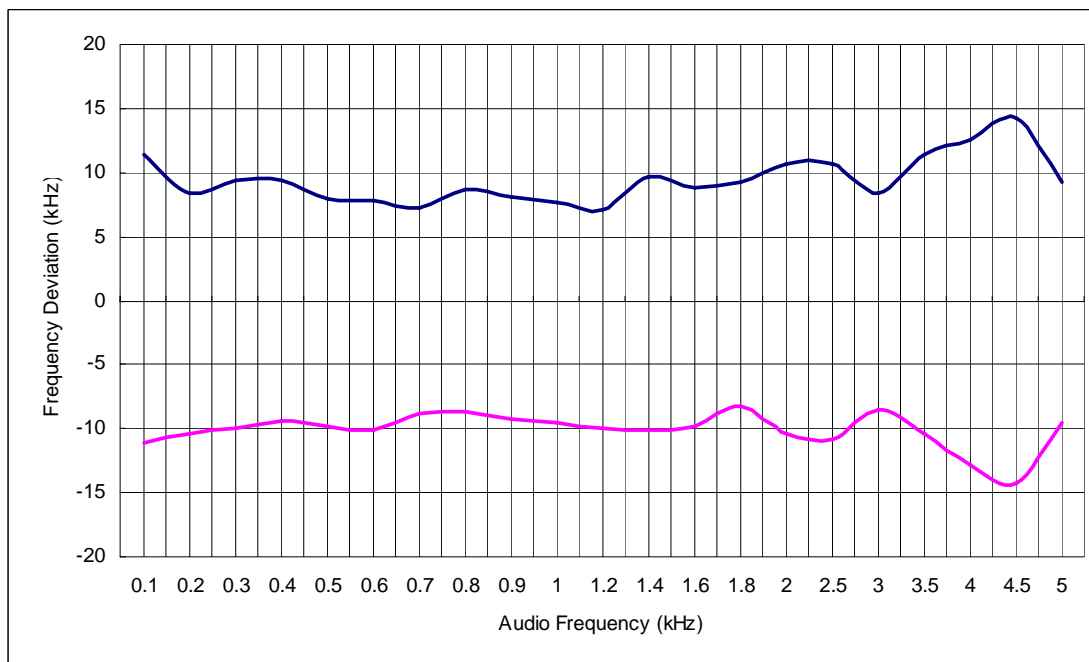
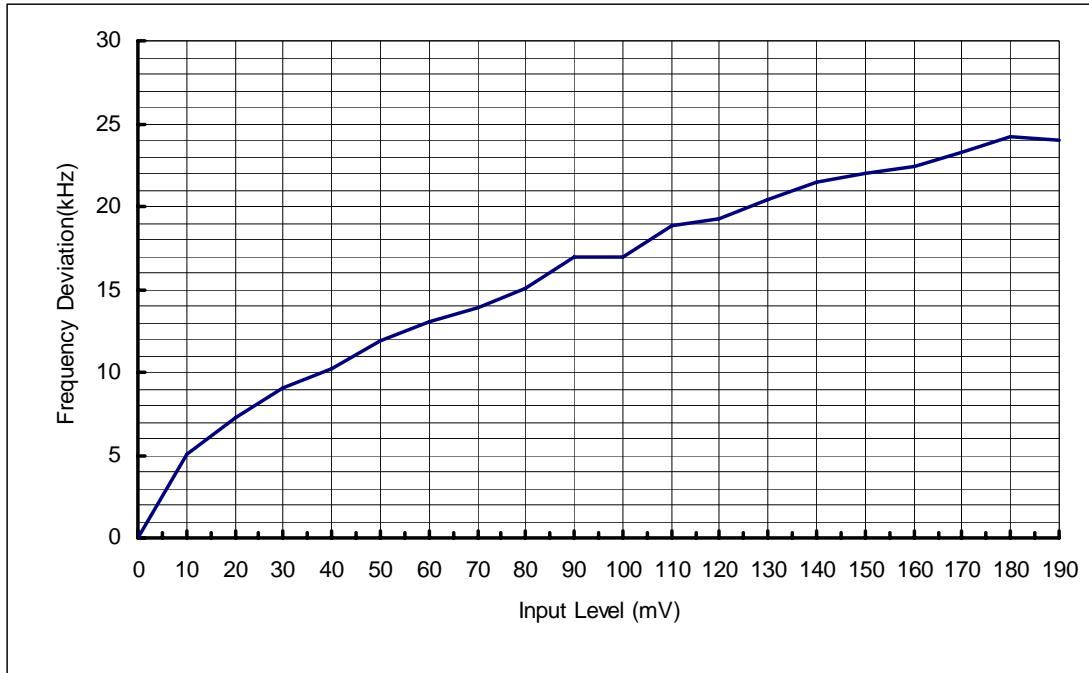



Registration number: W6M20902-9587-C-1

FCC ID: M5X-ACT7T

696.8 MHz

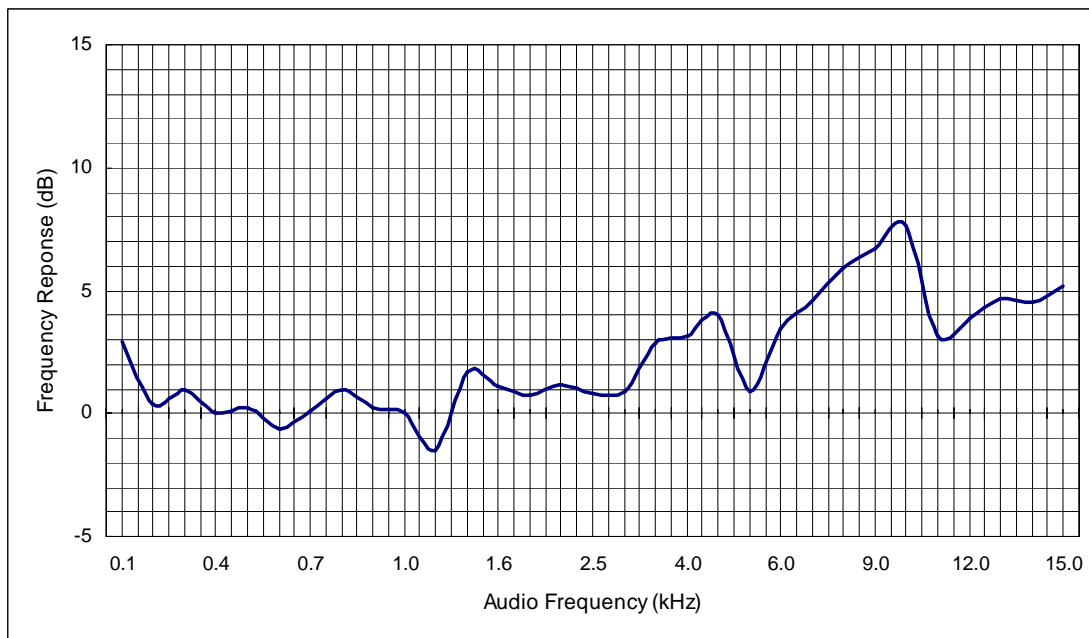
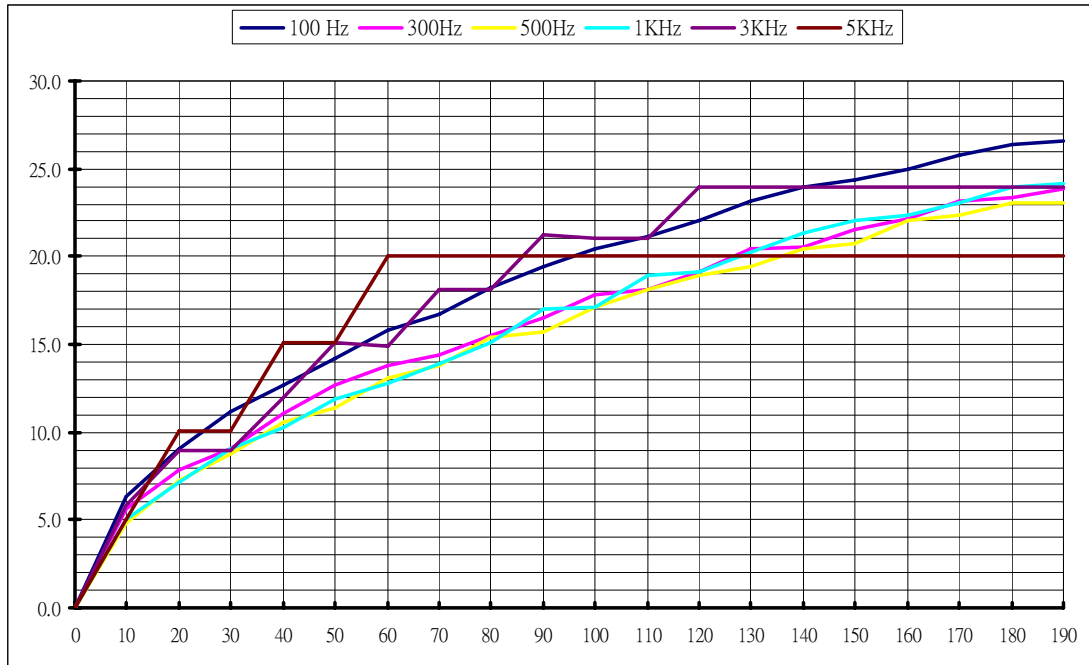



Registration number: W6M20902-9587-C-1

FCC ID: M5X-ACT7T

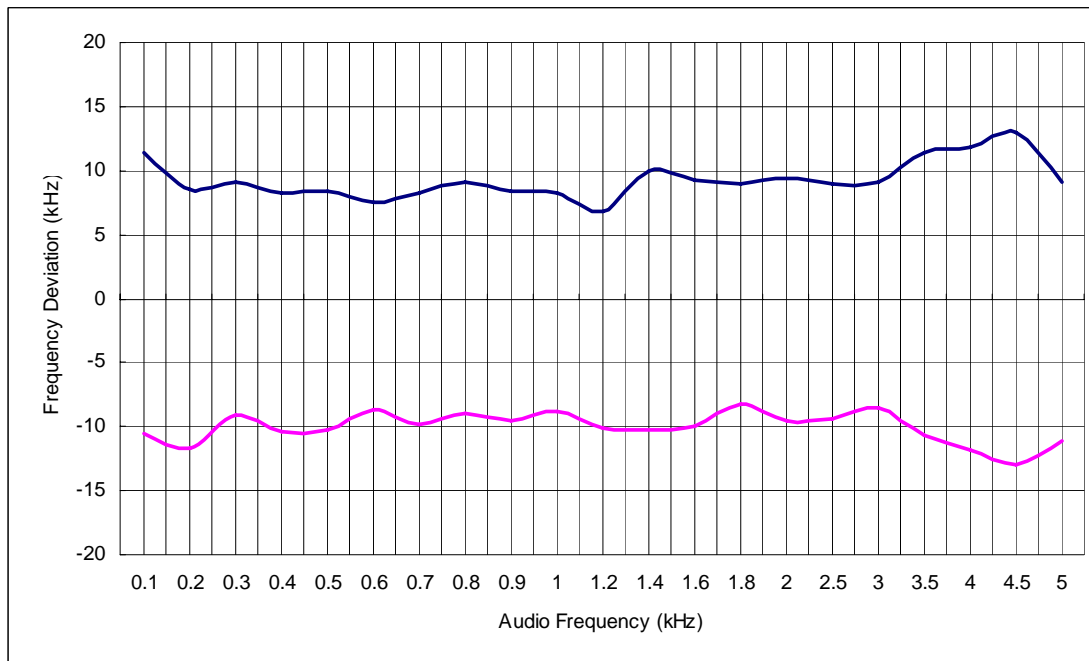
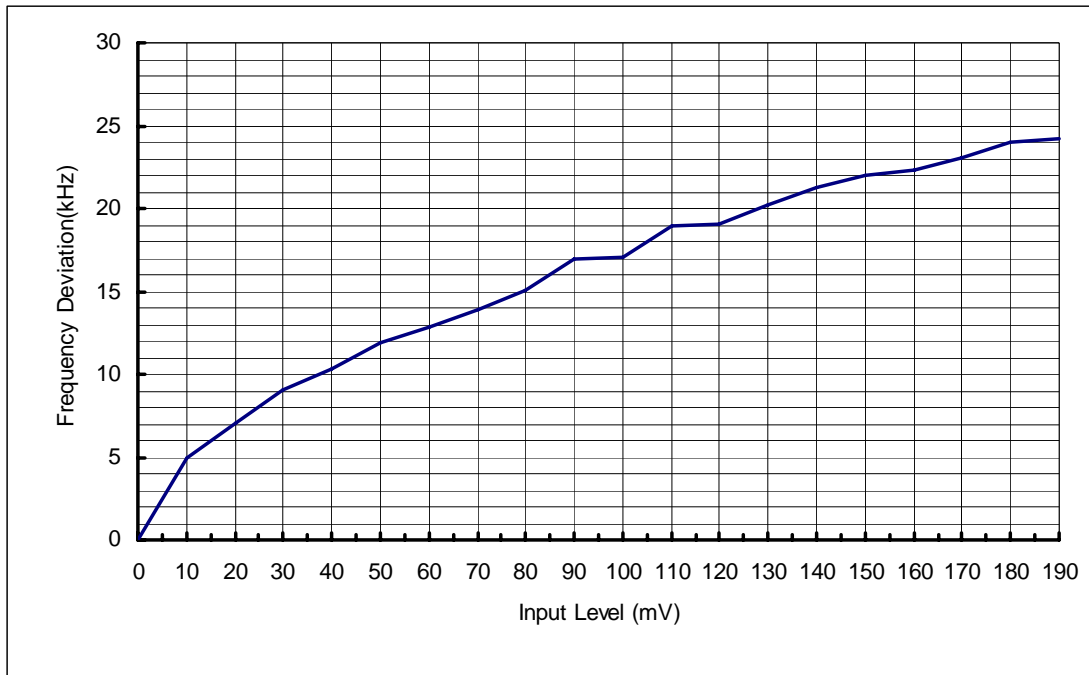

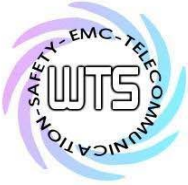

Registration number: W6M20902-9587-C-1

FCC ID: M5X-ACT7T

Occupied Bandwidth / Emission Mask

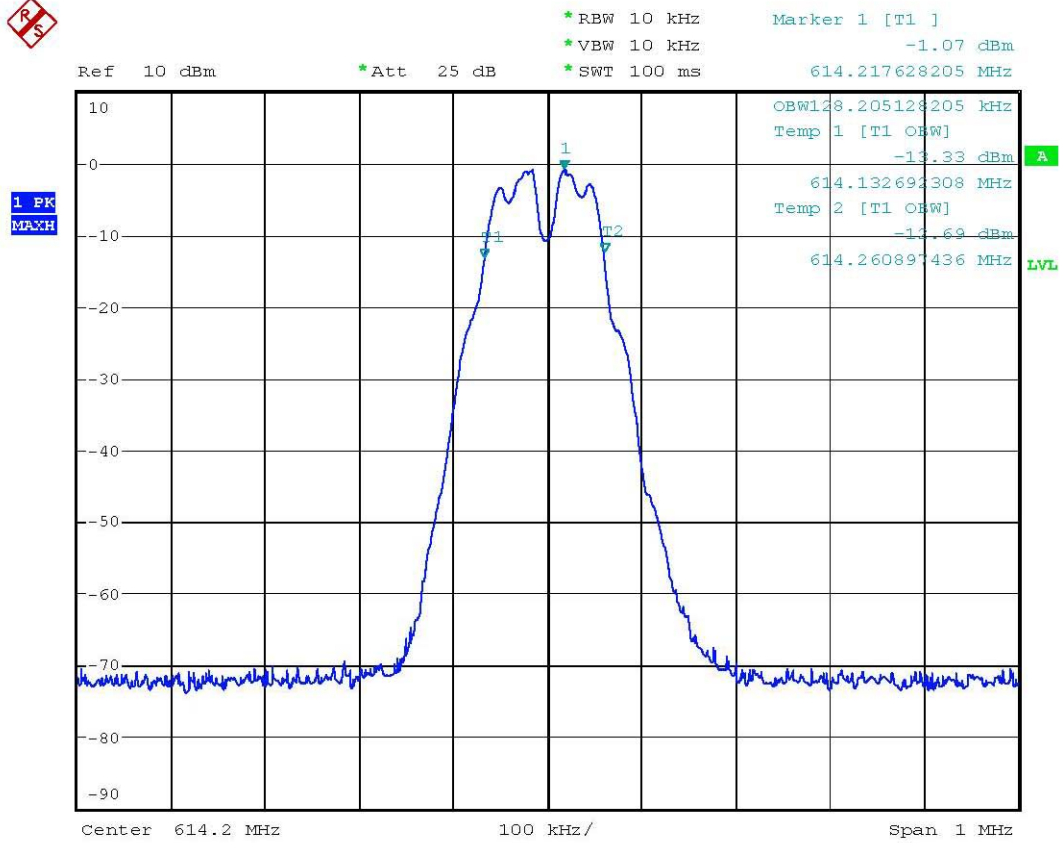

OCCUPIED BANDWIDTH 1000Hz MODULATION 614.2MHz

Date: 26.MAR.2009 09:04:21



Worldwide Testing Services(Taiwan) Co., Ltd.

Registration number: W6M20902-9587-C-1

FCC ID: M5X-ACT7T

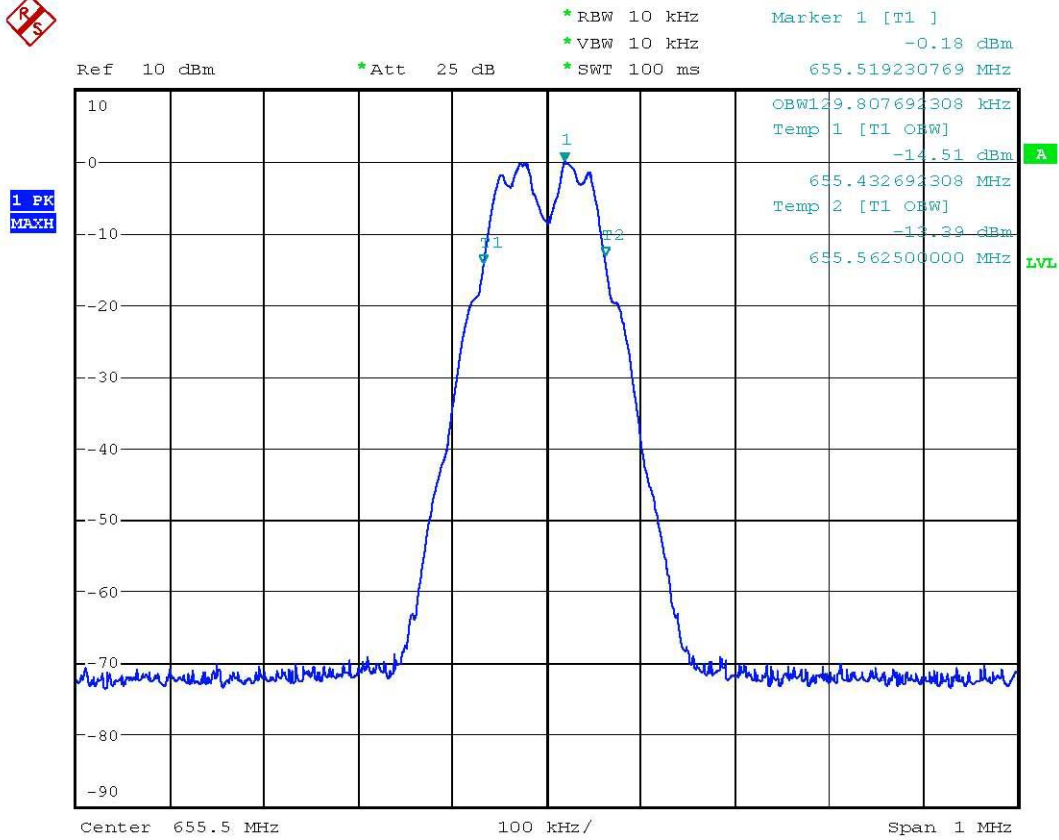

OCCUPIED BANDWIDTH 1000Hz MODULATION 655.5MHz

Date: 26.MAR.2009 09:28:23



Worldwide Testing Services(Taiwan) Co., Ltd.

Registration number: W6M20902-9587-C-1

FCC ID: M5X-ACT7T

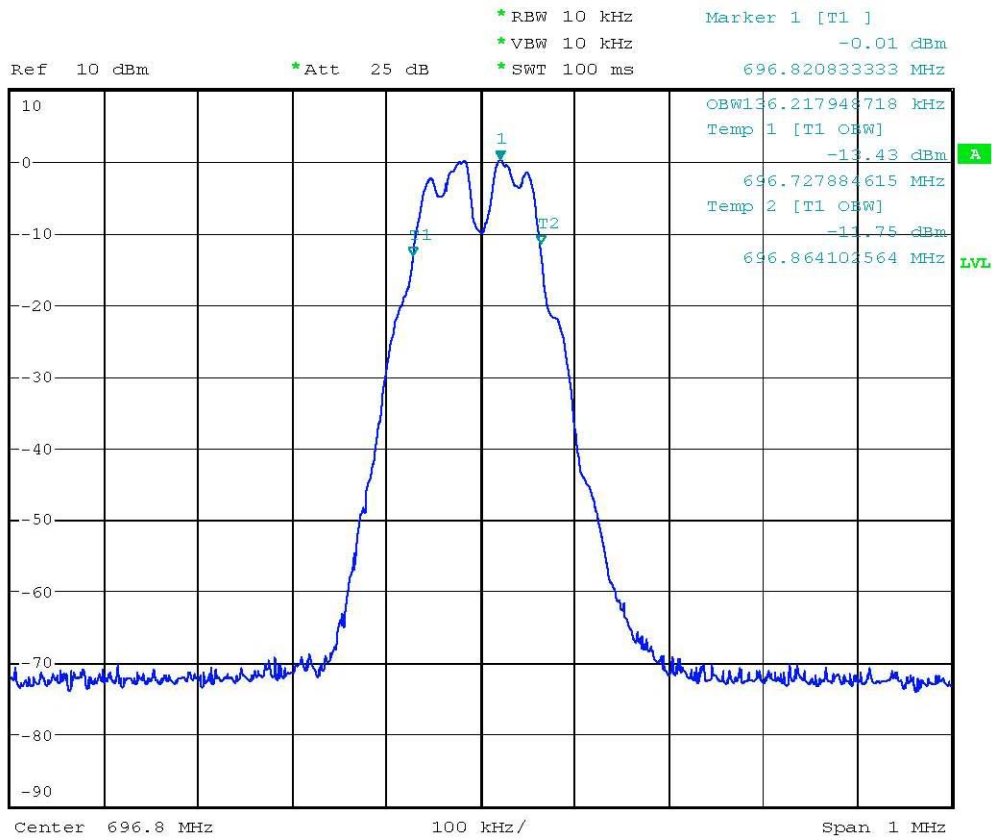

OCCUPIED BANDWIDTH 1000Hz MODULATION 696.8MHz

Date: 26.MAR.2009 09:45:28



Worldwide Testing Services(Taiwan) Co., Ltd.

Registration number: W6M20902-9587-C-1

FCC ID: M5X-ACT7T

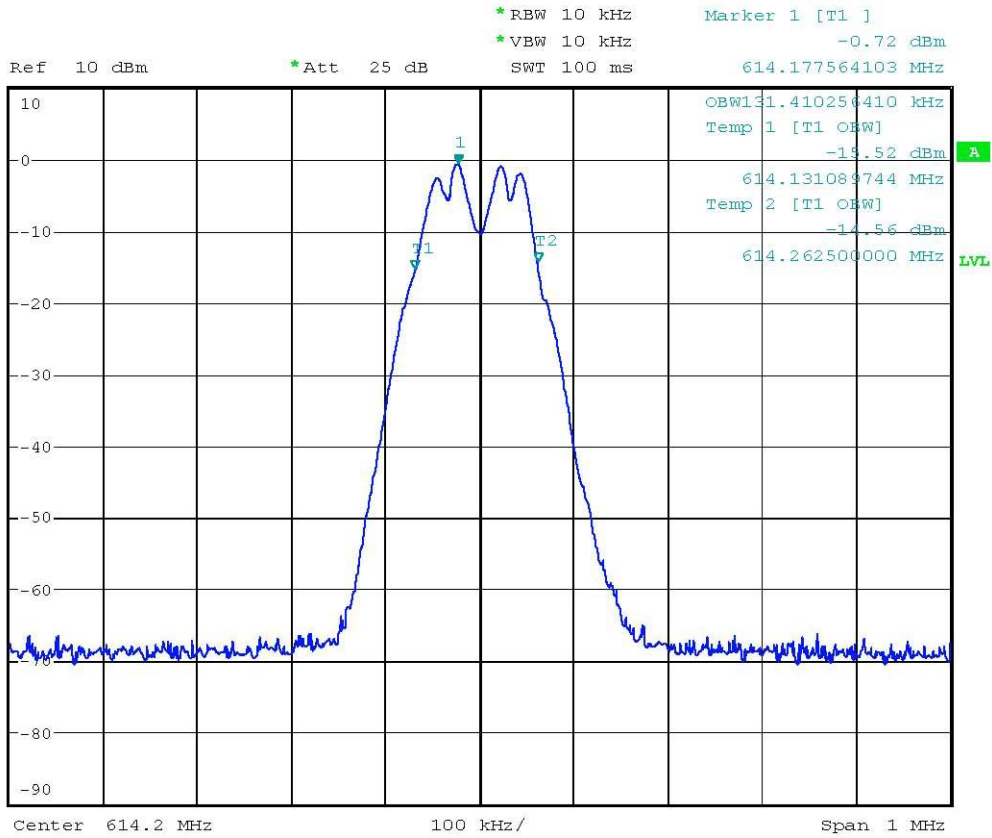

OCCUPIED BANDWIDTH 2500Hz MODULATION 614.2MHz

Date: 2.APR.2009 16:30:26



Worldwide Testing Services(Taiwan) Co., Ltd.

Registration number: W6M20902-9587-C-1

FCC ID: M5X-ACT7T

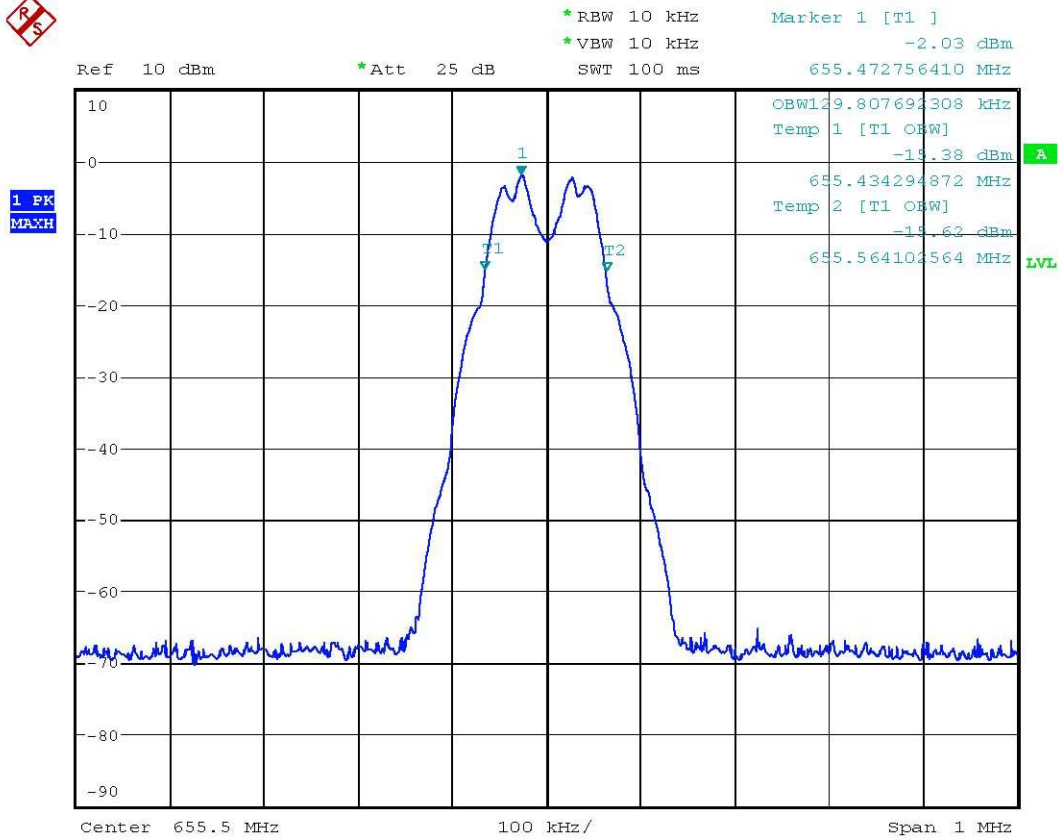

OCCUPIED BANDWIDTH 2500Hz MODULATION 655.5MHz

Date: 2.APR.2009 16:33:34



Worldwide Testing Services(Taiwan) Co., Ltd.

Registration number: W6M20902-9587-C-1

FCC ID: M5X-ACT7T

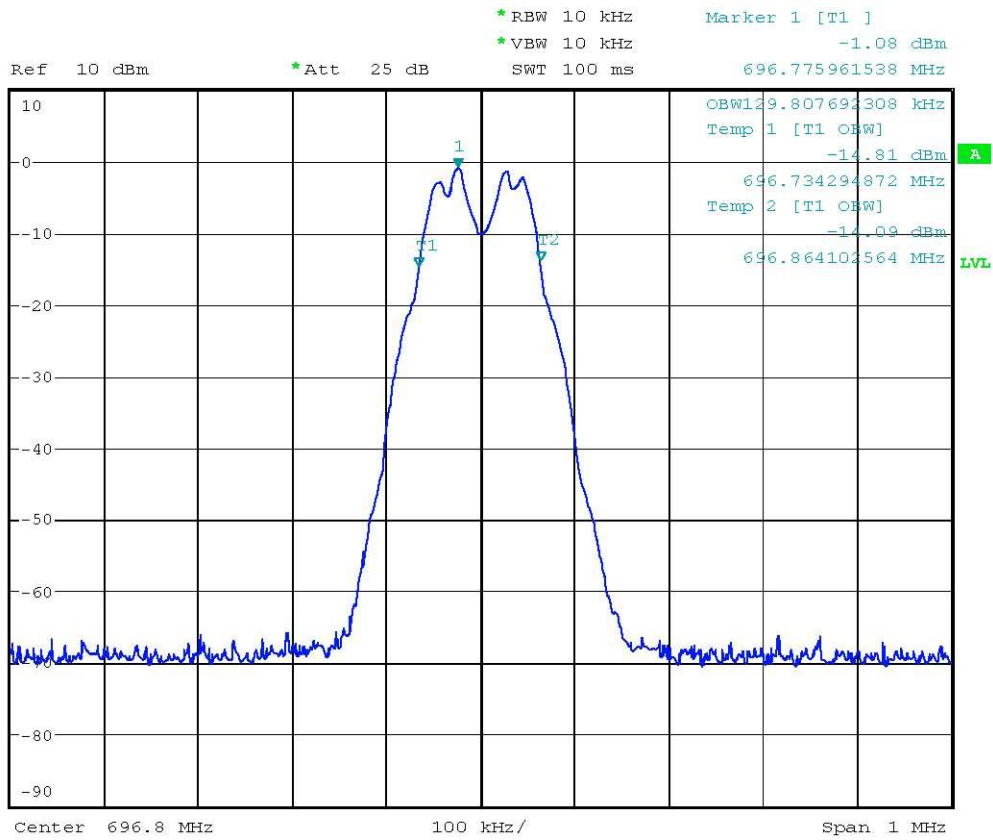

OCCUPIED BANDWIDTH 2500Hz MODULATION 696.8MHz

Date: 2.APR.2009 16:37:11



Worldwide Testing Services(Taiwan) Co., Ltd.

Registration number: W6M20902-9587-C-1

FCC ID: M5X-ACT7T

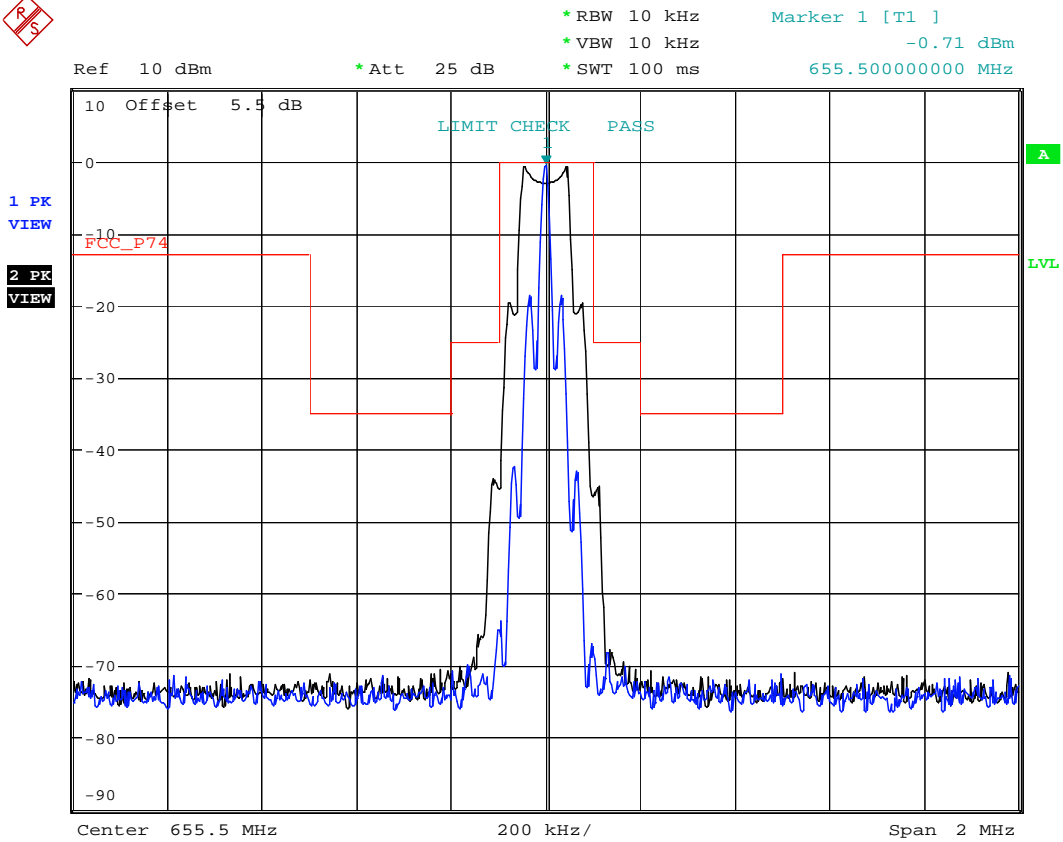

EMISSION MASK 655.5MHz

Date: 26.MAR.2009 09:33:50



Registration number: W6M20902-9587-C-1

FCC ID: M5X-ACT7T

Radiation Spurious Emission

CH Low_614.2 MHz

Antenna Polarization H

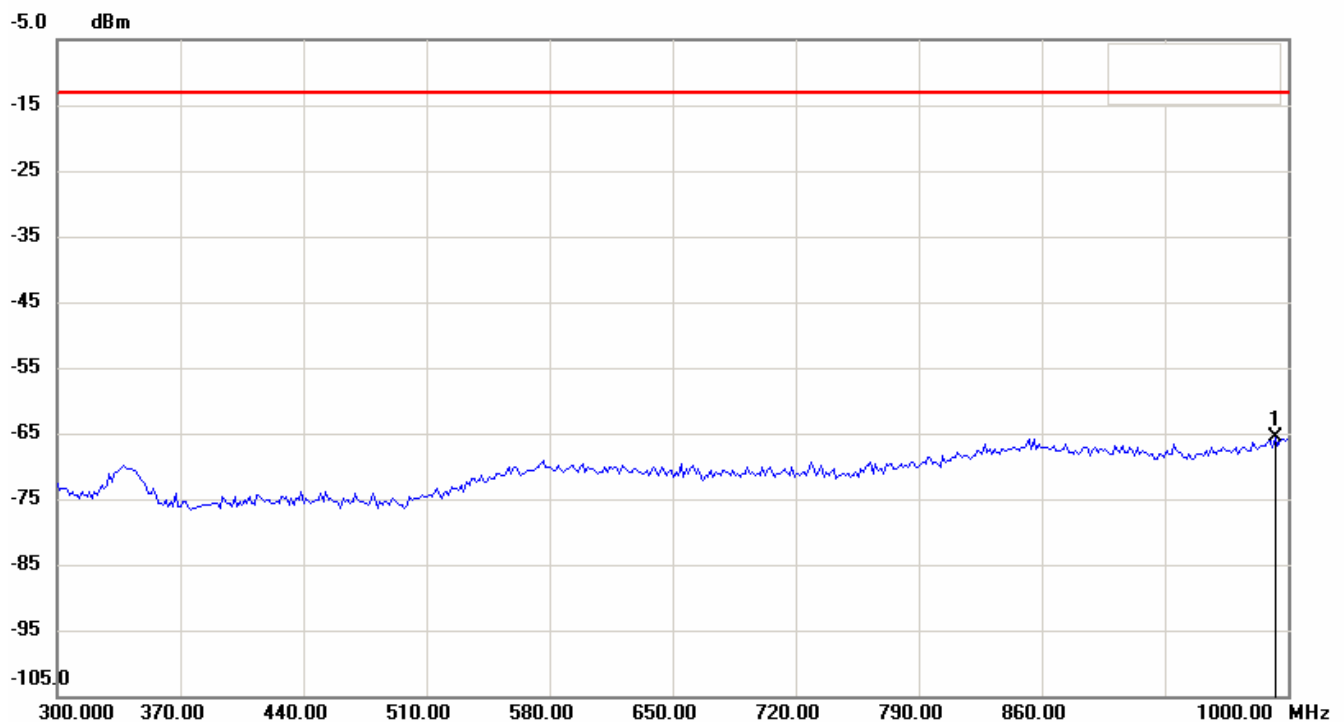
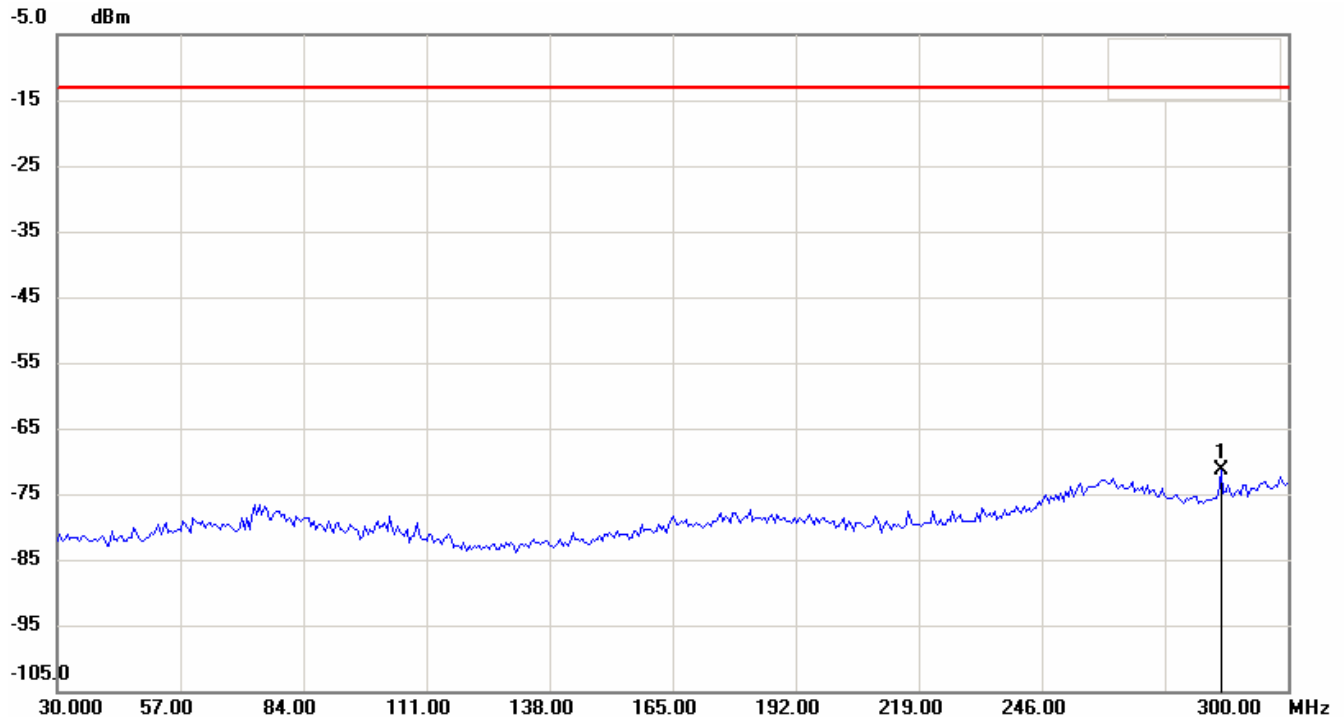

Note:

4. The attached measurement plots are preliminarily pre-scanned with peak detector for determining the final checking frequencies and are for reference only.
5. The some frequencies may exceed the limit line without the specified detectors, but that cannot present the results are failed to the specification of test standard.
6. For corrected test results are listed in the relevant table of radiated test data of this test report.



Registration number: W6M20902-9587-C-1

FCC ID: M5X-ACT7T

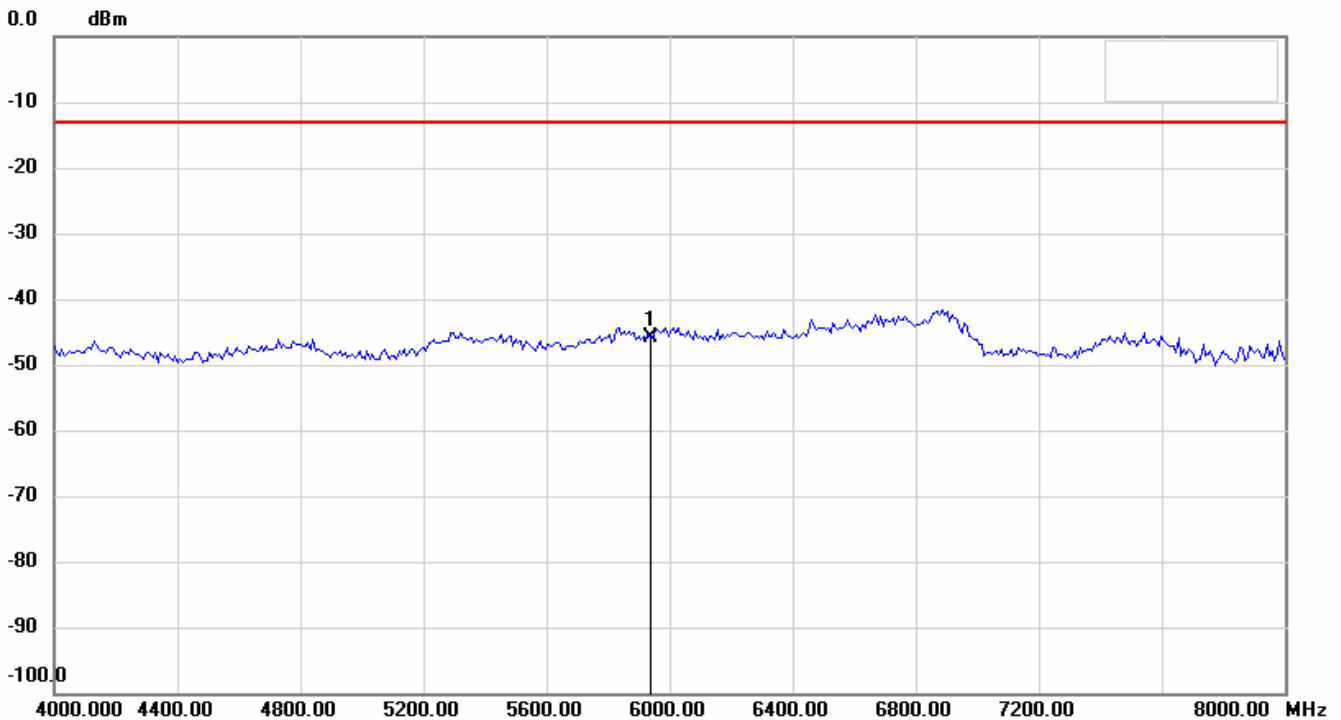
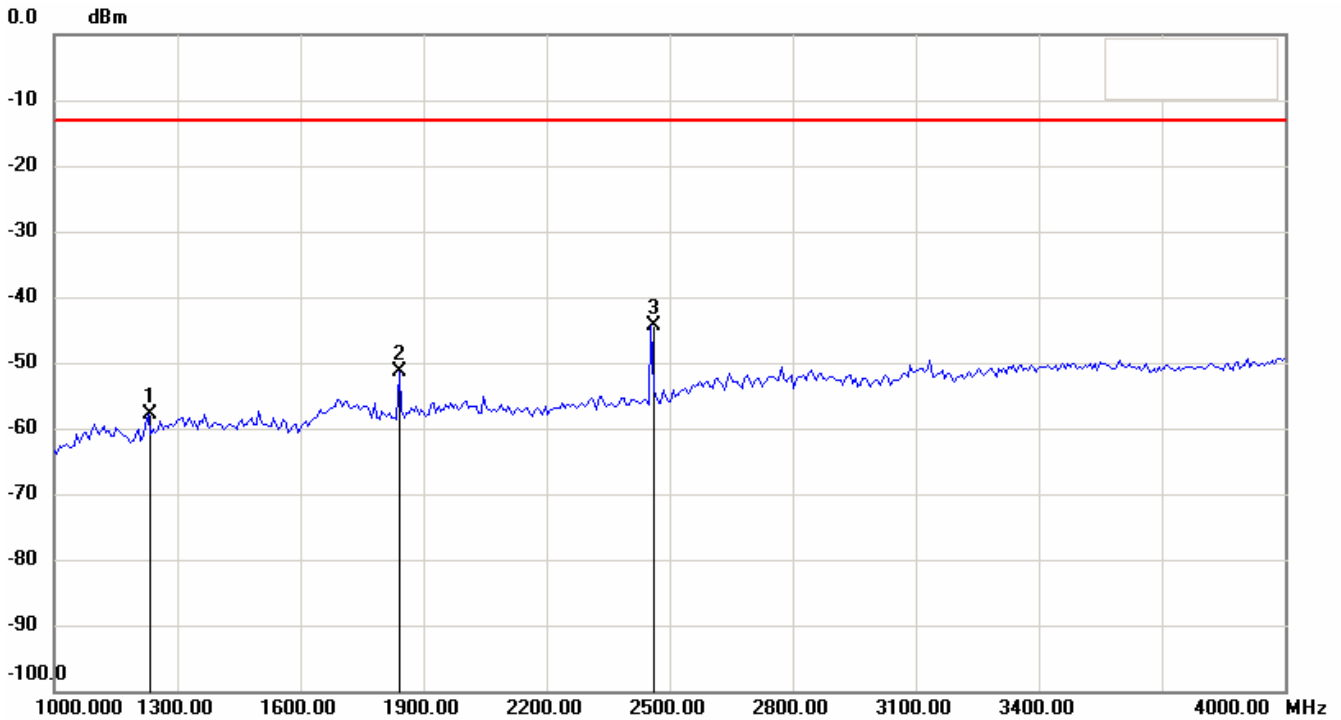

Note:

1. The attached measurement plots are preliminarily pre-scanned with peak detector for determining the final checking frequencies and are for reference only.
2. The some frequencies may exceed the limit line without the specified detectors, but that cannot present the results are failed to the specification of test standard.
3. For corrected test results are listed in the relevant table of radiated test data of this test report.



Registration number: W6M20902-9587-C-1

FCC ID: M5X-ACT7T

Antenna Polarization V

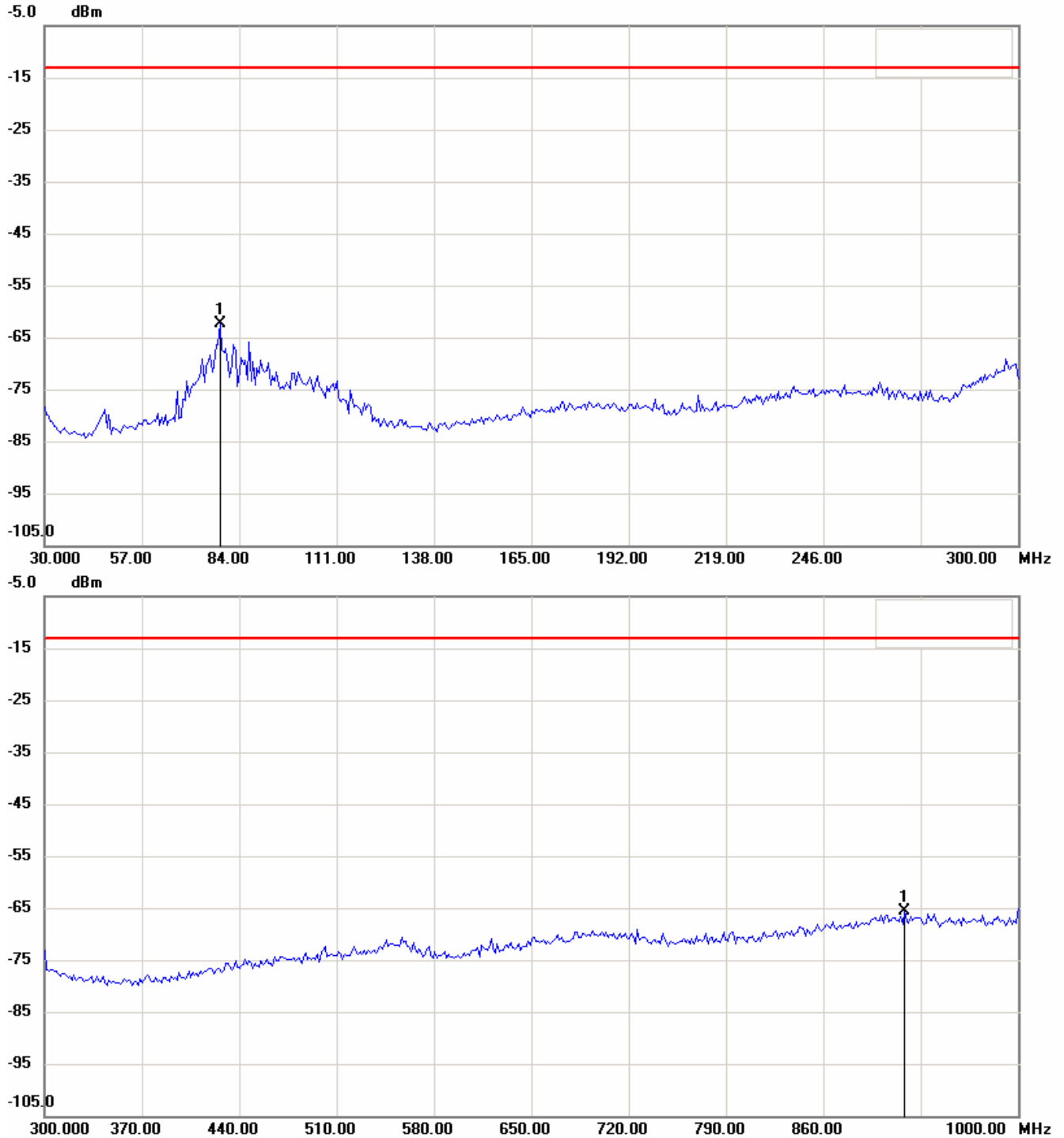

Note:

1. The attached measurement plots are preliminarily pre-scanned with peak detector for determining the final checking frequencies and are for reference only.
2. The some frequencies may exceed the limit line without the specified detectors, but that cannot present the results are failed to the specification of test standard.
3. For corrected test results are listed in the relevant table of radiated test data of this test report.



Worldwide Testing Services(Taiwan) Co., Ltd.

Registration number: W6M20902-9587-C-1

FCC ID: M5X-ACT7T

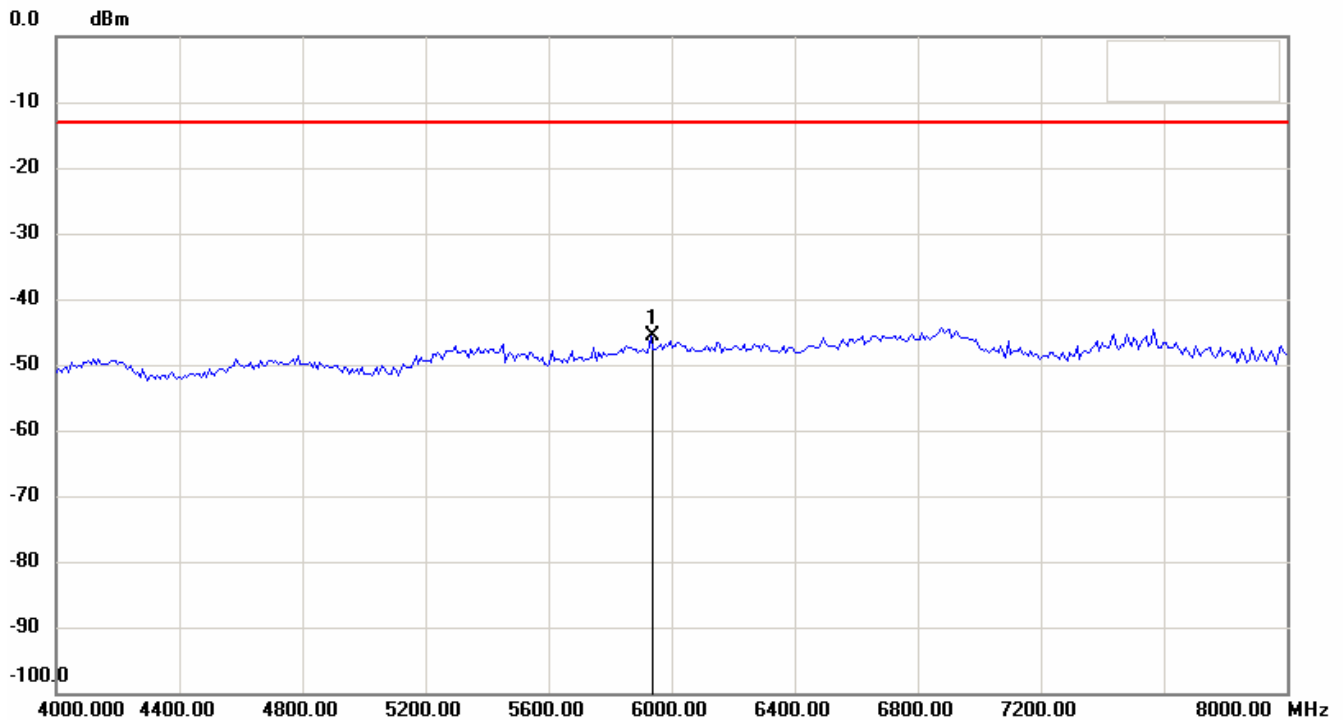
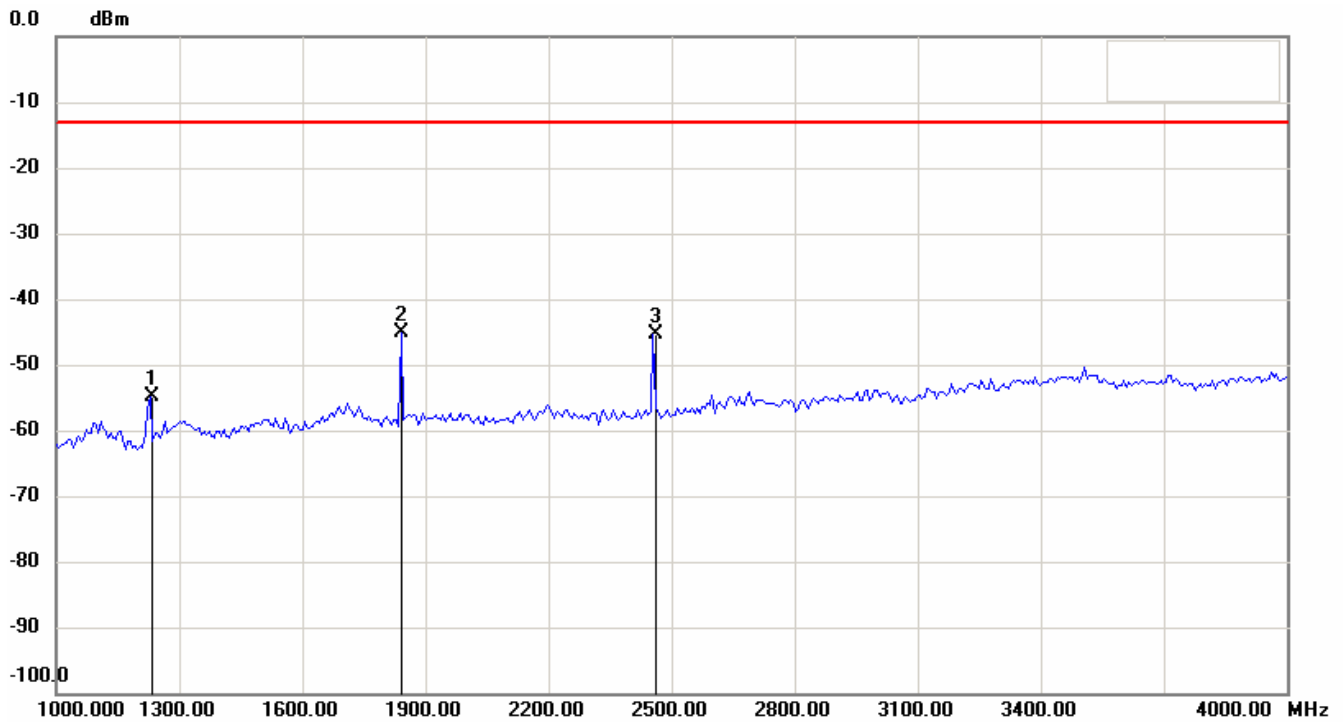

Note:

1. The attached measurement plots are preliminarily pre-scanned with peak detector for determining the final checking frequencies and are for reference only.
2. The some frequencies may exceed the limit line without the specified detectors, but that cannot present the results are failed to the specification of test standard.
3. For corrected test results are listed in the relevant table of radiated test data of this test report.

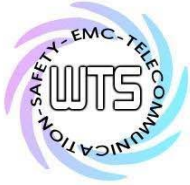

Registration number: W6M20902-9587-C-1

FCC ID: M5X-ACT7T

CH Middle_655.5 MHz

Antenna Polarization H

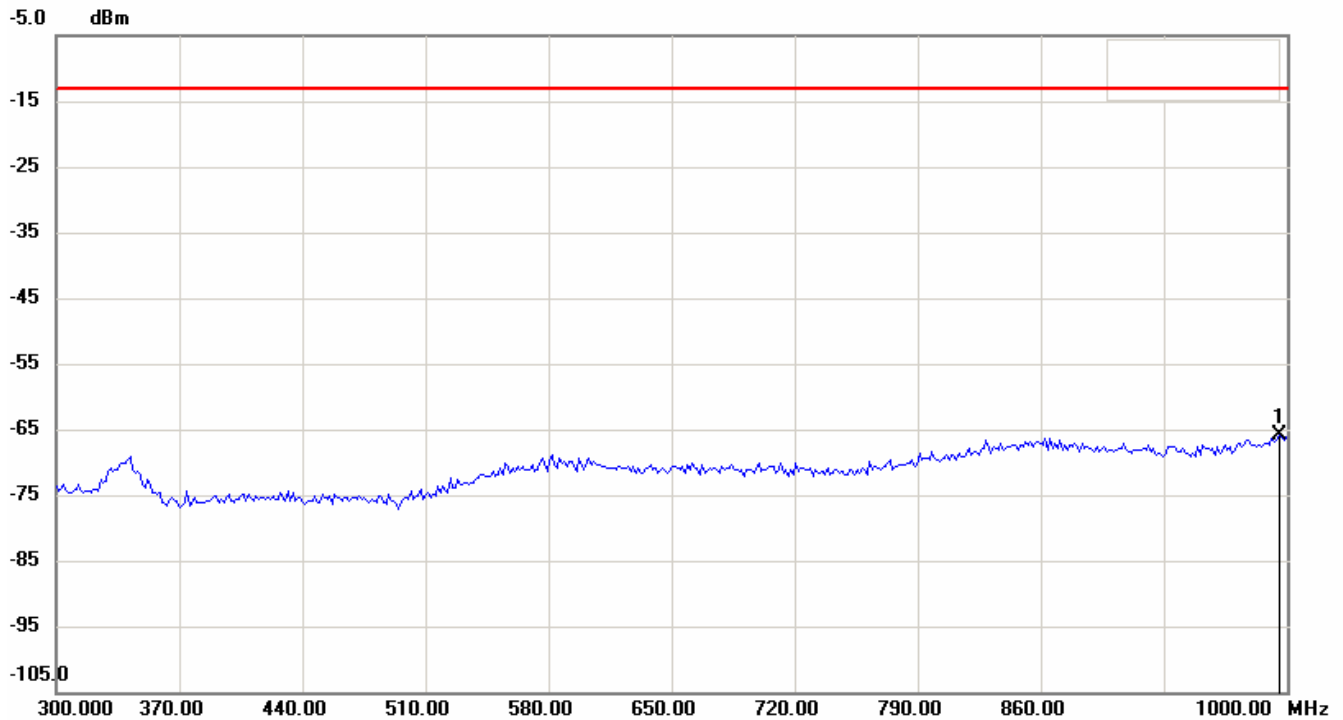
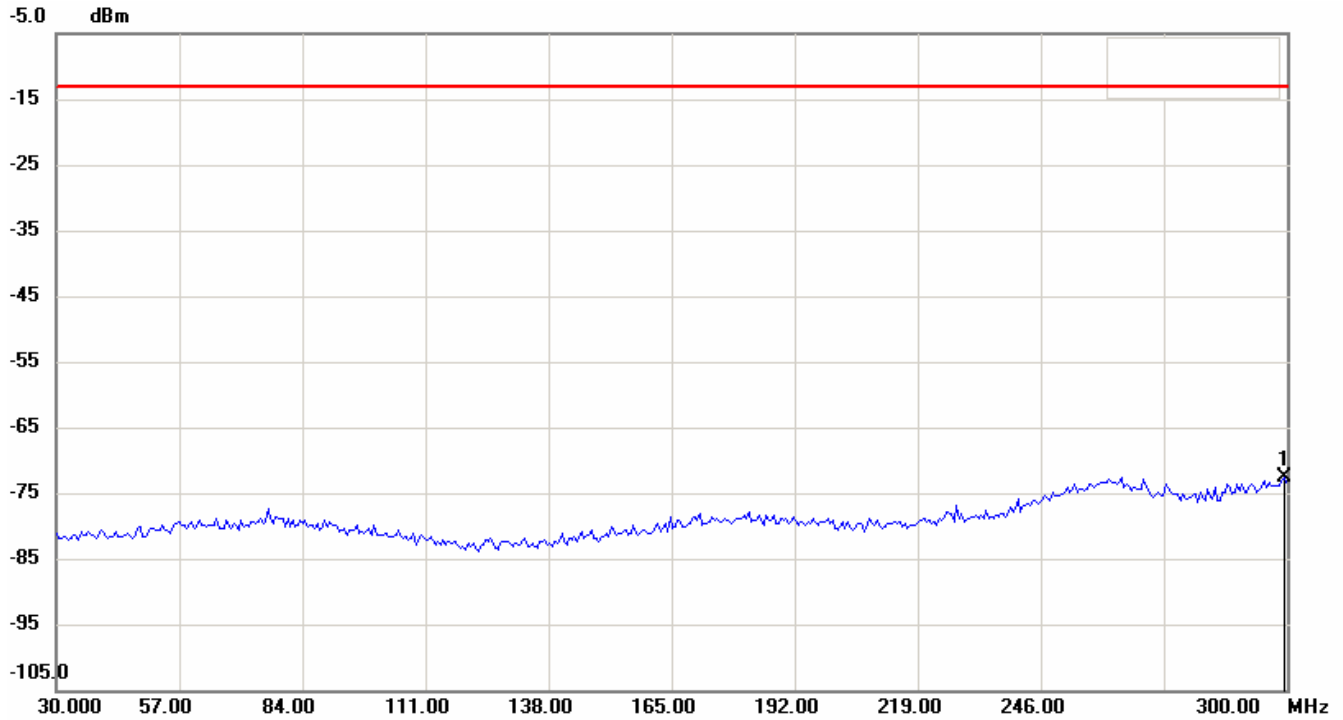

Note:

1. The attached measurement plots are preliminarily pre-scanned with peak detector for determining the final checking frequencies and are for reference only.
2. The some frequencies may exceed the limit line without the specified detectors, but that cannot present the results are failed to the specification of test standard.
3. For corrected test results are listed in the relevant table of radiated test data of this test report.



Registration number: W6M20902-9587-C-1

FCC ID: M5X-ACT7T

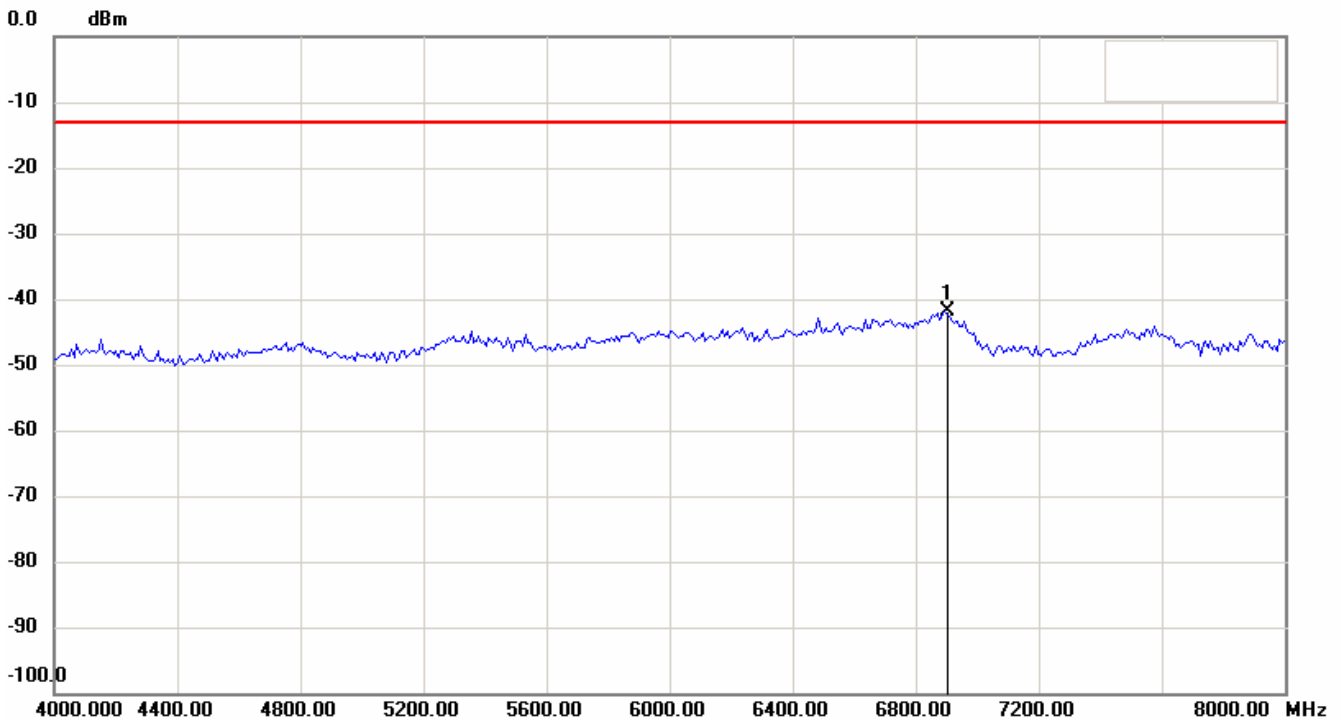
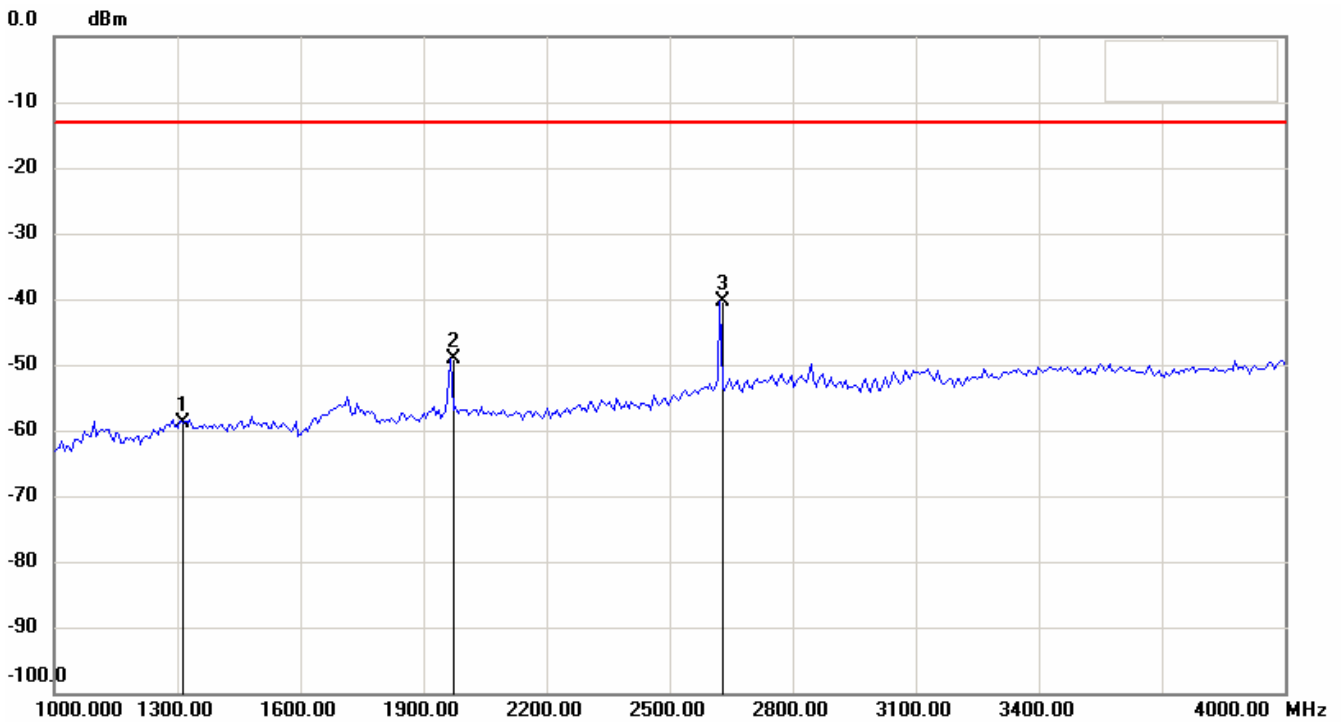

Note:

1. The attached measurement plots are preliminarily pre-scanned with peak detector for determining the final checking frequencies and are for reference only.
2. The some frequencies may exceed the limit line without the specified detectors, but that cannot present the results are failed to the specification of test standard.
3. For corrected test results are listed in the relevant table of radiated test data of this test report.

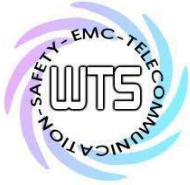

Registration number: W6M20902-9587-C-1

FCC ID: M5X-ACT7T

Antenna Polarization V

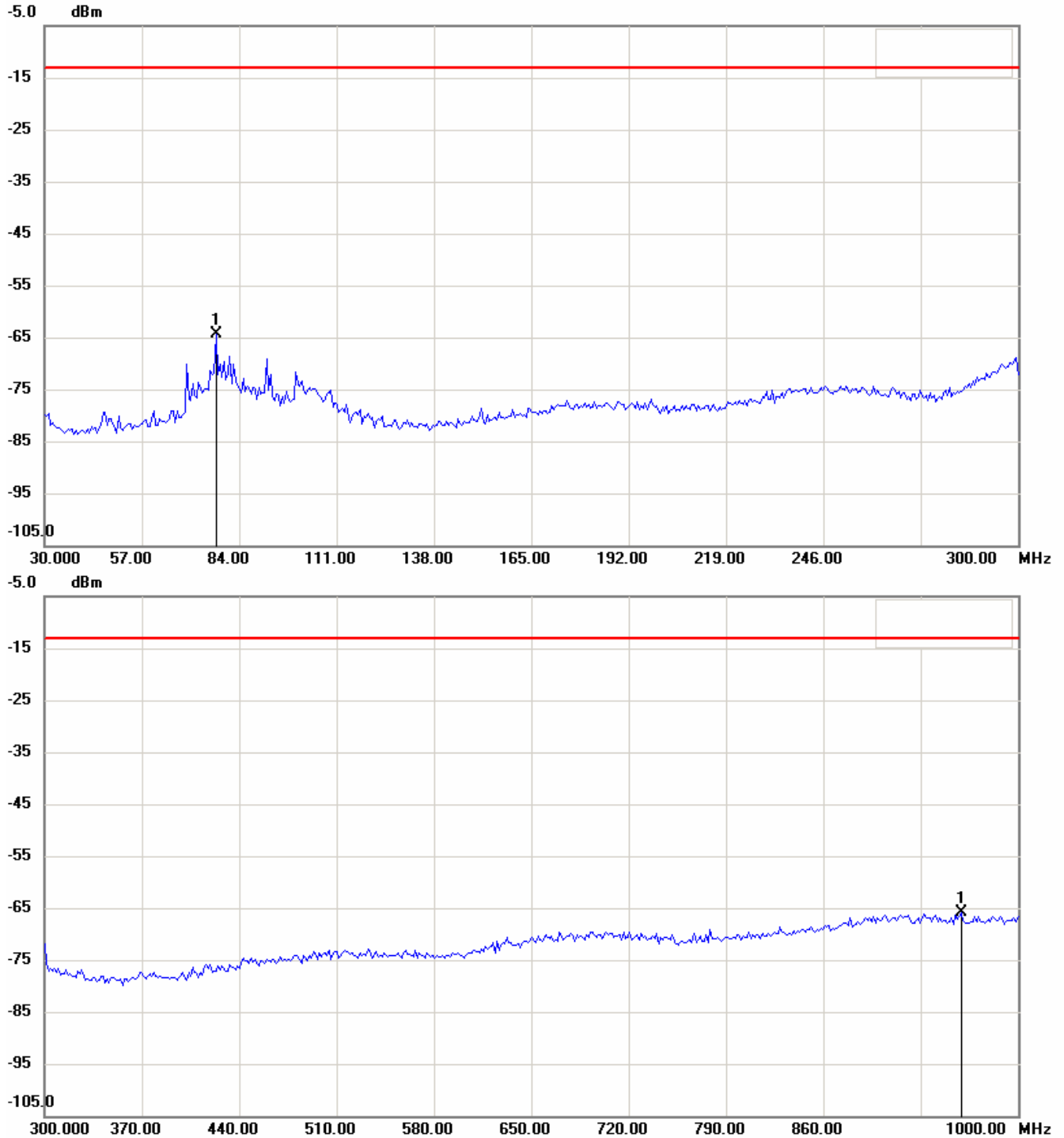

Note:

1. The attached measurement plots are preliminarily pre-scanned with peak detector for determining the final checking frequencies and are for reference only.
2. The some frequencies may exceed the limit line without the specified detectors, but that cannot present the results are failed to the specification of test standard.
3. For corrected test results are listed in the relevant table of radiated test data of this test report.



Registration number: W6M20902-9587-C-1

FCC ID: M5X-ACT7T

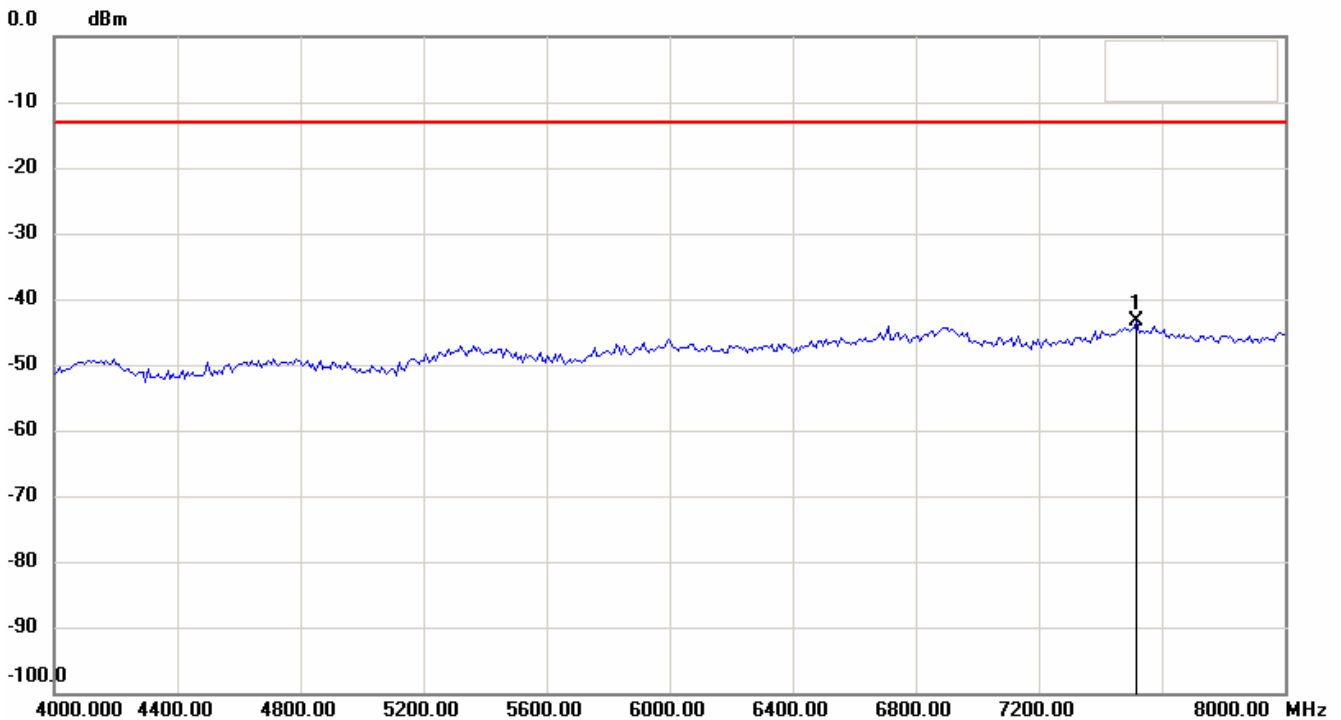
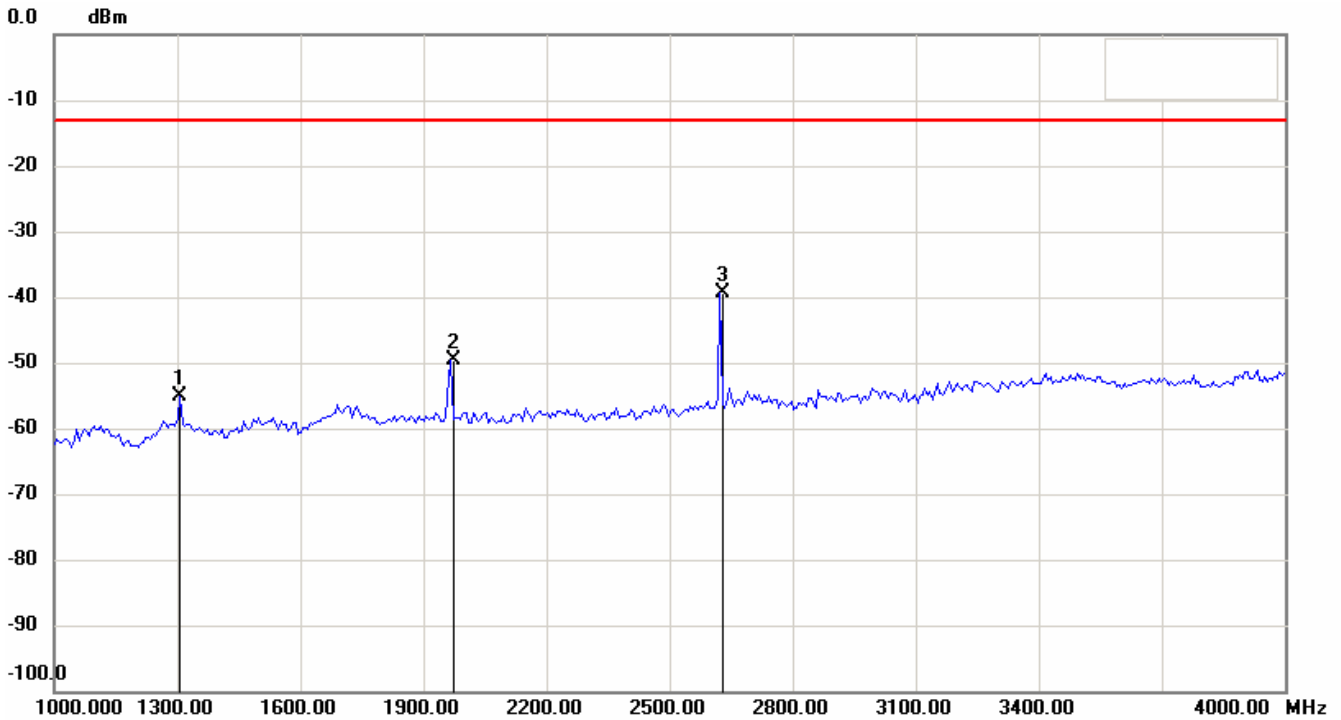

Note:

1. The attached measurement plots are preliminarily pre-scanned with peak detector for determining the final checking frequencies and are for reference only.
2. The some frequencies may exceed the limit line without the specified detectors, but that cannot present the results are failed to the specification of test standard.
3. For corrected test results are listed in the relevant table of radiated test data of this test report.

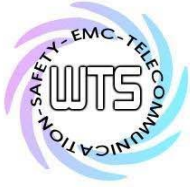

Worldwide Testing Services(Taiwan) Co., Ltd.

Registration number: W6M20902-9587-C-1

FCC ID: M5X-ACT7T

CH High_696.8 MHz

Antenna Polarization H

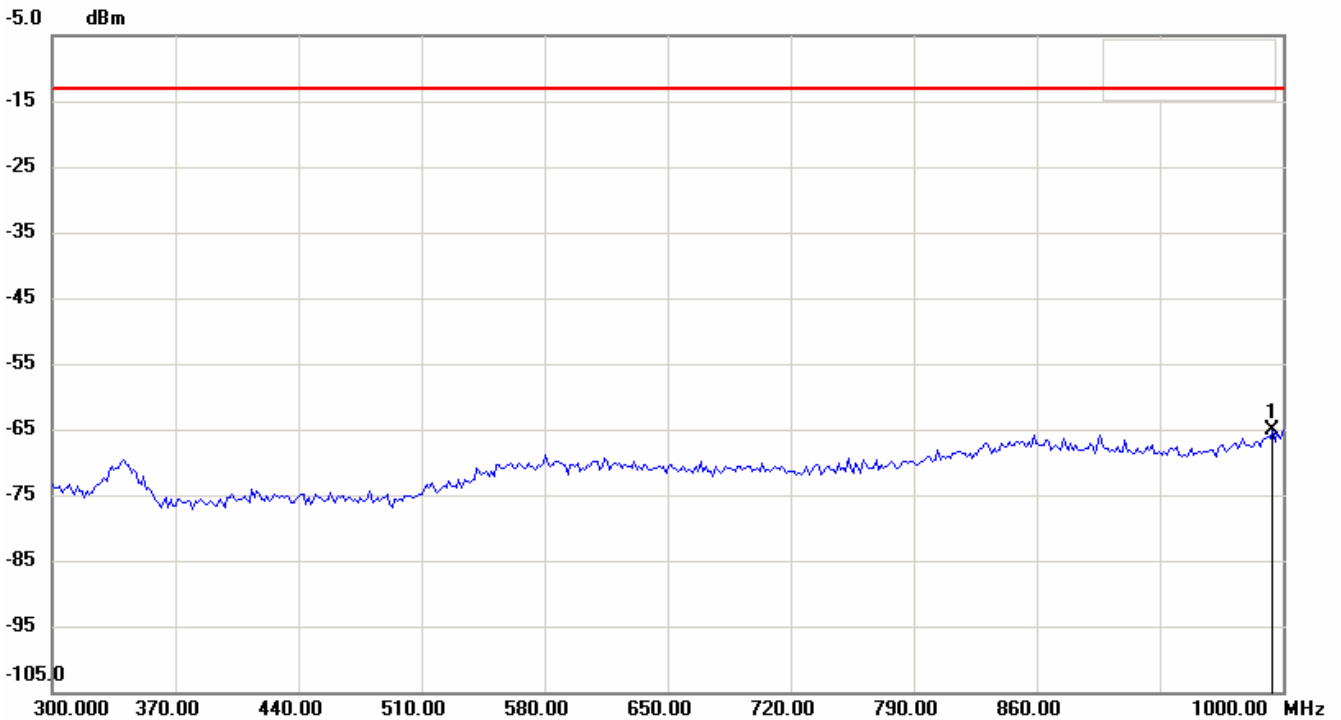
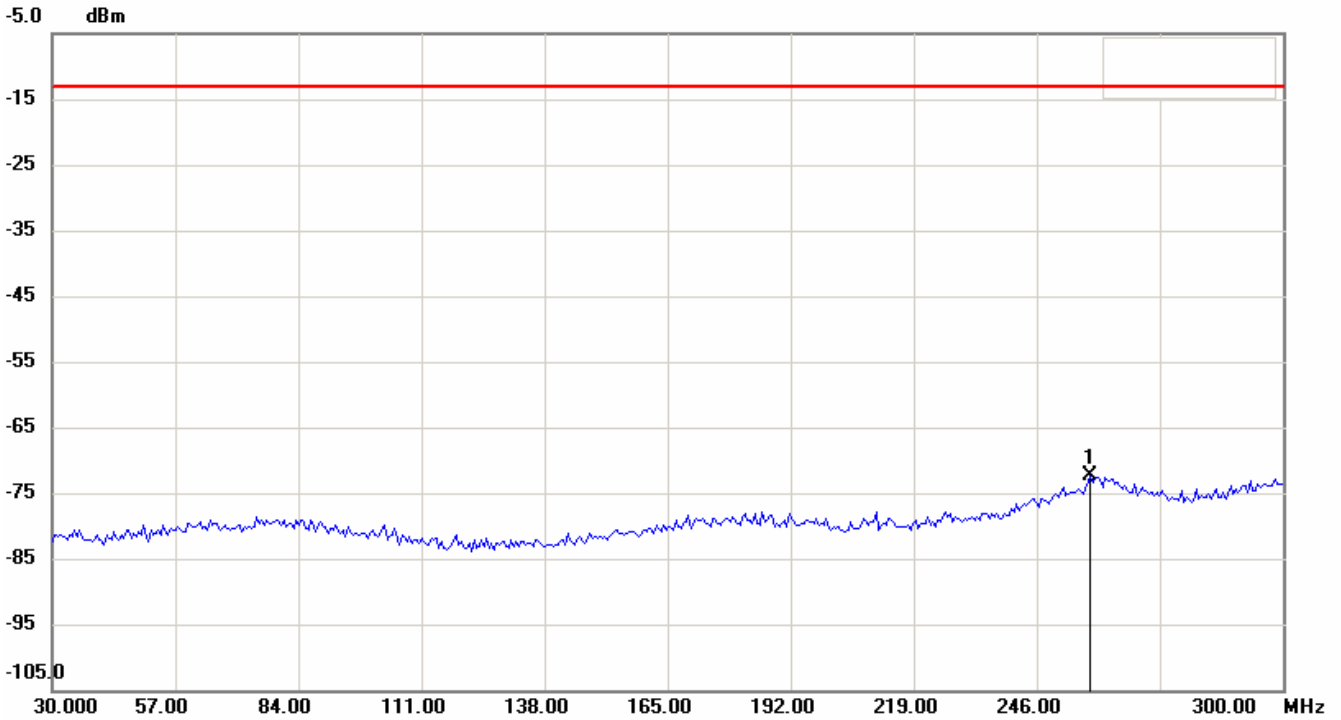

Note:

1. The attached measurement plots are preliminarily pre-scanned with peak detector for determining the final checking frequencies and are for reference only.
2. The some frequencies may exceed the limit line without the specified detectors, but that cannot present the results are failed to the specification of test standard.
3. For corrected test results are listed in the relevant table of radiated test data of this test report.



Registration number: W6M20902-9587-C-1

FCC ID: M5X-ACT7T

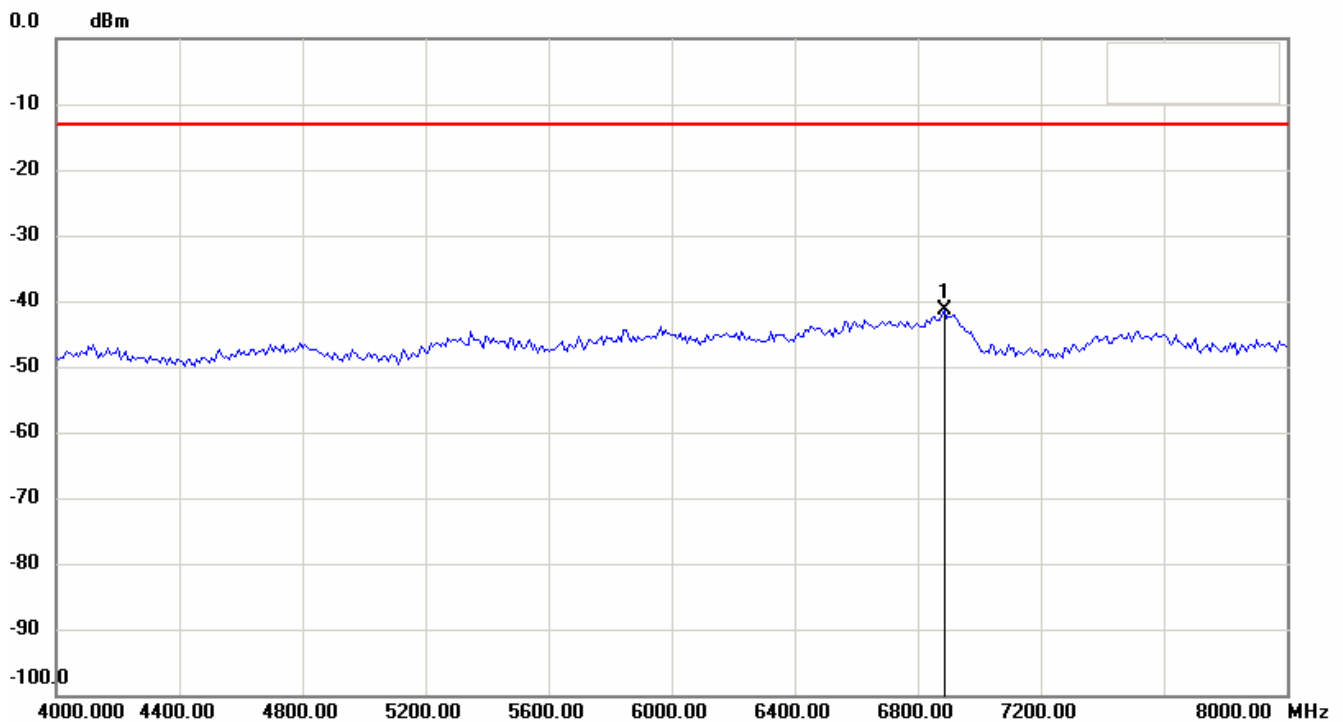
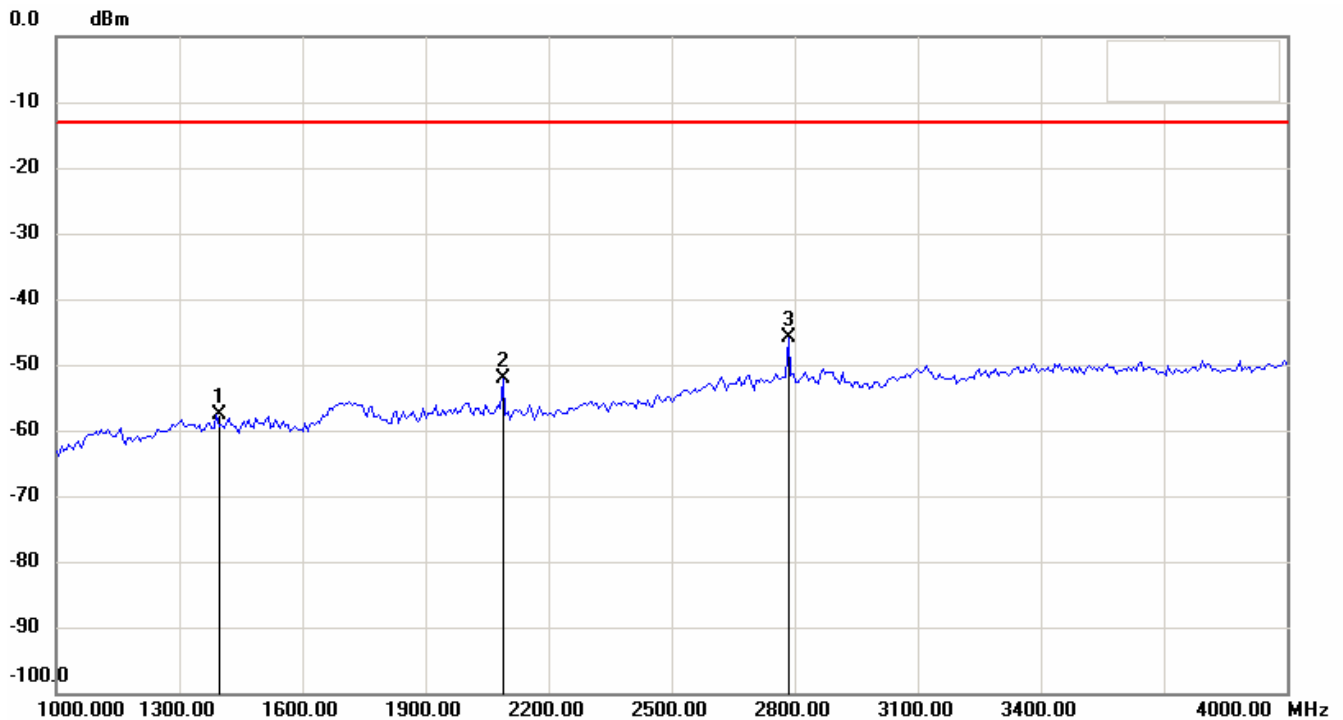

Note:

1. The attached measurement plots are preliminarily pre-scanned with peak detector for determining the final checking frequencies and are for reference only.
2. The some frequencies may exceed the limit line without the specified detectors, but that cannot present the results are failed to the specification of test standard.
3. For corrected test results are listed in the relevant table of radiated test data of this test report.



Registration number: W6M20902-9587-C-1

FCC ID: M5X-ACT7T

Antenna Polarization V

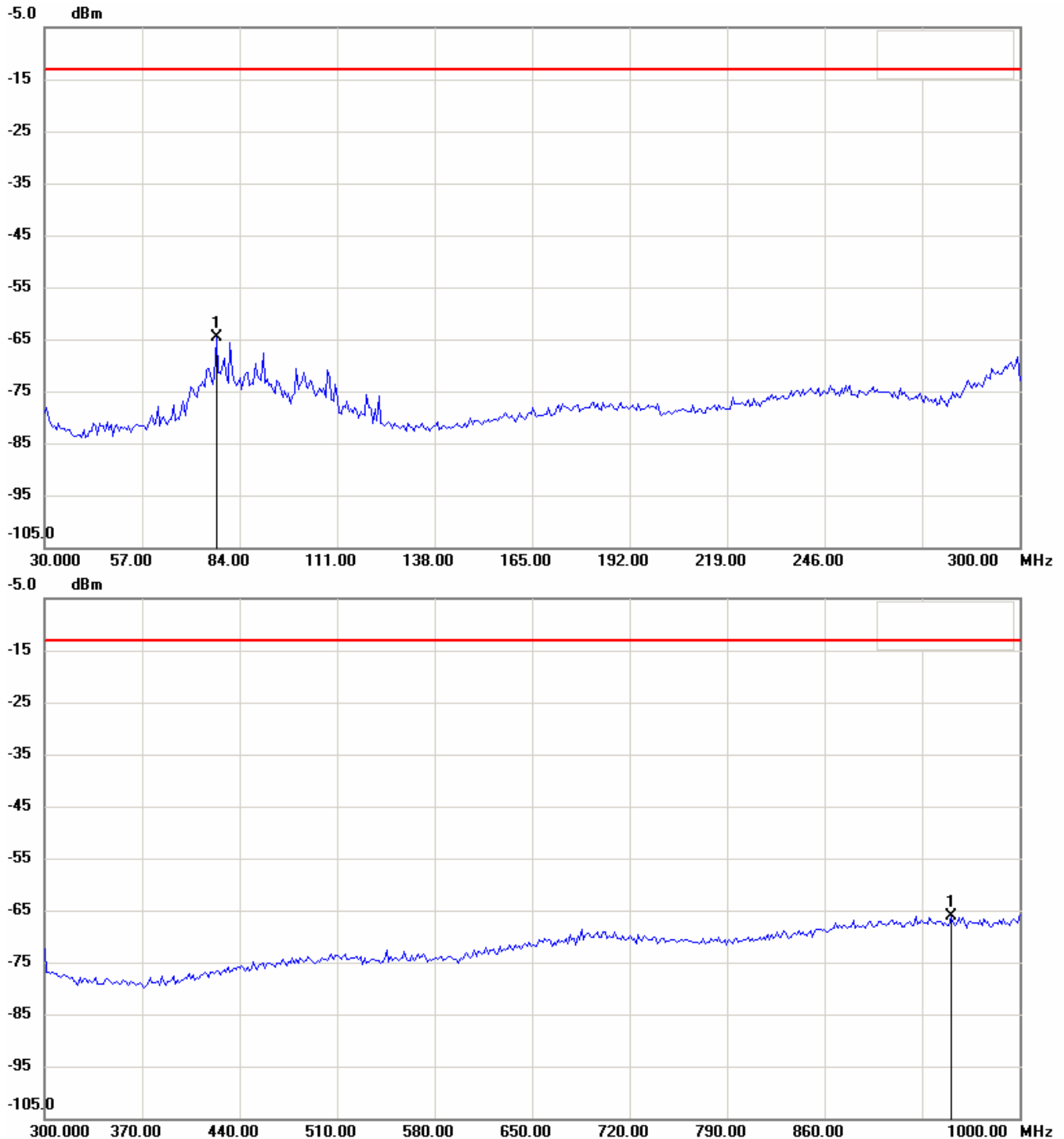

Note:

1. The attached measurement plots are preliminarily pre-scanned with peak detector for determining the final checking frequencies and are for reference only.
2. The some frequencies may exceed the limit line without the specified detectors, but that cannot present the results are failed to the specification of test standard.
3. For corrected test results are listed in the relevant table of radiated test data of this test report.



Registration number: W6M20902-9587-C-1

FCC ID: M5X-ACT7T

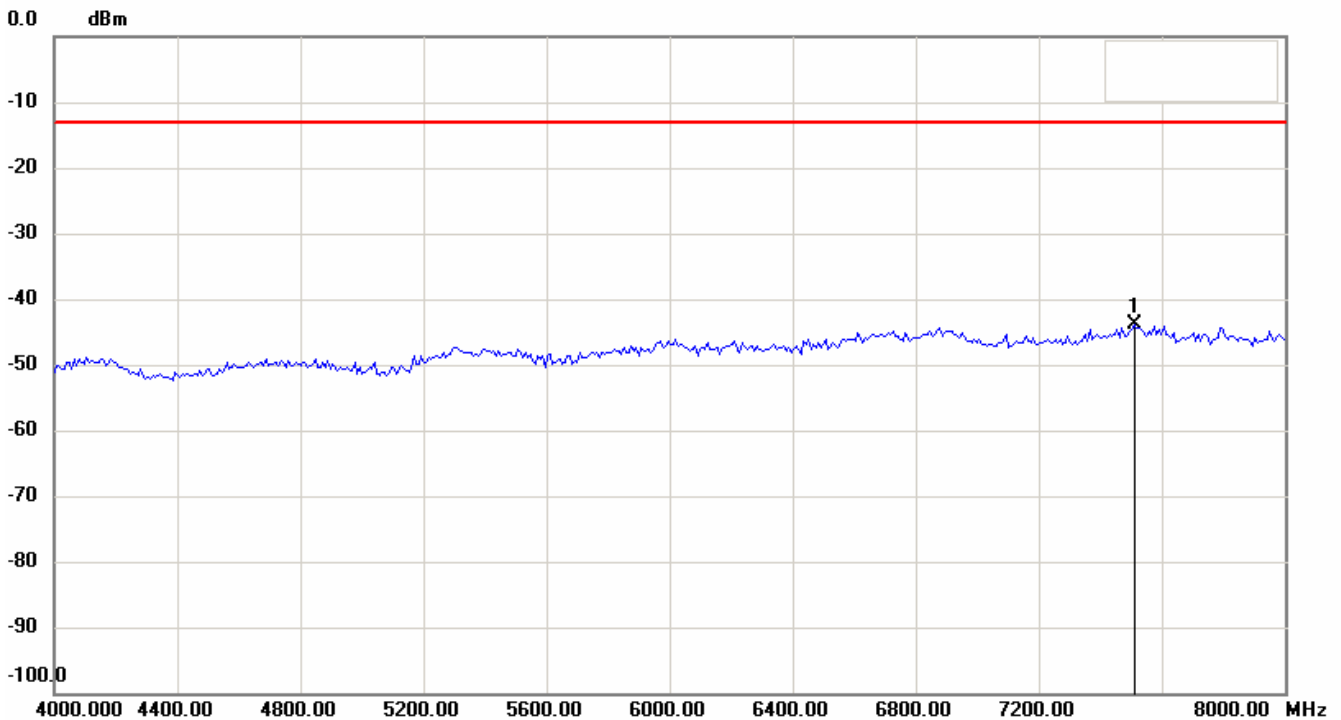
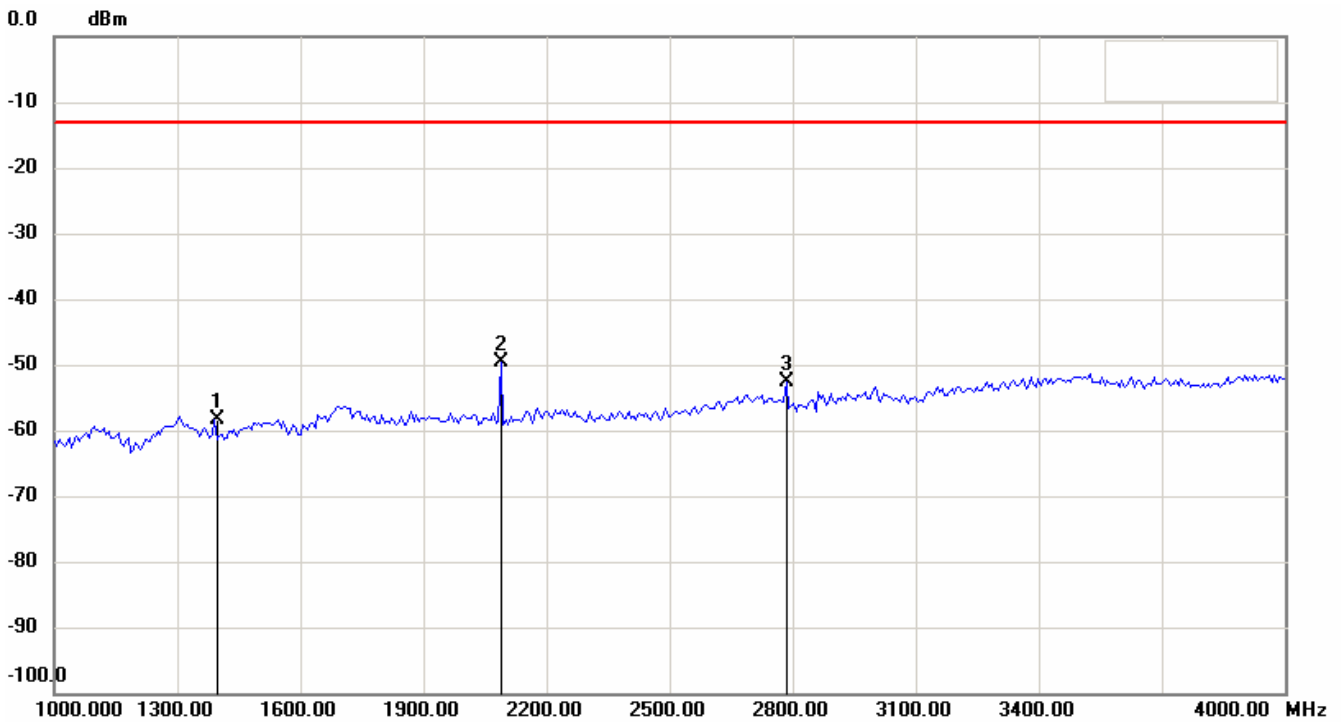

Note:

1. The attached measurement plots are preliminarily pre-scanned with peak detector for determining the final checking frequencies and are for reference only.
2. The some frequencies may exceed the limit line without the specified detectors, but that cannot present the results are failed to the specification of test standard.
3. For corrected test results are listed in the relevant table of radiated test data of this test report.

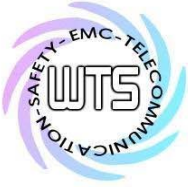

Worldwide Testing Services(Taiwan) Co., Ltd.

Registration number: W6M20902-9587-C-1

FCC ID: M5X-ACT7T

External Photos





Worldwide Testing Services(Taiwan) Co., Ltd.

Registration number: W6M20902-9587-C-1
FCC ID: M5X-ACT7T



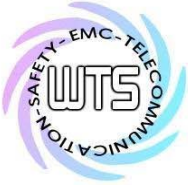

Worldwide Testing Services(Taiwan) Co., Ltd.

Registration number: W6M20902-9587-C-1

FCC ID: M5X-ACT7T



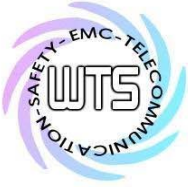

Worldwide Testing Services(Taiwan) Co., Ltd.

Registration number: W6M20902-9587-C-1
FCC ID: M5X-ACT7T



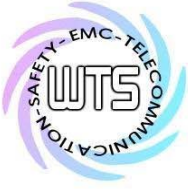

Worldwide Testing Services(Taiwan) Co., Ltd.

Registration number: W6M20902-9587-C-1
FCC ID: M5X-ACT7T





Worldwide Testing Services(Taiwan) Co., Ltd.

Registration number: W6M20902-9587-C-1

FCC ID: M5X-ACT7T

Internal Photos





Worldwide Testing Services(Taiwan) Co., Ltd.

Registration number: W6M20902-9587-C-1

FCC ID: M5X-ACT7T



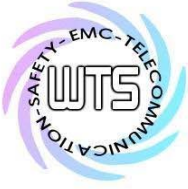

Worldwide Testing Services(Taiwan) Co., Ltd.

Registration number: W6M20902-9587-C-1

FCC ID: M5X-ACT7T

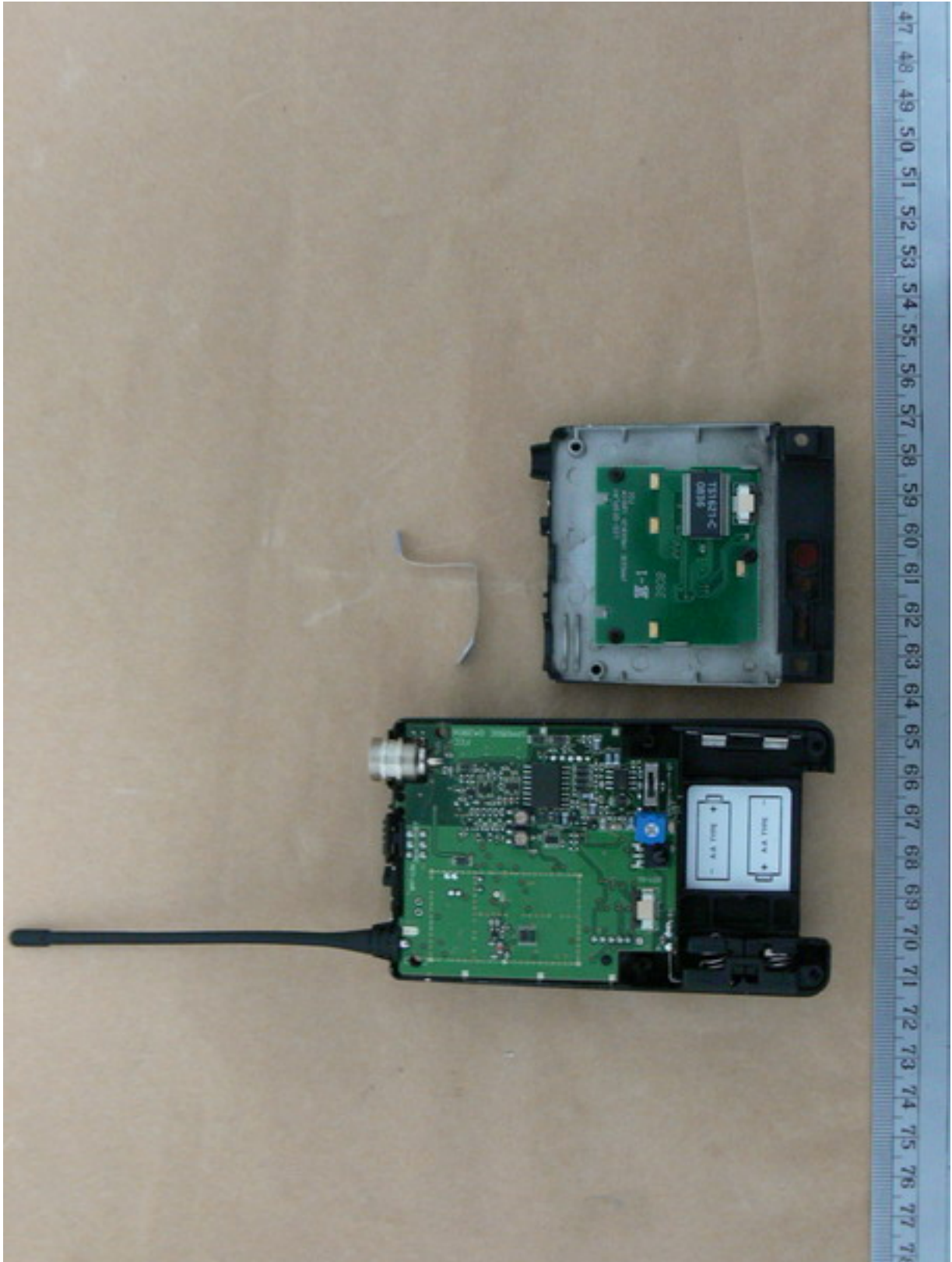

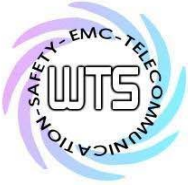

Worldwide Testing Services(Taiwan) Co., Ltd.

Registration number: W6M20902-9587-C-1

FCC ID: M5X-ACT7T



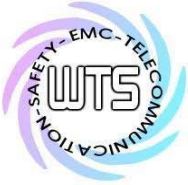

Worldwide Testing Services(Taiwan) Co., Ltd.

Registration number: W6M20902-9587-C-1
FCC ID: M5X-ACT7T

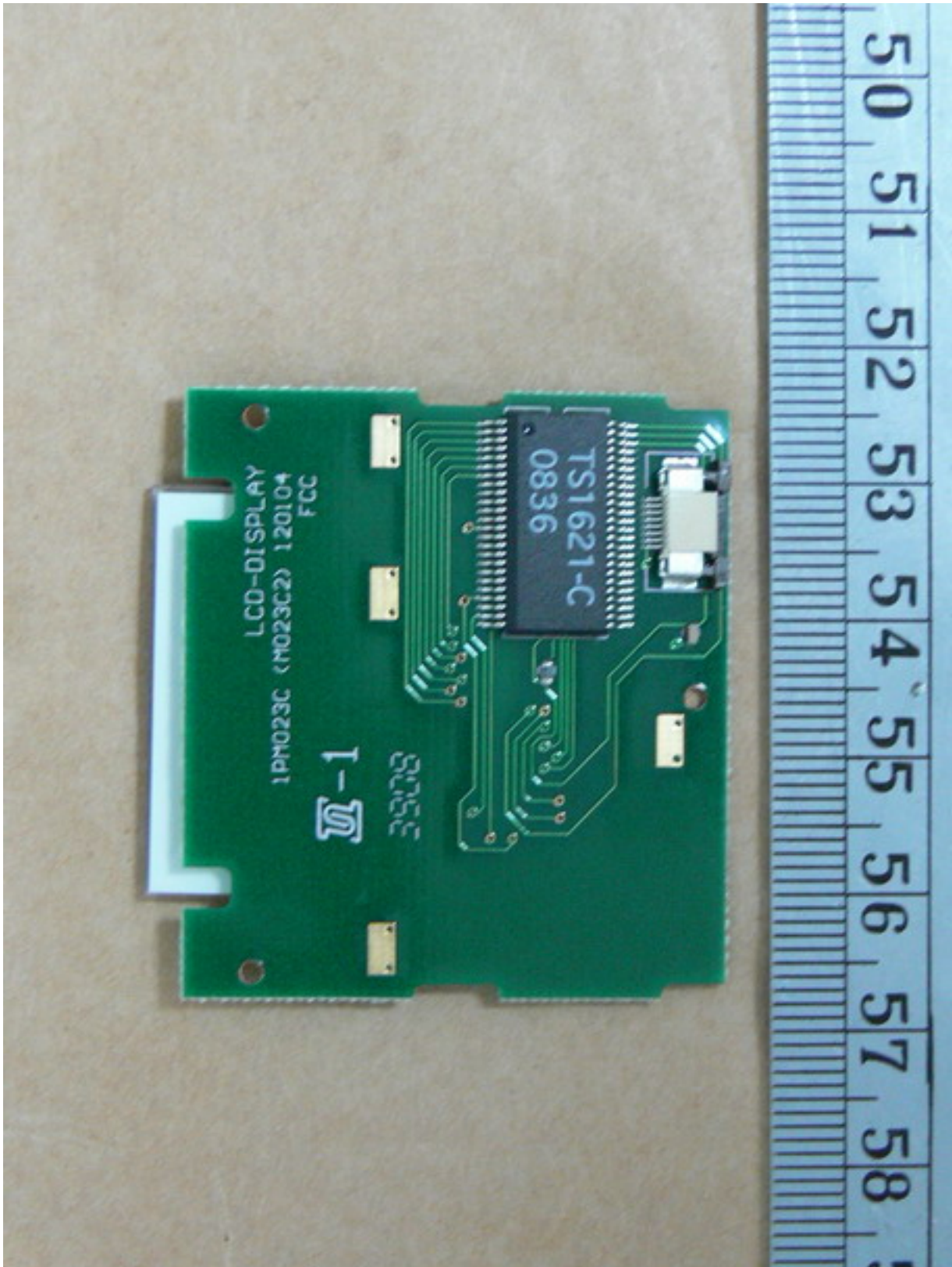

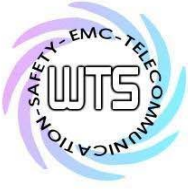

Worldwide Testing Services(Taiwan) Co., Ltd.

Registration number: W6M20902-9587-C-1
FCC ID: M5X-ACT7T

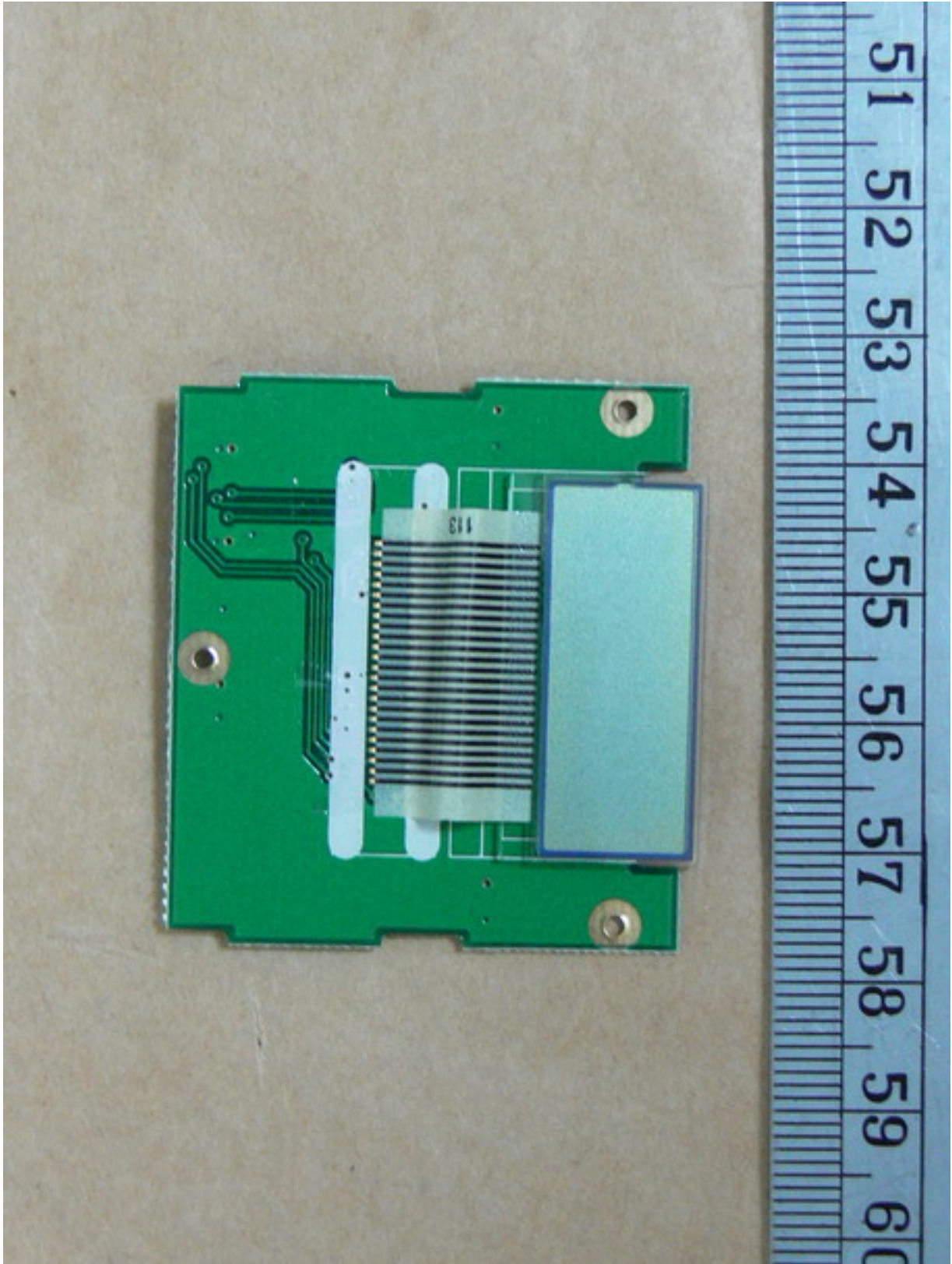

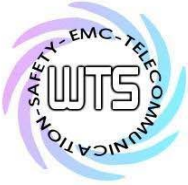

Worldwide Testing Services(Taiwan) Co., Ltd.

Registration number: W6M20902-9587-C-1

FCC ID: M5X-ACT7T



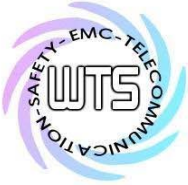

Worldwide Testing Services(Taiwan) Co., Ltd.

Registration number: W6M20902-9587-C-1

FCC ID: M5X-ACT7T

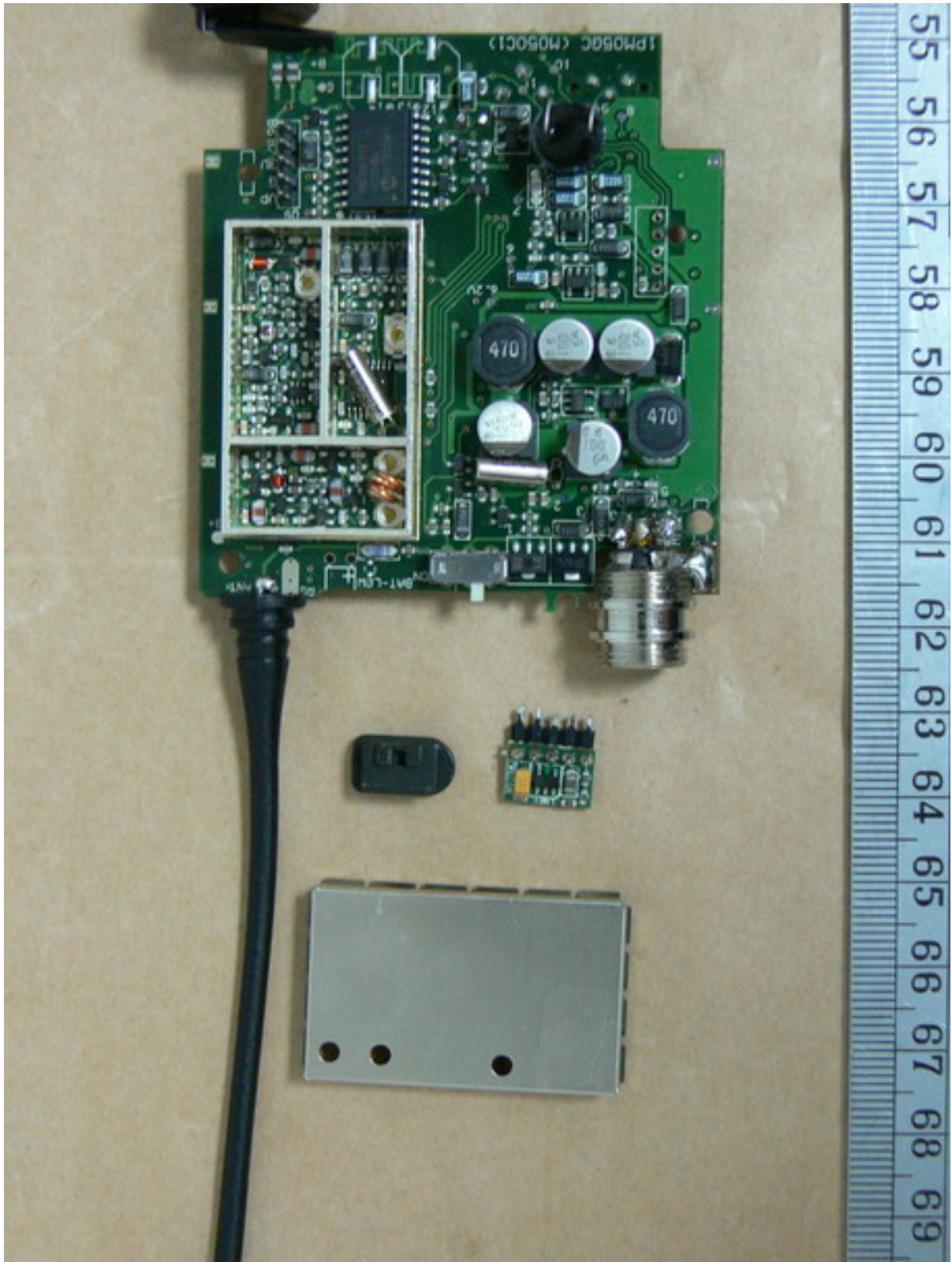



Worldwide Testing Services(Taiwan) Co., Ltd.

Registration number: W6M20902-9587-C-1

FCC ID: M5X-ACT7T

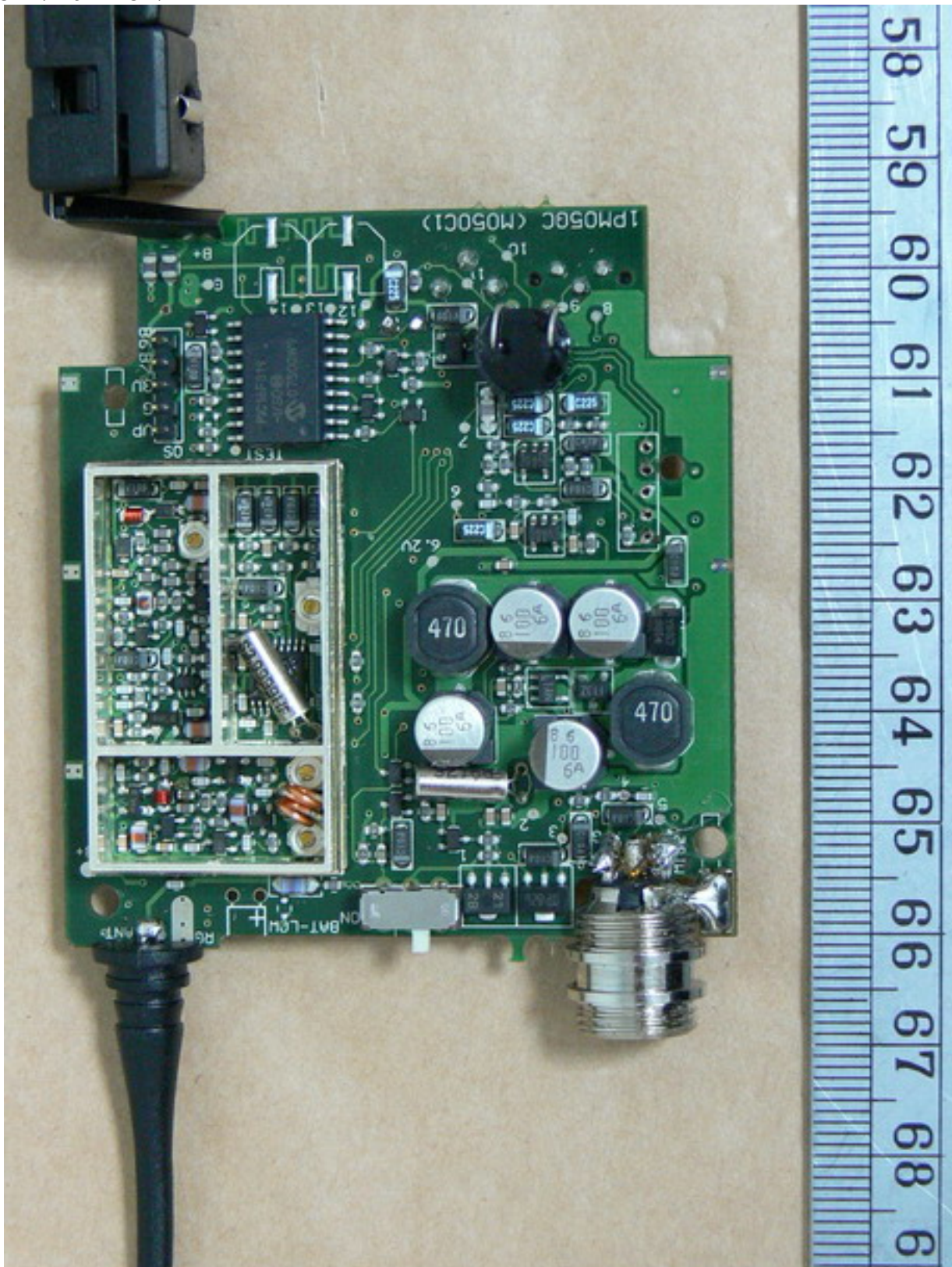



Worldwide Testing Services(Taiwan) Co., Ltd.

Registration number: W6M20902-9587-C-1

FCC ID: M5X-ACT7T

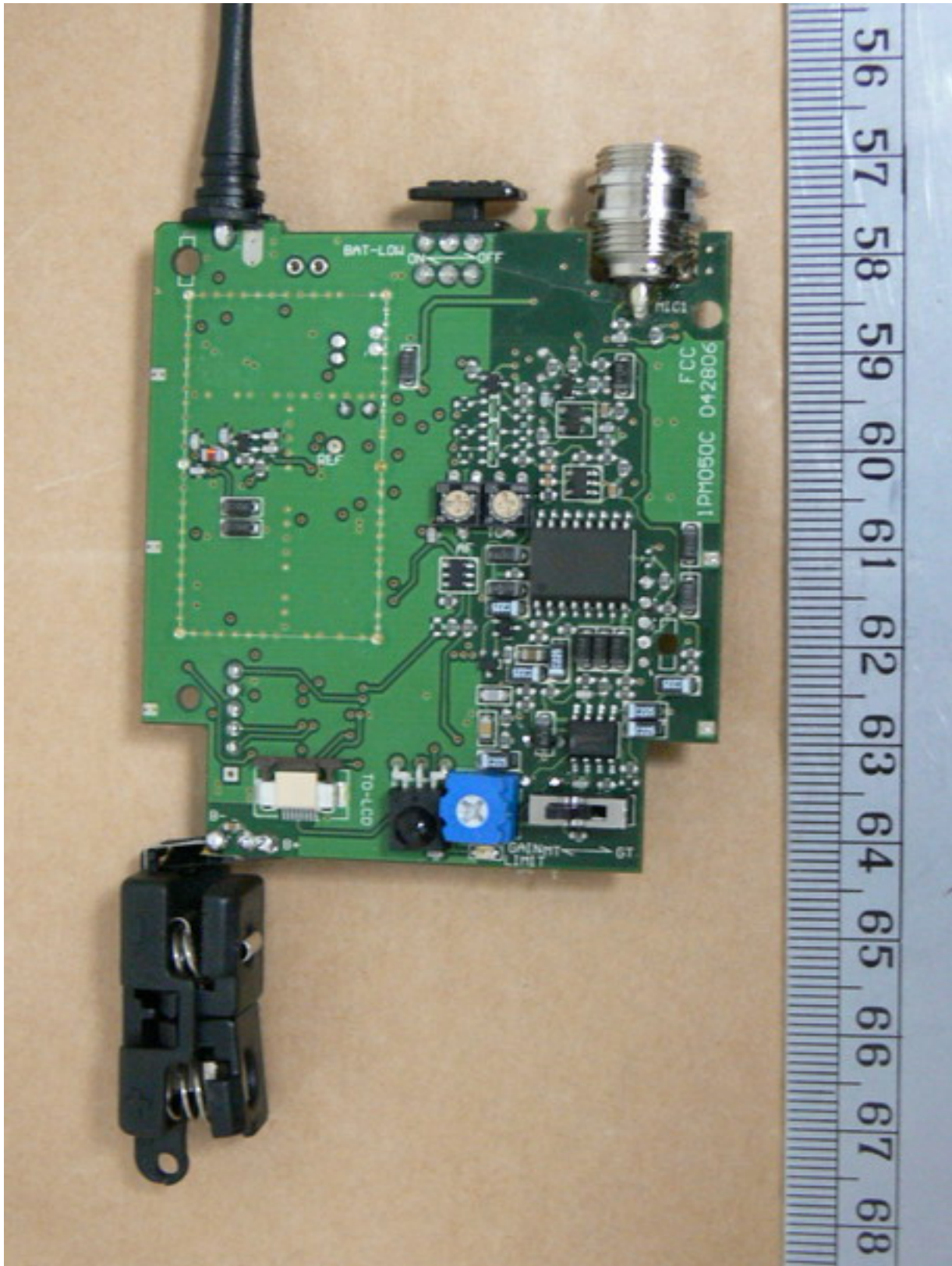

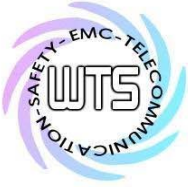

Worldwide Testing Services(Taiwan) Co., Ltd.

Registration number: W6M20902-9587-C-1
FCC ID: M5X-ACT7T

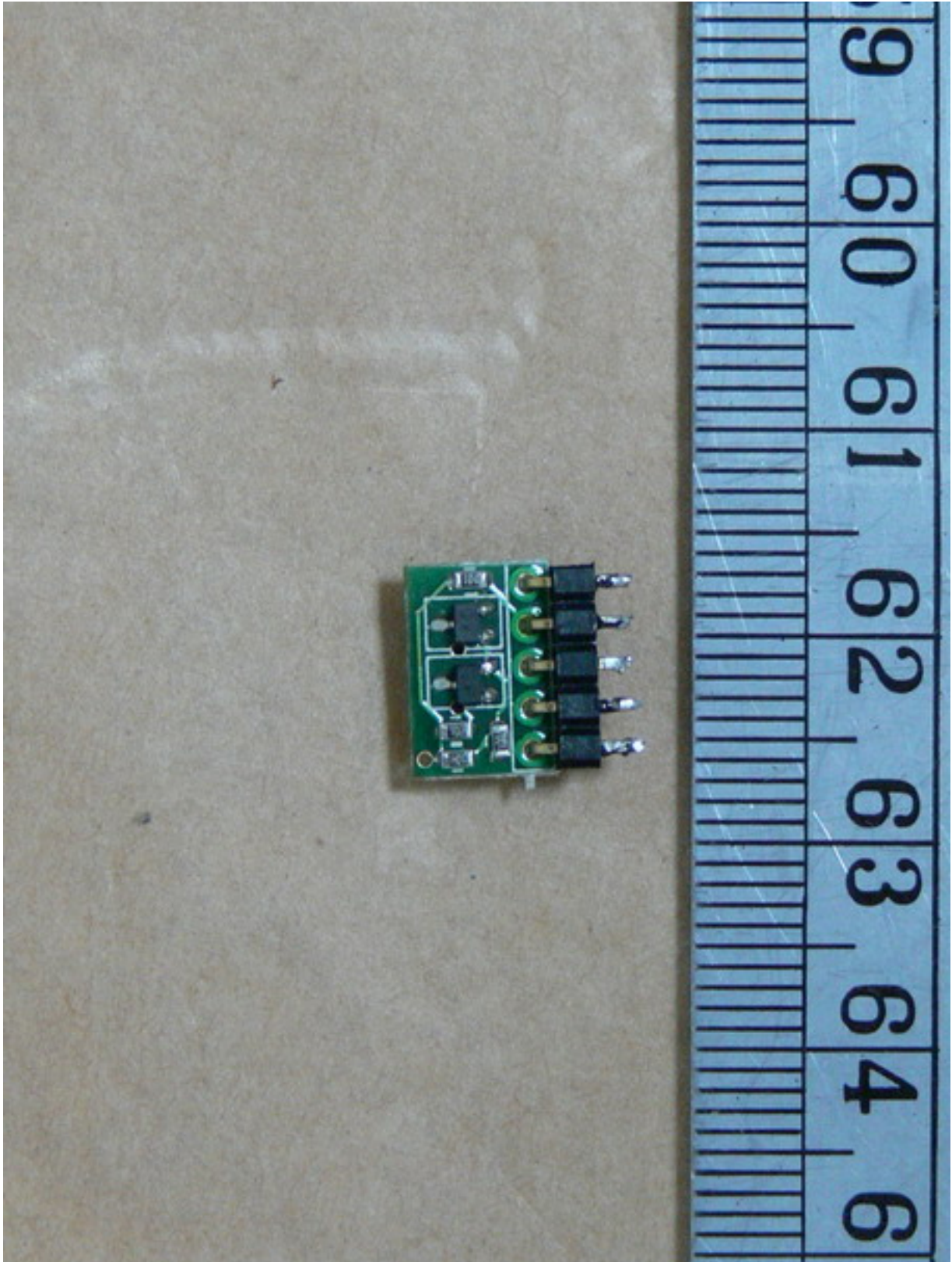

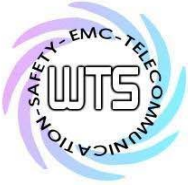

Worldwide Testing Services(Taiwan) Co., Ltd.

Registration number: W6M20902-9587-C-1
FCC ID: M5X-ACT7T

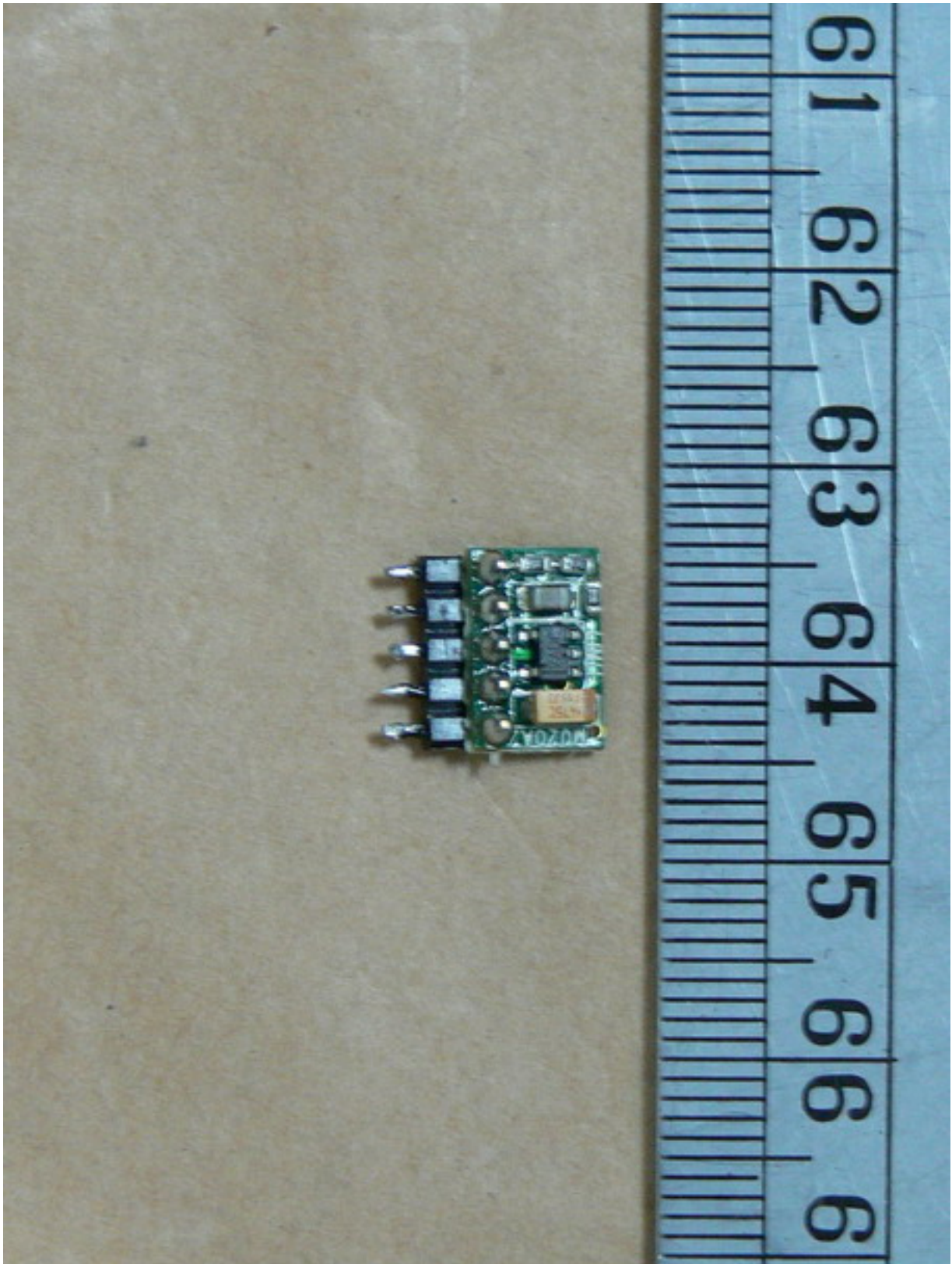

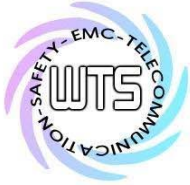

Registration number: W6M20902-9587-C-1

FCC ID: M5X-ACT7T

Set Up Photo of Radiated Emission

