

MIPRO[®]

ACT-70T

Wideband Bodypack Transmitter

User Guide

MIPRO MIPRO Electronics Co., Ltd.

Headquarters: 814 Pei-Kang Road, Chiayi, 60096, Taiwan.

Web: www.mipro.com.tw

E-mail: mipro@mipro.com.tw

FC CE



AS121015

Design and specifications are subject to change without prior notice



Contents

1	Features
3	Bodypack Controls and Indicators
6	Operating Instructions
7	LCD Display Screen
8	Transmitter Parameters
14	Battery Status
16	Setting MUTE
18	AF Input Connections
19	Battery Removal and Installation

Features

- Bandwidth to 72MHz for compatibility with the wideband receivers.
- Industry's smallest bodypack transmitter with sturdy magnesium alloy housing for 2AA batteries.
- Antenna, mute button and XLR input connector are located on the top of transmitter.
- Backlit LCD displays working band-code, group, channel, frequency, AF input gain, RF output power, mute, battery status, and error codes.
- Innovatively designed battery cover allows easy access to operate buttons and prevents accidental operation.
- Mute button and remote-control jack is equipped for easy activation of mute function.
- High efficiency, low power consumption, low spurious emission and high stability PLL synthesized circuit is applied.
- An interference-free working channel can be synchronized quickly and precisely by MIPRO's patented ACT™ function.
- High SPL input without distortion.
- Can be directly matched to high-low input impedance for microphone and guitar without switching and the input sensitivity is adjustable.
- Mini-XLR input connector for quick-lock or screw-lock with lavalier or headworn microphones and guitar.
- Adjustable belt clip allows wearing transmitter in any position.

Furnished Accessories:

- USER GUIDE x1

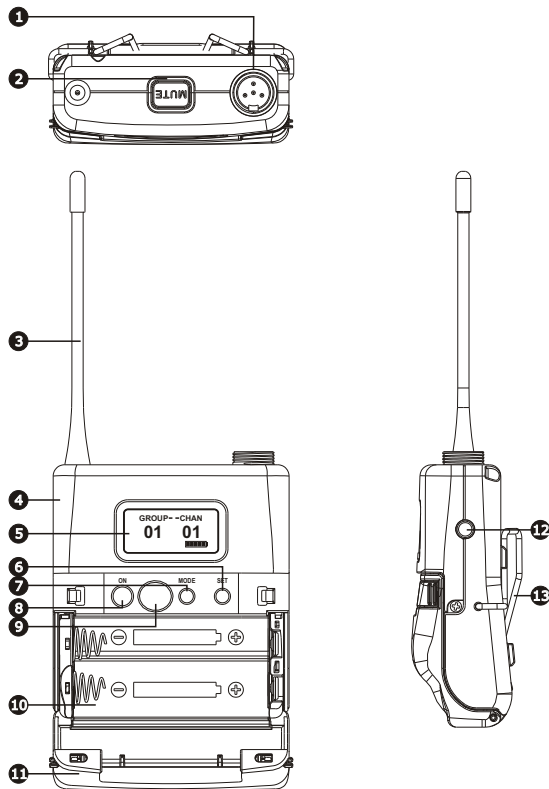
Bodypack Controls and Indicators

- 1 Audio Input Connector:** TA4F mini 4-pin connector accepts any MIPRO lavalier, instrument and headset microphones and cables. (See 5 ways of connection on AF Input Connections)

- ② **MUTE Button:** To mute and un-mute the audio signal temporary.
- ③ **Antenna:** Flexible 1/ 4 wave transmitting antenna.
- ④ **Transmitter Housing:** Holds PCB board and wires.
- ⑤ **LCD Panel:** Display transmitter parameters.
- ⑥ **SET Button:** Parameter selection button.
- ⑦ **MODE Button:** Allows access to 7 available functions displaying in LCD panel.
- ⑧ **Power Button:** Press and hold 2 seconds to power ON or OFF.
- ⑨ **ACT IR Port:** Align and syncs the transmitter and receiver frequency automatically.
- ⑩ **Battery Compartment:** Holds 2 'AA' batteries.
- ⑪ **Battery Cover:** Hinged cover opens to provide access to 2 'AA' batteries.
- ⑫ **External Mute Connector:** When an external mute switch cable, MJ-70 (optional) is connected, user can manually mute and un-mute the audio temporary.
- ⑬ **Belt Clip:** Detachable and reversible design allows the transmitter to be worn on a belt, waistband, or guitar strap (Figure 1).

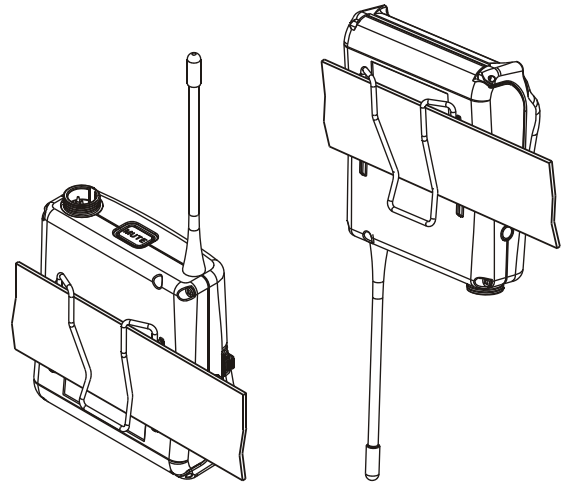

(Positive Wear)

(Opposite Wear)

(Figure 1)

Operating Instructions

- The audio gain level is factory preset at 0dB level.
- Guitar setting is recommended at -12dB level.
- Insert the lavalier, headset microphone or instrument cable into the audio input connector before power ON the transmitter.
- Tighten the connector screw clockwise direction as shown in (Figure 2) for a secured fit.

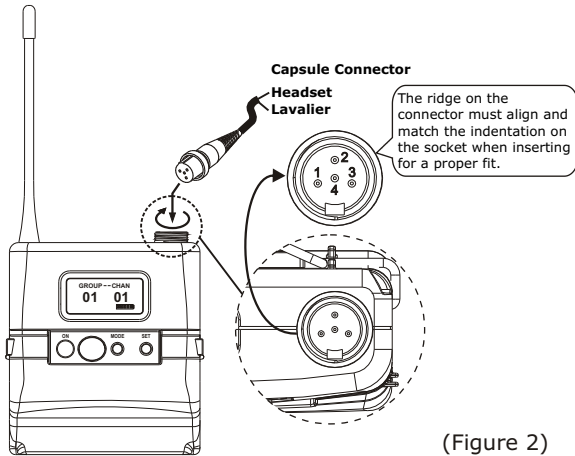

LCD Display Screen



- 14 LCD Screen
- 15 AF (audio) MUTE
- 16 Transmitter Battery Meter

Transmitter Parameters

- **MODE** button

Press "**MODE**" button to access one of the six parameters below.

- **SET** button

Press "**SET**" button then the changeable functions will twinkle. Change to the desired parameters during the above twinkle by pressing "**SET**" button.

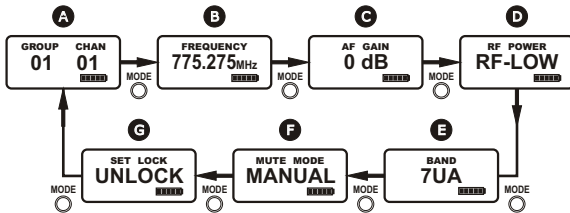
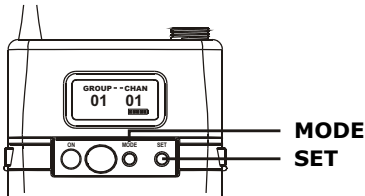

- Ⓐ Group and Channel
- Ⓑ Frequency
- Ⓒ Sensitivity Level
- Ⓓ RF Output Power
- Ⓔ Frequency Band
- Ⓕ MUTE Mode
- Ⓖ Parameters Lock & Unlock Status

- Frequency Band, Group & Channel and Frequency are factory pre-set, thus, its parameter values are displayed after it is ACT synced. Values cannot be changed.



(Frequency Band)



(Group and Channel)

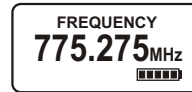

(Frequency)

Setting Input Gain Level

- Selectable **AF GAIN** between 12dB to -18dB with 6dB parameter up or down selection.
- Press **MODE** button until **AF GAIN** mode appears.
- Press **SET** button once to activate function.
- Press **SET** button to select the desired sensitivity level.
- Press **MODE** button to confirm and save the change.
- The higher the sensitivity level, the lower the dynamic range of input signals. Meanwhile noise will increase, and the feedback problem will be getting more serious.

NOTE: Guitar setting is recommended at -12dB level.

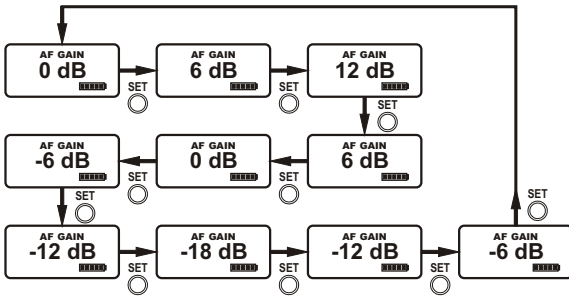

Setting RF Output Power

- 2 RF Output Power Levels: **RF-LOW** and **RF-HI**.
- Press **MODE** button until **RF POWER** mode appears.
- Press **SET** button once to activate function.
- Press **SET** button to select the desired RF output power.
- Press **MODE** button to confirm and save the change.

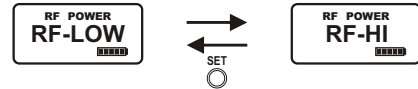

MUTE MODE

- **MUTE MODE:** Select from **MANUAL** and **DISABLE**.
- Press **MODE** button until **MUTE MODE** appears. Press **SET** button once, the LCD screen starts flashing to denote it is ready to accept mode changes. Press **SET** button to change between **MANUAL** and **DISABLE** in cycle. Press **MODE** button to confirm and save the change, or LCD will stop flashing after 5 seconds and parameter will be saved.
- **MUTE** button is operable when **MUTE MODE** is set in **MANUAL** mode.
- **MUTE** button is not operable when **MUTE MODE** is set in **DISABLE** mode.

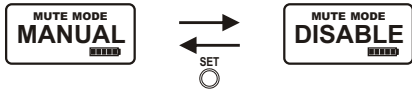

Setting LOCK

- Setting LOCK can be switched to **LOCK** or **UNLOCK** mode.
- Press **MODE** button until **SET LOCK** mode appears.
- Press **SET** button to select the desired parameter.
- Press **MODE** button to confirm and save the change.
- Press **SET** button twice to remove the LOCK function.
- The LOCK function will be removed automatically when losing power.
- Mute function can still work properly when LOCK.

NOTE: Once locked, all 7 parameter values cannot be changed.

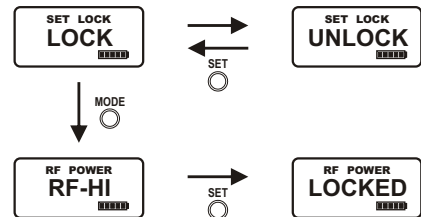

Battery Status

- Indicates the power remaining in the transmitter battery. When the battery has less than 10% power remaining it must be replaced or recharged. If an under voltage condition continues, the LCD will show "OFF..." and the system will shut down to prevent being overly discharged.

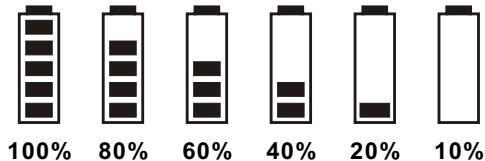

Power Button

- Press and hold for 2 seconds to power on & off. "OFF..." - Power Off
- When the power switch is turned off, the LCD will show "OFF..." (for Power Off) first and then the system will shut down and no further messages will be displayed.

OFF...

ERR Message

- When "ERR" appears in the display it indicates that an operational error has occurred. Please refer to the following codes to diagnose which error you are experiencing.
 - ERR no01** EEPROM is not being programmed or internal data error.
 - ERR no02** For testing only.
 - ERR no03** The frequency you want to program is above the switching bandwidth of the transmitter. Use a receiver with an appropriate frequency group. (At this time the microphone is still operating and the frequency remains unchanged. To clear the displayed "ERR" message, switch the handheld transmitter off and on again.)
 - ERR no04** The frequency you want to program is below the switching bandwidth of the transmitter. Use a receiver with an appropriate frequency group. (At this time the microphone is still operating and the frequency remains unchanged. To clear the displayed "ERR" message, switch the handheld transmitter off and on again.)
- "Group" & "Channel"** : When both the group and channel numbers are displayed, it means that you are using the pre-programmed frequency of the receiver.
- "Channel" Only** : If "Channel" only is displayed, it means that you are using a frequency which is not pre-programmed.

Setting MUTE

- Press **MUTE** button to enter **MUTE** mode.
- Under **MUTE** mode, press **MUTE** button to exit **MUTE** mode.
- **MUTE** button is operable when **SET LOCK** mode is **LOCK**.
- **MUTE** button is not operable when **MUTE MODE** is set in **DISABLE** mode.

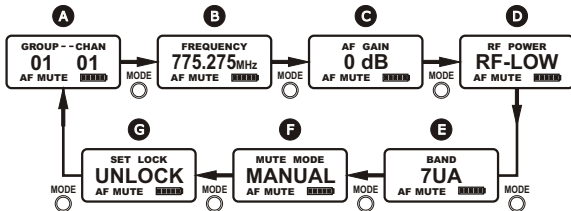
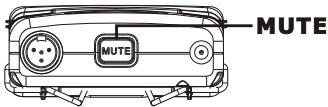

External Mute Connector

- External mute connector is a 3.5mm jack. When an external mute switch cable, MJ-70 (optional) is connected, user can manually mute and un-mute the audio temporary.

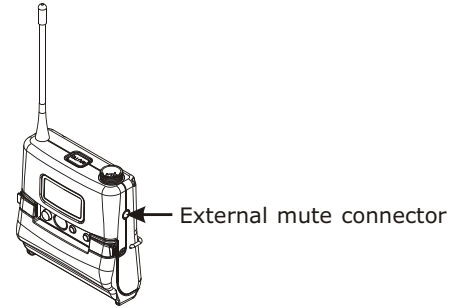

MJ-70 External Mute Switch (optional)

- ① 3.5mm jack.
- ② External mute switch on/off button.

NOTE: Plug in the device before power on the bodypack transmitter.

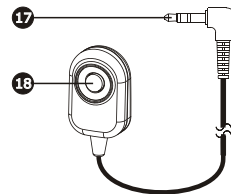

AF Input Connections

- (1) 2-Wire Electret condenser microphone Capsule

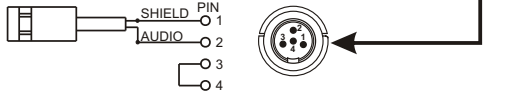

- (2) 3-Wire Electret condenser microphone Capsule

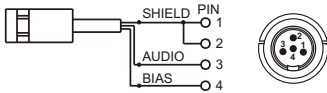

- (3) Dynamic Microphone

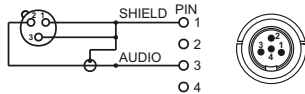

- (4) Electric Guitar

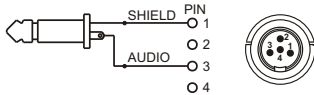

- (5) Line-in (Impedance 8K Ω ATT. 10dB)

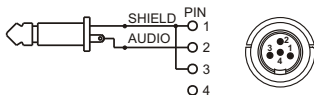

Battery Removal and Installation

- Pushing down both snap locks on the sides to open battery compartment cover. Take out the two batteries. (Figure 3)
- Insert two fresh AA batteries (alkaline type is recommended) into the battery compartment according to the correct polarity (- and +) as shown in (Figure 4). Then close the battery compartment cover tightly.

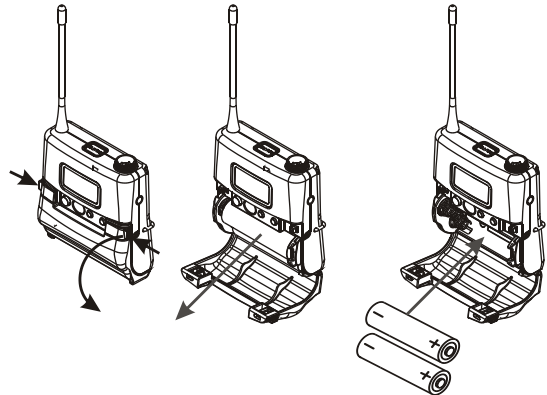

(Figure 3)

(Figure 4)

Caution:

Remove the batteries if unused for a long period of time to prevent battery leakage, corrosion and causes possible damage to electronics.

Disassemble the Belt Clip

- Turn the bodypack transmitter to the back side like the right diagram.



- Pull open one side of the belt clip and make it depart from the slot of the bodypack transmitter like the right diagram.

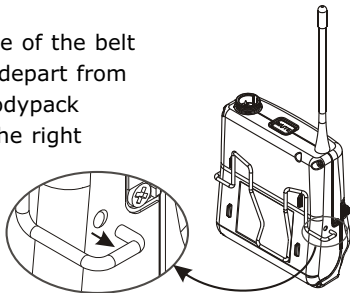

- Then the other side of the belt clip can be departed from the other slot easily. The whole belt clip is departed from the bodypack transmitter completely like the right diagram.

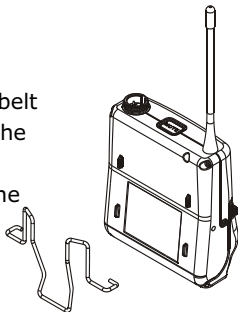

Assemble the Belt Clip

- Turn the bodypack transmitter to the back side. Put the belt clip to the right direction and aim the one side of the belt clip to the slot of the bodypack transmitter like the right diagram.

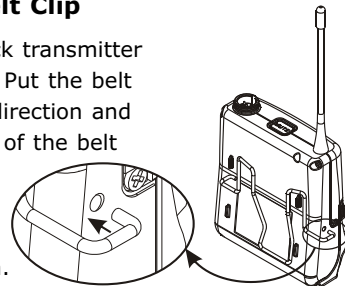

- For opposite wear of bodypack transmitter, just rotate the belt clip by 180°C like the right diagram.

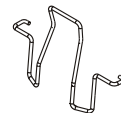

- Put one side of the belt clip to the slot of bodypack transmitter and fix it like the right diagram.



- Pull open the other side of the belt clip and put it to the other slot of bodypack transmitter and fix it like the right diagram.



FC & IC - ID**FCC**

This device complies with Part 15 of the FCC Rules. Operation is subject to the following two conditions: (1) This device may not cause harmful interference, and (2) This device must accept any interference received, including interference that may cause undesired operation.

Disposal Dispose of any unusable devices or batteries responsibly and in accordance with any applicable regulations.



Disposing of used batteries with domestic waste is to be avoided!

Batteries / NiCad cells often contain heavy metals such as cadmium(Cd), mercury(Hg) and lead(Pb) that makes them unsuitable for disposal with domestic waste. You may return spent batteries/ accumulators free of charge to recycling centres or anywhere else batteries/accumulators are sold.

By doing so, you contribute to the conservation of our environment!

This device complied with FCC radiation exposure limits as set forth for an uncontrolled environment. This device should be installed and operated so that its antenna(s) are not co-located or operating in conjunction with any other antenna or transmitter

FCC Caution: To assure continued compliance, any changes or modifications not expressly approved by the party responsible for compliance could void the user's authority to operate this equipment. (Example - use only shielded interface cables when connecting to computer or peripheral devices).

IC

This device complies with Industry Canada's RSSs. Operation is subject to the following two conditions: (1) This device may not cause interference; and (2) This device must accept any interference, including interference that may cause undesired operation of the device.

Le présent appareil est conforme aux CNR d'Industrie Canada applicables aux appareils radio. L'exploitation est autorisée aux deux conditions suivantes :

- (1) l'appareil ne doit pas produire de brouillage;
- (2) l'utilisateur de l'appareil doit accepter tout brouillage radioélectrique subi, même si le brouillage est susceptible d'en compromettre le fonctionnement.