

MIPRO®

ACT-70T / 52T / 32T / 24T / 58T

Bodypack Transmitters (Two AA Disposable Batteries)

ACT-70TC / 52TC / 32TC / 24TC / 58TC

Bodypack Transmitters (Rechargeable Lithium Battery)

User Guide



ACT-70T

ACT-52T

ACT-32T

ACT-24T

ACT-58T



ACT-70TC

ACT-52TC
ACT-32TC

ACT-24TC

ACT-58TC

I. Parts Name, Fig. 1

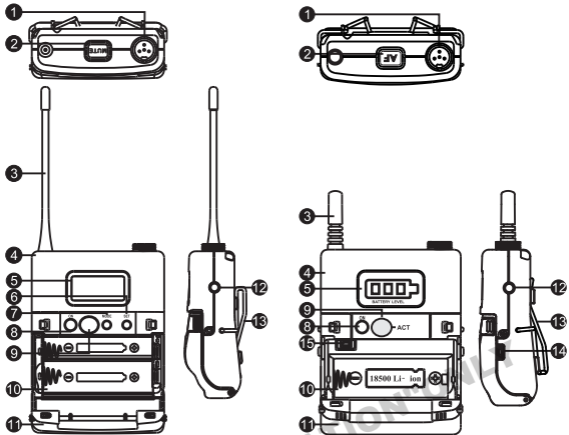

Fig. 1: AA Battery (left); Rechargeable Battery (right)

- ① 4-Pin Microphone Input Jack.
- ② Mute button.
- ③ Transmitting Antenna.
- ④ Housing.
- ⑤ LCD Panel.
- ⑥ SET button.
- ⑦ MODE button.
- ⑧ Power Switch.
- ⑨ ACT Sync Window.

- ⑩ Battery Compartment.
- ⑪ Battery Cover.
- ⑫ Remote control mute connector.
- ⑬ Reversible Belt Clip, Fig. 2.
- ⑭ Battery Charging Contact. (Rechargeable)
- ⑮ Battery protection circuit reset button. (ACT-70TC/52TC/32TC Rechargeable)

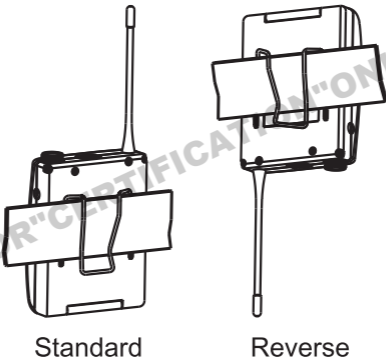

Fig.2

II. 4-Pin Microphone Input Jack Connection

1. Before turning on the power, connect the input signal source to the microphone input jacket ❶ first to avoid open-circuit induced noise, Fig. 3.
2. Align and fasten the connector clockwise for a secured fit.

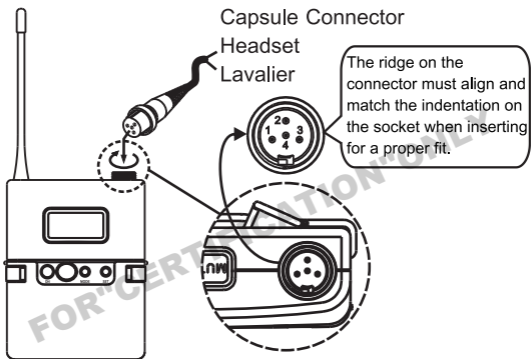

Fig. 3

III. LCD Display, Fig. 4



Fig. 4

- ❶ Transmitter Functions.
- ❷ Transmitter Parameters.
- ❸ Transmitter Battery Display.

IV. Operating Instructions

1. Press MODE button **7** to move the cursor and access the following parameters in Fig. 5.
2. Press SET button **6** to activate parameters for changing. Press SET button during blinking to change a parameter value, Fig. 5.

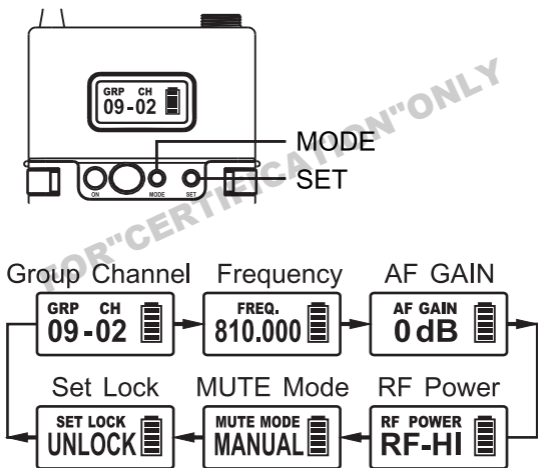

Fig. 5

3. Group (GRP)/Channel (CH)/Frequency (FREQ.) are synced from receiver and cannot be changed, Fig. 6.

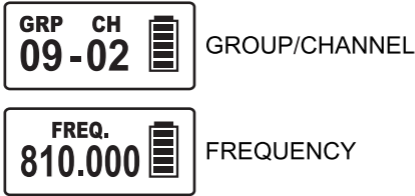

Fig. 6

4. AF Gain Setting, Fig. 7:

- (A) AF Gain can be changed from 12dB ~ -12dB, in 6dB steps.
- (B) Press MODE button to access AF GAIN parameter. Press SET button to change. To save, press MODE button or until flashing stops.
- (C) The higher the AF gain is, the lower the input signal of dynamic range will be and it will increase noise and feedback chances.
- (D) Set AF Gain to -12dB for guitar.
- (E) 0dB is the factory default setting.

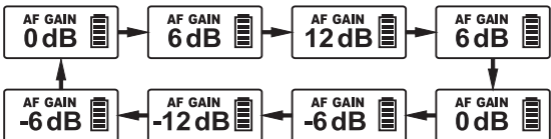

Fig. 7

5. RF Power Setting, Fig. 8:

- (A) RF Power can be changed to RF-HI or RF-LOW.
- (B) Press MODE button to access RF POWER parameter. Press SET button, the parameters start flashing. Press SET button again, the parameter will change circularly. Press MODE button to save or the parameter saves automatically when flashing stops.



Fig. 8

6. MUTE MODE Setting, Fig. 9:

- (A) MUTE MODE can be changed to MANUAL or DISABLE.
- (B) Press MODE button to access MUTE MODE parameter. Press SET button, the parameters start flashing. Press SET button again, the parameter will change circularly. Press MODE button to save or the parameter saves automatically when flashing stops.
- (C) MANUAL mode indicates MUTE button can be muted.
- (D) DISABLE mode indicates MUTE button cannot be muted.

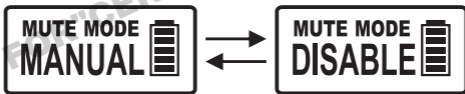

Fig. 9

7. Lock Setting, Fig. 10:

- (A) LOCK can be changed to LOCK or UNLOCK.
- (B) Press MODE button to access LOCK parameter. Press SET button, the parameters start flashing. Press SET button again, the parameter will change circularly. Press MODE button to save or the parameter saves automatically when flashing stops.
- (C) LOCKED mode indicates power button cannot work and mute function is normal.
- (D) Repeat same procedures to change back to UNLOCK mode. UNLOCK mode indicates power is operational.

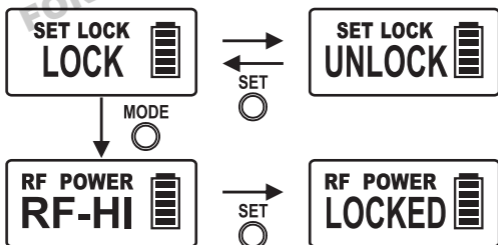

Fig. 10

V. Battery Level Status

1. Replace with a charged battery once level falls to 10%. Device will power off automatically with an OFF message once power level falls too low, See Fig. 11.

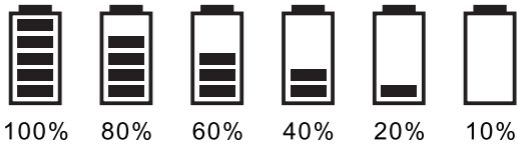

Fig. 11

2. ACT-24T/24TC/58T/58TC:

Battery level indicators. Recommend charging or replace a fully-charged battery when single red indicator remains. Power shutdown automatically when battery voltage is too low, Fig. 12.

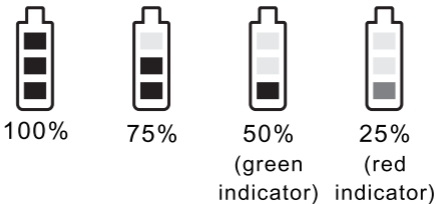

Fig. 12

VI. Power On/Off

1. Press and hold power button for two seconds to power on or power off the device. LCD is lit when power is turned on.
2. The LCD screen display OFF... during powering off, See Fig. 13.



Fig. 13

FOR "CERTIFICATION" ONLY

3. Error codes:
 - (A) ERR no01→Channel wasn't programmed or internal data error.
 - (B) ERR no02→Testing only.
 - (C) ERR no03→The set frequency exceeds the upper band. The microphone frequency will not be changed but it can be operated as long as the power switch is turned on again.
 - (D) ERR no04→The set frequency exceeds the lower band. The microphone frequency will not be changed but it can be operated as long as the power switch is turned on again.
4. GROUP CHANNEL are internal programmed channels.
5. CHANNEL displays only (GROUP is not shown) indicates a user-defined frequency synced from receiver and it only can be changed via PC.

VII. MUTE setting

1. Press MUTE button to enter MUTE mode, Fig. 14.
2. Press MODE, SET buttons to access parameters. Returns to mute mode when button is not pressed for 5 seconds, Fig 15.
3. Press MUTE button to disable MUTE mode.
4. UNMUTE displays for 1 second and then returns to main screen.
5. MUTE button acts only under MANUAL setting.

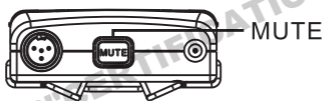

Fig. 14

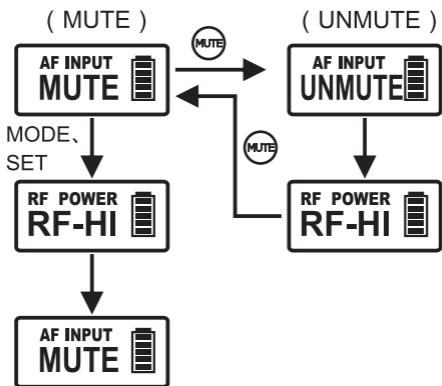

Fig. 15

6. External Mute Switch connector, Fig. 16:

External Mute Switch has a 3.5 Ø connector. Once MJ-70 is inserted it acts as an external mute switch.

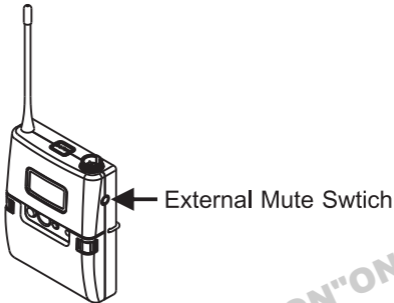

Fig. 16

7. External Mute Switch cable (optional),
Fig. 17:

- ① External Mute Switch plug.
- ② External Mute button switch.

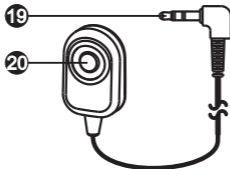

Fig. 17

Caution: Plug MJ-70 into the remote control mute connector ⑫ before turning on the power.

VIII. 4-Pin Microphone Input Jack Wiring,

Fig. 18



Fig. 18

1. 2-wire electret condenser microphone capsule connection, Fig. 19:

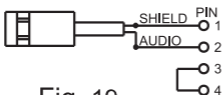

Fig. 19



2. 3-wire electret condenser microphone capsule connection, Fig. 20:

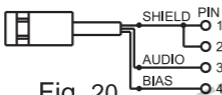

Fig. 20



3. Dynamic Microphone, Fig. 21:

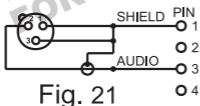

Fig. 21



4. Electric Guitar, Fig. 22:

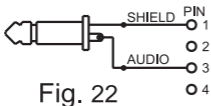

Fig. 22



5. Line-input (impedance 8K ATT 10dB), Fig. 23:

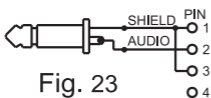

Fig. 23



IX. AA Battery Insertion and Replacement

1. Press the side hooks to open battery compartment. Remove the battery carefully, Fig. 24.
2. Insert two AA sized batteries according to correct polarity, Fig. 25.
3. Power off to conserve battery power. Remove the battery when it will not be used for extended periods of time.

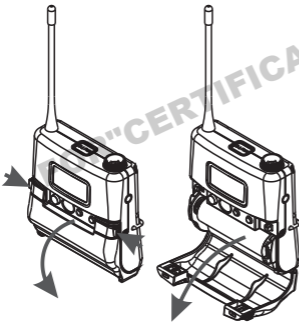

Fig. 24

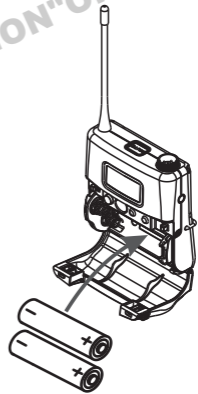

Fig. 25

X. Rechargeable Battery Insertion and Replacement

1. Press the side hooks to open battery compartment. Remove the battery carefully, Fig. 26.
2. Insert one 18500 type lithium battery according to correct polarity, Fig. 27.

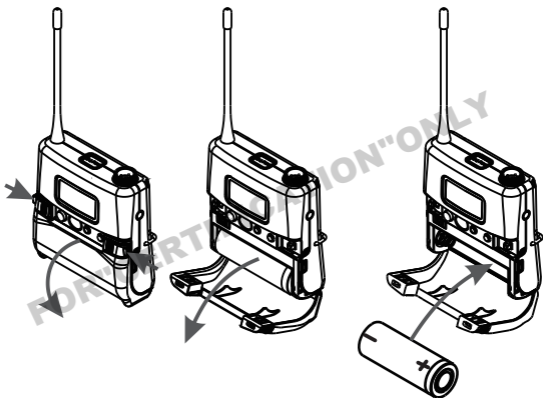

Fig. 26

Fig. 27

3. Check battery polarity was inserted correctly if battery power is sufficient but unable to turn on the transmitter. Battery protection circuit is activated if correct battery polarity. Below methods are available to bypass the battery circuit protection:

- (A) Insert the transmitter into the single or dual-docking battery charger for at least 10 seconds. Power on the transmitter.
- (B) Insert battery with incorrect polarity first. Remove and re-insert again with correct polarity.
- (C) ACT-70TC/52TC/32TC:
Open battery compartment, press the battery protection circuit button as shown in Fig. 28. Power on the transmitter.

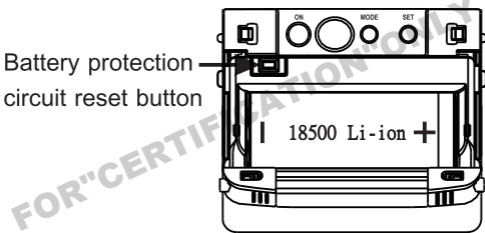

Fig. 28

- (D) Power off to conserve battery power. Remove the battery when it will not be used for extended periods of time.
- (E) We recommend transmitter to be recharged directly in the docking battery charger.

XI. Transmitter Battery Chargers (optional)

1. Transmitter(s) can be inserted into single-docking or dual-docking battery chargers (Fig. 29 & 30) or 18500 rechargeable battery can be recharged in dual-docking battery charger (Fig. 31).
2. MP-8 single-docking battery charger, Fig. 29.
3. MP-80 dual-docking battery charger, Fig. 30.

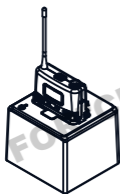

Fig. 29:
Bodypack transmitter
recharged in MP-8

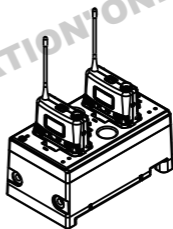

Fig. 30:
Bodypack transmitters
recharged in MP-80

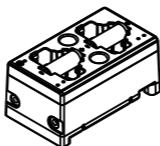

Fig. 31: 18500 rechargeable
battery recharged in MP-80

XII. Notes

1. Refer to actual product in the event of product description discrepancy.
2. Frequency range and maximum deviation comply with the regulations of different countries.

FOR "CERTIFICATION" ONLY

FCC

FCC Caution: To assure continued compliance, any changes or modifications not expressly approved by the party responsible for compliance could void the user's authority to operate this equipment. (Example - use only shielded interface cables when connecting to computer or peripheral devices).

This device complies with Part 15 of the FCC Rules. Operation is subject to the following two conditions:

- (1) This device may not cause harmful interference, and
- (2) This device must accept any interference received, including interference that may cause undesired operation.

This device complied with FCC radiation exposure limits as set forth for an uncontrolled environment. This device should be installed and operated so that its antenna(s) are not co-located or operating in conjunction with any other antenna or transmitter.

IC

This device complies with Industry Canada's RSSs. Operation is subject to the following two conditions:

- (1) This device may not cause interference; and
- (2) This device must accept any interference, including interference that may cause undesired operation of the device.

Le présent appareil est conforme aux CNR d'Industrie Canada applicables aux appareils radio. L'exploitation est autorisée aux deux conditions suivantes :

- (1) l'appareil ne doit pas produire de brouillage;
- (2) l'utilisateur de l'appareil doit accepter tout brouillage radioélectrique subi, même si le brouillage est susceptible d'en compromettre le fonctionnement.

Federal Communication Commission Interference Statement

This equipment has been tested and found to comply with the limits for a Class B digital device, pursuant to Part 15 of the FCC Rules. These limits are designed to provide reasonable protection against harmful interference in a residential installation.

This equipment generates, uses and can radiate radio frequency energy and, if not installed and used in accordance with the instructions, may cause harmful interference to radio communications. However, there is no guarantee that interference will not occur in a particular installation. If this equipment does cause harmful interference to radio or television reception, which can be determined by turning the equipment off and on, the user is encouraged to try to correct the interference by one of the following measures:

- . Reorient or relocate the receiving antenna.
- . Increase the separation between the equipment and receiver.
- . Connect the equipment into an outlet on a circuit different from that to which the receiver is connected.
- . Consult the dealer or an experienced radio/TV technician for help.

FCC Caution: To assure continued compliance, any changes or modifications not expressly approved by the party responsible for compliance could void the user's authority to operate this equipment. (Example - use only shielded interface cables when connecting to computer or peripheral devices).

FCC Radiation Exposure Statement

This equipment complies with FCC RF radiation exposure limits set forth for an uncontrolled environment.

This transmitter must not be co-located or operating in conjunction with any other antenna or transmitter.

This device complies with Part 15 of the FCC Rules. Operation is subject to the following two conditions:

- (1) This device may not cause harmful interference, and
- (2) This device must accept any interference received, including interference that may cause undesired operation.

FOR "CERTIFICATION" ONLY

Industry Canada Statement

This device complies with Industry Canada licence-exempt RSS standard.

Operation is subject to the following two conditions:

- (1) this device may not cause interference, and
- (2) this device must accept any interference, including interference that may cause undesired operation of the device.

Le présent appareil est conforme aux CNR d'Industrie Canada applicables aux appareils radio exempts de licence. L'exploitation est autorisée aux deux conditions suivantes : (1) l'appareil ne doit pas produire de brouillage, et (2) l'utilisateur de l'appareil doit accepter tout brouillage radioélectrique subi, même si le brouillage est susceptible d'en compromettre le fonctionnement.

IC Radiation Exposure Statement:

This equipment complies with IC RSS-102 radiation exposure limit set forth for an uncontrolled environment.

Cet équipement est conforme aux CNR-102 d'Industrie Canada.

FOR "CERTIFICATION" ONLY

FOR "CERTIFICATION" ONLY

MIPRO[®]
MICROPHONE PROFESSIONALS

MIPRO Electronics Co., Ltd

Headquarters: No. 814, Beigang Rd., Chiayi City 60096, Taiwan

Tel : +886.5.238.0809

Fax : +886.5.238.0803

www.mipro.com.tw

mipro@mipro.com.tw

All rights reserved. MN 019/09

Do not copy or forward without prior approvals MIPRO.

Specifications and design subject to change without notice.



CE FC



2CE612C