

MIPRO[®]

ACT-800T UHF Digital

ACT-700T/ACT-500T/ACT-300T UHF Analog

ACT-240T/2.4GHz, ACT-580T/5.8GHz Digital

Bodypack Transmitters

User Guide



I. Part Names

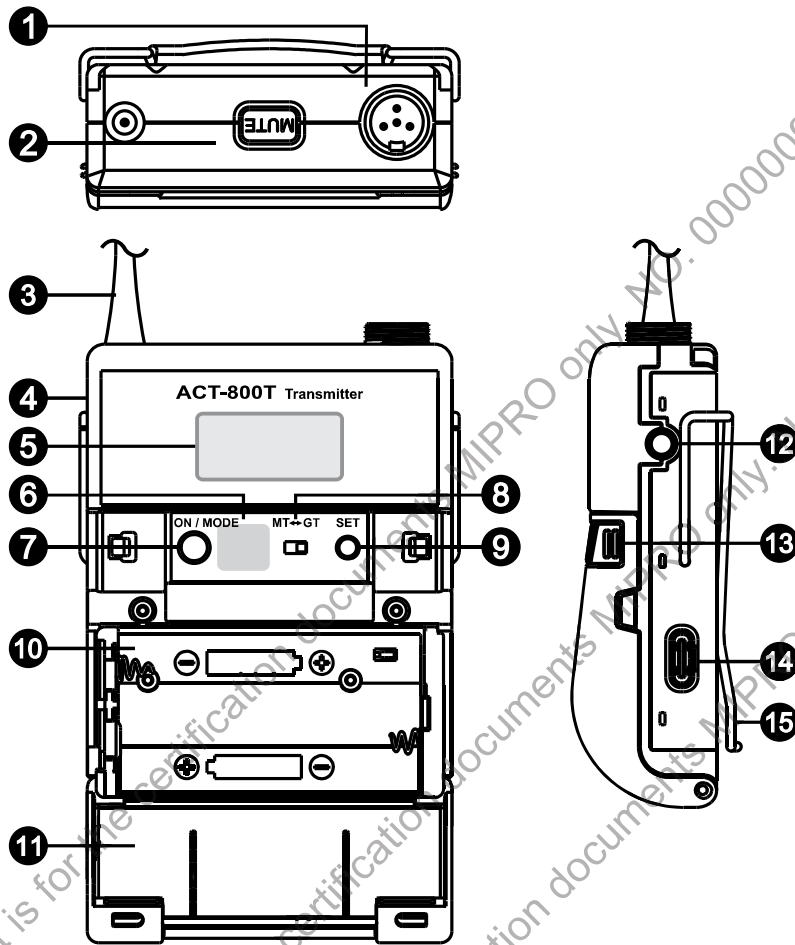

- ❶ 4-Pin Microphone Input Jack
- ❷ Mute Button
- ❸ Transmitting Antenna
- ❹ Housing
- ❺ LCD Panel
- ❻ ACT Sync Window
- ❼ Power / MODE button
- ❽ MT / GT Switch
- ❾ SET Button
- ❿ Battery Holder
- ⓫ Battery Cover

1

All rights reserved. Do not copy or forward without prior approvals MIPRO.
Specifications and design subject to change without notice. YM 021/05

- 12 Remote Control Mute Connector
- 13 Battery Cover Hooks
- 14 USB Type-C Charging Port
- 15 Belt Clip. Fig. 2

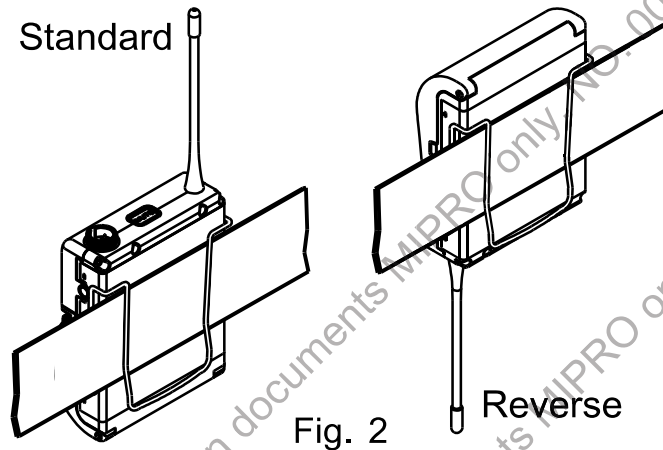

Fig. 2

II. 4-Pin Microphone Input Jack Connection

1. Before power on, connect the input signal source to the microphone input jack ❶ first to avoid open-circuit induced noise.
2. Align and fasten the connector clockwise for a secured fit. Fig. 3

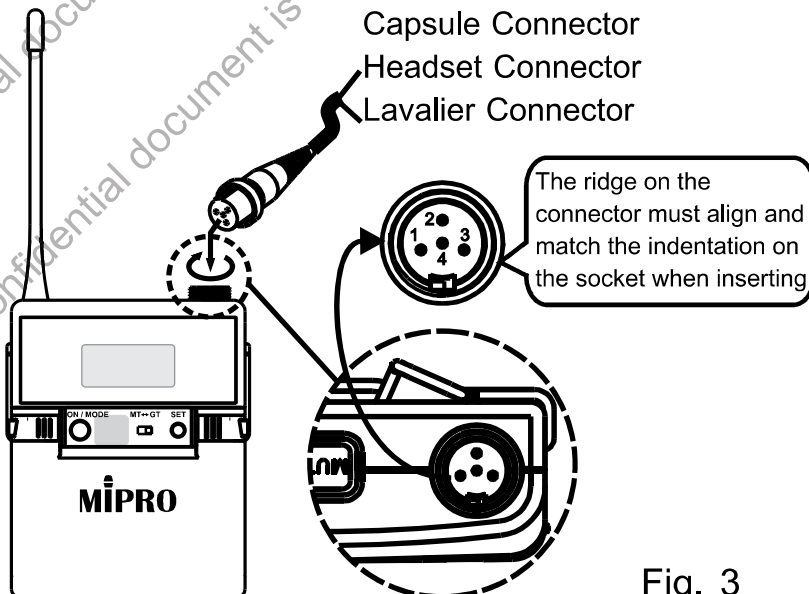
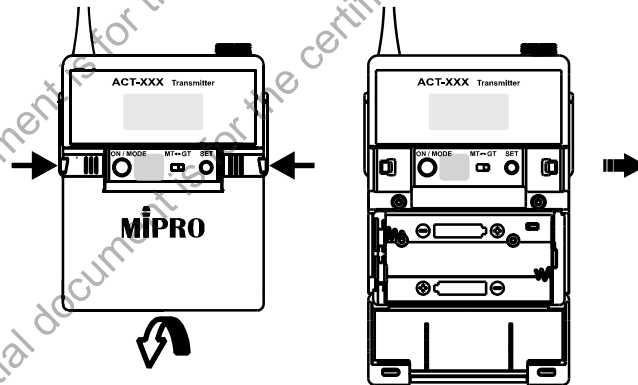

Fig. 3

III. Battery Insertion and Replacement

1. Battery Insertion. Fig. 4

- (A) Press the battery cover side hooks **13** inward to lift the battery cover.
 - (B) Insert one 18500 lithium battery or two AA batteries.
 - (C) 18500 lithium battery insertion: + pole faces toward left.
 - (D) AA batteries insertion: insert one into the lower holder with + pole toward left, and then insert another into the upper holder with – pole toward left.
2. Check battery polarity was inserted correctly if battery power is sufficient but unable to turn on the transmitter.
3. Power off to conserve battery power. Remove the battery when it will not be used for extended period of time.



Bodypack Transmitters

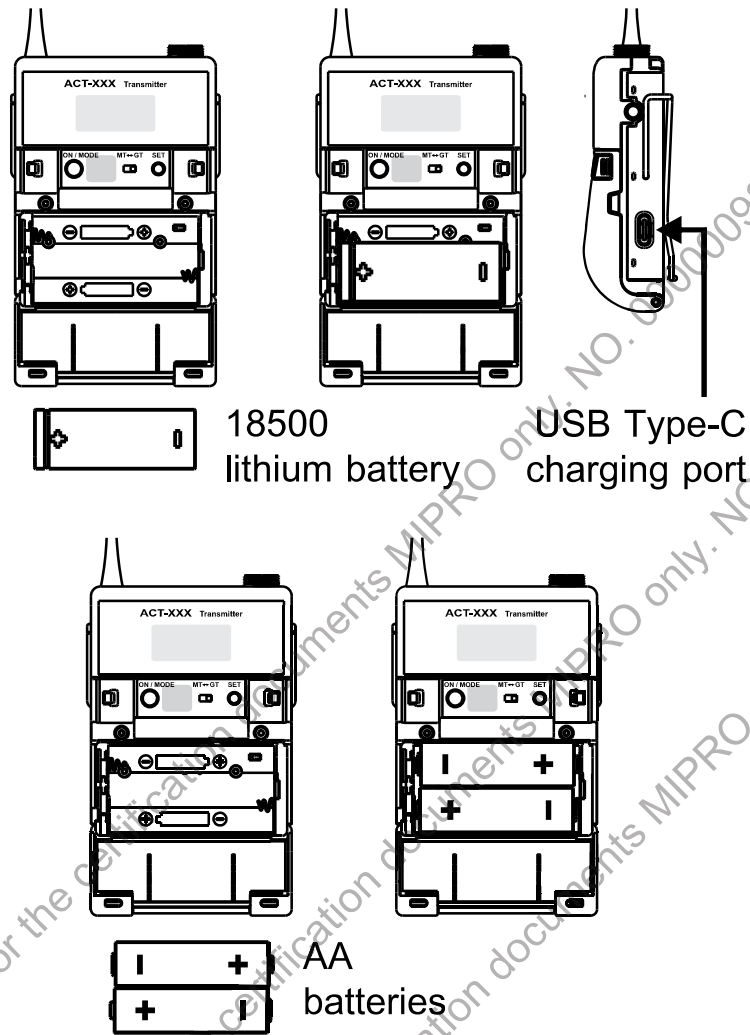

Fig. 4

4. This device can charge only one ICR-18500 lithium battery via USB Type-C. Cautions during charging:

- (A) Before charging, make sure the inside battery is an ICR-18500 lithium battery.
- (B) Confirm the battery polarity is inserted correctly.
- (C) Turn off the power first and then charge.
- (D) Do not charge AA batteries or NiMH batteries. Any damage caused by incorrect batteries is excluded from the warranty.
- (E) The charging port doesn't supply the power for the device.

(F) Do not remove the lithium battery during charging status. Detach the charging cable before removing the lithium battery.

(G)  Indicator: Amber (charging); Green (full)

(H) Check the 18500 lithium battery is inserted correctly if the indicator doesn't glow.

IV. Operating Instructions

1. Power On/Off:

(A) Press and hold Power button for 2 seconds to turn on; press and hold Power button for 5 seconds to turn off. The LCD panel glows when power on. Fig. 5, 6

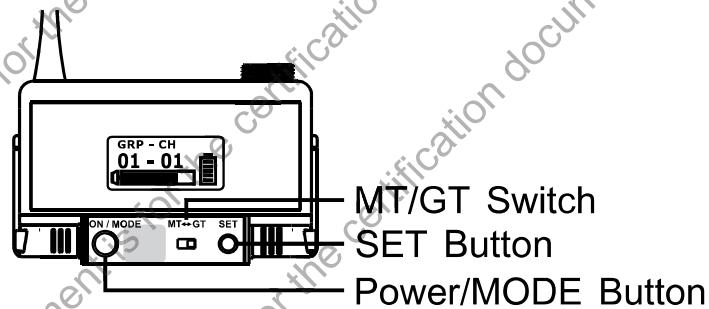

Fig. 5

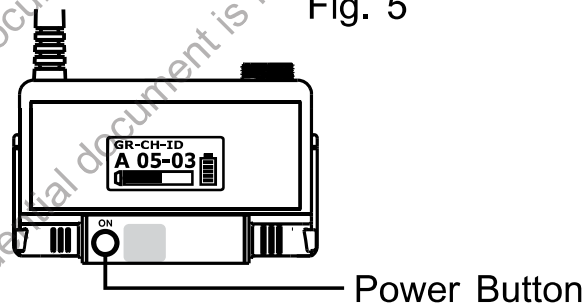

Fig. 6

(B) The LCD shows OFF... during turn off. Fig. 7



Fig. 7

2. Press MODE button to select functions.
3. Press SET button, the parameter blinks, press SET button again to change the parameter. Fig. 5
4. MT/GT Switch. Fig. 5
 - (A) MT: low input impedance. It is recommended for microphone connection.
 - (B) GT: high input impedance. It is recommended for guitar connection.
5. Battery Level Status:
 Replace with a charged battery once the level falls to 10%. The device will power off automatically with an OFF message once the power level falls too low. Fig. 8

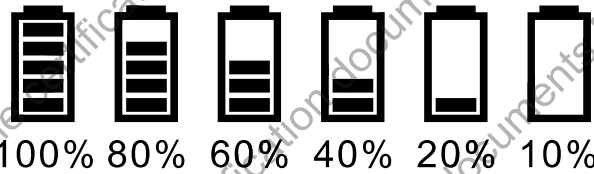

Fig. 8

V. LCD and Operating Instructions

1. LCD Display. Fig. 9:

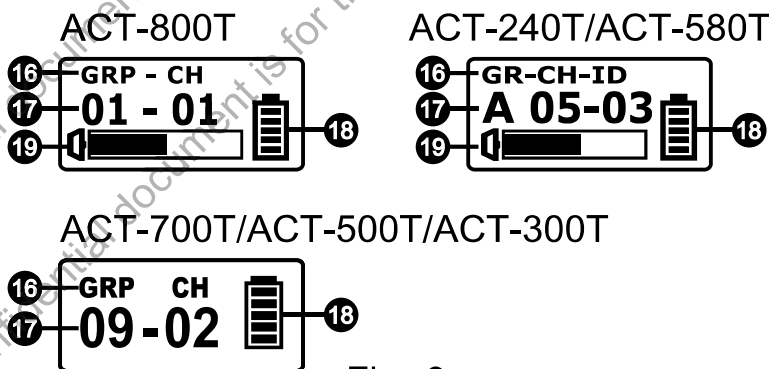

Fig. 9

- 16 Functions
- 17 Parameters
- 18 Battery Status
- 19 Audio Signal Level Bar

2. ACT-800T LCD. Fig. 10

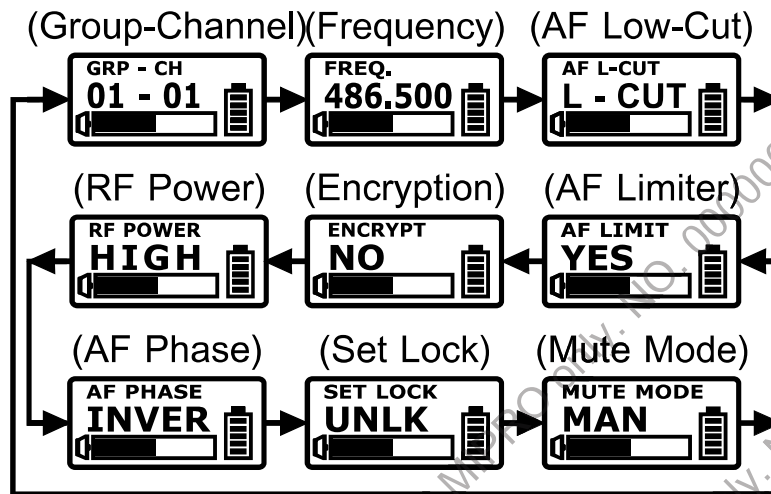

Fig. 10

(A) Group (GRP) / Channel (CH) / Frequency (FREQ.). Fig. 11

- (1) Group / Channel / Frequency is synced from the receiver and cannot be changed.
- (2) To change Group / Channel / Frequency, do it at the receiver and then press ACT button to sync.

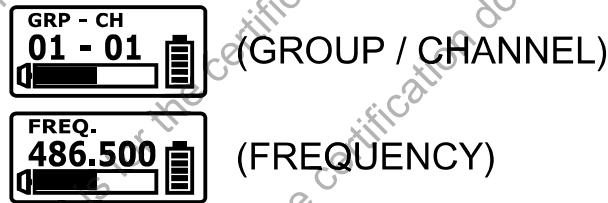

Fig. 11

- (3) The specific group and channel set via PC will display * * - * *. Fig. 12

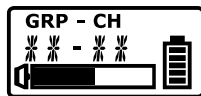

Fig. 12

(B) AF L-CUT: AF Low-Cut Setting. Fig. 13

- (1) Select L-CUT or FLAT.
- (2) L-CUT: the frequency response at 100Hz will decrease about 3dB with a slope of -6dB/Octave.

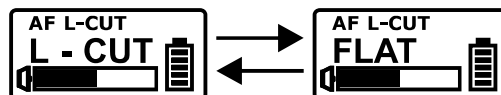

Fig. 13

(C) AF LIMIT: Audio Input Limit Setting.

Fig. 14

- (1) Select YES or NO.
- (2) YES: the maximum output of the receiver is limited to 1V.

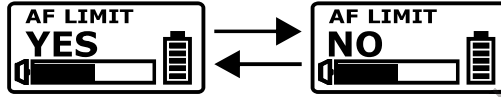

Fig. 14

(D) ENCRYPTION: Display Encryption Information. Fig. 15

The ENCRYPTION function must be set at receiver first then using ACT to program the transmitter. (Refer to ENCRYPTION function of the receiver)



Fig. 15

(E) RF POWER: RF Power Setting. Fig. 16

- (1) Select HIGH or LOW.
- (2) HIGH has 50mW transmitting power. LOW has 10mW transmitting power. Set appropriate power to meet region/country regulations.

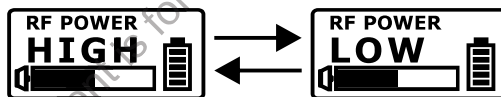

Fig. 16

(F) AF PHASE: Phase Setting of AF inputs.

Fig. 17

- (1) Select NORM or INVER. NORM is positive polarity; INVER is reverse polarity.
- (2) AF PHASE function provides users a phase selection for different condenser microphones. The normal setting is NORM, and INVER might be selected if a two-wire condenser microphone is used.

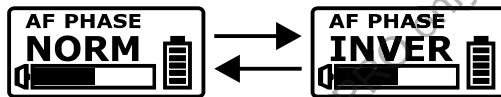

Fig. 17

(G) SET LOCK: Parameter Lock Setting.

Fig. 18

- (1) Select UNLK or LOCK.
- (2) During LOCK mode, settings cannot be changed including power on / off. To power off, it must be under unlock mode (UNLK). A sudden loss of power will disable LOCK.
- (3) MUTE function can be operated normally under LOCK mode.

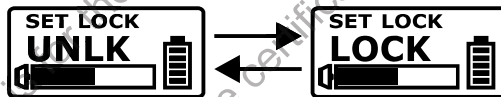

Fig. 18

(H) MUTE MODE: Mute Setting. Fig. 19

- (1) Select MAN, DIS or HOLD.

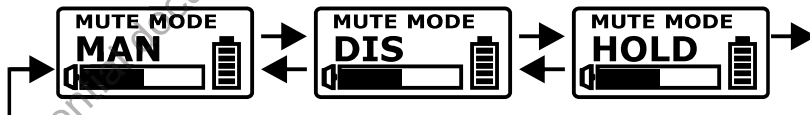

Fig. 19

- (2) MAN: the mute function is controlled by MUTE button. Fig. 20
 - (a) Press MUTE button to mute the transmitter, and the Audio Signal Level Bar 19 shows AF MUTE and blinks. Press again to unmute and the blink stops.

(b) AF MUTE will be disabled automatically when power off.

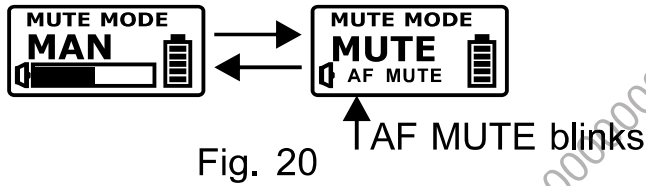

Fig. 20

- (3) DIS: Disable the mute function.
- (4) HOLD: Fig. 21
 - (a) Under HOLD mode, press Mute button to mute, release to unmute.
 - (b) Under HOLD mode, use ON/OFF of Remote Mute Switch to mute/unmute.

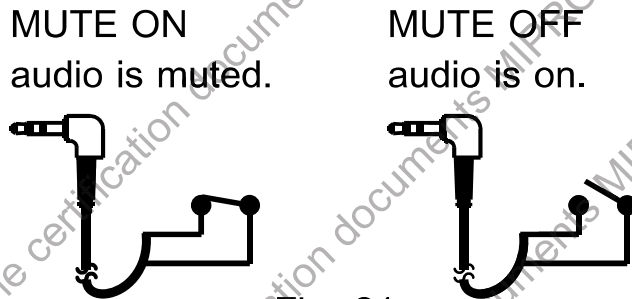

Fig. 21

(I) Error codes:

- (1) ROM-ER → Channel wasn't programmed or internal data error.
- (2) ERROR1 → RF frequency targeting circuitry is failed.
- (3) NO---03 → the set frequency exceeds the upper band. The transmitter frequency will not be changed but it can be operated as long as the power switch is turned on again.
- (4) NO---04 → The set frequency exceeds the lower band. The transmitter frequency will not be changed but it can be operated as long as the power switch is turned on again.

(J) MUTE Button. Fig. 22

- (1) Press MUTE button to enter MUTE status, the Audio Signal Level Bar shows AF MUTE and blinks, and all operations and the ACT function are still workable.
- (2) Press MUTE button again to unmute. AF MUTE will be disabled automatically when power off.
- (3) MUTE button is only workable under MAN (Manual Setting) mode.

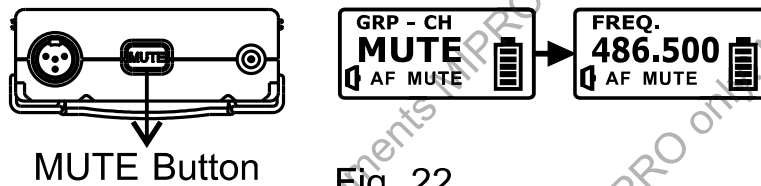

3. ACT-240T / ACT-580T LCD:

(A) GR (Group) – CH (Channel) – ID (ID Code). Fig. 23:

- (1) Group / Channel / ID Code messages are displayed only and cannot be changed.
- (2) To change Group / Channel / ID Code, do it at the receiver and then press ACT button to sync.

(Group-Channel-ID Code)

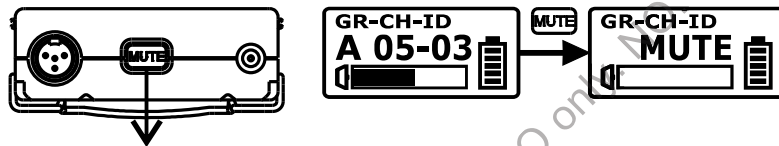

Fig. 23

- (3) ACT-240T: GROUP A, CH 1~12, ID 1~64.
ACT-580T: GROUP A, B1, B2, CH 1~12, ID 1~64, and  pairing mode.

(B) MUTE Button. Fig. 24:

- (1) Press MUTE button to enter mute status. LCD shows MUTE, and the ACT function still can be activated.
- (2) Press again to unmute. The Mute setting will be canceled automatically when power off.



MUTE Button Fig. 24

- (3) Lock: Power off. Press and hold the MUTE button, and power on to disable the MUTE button. LCD shows DISABLE. Fig. 25
- (4) Disable Lock: Power off. Press and hold the MUTE button, and power on to enable the MUTE button. LCD shows ENABLE. Fig. 26

Lock the MUTE button:

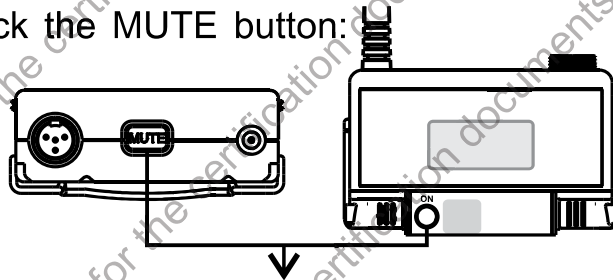

Press and hold the MUTE button, and power on



Fig. 25

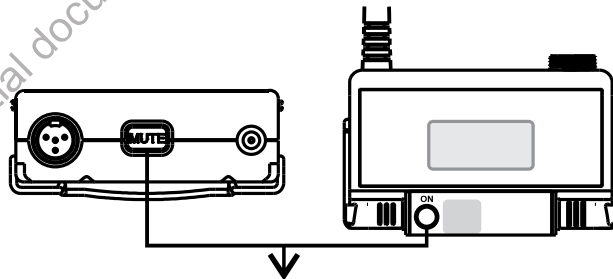

Press and hold the MUTE button, and power on



Fig. 26

4. ACT-700T / ACT-500T / ACT-300T LCD.

Fig. 27:

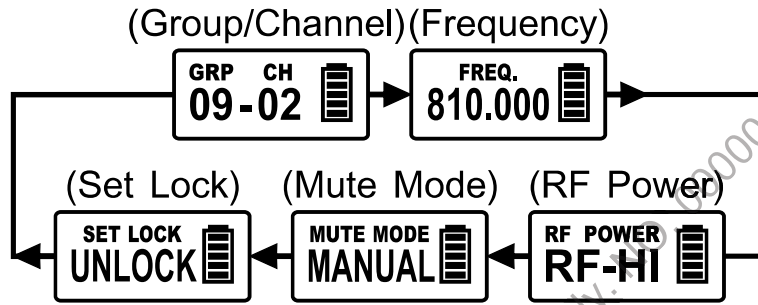

Fig. 27

(A) Group (GRP) / Channel (CH) / Frequency (FREQ.), Fig. 28:

- (1) Group / Channel / Frequency messages are displayed only and cannot be changed.
- (2) To change Group / Channel / Frequency, do it at the receiver and then press ACT button to sync.

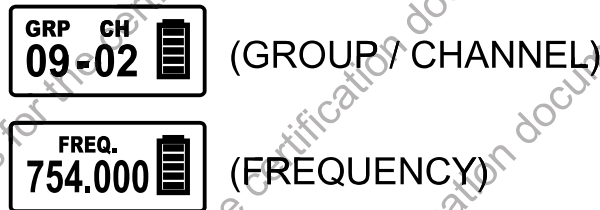

Fig. 28

- (3) For those specific channels set via PC, the screen shows only CHANNEL and numbers.



Fig. 29

(B) RF POWER Setting. Fig. 30:

Select RF-HI or RF-LOW.

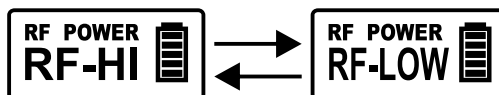

Fig. 30

(C) MUTE MODE Setting. Fig. 31:

- (1) Select MANUAL or DISABLE.
- (2) MANUAL: Use MUTE button to mute/unmute.
- (3) DISABLE: MUTE button is disabled. Mute setting is canceled.

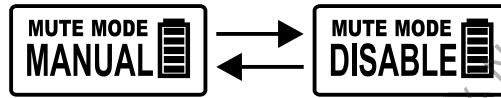

Fig. 31

(D) SET LOCK Setting. Fig. 32:

- (1) Select LOCK or UNLOCK.
- (2) LOCKED: Power button is locked and cannot be operated. The mute function is workable.
- (3) Press MODE button and press SET button to select UNLOCK to unlock the setting. After UNLOCK stops blinking, the unlock setting is confirmed and the power button lock will be canceled.

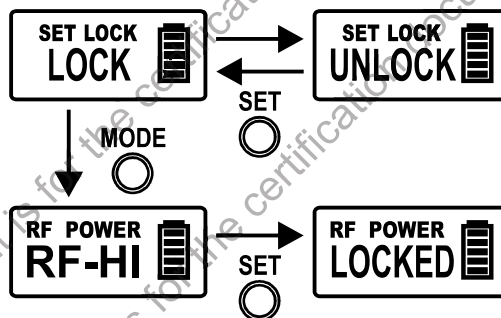

Fig. 32

(E) Error Codes:

- (1) ERR no01 → EEPROM Channel wasn't programmed or internal data error.
- (2) ERR no02 → for testing only.
- (3) ERR no03 → the set frequency exceeds the upper band. The transmitter frequency will not be changed but it can be operated as long as the power switch is turned on again.
- (4) ERR no04 → the set frequency exceeds the lower band. The transmitter frequency will not be changed but it can be operated as long as the power switch is turned on again.

(H) MUTE Button. Fig. 33:

- (1) Press MUTE button to enter mute status.
- (2) Press MODE, SET buttons to select parameters. Idle for 5 seconds and return to MUTE mode.
- (3) Press MUTE button again to unmute.
- (4) Unmute Mode: The screen shows UNMUTE for 1 second and returns to Home Screen.
- (5) MUTE button is only workable under MANUAL mode.

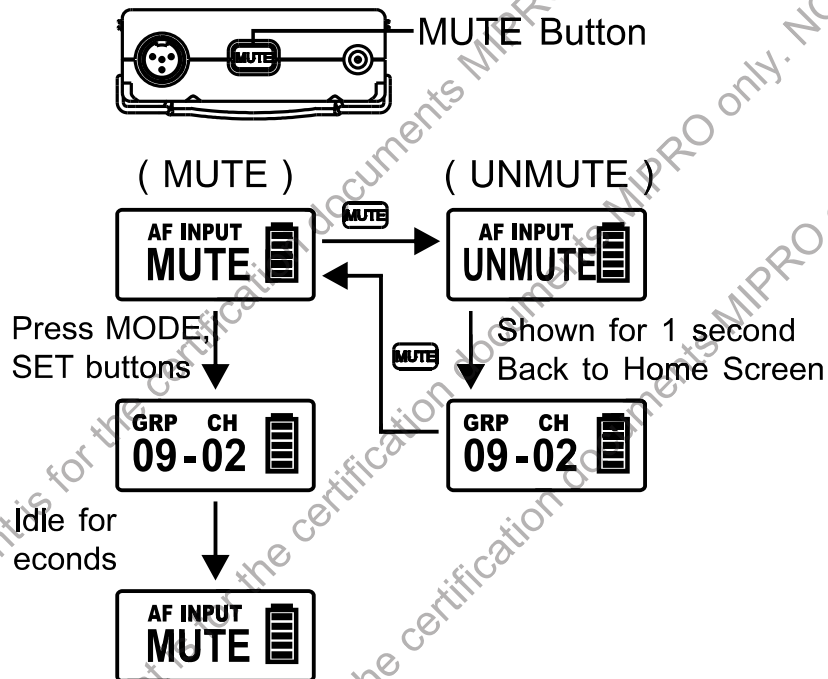

Fig. 33

VI. Other Operations

1. Remote Control Mute Connector.

Fig. 34:

3.5 Ø Remote Control Mute Connector is for accepting MJ-70 Remote Mute Switch Cable.

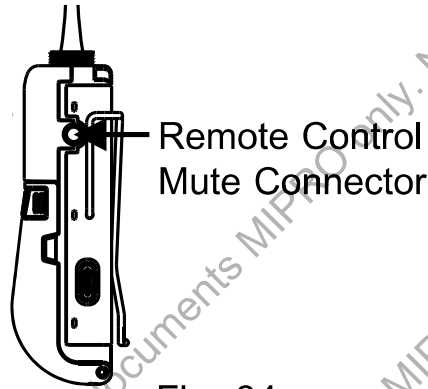

Fig. 34

2. Remote Mute Switch (Optional).

Fig. 35:

Plug MJ-70 Remote Mute Switch into Remote Control Mute Connector **12** before power on.

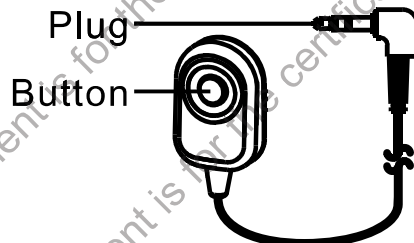

Fig.35

VII. Notes

1. Refer to the actual product in the event of product description discrepancy.
2. Frequency range and maximum deviation comply with the regulations of different countries.

VIII. 4-Pin Microphone Input Jack Wiring. Fig. 36

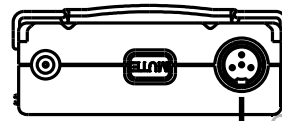

Fig. 36

1. 2-wire electret condenser microphone capsule connection. Fig. 37:

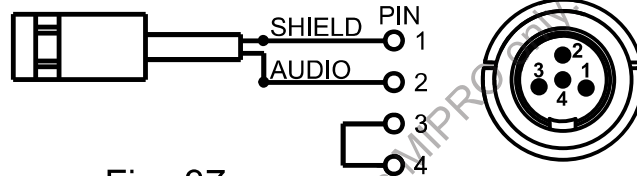

Fig. 37

2. 3-wire electret condenser microphone capsule connection. Fig. 38:

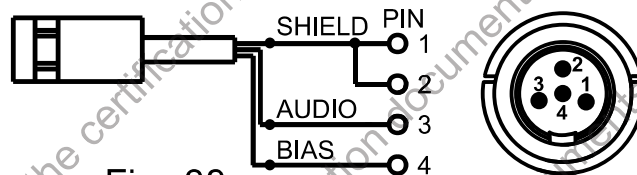

Fig. 38

3. Dynamic Microphone. Fig. 39

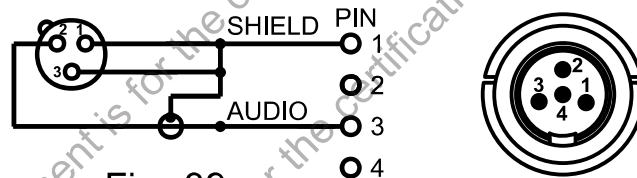

Fig. 39

4. Electric Guitar. Fig. 40:

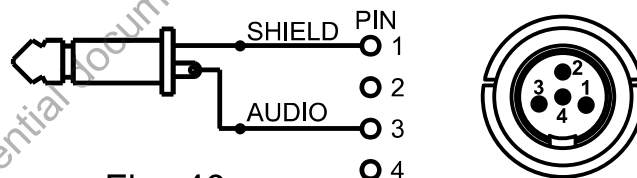

Fig. 40

5. Line-in (impedance 8K ATT 10dB). Fig. 41

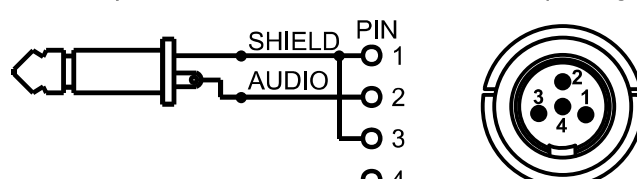

Fig. 41

Bodypack Transmitters

Federal Communication Commission Interference Statement

This equipment has been tested and found to comply with the limits for a Class B digital device, pursuant to Part 15 of the FCC Rules. These limits are designed to provide reasonable protection against harmful interference in a residential installation.

This equipment generates, uses and can radiate radio frequency energy and, if not installed and used in accordance with the instructions, may cause harmful interference to radio communications. However, there is no guarantee that interference will not occur in a particular installation. If this equipment does cause harmful interference to radio or television reception, which can be determined by turning the equipment off and on, the user is encouraged to try to correct the interference by one of the following measures:

- . Reorient or relocate the receiving antenna.
- . Increase the separation between the equipment and receiver.
- . Connect the equipment into an outlet on a circuit different from that to which the receiver is connected.
- . Consult the dealer or an experienced radio/TV technician for help.

FCC Caution: To assure continued compliance, any changes or modifications not expressly approved by the party responsible for compliance could void the user's authority to operate this equipment. (Example - use only shielded interface cables when connecting to computer or peripheral devices).

FCC Radiation Exposure Statement

This equipment complies with FCC RF radiation exposure limits set forth for an uncontrolled environment. This equipment should be installed and operated with a minimum distance of 0.5 centimeters between the radiator and your body.

This transmitter must not be co-located or operating in conjunction with any other antenna or transmitter.

The antennas used for this transmitter must be installed to provide a separation distance of at least 0.5 cm from all persons and must not be co-located or operating in conjunction with any other antenna or transmitter.

This device complies with Part 15 of the FCC Rules.

Operation is subject to the following two conditions:

- (1) This device may not cause harmful interference, and
- (2) This device must accept any interference received, including interference that may cause undesired operation.

This Confidential document is for the certification documents MIPRO only. NO. 000000987
This Confidential document is for the certification documents MIPRO only. NO. 000000
This Confidential document is for the certification documents MIPRO only. NO.

MIPRO[®]
MICROPHONE PROFESSIONALS



MIPRO Electronics Co., Ltd

Headquarters: No. 814, Beigang Rd., Chiayi City 600079, Taiwan
Tel : +886.5.238.0809 Fax : +886.5.238.0803
www.mipro.com.tw mipro@mipro.com.tw



2 CE669A

All rights reserved. Do not copy or forward without prior approvals MIPRO. Specifications and design subject to change without notice. YM 021/05