

# MIPRO<sup>®</sup>

## ACT-31T

### Bodypack Transmitter

### User Guide



**MIPRO<sup>®</sup>**  
MICROPHONE PROFESSIONALS

**MIPRO Electronics Co., Ltd**

Headquarters : 814 Pei-Kang Road, Chiayi, 60096, Taiwan  
Tel : +886.5.238.0809 Fax : +886.5.238.0803  
www.mipro.com.tw mipro@mipro.com.tw



2CE347E



All rights reserved. Do not copy or forward without prior approvals MIPRO.  
Specifications and design subject to change without notice. MN 013/09

## **! IMPORTANT SAFETY INSTRUCTIONS !**

1. Read these instructions.
2. Keep these instructions.
3. Heed all warnings.
4. Follow all instructions.
5. Do not use this apparatus near water.
6. Clean only with a dry cloth.
7. Do not block any ventilation openings. Install in accordance with the manufacturer's instructions.
8. Do not install near any heat sources such as radiators, heat registers, stoves, or other apparatus (including amplifiers) that produce heat.
9. Do not defeat the safety purpose of the polarised or ground plug: A polarised plug has two blades with one wider than the other. The wide blade is provided for your safety. When the provided plug does not fit into your outlet, consult an electrician for replacement of the obsolete outlet.
10. Protect the power cord from being walked on or pinched particularly at plug, convenience receptacles, and the point where they exit from the apparatus.
11. Only use attachments/accessories specified by the manufacturer.
12. Use only with a cart, stand, tripod, bracket, or table specified by the manufacturer, or sold with the apparatus. When a cart is used, use caution when moving the cart/apparatus combination to avoid injury from tip-over. 
13. Unplug this apparatus during lightning storms or when unused for long periods of time.
14. Refer all servicing to qualified service personnel. Servicing is required when the apparatus has been damaged in any way, such as power-supply cord or plug is damaged, liquid has been spilled or objects have fallen into the apparatus, the apparatus has been exposed to rain or moisture, does not operate normally, or has been dropped.
15. To reduce the risk of fire or electric shock, do not expose this apparatus to rain or moisture.
16. Apparatus should not be exposed to dripping or splashing and no objects filled with liquids, should be placed on the apparatus.
17. Use only with the battery which specified by manufacturer.
18. The power supply cord set is to be the main disconnected device.

## **WARNING**

1. **FOR OUTDOOR USE:**  
To reduce the risk of fire or electric shock, do not expose this apparatus to rain or moisture.
2. **UNDER WET LOCATION:**  
Apparatus should not be exposed to dripping or splashing and no objects filled with liquids, such as vases should be placed on the apparatus.
3. **SERVICE INSTRUCTIONS:**  
CAUTION - These servicing instructions are for use by qualified service personnel only. To reduce the risk of electric shock, do not perform any servicing other than that contained in the operating instructions unless you are qualified to do so.

**CAUTION**  
RISK OF ELECTRIC SHOCK  
DO NOT OPEN

 This symbol indicates that dangerous voltage constituting a risk of electric shock is present within this unit.

 This symbol indicates that there are important operating and maintenance instructions in the literature accompanying this unit.

**Disposal** Dispose of any unusable devices or batteries responsibly and in accordance with any applicable regulations.



2006-08-15

Disposing of used batteries with domestic waste is to be avoided!

Batteries / NiCad cells often contain heavy metals such as cadmium(Cd), mercury(Hg) and lead(Pb) that makes them unsuitable for disposal with domestic waste. You may return spent batteries/accumulators free of charge to recycling centres or anywhere else batteries/accumulators are sold.

By doing so, you contribute to the conservation of our environment!

## Contents

- 1 Bodypack Controls and Indicators
- 3 Operating Instructions
- 4 LCD Display Screen
- 5 Transmitter Parameters
- 12 Battery Status
- 13 MUTE Control Set-Up
- 15 AF Input Connections
- 16 Battery Removal and Installation

## Bodypack Controls and Indicators

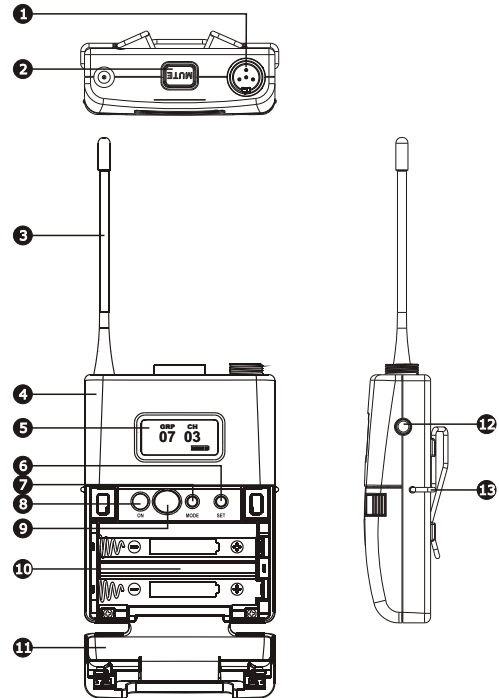

- ❶ **Audio Input Connector:** TA4F mini 4-pin connector accepts any MIPRO lavalier, instrument and headset microphones and cables. (See 5 ways of connection on AF Input Connections)
- ❷ **MUTE Button:** To mute and un-mute the audio signal temporary.

- 3 **Antenna:** Flexible 1/4 wave transmitting antenna.
- 4 **Transmitter Housing:** Holds PCB board and wires.
- 5 **LCD Panel:** Display transmitter parameters.
- 6 **SET Button:** Parameter selection button.
- 7 **MODE Button:** Allows access to 7 available functions displaying in LCD panel.
- 8 **Power Button:** Press and hold 2 seconds to power ON or OFF.
- 9 **ACT IR Port:** Align and syncs the transmitter and receiver frequency automatically.
- 10 **Battery Compartment:** Holds 2 'AA' batteries.
- 11 **Battery Cover:** Hinged cover opens to provide access to 2 'AA' batteries.
- 12 **External Mute Connector:** When an external mute switch cable, MJ-70 (optional) is connected, user can manually mute and un-mute the audio temporary.
- 13 **Belt Clip:** Detachable and reversible design allows the transmitter to be worn on a belt, waistband, or guitar strap (Figure 1).

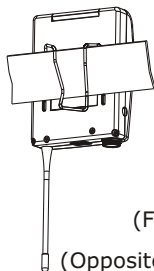
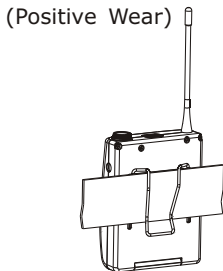

(Figure 1)

(Opposite Wear)

## Operating Instructions

- The audio gain level is factory preset at Microphone-Low level. Guitar setting is recommended at LINE level.
- Insert the lavalier, headset microphone or instrument cable into the audio input connector before power ON the transmitter.
- Tighten the connector screw clockwise direction as shown in (Figure 2) for a secured fit.

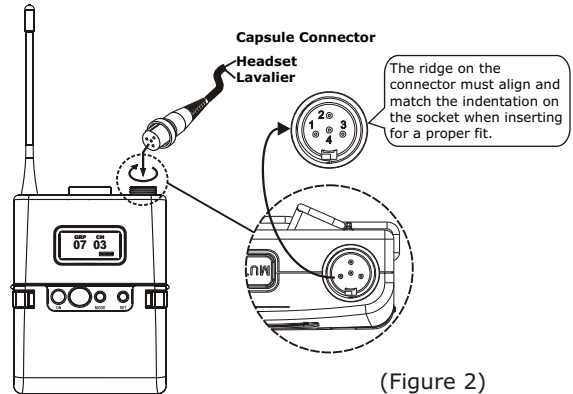

(Figure 2)

## LCD Display Screen



- 14 LCD Screen
- 15 AF (audio) MUTE
- 16 Transmitter Battery Meter

## Transmitter Parameters

- **MODE** button  
Press "**MODE**" button to access one of the 7 parameters below.
- **SET** button  
Press "**SET**" button then the changeable functions will twinkle. Change to the desired parameters during the above twinkle by pressing "**SET**" button.

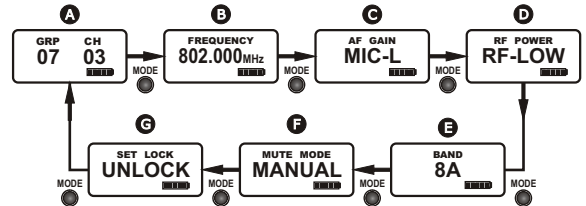
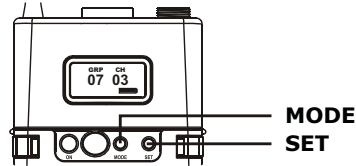

- A Group and Channel
- B Frequency
- C Sensitivity Level
- D RF Output Power
- E Frequency Band
- F MUTE Mode
- G Parameters Lock & Unlock Status

- Frequency Band, Group & Channel and Frequency are factory pre-set, thus, its parameter values are displayed after it is ACT synced. Values cannot be changed.



(Frequency Band)



(Group and Channel)



(Frequency)

## Setting Input Sensitivity Level

- 4 Selectable Sensitivity Levels:  
**LINE** \ **MIC-L (MICROPHONE-LOW)** \ **MIC-M (MICROPHONE-MID)** \ **MIC-H (MICROPHONE-HIGH)**.
- Press **MODE** button until **AF GAIN** mode appears.
- Press **SET** button once to activate function.
- Press **SET** button to select the desired sensitivity level.
- Press **MODE** button to confirm and save the change.
- The higher the sensitivity level, the lower the dynamic range of input signals. Meanwhile noise will increase, and the feedback problem will be getting more serious.

**NOTE:** Guitar setting is recommended at LINE level.

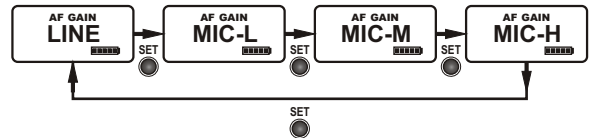

## Setting RF Output Power

- 2 RF Output Power Levels: **RF-LOW** and **RF-HI**.
- Press **MODE** button until **RF POWER LOW** or **RF POWER HIGH** mode appears.
- Press **SET** button once to activate function.
- Press **SET** button to select the desired RF output power.
- Press **MODE** button to confirm and save the change.

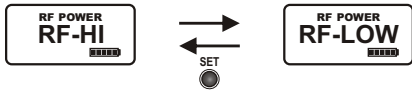

## MUTE MODE

- **MUTE MODE:** Select from **MANUAL** and **DISABLE**.
- Press **MODE** button until **MUTE MODE** appears. Press **SET** button once, the LCD screen starts flashing to denote it is ready to accept mode changes. Press **SET** button to change between **MANUAL** and **DISABLE** in cycle. Press **MODE** button to confirm and save the change, or LCD will stop flashing after 5 seconds and parameter will be saved.
- **MUTE** button is operable when **MUTE MODE** is set in **MANUAL** mode.
- **MUTE** button is not operable when **MUTE MODE** is set in **DISABLE** mode.

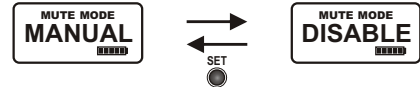

## Setting LOCK

- Setting LOCK can be switched to **LOCK** or **UNLOCK** mode.
- Press **MODE** button until **SET LOCK** mode appears.
- Press **SET** button to select the desired parameter.
- Press **MODE** button to confirm and save the change.
- Press **SET** button twice to remove the LOCK function.
- The LOCK function will be removed automatically when losing power.
- Mute function can still work properly when LOCK.

**NOTE:** Once locked, all 7 parameter values cannot be changed.

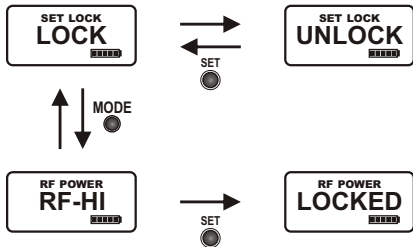

## ERR Message

- When "ERR" appears in the display it indicates that an operational error has occurred. Please refer to the following codes to diagnose which error you are experiencing.
  - ERR no01** EEPROM is not being programmed or internal data error.
  - ERR no02** For testing only.
  - ERR no03** The frequency you want to program is above the switching bandwidth of the transmitter. Use a receiver with an appropriate frequency group. (At this time the microphone is still operating and the frequency remains unchanged. To clear the displayed "ERR" message, switch the handheld transmitter off and on again.)
  - ERR no04** The frequency you want to program is below the switching bandwidth of the transmitter. Use a receiver with an appropriate frequency group. (At this time the microphone is still operating and the frequency remains unchanged. To clear the displayed "ERR" message, switch the handheld transmitter off and on again.)
- **"Group" & "Channel":** When both the group and channel numbers are displayed, it means that you are using the pre-programmed frequency of the receiver.
- **"Channel" Only:** If "Channel" only is displayed, it means that you are using a frequency which is not pre-programmed.



## Battery Status

Indicates the power remaining in the transmitter battery. When the battery has less than 10% power remaining it must be replaced or recharged. If an under voltage condition continues, the LCD will show "OFF..." and the system will shut down to prevent being overly discharged.

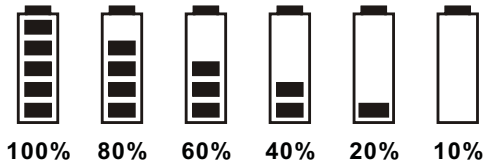

## Power Button

### "OFF..." - Power Off:

- When the power switch is turned off, the LCD will show "OFF..." (for Power Off) first and then the system will shut down and no further messages will be displayed.
- Press and hold for 2 seconds to power on & off.

OFF...

## MUTE Control Set-Up

**MUTE** control enables audio to be muted or unmuted temporarily.

- Press **MUTE** button to mute audio temporarily. Parameter values can be changed and ACT sync activate during this **MUTE** mode.
- Press **MUTE** button to un-mute.

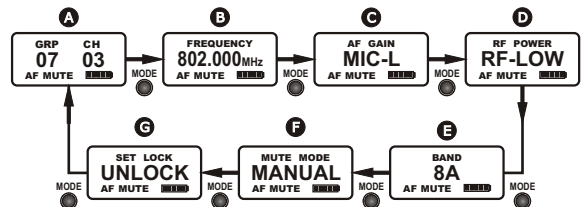
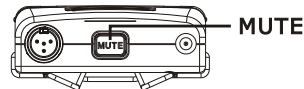

## External Mute Connector

- External mute connector is a 3.5mm jack. When an external mute switch cable, MJ-70 (optional) is connected, user can manually mute and un-mute the audio temporary.

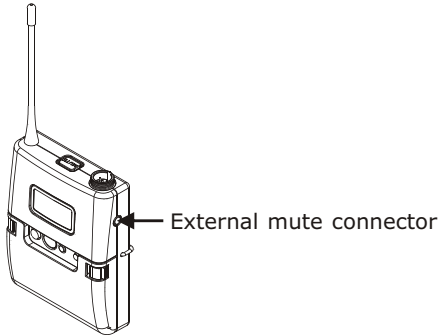

## MJ-70 External Mute Switch (optional)

- 17 3.5mm jack.
- 18 External mute switch on/off button.

**NOTE:** Plug in the device before power on the bodypack transmitter.

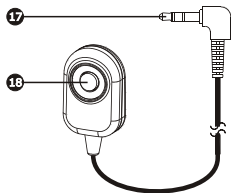

## AF Input Connections

- 2-Wire Electret condenser microphone Capsule

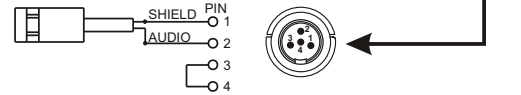

- 3-Wire Electret condenser microphone Capsule

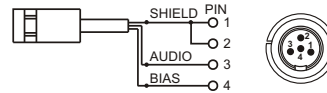

- Dynamic Microphone

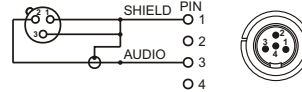

- Electric Guitar

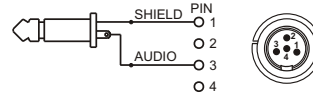

- Line-in (Impedance  $8K\Omega$  ATT. 10dB)

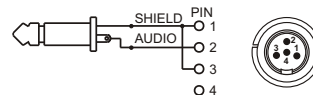

## Battery Removal and Installation

Pushing down both snap locks on the sides to open battery compartment cover. Take out the two batteries. (Figure 3)

Insert two fresh AA batteries (alkaline type is recommended) into the battery compartment according to the correct polarity (- and +) as shown in (Figure 4). Then close the battery compartment cover tightly.

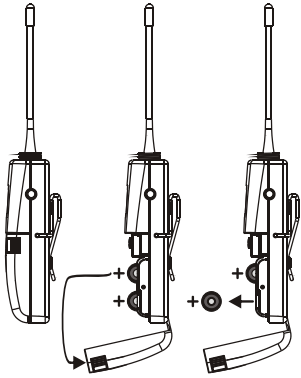

(Figure 3)

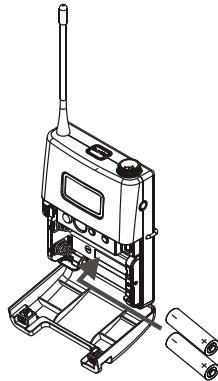

(Figure 4)

### Caution:

Remove the batteries if unused for a long period of time to prevent battery leakage, corrosion and causes possible damage to electronics.



## & IC - ID

THIS DEVICE COMPLIES WITH PART 15 & 74 OF THE FCC RULES AND RSS-123 ISSUE 2, RSS-210 ISSUE 8 OF CANADA.

OPERATION IS

SUBJECT TO THE FOLLOWING TWO CONDITIONS:

- (1) This device may not cause interference.
- (2) This device must accept any interference, including interference that may cause undesired operation of the device. This equipment complies with FCC RF radiation exposure limits set forth for an uncontrolled environment.

Le présent appareil est conforme aux CNR d'Industrie Canada applicables aux appareils radio

exempts de licence. L'exploitation est autorisée aux deux conditions suivantes :

- (1) l'appareil ne doit pas produire de brouillage, et
- (2) l'utilisateur de l'appareil doit accepter tout brouillage radioélectrique subi, même si le brouillage est susceptible d'en compromettre le fonctionnement.

## **Federal Communication Commission Interference Statement**

This equipment has been tested and found to comply with the limits for a Class B digital device, pursuant to Part 15 & 74 of the FCC Rules. These limits are designed to provide reasonable protection against harmful interference in a residential installation.

This equipment generates, uses and can radiate radio frequency energy and, if not installed and used in accordance with the instructions, may cause harmful interference to radio communications. However, there is no guarantee that interference will not occur in a particular installation. If this equipment does cause harmful interference to radio or television reception, which can be determined by turning the equipment off and on, the user is encouraged to try to correct the interference by one of the following measures:

- . Reorient or relocate the receiving antenna.
- . Increase the separation between the equipment and receiver.
- . Connect the equipment into an outlet on a circuit different from that to which the receiver is connected.
- . Consult the dealer or an experienced radio/TV technician for help.

***FCC Caution:*** To assure continued compliance, any changes or modifications not expressly approved by the party responsible for compliance could void the user's authority to operate this equipment. (Example - use only shielded interface cables when connecting to computer or peripheral devices).