

# MIPRO<sup>®</sup>

## User Guide

### ACT-24HC

Rechargeable Handheld Transmitter

### ACT-24TC

Rechargeable Bodypack Transmitter

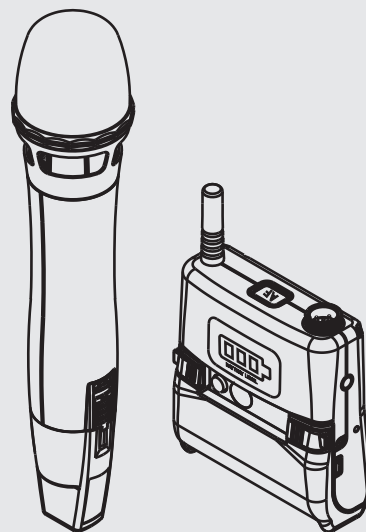

**MIPRO<sup>®</sup>**  
MICROPHONE PROFESSIONALS

**MIPRO Electronics Co., Ltd**

Headquarters : 814 Pei-Kang Road, Chiayi, 60096, Taiwan  
Tel : +886.5.238.0809 Fax : +886.5.238.0803  
www.mipro.com.tw mipro@mipro.com.tw

All rights reserved. MN 015/03

Do not copy or forward without prior approvals MIPRO.

Specifications and design subject to change without notice.



2CE540A

## Contents

### Rechargeable Handheld Transmitter

- 1 Handheld Controls and Indicators
- 3 Operating instructions for insertion & removing battery
- 5 Operating instructions
- 6 Rear Cap has an On/Off Switch Protection
- 7 General Tips for Improving System Performance

### Rechargeable Bodypack Transmitter

- 8 Bodypack Controls and Indicators
- 10 Audio Input Operating Instructions
- 11 Operating Instructions
- 13 AF Input Connections
- 14 Battery Removal and Installation
- 16 MP-80 Battery Charger (Optional)

## Handheld Controls and Indicators

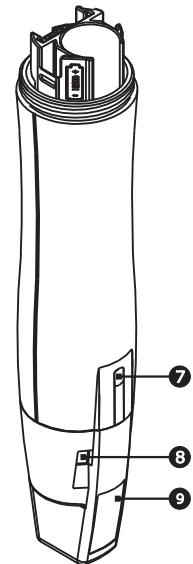
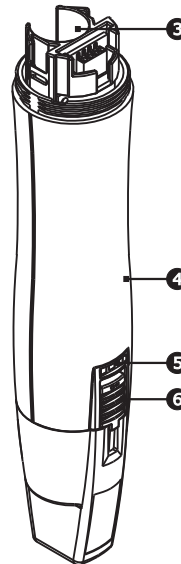
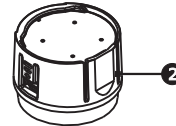
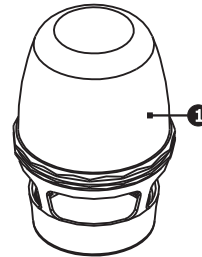

- ❶ **Capsule Module:** The anti-roll grille protects detachable microphone capsule and the internal foam prevents breathing, wind and POP noises.
- ❷ **Fixed Ring**
- ❸ **Battery Compartment:** Accommodates one 18500 rechargeable battery.
- ❹ **Housing:** Protects transmitter PCB, battery compartment and battery.
- ❺ Ascertain the power is turn "ON" to see battery status.
  - **Normal Battery:** LEDs indicates battery meters.
  - **Weak Battery:** Red LED is lit. Recharge or insert a new recharged battery.
  - **No LEDs light:** battery is completely drained or polarity inserted incorrectly.
- ❻ **Power On/Off Switch:** Always power off the transmitter to conserve battery life when not in use.
- ❼ **ACT Infrared (IR) Sync Port:** Receives signals from receiver to synchronize frequencies automatically.
- ❽ **Battery Charging Contact:** Align contacts during charging.
  - (a) Metal objects contact is forbidden.
  - (b) It is forbidden to contact metal objects.
- ❾ **Color Coded Protection Cap:** Protects against accidental power on/off. Available in different colors for channel differentiation.

## Operating instructions for insertion & removing battery

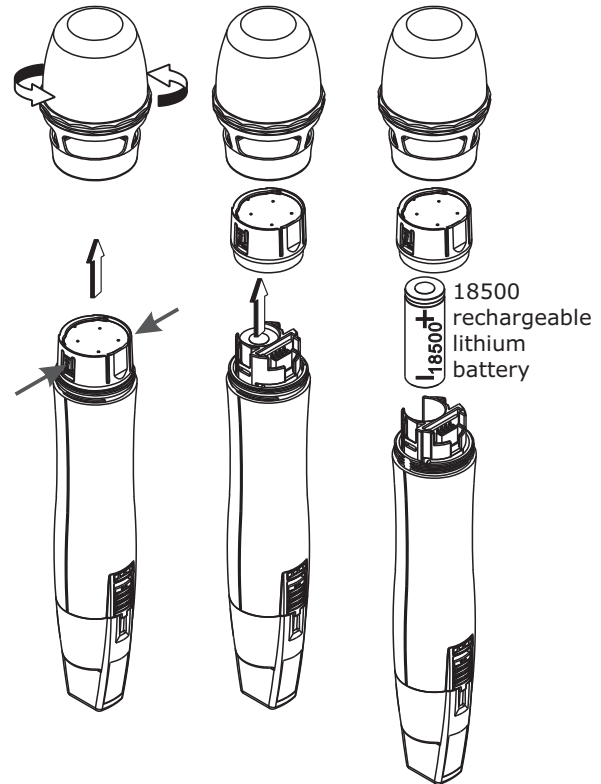

1. Remove grill in counter clock direction.
2. Press and hold both sides of microphone capsule module and remove gently.

3. Ascertain the battery is inserted according to its correct polarity. A click is heard once correctly inserted and grill can be closed properly. No click is heard and grill cannot be closed properly if battery is inserted with the wrong polarity.

**NOTE:**

Transmitter cannot be powered on with a charged battery.

- a. Check for correct polarity insertion.  
(+ facing up)
- b. If inserted with correct polarity and still cannot be powered on it could be due to battery protection mechanism is in effect. Insert the whole transmitter back to the battery charger for 10 seconds to "wake-up" and power on again.
- c. If battery charger is not used, reverse battery polarity for 10 seconds and then re-inserted with correct polarity to wake up the battery. Power on again.

**Operating Instructions**

1. Power On & Off
  - a. Power On: Push the ON/OFF switch to the "ON" location, the battery indicators will light.
  - b. Power Off: Push the ON/OFF switch back, the battery indicators will go out.
2. Battery Status Display
  - a. Red LED indicator is lit when battery is too low. Please recharge or insert a new recharged battery. The microphone will be shut down automatically if the battery keeps low status.

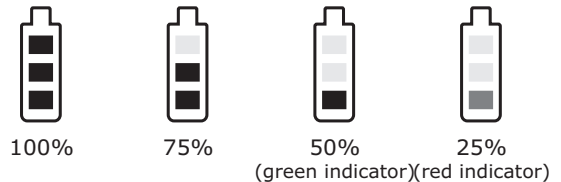

## Rear Cap has an On/Off Switch Protection

The patented color rear cap serves two purposes; it provides easy channel identification and protects the on/off switch. It is designed to allow the on/off switch to either be exposed or concealed as desired. You can avoid unintended switching off of the microphone by rotating the color rear cap 180 degrees to fix the on/off switch. The cap can be removed by gripping it firmly and pulling; be sure to push it firmly into place when replacing it on the microphone.

**Note:** During microphone usage, the color rear cap must be installed.

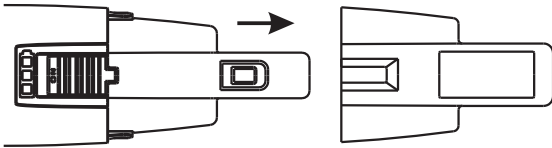

Press both sides and pull out to remove the rear cap

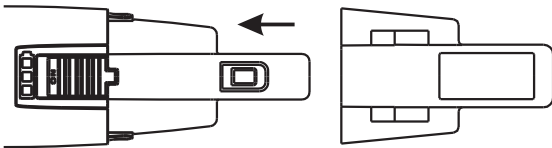

Turn the rear cap 180 degree and insert back  
The ON/OFF switch is immovable

## General Tips for Improving System Performance

1. Performer should avoid holding the microphone over or near the antenna section as this will deteriorate transmission efficiency. Severe deterioration if performer directly covers up the antenna section with both hands.
2. Many performers tend to hold the microphone by the top grille. Unfortunately, this position seriously degrades both the sound quality and directionality of a microphone. Even the most expensive microphones will have its original sound quality compromised by this method. Grabbing a microphone by the grille will isolate the capsule's acoustic resonance circuit or change the capsule resonator's frequency. This results in an inferior performance in both frequency response and the separation of directionality. In addition, a palm's sound-focusing effect will tend to strengthen resonances in certain frequencies and can cause unwanted echo.
3. A proper technique is required for using directional microphones because the distance between the microphone and your mouth has a significant impact on sensitivity and performance. There is an inverse relationship between microphone sensitivity and the distance from the mouth to the microphone. Consequently, performers with a "weaker" sound level cannot expect to hold the microphone too far away from their mouth and compensate by turning up the amplifier volume to increase the sound level as this can easily cause echo or feedback. In contrast, performers with a "louder" sound level should not hold the microphone too close as this can easily result in distortion by causing the amplifier system to be overloaded.
4. Furthermore, a large-diaphragm directional microphone has a very distinct proximity effect. When the microphone is close to the mouth, the bass response is strengthened as the distance gets closer. Therefore, if a performer's sound is insufficient in bass, they can hold the microphone closer and use the proximity effect to help compensate for the lower bass level. Conversely, if a performer's voice is too heavy in the bass register, increasing the distance between the microphone and their mouth will decrease the proximity effect and reduce the bass response, thus making their voice become clearer and brighter.
5. It is recommended to keep the grille and sponge windscreen clean to avoid any substance blocking the proximity effect of the microphone.

## Bodypack Controls and Indicators

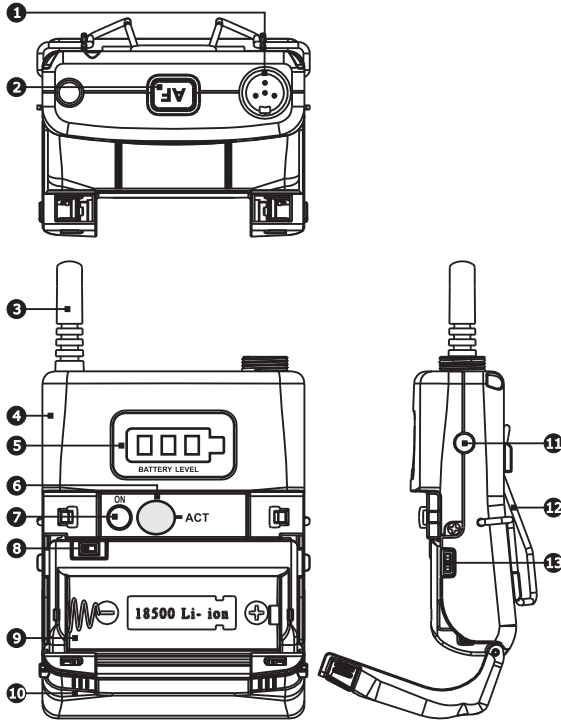

- 1 **Audio Input Connector:** TA4F mini 4-pin connector accepts any MIPRO lavalier, instrument and headset microphones and cables. (See 5 ways of connection on AF Input Connections)
- 2 **AF Button:** Light stands for audio signal. Press it and the light goes out.

- 3 **Antenna:** Flexible 1/ 4 wave transmitting antenna.
- 4 **Transmitter Housing:** Holds PCB board and wires.
- 5 **Battery Level Panel:** Display battery status.
- 6 **ACT IR Port:** Align and syncs the transmitter and receiver frequency automatically.
- 7 **Power Button:** Press and hold 2 seconds to power ON or OFF.
- 8 **Battery Circuitry Protection Reset Button**
- 9 **Battery Compartment:** Accommodates one 18500 rechargeable battery.
- 10 **Battery Cover:** Hinged cover opens to provide access to one 18500 rechargeable battery.
- 11 **External Mute Connector:** When an external mute switch cable, MJ-70 (optional) is connected , user can manually mute and un-mute the audio temporary.
- 12 **Belt Clip:** Detachable and reversible design allows the transmitter to be worn on a belt, waistband, or guitar strap (Figure 1).
- 13 **Battery Charging Contact:** Align contacts during charging.

(a) Metal objects contact is forbidden.

(b) It is forbidden to contact metal objects.

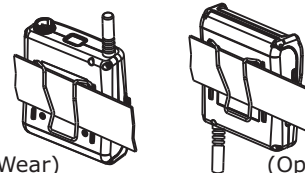

(Figure 1)

(Positive Wear)

(Opposite Wear)

## Audio Input Operating Instructions

1. Insert the lavalier, headset microphone or instrument cable into the audio input connector before power ON the transmitter.
2. Tighten the connector screw clockwise direction as shown in (Figure 2) for a secured fit.

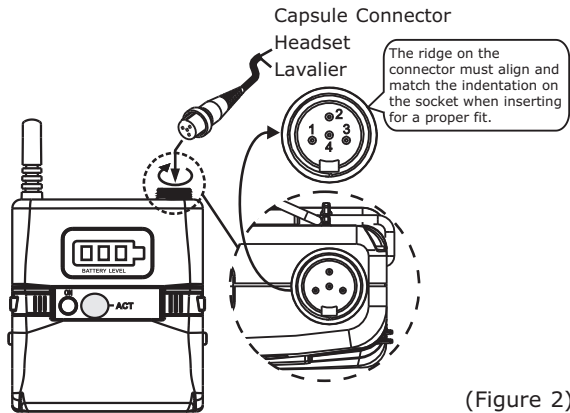

(Figure 2)

## Operating Instructions

1. Power On/Off
  - a. Power On: Press the Power button to power ON. The battery status indicators and AF Button indicator will light.
  - b. Power Off: During Power On status, press and hold the Power button for 2 seconds to power OFF.
2. Battery Status Display
  - a. Red LED indicator is lit when battery is too low. Please recharge or insert a new recharged battery. The transmitter will be shut down automatically if the battery keeps low status.

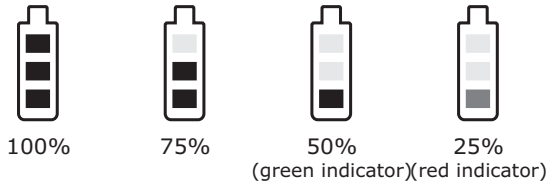

3. AF Button Setup

- a. Press AF Button to enter mute mode, and the indicator doesn't light.
- b. Press AF Button again to un-mute, and the indicator lights.

4. External Mute Connector

- a. External mute connector is a 3.5mm jack. When an external mute switch cable, MJ-70 (optional) is connected, user can manually mute and un-mute the audio temporary.

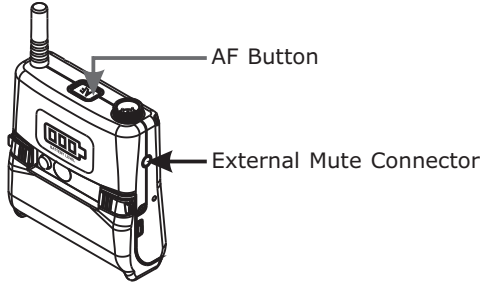

5. MJ-70 External Mute Switch (Optional)

- ① 3.5mm jack.
- ② External mute switch on/off button.

NOTE: Plug it into the device before to power on the bodypack transmitter.

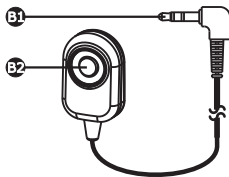

AF Input Connections

- (1) 2-Wire Electret condenser microphone Capsule



- (2) 3-Wire Electret condenser microphone Capsule

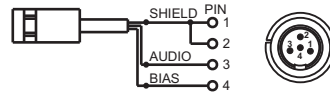

- (3) Dynamic Microphone

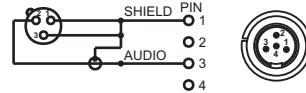

- (4) Electric Guitar

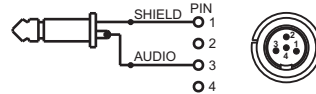

- (5) Line-in (Impedance 8KΩ ATT. 10dB)

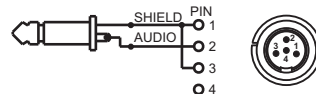



## Battery Removal and Installation

1. Pushing down both snap locks on the sides to open battery compartment cover. Take out the two batteries. (Figure 3)
2. Insert one charged 18500 rechargeable battery into the battery compartment according to the correct polarity (- and +) as shown in (Figure 4) . Then close the battery compartment cover tightly.

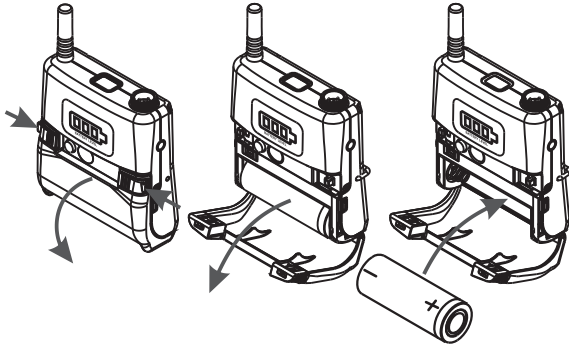

(Figure 3)

(Figure 4)

## Caution

Remove the batteries if unused for a long period of time to prevent battery leakage, corrosion and causes possible damage to electronics.

## Caution

Note: Transmitter cannot be powered on with charged battery.

Method 1:

- a. Ensure battery is inserted correctly with + top side.
- b. If battery is inserted correctly it could be due to self battery protection mechanism. Insert the transmitter into the charger to re-charge for 10-20 seconds to wake-up the battery. It should work.
- c. If charger cannot be used, reverse the battery insertion for 10-20 seconds, wake up the battery with correct polarity. It should work.

Method 2:

- a. Power off the transmitter before open the hinged cover. Press battery protection circuitry reset button once to wake-up battery. Power on the transmitter.

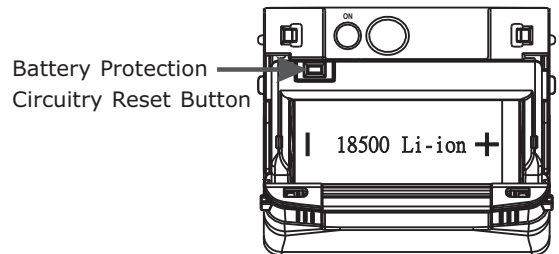

## MP-80 Battery Charger (Optional)

MP-80 Charger charges both transmitters and 18500 rechargeable batteries.

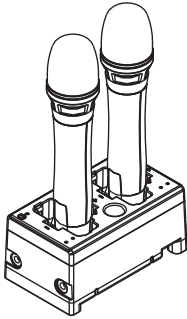

Transmitters Charging

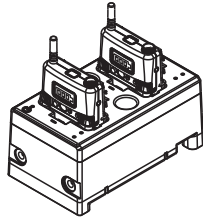

Transmitters Charging

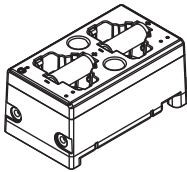

18500 Charging

### Notes

1. Refer to actual product in the event of product description discrepancy.
2. Frequency range and maximum deviation comply with the regulations of different countries.

## Federal Communication Commission Interference Statement

This equipment has been tested and found to comply with the limits for a Class B digital device, pursuant to Part 15 of the FCC Rules. These limits are designed to provide reasonable protection against harmful interference in a residential installation. This equipment generates, uses and can radiate radio frequency energy and, if not installed and used in accordance with the instructions, may cause harmful interference to radio communications. However, there is no guarantee that interference will not occur in a particular installation. If this equipment does cause harmful interference to radio or television reception, which can be determined by turning the equipment off and on, the user is encouraged to try to correct the interference by one of the following measures:

- Reorient or relocate the receiving antenna.
- Increase the separation between the equipment and receiver.
- Connect the equipment into an outlet on a circuit different from that to which the receiver is connected.
- Consult the dealer or an experienced radio/TV technician for help.

**FCC Caution:** To assure continued compliance, any changes or modifications not expressly approved by the party responsible for compliance could void the user's authority to operate this equipment. (Example - use only shielded interface cables when connecting to computer or peripheral devices).

### FCC Radiation Exposure Statement

This equipment complies with FCC RF radiation exposure limits set forth for an uncontrolled environment. This equipment should be installed and operated with a minimum distance of 0.5 cm between the radiator and your body.

This transmitter must not be co-located or operating in conjunction with any other antenna or transmitter.

The antennas used for this transmitter must be installed to provide a separation distance of at least 0.5 cm from all persons and must not be co-located or operating in conjunction with any other antenna or transmitter.

This device complies with Part 15 of the FCC Rules.

Operation is subject to the following two conditions:

- (1) This device may not cause harmful interference, and
- (2) This device must accept any interference received, including interference that may cause undesired operation.

## IC

This device complies with Industry Canada RSS-210 ISSUE 8 standards. Operation is subject to the following two conditions:

- (1) this device may not cause interference, and
- (2) this device must accept any interference, including interference that may cause undesired operation of the device.

Le présent appareil est conforme aux CNR d'Industrie Canada applicables aux appareils radio exempts de licence.

L'exploitation est autorisée aux deux conditions suivantes:

- (1) l'appareil ne doit pas produire de brouillage, et
- (2) l'utilisateur de l'appareil doit accepter tout brouillage radioélectrique subi, même si le brouillage est susceptible d'en compromettre le fonctionnement.

## WARNING

### 1. FOR OUTDOOR USE:



To reduce the risk of fire or electric shock, do not expose this apparatus to rain or moisture.

### 2. UNDER WET LOCATION:

Apparatus should not be exposed to dripping or splashing and no objects filled with liquids, such as vases should be placed on the apparatus.

### 3. SERVICE INSTRUCTIONS:

CAUTION - These servicing instructions are for use by qualified service personnel only. To reduce the risk of electric shock, do not perform any servicing other than that contained in the operating instructions unless you are qualified to do so.

CAUTION

RISK OF ELECTRIC SHOCK  
DO NOT OPEN



This symbol indicates that dangerous voltage constituting a risk of electric shock is present within this unit.



This symbol indicates that there are important operating and maintenance instructions in the literature accompanying this unit.

**Disposal** Dispose of any unusable devices or batteries responsibly and in accordance with any applicable regulations.



2005-08-19

Disposing of used batteries with domestic waste is to be avoided!

Batteries / NiCad cells often contain heavy metals such as cadmium(Cd), mercury(Hg) and lead(Pb) that makes them unsuitable for disposal with domestic waste. You may return spent batteries/accumulators free of charge to recycling centres or anywhere else batteries/accumulators are sold.

By doing so, you contribute to the conservation of our environment!