

FCC PART 74 TEST REPORT

for

Transmitter

Model No.: ACT-202T

FCC ID: M5X-ACT202T

of

Applicant: **MIPRO Electronics Co., Ltd.**

Address: **814 Pei-kang Road 600 Chia-yi Taiwan, R.O.C**

Tested and Prepared

by

Worldwide Testing Services (Taiwan) Co., Ltd.

FCC Registration No.: 930600

Industry Canada filed test laboratory Reg. No. IC 5679A-1

A2LA Accredited No.: 2732.01



Report No.: W6M21009-10893-C-1

6F, NO. 58, LANE 188, RUEY-KUANG RD., NEIHU TAIPEI 114, TAIWAN, R.O.C.
TEL: 886-2-66068877 FAX: 886-2-66068879 E-mail: wts@wts-lab.com



TABLE OF CONTENTS

1	GENERAL INFORMATION.....	3
1.1	NOTES.....	3
1.2	TESTING LABORATORY	4
1.2.1	Location	4
1.2.2	Details of accreditation status	4
1.3	DETAILS OF APPROVAL HOLDER.....	5
1.4	APPLICATION DETAILS	5
1.5	GENERAL INFORMATION OF TEST ITEM.....	5
1.6	TEST STANDARDS.....	6
2	TECHNICAL TEST.....	7
2.1	SUMMARY OF TEST RESULTS	7
2.2	TEST ENVIRONMENT	7
2.3	TEST EQUIPMENT LIST.....	8
2.4	GENERAL TEST PROCEDURE.....	11
3	TEST RESULTS (ENCLOSURE)	12
4	RF POWER OUTPUT (CONDUCTED) , FCC 2.1046 (A) ; 74.861 (E)	13
4.1	TEST PROCEDURE.....	13
4.2	TEST RESULTS	13
5	RADIATED POWER.....	14
5.1	TEST PROCEDURE	14
5.2	TEST RESULTS.....	15
6	MODULATION DEVIATION , FCC 2.1047 (B) ; 74.861(E).....	18
6.1	TEST PROCEDURE.....	18
6.2	TEST RESULTS.....	18
7	AUDIO FREQUENCY RESPONSE , FCC 2.1047 (A).....	19
7.1	TEST PROCEDURE.....	19
7.2	TEST RESULTS.....	19
8	OCCUPIED BANDWIDTH/EMISSION MASK, FCC 2.1049 (C) ; 74.861 (E)(5)	20
8.1	TEST PROCEDURE.....	20
8.2	TEST RESULTS	20
9	SPURIOUS EMISSIONS AT ANTENNA TERMINALS FCC2.1051 ; 74.861 (E)	21
9.1	TEST PROCEDURE.....	21
9.2	TEST RESULTS	21
9.3	LIMIT	21
10	RADIATED SPURIOUS EMISSION , FCC 2.1053 ; 74.861 (E).....	22



Worldwide Testing Services(Taiwan) Co., Ltd.

Registration number: W6M21009-10893-C-1

FCC ID: M5X-ACT202T

10.1	TEST PROCEDURE.....	22
10.2	TEST RESULTS	22
10.3	EXPLANATION OF TEST RESULT.....	26
10.4	LIMITS	26
11	LINE CONDUCTED EMISSION , FCC 15.207.....	27
11.1	TEST PROCEDURE.....	27
11.2	TEST RESULTS	27
12	FREQUENCY STABILITY VS. TEMPERATURE , FCC 2.1055 , 74.861 (E)	28
12.1	TEST PROCEDURE.....	28
12.2	TEST RESULTS	28
13	FREQUENCY STABILITY VS. VOLTAGE , FCC 2.1055 (D) ; 74.861 (E).....	31
13.1	TEST PROCEDURE.....	31
13.2	TEST RESULTS	31
	APPENDIX.....	32



Worldwide Testing Services(Taiwan) Co., Ltd.

Registration number: W6M21009-10893-C-1
FCC ID: M5X-ACT202T

1 General Information

1.1 Notes

The purpose of conformity testing is to increase the probability of adherence to the essential requirements or conformity specifications, as appropriate.

The complexity of the technical specifications, however, means that full and thorough testing is impractical for both technical and economic reasons.

Furthermore, there is no guarantee that a test sample which has passed all the relevant tests conforms to a specification.

Neither is there any guarantee that such a test sample will interwork with other genuinely open systems. The existence of the tests nevertheless provides the confidence that the test sample possesses the qualities as maintained and that its performance generally conforms to representative cases of communications equipment.

The test results of this test report relate exclusively to the item tested as specified in 1.5.

The test report may only be reproduced or published in full.

Reproduction or publication of extracts from the report requires the prior written approval of the Worldwide Testing Services (Taiwan) Co., Ltd.

Tester:

October 20, 2010	Rick Chen	<u>Rick Chen</u>
Date	WTS-Lab. Name	Signature

Technical responsibility for area of testing:

October 20, 2010	Chang Tse-Ming	<u>Chang Tse-Ming</u>
Date	WTS Name	Signature



Worldwide Testing Services(Taiwan) Co., Ltd.

Registration number: W6M21009-10893-C-1
FCC ID: M5X-ACT202T

1.2 Testing laboratory

1.2.1 Location

OATS
No.5-1, Shuang Sing Village,
LiShuei Rd., Wanli Township,
Taipei County 207, Taiwan (R.O.C.)

Company
Worldwide Testing Services(Taiwan) Co., Ltd.
6F, NO. 58, LANE 188, RUEY-KUANG RD.
NEIHU, TAIPEI 114, TAIWAN R.O.C.
Tel : 886-2-66068877
Fax : 886-2-66068879

1.2.2 Details of accreditation status

Accredited testing laboratory

A2LA accredited number: 2732.01

FCC filed test laboratory Reg. No. 930600

Industry Canada filed test laboratory Reg. No. IC 5679A-1



Test location, where different from Worldwide Testing Services (Taiwan) Co., Ltd. :

Name: ./.
Accredited number: ./.
Street: ./.
Town: ./.
Country: ./.
Telephone: ./.
Fax: ./.



Worldwide Testing Services(Taiwan) Co., Ltd.

Registration number: W6M21009-10893-C-1

FCC ID: M5X-ACT202T

1.3 Details of approval holder

Name: MIPRO Electronics Co., Ltd.
Street: 814 Pei-kang Road
Town: Chia-yi, 600
Country: Taiwan, R.O.C.
Telephone: +886-5-238-0809
Fax: +886-5-238-0803

1.4 Application details

Date of receipt of test sample: September 14, 2010
Date of test: From September 15, 2010 to October 20, 2010

1.5 General information of Test item

Type of test item: Transmitter
Model Number: ACT-202T
Brand Name: MIPRO
Multi-listing model number: ./.
Photos: see Appendix

Technical data

Frequency band :

Frequency(MHz)	TV Band	Used Band
26.100-26.480	<input type="checkbox"/>	<input type="checkbox"/>
54.000-72.000	<input type="checkbox"/>	<input type="checkbox"/>
76.000-88.000	<input type="checkbox"/>	<input type="checkbox"/>
161.625-161.775	<input type="checkbox"/>	<input type="checkbox"/>
174.000-216.000	<input type="checkbox"/>	<input type="checkbox"/>
450.000-451.000	<input type="checkbox"/>	<input type="checkbox"/>
455.000-456.000	<input type="checkbox"/>	<input type="checkbox"/>
470.000-488.000	<input type="checkbox"/>	<input type="checkbox"/>
488.000-494.000	<input type="checkbox"/>	<input type="checkbox"/>
494.000-608.000	<input checked="" type="checkbox"/>	<input checked="" type="checkbox"/>
614.000-697.000	<input checked="" type="checkbox"/>	<input checked="" type="checkbox"/>
944.000-952.000	<input type="checkbox"/>	<input type="checkbox"/>



Worldwide Testing Services(Taiwan) Co., Ltd.

Registration number: W6M21009-10893-C-1

FCC ID: M5X-ACT202T

Frequency band 1: 506.1~529.9 MHz
Frequency band 2: 614.1~697.9 MHz
Frequency (ch A): 506.1 MHz
Frequency (ch B): 518.0 MHz
Frequency (ch C): 529.9 MHz
Frequency (ch D): 614.1 MHz
Frequency (ch E): 655.5 MHz
Frequency (ch F): 697.9 MHz
Antenna Type: Build in antenna / gain:1 dBi
Power supply: Li Polymer×2 (7.4V)

Operation modes: Simplex

Additional information: The EUT is the portable device. So the EUT was tested on three different axes. The EUT uses the frequency range that are more than 10 MHz, so that was tested on low, middle, and high three different frequencies.

Manufacturer: (if different from approval holder)

Name: ./.
Street: ./.
Town: ./.
Country: ./.

1.6 Test standards

Technical standard: FCC Part 74 Subpart H , section 74.861 (2009-10)



Registration number: W6M21009-10893-C-1

FCC ID: M5X-ACT202T

2 Technical test

2.1 Summary of test results

No deviations from the technical specification(s) were ascertained in the course of the tests performed.

or

The deviations as specified in 3 were ascertained in the course of the tests performed.

2.2 Test environment

Temperature: 23 °C

Relative humidity content: 20 ... 75 %

Air pressure: 86-103 KPa



Worldwide Testing Services(Taiwan) Co., Ltd.

Registration number: W6M21009-10893-C-1

FCC ID: M5X-ACT202T

2.3 Test Equipment List

No.	Test equipment	Type	Serial No.	Manufacturer	Cal. Date	Next Cal. Date
ETSTW-CE 001	EMI TEST RECEIVER	ESHS10	842121/013	R&S	2010/9/2	2011/9/1
ETSTW-CE 004	ZWEILEITER-V- NETZNACHBILDUNG TWO- LINE V-NETWORK	ESH3-Z5	840731/011	R&S	2010/3/2	2011/3/1
ETSTW-CE 005	Line-Impedance Stabilisation Network	NNBM 8126D	137	Schwarzbeck	2010/9/8	2011/9/7
ETSTW-CE 006	IMPULSBEGRENZER PULSE LIMITER	ESH3-Z2	100226	R&S	2010/5/8	2011/5/7
ETSTW-CE 007	SPECTRUM ANALYZER 5GHz	FSB	849670/001	R&S	Pre-test Use NCR	
ETSTW-CE 008	HF-EICHLLEITUNG RF STEP ATTENUATOR 139dB DPSP	334.6010.02	844581/024	R&S	Function Test	
ETSTW-CE 009	TEMP.&HUMIDITY CHAMBER	GTH-225-40-1P-U	MAA0305-009	GIANT FORCE	2010/7/21	2011/7/19
ETSTW-CE 015	CISPR 22 TWO BALANCED TELECOM PAIRS IMPEDANCE STABILIZATION NETWORK	FCC-TLISN-T8-02	20307	FCC	2010/9/6	2011/9/5
ETSTW-RE 002	Function Generator	33220A	MY43004982	Agilent	Function Test	
ETSTW-RE 003	EMI TEST RECEIVER	ESI 26	831438/001	R&S	2010/8/10	2011/8/9
ETSTW-RE 004	EMI TEST RECEIVER	ESI 40	832427/004	R&S	2010/9/14	2011/9/13
ETSTW-RE 005	EMI TEST RECEIVER	ESVS10	843207/020	R&S	2010/9/2	2011/9/1
ETSTW-RE 006	Attenuator 10dB	50HF-010-5N-1	None	STEP	2010/3/5	2011/3/4
ETSTW-RE 010	ABSORBING CLAMP	MDS 21	3469	Schwarzbeck	2010/9/6	2011/9/5
ETSTW-RE 012	TUNABLE BANDREJECT FILTER	D.C 0309	146	K&L	Function Test	
ETSTW-RE 013	TUNABLE BANDREJECT FILTER	D.C 0336	397	K&L	Function Test	
ETSTW-RE 018	MICROWAVE HORN ANTENNA	AT4560	27212	AR	2010/9/8	2011/9/7
ETSTW-RE 020	MICROWAVE HORN ANTENNA	AT4002A	306915	AR	Function Test	
ETSTW-RE 021	SWEEP GENERATOR	SWM05	835130/010	R&S	2010/8/20	2011/8/19
ETSTW-RE 027	Passive Loop Antenna	6512	00034563	EMCO	2010/7/22	2011/7/21
ETSTW-RE 028	Log-Periodic Dipole Array Antenna	3148	34429	EMCO	2010/4/14	2011/4/13
ETSTW-RE 029	Biconical Antenna	3109	33524	EMCO	2010/4/14	2011/4/13
ETSTW-RE 030	Double-Ridged Guide Horn Antenna	3117	00035224	EMCO	2010/3/2	2011/3/1
ETSTW-RE 032	Millivoltmeter	URV 55	849086/013	R&S	2010/8/17	2011/8/16
ETSTW-RE 033	WaveRunner 6000A Serise Oscilloscope	WAVERUNNER 6100A	LCRY0604P14508	LeCroy	Function Test	
ETSTW-RE 034	Power Sensor	URV5-Z4	839313/006	R&S	2010/8/17	2011/8/16
ETSTW-RE 044	Log-Periodic Antenna	HL050	100094	R&S	2010/5/11	2011/5/10
ETSTW-RE 047	PSA SERIES SPECTRUM ANALYZER	E4445A	MY46181369	Agilent	Pre-test Use NCR	
ETSTW-RE 048	Triple Loop Antenna	HXYZ 9170	HXYZ 9170-134	Schwarzbeck	2010/8/30	2011/8/29
ETSTW-RE 049	TRILOG Super Broadband test Antenna	VULB 9160	9160-3185	Schwarzbeck	2010/4/13	2011/4/12
ETSTW-RE 051	Attenuator 6dB	50HF-006-1	None	JFW	2010/3/5	2011/3/4
ETSTW-RE 053	Attenuator 3dB	50HF-003-1	None	JFW	2010/3/5	2011/3/4



Worldwide Testing Services(Taiwan) Co., Ltd.

Registration number: W6M21009-10893-C-1

FCC ID: M5X-ACT202T

ETSTW-RE 055	SPECTRUM ANALYZER	FSU 26	200074	R&S	2010/6/3	2011/6/2
ETSTW-RE 060	Attenuator 30dB	5015-30	F651012z-01	ATM	Pre-test Use NCR	
ETSTW-RE 061	Amplifier Module	CHC 1	None	ETS	2010/9/27	2011/9/26
ETSTW-RE 062	Amplifier Module	CHC 2	None	KMIC	2009/11/12	2010/11/11
ETSTW-RE 064	Bluetooth Test Set	MT8852B-042	6K00005709	Anritsu	Function Test	
ETSTW-RE 065	Amplifier	AMF-6F-18002650-25-10P	941608	MITEQ	2010/4/13	2011/4/12
ETSTW-RE 066	Highpass Filter	H1G013G1	206015	MICROWAVE CIRCUITS, INC.	2010/3/5	2011/3/4
ETSTW-RE 072	CELL SITE TEST SET	8921A	3339A00375	HP	2010/9/30	2011/9/29
ETSTW-RE 073	Power Meter	N1911A	MY45100769	Agilent	2010/1/7	2011/1/6
ETSTW-RE 074	Power Sensor	N1921A	MY45241198	Agilent	2010/1/7	2011/1/6
ETSTW-RE 081	Highpass Filter	H03G13G1	4260-02 DC0428	MICROWAVE CIRCUITS, INC.	2010/3/5	2011/3/4
ETSTW-RE 096	SIGNAL GENERATOR	SMIQ 03B	102274	R&S	2010/5/31	2011/5/30
ETSTW-RE 099	DC Block	50DB-007-1	None	JFW	2010/3/5	2011/3/4
ETSTW-RE 105	2.4GHz Notch Filter	NO124411	39555	MICROWAVE CIRCUITS, INC.	2010/3/25	2011/3/24
ETSTW-RE 106	Humidity Temperature Meter	TES-1366	091011113	TES	2010/3/25	2011/3/24
ETSTW-GSM 002	Universal Radio Communication Tester	CMU 200	109439	R&S	2010/9/8	2011/9/7
ETSTW-GSM 019	Band Reject Filter	WRCTF824/849-822/851-40/12+9SS	3	WI	Function Test	
ETSTW-GSM 020	Band Reject Filter	WRCD1747/1748-1743/1752-32/5SS	1	WI	Function Test	
ETSTW-GSM 021	Band Reject Filter	WRCD1879.5/1880.5-1875.5/1884.5-32/5SS	3	WI	Function Test	
ETSTW-GSM 022	Band Reject Filter	WRCT901.9/903.1-904.25-50/8SS	1	WI	Function Test	
ETSTW-GSM 023	Power Divider	4901.19.A	None	SUHNER	2010/9/20	2011/9/19
ETSTW-Cable 002	Microwave Cable	SUCOFLEX 104 (S_Cable 7)	238093	HUBER+SUHNER	2010/9/27	2011/9/26
ETSTW-Cable 003	Microwave Cable	SUCOFLEX 104 (S_Cable 11)	209953	HUBER+SUHNER	2010/9/27	2011/9/26
ETSTW-Cable 006	Microwave Cable	SUCOFLEX 104 (S_Cable 8)	238095	HUBER+SUHNER	2010/3/5	2011/3/4
ETSTW-Cable 010	BNC Cable	5 M BNC Cable	None	JYE BAO CO.,LTD.	2010/3/5	2011/3/4
ETSTW-Cable 011	BNC Cable	BNC Cable 1	None	JYE BAO CO.,LTD.	2010/8/19	2011/8/18
ETSTW-Cable 012	BNC Cable	BNC Cable 2	None	JYE BAO CO.,LTD.	2010/8/19	2011/8/18
ETSTW-Cable 013	Microwave Cable	SUCOFLEX 104 (S_Cable 5)	232345	HUBER+SUHNER	2010/3/5	2011/3/4
ETSTW-Cable 022	N TYPE Cable	OATS Cable 3	0002	JYE BAO CO.,LTD.	2010/3/5	2011/3/4
ETSTW-Cable 028	Microwave Cable	FA147A0015M2020	30064-2	UTIFLEX	2010/9/13	2011/9/12
ETSTW-Cable 029	Microwave Cable	FA147A0015M2020	30064-3	UTIFLEX	2010/9/13	2011/9/12
ETSTW-Cable 039	Microwave Cable	SUCOFLEX 104 (S_Cable 19)	316739	HUBER+SUHNER	2010/3/5	2011/3/4
WTSTW-SW 001	EMI TEST SOFTWARE	Harmonics-1000	None	EMC PARTNER	HARCS Version 4.16 Firmware Version 2.18	
WTSTW-SW 002	EMI TEST SOFTWARE	EZ EMC	None	Farad	Version ETS-03A1	



Worldwide Testing Services(Taiwan) Co., Ltd.

Registration number: W6M21009-10893-C-1

FCC ID: M5X-ACT202T

WTSTW-SW 003	EMS TEST SOFTWARE	i2	None	AUDIX	Version 3.2007-8-17b
WTSTW-SW 005	GSM Fading Level Correction	GSMFadLevCor	None	R&S	Version 1.66



Registration number: W6M21009-10893-C-1

FCC ID: M5X-ACT202T

2.4 General Test Procedure

POWER LINE CONDUCTED INTERFERENCE: The procedure used was ANSI STANDARD C63.4-2003 using a 50 μ H LISN (if necessary). Both lines were observed. The bandwidth of the spectrum analyzer was 10 kHz with an appropriate sweep speed.

RADIATION INTERFERENCE: The test procedure used was according to ANSI STANDARD C63.4-2003 employing a spectrum analyzer. For investigated frequency is equal to or below 1GHz, the RBW and VBW of the spectrum analyzer was 100 kHz and 100 kHz respectively with an appropriate sweep speed. For investigated frequency is above 1GHz, both of RBW and VBW of the spectrum analyzer were 1 MHz with an appropriate sweep speed. The analyzer was calibrated in dB above a microvolt at the output of the antenna. The ambient temperature of the UUT was 23°C with a humidity of 40 %.

The table used for radiated measurements is capable of continuous rotation. The spectrum was scanned from 30 MHz to the frequency specified as follows:

- (1) If the intentional radiator operates below 10 GHz: to the tenth harmonic of the highest fundamental frequency or to 40 GHz, whichever is lower.
- (2) If the intentional radiator operates at or above 10 GHz and below 30 GHz: to the fifth harmonic of the highest fundamental frequency or to 100 GHz, whichever is lower.
- (3) If the intentional radiator operates at or above 30 GHz: to the fifth harmonic of the highest fundamental frequency or to 200 GHz, whichever is lower, unless specified otherwise elsewhere in the rules.
- (4) If the intentional radiator contains a digital device, regardless of whether this digital device controls the functions of the intentional radiator or the digital device is used for additional control or function purposes other than to enable the operation of the intentional radiator, the frequency range shall be investigated up to the range specified in paragraphs (a)(1)-(a)(3) of this section or the range applicable to the digital device, as shown in paragraph (b)(1) of this Section, whichever is the higher frequency range of investigation.

For hand-held devices, a exploratory test was performed with three (3) orthogonal planes to determine the highest emissions.

Measurements were made by at the registered open field test site located at The Registration Number:

When an emission was found, the table was rotated to produce the maximum signal strength. At this point, the antenna was raised and lowered from 1m to 4m. The antenna was placed in both the horizontal and vertical planes.



Registration number: W6M21009-10893-C-1
 FCC ID: M5X-ACT202T

3 Test results (enclosure)

Test case	Para. Number	Required	Test passed	Test failed
RF Power Output	2.1046 (a); 74.861 (e)(1)	<input checked="" type="checkbox"/>	<input checked="" type="checkbox"/>	<input type="checkbox"/>
Modulation Deviation	2.1047 (b); 74.861 (e)(2)	<input checked="" type="checkbox"/>	<input checked="" type="checkbox"/>	<input type="checkbox"/>
Audio Frequency Response	2.1047 (a)	<input checked="" type="checkbox"/>	<input checked="" type="checkbox"/>	<input type="checkbox"/>
Occupied Bandwidth / Emission Mask	2.1049 (c)(1); 74.861 (e)(5)	<input checked="" type="checkbox"/>	<input checked="" type="checkbox"/>	<input type="checkbox"/>
Spurious Emissions at Antenna Terminals	2.1051 74.861(e)(6)	<input type="checkbox"/>	<input type="checkbox"/>	<input type="checkbox"/>
Radiated Spurious Emission	2.1053 74.861(e)(6)	<input checked="" type="checkbox"/>	<input checked="" type="checkbox"/>	<input type="checkbox"/>
Line Conducted Emissions	15.207	<input type="checkbox"/>	<input type="checkbox"/>	<input type="checkbox"/>
Frequency Stability vs. Temperature	2.1055 (b); 74.861(e)(4)	<input checked="" type="checkbox"/>	<input checked="" type="checkbox"/>	<input type="checkbox"/>
Frequency Stability vs. Voltage	2.1055 (a)(1); 74.861 (e)(4)	<input checked="" type="checkbox"/>	<input checked="" type="checkbox"/>	<input type="checkbox"/>

The follows is intended to leave blank.



Registration number: W6M21009-10893-C-1
 FCC ID: M5X-ACT202T

4 RF Power Output (conducted) , FCC 2.1046 (a) ; 74.861 (e)

4.1 Test procedure

This transmitter output was connected to a calibrated coaxial attenuator, the other end of which was connected to a spectrum analyzer. Transmitter output was derived with the spectrum analyzer in dBm. The power output at the transmitter antenna port was determined by assign the value of the attenuator to the spectrum analyzer reading.

An HP power meter was also used to measure the RF power.

Tests were performed with an un-modulated carrier at three frequencies (low , middle and high channels) and on all power levels , which can be set-up on the transmitters.

4.2 Test Results

Frequency Channel	Peak Output Power (dBm)
-- MHz	--
-- MHz	--
-- MHz	--

Limits:

LPAS operating in TV bands	
Frequency [MHz]	Conducted output power [mW]
54 – 72 76 – 88 174 - 216	50 (17 dBm)
470 – 608 614 - 806	250 (24 dBm)

LPAS operating in other than TV bands	
Conducted power [W]	1

Test equipment used: ETSTW-RE 055

Explanation :This test is not required.

5 Radiated Power

5.1 Test Procedure

The EUT was positioned on a non-conductive turntable, 0.8m above the ground on an open test site. The radiated emission at the fundamental frequency was measured at 3m distance with a test antenna and spectrum analyzer.

Worst case emission was recorded with the rotation of the turntable and the raising and lowering of the test antenna.

Substitution RF power Measurement at WTS

General :

The applied substitution method follows ANSI/TIA/EIA-603, ANSI/TIA/EIA-102.CAAA or the appropriate ETSI rules respectively.

The actual signal generated by the EUT can be determined by means of a substitution measurement in which a known signal source replaces the device to be measured.

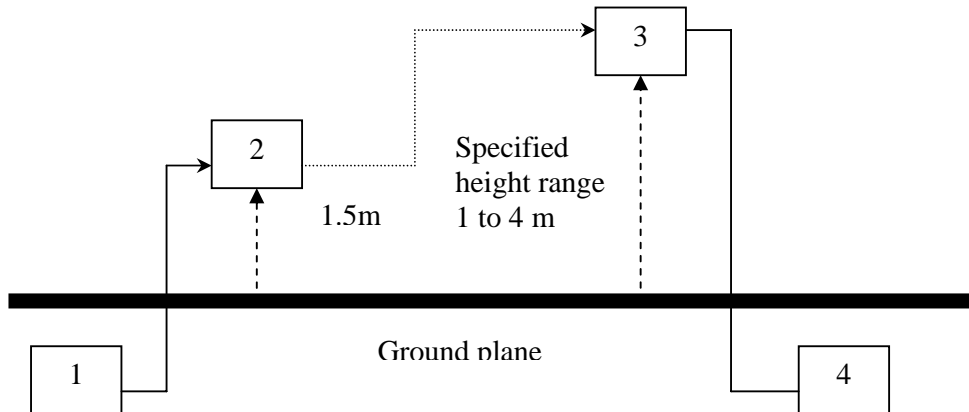

- 1) Signal generator ;
- 2) Substitution antenna ;
- 3) Test antenna ;
- 4) Spectrum analyzer or selective voltmeter.

The substitution antenna replaces the transmitter antenna at the same position and in vertical polarization. The frequency of the signal generator shall be adjusted to the measurement frequency.

The test antenna shall be raised or lowered, if necessary, to ensure that the maximum signal is still received. The input signal to the substitution antenna shall be adjusted in level until an equal or a known related level to that detected from the transmitter is obtained in the measurement receiver.

If a fully anechoic chamber is used as test site in order to provide free space conditions there is no need to change the height of the antenna.

The measurement will be repeated in horizontal position.



Worldwide Testing Services(Taiwan) Co., Ltd.

Registration number: W6M21009-10893-C-1
 FCC ID: M5X-ACT202T

Calibration :

In order to make this kind of measurement more effective and to avoid subjective measurement faults WTS has installed automatic computer controlled measurement procedures.

With the above described substitution method a test site is calibrated over the full frequency range which is used in suitable frequency steps. For a certain power level on the substitution antenna the received power over the whole frequency range is documented. All necessary antenna gains, cable losses, filter losses and amplifications of preamplifiers are taken in consideration. The summary of this calibration measurement performs a transducer factor that is related to the considered test site and a certain measurement distance. Differences of the radiated power levels of different test samples are determined by internal attenuation of measurement receiver . The proper function of such test site will be maintained by short term plausibility checks and periodical re-calibration.

Testing :

Now the test sample will be putted on the table at the defined position and the radiated power will be receiver and documented by the measurement receiver.

On test sites with ground plane the measurement antenna will be lowered and raised to maximum values at significant frequencies.

For peak power measurements the sample is turned by the turntable over 360 degree in order to find the direction with the maximum radiation or to document the max reading with the MAXHOLD function during the rotation.

5.2 Test results

Model: ACT-202T Date: 2010/9/30
 Mode: 506.1MHz Temperature: 24 °C Engineer: Kevin
 Polarization: Horizontal Humidity: 60 %

Frequency (MHz)	Reading (dBm) Peak	Factor (dB) Corr.	Result (dBm)	Limit (dBm)	Margin (dB)	Table Degree (Deg.)	Ant. High (cm)
506.1025	-38.54	28.57	-9.97	24.00	-33.97	160	150

Polarization: Vertical

Frequency (MHz)	Reading (dBm) Peak	Factor (dB) Corr.	Result (dBm)	Limit (dBm)	Margin (dB)	Table Degree (Deg.)	Ant. High (cm)
506.0975	-22.87	29.50	6.63	24.00	-17.37	200	150

Mode: 518.0MHz
 Polarization: Horizontal

Frequency (MHz)	Reading (dBm) Peak	Factor (dB) Corr.	Result (dBm)	Limit (dBm)	Margin (dB)	Table Degree (Deg.)	Ant. High (cm)
517.9975	-36.09	29.48	-6.61	24.00	-30.61	200	150



Worldwide Testing Services(Taiwan) Co., Ltd.

Registration number: W6M21009-10893-C-1

FCC ID: M5X-ACT202T

Polarization: Vertical

Frequency (MHz)	Reading (dBm) Peak	Factor (dB) Corr.	Result (dBm)	Limit (dBm)	Margin (dB)	Table Degree (Deg.)	Ant. High (cm)
518.0005	-19.70	29.42	9.72	24.00	-14.28	120	150

Mode: 529.9MHz

Polarization: Horizontal

Frequency (MHz)	Reading (dBm) Peak	Factor (dB) Corr.	Result (dBm)	Limit (dBm)	Margin (dB)	Table Degree (Deg.)	Ant. High (cm)
529.9025	-33.54	30.54	-3.00	24.00	-27.00	130	150

Polarization: Vertical

Frequency (MHz)	Reading (dBm) Peak	Factor (dB) Corr.	Result (dBm)	Limit (dBm)	Margin (dB)	Table Degree (Deg.)	Ant. High (cm)
529.8945	-19.58	29.41	9.83	24.00	-14.17	210	150

Mode: 614.1MHz

Polarization: Horizontal

Frequency (MHz)	Reading (dBm) Peak	Factor (dB) Corr.	Result (dBm)	Limit (dBm)	Margin (dB)	Table Degree (Deg.)	Ant. High (cm)
614.0944	-38.46	32.93	-5.53	24.00	-29.53	260	150

Polarization: Vertical

Frequency (MHz)	Reading (dBm) Peak	Factor (dB) Corr.	Result (dBm)	Limit (dBm)	Margin (dB)	Table Degree (Deg.)	Ant. High (cm)
614.1045	-21.21	30.06	8.85	24.00	-15.15	210	150

Mode: 655.5MHz

Polarization: Horizontal

Frequency (MHz)	Reading (dBm) Peak	Factor (dB) Corr.	Result (dBm)	Limit (dBm)	Margin (dB)	Table Degree (Deg.)	Ant. High (cm)
655.5055	-40.13	32.65	-7.48	24.00	-31.48	200	150

Polarization: Vertical

Frequency (MHz)	Reading (dBm) Peak	Factor (dB) Corr.	Result (dBm)	Limit (dBm)	Margin (dB)	Table Degree (Deg.)	Ant. High (cm)
655.5045	-25.56	32.18	6.62	24.00	-17.38	190	150



Worldwide Testing Services(Taiwan) Co., Ltd.

Registration number: W6M21009-10893-C-1

FCC ID: M5X-ACT202T

Mode: 697.9MHz

Polarization: Horizontal

Frequency (MHz)	Reading (dBm) Peak	Factor (dB) Corr.	Result (dBm)	Limit (dBm)	Margin (dB)	Table Degree (Deg.)	Ant. High (cm)
697.8985	-37.28	32.70	-4.58	24.00	-28.58	260	150

Polarization: Vertical

Frequency (MHz)	Reading (dBm) Peak	Factor (dB) Corr.	Result (dBm)	Limit (dBm)	Margin (dB)	Table Degree (Deg.)	Ant. High (cm)
697.9045	-24.95	33.50	8.55	24.00	-15.45	250	150

Test equipment used: ETSTW-RE 003, ETSTW-RE 004, ETSTW-RE 021, ETSTW-RE 028, ETSTW-RE 029

Explanation: Please see attached diagrams as appendix.



Registration number: W6M21009-10893-C-1

FCC ID: M5X-ACT202T

6 Modulation Deviation , FCC 2.1047 (b) ; 74.861(e)

6.1 Test procedure

Modulation limiting is the transmitter circuit’s ability to limit the transmitter from producing deviations in excess of rated system deviation.

The audio signal generator is connected to the audio input of the EUT with its full rating.

The modulation response is measured at certain modulation frequencies, related to 1000Hz reference signal. Tests are performed for positive and negative modulation.

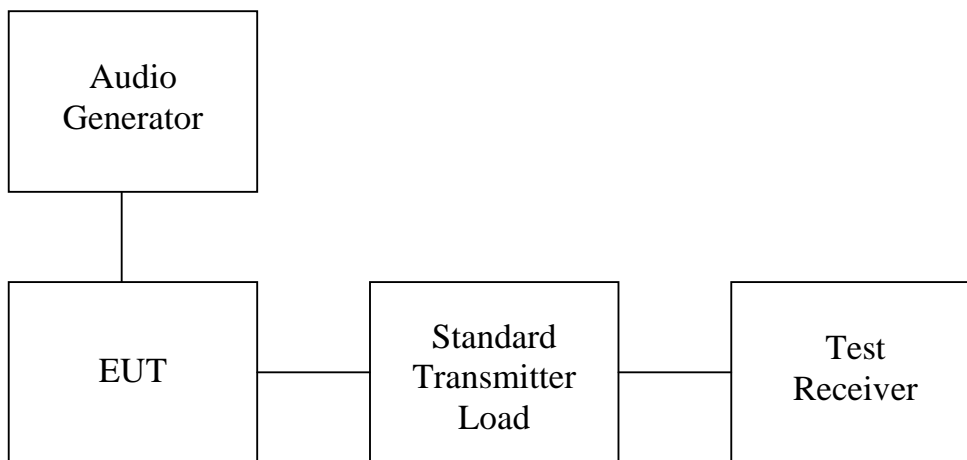

6.2 Test results

Explanation: Please see attached diagrams as appendix.

Limits : ± 75 kHz

Test equipment used: ETSTW-RE 002, ETSTW-RE 055



Registration number: W6M21009-10893-C-1

FCC ID: M5X-ACT202T

7 Audio frequency response , FCC 2.1047 (a)

7.1 Test procedure

The audio frequency response is the degree of closeness to which the frequency deviation of the transmitter follows a prescribed characteristic.

The frequency response of the audio modulation part is measured over a frequency range of 100 Hz to 5000 Hz.

For 1000 Hz tone reference signal the audio generator level is adjusted to get 20% of the rated system deviation.

The deviations obtained over the frequency range from 100 Hz to 5000 Hz are recorded and compared with the reference deviation as follows :

$$\text{Audio Frequency Response} = 20 \log [\text{DEV}_{\text{Freq}} / \text{DEV}_{\text{ref}}].$$

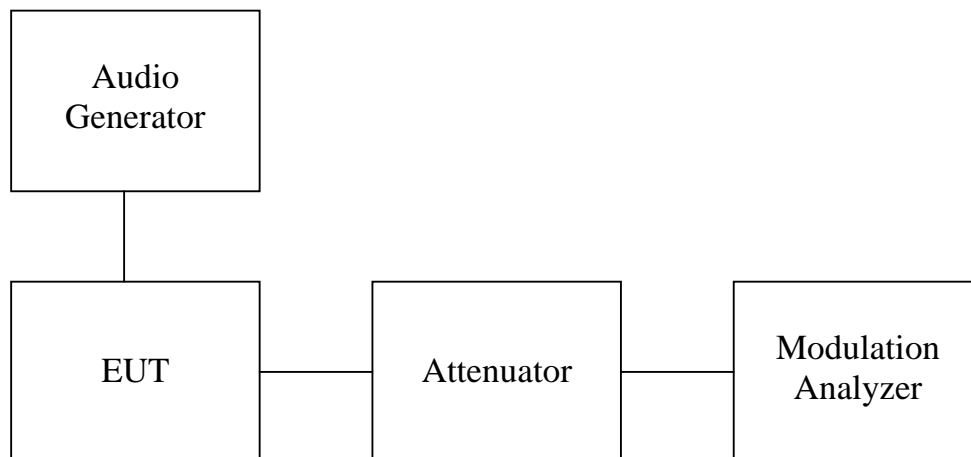

7.2 Test results

Explanation: Please see attached diagrams as appendix.

Test equipment used: ETSTW-RE 002



Registration number: W6M21009-10893-C-1

FCC ID: M5X-ACT202T

8 Occupied Bandwidth/Emission Mask, FCC 2.1049 (c) ; 74.861 (e)(5)

The occupied bandwidth, that is the frequency bandwidth such that, below its lower and above its upper frequency limits, the mean powers radiated are each equal to 0.5 percent of the total mean power. Near the carrier an Emission Mask is defined by the standard.

8.1 Test procedure

The RF output of the transceiver was connected to the input of the spectrum analyzer through sufficient attenuation.

Occupied Bandwidth was measured with a occupied bandwidth function of the analyzer.

The near the carrier emissions are measured by normal power measurement function of the analyzer.

8.2 Test Results

1000 Hz Modulation

Occupied Channel Bandwidth (kHz)	
Channel A	136.217948718 kHz
Channel B	135.416666667 kHz
Channel C	135.416666667 kHz
Channel D	141.025641026 kHz
Channel E	147.435897436 kHz
Channel F	154.647435897 kHz

2500 Hz Modulation

Occupied Channel Bandwidth (kHz)	
Channel A	164.262820513 kHz
Channel B	163.461538462 kHz
Channel C	164.262820513 kHz
Channel D	169.871794872 kHz
Channel E	177.884615385 kHz
Channel F	185.897435897 kHz

Test equipment used: ETSTW-RE 055

Explanation : Please see attached diagram as appendix .



Registration number: W6M21009-10893-C-1

FCC ID: M5X-ACT202T

9 Spurious Emissions at Antenna Terminals FCC2.1051 ; 74.861 (e)

9.1 Test procedure

This transmitter output was connected to a calibrated coaxial attenuator, the other end of which was connected to a spectrum analyzer. Transmitter output was derived with the spectrum analyzer in dBm.

The Spurious Emissions at Antenna Terminals was measured by the spectrum analyzer with a suitable notch filter and high-pass filter.

Tests were performed with an un-modulated carrier at three frequencies (low , middle and high channels) and on all power levels , which can be set-up on the transmitters.

9.2 Test Results

Summary table with conducted data of the test plots for Carrier Test Frequency

Frequency Marker Indication [MHz]	Indication Power Level [dBm]	Compliance Limit [dBm]	Margin
--	--	--	--
--	--	--	--

9.3 Limit

Compliance with § 74.861 requires that any emission be attenuated below the transmitter power at least $43 + 10 \log_{10} P$ (P = transmitter power in Watts).

The compliance limit was calculated as an example per the following table :

Maximum transmitter output power	9.83 dBm
Required attenuation	$43 + 10 \log_{10} 0.009616 \text{ W} = 22.83 \text{ dB}$
Maximum transmitter output power	9.83 dBm
<u>Required attenuation</u>	<u>22.83 dB</u>
Compliance limit	-13 dBm

Test equipment used: ETSTW-RE 055

Explanation : This test is not applicable.



Worldwide Testing Services(Taiwan) Co., Ltd.

Registration number: W6M21009-10893-C-1

FCC ID: M5X-ACT202T

10 Radiated Spurious Emission , FCC 2.1053 ; 74.861 (e)

10.1 Test procedure

The EUT was positioned on a non-conductive turntable , 0.8m above the ground plane.

The radiated emission at the fundamental frequency was measured at 3 m distance with a test antenna and spectrum analyzer.

Worst case emission was recorded with the rotation of the turntable and the raising and lowering of the test antenna.

ERP was measured using a substitution method. The EUT was replaced by reference antenna connected to a signal generator.

The test of spurious radiated emission have been carried out with the ESK-Software from Rode & Schwarz. The measurements below 1GHz were performed with a measurement bandwidth of 100kHz, above 1GHz with a bandwidth of 1 MHz.

Spurious emission limits near the carrier are defined by a emission mask. This measurements are done in conducted mode.

10.2 Test Results

The measurements of the spurious emission at the upper , center and lower channel.

The measurement diagrams show that all significant spurs are well below the limit line.

Model: ACT-202T Date: 2010/10/1
 Mode: 506.1MHz Temperature: 24 °C Engineer: Kevin
 Polarization: Horizontal Humidity: 60 %

Frequency (MHz)	Reading (dBm) Peak	Factor (dB) Corr.	Result (dBm)	Limit (dBm)	Margin (dB)	Table Degree (Deg.)	Ant. High (cm)
285.3908	-101.71	29.68	-72.03	-13.00	-59.03	100	150
297.8356	-103.57	31.47	-72.10	-13.00	-59.10	250	150
396.7937	-65.62	-7.48	-73.10	-13.00	-60.10	210	150
879.3586	-73.18	0.06	-73.12	-13.00	-60.12	110	150
1012.0240	-36.92	-0.47	-37.39	-13.00	-24.39	260	150
1517.0340	-56.90	2.89	-54.01	-13.00	-41.01	140	150

Polarization: Vertical

Frequency (MHz)	Reading (dBm) Peak	Factor (dB) Corr.	Result (dBm)	Limit (dBm)	Margin (dB)	Table Degree (Deg.)	Ant. High (cm)
292.4248	-102.28	32.79	-69.49	-13.00	-56.49	260	150
298.3768	-105.11	35.06	-70.05	-13.00	-57.05	170	150
687.1743	-75.12	-1.72	-76.84	-13.00	-63.84	260	150
879.3586	-73.46	-0.29	-73.75	-13.00	-60.75	130	150
1012.0240	-31.34	0.40	-30.94	-13.00	-17.94	180	150
1517.0340	-52.18	3.04	-49.14	-13.00	-36.14	210	150



Worldwide Testing Services(Taiwan) Co., Ltd.

Registration number: W6M21009-10893-C-1

FCC ID: M5X-ACT202T

Mode: 518.0MHz Temperature: 24 °C Engineer: Kevin
 Polarization: Horizontal Humidity: 60 %

Frequency (MHz)	Reading (dBm) Peak	Factor (dB) Corr.	Result (dBm)	Limit (dBm)	Margin (dB)	Table Degree (Deg.)	Ant. High (cm)
79.2386	-101.83	25.66	-76.17	-13.00	-63.17	210	150
285.3908	-101.62	29.68	-71.94	-13.00	-58.94	160	150
396.7937	-65.08	-7.48	-72.56	-13.00	-59.56	240	150
678.7576	-72.05	-2.23	-74.28	-13.00	-61.28	130	150
1036.0720	-34.15	0.30	-33.85	-13.00	-20.85	100	150
1553.1060	-56.98	2.47	-54.51	-13.00	-41.51	200	150

Polarization: Vertical

Frequency (MHz)	Reading (dBm) Peak	Factor (dB) Corr.	Result (dBm)	Limit (dBm)	Margin (dB)	Table Degree (Deg.)	Ant. High (cm)
68.9580	-98.80	23.61	-75.19	-13.00	-62.19	220	150
298.3768	-104.72	35.06	-69.66	-13.00	-56.66	160	150
712.4248	-75.28	-1.68	-76.96	-13.00	-63.96	210	150
922.8456	-74.98	0.06	-74.92	-13.00	-61.92	300	150
1036.0720	-25.58	1.03	-24.55	-13.00	-11.55	100	150
1553.1060	-52.10	2.63	-49.47	-13.00	-36.47	210	150

Mode: 529.9MHz Temperature: 24 °C Engineer: Kevin
 Polarization: Horizontal Humidity: 60 %

Frequency (MHz)	Reading (dBm) Peak	Factor (dB) Corr.	Result (dBm)	Limit (dBm)	Margin (dB)	Table Degree (Deg.)	Ant. High (cm)
77.6153	-104.05	25.45	-78.60	-13.00	-65.60	160	150
262.6653	-104.42	31.64	-72.78	-13.00	-59.78	200	150
396.7937	-65.31	-7.48	-72.79	-13.00	-59.79	160	150
994.3887	-74.75	0.33	-74.42	-13.00	-61.42	110	150
1054.1080	-35.47	0.87	-34.60	-13.00	-21.60	140	150
1589.1780	-59.11	2.06	-57.05	-13.00	-44.05	200	150

Polarization: Vertical

Frequency (MHz)	Reading (dBm) Peak	Factor (dB) Corr.	Result (dBm)	Limit (dBm)	Margin (dB)	Table Degree (Deg.)	Ant. High (cm)
78.6975	-97.66	25.28	-72.38	-13.00	-59.38	200	150
293.5070	-103.22	33.20	-70.02	-13.00	-57.02	100	150
816.2323	-75.49	-2.13	-77.62	-13.00	-64.62	210	150
984.5691	-74.32	-0.52	-74.84	-13.00	-61.84	170	150
1054.1080	-30.69	1.51	-29.18	-13.00	-16.18	240	150
1589.1780	-51.82	2.21	-49.61	-13.00	-36.61	160	150



Worldwide Testing Services(Taiwan) Co., Ltd.

Registration number: W6M21009-10893-C-1

FCC ID: M5X-ACT202T

Mode: 614.1MHz Temperature: 24 °C Engineer: Kevin
Polarization: Horizontal Humidity: 60 %

Frequency (MHz)	Reading (dBm) Peak	Factor (dB) Corr.	Result (dBm)	Limit (dBm)	Margin (dB)	Table Degree (Deg.)	Ant. High (cm)
76.5331	-103.34	25.31	-78.03	-13.00	-65.03	200	150
262.6653	-103.86	31.64	-72.22	-13.00	-59.22	130	150
684.3686	-74.09	-2.24	-76.33	-13.00	-63.33	280	150
995.7916	-75.60	0.39	-75.21	-13.00	-62.21	160	150
1228.4570	-54.60	1.50	-53.10	-13.00	-40.10	200	150
1709.4190	-60.79	6.00	-54.79	-13.00	-41.79	130	150

Polarization: Vertical

Frequency (MHz)	Reading (dBm) Peak	Factor (dB) Corr.	Result (dBm)	Limit (dBm)	Margin (dB)	Table Degree (Deg.)	Ant. High (cm)
78.6975	-94.68	25.28	-69.40	-13.00	-56.40	100	150
298.3768	-104.64	35.06	-69.58	-13.00	-56.58	200	150
696.9940	-75.11	-1.46	-76.57	-13.00	-63.57	190	150
938.2766	-75.32	-0.16	-75.48	-13.00	-62.48	120	150
1228.4570	-40.91	0.84	-40.07	-13.00	-27.07	160	150
1841.6830	-58.44	3.28	-55.16	-13.00	-42.16	140	150

Mode: 655.5MHz Temperature: 24 °C Engineer: Kevin
Polarization: Horizontal Humidity: 60 %

Frequency (MHz)	Reading (dBm) Peak	Factor (dB) Corr.	Result (dBm)	Limit (dBm)	Margin (dB)	Table Degree (Deg.)	Ant. High (cm)
73.8276	-101.29	24.95	-76.34	-13.00	-63.34	210	150
264.2885	-103.81	31.38	-72.43	-13.00	-59.43	130	150
396.7937	-65.92	-7.48	-73.40	-13.00	-60.40	110	150
678.7576	-72.49	-2.23	-74.72	-13.00	-61.72	170	150
1306.6130	-58.15	3.06	-55.09	-13.00	-42.09	260	150
1709.4190	-61.13	6.00	-55.13	-13.00	-42.13	140	150

Polarization: Vertical

Frequency (MHz)	Reading (dBm) Peak	Factor (dB) Corr.	Result (dBm)	Limit (dBm)	Margin (dB)	Table Degree (Deg.)	Ant. High (cm)
78.1564	-98.04	25.17	-72.87	-13.00	-59.87	160	150
254.0080	-104.08	29.83	-74.25	-13.00	-61.25	210	150
928.4570	-74.76	-0.02	-74.78	-13.00	-61.78	130	150
990.1803	-73.92	-0.55	-74.47	-13.00	-61.47	270	150
1306.6130	-55.60	3.18	-52.42	-13.00	-39.42	130	150
1721.4430	-60.80	4.70	-56.10	-13.00	-43.10	210	150



Worldwide Testing Services(Taiwan) Co., Ltd.

Registration number: W6M21009-10893-C-1

FCC ID: M5X-ACT202T

Mode: 697.9MHz Temperature: 24 °C Engineer: Kevin
 Polarization: Horizontal Humidity: 60 %

Frequency (MHz)	Reading (dBm) Peak	Factor (dB) Corr.	Result (dBm)	Limit (dBm)	Margin (dB)	Table Degree (Deg.)	Ant. High (cm)
78.1564	-102.12	25.52	-76.60	-13.00	-63.60	160	150
285.3908	-101.93	29.68	-72.25	-13.00	-59.25	170	150
396.7937	-65.34	-7.48	-72.82	-13.00	-59.82	280	150
678.7576	-71.80	-2.23	-74.03	-13.00	-61.03	110	150
1366.7340	-61.22	2.73	-58.49	-13.00	-45.49	280	150
1709.4190	-61.13	6.00	-55.13	-13.00	-42.13	130	150

Polarization: Vertical

Frequency (MHz)	Reading (dBm) Peak	Factor (dB) Corr.	Result (dBm)	Limit (dBm)	Margin (dB)	Table Degree (Deg.)	Ant. High (cm)
75.4510	-99.35	24.63	-74.72	-13.00	-61.72	210	150
285.3908	-103.06	30.11	-72.95	-13.00	-59.95	300	150
718.0361	-75.53	-1.81	-77.34	-13.00	-64.34	210	150
918.6372	-75.46	0.12	-75.34	-13.00	-62.34	140	150
1390.7820	-56.41	1.16	-55.25	-13.00	-42.25	260	150
1793.5870	-60.28	3.18	-57.10	-13.00	-44.10	130	150

- Note:**
1. Correction Factor = Antenna Gain + Cable Loss + Amplifier Gain
 2. The formula of measured value as: Test Result = Reading + Correction Factor
 3. Detector function in the form : PK = Peak, AV = Average
 4. All not in the table noted test results are more than 20 dB below the relevant limits.
 5. See the attached diagram as appendix.



Registration number: W6M21009-10893-C-1

FCC ID: M5X-ACT202T

10.3 Explanation of test result

The measurements of the spurious emissions at the equipment output terminals were performed pursuant to the test procedure above in order to verify that any emissions are below the limits given by § 74.861 (6).

Calculation of test results :

Such factors like antenna correction , cable loss , external attenuation etc. are already included in the provided measurement results. This is done by using validated test software and calibrated test system according the accreditation requirements.

In the Table being listed the critical peak and average value an exhibit the compliance with the above calculated Limits.

10.4 Limits

Compliance with § 74.861 requires that any emission be attenuated below the transmitter power at least $43 + 10 \log_{10} P$ (P = transmitter power in Watts).

The compliance limit was calculated as an example per the following table :

Maximum transmitter output power	9.83 dBm
Required attenuation	$43 + 10 \log_{10} 0.009616 \text{ W} = 22.83 \text{ dB}$
Maximum transmitter output power	9.83 dBm
<u>Required attenuation</u>	<u>22.83 dB</u>
Compliance limit	-13 dBm

Test equipment used: ETSTW-RE 003, ETSTW-RE 004, ETSTW-RE 021, ETSTW-RE 028, ETSTW-RE 029, ETSTW-RE 030, ETSTW-RE 044

Explanation : See attached diagrams in appendix.



Registration number: W6M21009-10893-C-1

FCC ID: M5X-ACT202T

11 Line Conducted Emission , FCC 15.207

11.1 Test procedure

For an intentional radiator which is designed to be connected to the public utility (AC) power line, the radio frequency voltage that is conducted back onto the AC line on any frequency or frequencies within the band 150 kHz to 30 MHz shall not exceed the limits in the table bellows with this provision shall be based on the measurement of the radio frequency voltage between each power line and ground at the power terminals.

This measurement was transact first with instrumentation using an average and peak detector and a 10 kHz bandwidth. If the peak detector achieves a calculated level, the measurement is repeated by an instrumentation using a quasi-peak detector.

11.2 Test Results

Frequency	Max. Level (dB μ V)	
	quasi-peak	average
-- kHz	--	--

Limits:

Frequency of Emission (MHz)	Conducted Limit (dB μ V)	
	Quasi Peak	Average
0.15-0.5	66 to 56	56 to 46
0.5-5	56	46
5-30	60	50

Test equipment used: ETSTW-CE 001, ETSTW-CE 004, ETSTW-CE 006

Explanation: The transmitter of EUT is battery used, so this test is not required.



Registration number: W6M21009-10893-C-1

FCC ID: M5X-ACT202T

12 Frequency Stability vs. Temperature , FCC 2.1055 , 74.861 (e)

12.1 Test procedure

The equipment under test was connected to an external DC power supply and the RF output was connected to a frequency counter via feed through attenuators. The EUT was placed inside the temperature chamber. The DC leads and RF output cable, exited the chamber through an opening made for that purpose.

After the temperature stabilized the frequency output was recorded from the counter.

12.2 Test Results

506.1 MHz

°C	Frequency Error (kHz)	Frequency Error (ppm)
-30	3.557	7.029
-20	4.474	8.841
-10	4.317	8.529
0	4.795	9.475
10	2.987	5.902
20	1.456	2.877
30	-0.870	-1.720
40	-1.908	-3.770
50	-4.716	-9.318

25°C: 506.099688 MHz

Limit: 25.305 kHz(±0.005%)

518.0 MHz

°C	Frequency Error (kHz)	Frequency Error (ppm)
-30	3.444	6.649
-20	3.883	7.496
-10	5.003	9.657
0	3.022	5.834
10	0.887	1.711
20	1.327	2.563
30	0.340	0.656
40	-2.355	-4.546
50	-4.166	-8.042

25°C: 518.000212 MHz

Limit: 25.90 kHz(±0.005%)



Worldwide Testing Services(Taiwan) Co., Ltd.

Registration number: W6M21009-10893-C-1

FCC ID: M5X-ACT202T

529.9 MHz

°C	Frequency Error (kHz)	Frequency Error (ppm)
-30	3.525	6.652
-20	4.487	8.468
-10	4.487	8.468
0	4.166	7.862
10	1.923	3.629
20	0.641	1.210
30	-0.321	-0.606
40	-2.885	-5.444
50	-4.488	-8.470

25°C: 529.900000 MHz

Limit: 26.495 kHz(±0.005%)

614.1 MHz

°C	Frequency Error (kHz)	Frequency Error (ppm)
-30	2.918	4.751
-20	5.811	9.463
-10	4.344	7.073
0	4.665	7.597
10	3.202	5.214
20	1.016	1.654
30	-0.920	-1.499
40	-3.500	-5.700
50	-4.345	-7.075

25°C: 614.099655 MHz

Limit: 30.705 kHz(±0.005%)

655.5 MHz

°C	Frequency Error (kHz)	Frequency Error (ppm)
-30	2.701	4.120
-20	3.572	5.449
-10	4.250	6.483
0	2.902	4.427
10	0.313	0.478
20	0.188	0.287
30	-0.853	-1.302
40	-4.668	-7.121
50	-4.531	-6.912



Worldwide Testing Services(Taiwan) Co., Ltd.

Registration number: W6M21009-10893-C-1

FCC ID: M5X-ACT202T

25°C: 655.500783 MHz

Limit: 32.775 kHz(±0.005%)

697.9 MHz

°C	Frequency Error (kHz)	Frequency Error (ppm)
-30	3.797	5.440
-20	4.127	5.914
-10	4.666	6.686
0	4.051	5.804
10	1.515	2.171
20	0.759	1.088
30	0.000	0.000
40	-3.003	-4.303
50	-3.355	-4.807

25°C: 697.899568 MHz

Limit: 34.895 kHz(±0.005%)

Test equipment used: ETSTW-RE 055, ETSTW-CE 009



Registration number: W6M21009-10893-C-1

FCC ID: M5X-ACT202T

13 Frequency Stability vs. Voltage , FCC 2.1055 (d) ; 74.861 (e)

13.1 Test procedure

An external variable DC power supply was connected to the battery terminals of the equipment under test.

For hand carried , battery powered equipment primary supply voltage was reduced to the battery operating end point as specified by the manufacturer. The output frequency was recorded for each battery voltage.

13.2 Test Results

Frequency in Normal Condition (MHz)	Frequency in battery operating end point (MHz)	Frequency Error (kHz)	Frequency Error (ppm)
506.099688	506.099535	-0.153	-0.303
518.000212	517.999030	-1.182	-2.282
529.900000	529.900000	0.000	0.000
614.099655	614.100140	0.485	0.790
655.500783	655.499148	-1.635	-2.494
697.899568	697.900855	1.287	1.844

Limit : $\pm 0.005\%$

Test equipment used: ETSTW-RE 055



Appendix

A. Measurement diagrams

1. RF Power Output
2. Modulation Deviation and Audio frequency response
3. Occupied Bandwidth / Emission Mask
4. Spurious Emissions at Antenna Terminals
(This test is not applicable)
5. Radiation Spurious Emission
6. Line Conducted Emissions
(This is not required the sample is battery used.)
7. Frequency Stability vs. Temperature
No diagrams
Refer to point 12.2
8. Frequency Stability vs. Voltage
No diagrams
Refer to point 13.2

B. Photos

1. External Photos
2. Internal Photos
3. Set Up Photo of Radiated Emission



Registration number: W6M21009-10893-C-1

FCC ID: M5X-ACT202T

RF Power Output

506.1 MHz

Antenna Polarization H

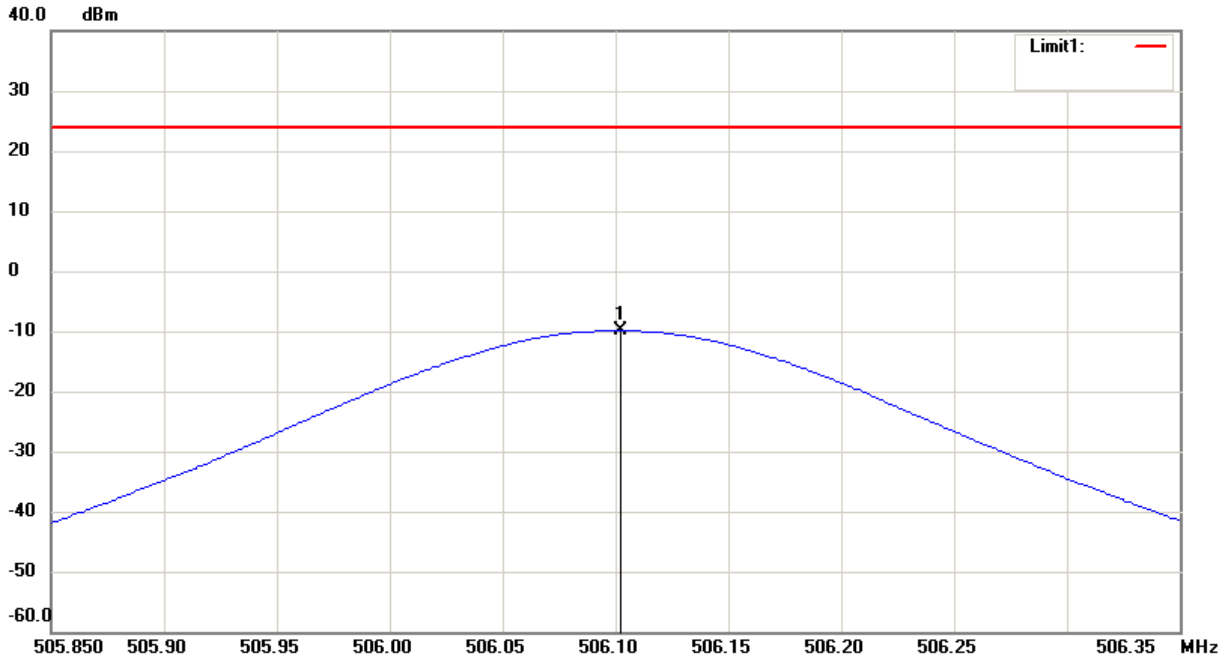

Antenna Polarization V

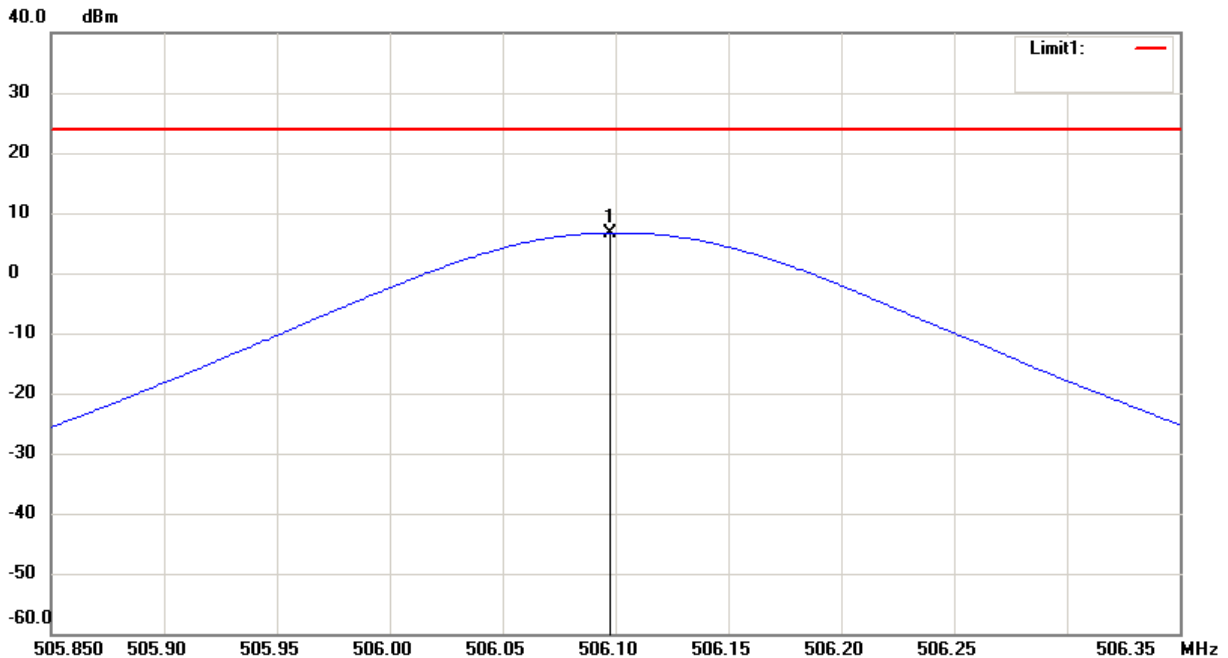

Note:

1. The attached measurement plots are preliminarily pre-scanned with peak detector for determining the final checking frequencies and are for reference only.
2. The some frequencies may exceed the limit line without the specified detectors, but that cannot present the results are failed to the specification of test standard.
3. For corrected test results are listed in the relevant table of radiated power test data of this test report.



Registration number: W6M21009-10893-C-1

FCC ID: M5X-ACT202T

518.0 MHz

Antenna Polarization H

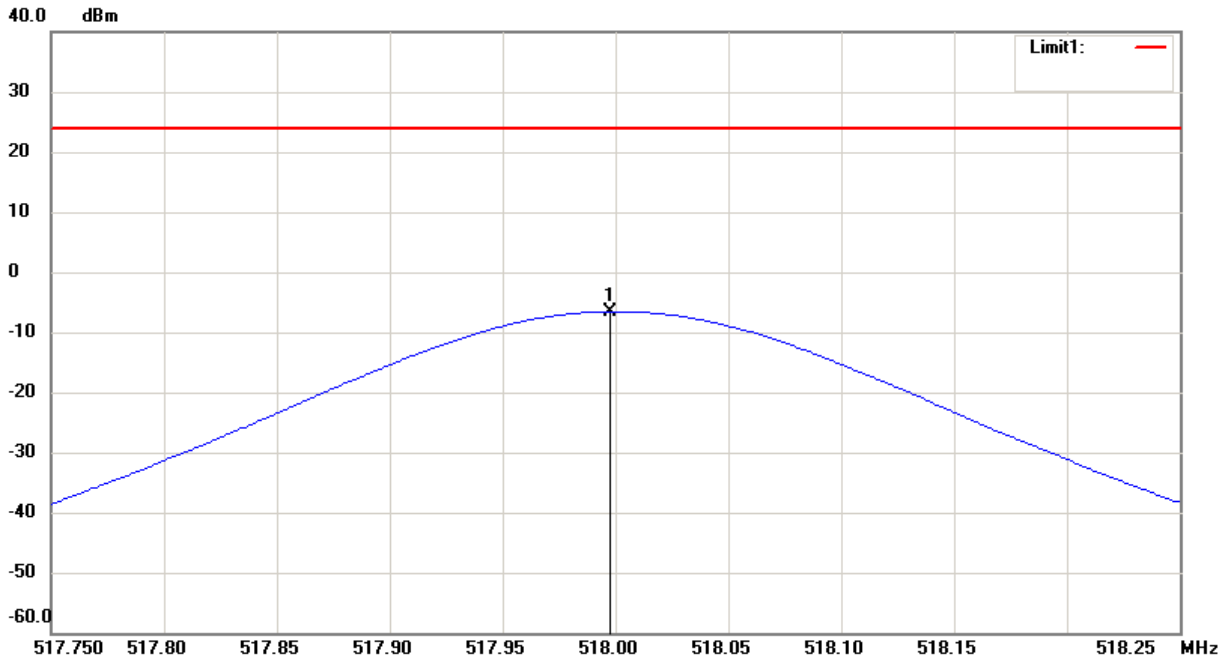

Antenna Polarization V

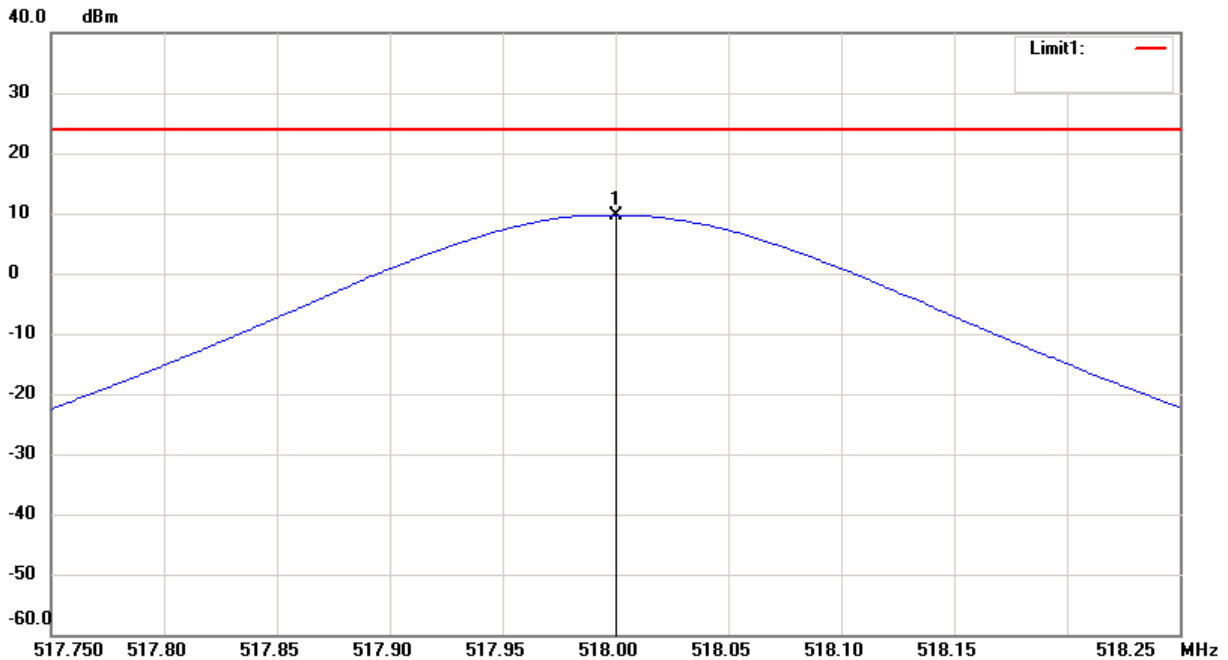

Note:

1. The attached measurement plots are preliminarily pre-scanned with peak detector for determining the final checking frequencies and are for reference only.
2. The some frequencies may exceed the limit line without the specified detectors, but that cannot present the results are failed to the specification of test standard.
3. For corrected test results are listed in the relevant table of radiated power test data of this test report.



Registration number: W6M21009-10893-C-1

FCC ID: M5X-ACT202T

529.9 MHz

Antenna Polarization H

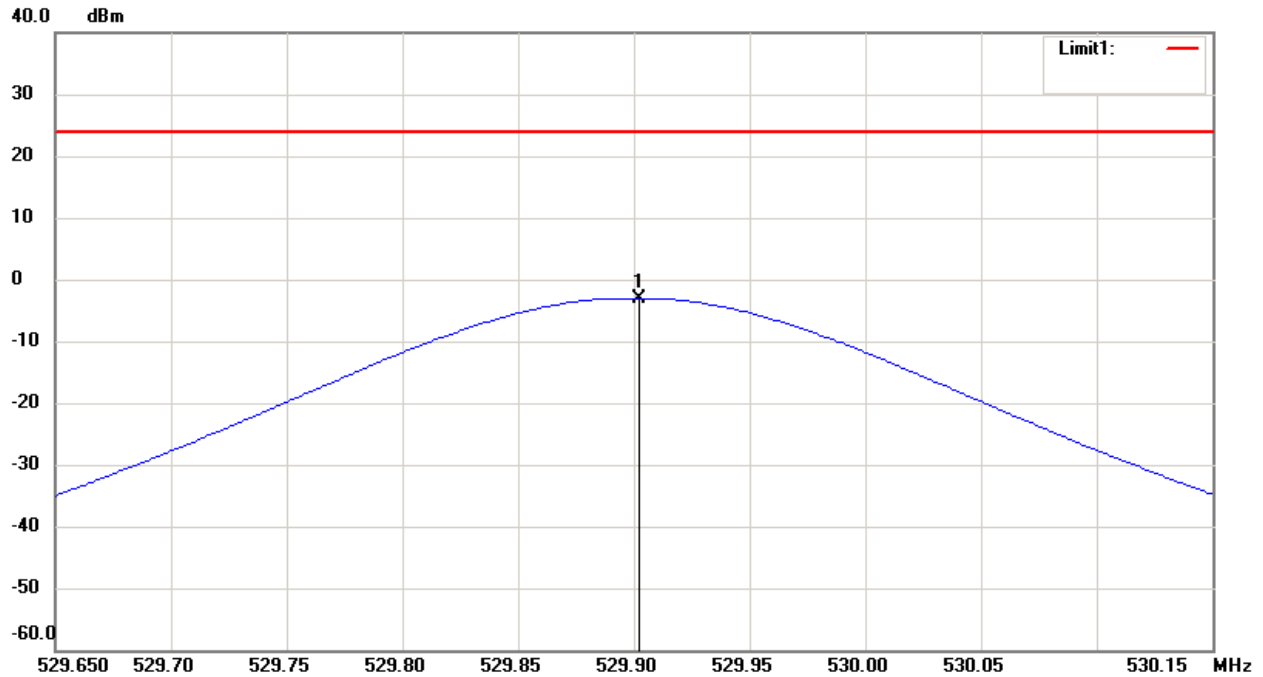

Antenna Polarization V

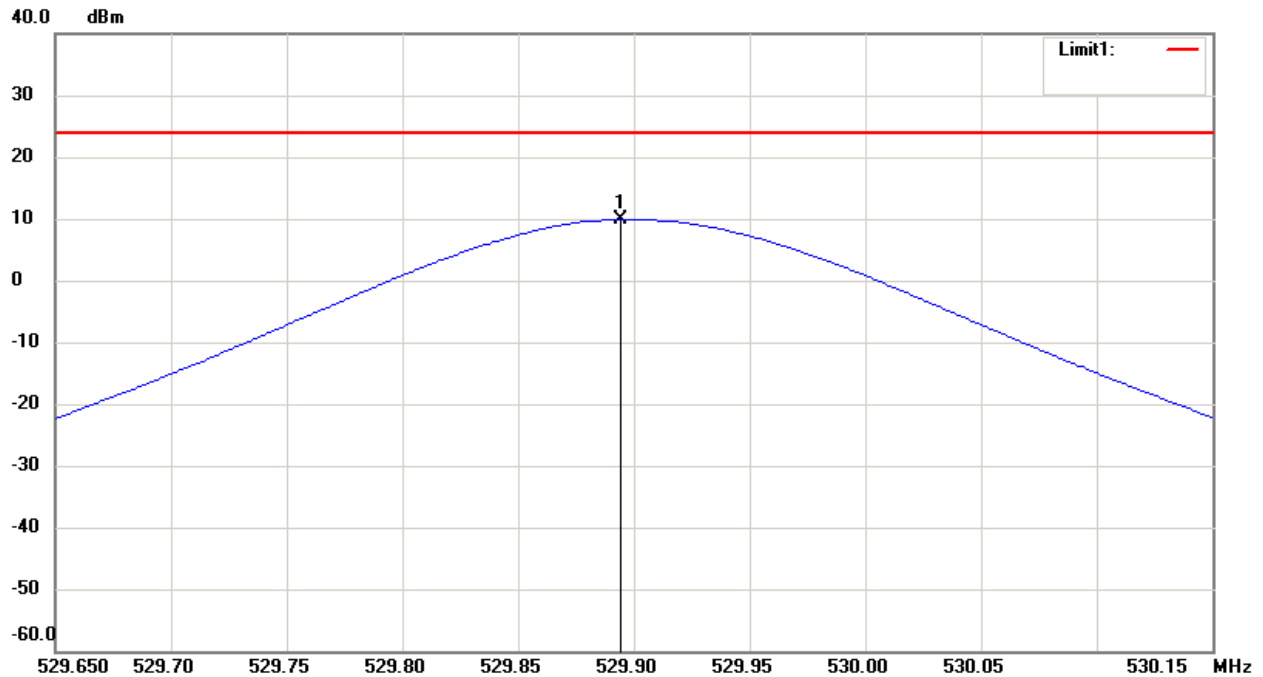

Note:

1. The attached measurement plots are preliminarily pre-scanned with peak detector for determining the final checking frequencies and are for reference only.
2. The some frequencies may exceed the limit line without the specified detectors, but that cannot present the results are failed to the specification of test standard.
3. For corrected test results are listed in the relevant table of radiated power test data of this test report.



Registration number: W6M21009-10893-C-1

FCC ID: M5X-ACT202T

614.1 MHz

Antenna Polarization H

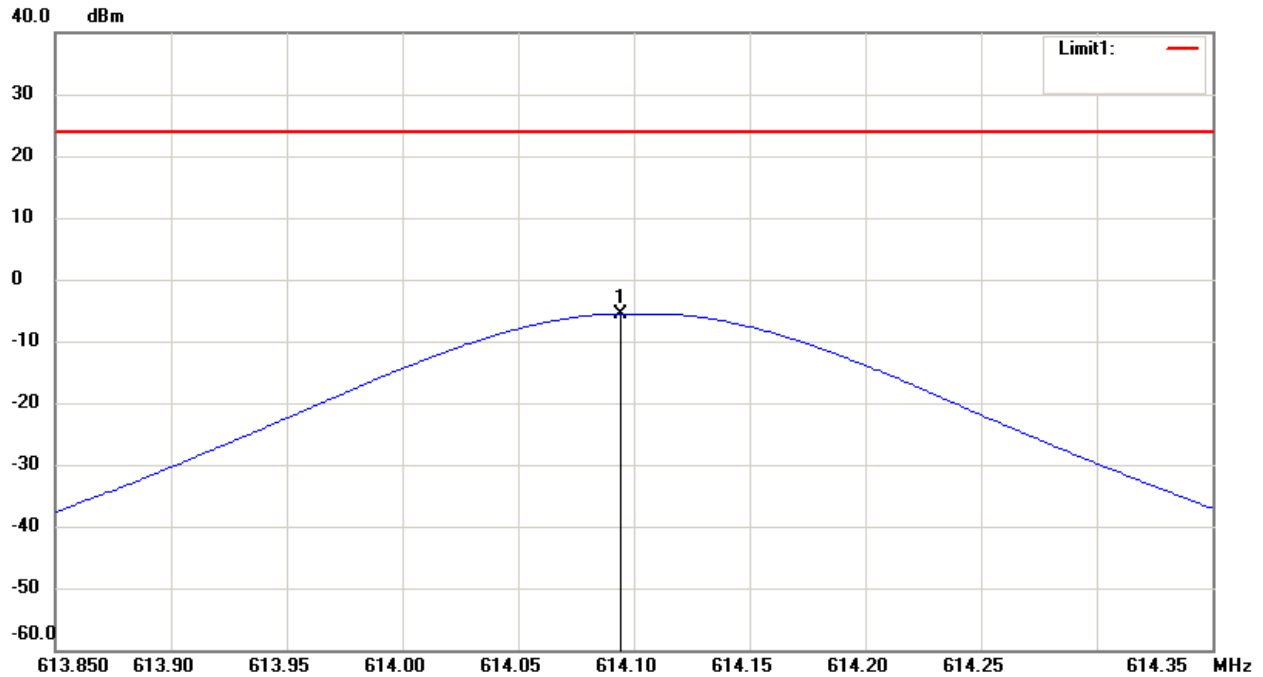

Antenna Polarization V

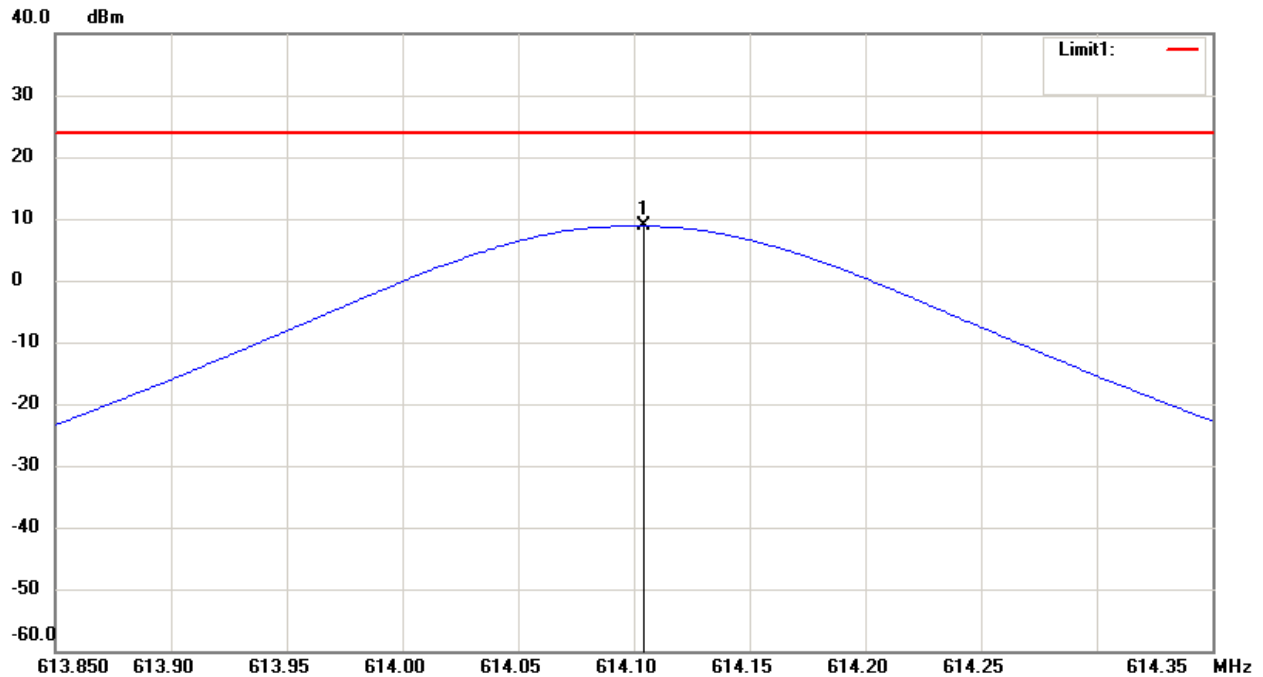

Note:

1. The attached measurement plots are preliminarily pre-scanned with peak detector for determining the final checking frequencies and are for reference only.
2. The some frequencies may exceed the limit line without the specified detectors, but that cannot present the results are failed to the specification of test standard.
3. For corrected test results are listed in the relevant table of radiated power test data of this test report.



Registration number: W6M21009-10893-C-1

FCC ID: M5X-ACT202T

655.5 MHz

Antenna Polarization H

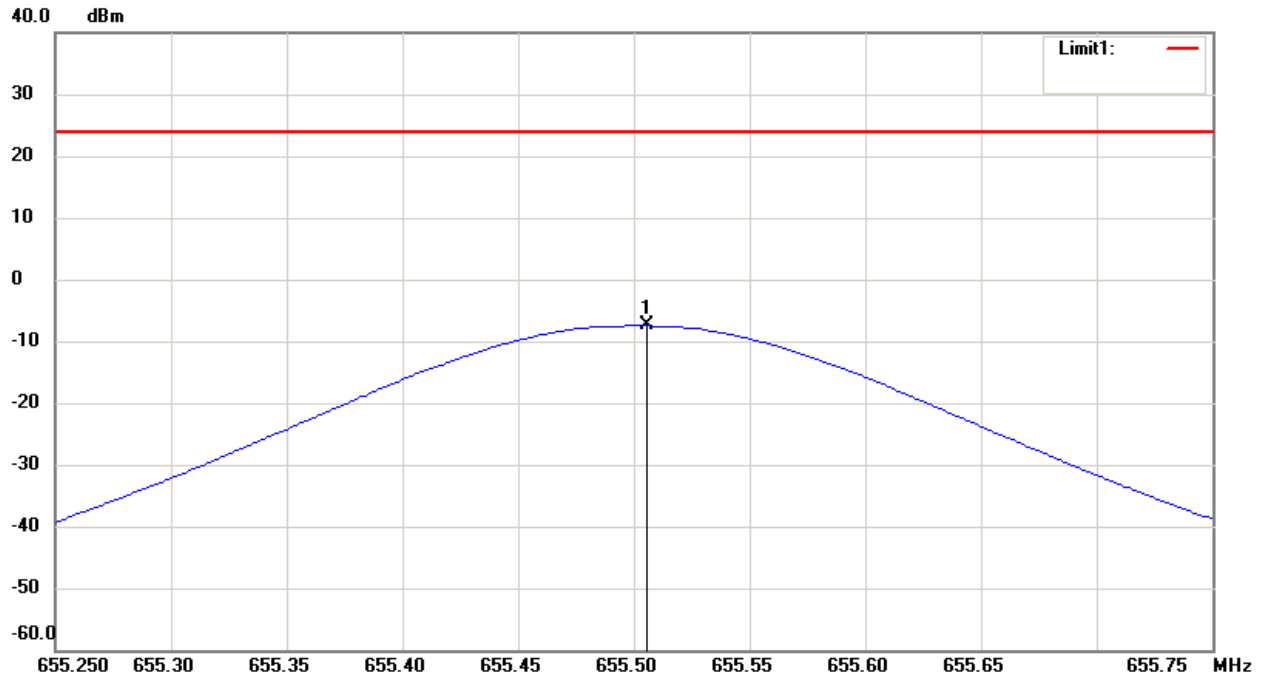

Antenna Polarization V

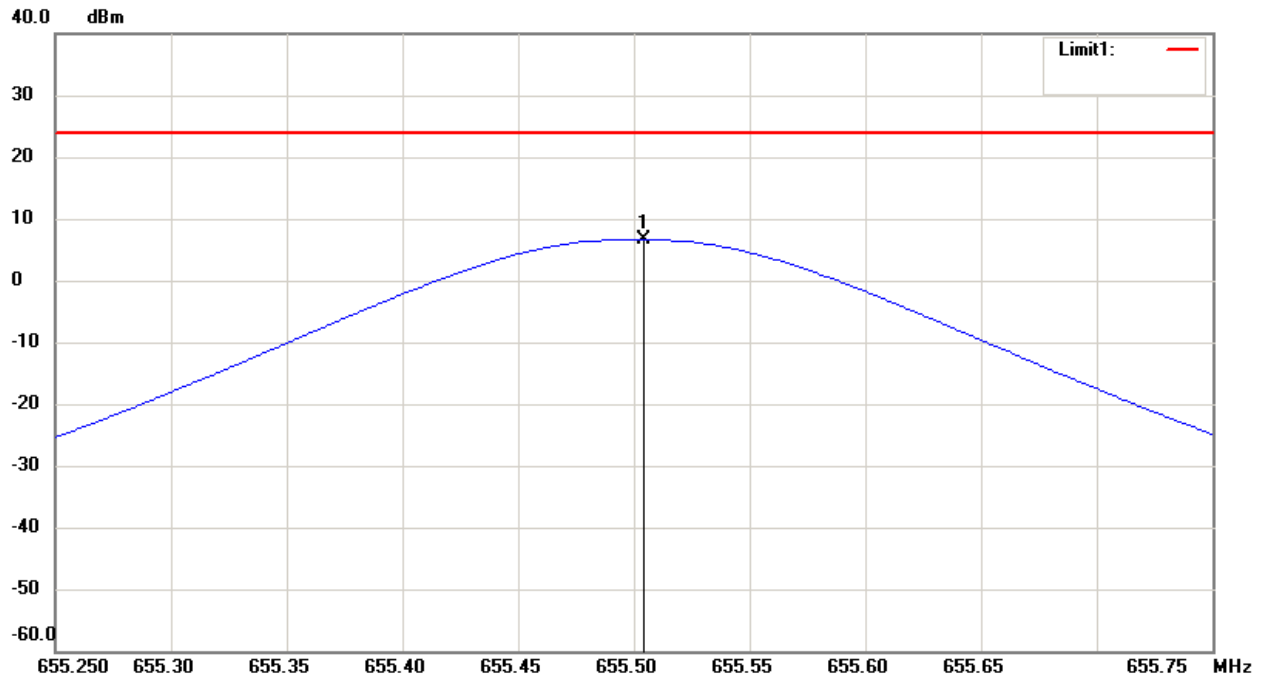

Note:

1. The attached measurement plots are preliminarily pre-scanned with peak detector for determining the final checking frequencies and are for reference only.
2. The some frequencies may exceed the limit line without the specified detectors, but that cannot present the results are failed to the specification of test standard.
3. For corrected test results are listed in the relevant table of radiated power test data of this test report.



Registration number: W6M21009-10893-C-1

FCC ID: M5X-ACT202T

697.9 MHz

Antenna Polarization H

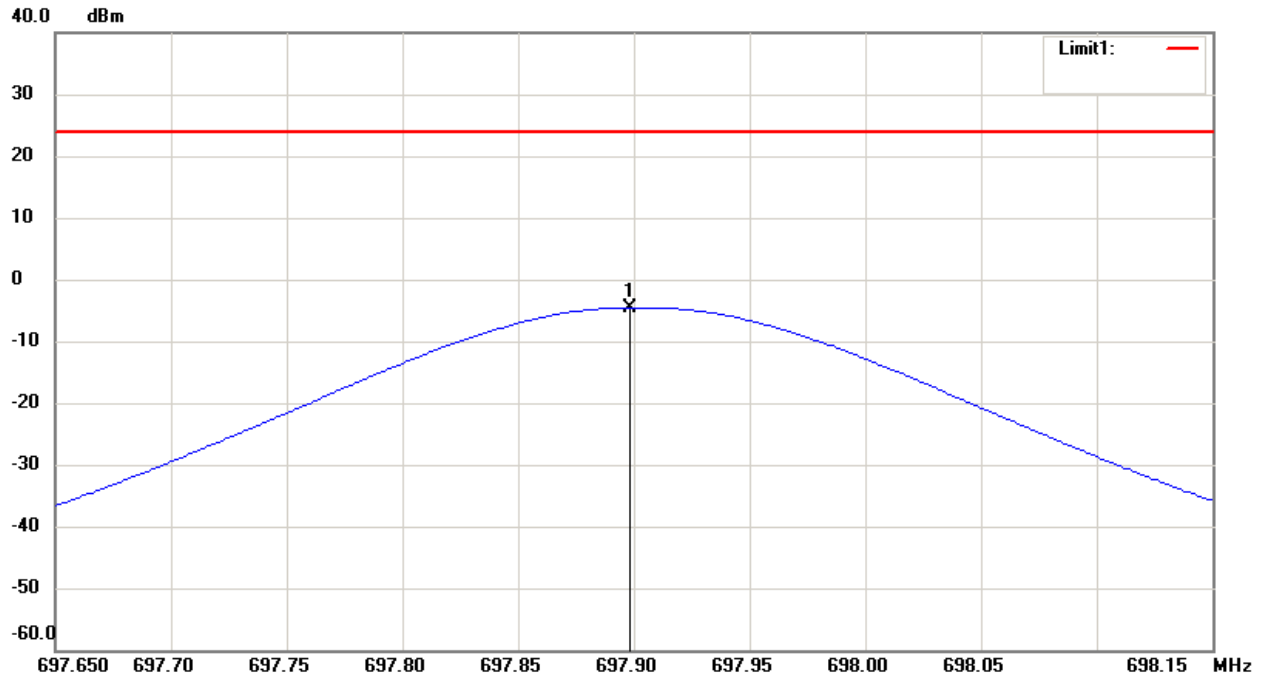

Antenna Polarization V

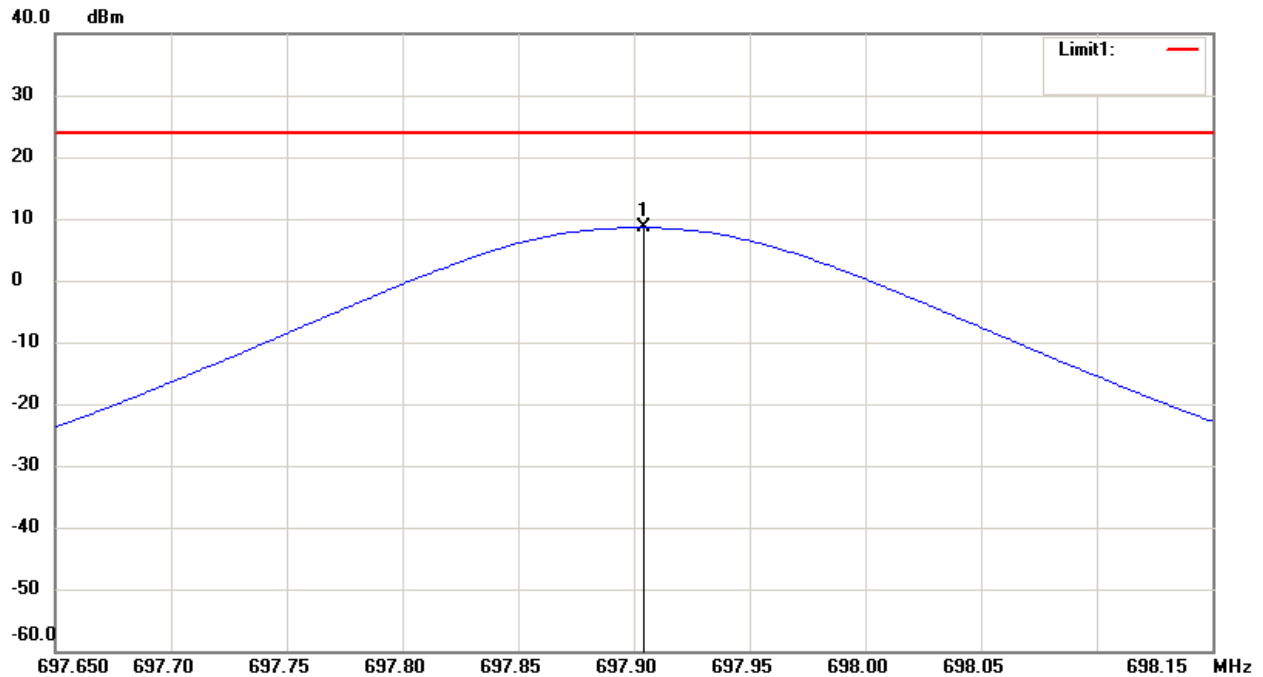

Note:

1. The attached measurement plots are preliminarily pre-scanned with peak detector for determining the final checking frequencies and are for reference only.
2. The some frequencies may exceed the limit line without the specified detectors, but that cannot present the results are failed to the specification of test standard.
3. For corrected test results are listed in the relevant table of radiated power test data of this test report.



Registration number: W6M21009-10893-C-1

FCC ID: M5X-ACT202T

Modulation Deviation and Audio frequency response

506.1 MHz

Modulation Characteristics

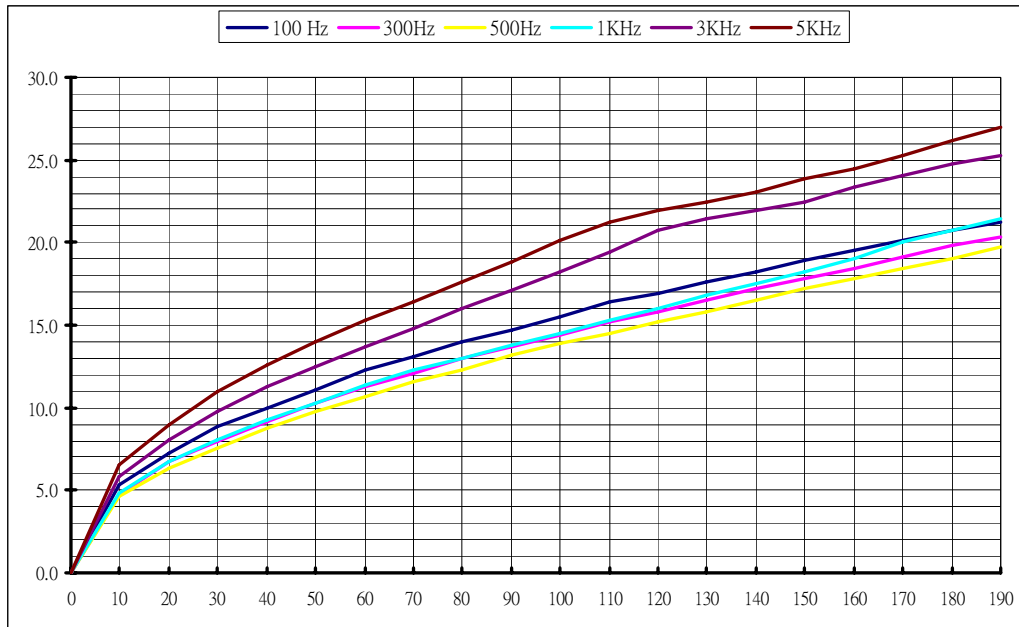

Frequency Deviation at 1kHz

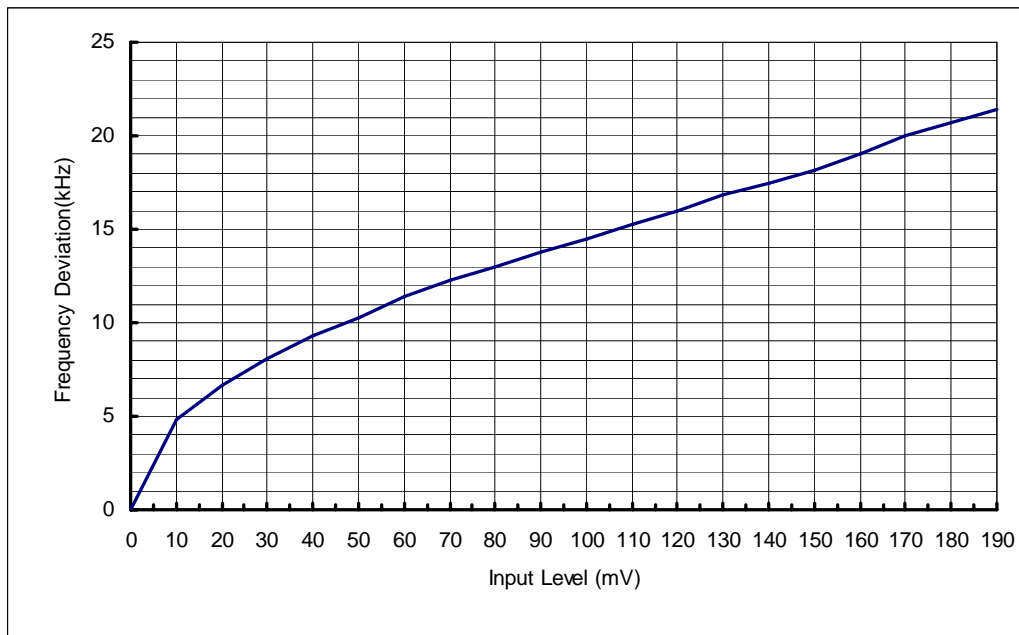



Registration number: W6M21009-10893-C-1

FCC ID: M5X-ACT202T

Frequency Deviation

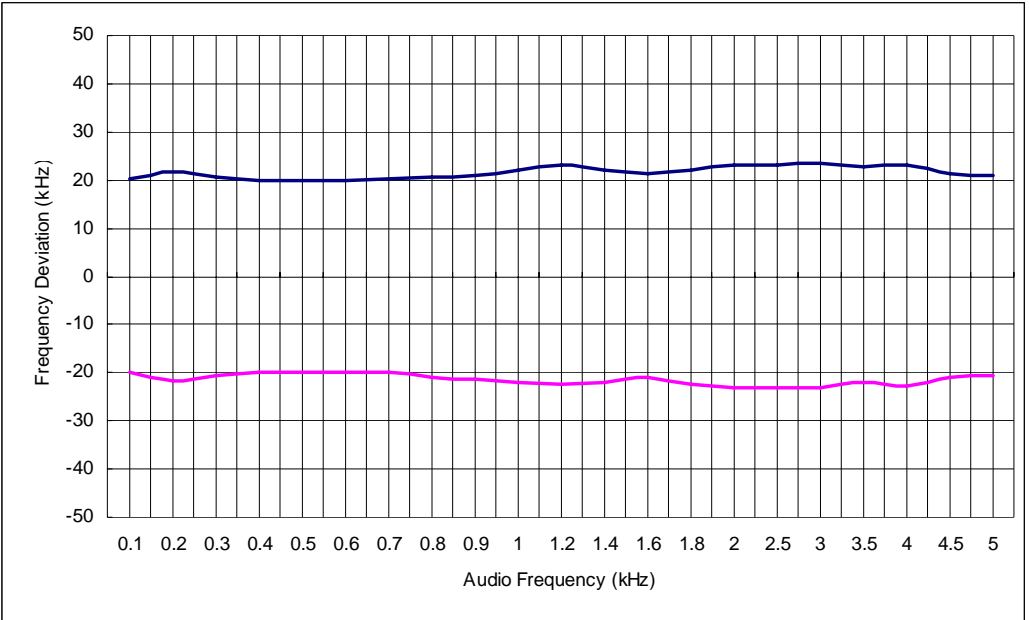

Audio Response

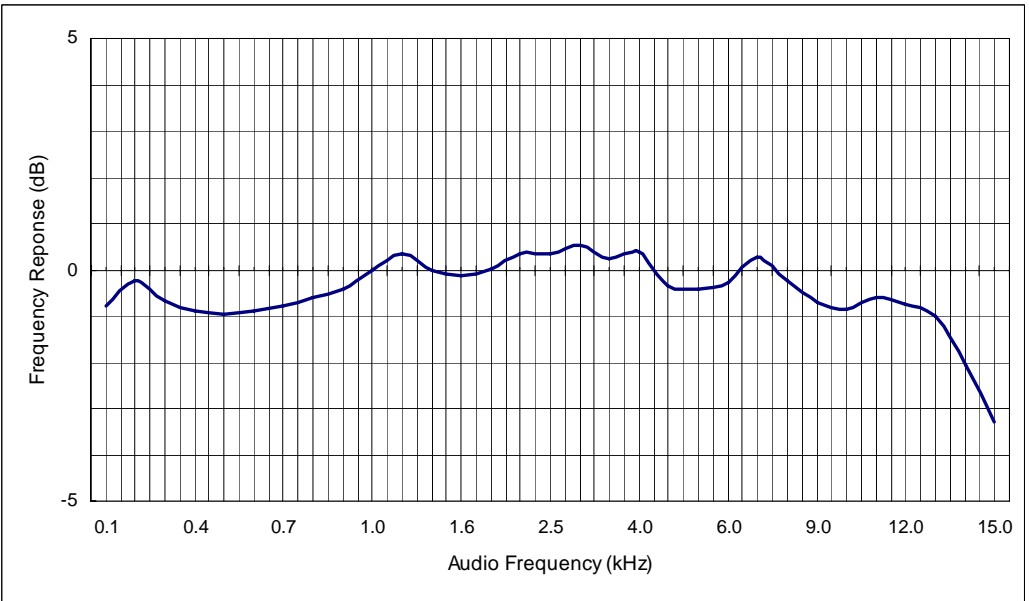



Registration number: W6M21009-10893-C-1

FCC ID: M5X-ACT202T

518.0 MHz

Modulation Characteristics

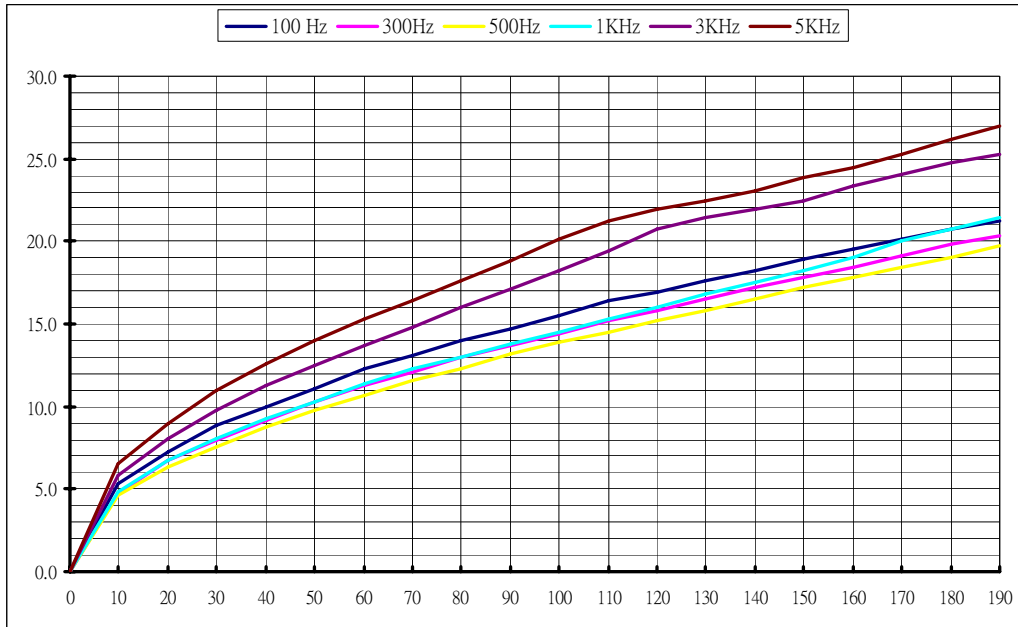

Frequency Deviation at 1kHz

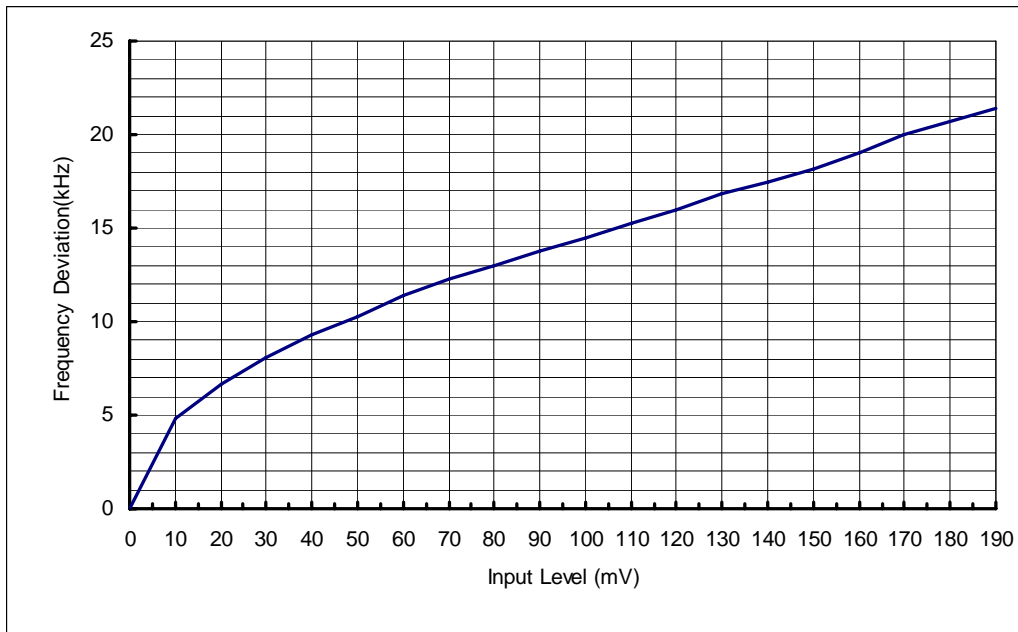



Registration number: W6M21009-10893-C-1

FCC ID: M5X-ACT202T

Frequency Deviation

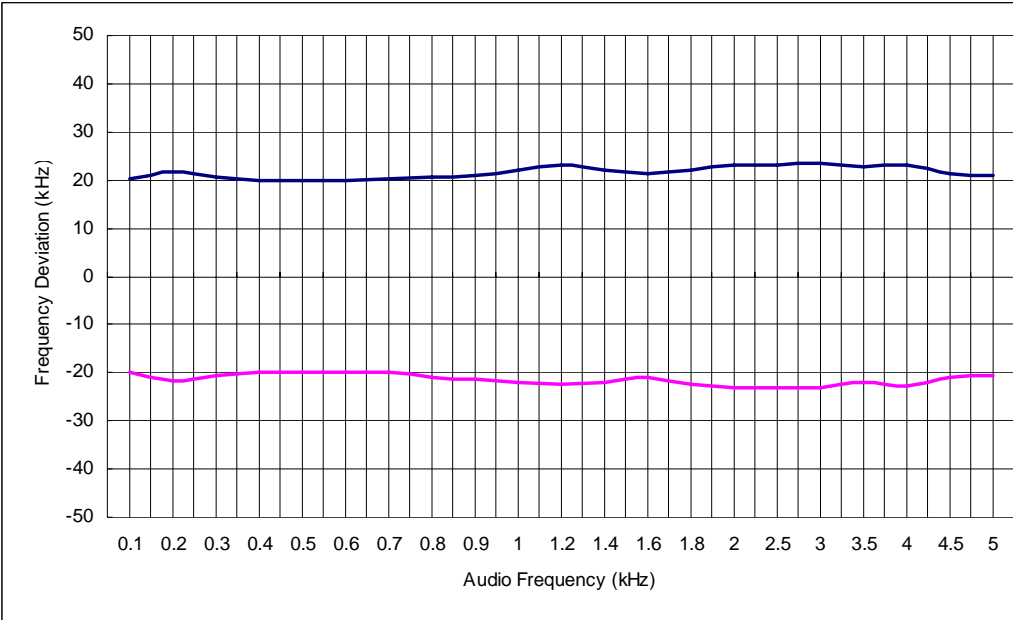

Audio Response

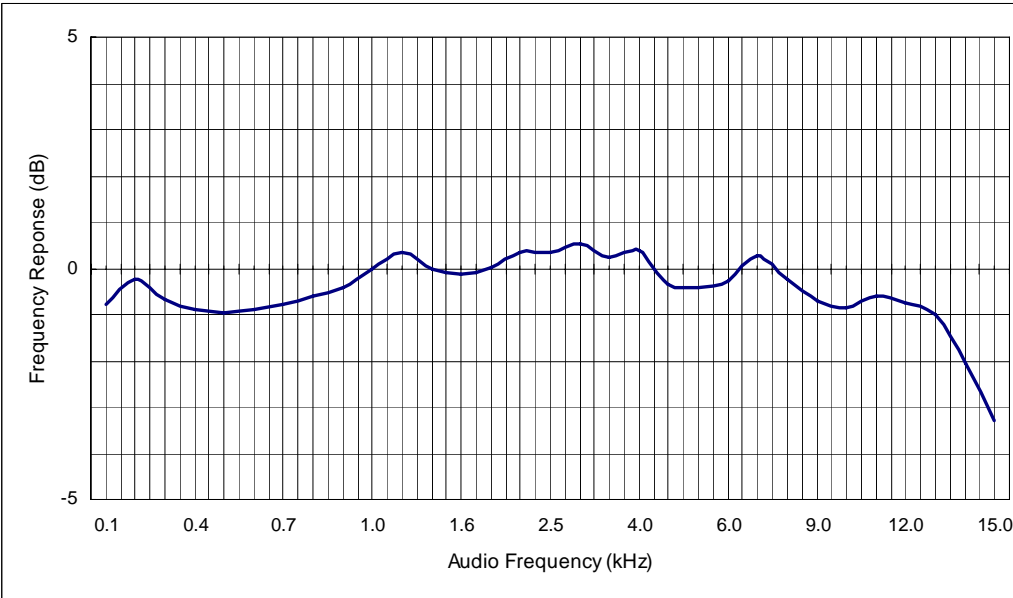



Registration number: W6M21009-10893-C-1

FCC ID: M5X-ACT202T

529.9 MHz

Modulation Characteristics

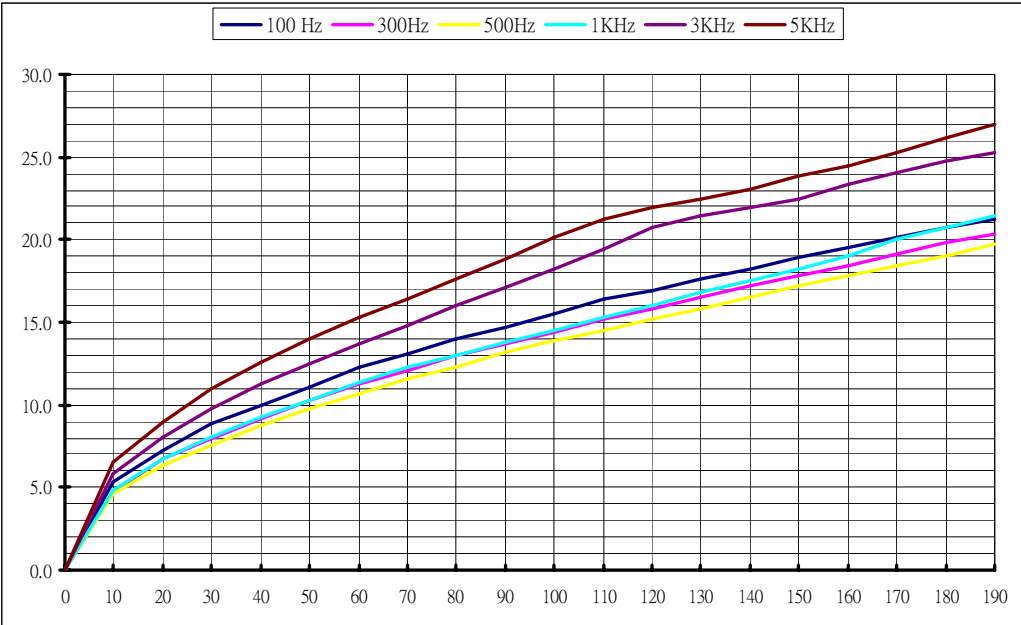

Frequency Deviation at 1kHz

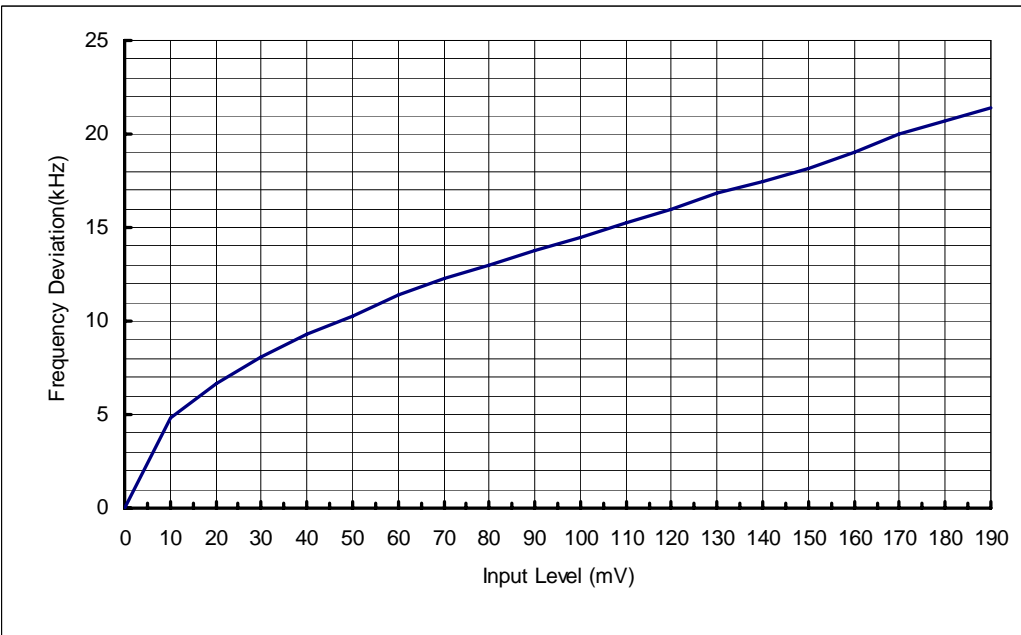



Registration number: W6M21009-10893-C-1

FCC ID: M5X-ACT202T

Frequency Deviation

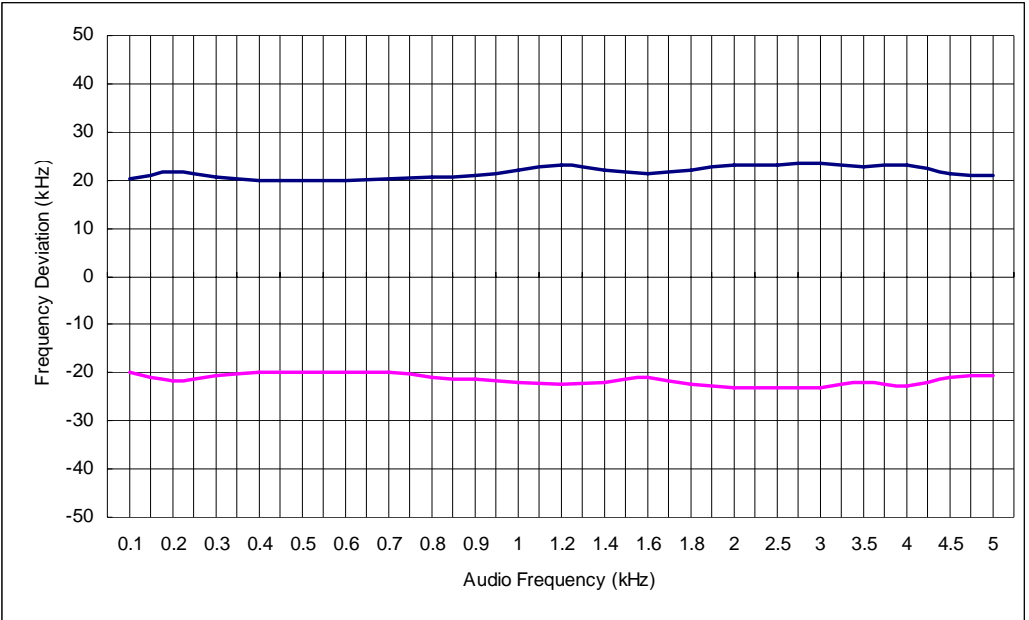

Audio Response

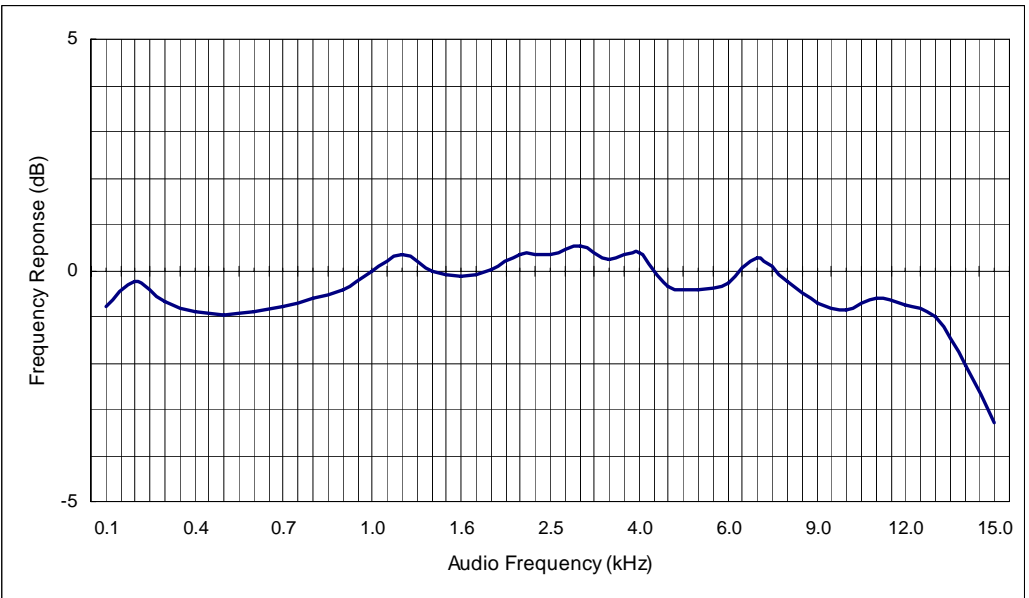



Registration number: W6M21009-10893-C-1

FCC ID: M5X-ACT202T

614.1 MHz

Modulation Characteristics

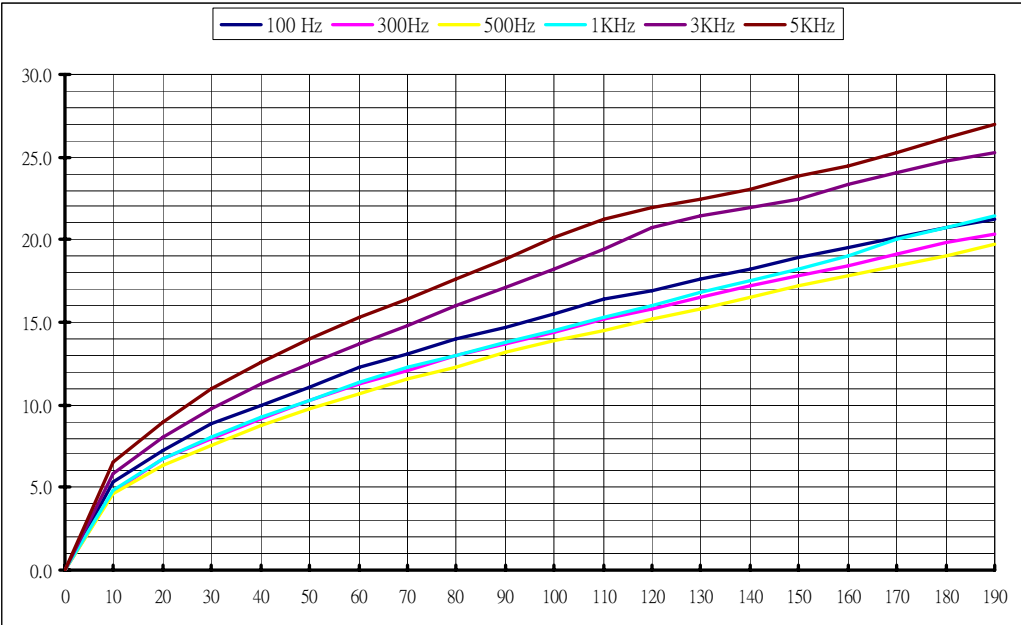

Frequency Deviation at 1kHz

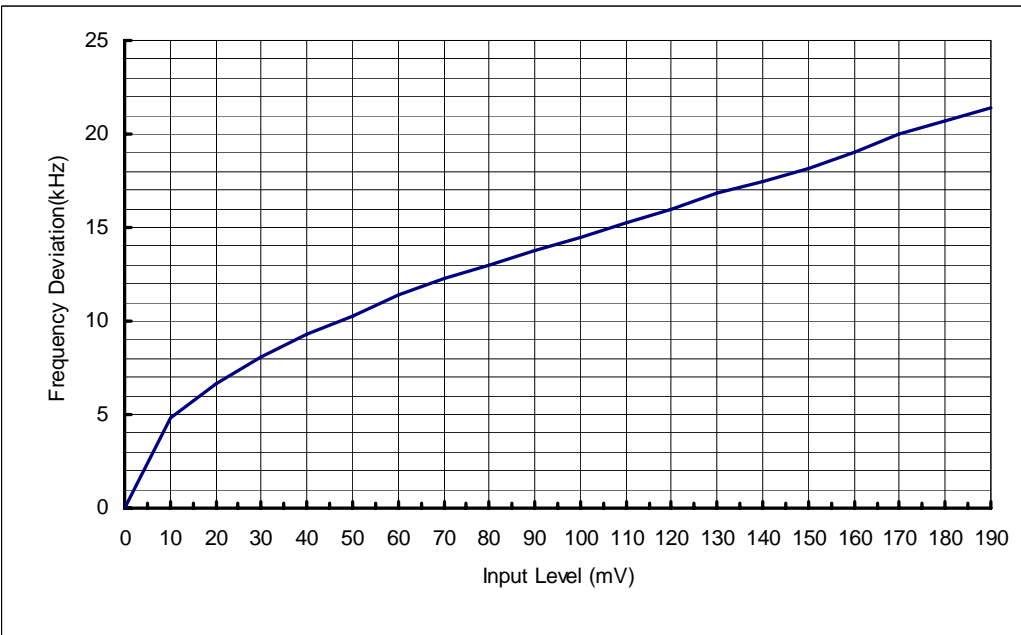



Registration number: W6M21009-10893-C-1

FCC ID: M5X-ACT202T

Frequency Deviation

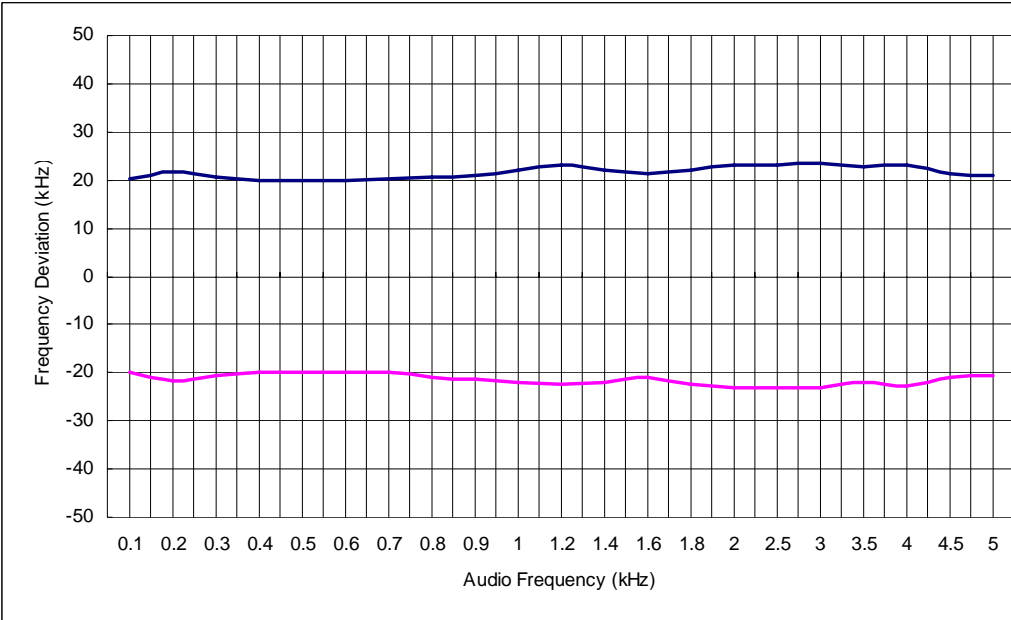

Audio Response

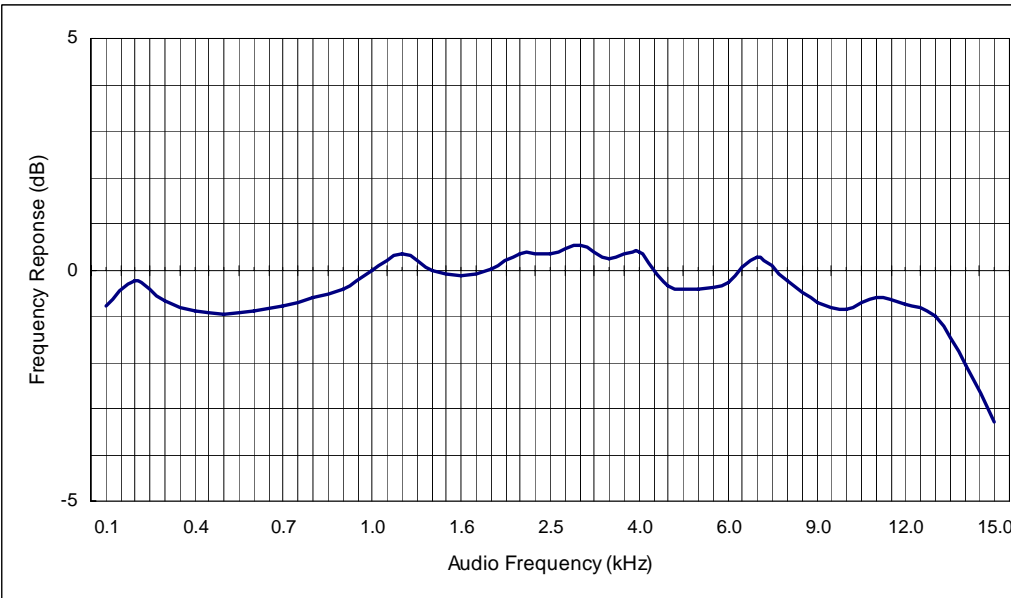



Registration number: W6M21009-10893-C-1

FCC ID: M5X-ACT202T

655.5 MHz

Modulation Characteristics

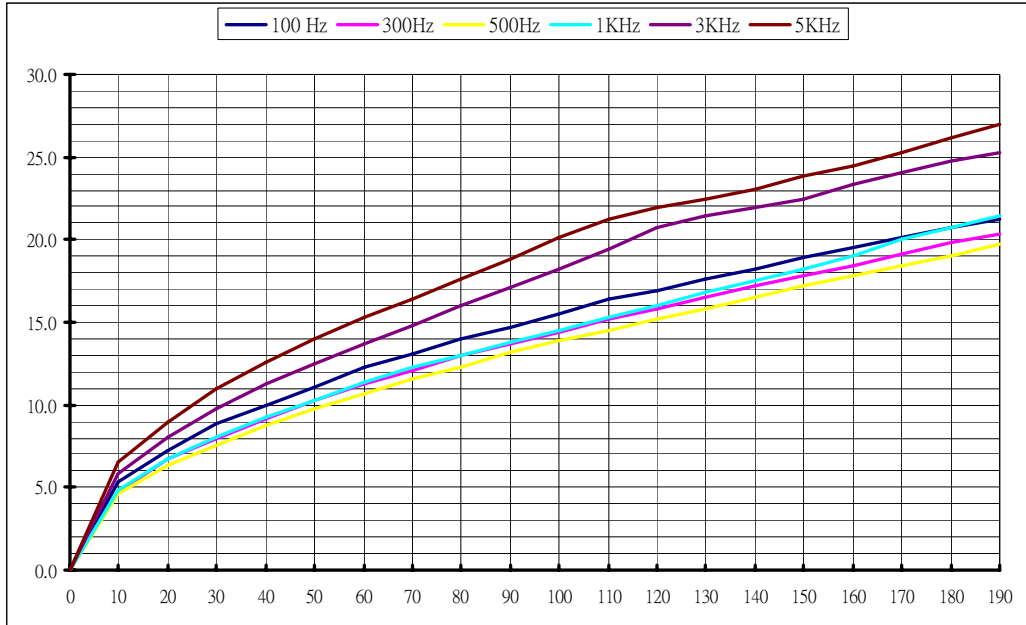

Frequency Deviation at 1kHz

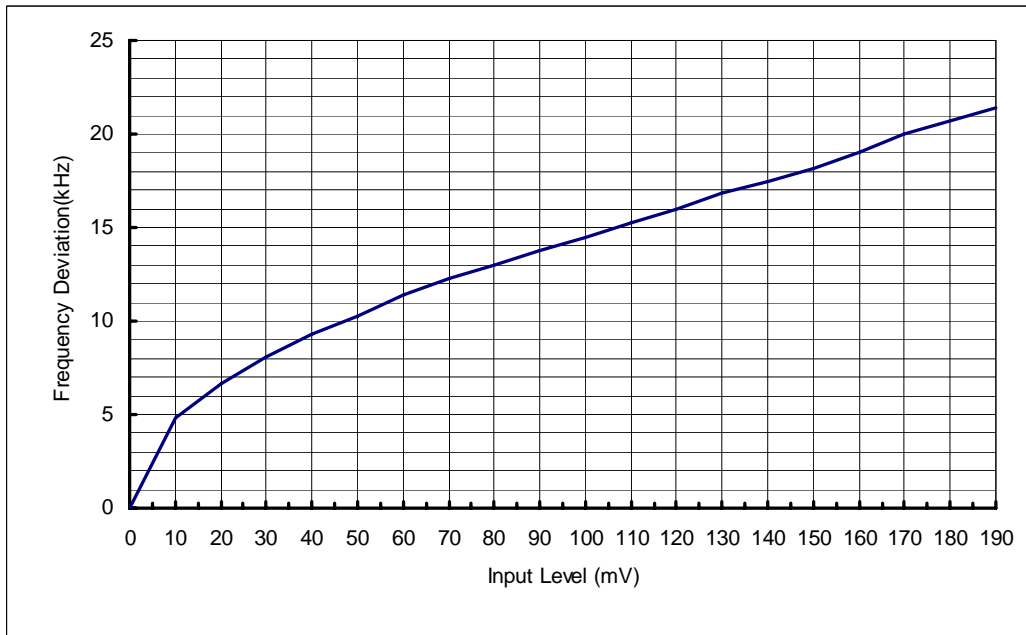



Registration number: W6M21009-10893-C-1

FCC ID: M5X-ACT202T

Frequency Deviation

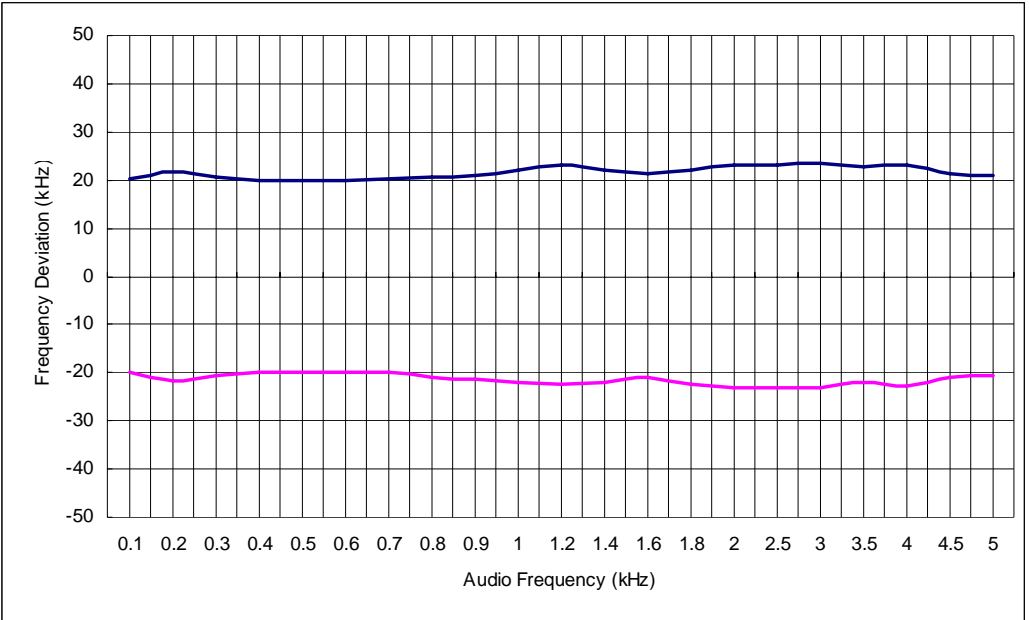

Audio Response

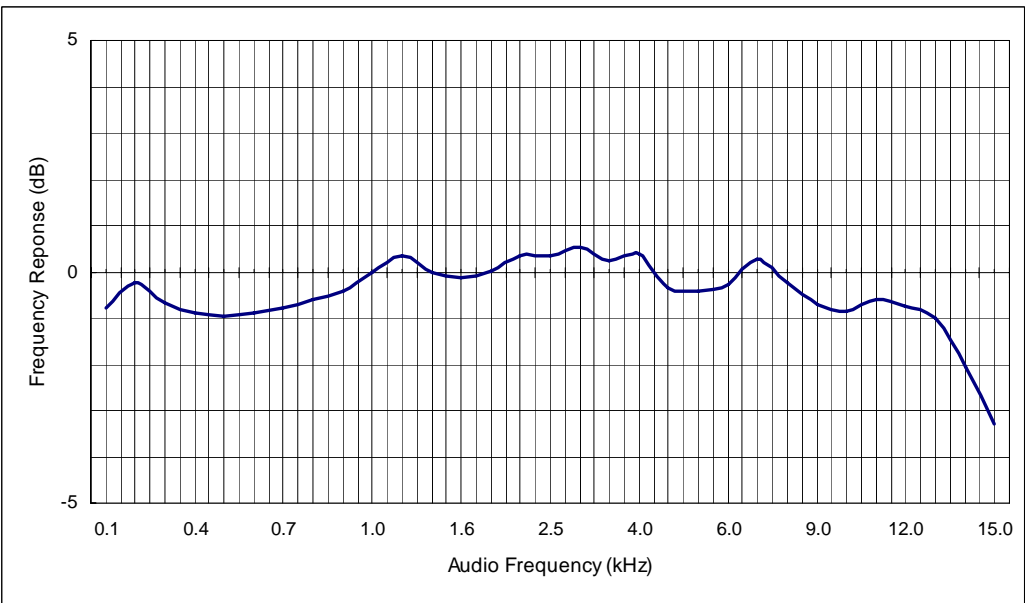



Registration number: W6M21009-10893-C-1

FCC ID: M5X-ACT202T

697.9 MHz

Modulation Characteristics

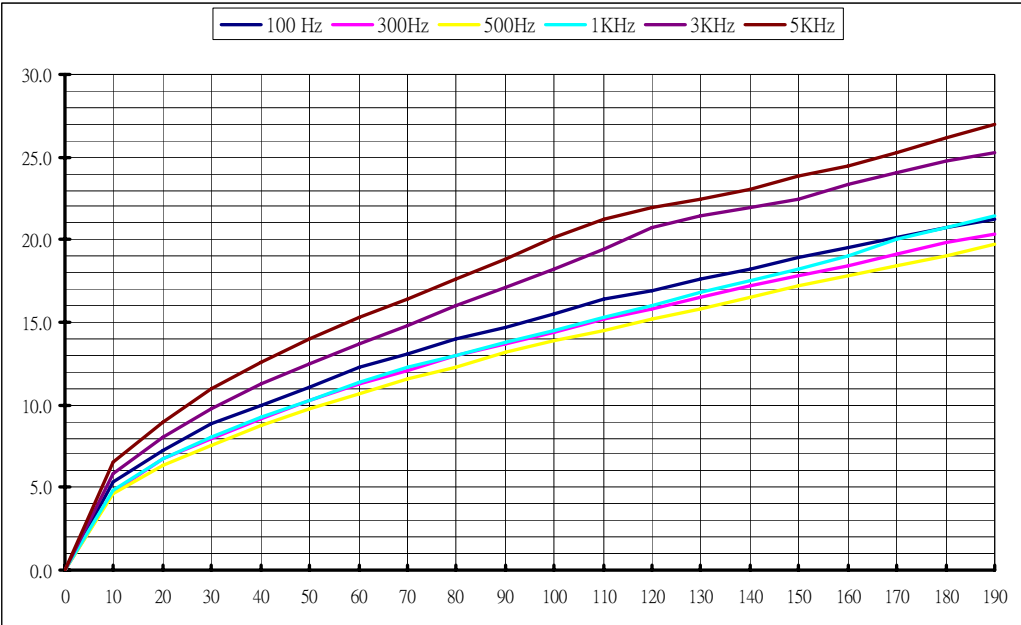

Frequency Deviation at 1kHz

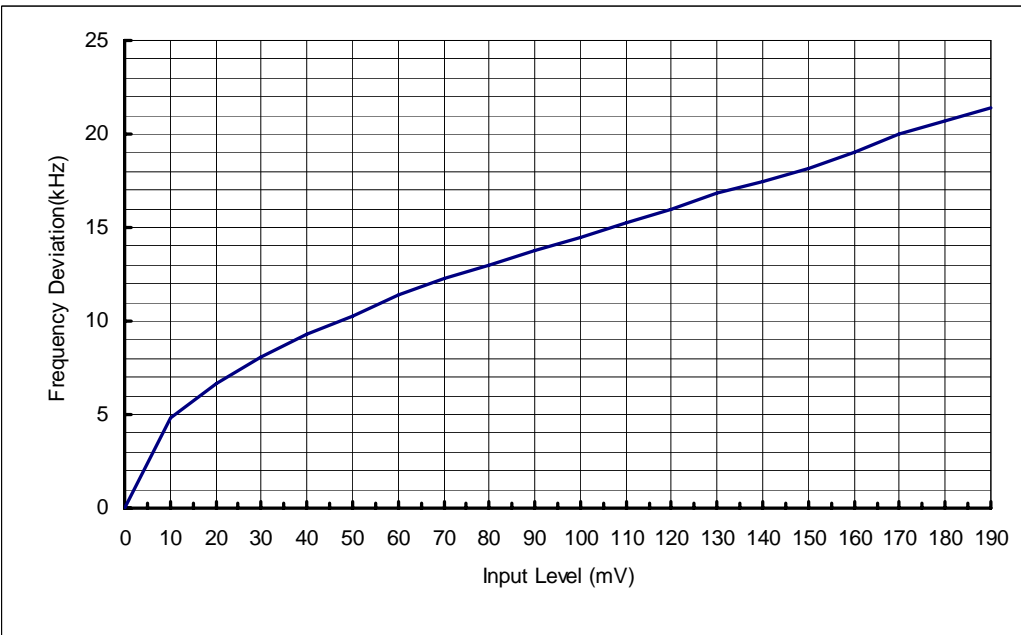



Registration number: W6M21009-10893-C-1

FCC ID: M5X-ACT202T

Frequency Deviation

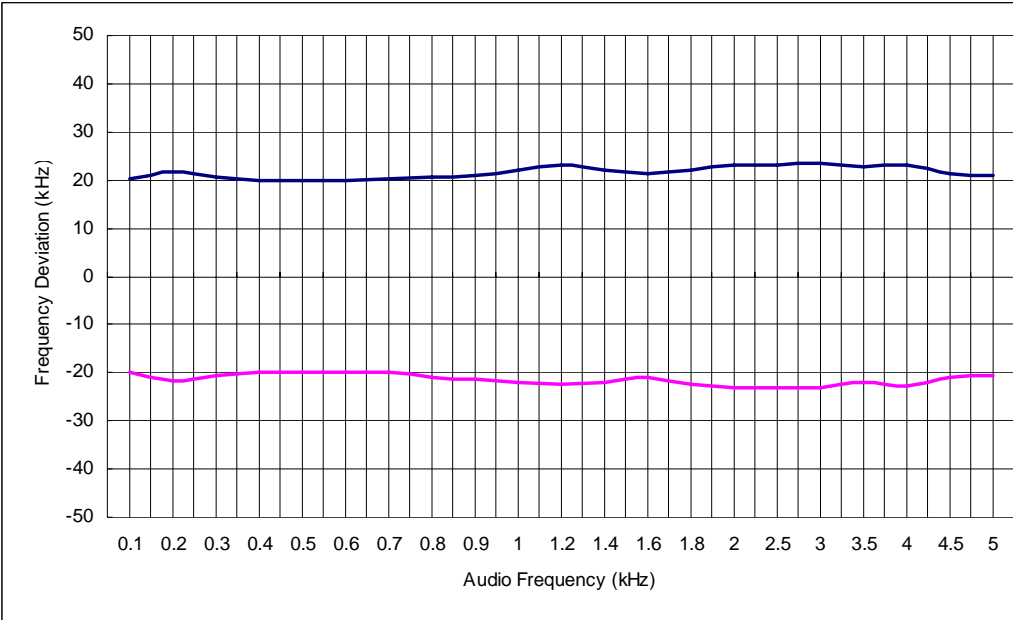

Audio Response

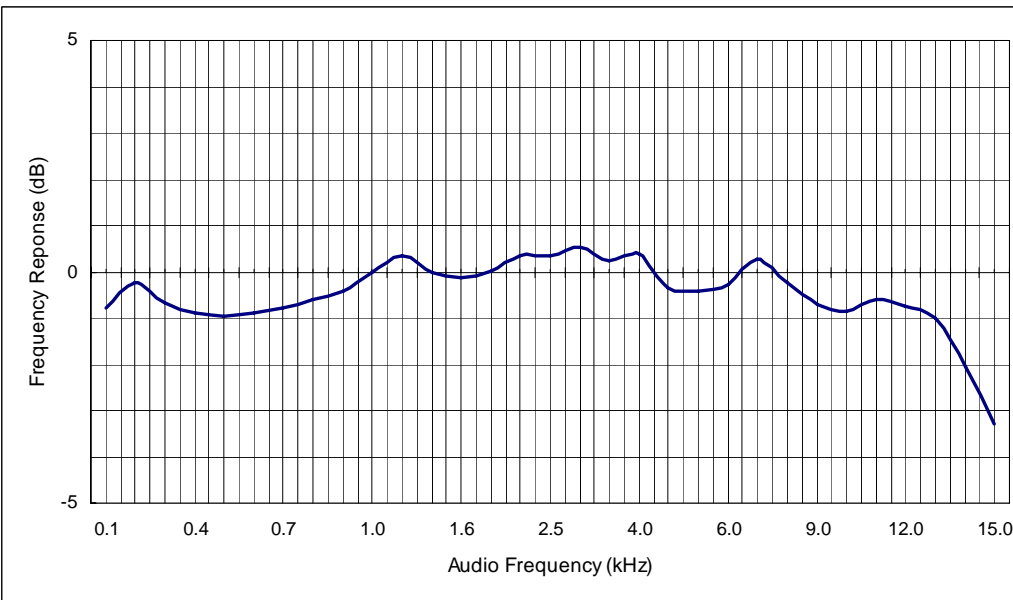



Registration number: W6M21009-10893-C-1

FCC ID: M5X-ACT202T

Occupied Bandwidth / Emission Mask

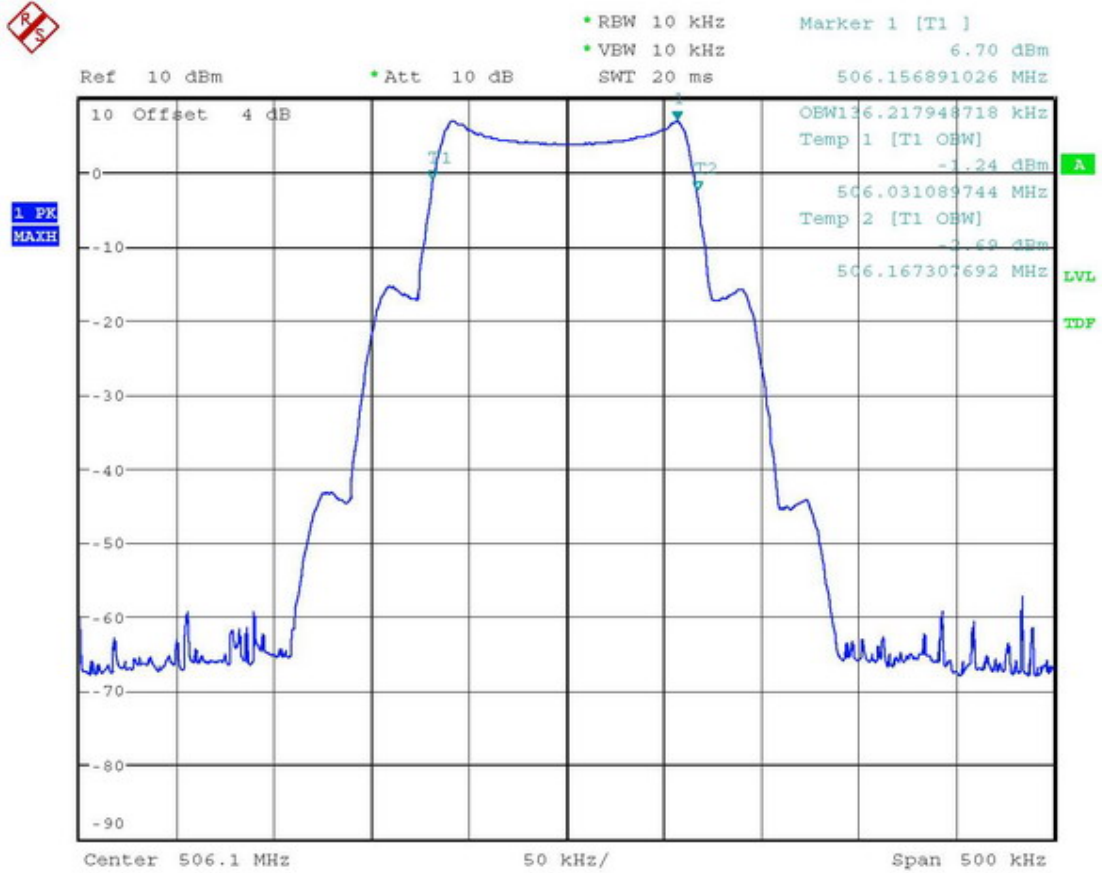

OCCUPIED BANDWIDTH 1KHZ

Date: 1.OCT.2010 09:07:11



Worldwide Testing Services(Taiwan) Co., Ltd.

Registration number: W6M21009-10893-C-1

FCC ID: M5X-ACT202T

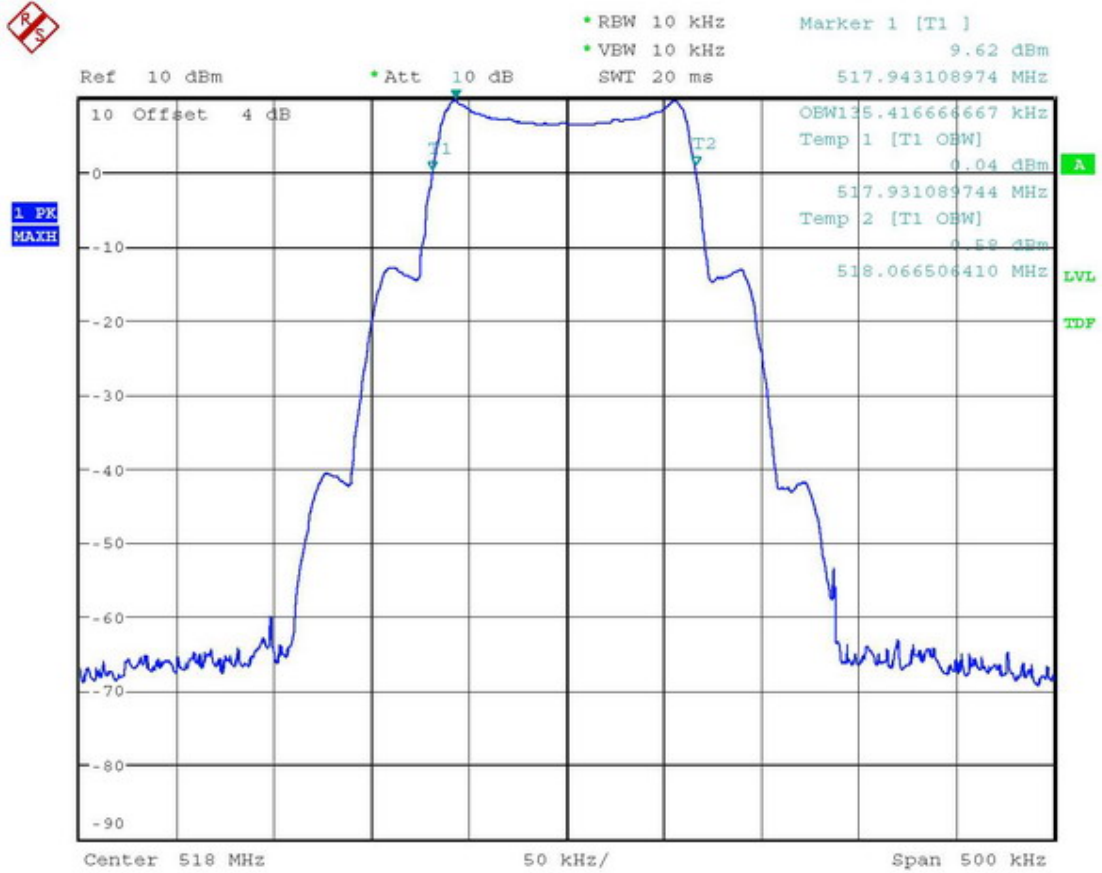

OCCUPIED BANDWIDTH 1KHz

Date: 1.OCT.2010 09:29:41



Worldwide Testing Services(Taiwan) Co., Ltd.

Registration number: W6M21009-10893-C-1

FCC ID: M5X-ACT202T

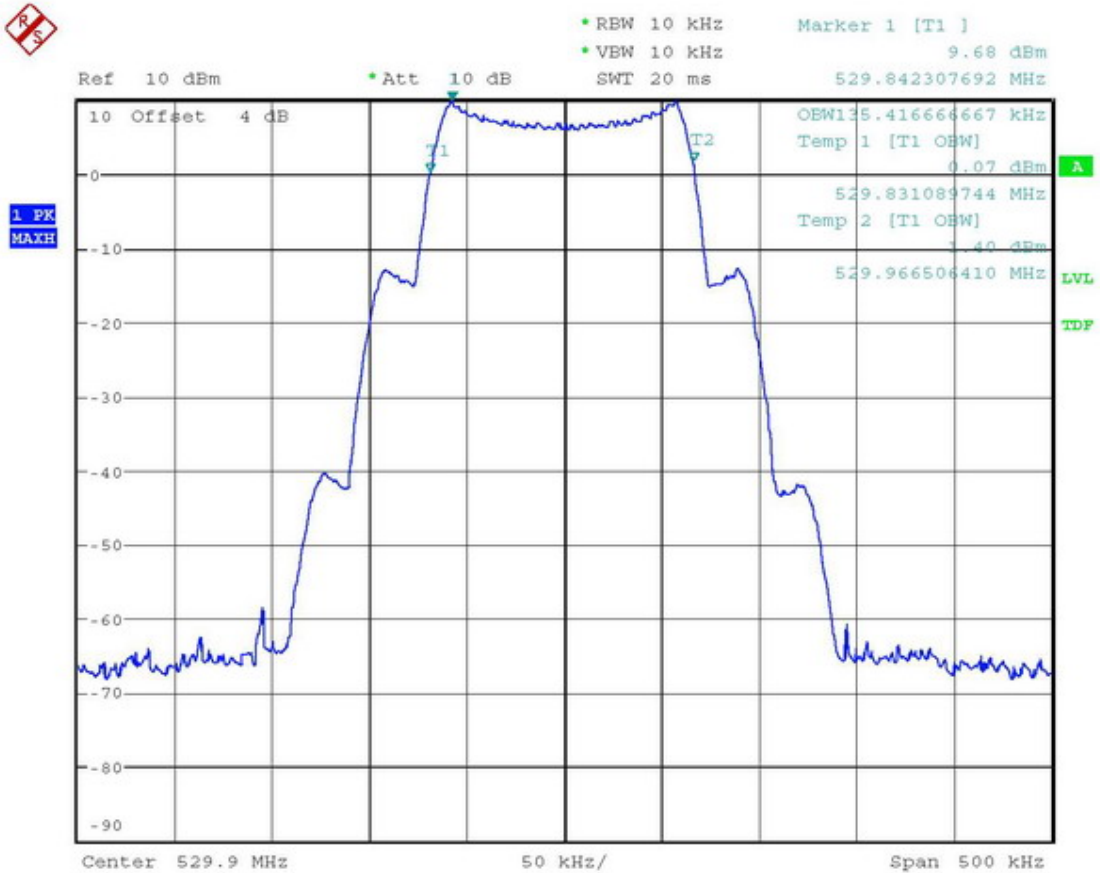

OCCUPIED BANDWIDTH 1KHz

Date: 1.OCT.2010 09:33:29



Worldwide Testing Services(Taiwan) Co., Ltd.

Registration number: W6M21009-10893-C-1

FCC ID: M5X-ACT202T

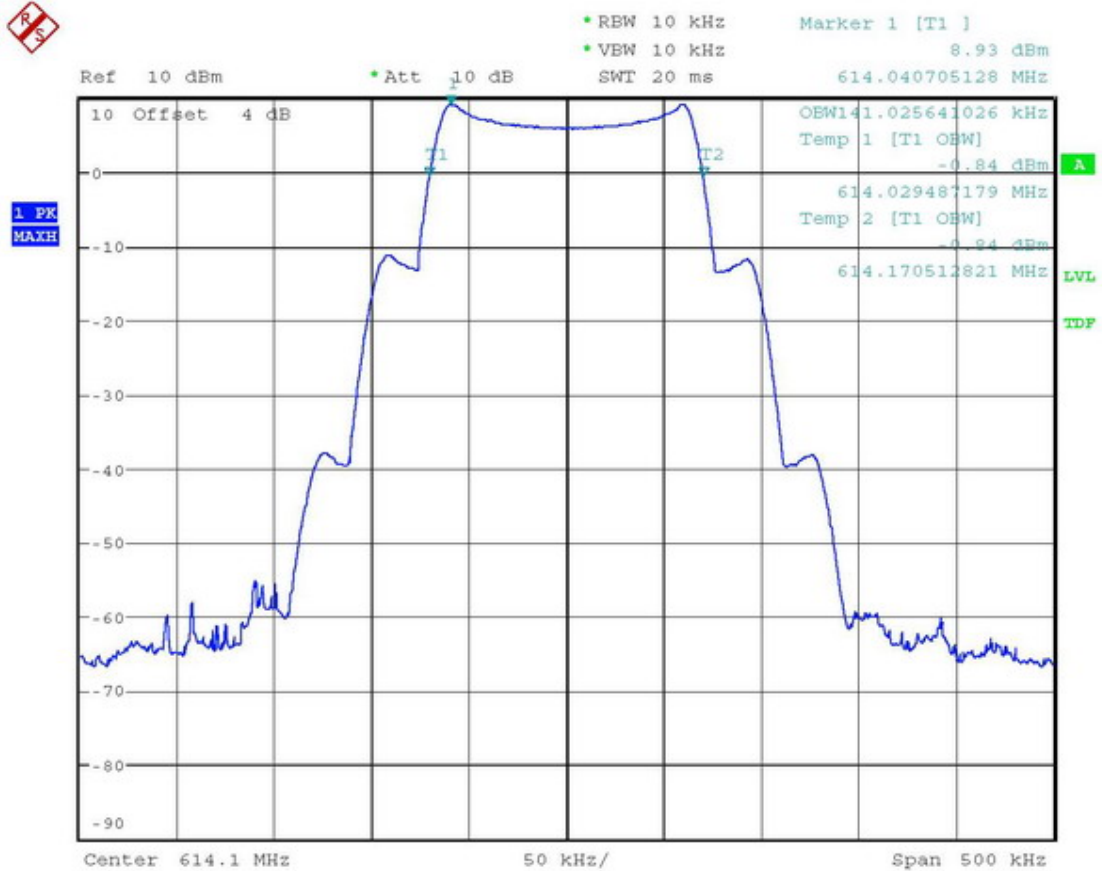

OCCUPIED BANDWIDTH 1KHz

Date: 1.OCT.2010 13:34:45



Worldwide Testing Services(Taiwan) Co., Ltd.

Registration number: W6M21009-10893-C-1

FCC ID: M5X-ACT202T

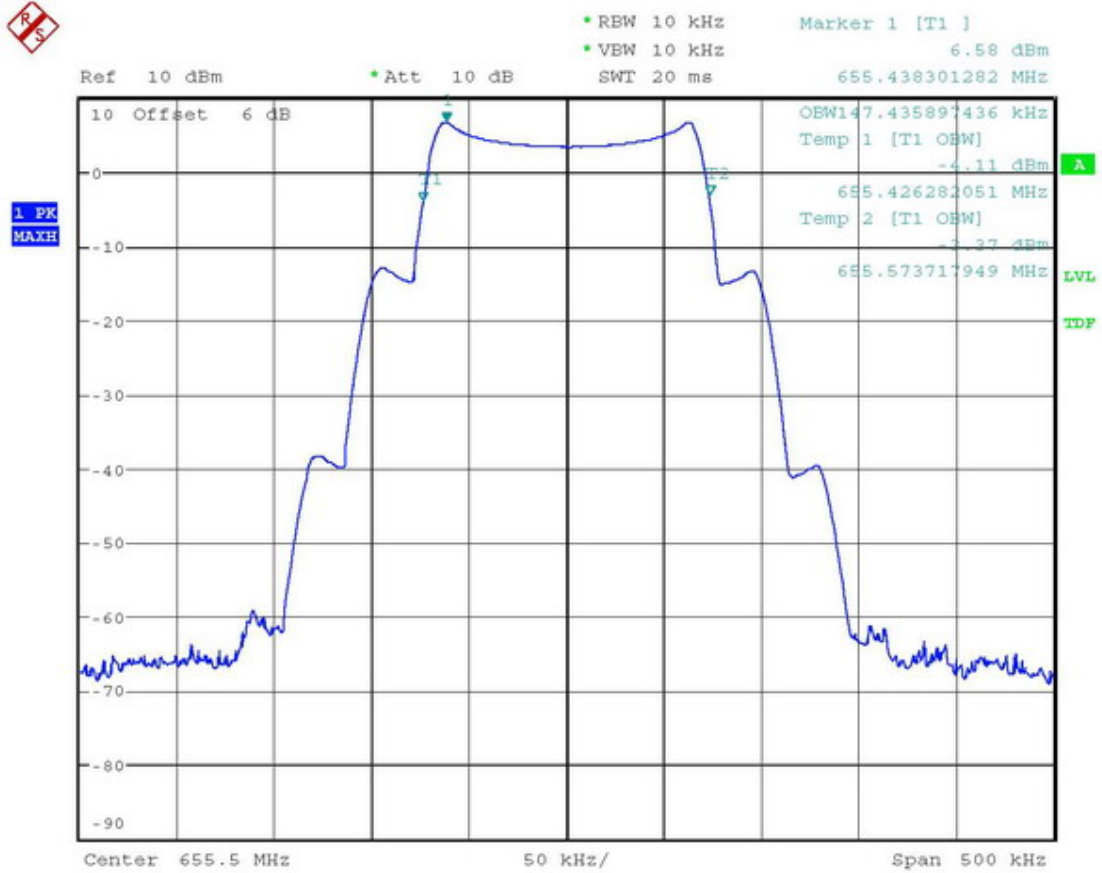

OCCUPIED BANDWIDTH 1KHz

Date: 1.OCT.2010 14:32:13



Worldwide Testing Services(Taiwan) Co., Ltd.

Registration number: W6M21009-10893-C-1

FCC ID: M5X-ACT202T

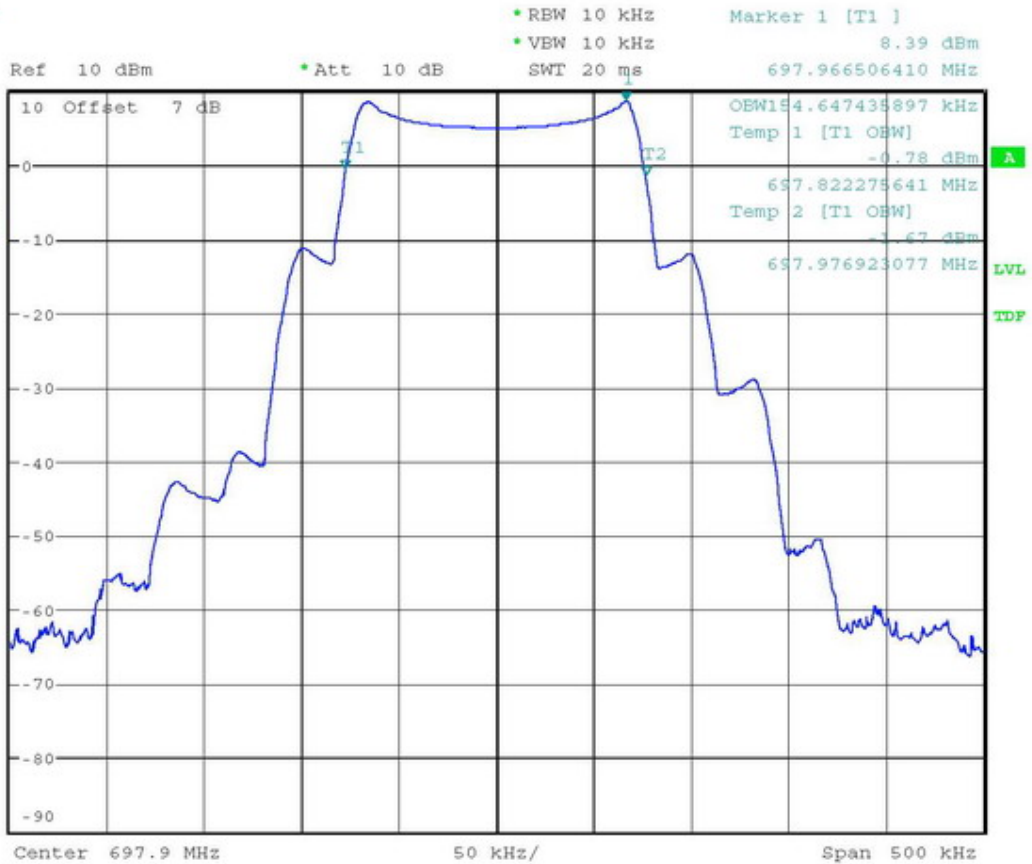

OCCUPIED BANDWIDTH 1KHz

Date: 1.OCT.2010 14:03:20



Worldwide Testing Services (Taiwan) Co., Ltd.

Registration number: W6M21009-10893-C-1

FCC ID: M5X-ACT202T

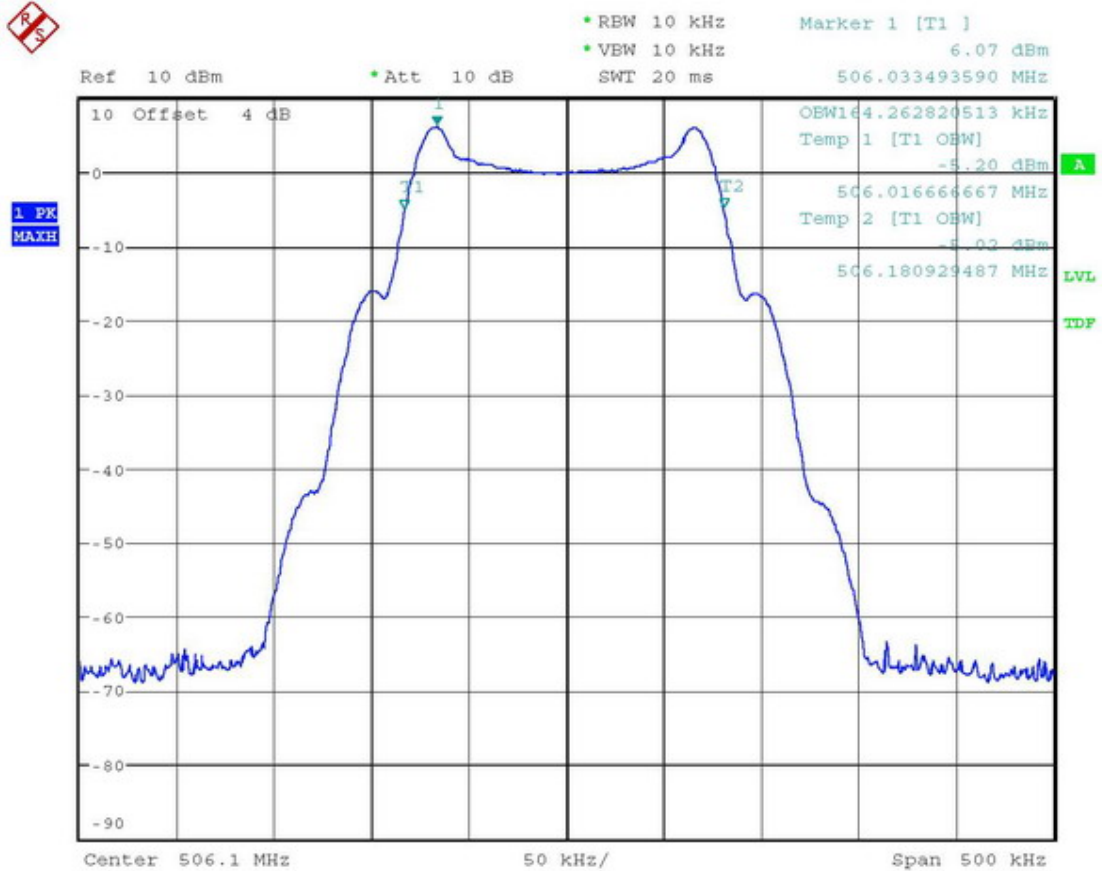

OCCUPIED BANDWIDTH 2.5KHz
Date: 1.OCT.2010 09:07:45



Worldwide Testing Services(Taiwan) Co., Ltd.

Registration number: W6M21009-10893-C-1

FCC ID: M5X-ACT202T

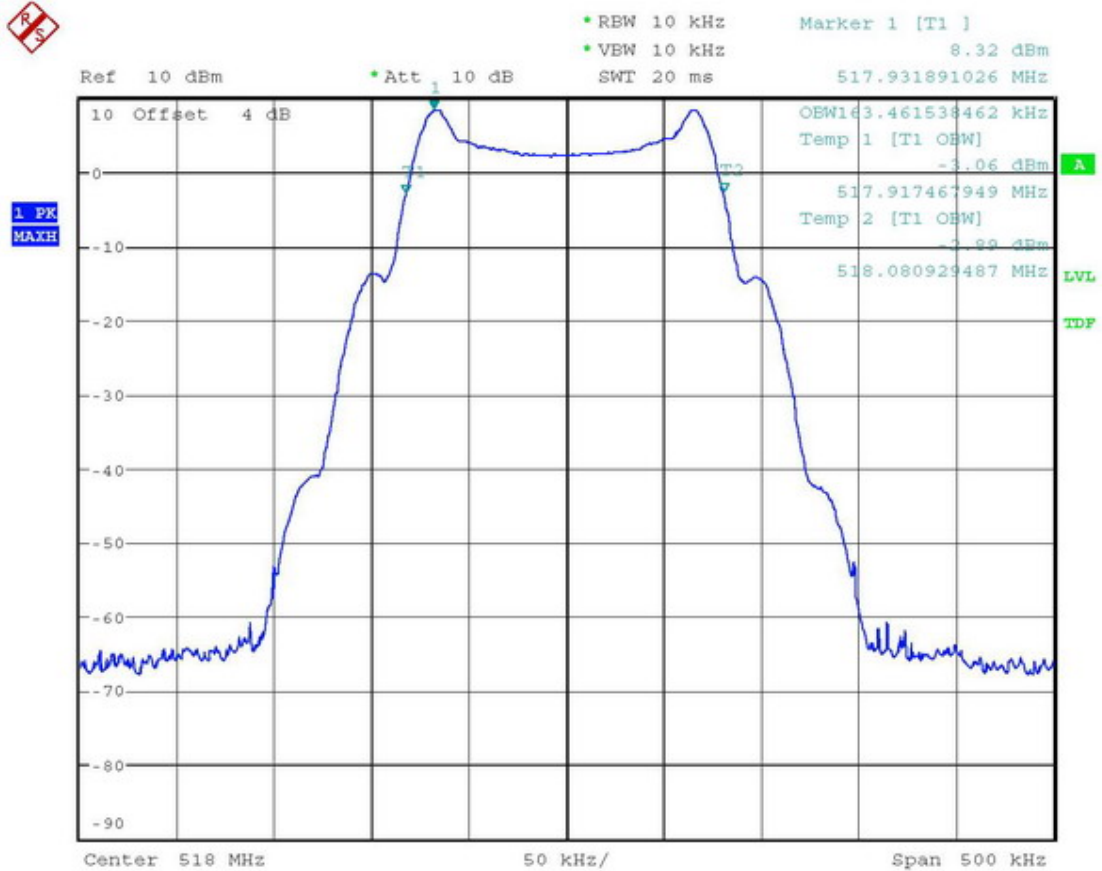

OCCUPIED BANDWIDTH 2.5KHz
Date: 1.OCT.2010 09:29:05



Worldwide Testing Services(Taiwan) Co., Ltd.

Registration number: W6M21009-10893-C-1

FCC ID: M5X-ACT202T

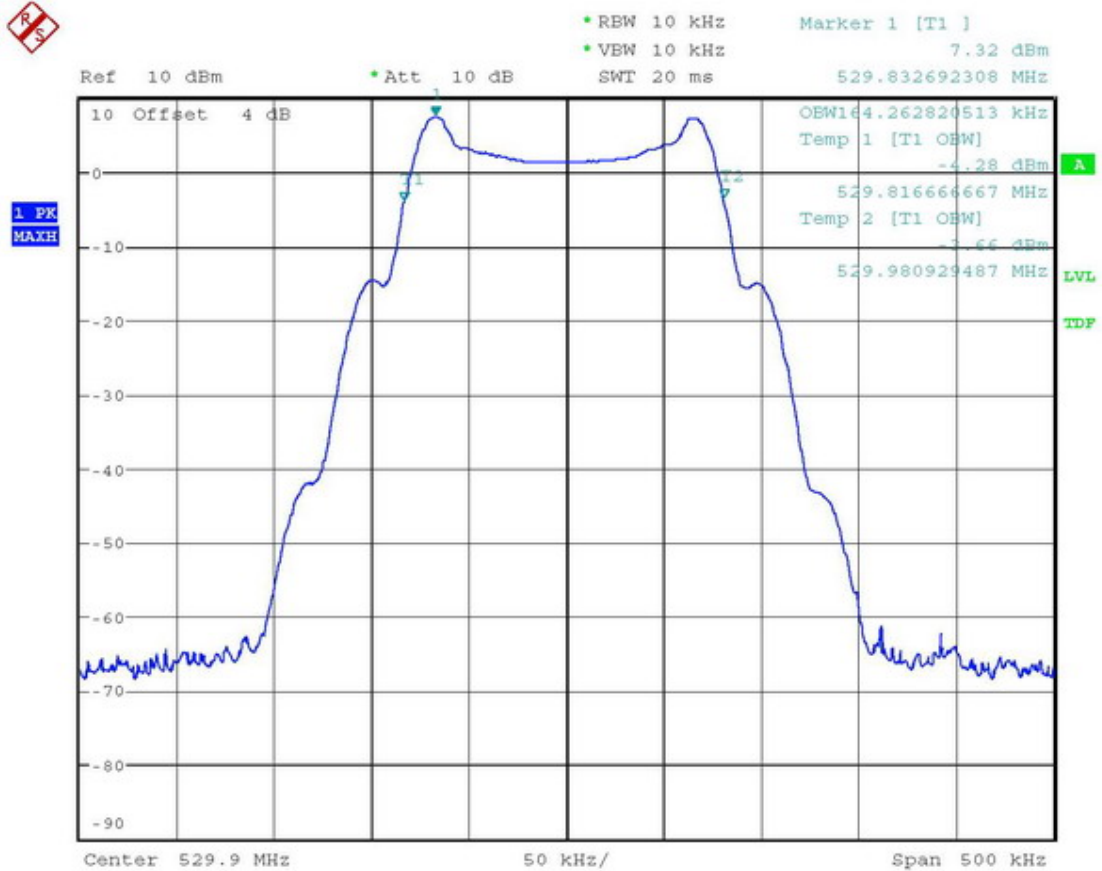

OCCUPIED BANDWIDTH 2.5KHz
Date: 1.OCT.2010 09:34:17



Worldwide Testing Services (Taiwan) Co., Ltd.

Registration number: W6M21009-10893-C-1

FCC ID: M5X-ACT202T

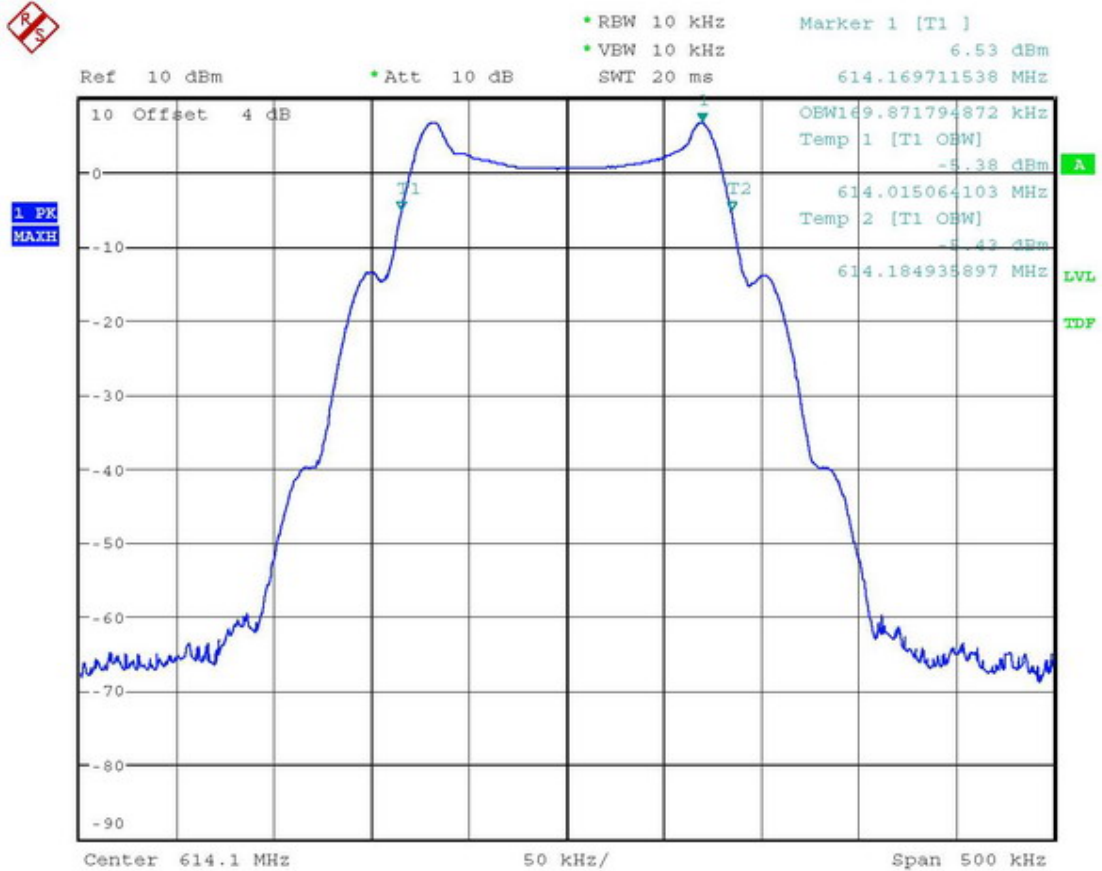

OCCUPIED BANDWIDTH 2.5KHz

Date: 1.OCT.2010 13:37:24



Worldwide Testing Services (Taiwan) Co., Ltd.

Registration number: W6M21009-10893-C-1

FCC ID: M5X-ACT202T

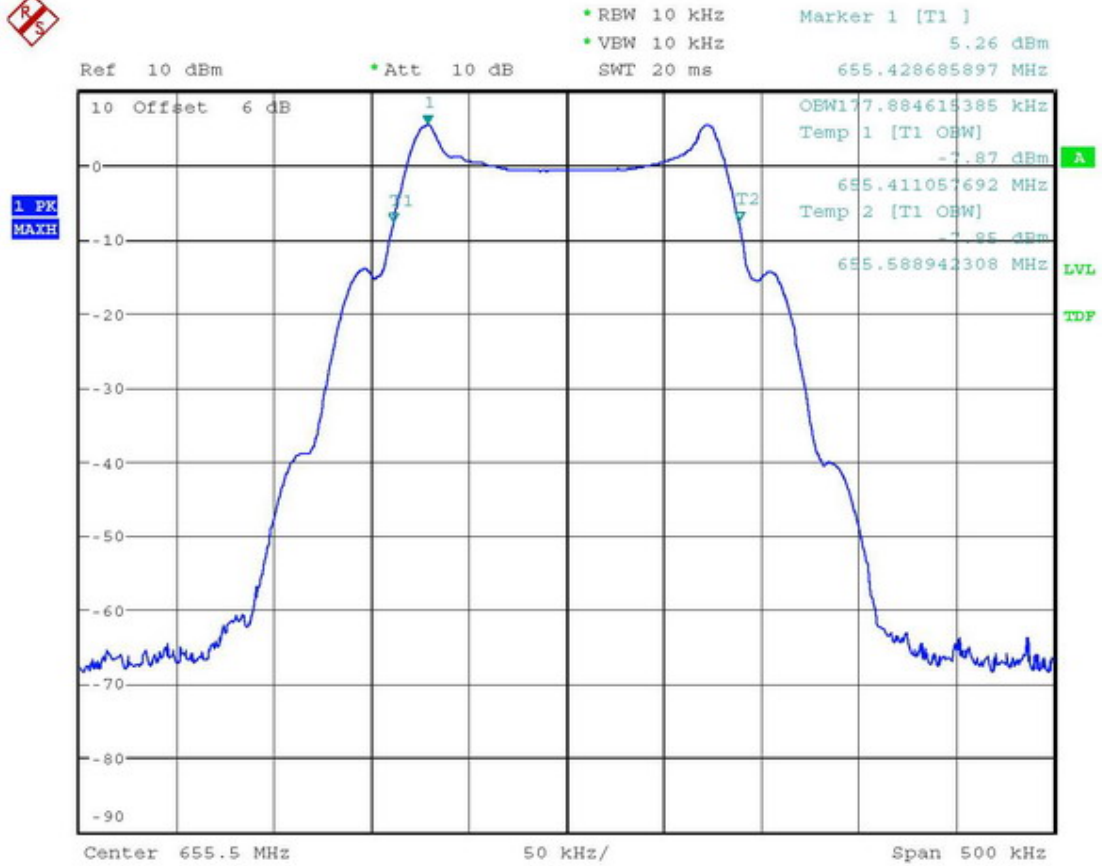

OCCUPIED BANDWIDTH 2.5KHz
Date: 1.OCT.2010 14:31:29



Worldwide Testing Services(Taiwan) Co., Ltd.

Registration number: W6M21009-10893-C-1

FCC ID: M5X-ACT202T

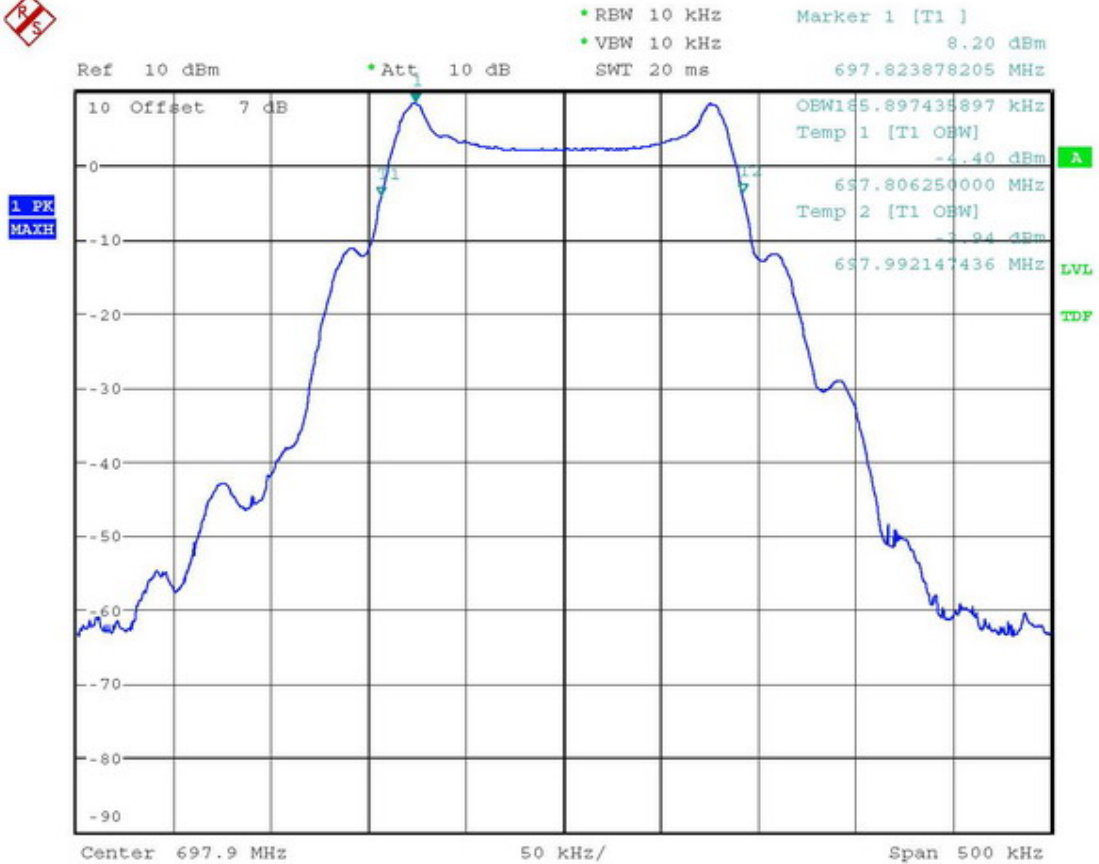

OCCUPIED BANDWIDTH 2.5KHz
Date: 1.OCT.2010 14:02:32



Worldwide Testing Services(Taiwan) Co., Ltd.

Registration number: W6M21009-10893-C-1

FCC ID: M5X-ACT202T

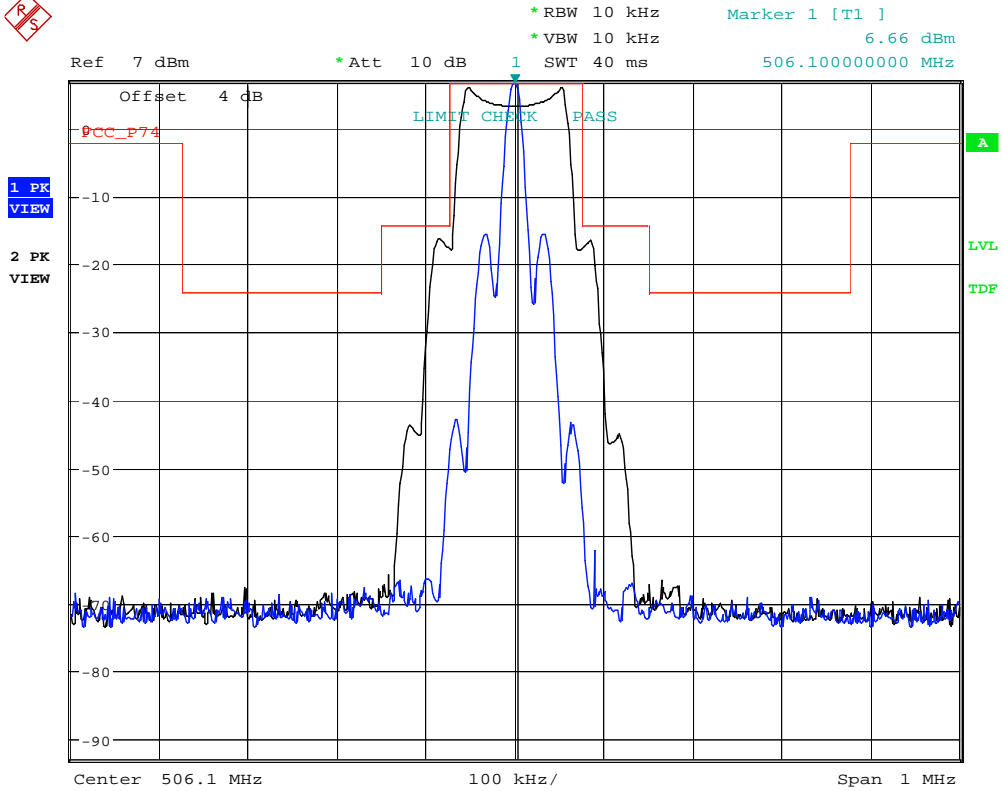

EMISSION MASK

Date: 1.OCT.2010 10:02:51



Registration number: W6M21009-10893-C-1

FCC ID: M5X-ACT202T

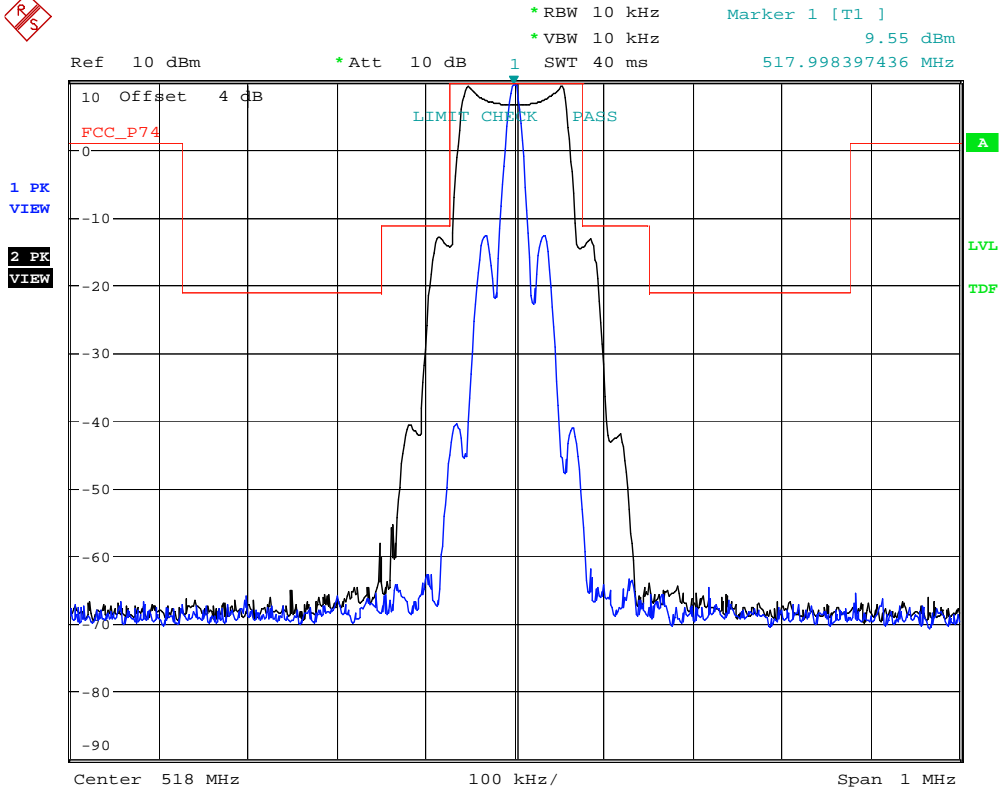

EMISSION MASK

Date: 1.OCT.2010 09:57:06



Registration number: W6M21009-10893-C-1

FCC ID: M5X-ACT202T

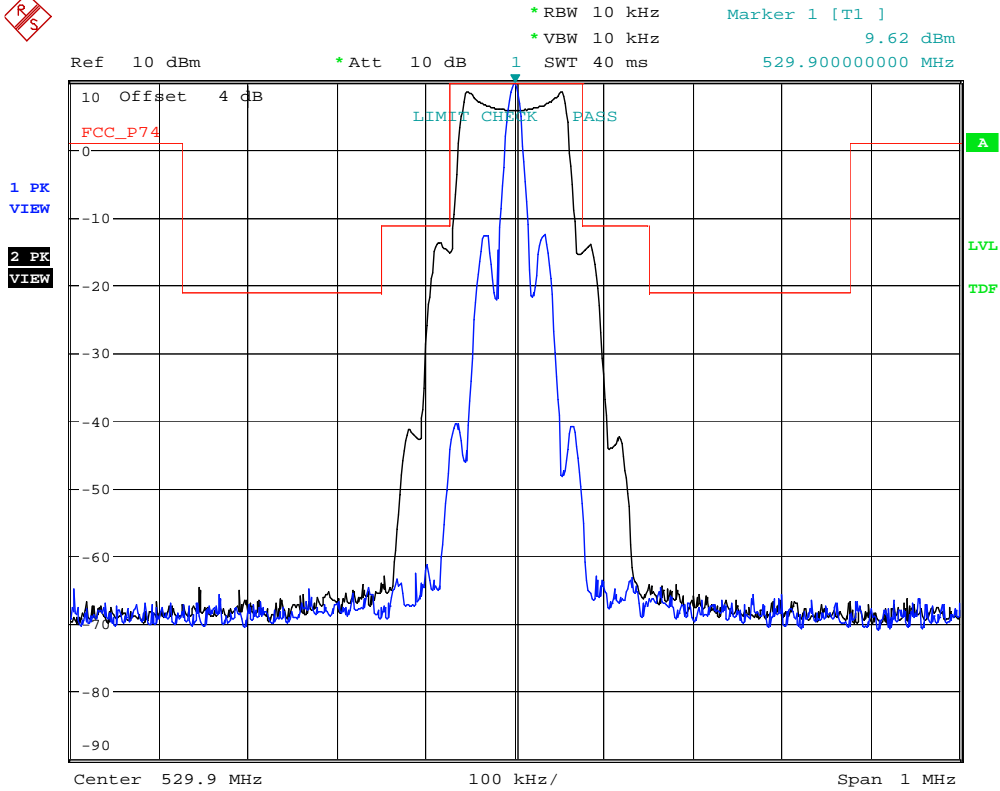

EMISSION MASK

Date: 1.OCT.2010 09:46:37



Registration number: W6M21009-10893-C-1

FCC ID: M5X-ACT202T

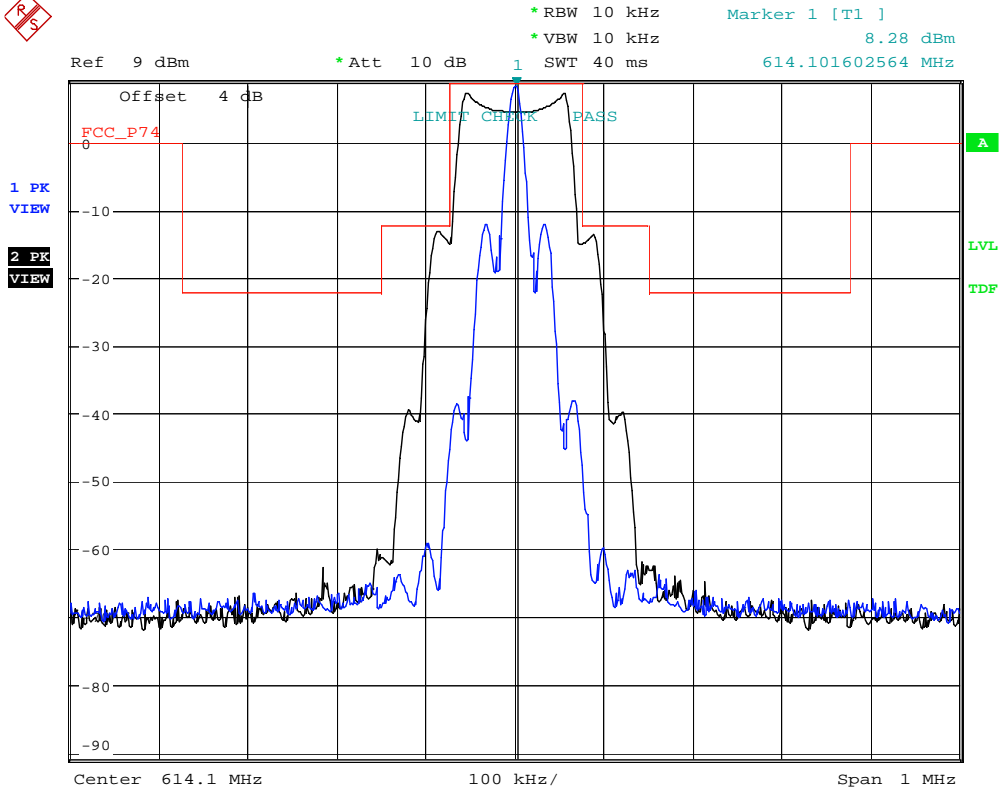

EMISSION MASK

Date: 1.OCT.2010 13:44:30



Registration number: W6M21009-10893-C-1

FCC ID: M5X-ACT202T

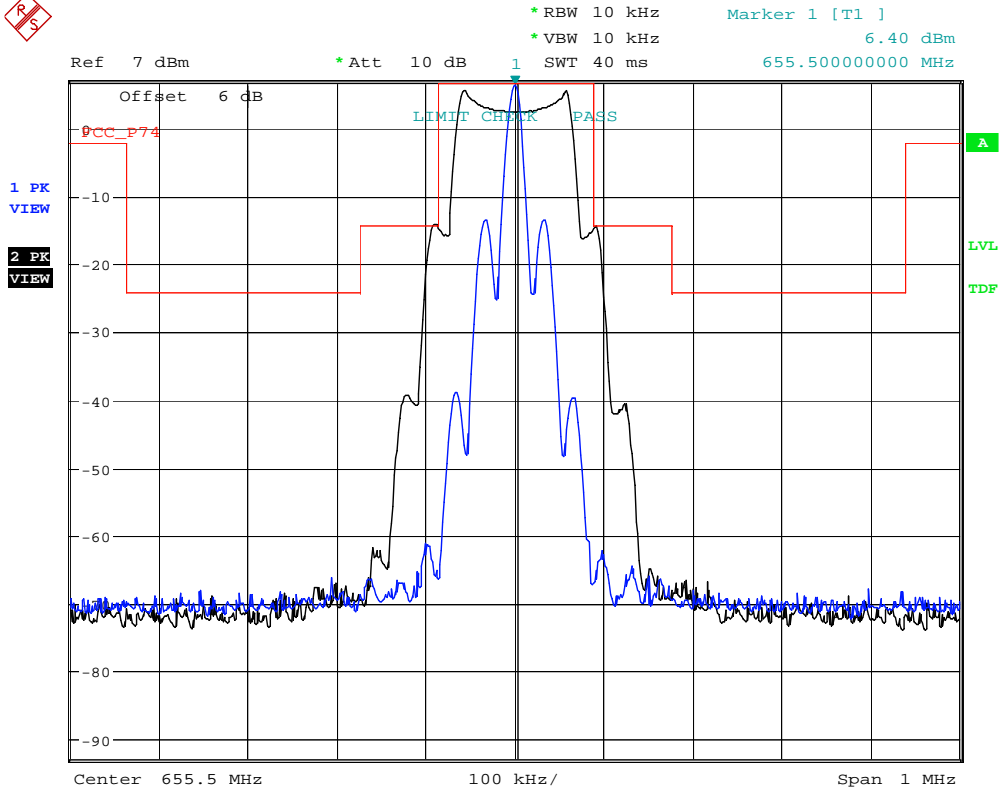

EMISSION MASK

Date: 1.OCT.2010 14:39:25



Registration number: W6M21009-10893-C-1

FCC ID: M5X-ACT202T

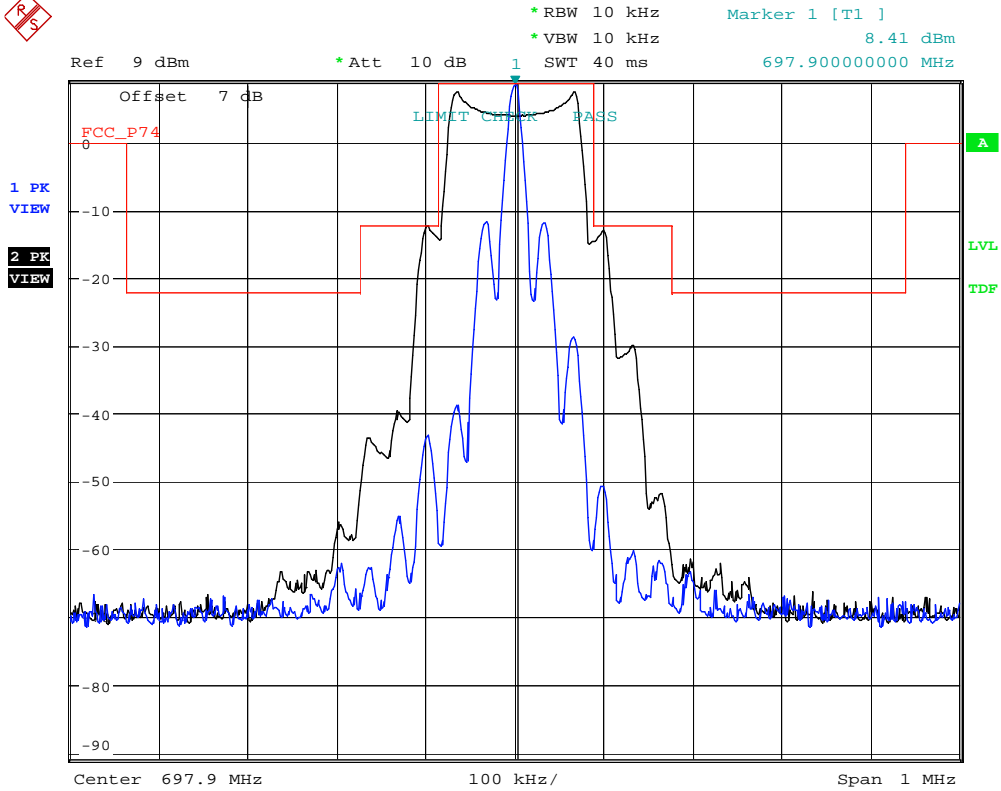

EMISSION MASK

Date: 1.OCT.2010 14:14:28



Registration number: W6M21009-10893-C-1

FCC ID: M5X-ACT202T

Radiation Spurious Emission

506.1 MHz

Antenna Polarization H

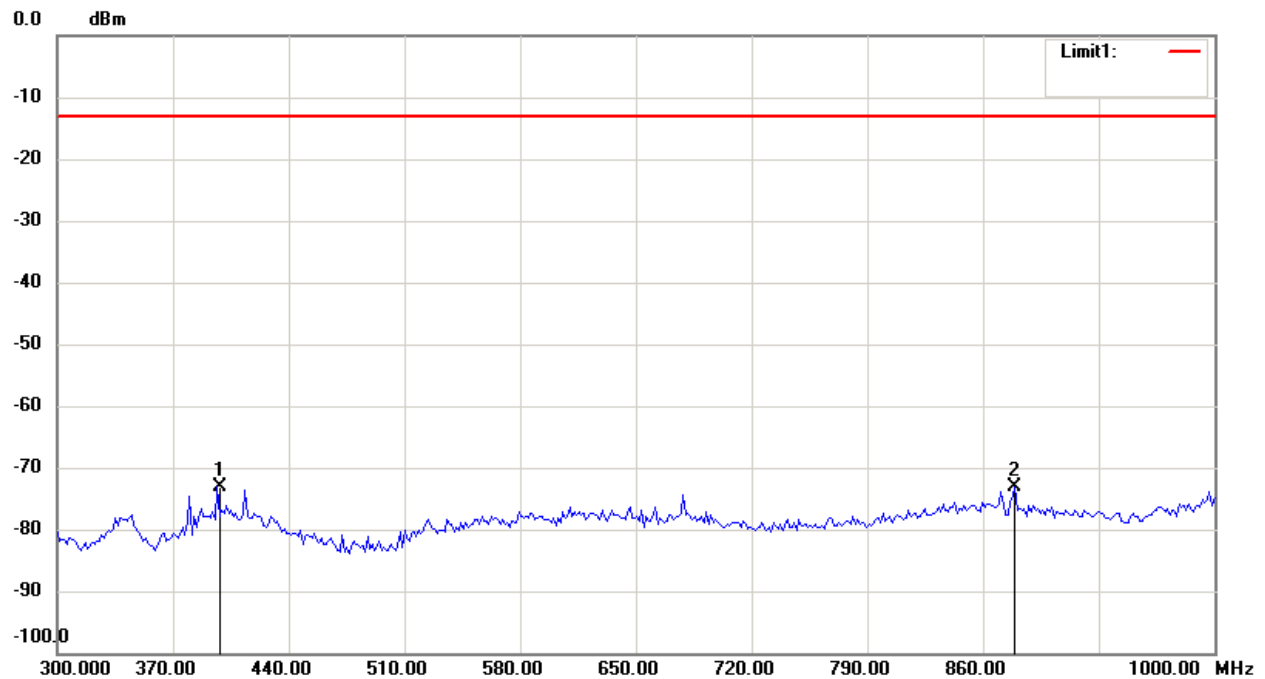
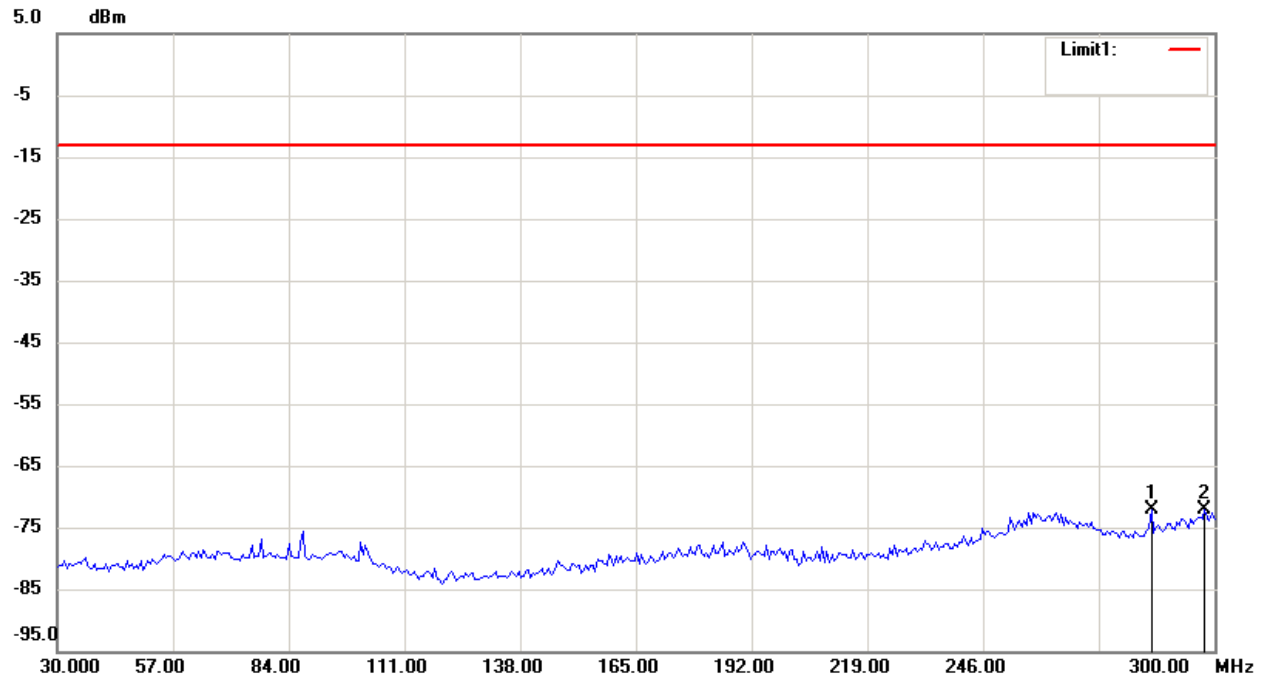

Note:

1. The attached measurement plots are preliminarily pre-scanned with peak detector for determining the final checking frequencies and are for reference only.
2. The some frequencies may exceed the limit line without the specified detectors, but that cannot present the results are failed to the specification of test standard.
3. For corrected test results are listed in the relevant table of radiated test data of this test report.



Registration number: W6M21009-10893-C-1

FCC ID: M5X-ACT202T

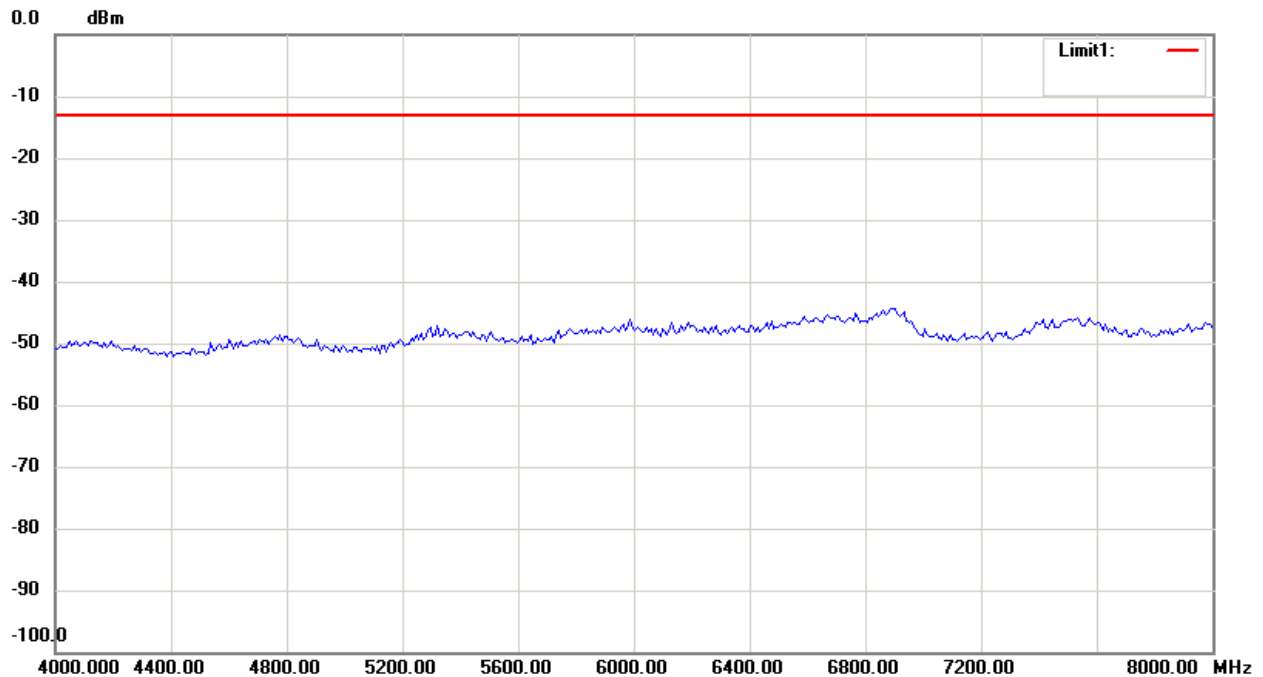
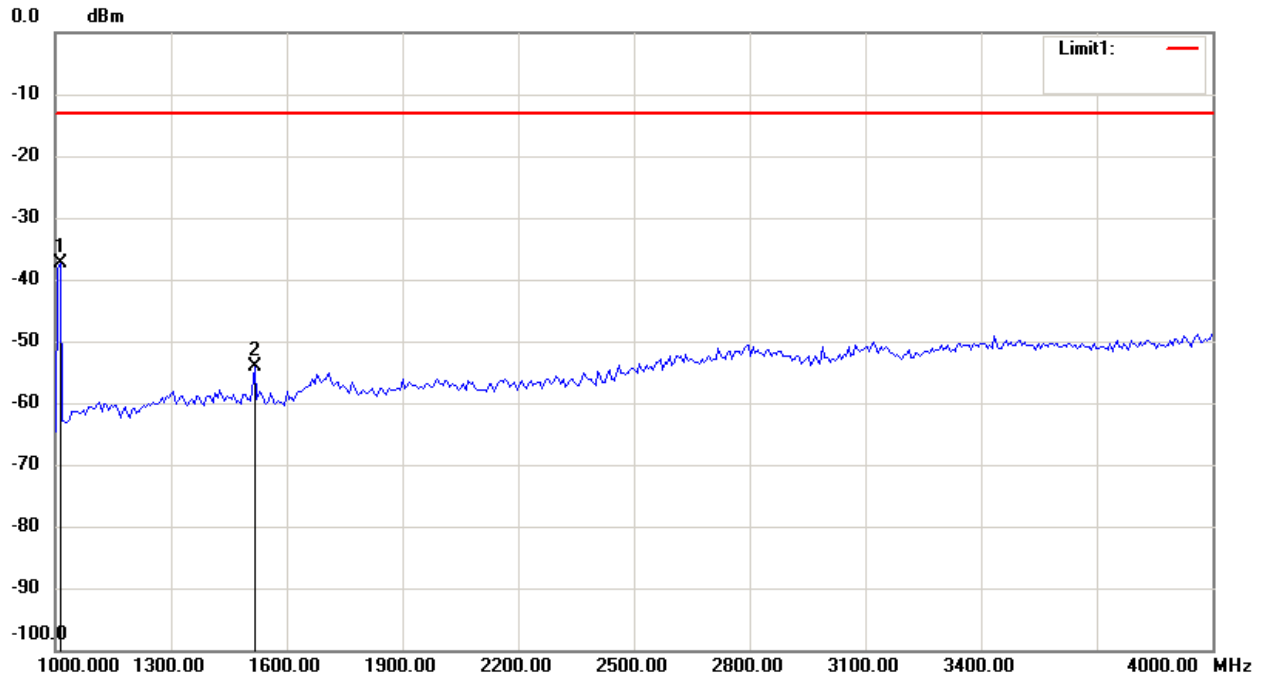

Note:

1. The attached measurement plots are preliminarily pre-scanned with peak detector for determining the final checking frequencies and are for reference only.
2. The some frequencies may exceed the limit line without the specified detectors, but that cannot present the results are failed to the specification of test standard.
3. For corrected test results are listed in the relevant table of radiated test data of this test report.



Registration number: W6M21009-10893-C-1

FCC ID: M5X-ACT202T

Antenna Polarization V

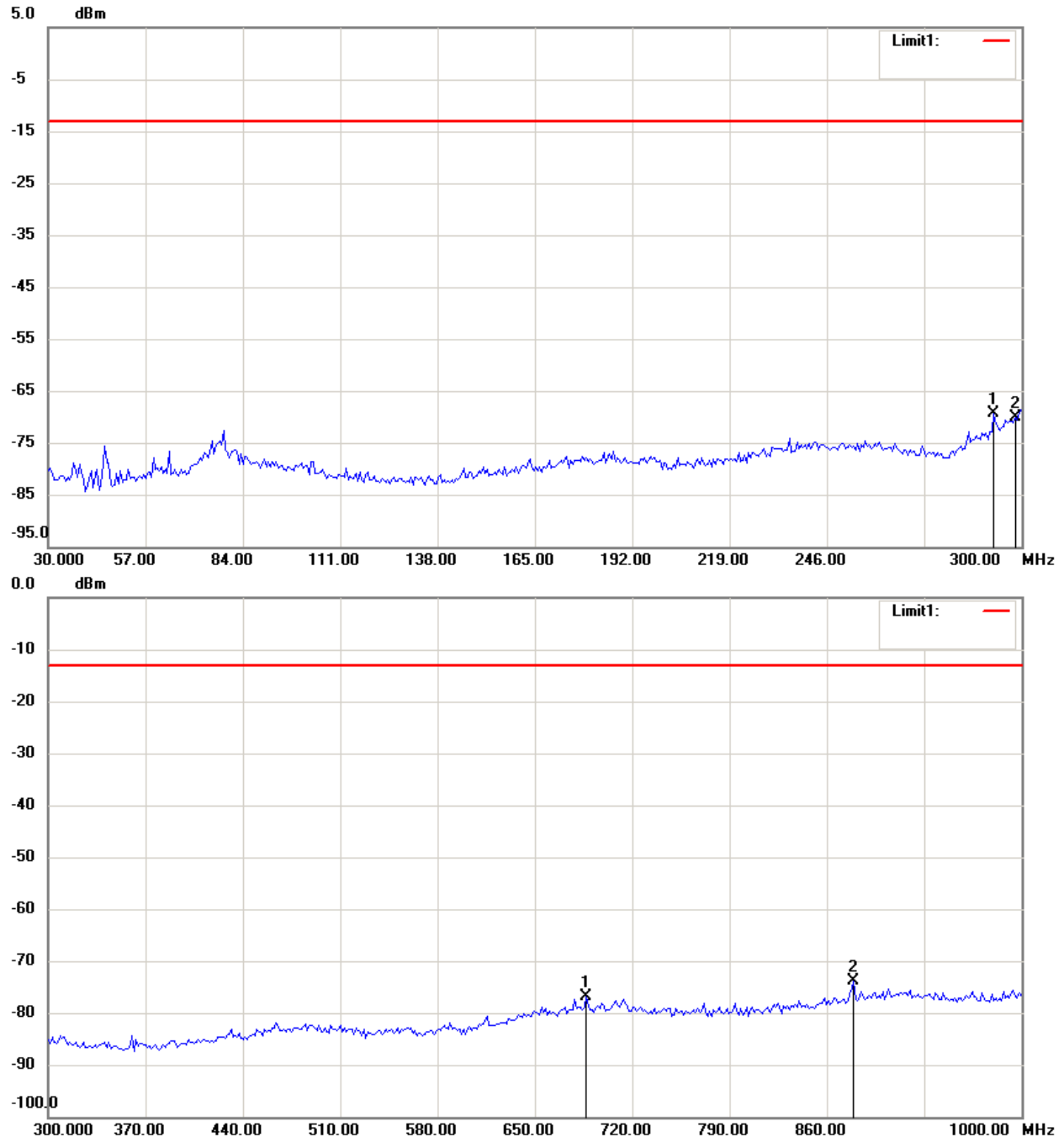

Note:

1. The attached measurement plots are preliminarily pre-scanned with peak detector for determining the final checking frequencies and are for reference only.
2. The some frequencies may exceed the limit line without the specified detectors, but that cannot present the results are failed to the specification of test standard.
3. For corrected test results are listed in the relevant table of radiated test data of this test report.



Registration number: W6M21009-10893-C-1

FCC ID: M5X-ACT202T

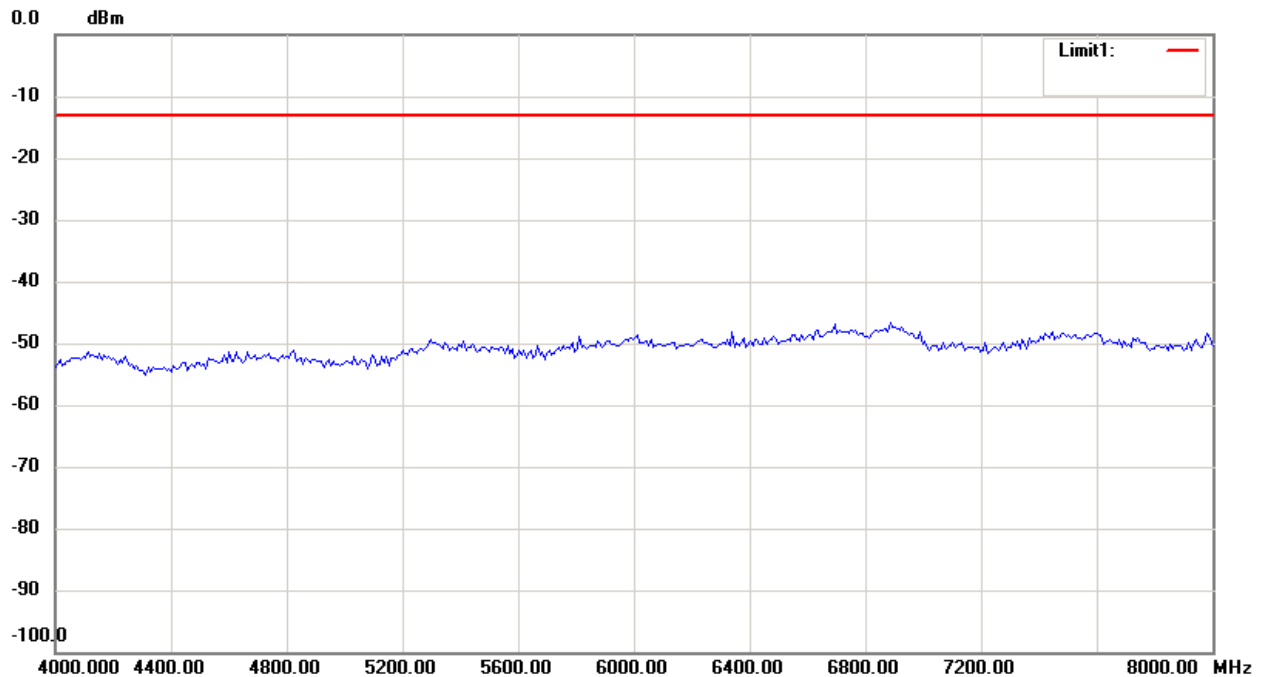
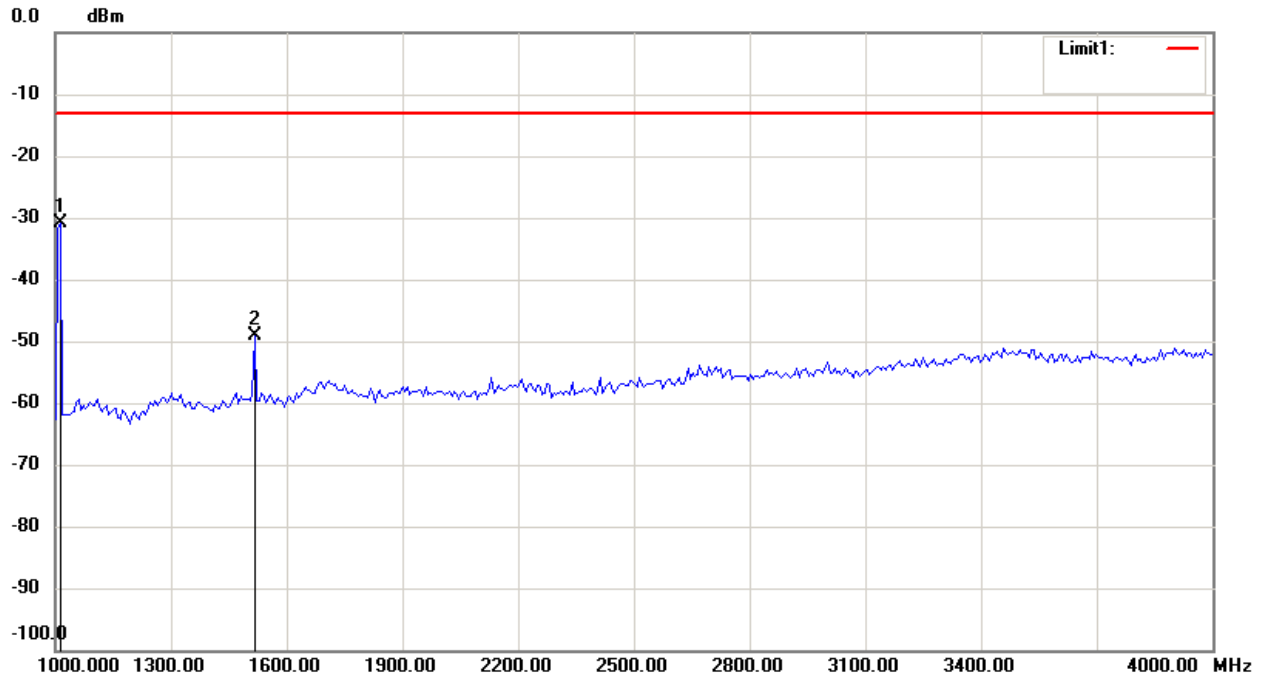

Note:

1. The attached measurement plots are preliminarily pre-scanned with peak detector for determining the final checking frequencies and are for reference only.
2. The some frequencies may exceed the limit line without the specified detectors, but that cannot present the results are failed to the specification of test standard.
3. For corrected test results are listed in the relevant table of radiated test data of this test report.



Registration number: W6M21009-10893-C-1

FCC ID: M5X-ACT202T

518.0 MHz

Antenna Polarization H

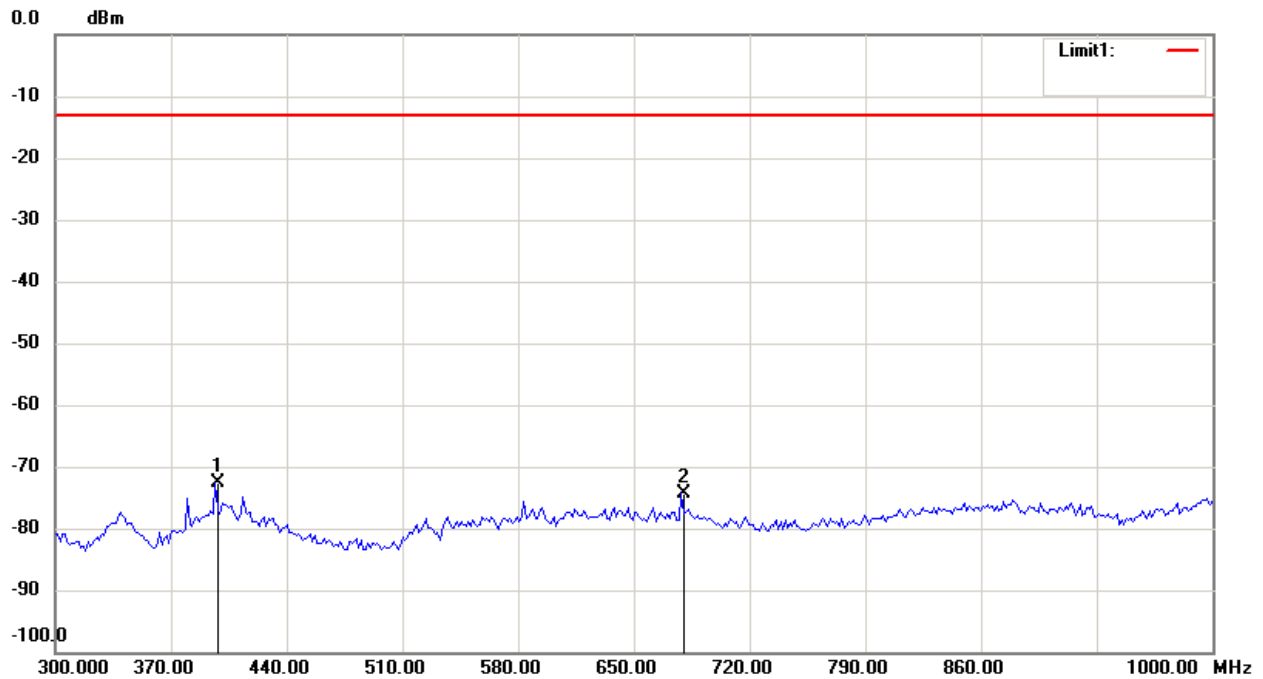
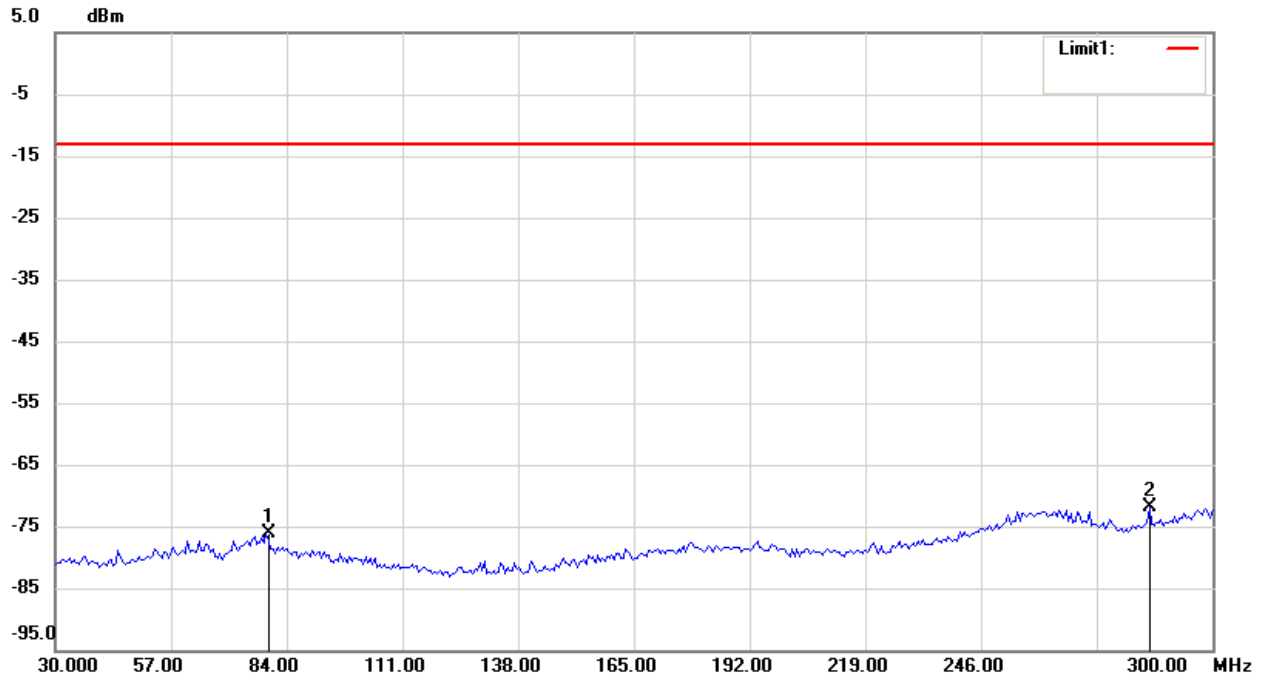

Note:

1. The attached measurement plots are preliminarily pre-scanned with peak detector for determining the final checking frequencies and are for reference only.
2. The some frequencies may exceed the limit line without the specified detectors, but that cannot present the results are failed to the specification of test standard.
3. For corrected test results are listed in the relevant table of radiated test data of this test report.



Registration number: W6M21009-10893-C-1

FCC ID: M5X-ACT202T

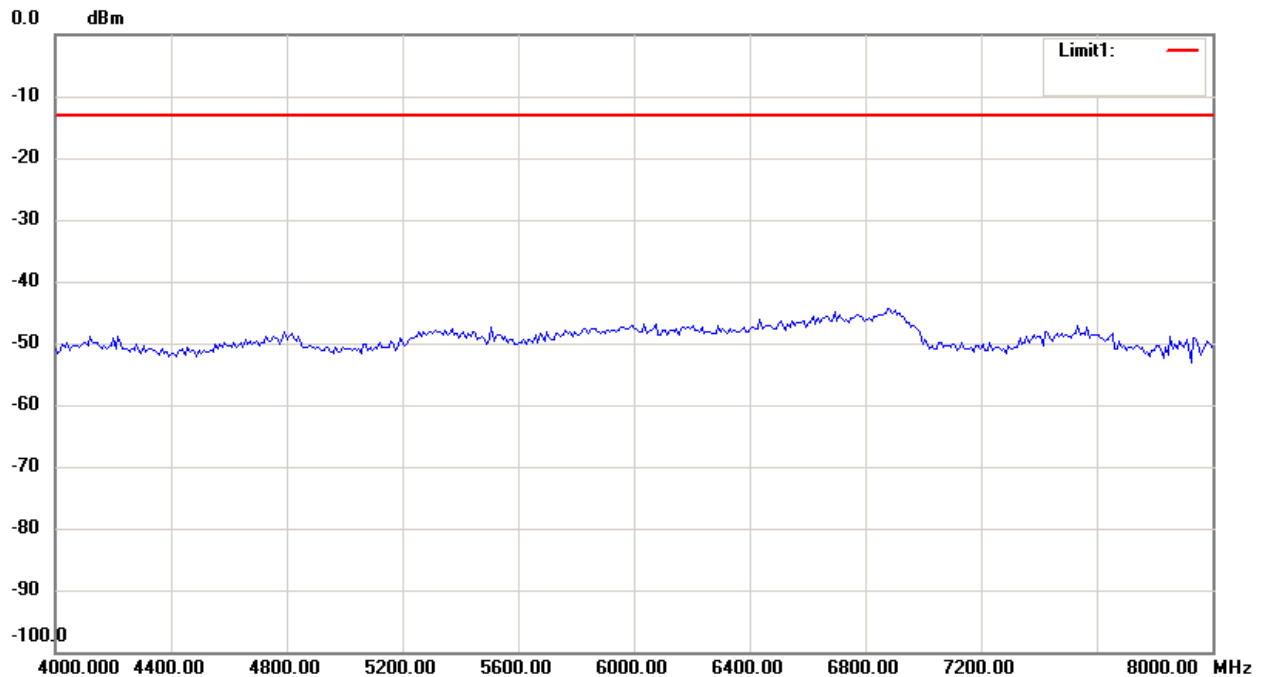
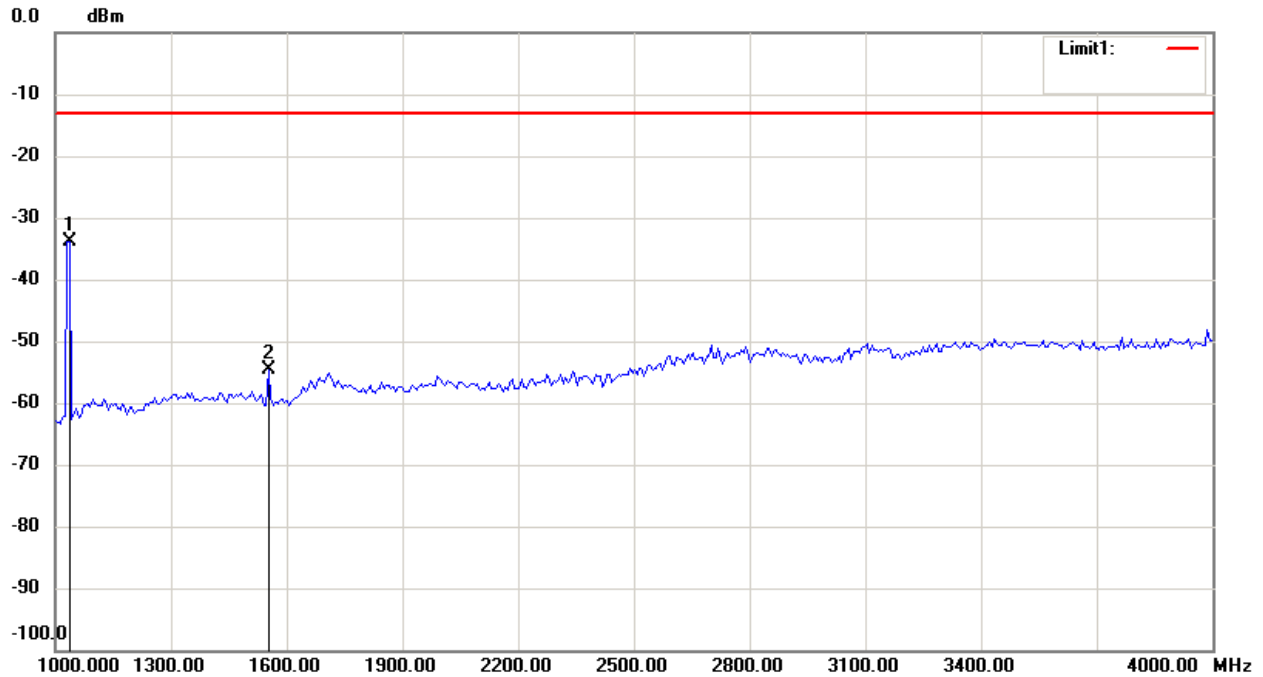

Note:

1. The attached measurement plots are preliminarily pre-scanned with peak detector for determining the final checking frequencies and are for reference only.
2. The some frequencies may exceed the limit line without the specified detectors, but that cannot present the results are failed to the specification of test standard.
3. For corrected test results are listed in the relevant table of radiated test data of this test report.



Registration number: W6M21009-10893-C-1

FCC ID: M5X-ACT202T

Antenna Polarization V

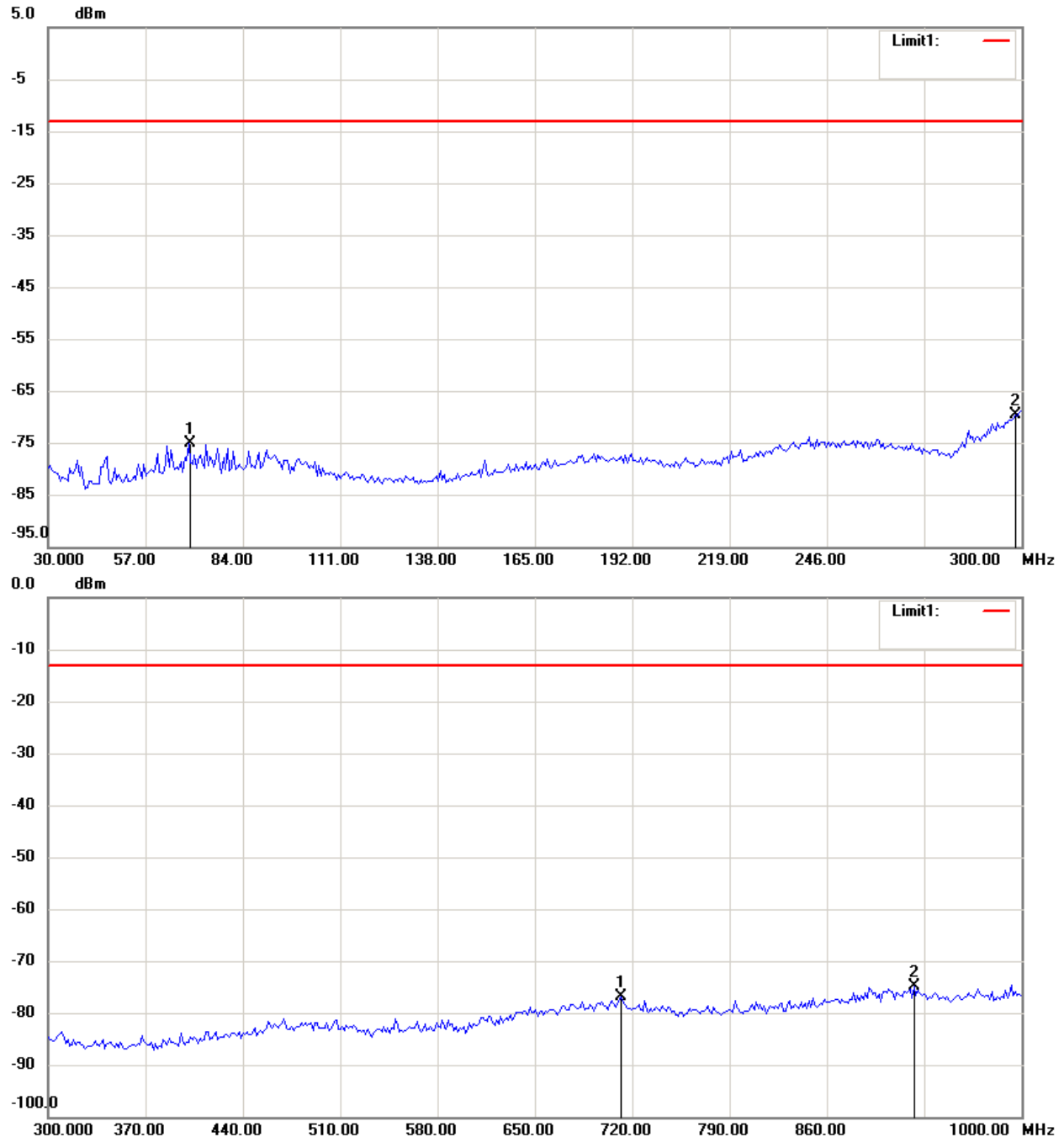

Note:

1. The attached measurement plots are preliminarily pre-scanned with peak detector for determining the final checking frequencies and are for reference only.
2. The some frequencies may exceed the limit line without the specified detectors, but that cannot present the results are failed to the specification of test standard.
3. For corrected test results are listed in the relevant table of radiated test data of this test report.



Registration number: W6M21009-10893-C-1

FCC ID: M5X-ACT202T

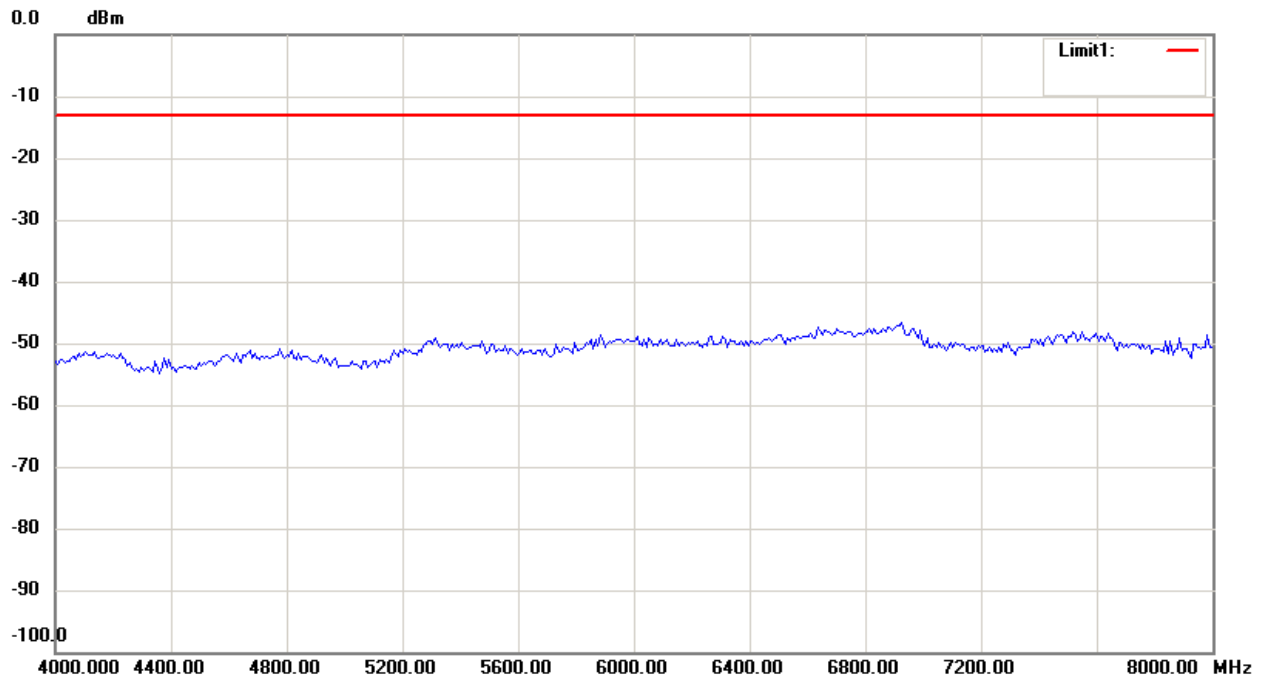
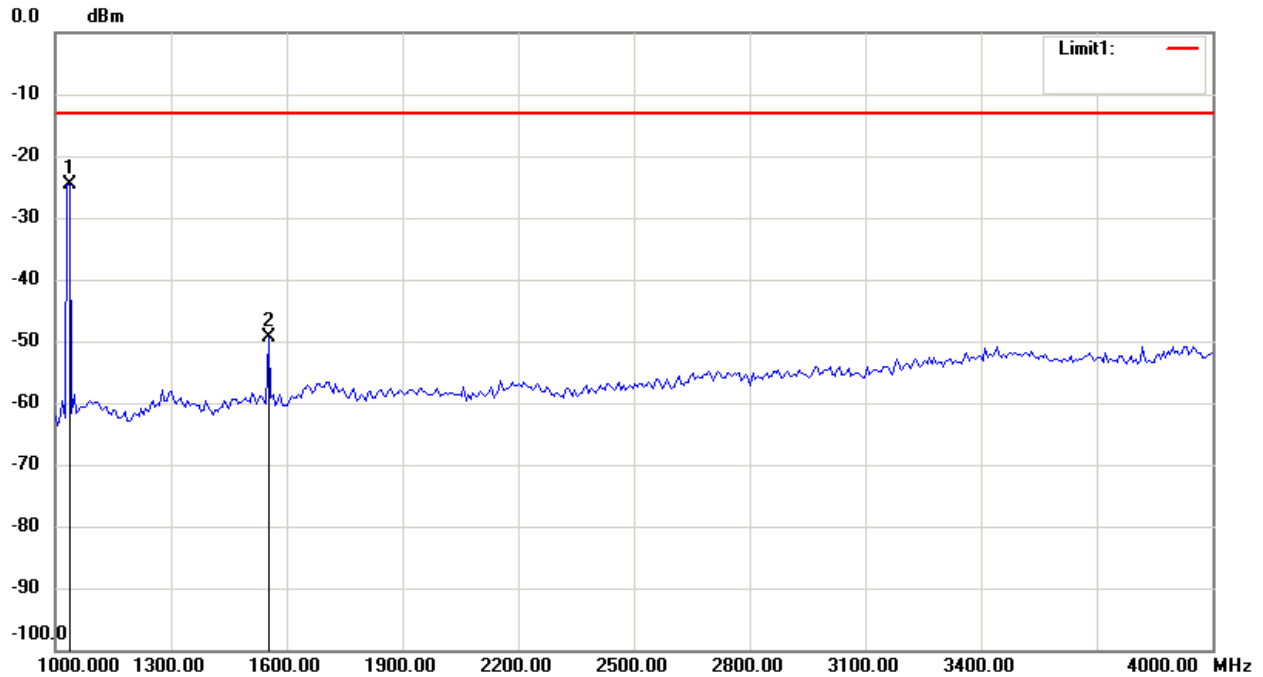

Note:

1. The attached measurement plots are preliminarily pre-scanned with peak detector for determining the final checking frequencies and are for reference only.
2. The some frequencies may exceed the limit line without the specified detectors, but that cannot present the results are failed to the specification of test standard.
3. For corrected test results are listed in the relevant table of radiated test data of this test report.



Registration number: W6M21009-10893-C-1

FCC ID: M5X-ACT202T

529.9 MHz

Antenna Polarization H

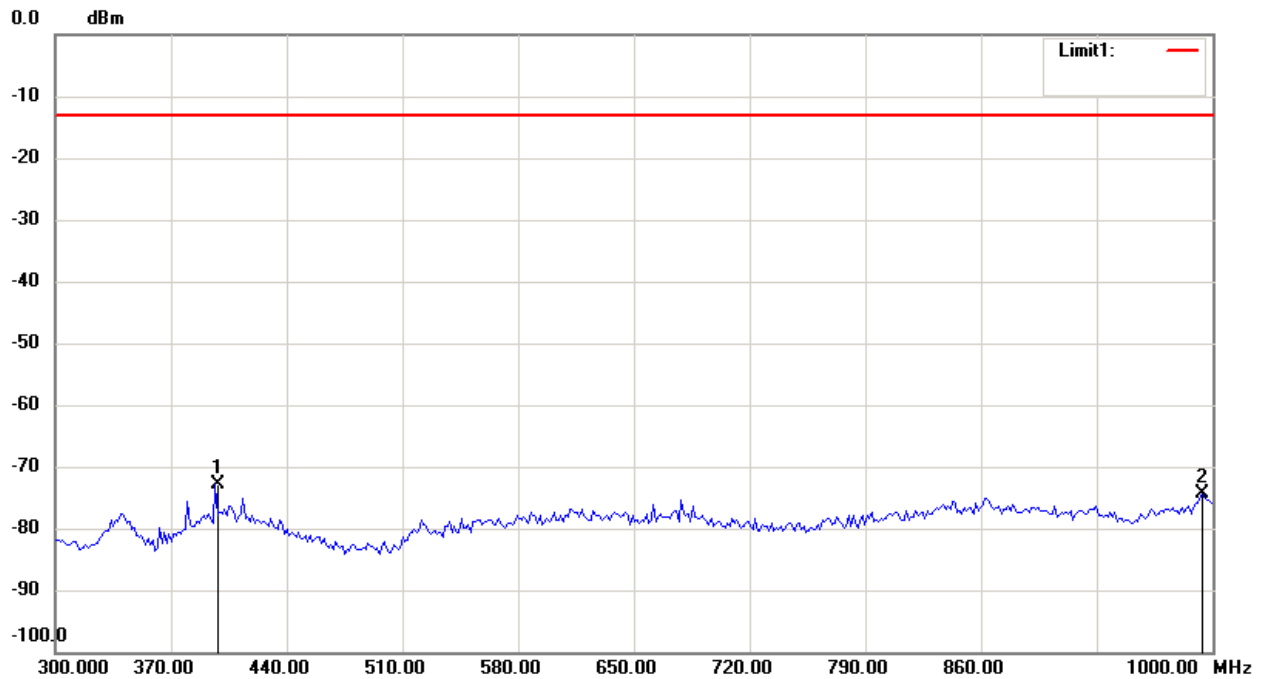
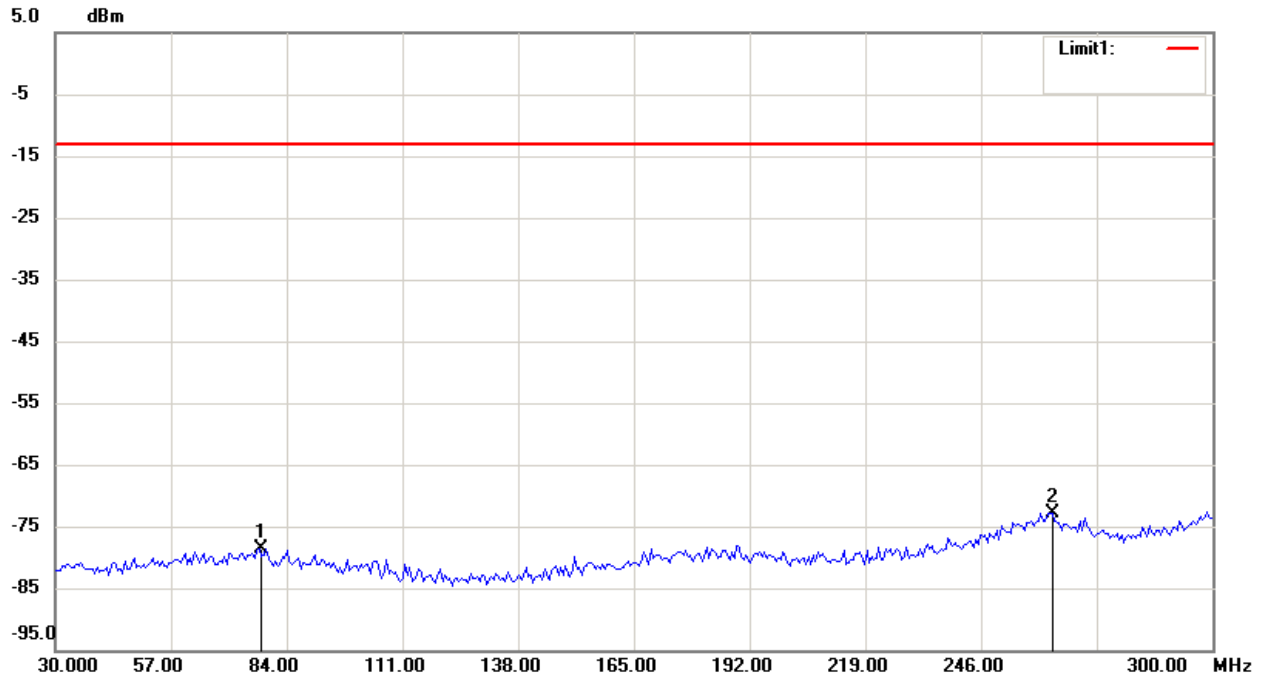

Note:

1. The attached measurement plots are preliminarily pre-scanned with peak detector for determining the final checking frequencies and are for reference only.
2. The some frequencies may exceed the limit line without the specified detectors, but that cannot present the results are failed to the specification of test standard.
3. For corrected test results are listed in the relevant table of radiated test data of this test report.



Registration number: W6M21009-10893-C-1

FCC ID: M5X-ACT202T

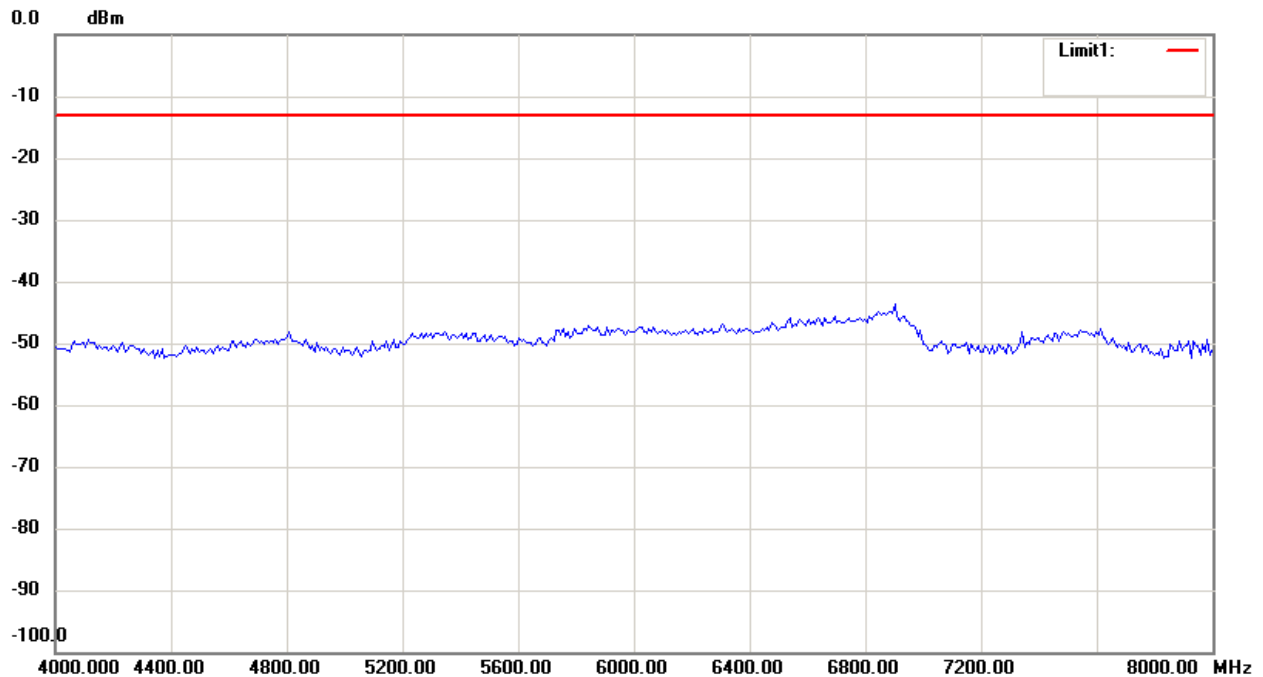
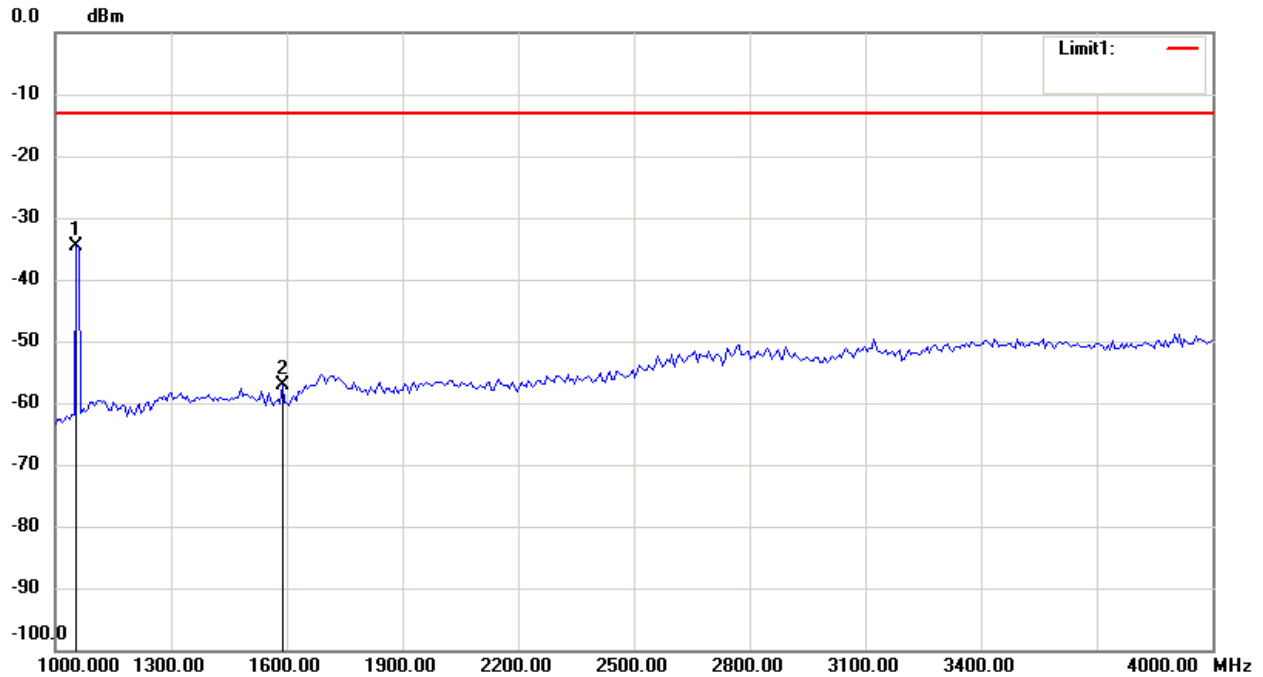

Note:

1. The attached measurement plots are preliminarily pre-scanned with peak detector for determining the final checking frequencies and are for reference only.
2. The some frequencies may exceed the limit line without the specified detectors, but that cannot present the results are failed to the specification of test standard.
3. For corrected test results are listed in the relevant table of radiated test data of this test report.



Registration number: W6M21009-10893-C-1

FCC ID: M5X-ACT202T

Antenna Polarization V

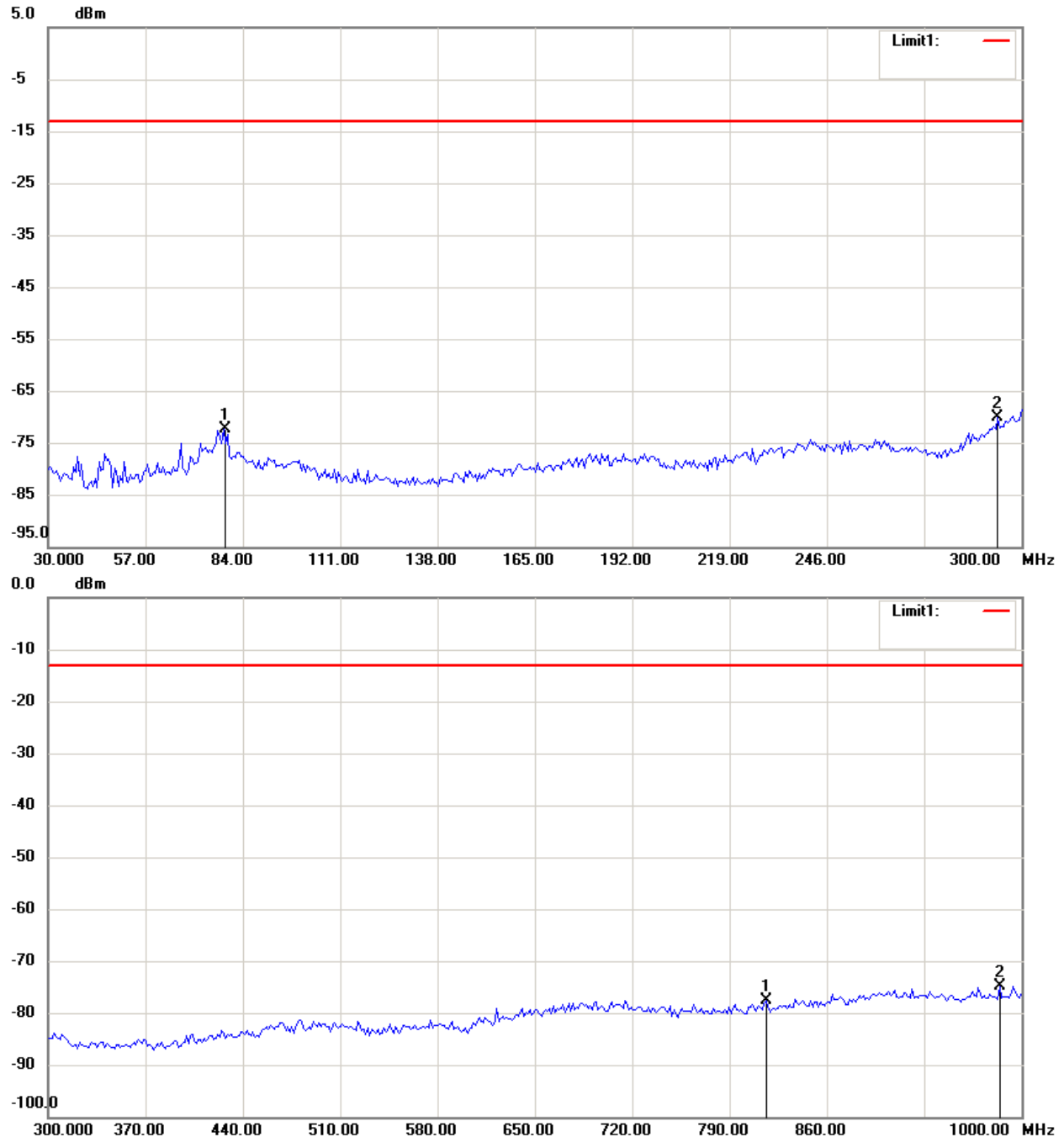

Note:

1. The attached measurement plots are preliminarily pre-scanned with peak detector for determining the final checking frequencies and are for reference only.
2. The some frequencies may exceed the limit line without the specified detectors, but that cannot present the results are failed to the specification of test standard.
3. For corrected test results are listed in the relevant table of radiated test data of this test report.



Registration number: W6M21009-10893-C-1

FCC ID: M5X-ACT202T

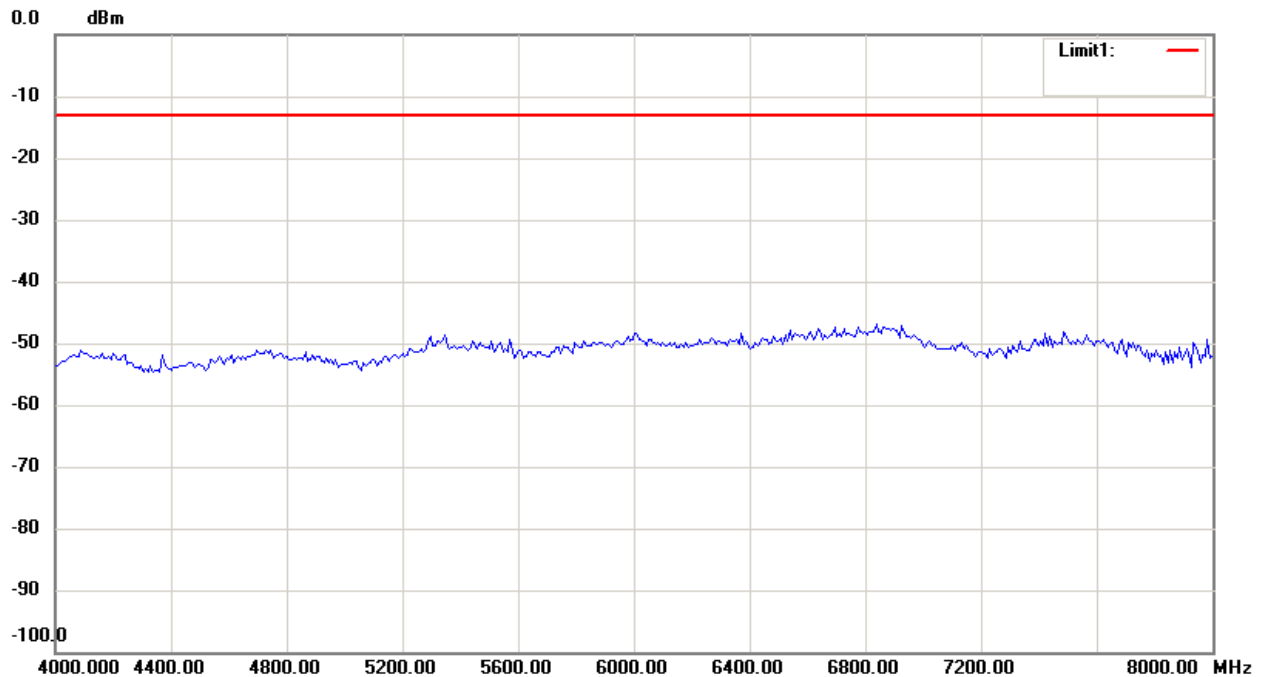
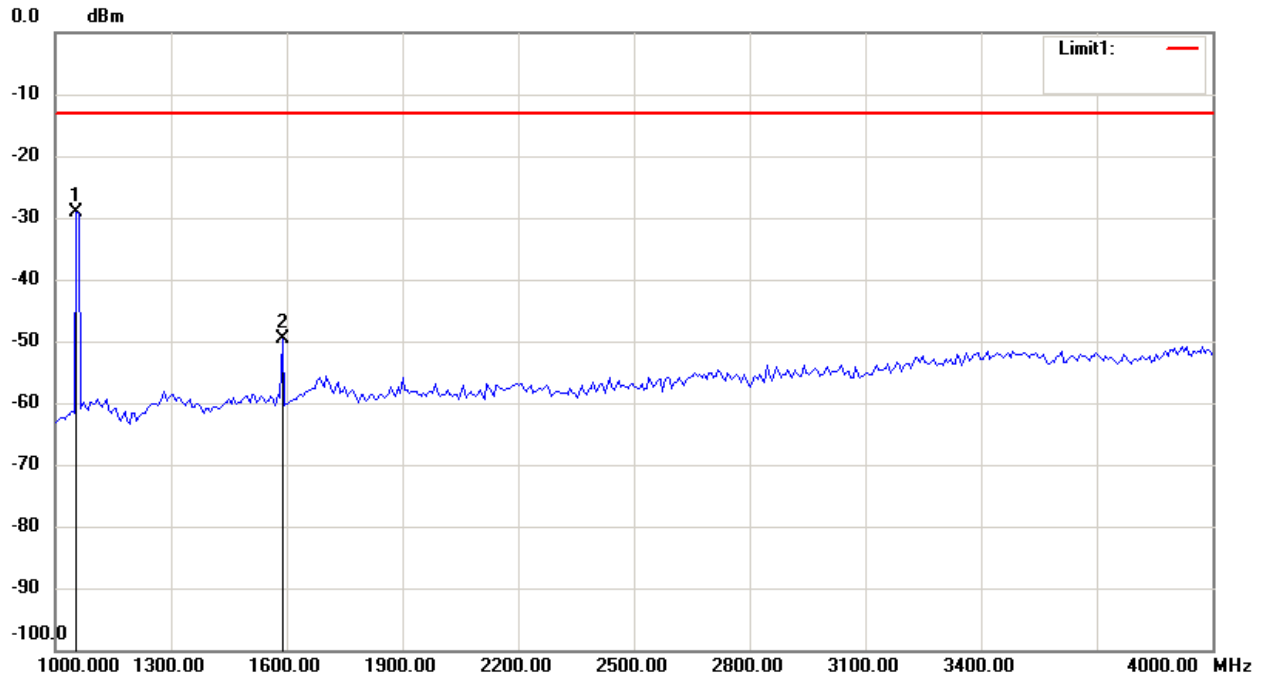

Note:

1. The attached measurement plots are preliminarily pre-scanned with peak detector for determining the final checking frequencies and are for reference only.
2. The some frequencies may exceed the limit line without the specified detectors, but that cannot present the results are failed to the specification of test standard.
3. For corrected test results are listed in the relevant table of radiated test data of this test report.



Registration number: W6M21009-10893-C-1

FCC ID: M5X-ACT202T

614.1 MHz

Antenna Polarization H

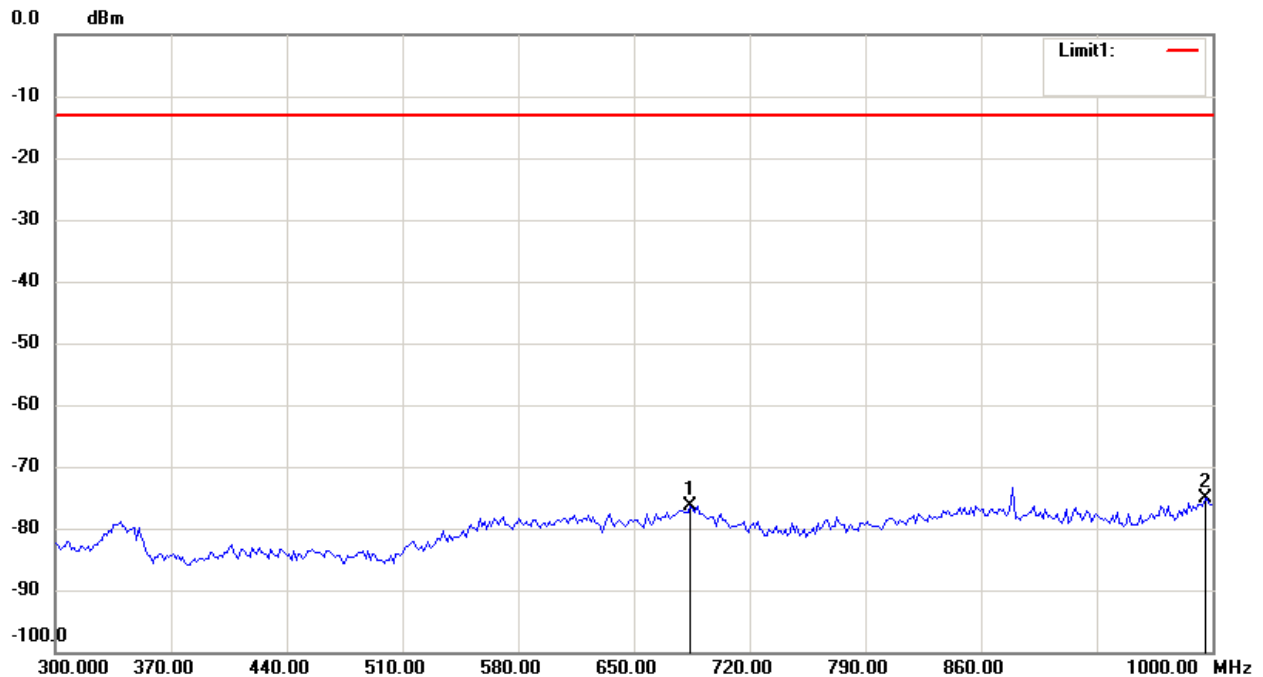
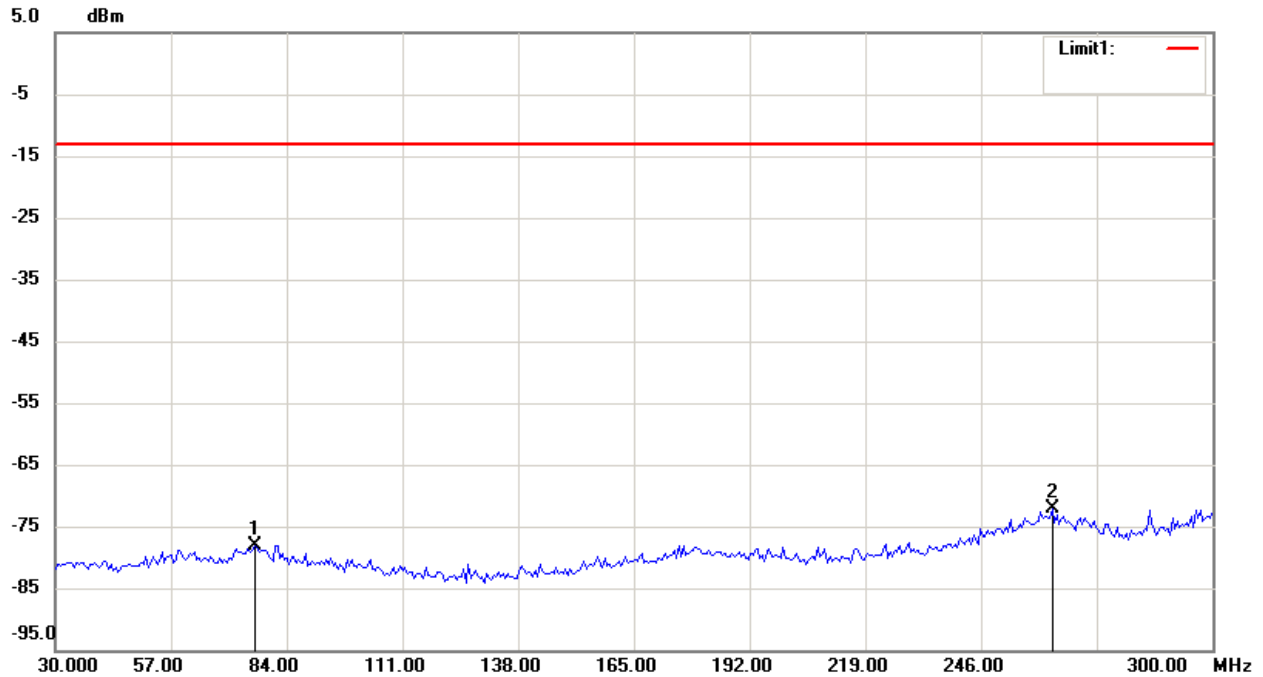

Note:

1. The attached measurement plots are preliminarily pre-scanned with peak detector for determining the final checking frequencies and are for reference only.
2. The some frequencies may exceed the limit line without the specified detectors, but that cannot present the results are failed to the specification of test standard.
3. For corrected test results are listed in the relevant table of radiated test data of this test report.



Registration number: W6M21009-10893-C-1

FCC ID: M5X-ACT202T

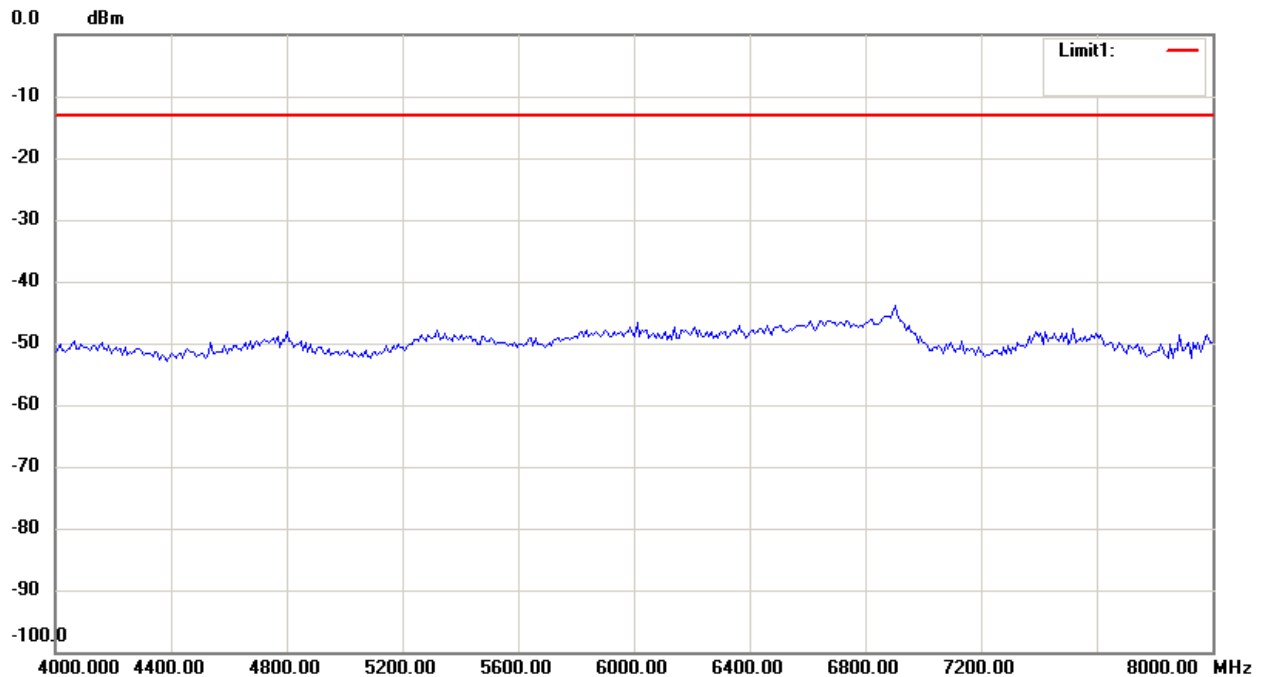
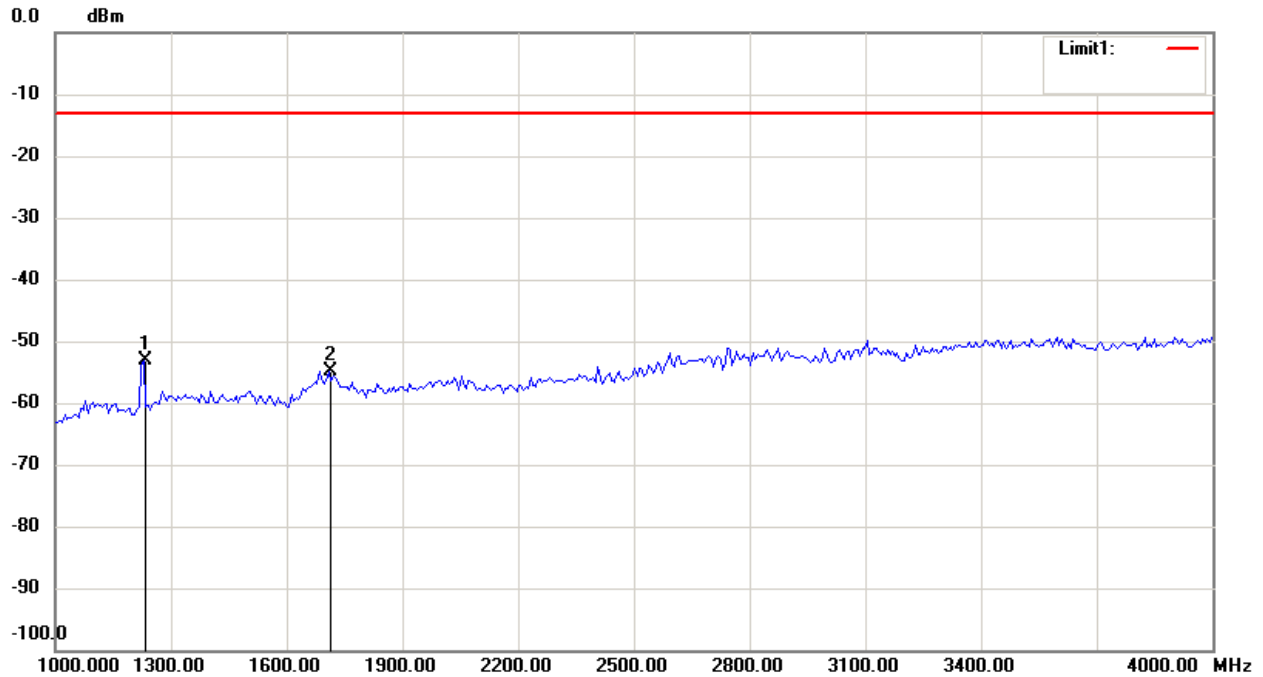

Note:

1. The attached measurement plots are preliminarily pre-scanned with peak detector for determining the final checking frequencies and are for reference only.
2. The some frequencies may exceed the limit line without the specified detectors, but that cannot present the results are failed to the specification of test standard.
3. For corrected test results are listed in the relevant table of radiated test data of this test report.



Registration number: W6M21009-10893-C-1

FCC ID: M5X-ACT202T

Antenna Polarization V

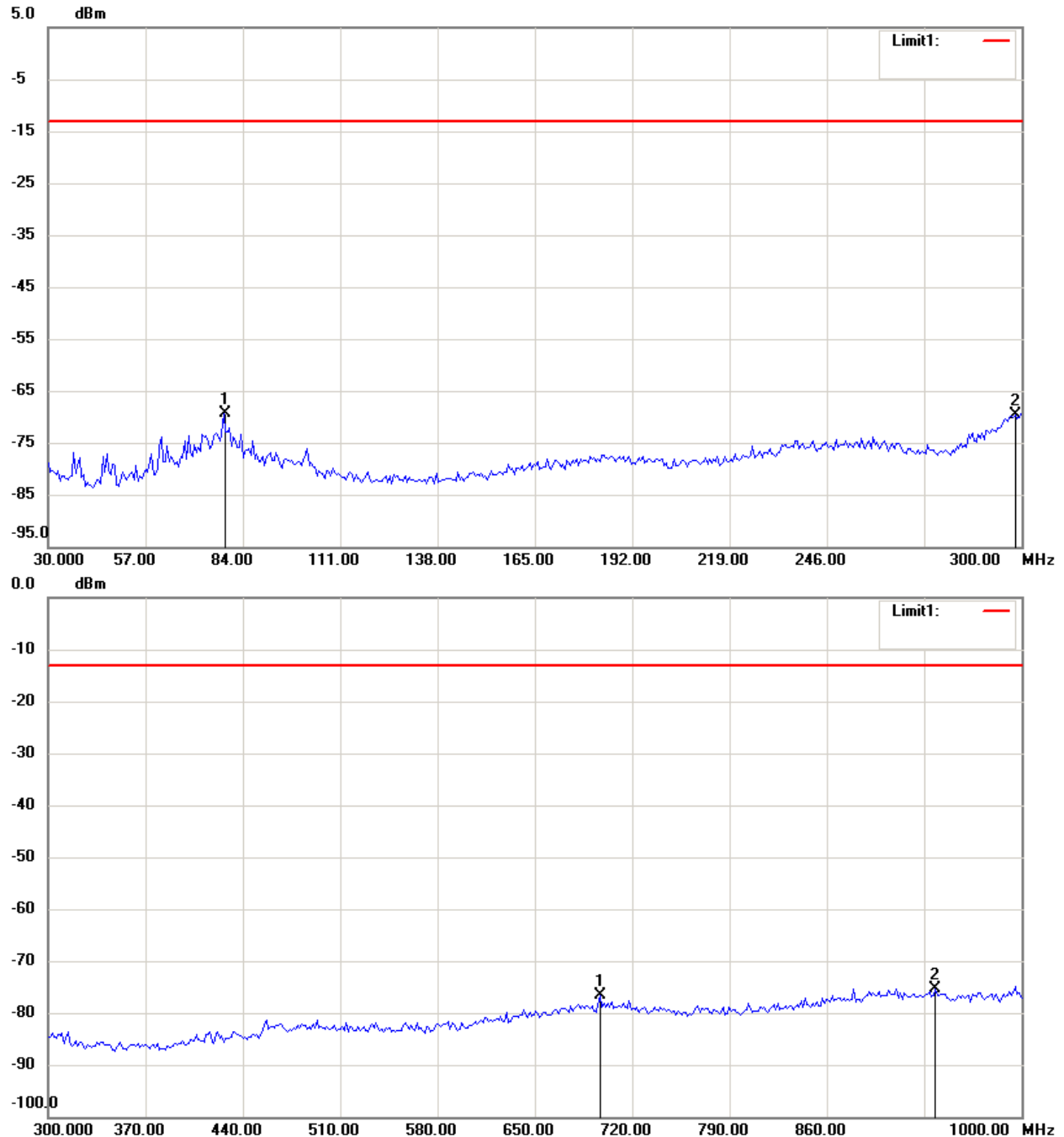

Note:

1. The attached measurement plots are preliminarily pre-scanned with peak detector for determining the final checking frequencies and are for reference only.
2. The some frequencies may exceed the limit line without the specified detectors, but that cannot present the results are failed to the specification of test standard.
3. For corrected test results are listed in the relevant table of radiated test data of this test report.



Registration number: W6M21009-10893-C-1

FCC ID: M5X-ACT202T

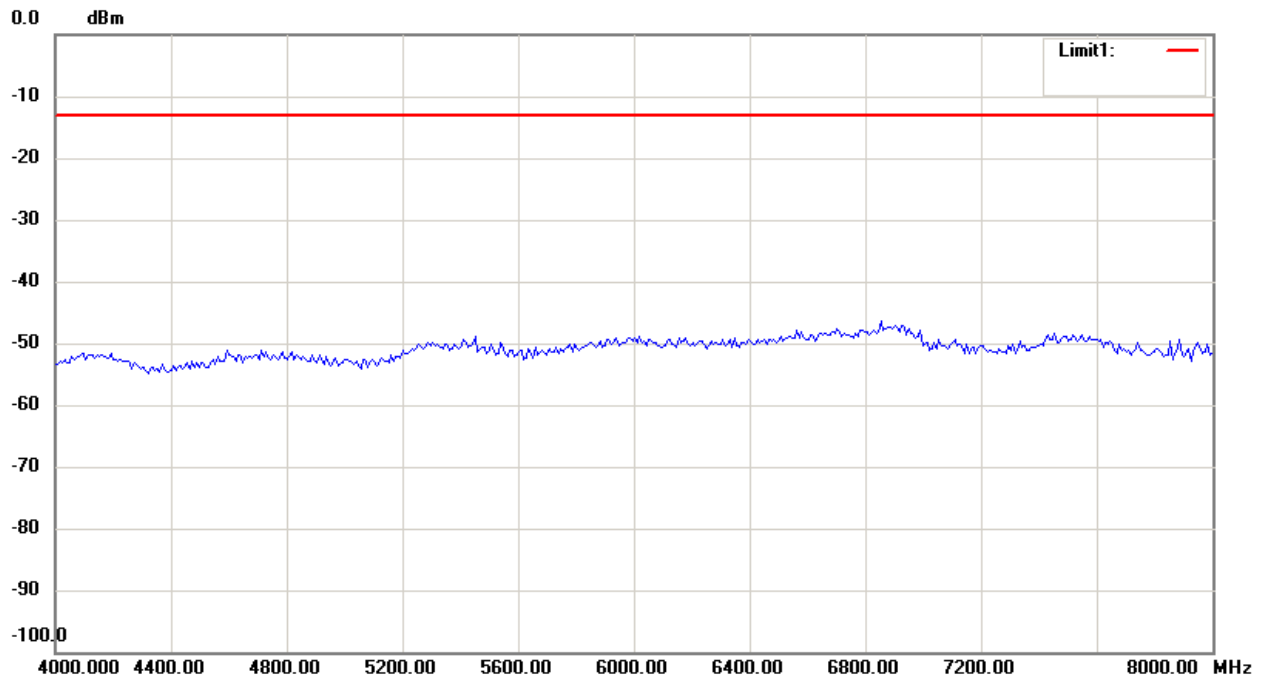
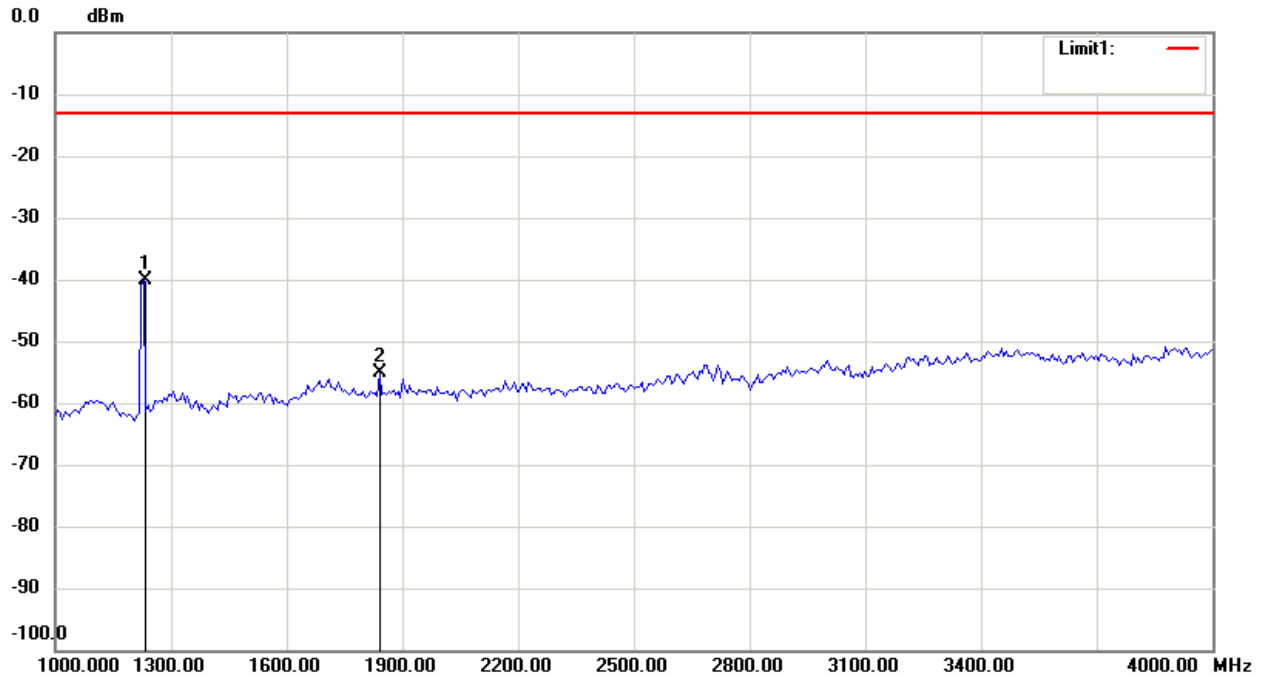

Note:

1. The attached measurement plots are preliminarily pre-scanned with peak detector for determining the final checking frequencies and are for reference only.
2. The some frequencies may exceed the limit line without the specified detectors, but that cannot present the results are failed to the specification of test standard.
3. For corrected test results are listed in the relevant table of radiated test data of this test report.



Registration number: W6M21009-10893-C-1

FCC ID: M5X-ACT202T

655.5 MHz

Antenna Polarization H

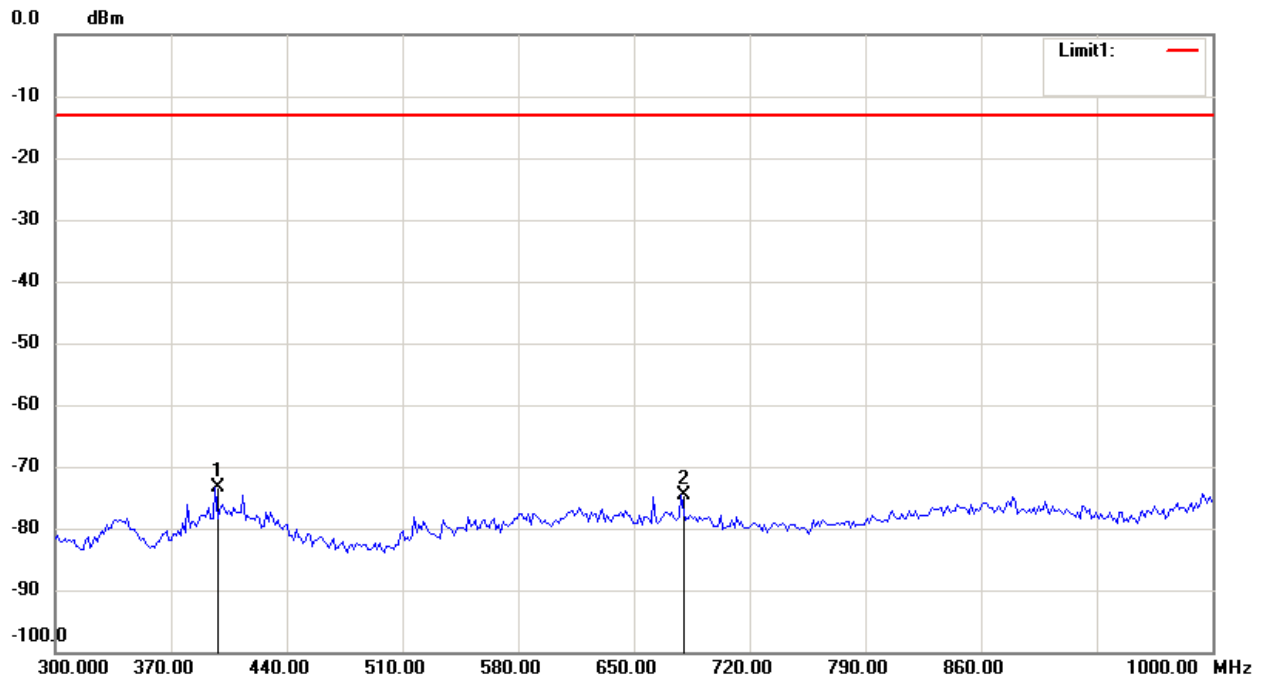
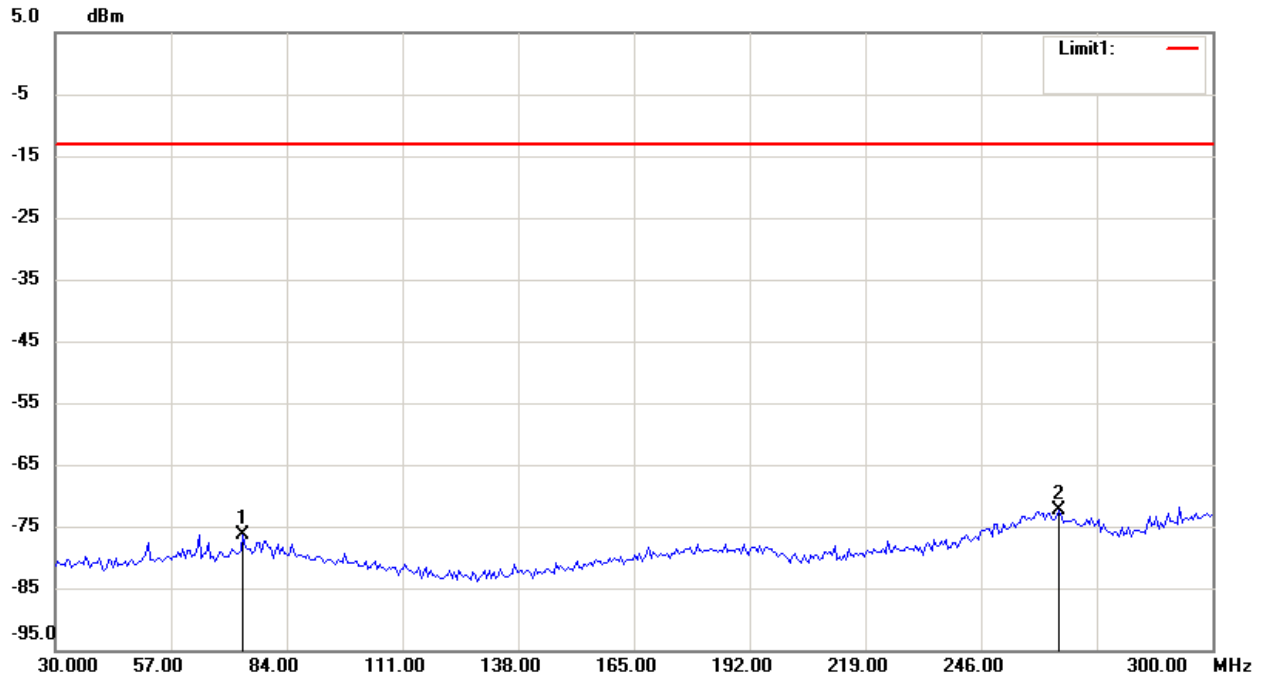

Note:

1. The attached measurement plots are preliminarily pre-scanned with peak detector for determining the final checking frequencies and are for reference only.
2. The some frequencies may exceed the limit line without the specified detectors, but that cannot present the results are failed to the specification of test standard.
3. For corrected test results are listed in the relevant table of radiated test data of this test report.



Registration number: W6M21009-10893-C-1

FCC ID: M5X-ACT202T

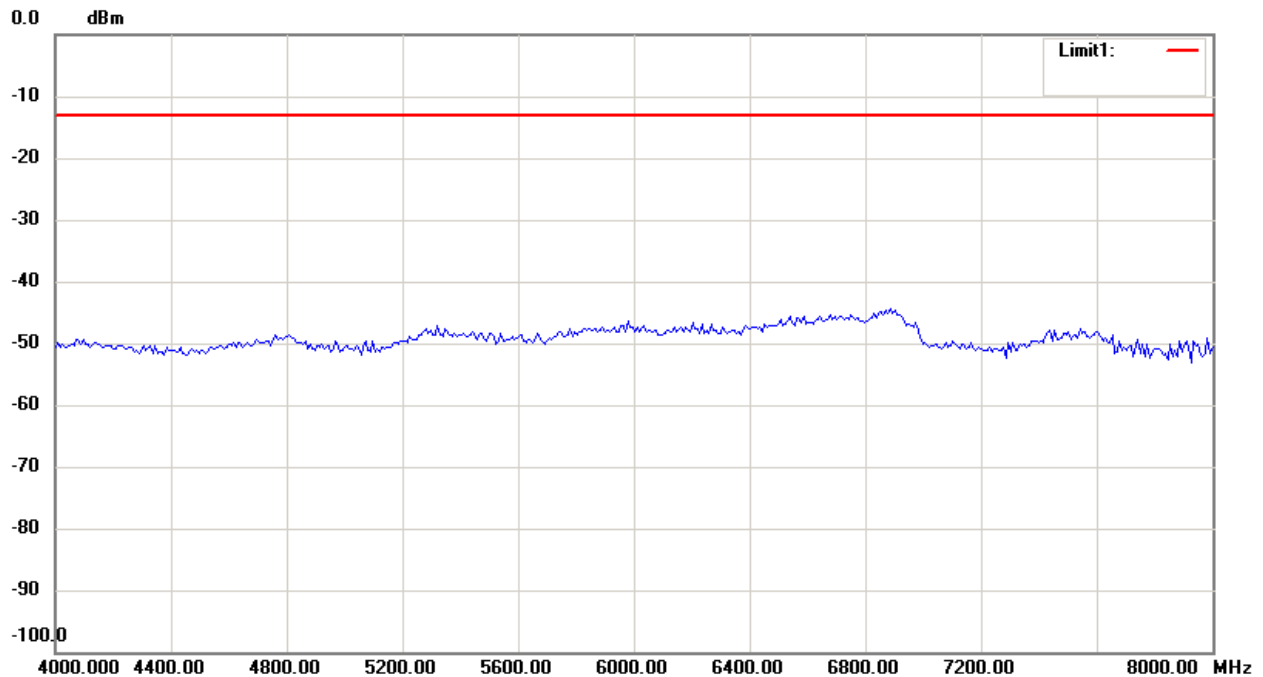
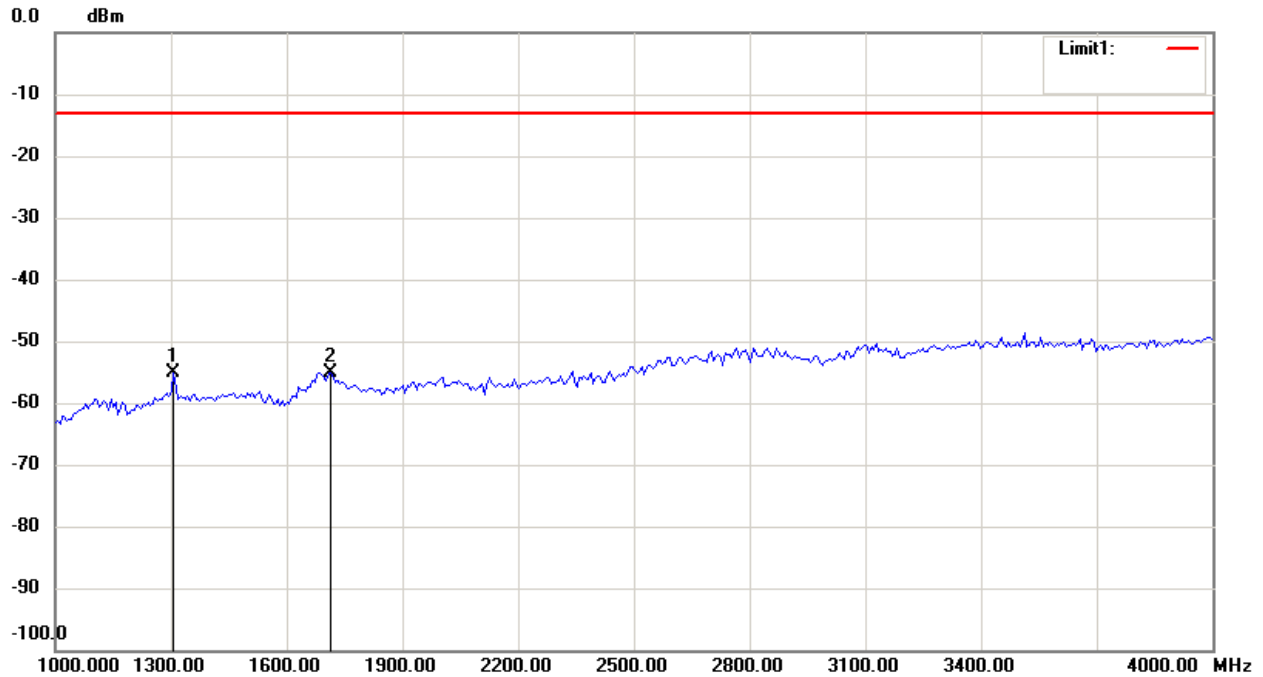

Note:

1. The attached measurement plots are preliminarily pre-scanned with peak detector for determining the final checking frequencies and are for reference only.
2. The some frequencies may exceed the limit line without the specified detectors, but that cannot present the results are failed to the specification of test standard.
3. For corrected test results are listed in the relevant table of radiated test data of this test report.



Registration number: W6M21009-10893-C-1

FCC ID: M5X-ACT202T

Antenna Polarization V

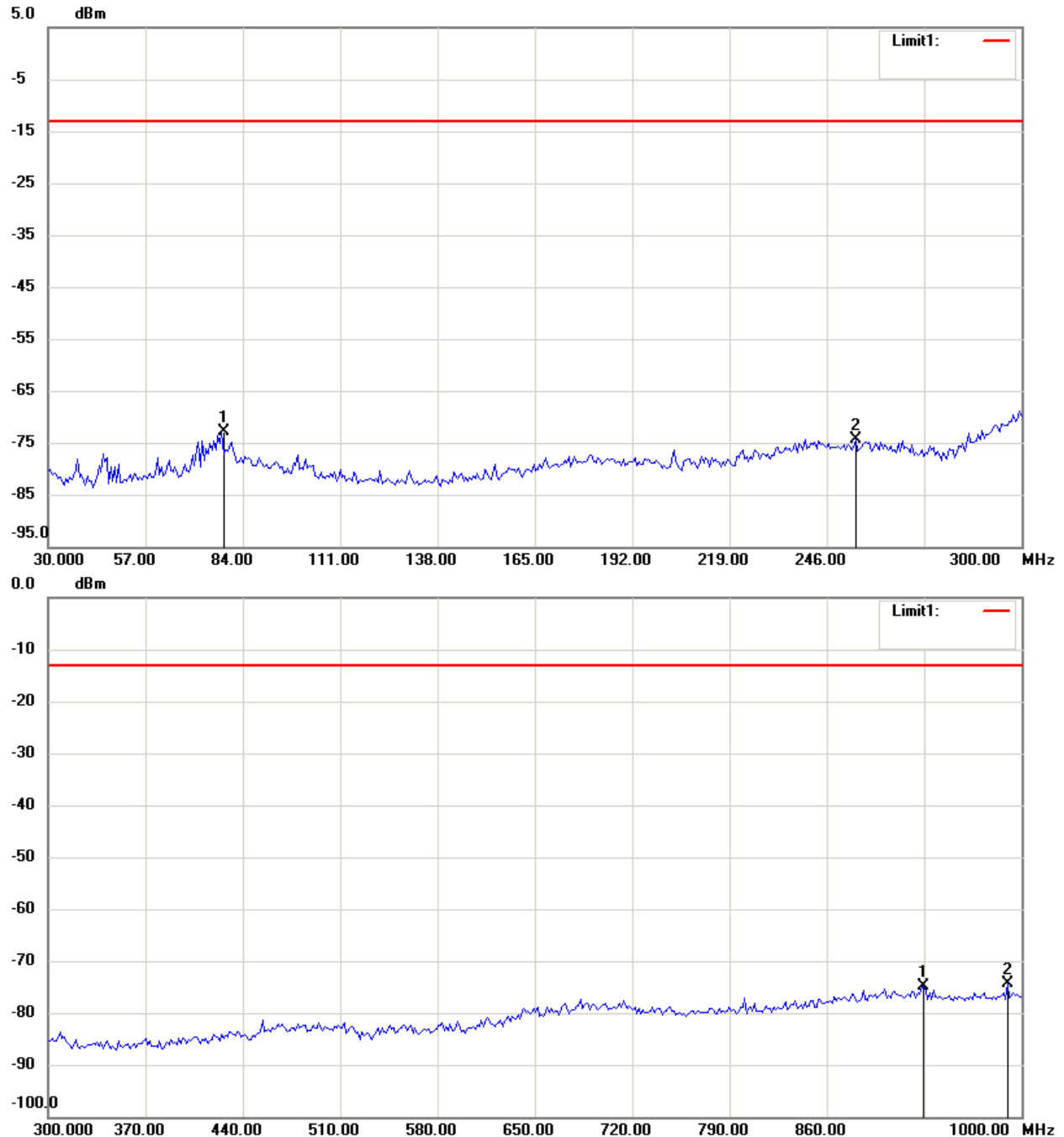

Note:

1. The attached measurement plots are preliminarily pre-scanned with peak detector for determining the final checking frequencies and are for reference only.
2. The some frequencies may exceed the limit line without the specified detectors, but that cannot present the results are failed to the specification of test standard.
3. For corrected test results are listed in the relevant table of radiated test data of this test report.



Registration number: W6M21009-10893-C-1

FCC ID: M5X-ACT202T

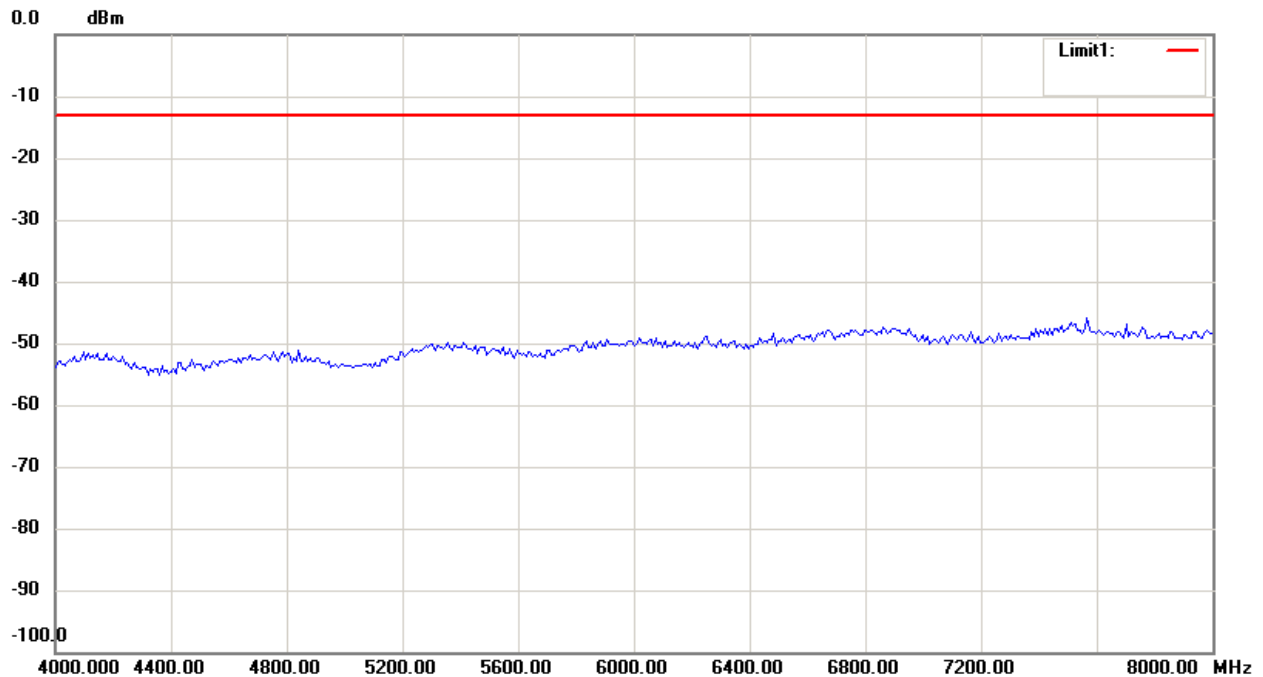
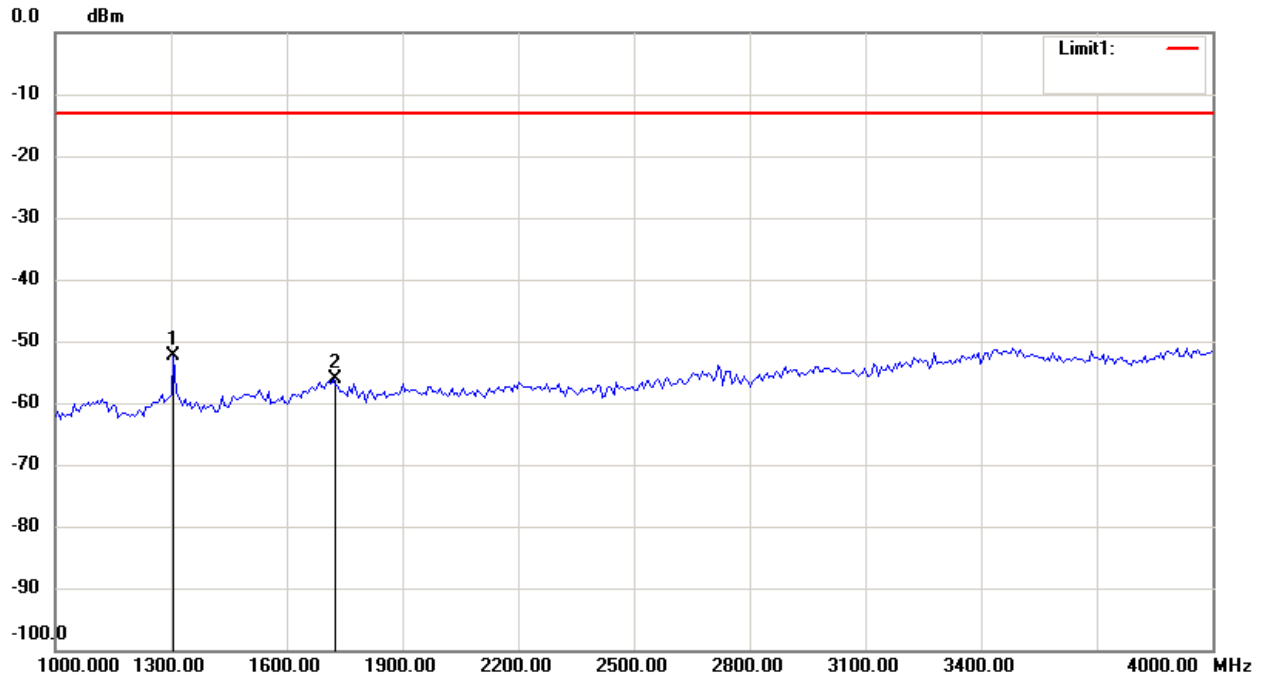

Note:

1. The attached measurement plots are preliminarily pre-scanned with peak detector for determining the final checking frequencies and are for reference only.
2. The some frequencies may exceed the limit line without the specified detectors, but that cannot present the results are failed to the specification of test standard.
3. For corrected test results are listed in the relevant table of radiated test data of this test report.



Registration number: W6M21009-10893-C-1

FCC ID: M5X-ACT202T

697.9 MHz

Antenna Polarization H

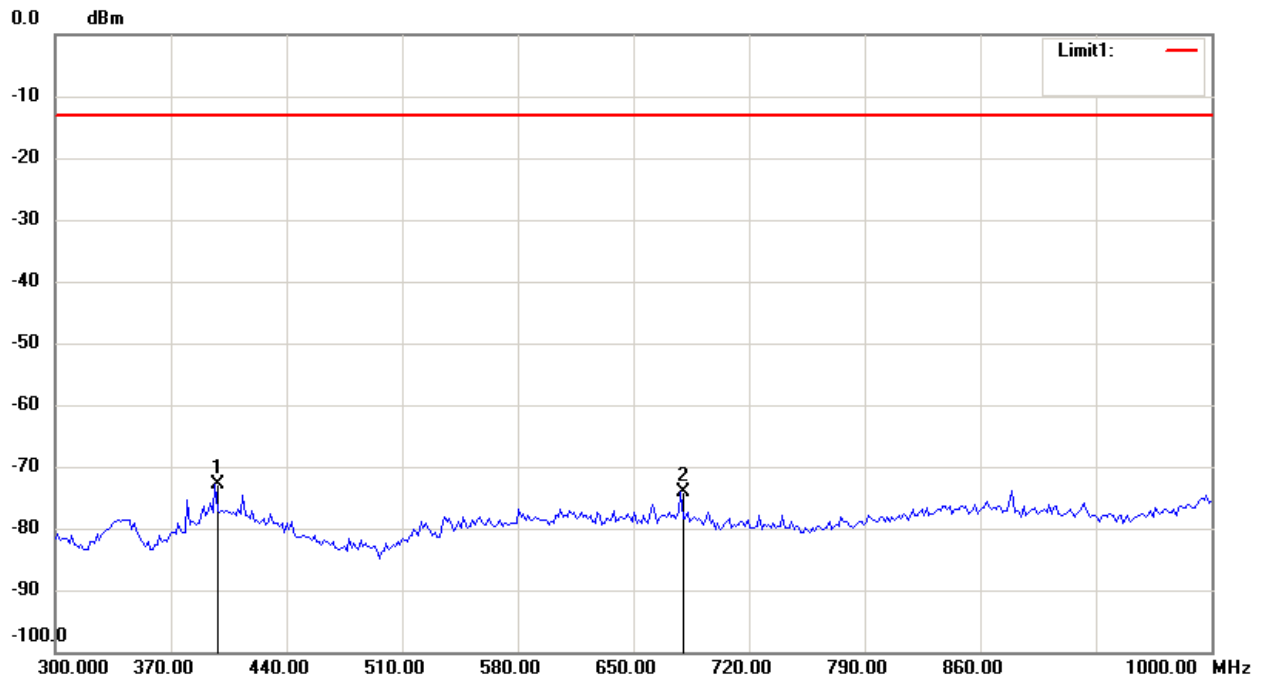
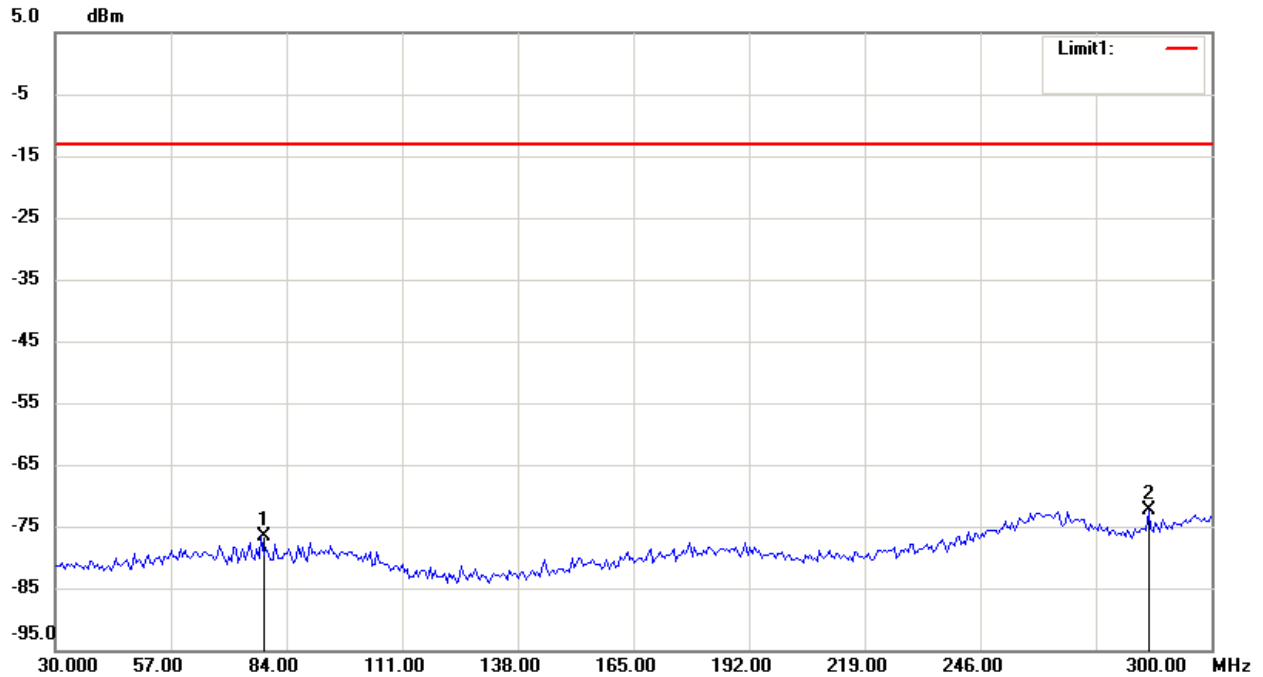

Note:

1. The attached measurement plots are preliminarily pre-scanned with peak detector for determining the final checking frequencies and are for reference only.
2. The some frequencies may exceed the limit line without the specified detectors, but that cannot present the results are failed to the specification of test standard.
3. For corrected test results are listed in the relevant table of radiated test data of this test report.



Registration number: W6M21009-10893-C-1

FCC ID: M5X-ACT202T

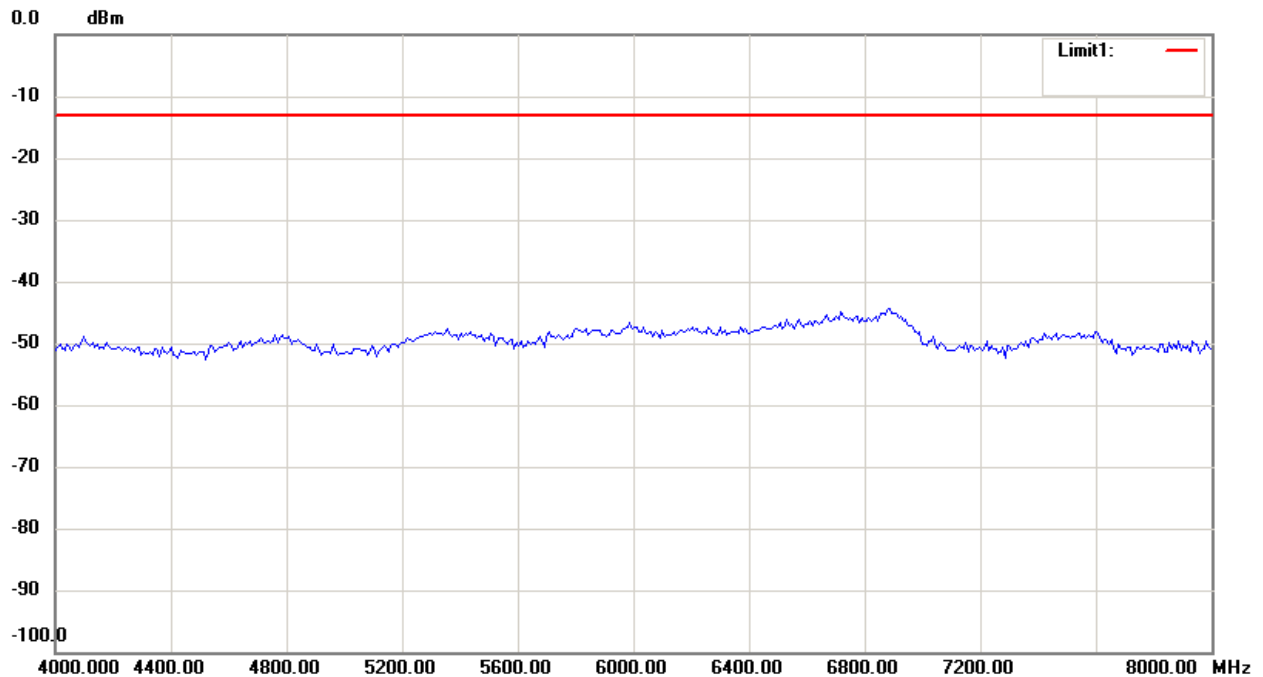
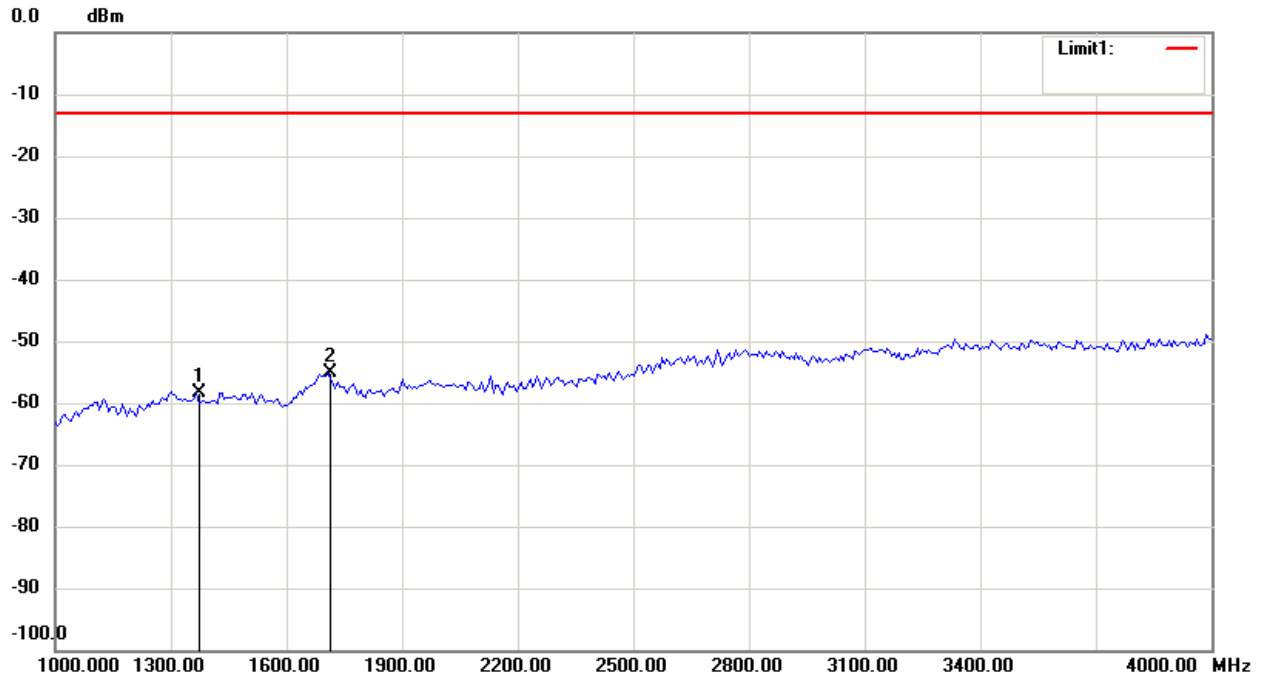

Note:

1. The attached measurement plots are preliminarily pre-scanned with peak detector for determining the final checking frequencies and are for reference only.
2. The some frequencies may exceed the limit line without the specified detectors, but that cannot present the results are failed to the specification of test standard.
3. For corrected test results are listed in the relevant table of radiated test data of this test report.



Registration number: W6M21009-10893-C-1

FCC ID: M5X-ACT202T

Antenna Polarization V

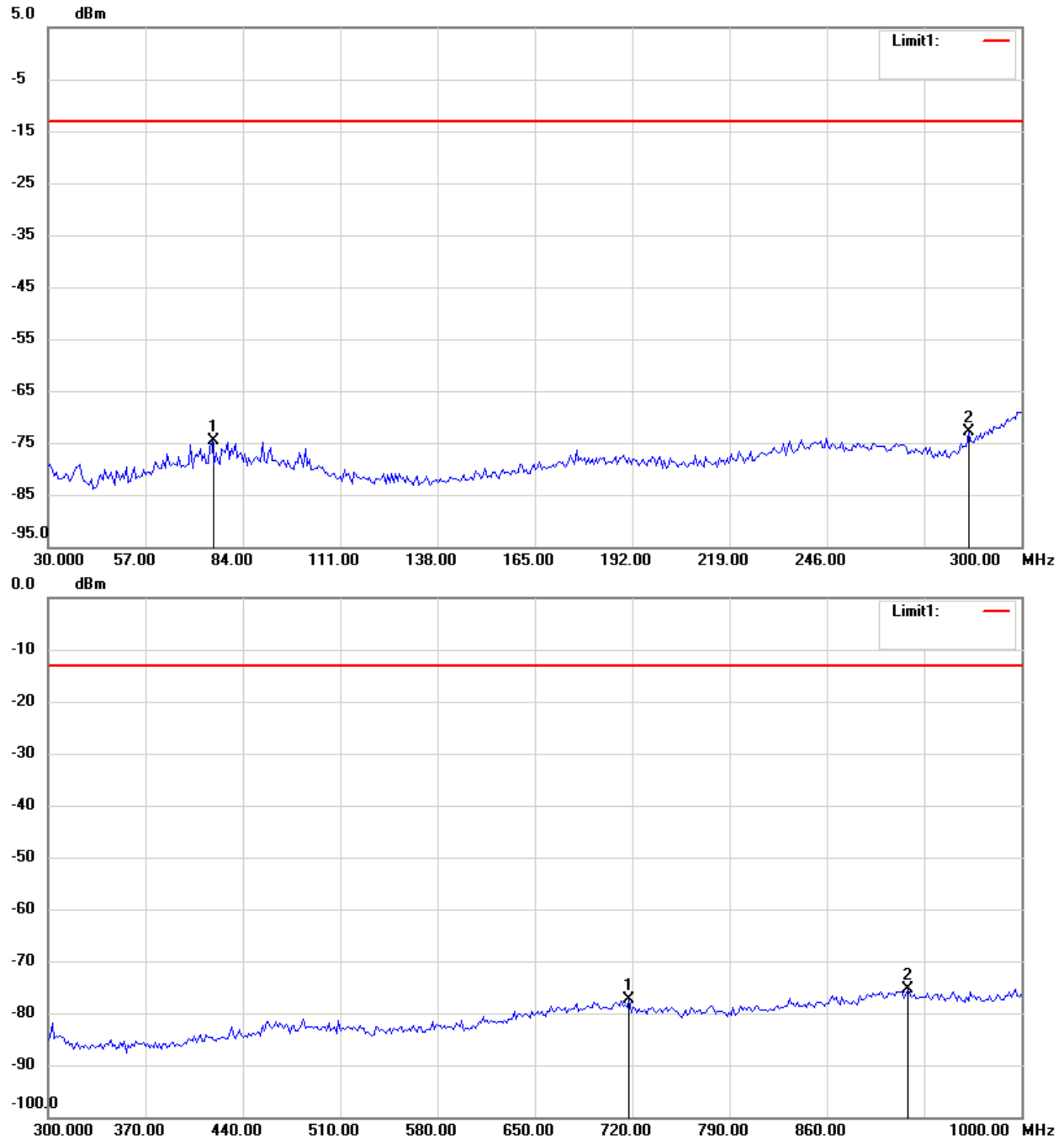

Note:

1. The attached measurement plots are preliminarily pre-scanned with peak detector for determining the final checking frequencies and are for reference only.
2. The some frequencies may exceed the limit line without the specified detectors, but that cannot present the results are failed to the specification of test standard.
3. For corrected test results are listed in the relevant table of radiated test data of this test report.



Registration number: W6M21009-10893-C-1

FCC ID: M5X-ACT202T

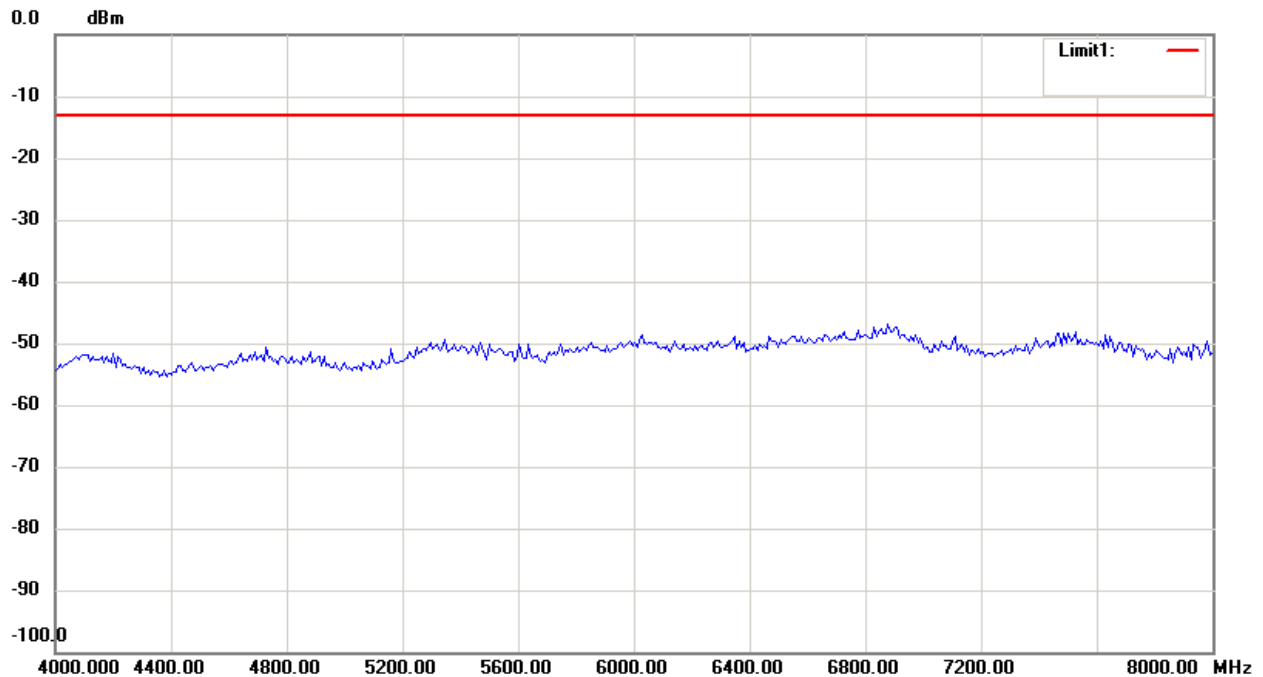
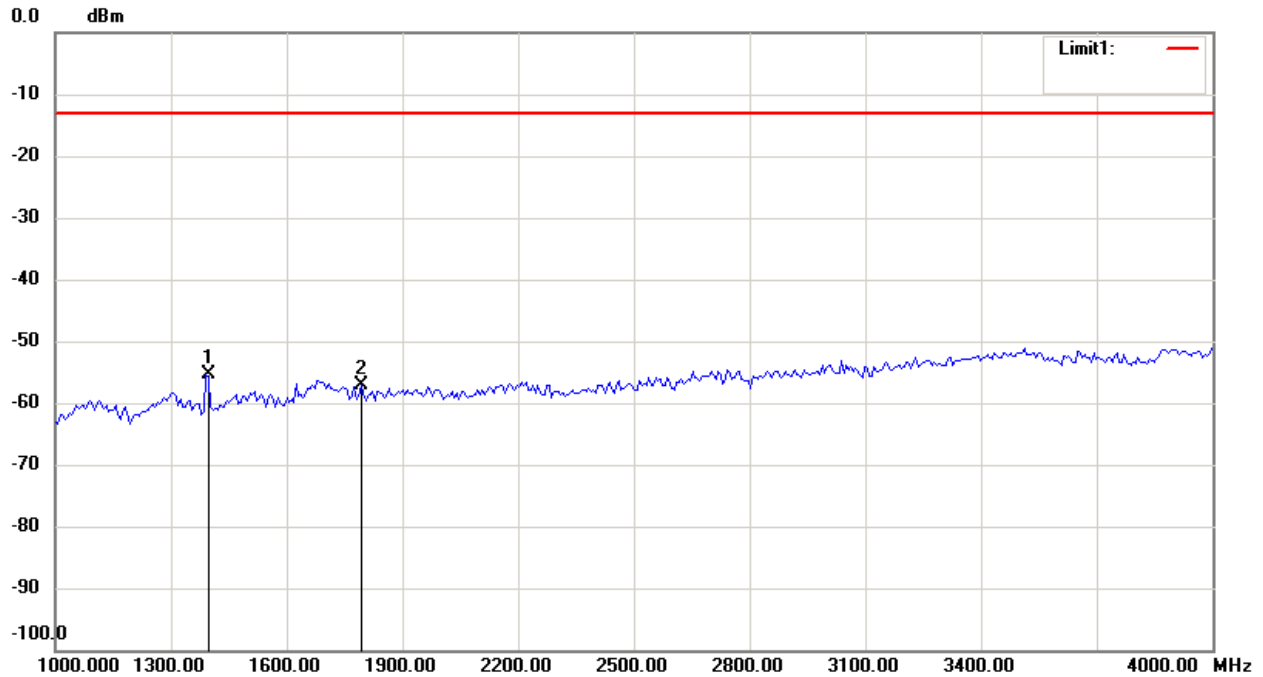

Note:

1. The attached measurement plots are preliminarily pre-scanned with peak detector for determining the final checking frequencies and are for reference only.
2. The some frequencies may exceed the limit line without the specified detectors, but that cannot present the results are failed to the specification of test standard.
3. For corrected test results are listed in the relevant table of radiated test data of this test report.



Registration number: W6M21009-10893-C-1

FCC ID: M5X-ACT202T

External Photos





Registration number: W6M21009-10893-C-1

FCC ID: M5X-ACT202T





Registration number: W6M21009-10893-C-1

FCC ID: M5X-ACT202T





Registration number: W6M21009-10893-C-1

FCC ID: M5X-ACT202T





Worldwide Testing Services(Taiwan) Co., Ltd.

Registration number: W6M21009-10893-C-1

FCC ID: M5X-ACT202T





Registration number: W6M21009-10893-C-1

FCC ID: M5X-ACT202T





Worldwide Testing Services(Taiwan) Co., Ltd.

Registration number: W6M21009-10893-C-1

FCC ID: M5X-ACT202T





Registration number: W6M21009-10893-C-1

FCC ID: M5X-ACT202T

Internal Photos

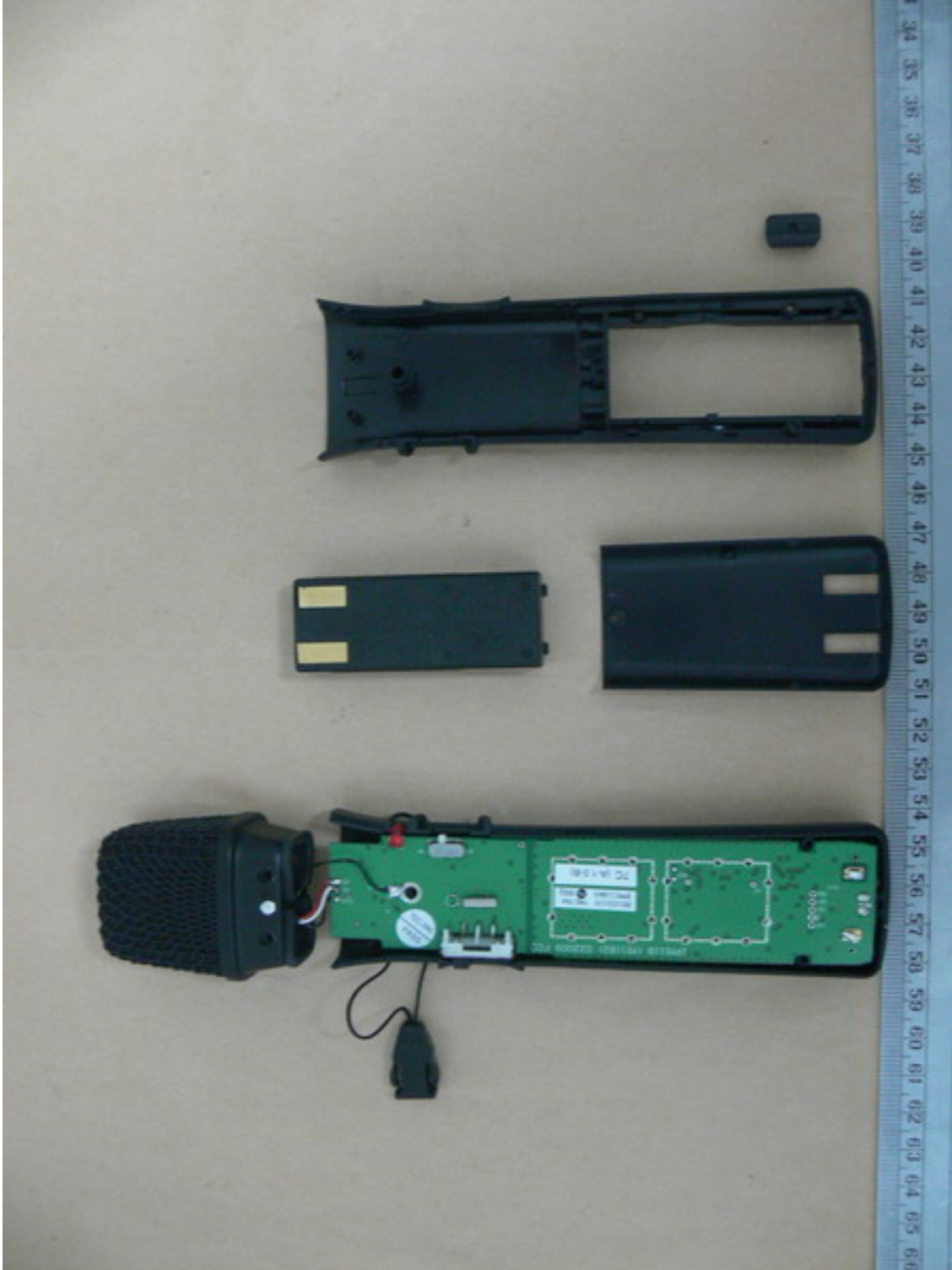



Registration number: W6M21009-10893-C-1

FCC ID: M5X-ACT202T

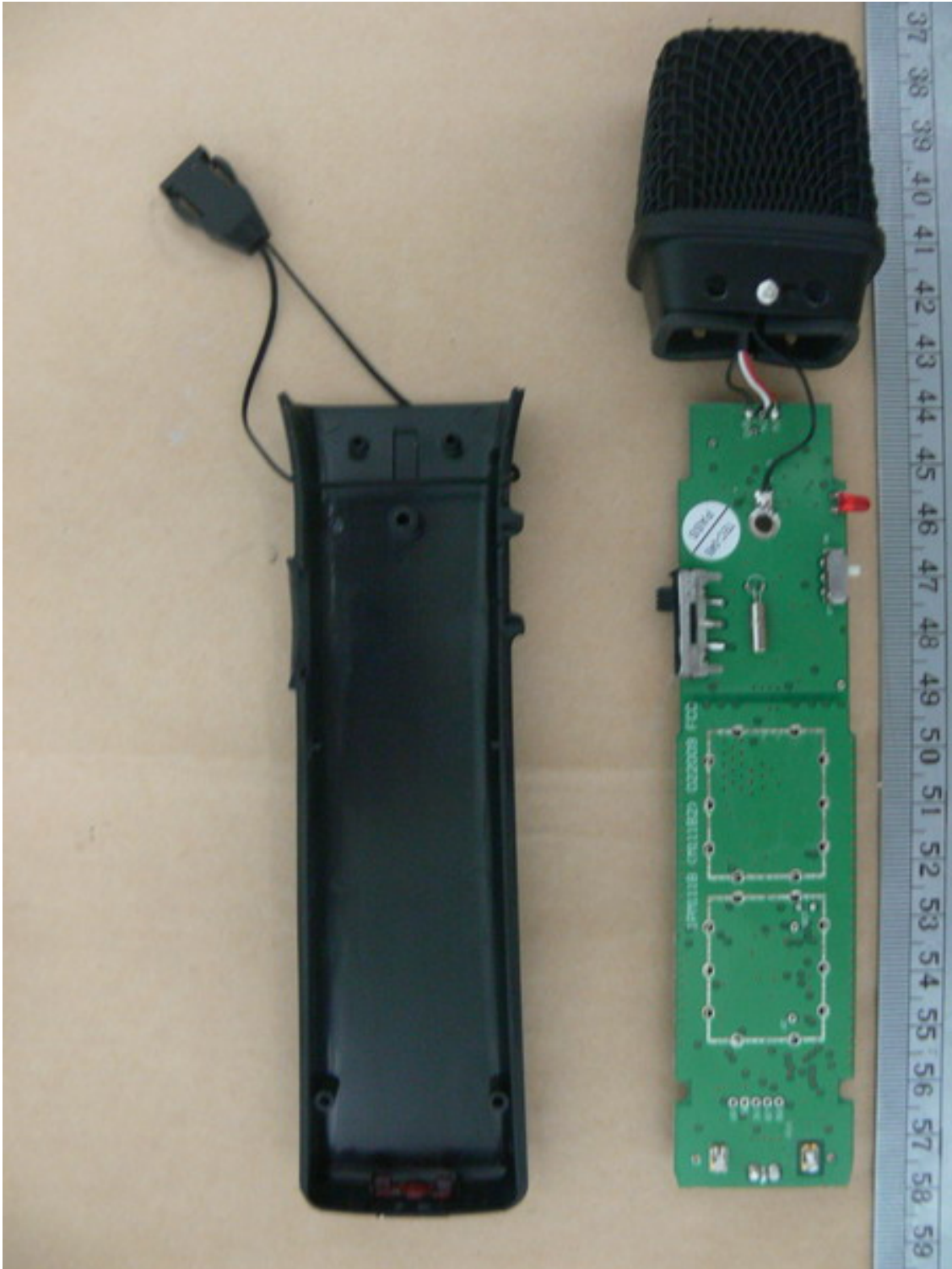



Registration number: W6M21009-10893-C-1

FCC ID: M5X-ACT202T

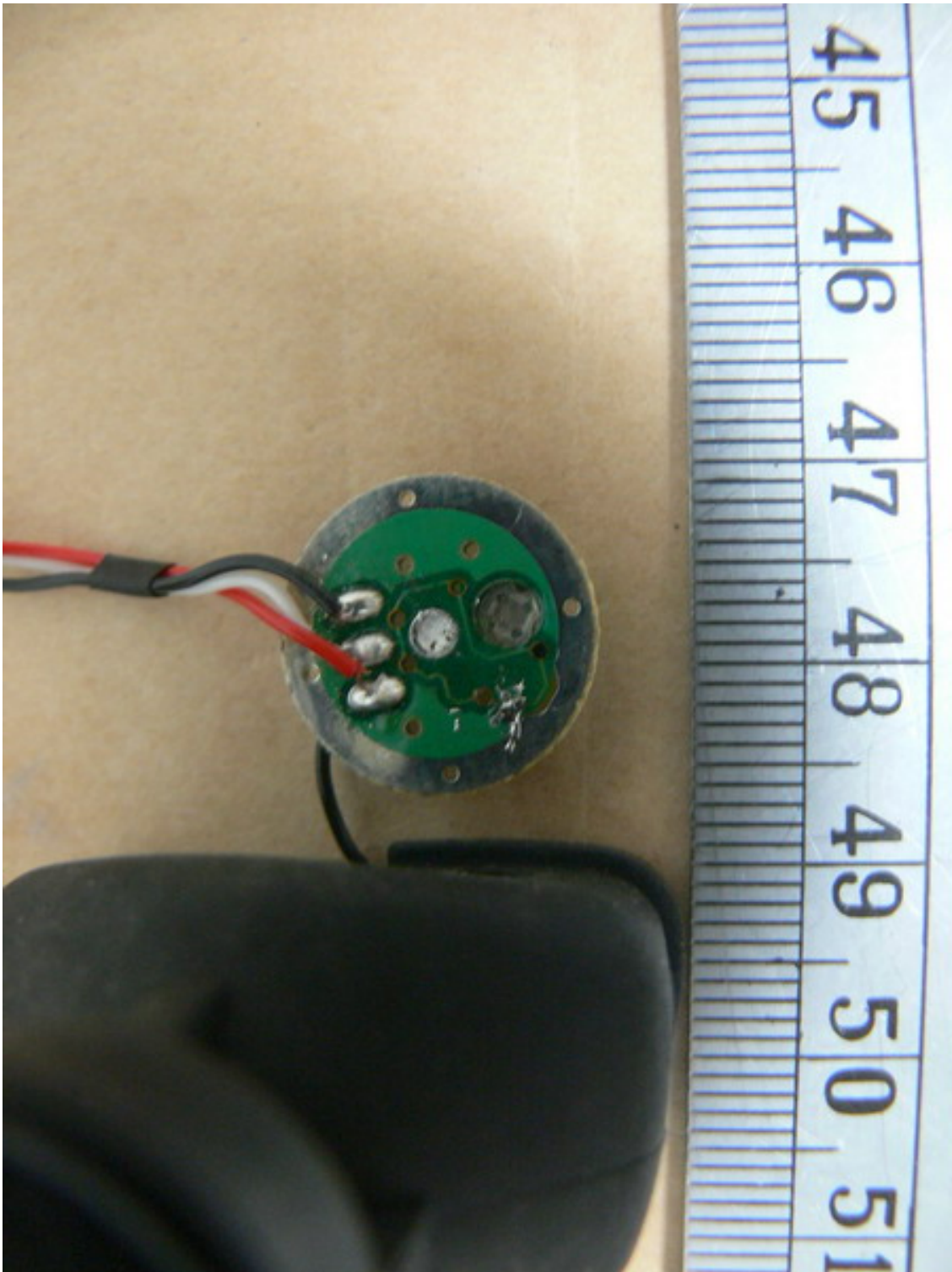



Registration number: W6M21009-10893-C-1

FCC ID: M5X-ACT202T





Worldwide Testing Services(Taiwan) Co., Ltd.

Registration number: W6M21009-10893-C-1

FCC ID: M5X-ACT202T





Registration number: W6M21009-10893-C-1

FCC ID: M5X-ACT202T

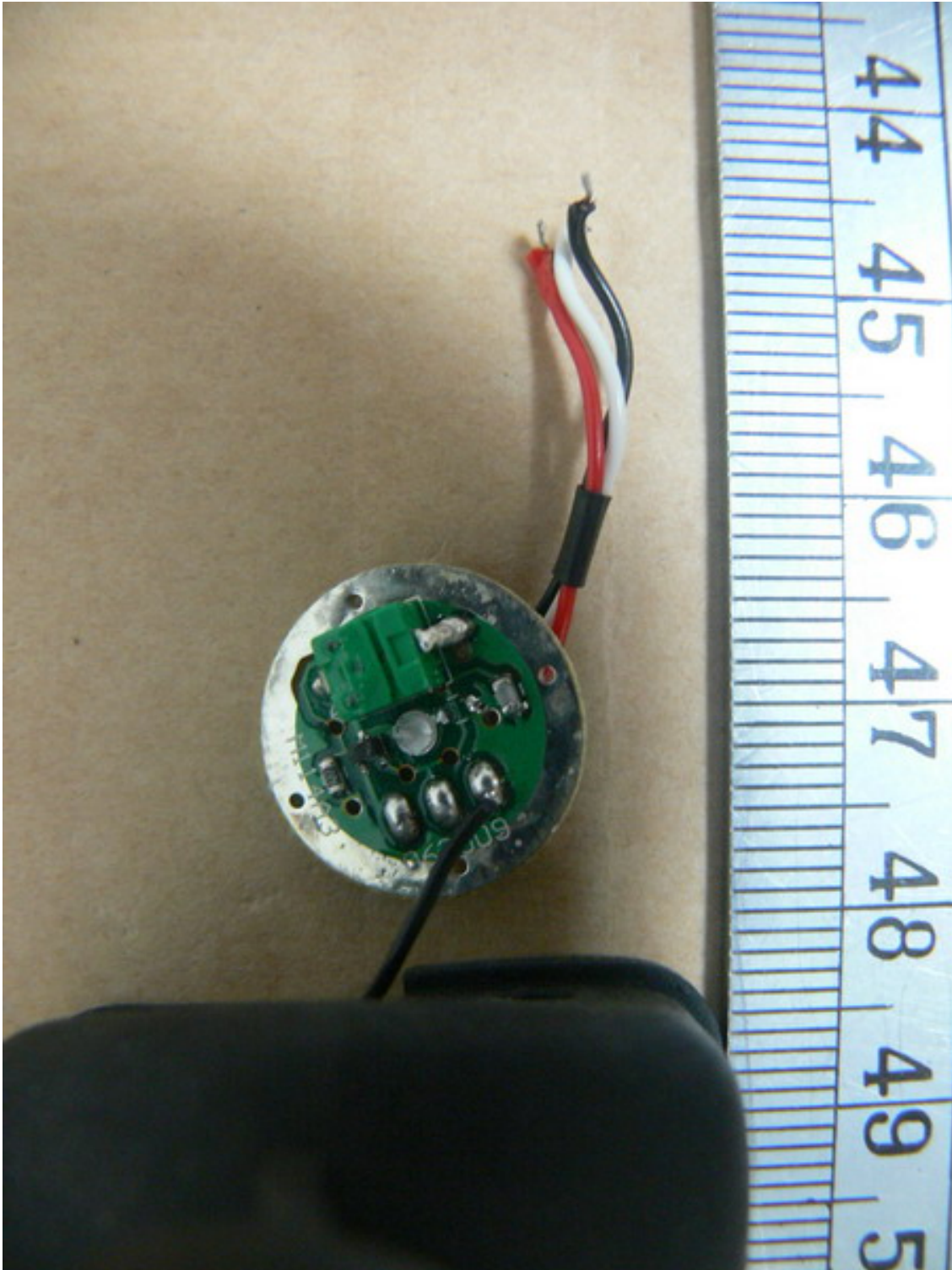



Registration number: W6M21009-10893-C-1

FCC ID: M5X-ACT202T

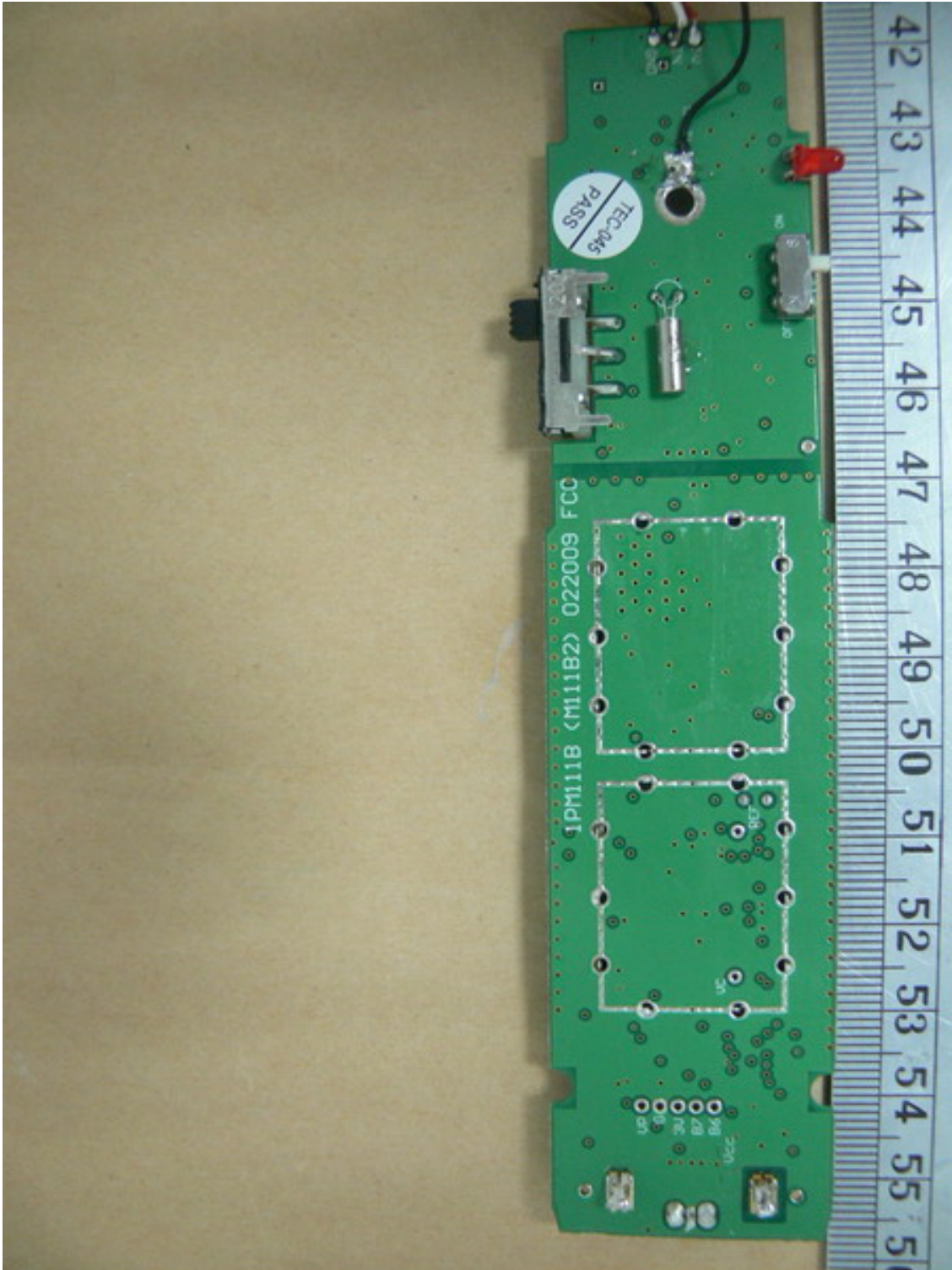



Worldwide Testing Services(Taiwan) Co., Ltd.

Registration number: W6M21009-10893-C-1

FCC ID: M5X-ACT202T

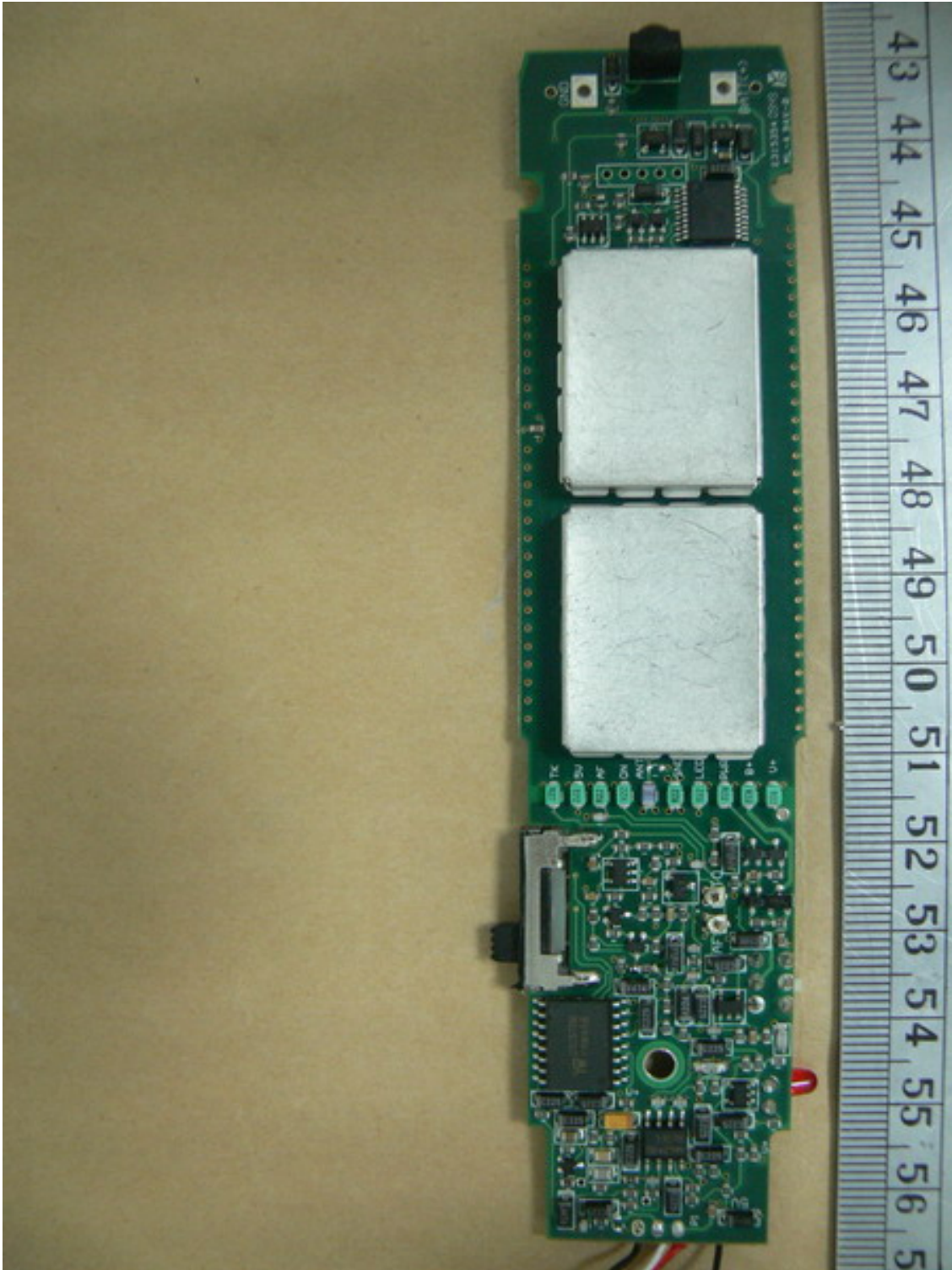



Registration number: W6M21009-10893-C-1

FCC ID: M5X-ACT202T

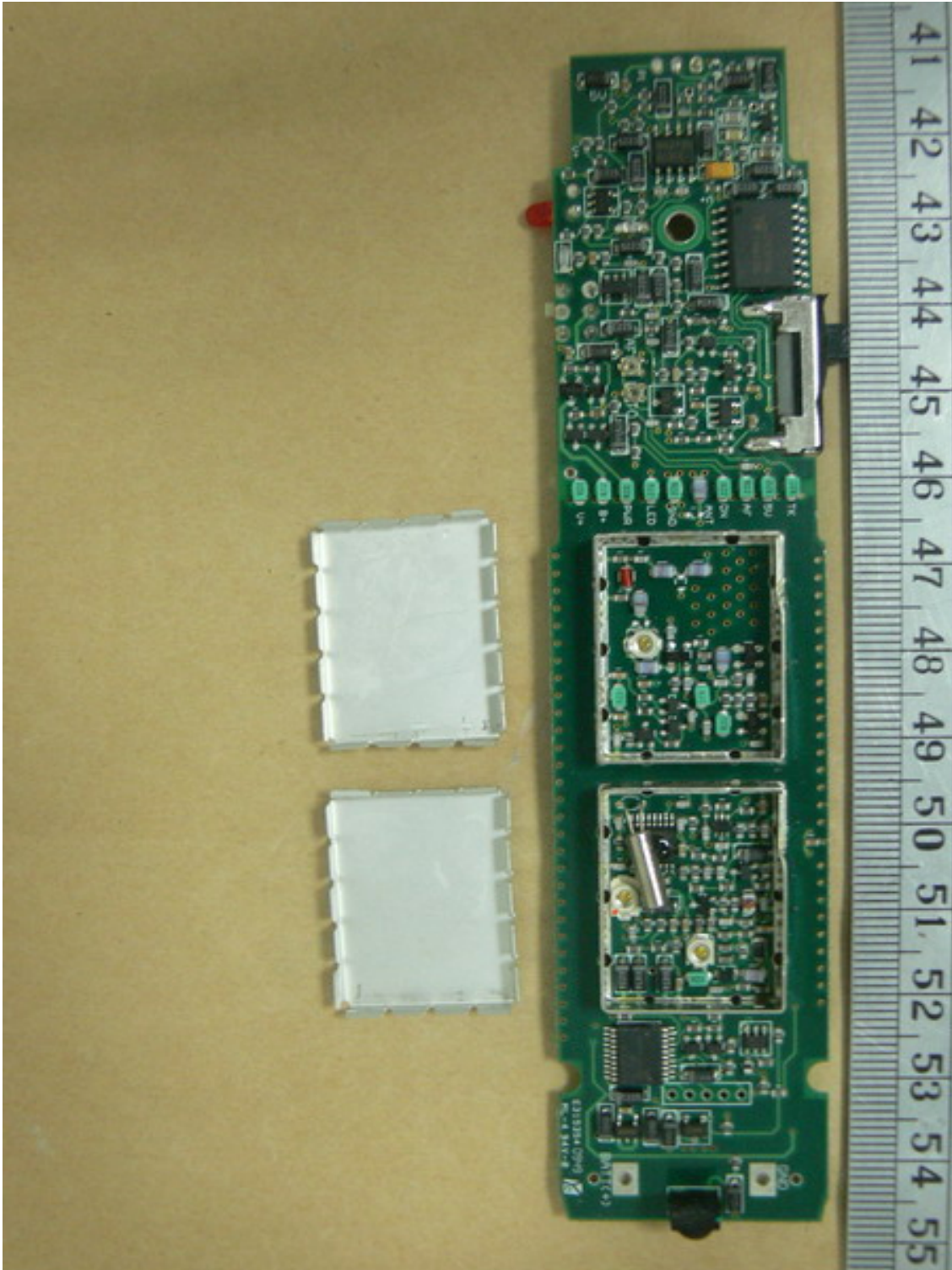



Registration number: W6M21009-10893-C-1

FCC ID: M5X-ACT202T

Set Up Photo of Radiated Emission

