



Gallagher

T11 Reader

Installation Note

T11 MIFARE® Reader, Black: C300410

T11 MIFARE® Reader, White: C300411

T11 Multi Tech Reader, Black: C300430

T11 Multi Tech Reader, White: C300431

High Sec T11 Reader, Black: C305410

High Sec T11 Reader, White: C305411

High Sec T11 Reader, Multi Tech, Black: C305430

High Sec T11 Reader, Multi Tech, White: C305431



Disclaimer

This document gives certain information about products and/or services provided by Gallagher Group Limited or its related companies (referred to as "Gallagher Group").

The information is indicative only and is subject to change without notice meaning it may be out of date at any given time. Although every commercially reasonable effort has been taken to ensure the quality and accuracy of the information, Gallagher Group makes no representation as to its accuracy or completeness and it should not be relied on as such. To the extent permitted by law, all express or implied, or other representations or warranties in relation to the information are expressly excluded.

Neither Gallagher Group nor any of its directors, employees or other representatives shall be responsible for any loss that you may incur, either directly or indirectly, arising from any use or decisions based on the information provided.

Except where stated otherwise, the information is subject to copyright owned by Gallagher Group and you may not sell it without permission. Gallagher Group is the owner of all trademarks reproduced in this information. All trademarks which are not the property of Gallagher Group, are acknowledged.

Copyright © Gallagher Group Ltd 2023. All rights reserved.

Contents

1	Introduction	3
2	Before you begin	4
3	Distance between readers	6
4	Installation	7
5	LED indications.....	9
6	Accessories	9
7	Technical specifications.....	10
8	Approvals and Compliance Standards.....	10
9	Mounting dimensions	12

1 Introduction

The Gallagher T11 Reader is a smart card and Bluetooth® low energy technology reader. It can be installed as either an entry reader or exit reader. It can be mounted on a vertical, rectangular 50 mm x 75 mm (2" x 3") flush box with mounting holes spaced at a nominal 85 mm (3.25").

The reader sends information to the Gallagher Controller and acts upon information sent from the Gallagher Controller. The reader itself does not make any access decisions.

The reader is available in eight variants. The supported technologies and compatibility for each variant is shown in the table below.

Reader Variant	Product Codes	Card Technologies Supported	NFC Access for Android Supported From	Bluetooth® Access Supported From	HBUS Comms Supported From	Cardax IV Comms Supported From
T11 MIFARE Reader	C300410 C300411	ISO 14443A MIFARE® DESFire® EV1/EV2*/EV3**, MIFARE Plus®, and MIFARE Classic® cards	vEL7.80 HBUS only	None	vEL7.00	vEL1.02
T11 Multi Tech Reader	C300430 C300431	ISO 14443A MIFARE DESFire EV1/EV2*/EV3**, MIFARE Plus, MIFARE Classic, and 125 KHz cards	vEL7.80 HBUS only	vEL7.60 HBUS only	vEL7.00	vEL1.02***
High Sec T11 Reader	C305410 C305411	ISO 14443A PIV, PIV-I, CAC, TWIC, MIFARE DESFire EV1/EV2*/EV3**, MIFARE Plus, and MIFARE Classic cards	vEL7.80 HBUS only	None	vEL7.10	None
High Sec T11 Reader, Multi Tech	C305430 C305431	ISO 14443A PIV, PIV-I, CAC, TWIC, MIFARE DESFire EV1/EV2*/EV3**, MIFARE Plus, MIFARE Classic, and 125 KHz cards	vEL7.80 HBUS only	None	vEL7.10	None

* MIFARE DESFire EV2 is supported from vEL7.70.

** MIFARE DESFire EV3 is supported from vEL8.30.1458 (or later).

*** Gallagher strongly recommends against using dual technology 125/MIFARE cards with Multi Tech Readers for sites running pre-Command Centre v7.00 software. From Command Centre v7.00, a site may specify which technology a Multi Tech Reader should read off a dual technology card.

2 Before you begin

2.1 Shipment contents

Check the shipment contains the following items:

- 1 x Gallagher T11 Reader fascia assembly
- 1 x Gallagher T11 Reader bezel
- 1 x M3 Torx Post Security screw
- 2 x 6-32 UNC Phillips drive fixing screws
- 4 x 25 mm No.6 self tapping, pan head, Phillips drive fixing screws
- 4 x 40 mm No.6 self tapping, pan head, Phillips drive fixing screws

2.2 Power supply

The Gallagher T11 Reader is designed to operate over a supply voltage range of 9 - 16 Vdc measured at the reader terminals. The operating current draw is dependant on the supply voltage at the reader. For a MIFARE reader, at 13.6 Vdc the current draw is 50 mA (idle). During credential read, beeper and LED activity, the current will momentarily reach 77 mA (maximum). For a Multi Tech reader, at 13.6 Vdc the current draw is 80 mA (idle) and will momentarily reach 142 mA (maximum). The power source should be linear or a good quality switched-mode power supply. The performance of the reader may be affected by a low quality, noisy power supply.

2.3 Cabling

The Gallagher T11 Reader requires a minimum cable size of 4 core 24 AWG (0.2 mm²) stranded security cable. This cable allows the transmission of data (2 wires) and power (2 wires). When using a single cable to carry both power supply and data, both the power supply voltage drop and data requirements must be considered. Although the reader is specified to operate at 9 Vdc, for good engineering design it is recommended that the voltage at the reader should be approximately 12 Vdc.

HBUS cabling topology

The HBUS communications protocol is based on the RS485 standard and allows the reader to communicate over a distance of up to 500 m (1640 ft).

The cabling between HBUS devices should be done in a "daisy chain" topology, (i.e. A "T" or "Star" topology should not be used between devices). Should "Star" or "Home-Run" wiring be required, the HBUS 4H/8H Modules and the HBUS Door Module allow multiple HBUS devices to be individually wired to the one physical location.

The end devices on the HBUS cable should be terminated using 120 ohms resistance. To terminate the Gallagher Controller 6000, connect the supplied on-board termination jumpers to the Controller. To terminate a reader, connect the orange (termination) wire to the green (HBUS A) wire. Termination is already included at the HBUS Module, (i.e. each HBUS port is permanently terminated at the module).

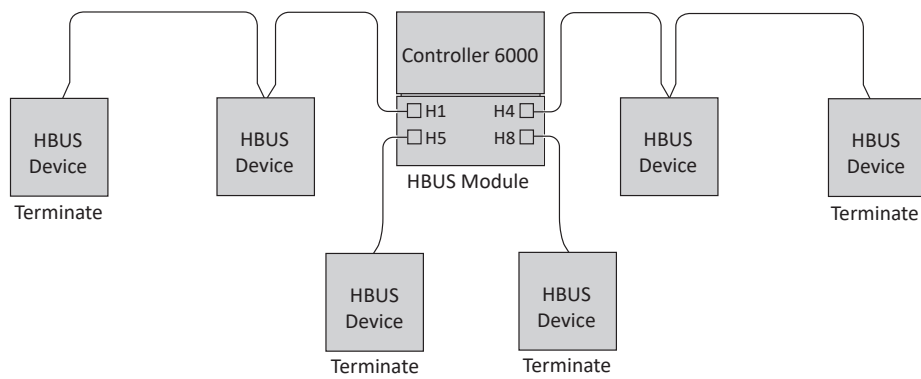
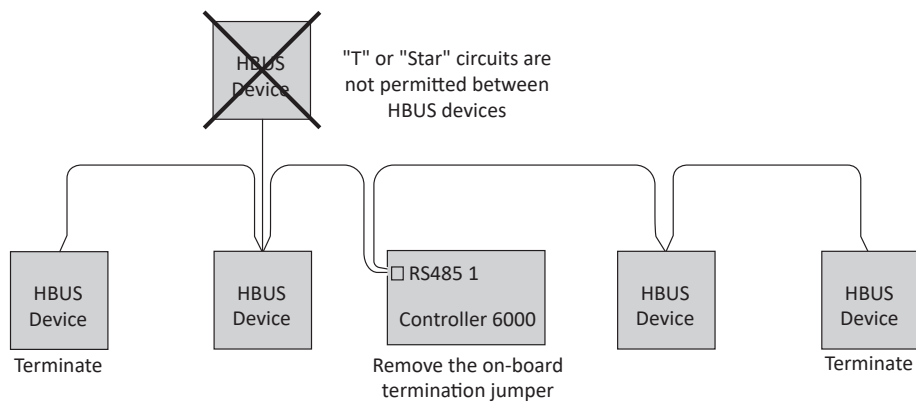
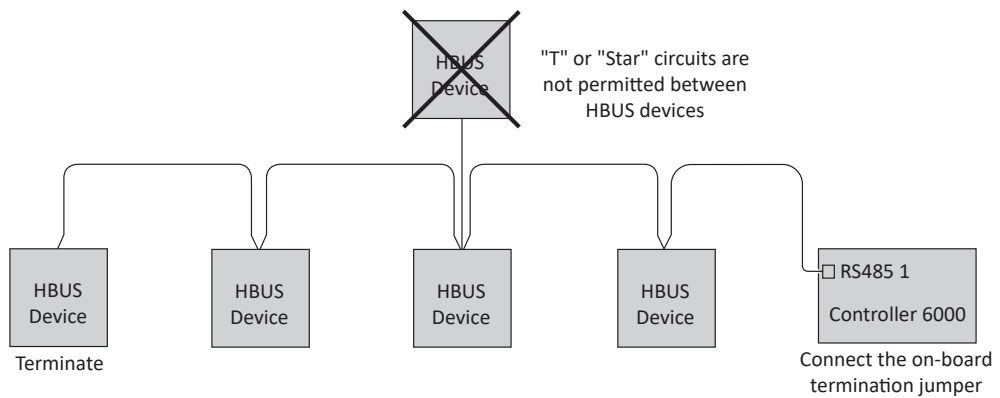

Cable distance

Cable type	Cable format*	HBUS single reader connected using data only in a single cable	Cardax IV single reader connected using data only in a single cable***	HBUS/Cardax IV single reader connected using power and data in a single cable****
CAT 5e or better**	4 twisted pair each 2 x 0.2 mm ² (24 AWG)	500 m (1640 ft)	200 m (650 ft)	100 m (330 ft)
BELDEN 9842** (shielded)	2 twisted pair each 2 x 0.2 mm ² (24 AWG)	500 m (1640 ft)	200 m (650 ft)	100 m (330 ft)
SEC472	4 x 0.2 mm ² Not twisted pairs (24 AWG)	400 m (1310 ft)	200 m (650 ft)	100 m (330 ft)
SEC4142	4 x 0.4 mm ² Not twisted pairs (21 AWG)	400 m (1310 ft)	200 m (650 ft)	150 m (500 ft)
C303900/ C303901 Gallagher HBUS Cable	2 Twisted pair each 2 x 0.4 mm ² (21 AWG, Data) and 2 x 0.75 mm ² Not Twisted Pair (~18 AWG, Power)	500 m (1640 ft)	200 m (650 ft)	450 m (1490 ft)

* The matching of wire sizes to equivalent wire gauges are only approximate.

** Recommended cable types for optimal HBUS RS485 performance.

*** Not applicable for PIV or Bluetooth® enabled reader installations.

**** Tested with 13.6V at start of cable.

Notes:

- Shielded cable may reduce the obtainable cable length. Shielded cable should be grounded at the Controller end only.
- If other cable types are used, operating distances and performance may be reduced depending on the cable quality.
- HBUS allows up to 20 readers to be connected to a single cable. Each reader requires at least 9 Vdc to function correctly. The cable length and the number of readers connected will have an impact on the voltage at each reader.

3 Distance between readers

The distance separating any two proximity readers must not be less than 200 mm (8 in) in all directions. When mounting a proximity reader on an internal wall, check that any reader fixed to the other side of the wall is not less than 200 mm (8 in) away.

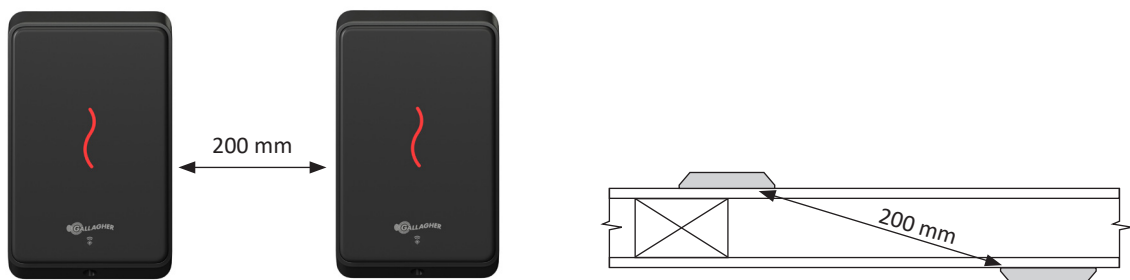

4 Installation



ATTENTION: This equipment contains components that can be damaged by electrostatic discharge. Ensure both you and the equipment are earthed before beginning any servicing.

The Gallagher T11 Reader is designed to be mounted on vertically orientated electrical flush (gang) boxes, or any solid flat surface. However installation on metal surfaces, particularly those with a large surface area will reduce read range. The extent to which the range is reduced will depend upon the type of metal surface.

Note: Consideration should be given to the installation environment when using Bluetooth® enabled readers, as the read range may be reduced.

The recommended mounting height for the reader is 1.1 m (3.6 ft) from the floor level to the centre of the reader device. However this may vary in some countries and you should check local regulations for variations to this height.

1. Ensure the building cable has been run out through the flush box.

If you are not mounting to a flush box, use the reader bezel as a guide to drill all five holes. Drill the 13 mm (1/2 inch) diameter centre hole (this is the centre hole for which the building cable will exit the mounting surface) and the four fixing holes.

2. Run the building cabling out through the centre hole and through the reader bezel.
3. Secure the bezel to the flush box using the two 6-32 UNC screws provided. It is important the reader bezel is flush with and tight against the mounting surface.

If you are not mounting to a flush box, secure the bezel to the mounting surface using the four fixing screws provided.

Note: It is strongly recommended that you use the screws provided. If an alternative screw is used, the head must be no larger nor deeper than that of the screw provided.

Note: Ensure the centre hole allows the cable to run freely out through the mounting surface, so that the reader facia can clip into the bezel.

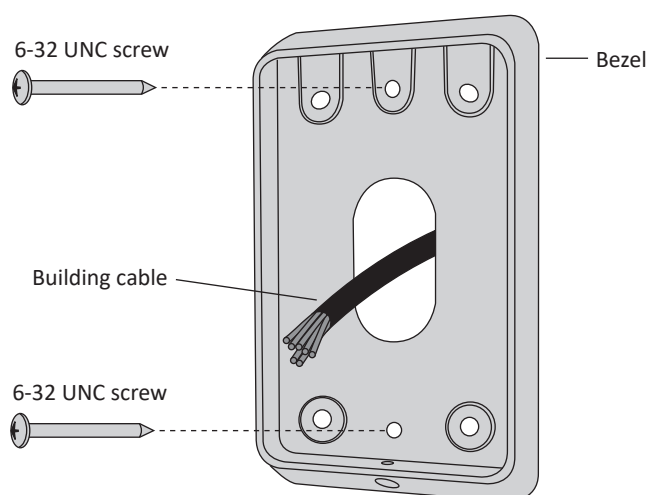

4. Connect the reader tail extending from the facia assembly to the building cable. Connect the wires for the appropriate reader you wish to interface, either an HBUS Reader or a Cardax IV Reader, as shown in the following diagrams.

Note: PIV and Bluetooth® enabled readers must be connected as HBUS Readers. PIV readers connect to the Gallagher High Sec Controller 6000 (C305101) only.

An HBUS Reader connects to a Gallagher Controller 6000, Gallagher 4H/8H Module (attached to a Controller 6000) or a Gallagher HBUS Door Module (connected to a Controller 6000).

A Cardax IV Reader connects to a Gallagher Controller 6000, Gallagher 4R/8R Module (attached to a Controller 6000) or a Gallagher GBUS Universal Reader Interface (Gallagher GBUS URI).

HBUS Reader connection:

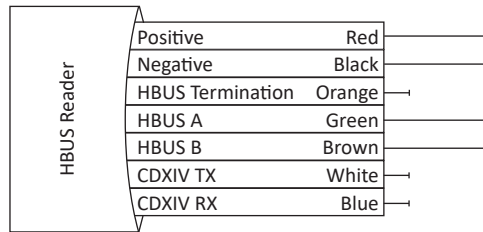

HBUS Reader terminated:

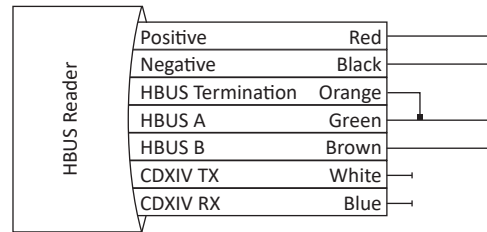

Note: To terminate an HBUS Reader, connect the **Orange** (HBUS Termination) wire to the **Green** (HBUS A) wire.

Cardax IV Reader connection:

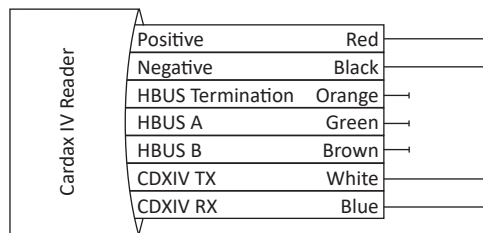

- Fit the fascia assembly into the bezel by clipping the small lip, into the top of the bezel and holding the top, press the bottom of the fascia assembly down into the bezel.
- Insert the M3 Torx Post Security screw (using a T10 Torx Post Security screwdriver) through the hole at the bottom of the bezel to secure the fascia assembly.

Note: The Torx Post Security screw needs only to be lightly tightened.

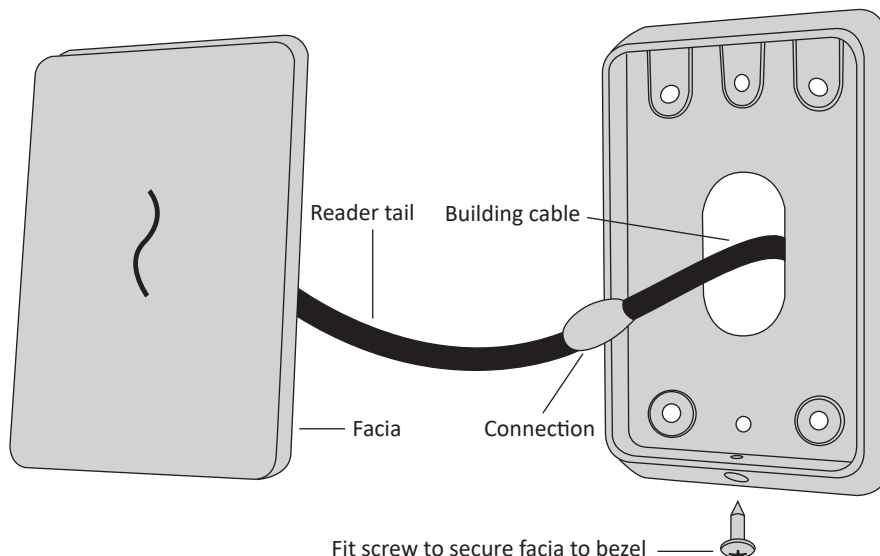

7. Removal of the fascia assembly is a simple reversal of these steps.
8. Configure the reader in Command Centre. If the reader is connected as an HBUS Reader, refer to the topic "*Configuring HBUS Devices*" in the Command Centre Configuration Client Online Help. If the reader is connected as a Cardax IV Reader, refer to the topic "*Creating Readers*" in the Command Centre Configuration Client Online Help.

5 LED indications

LED (squiggle)	HBUS indication
3 Flash (Amber)	No communications with the Controller.
2 Flash (Amber)	Communications with the Controller, but reader is not configured.
1 Flash (Amber)	Configured to a Controller, but reader is not assigned to a door or elevator car.
On (Green or Red)	Fully configured and functioning normally. Green = Access mode is Free Red = Access mode is Secure
Flashes Green	Access has been granted.
Flashes Red	Access has been denied.
Flashes (Blue)	Reading and validating a PIV card. Reading a Gallagher mobile credential.

LED (squiggle)	Cardax IV indication
3 Flash (Amber)	No communications with the Controller.
On (Green or Red)	Fully configured and functioning normally. Green = Access mode is Free Red = Access mode is Secure
Flashes Green	Access has been granted.
Flashes Red	Access has been denied.

6 Accessories

Accessory	Product Code
T11 Dress Plate, Black, Pk 10	C300321
T11 Bezel, Black, Pk 10	C300284
T11 Bezel, White, Pk 10	C300285
T11 Bezel, Silver, Pk 10	C300286
T11 Bezel, Gold, Pk 10	C300287
T11 Spacer, Black, Pk 10	C300302
T11 Spacer, White, Pk 10	C300303
T11/T12 Protective Cover Spacer	C300311
T11/T12 Protective Cover	C300271

7 Technical specifications

Routine maintenance:	Not applicable for this reader				
Cleaning:	This reader should only be cleaned with a clean, lint free, damp cloth				
Voltage:	9 Vdc - 16 Vdc				
Current ⁴ :		MIFARE Reader		Multi Tech Reader	
		Idle ¹	Maximum ²	Idle ¹	Maximum ²
	at 9 Vdc	70 mA	115 mA	106 mA	176 mA
	at 13.6 Vdc	50 mA	77 mA	80 mA	142 mA
Temperature range:	-35 °C to +70 °C Note: Direct sunlight may increase the internal reader temperature above the ambient temperature level				
Humidity:	0 - 95% non-condensing ³				
Environmental protection:	IP68				
Impact rating:	IK07				
Unit dimensions:	Height 115 mm (4.5") Width 70 mm (2.8") Depth 12 mm (0.5")				
Maximum number of readers on one HBUS cable:	20				

¹ The reader is idle.

² Maximum reader current during credential read.

³ Gallagher T Series readers are UL humidity tested and certified to 85% and have been independently verified to 95%.

⁴ Reader currents verified by UL are provided in the document "*3E2793 Gallagher Command Centre UL Configuration Requirements*".

Note: The current values stated above have been reported using the default configuration for a reader in Command Centre. Changing the configuration may vary the current value.

8 Approvals and Compliance Standards



This symbol on the product or its packaging indicates that this product must not be disposed of with other waste. Instead, it is your responsibility to dispose of your waste equipment by handing it over to a designated collection point for the recycling of waste electrical and electronic equipment. The separate collection and recycling of your waste equipment at the time of disposal will help conserve natural resources and ensure that it is recycled in a manner that protects human health and the environment. For more information about where you can drop off your waste equipment for recycling, please contact your local city recycling office or the dealer from whom you purchased the product.



This product complies with the environmental regulations for the Restriction of Hazardous Substances in electrical and electronic equipment (RoHS). The RoHS directive prohibits the use of electronic equipment containing certain hazardous substances in the European Union.



This device complies with part 15 of the FCC Rules. Operation is subject to the following two conditions: (1) This device may not cause harmful interference, and (2) this device must accept any interference received, including interference that may cause undesired operation.

Note: Changes or modifications not expressly approved by Gallagher Limited could void the user's authority to operate this equipment.

Note: This equipment has been tested and found to comply with the limits for a Class B digital device, pursuant to part 15 of the FCC Rules. These limits are designed to provide reasonable protection against harmful interference in a residential installation. This equipment generates, uses and can radiate radio frequency energy and, if not installed and used in accordance with the instructions, may cause harmful interference to radio communications. However, there is no guarantee that interference will not occur in a particular installation. If this equipment does cause harmful interference to radio or television reception, which can be determined by turning the equipment off and on, the user is encouraged to try to correct the interference by one or more of the following measures:

- Reorient or relocate the receiving antenna.
- Increase the separation between the equipment and receiver.
- Connect the equipment into an outlet on a circuit different from that to which the receiver is connected.
- Consult the dealer or an experienced radio/TV technician for help.

Industry Canada This device complies with Industry Canada licence-exempt RSS standard(s). Operation is subject to the following two conditions: (1) this device may not cause interference, and (2) this device must accept any interference, including interference that may cause undesired operation of the device.

Industrie Canada Le présent appareil est conforme aux CNR d'Industrie Canada applicables aux appareils radio exempts de licence. L'exploitation est autorisée aux deux conditions suivantes : (1) l'appareil ne doit pas produire de brouillage, et (2) l'utilisateur de l'appareil doit accepter tout brouillage radioélectrique subi, même si le brouillage est susceptible d'en compromettre le fonctionnement.

UL Installations Please refer to the document "3E2793 Gallagher Command Centre UL Configuration Requirements" for a guide to configuring the Gallagher system to the appropriate UL Standard. Installers must ensure these instructions are followed to ensure the installed system is UL compliant.

AS/NZS IEC 60839.11.1:2019 Grade 4, Class II

HVIN	FCC ID	IC ID
C300410 T11 MIFARE Reader, Black C300411 T11 MIFARE Reader, White C305410 High Sec T11 Reader, Black C305411 High Sec T11 Reader, White	M5VC30042XA	7369A-C30022X
C300410- T11 MIFARE Reader, Black C300411- T11 MIFARE Reader, White	M5VC30042XB	7369A-C30022XB
C300430 T11 Multi Tech Reader, Black C300431 T11 Multi Tech Reader, White C305430 High Sec T11 Reader, Multi Tech, Black C305431 High Sec T11 Reader, Multi Tech, White	M5VC30044XA	7369A-C30024X
C300430- T11 Multi Tech Reader, Black C300431- T11 Multi Tech Reader, White	M5VC30044XB	7369A-C30024XB
C500430 SMB T11 Reader, Black C500431 SMB T11 Reader, White	M5VC30044XA	
C500430- SMB T11 Reader, Black C500431- SMB T11 Reader, White	M5VC30044XB	



US - Equipment: com, burg and acc reader
CA - Equipment: com, burg reader



9 Mounting dimensions

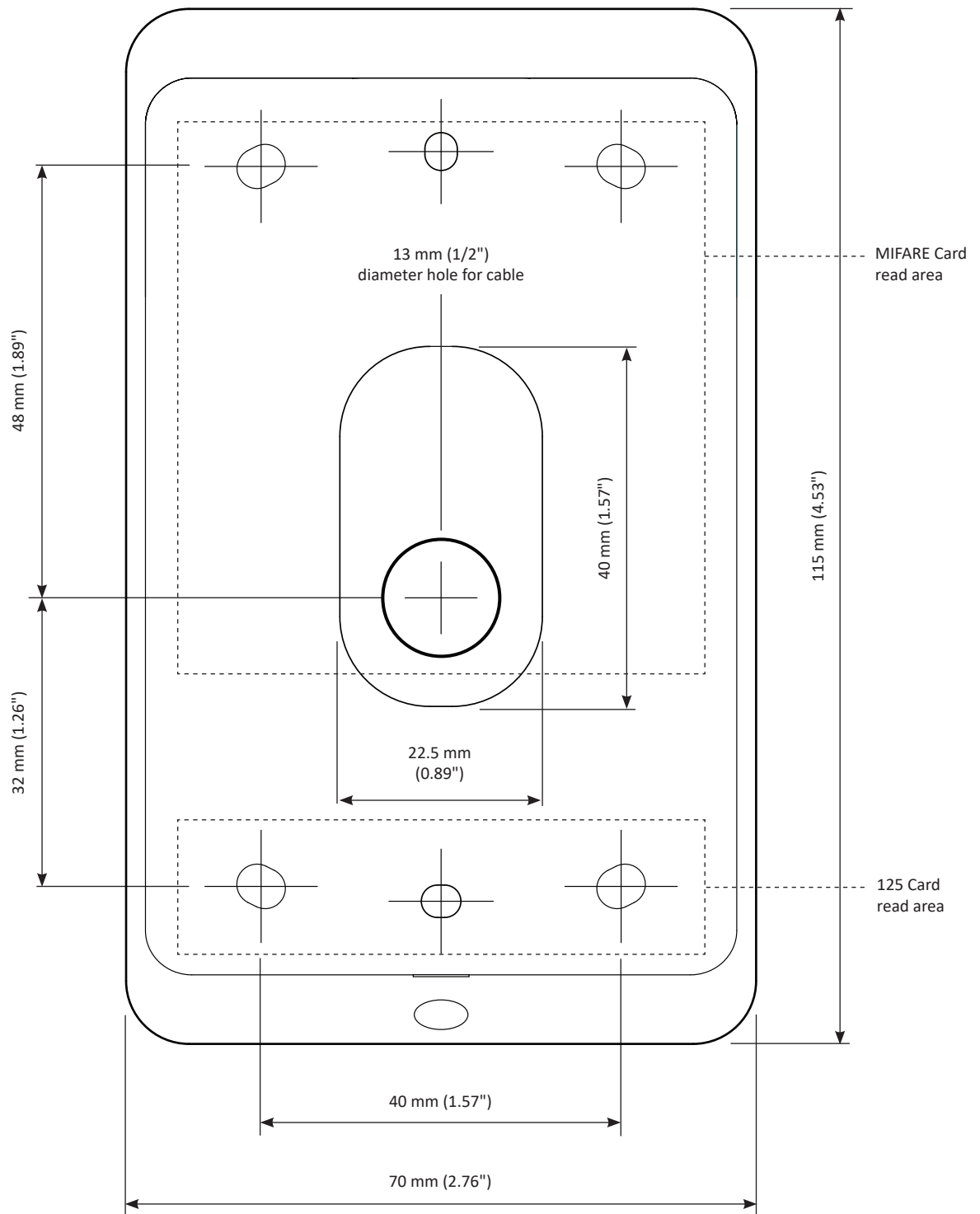

IMPORTANT

This picture is not to scale, therefore use the measurements provided.