



EMC Technologies Pty Ltd
ABN 82 057 105 549
176 Harrick Road, Keilor Park,
Victoria 3042, Australia

Ph: + 61 (0)3 9365 1000
Fax: + 61 (0)3 9331 7455
Email: sales@emctech.com.au

RADIO REPORT FOR CERTIFICATION
to
FCC PART 15 Subpart C (Section 15.225)

FCC ID: M5VC30040X

Test Sample: T10 Mifare Reader
Model: C305400

Client: Gallagher Group Ltd.

Report Number: M160412-3

Issue Date: 02 June 2016

EMC Technologies Pty Ltd reports apply only to the specific samples tested under stated test conditions. It is the manufacturer's responsibility to assure that additional production units of this model are manufactured with identical electrical and mechanical components. EMC Technologies Pty Ltd shall have no liability for any deductions, inferences or generalisations drawn by the client or others from EMC Technologies Pty Ltd issued reports. This report shall not be used to claim, constitute or imply product endorsement by EMC Technologies Pty Ltd.



Accredited for compliance with ISO/IEC 17025. The results of the test, calibrations and/or measurement included in this document are traceable to Australian/national standards. NATA is a signatory to the ILAC Mutual Recognition Arrangement for the mutual recognition of the equivalence of testing, calibration and inspection reports.

This document shall not be reproduced except in full.

RADIO REPORT FOR CERTIFICATION
to
FCC PART 15 Subpart C (Section 15.225)
EMC Technologies Report No.: M160412-3
Issue Date: 02 June 2016

CONTENTS

1.0	INTRODUCTION
2.0	GENERAL INFORMATION
3.0	TEST RESULTS
3.1	§15.203 Antenna Requirement
3.2	§15.207 Conducted Limits
3.3	§15.209 Radiated Emission Limits; General Requirements
3.4	§15.225(a) Fundamental Field Strength
3.5	§15.225(b and c) Transmission Mask 13.110-14.010 MHz
3.6	§15.225(d) Spurious Emissions
3.7	§15.225(e) Frequency Tolerance
4.0	COMPLIANCE STATEMENT
5.0	MEASUREMENT UNCERTAINTY



Accredited for compliance with ISO/IEC 17025. The results of the test, calibrations and/or measurement included in this document are traceable to Australian/national standards. NATA is a signatory to the ILAC Mutual Recognition Arrangement for the mutual recognition of the equivalence of testing, calibration and inspection reports.

This document shall not be reproduced except in full.

RADIO REPORT FOR CERTIFICATION
to
FCC PART 15 Subpart C (Section 15.225)

Report Number: M160412-3
Issue Date: 02 June 2016

Sample: T10 Mifare Reader
Model: C305400
Serial Number: 1613507001 and 1613507002
Manufacturer: Gallagher Group Ltd.

FCC ID: M5VC30040X
Equipment Type: Intentional Radiator (Transceiver)

Tested for: Gallagher Group Ltd.
Address: 181 Kahikatea Drive, Melville, Hamilton 3206, New Zealand
Phone: +64 7 838 9800
Fax: +64 7 838 9801
Contact: Menardo Lazaro
Email: menardo.lazaro@gallagher.com

Standard: FCC Part 15 – *Radio Frequency Devices*
FCC Part 15 Subpart C – *Intentional Radiators*
Section 15.225 – *Operation within the band 13.110-14.010 MHz*

Test Dates: 20th April 2016 to 17th May 2016

Test Engineers:



Chris Martin



Justin McHenry

Attestation:

I hereby certify that the device(s) described herein were tested as described in this report and that the data included is that which was obtained during such testing.

Authorised Signatory:

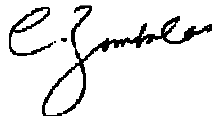

Chris Zombolas
Technical Director
EMC TECHNOLOGIES PTY LTD

Issued by: EMC Technologies Pty. Ltd., 176 Harrick Road, Keilor Park, VIC 3042, Australia.
Phone : +61 3 9365 1000 **Fax:** +61 3 9331 7455 **Web:** www.emctech.com.au



Accredited for compliance with ISO/IEC 17025. The results of the test, calibrations and/or measurement included in this document are traceable to Australian/national standards. NATA is a signatory to the ILAC Mutual Recognition Arrangement for the mutual recognition of the equivalence of testing, calibration and inspection reports.

This document shall not be reproduced except in full.

RADIO REPORT FOR CERTIFICATION to FCC PART 15 SUBPART C (SECTION 15.225)

1.0 INTRODUCTION

Test results and procedures were performed in accordance with the following Federal Communications Commission (FCC) standards/regulations:

47 CFR, Part 15, Subpart C: Rules for intentional radiators
 Section 15.203: Antenna requirements
 Section 15.207: Conducted Limits
 Section 15.209: Radiated Emission Limits (General requirements)
 Section 15.225: Operation within the band 13.110-14.010 MHz

The sample **complied** with the requirements of 47 CFR, Part 15 Subpart C - Section 15.225.

The measurement procedure used was in accordance with ANSI C63.10: 2013. The instrumentation conformed to the requirements of ANSI C63.2: 2009.

1.1 Summary of Results

FCC Part 15 Subpart C	Test Performed	Results
15.203	Antenna Requirement	Complied
15.207	Conducted Limits	Complied
15.209	Radiated Emissions Limits; General Requirements	Complied
15.225(a)	Fundamental Field Strength	Complied
15.225(b and c)	Transmission Mask 13.110-14.010 MHz	Complied
15.225(d)	Spurious Emissions	Complied
15.225(e)	Frequency Tolerance	Complied

1.2 Modifications by EMC Technologies

No modifications were performed.

2.0 GENERAL INFORMATION

(Information supplied by the Client)

2.1 EUT (Transmitter) Details

Wireless Radio: 13.56 MHz
Antenna type: Integral, PCB loop

2.2 EUT (Host) Details

Test Sample: T10 Mifare Reader
Model Number: C305400
Serial Number: 1613507001 and 1613507002
Manufacturer: Gallagher Group Ltd.

Supply Rating: 13.6Vdc 82mA (standby) or 115mA (peak)
Highest operating Frequency: 27.12 MHz
Dimensions: 115mm x 35mm x 15mm
Interference Cables: DC cable <3m
 Communication cable >3m
 Ethernet cable <3m

Load/ auxiliary equipment: Gallagher controller 6000
 Laptop

2.3 Test Configuration

Conducted Emission measurements were made on a power supply connected to the Controller 6000 and sample. The antenna on the sample (SN 1613507002) was replaced with a resistive load to generate case emissions.

Radiated measurements were made on an unmodified sample (SN 1613507002).

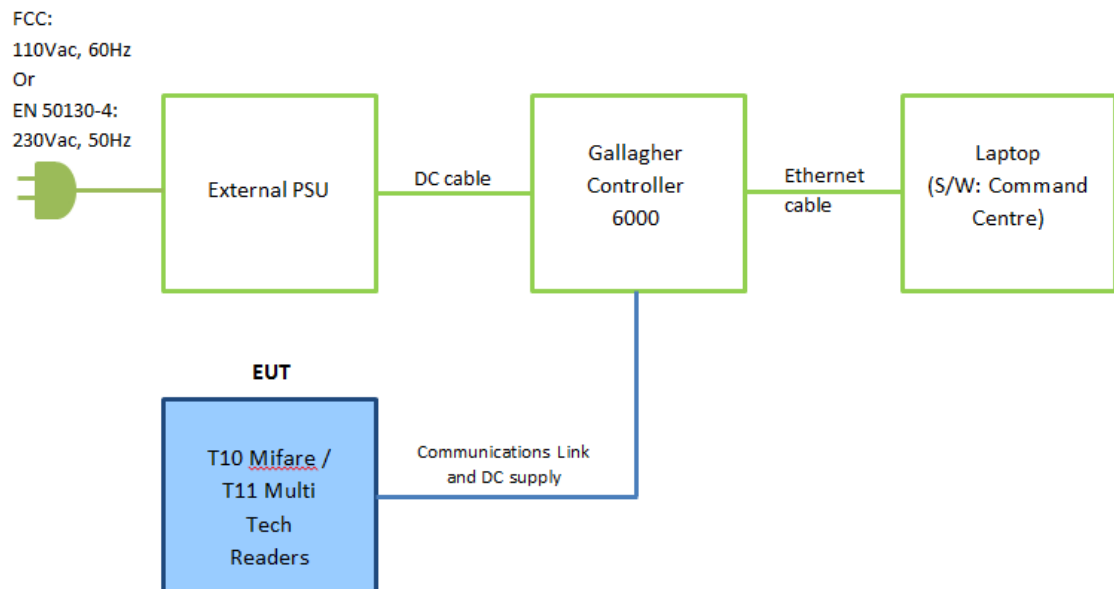

2.4 Operational Description

T10 Mifare Reader was a smart card proximity reader that operated with a fundamental frequency of 13.56MHz. It had 7 wires: 2 wires for DC power and 5 wires for communications. Rated operating voltage was 13.6Vdc.



Accredited for compliance with ISO/IEC 17025. The results of the test, calibrations and/or measurement included in this document are traceable to Australian/national standards. NATA is a signatory to the ILAC Mutual Recognition Arrangement for the mutual recognition of the equivalence of testing, calibration and inspection reports.

This document shall not be reproduced except in full.

2.5 Test Facility

2.5.1 General

EMC Technologies Pty Ltd is listed by the FCC as a test laboratory able to perform compliance testing for the public. EMC Technologies is listed as an FCC part 47CFR2.948 test lab and may perform the testing required under Parts 15 and 18 – **FCC Registration Number 90560**

EMC Technologies Pty Ltd has also been accredited as a Conformity Assessment Body (CAB) by Australian Communications and Media Authority (ACMA) under the APECTEL MRA and is designated to perform compliance testing on equipment subject to Declaration of Conformity (DoC) and Certification under Parts 15 and 18 of the FCC Commission's rules – **Registration Number 494713 & Designation number AU0001.**

EMC Technologies indoor open area test site (iOATS) have been accepted by Industry Canada for the performance of radiated measurements in accordance with RSS-Gen, Issue 8 - **Industry Canada iOATS number - IC 3569B**

Measurements in this report were performed at EMC Technologies' laboratory in Keilor Park, Victoria Australia.

2.5.2 NATA Accreditation

NATA is the Australian National laboratory accreditation body and has accredited EMC Technologies to operate to the IEC/ISO17025 requirements. A major requirement for accreditation is the assessment of the company and its personnel as being technically competent in testing to the standards. This requires fully documented test procedures, continued calibration of all equipment to the National Standard at the National Measurements Institute (NMI) and an internal quality system to ISO 9002. NATA has mutual recognition agreements with the National Voluntary Laboratory Accreditation Program (NVLAP) and the American Association for Laboratory Accreditation (A²LA).

EMC Technologies is accredited in Australia by the National Association of Testing Authorities (NATA). All testing in this report has been conducted in accordance with EMC Technologies' scope of NATA accreditation.

The current full scope of accreditation can be found on the NATA website: www.nata.asn.au



Accredited for compliance with ISO/IEC 17025. The results of the test, calibrations and/or measurement included in this document are traceable to Australian/national standards. NATA is a signatory to the ILAC Mutual Recognition Arrangement for the mutual recognition of the equivalence of testing, calibration and inspection reports.

This document shall not be reproduced except in full.

2.6 Test Equipment Calibration

Measurement instrumentation and transducers were calibrated in accordance with the applicable standards by an independent NATA registered laboratory such as Agilent Technologies (Australia) Pty Ltd or the National Measurement Institute (NMI) or in-house. All equipment calibration is traceable to Australian national standards at the National Measurements Institute.

Equipment Type	Make/Model/Serial Number	Last Cal. dd/mm/yy	Due Date dd/mm/yy	Cal. Interval
Chamber	Frankonia SAC-10-2 (R-139)	8/01/2016	8/01/2017	1 Year, *1
	Scalar RFI S100 (R-010)	Not Required		
EMI Receiver	R&S ESU40 20 Hz – 40 GHz Sn: 100392 (R-140)	19/11/2015	19/11/2016	1 Year, *2
	HP 85460A 9kHz-6.5 GHz Sn 3448A00287	10/11/2016	10/11/2017	1 Year, *2
Antennas	EMCO 6502 Active Loop 9kHz – 30MHz Sn. 9311-2801 (A-231)	20/07/2015	20/07/2018	3 Year, *2
	SUNOL JB6 BICONILOG 30 – 6000 MHz Sn. A012312 (A-363)	16/05/2014	16/05/2016	2 Year, *2
Cables	Room 12 inbuilt cable Panel 1 to 10m (C-422)	09/05/2016	09/05/2016	1 Year, *1
	Room 12 Antenna cable (C-437)	09/05/2016	09/05/2016	1 Year, *1
	Cable- 3 metre BNC (C-284)	4/01/2016	4/01/2017	1 Year, *1
	Cable- 3 metre BNC (C-444)	27/05/2015	27/05/2016	1 Year, *1
LISN	EMCO 3810/2NM Sn. 9607-1505 (L-019)	23/10/2014	23/10/2016	2 Year, *1

Note *1. Internal NATA calibration.

Note *2. External NATA / A2LA calibration



Accredited for compliance with ISO/IEC 17025. The results of the test, calibrations and/or measurement included in this document are traceable to Australian/national standards. NATA is a signatory to the ILAC Mutual Recognition Arrangement for the mutual recognition of the equivalence of testing, calibration and inspection reports.

This document shall not be reproduced except in full.

3.0 TEST RESULTS

3.1 §15.203 Antenna Requirement

An internal, permanently attached antenna was incorporated within the T10 Mifare Reader ensuring that it could not be replaced.

3.2 §15.207 Conducted Limits

3.2.1 Test Procedure

The arrangement specified in ANSI C63.10: 2013 was adhered to for the conducted EMI measurements. The EUT was placed in the RF screened enclosure and a CISPR EMI Receiver as defined in ANSI C63.2: 2009 was used to perform the measurements.

The EMI Receiver was operated under program control, using the Max-Hold function and automatic frequency scanning, measurement and data logging techniques. The specified 0.15 MHz to 30 MHz frequency range was sub-divided into sub-ranges to ensure that all short duration peaks were captured.

3.2.2 Peak Maximising Procedure

For each of the sub-ranges, the EMI receiver was set to continuous scan with the Peak detector set to Max-Hold mode. The Quasi-Peak detector and the Average detector were then used to measure the actual Quasi-Peak and Average level of the most significant peaks detected.

3.2.3 Calculation of Voltage Levels

The voltage levels were automatically measured in software and compared to the test limit. The method of calculation was as follows:

$$V_{EMI} = V_{Rx} + L_{BPF}$$

Where:

- V_{EMI} = the Measured EMI voltage in dB μ V to be compared to the limit.
- V_{Rx} = the Voltage in dB μ V read directly at the EMI receiver.
- L_{BPF} = the insertion loss in dB of the LISN, cables and limiter.

3.2.4 Plotting of Conducted Emission Measurement Data

The measurement data pertaining to each frequency sub-range were concatenated to form a single graph of (peak) amplitude versus frequency. This was performed for both Active and Neutral lines and the composite graph was subsequently plotted. A list of the highest relevant peaks and the respective Quasi-Peak and Average values were also plotted on the graph.

3.2.5 Results of Conducted Emission Measurement

The highest conducted emission measured was -7.5 dB μ V below the quasi-peak limit (point 1 on the neutral line graph below) as outlined in §15.207. All other measured peaks were below this point.



Accredited for compliance with ISO/IEC 17025. The results of the test, calibrations and/or measurement included in this document are traceable to Australian/national standards. NATA is a signatory to the ILAC Mutual Recognition Arrangement for the mutual recognition of the equivalence of testing, calibration and inspection reports.

This document shall not be reproduced except in full.

3.2.5.1 Active Line

Gallagher Group Ltd.
 Conducted Emissions (0.15-30 MHz)
 T10 Milfare Reader (Loaded)
 Active Line

FCC 15.207
 Conducted Emissions (dBuV)
 ~ = QP Value * = CISPR Av

Job No: M160412
 Test Date: 20/04/2016

Limit1: FCC_BQPN FCC PART 15 CLASS B CONDUCTED QP LIMITS (2002)
 Limit2: FCC_BAVN FCC PART 15 CLASS B CONDUCTED AVERAGE LIMIT (2002)

Trace 2: Active Line
 R:\FMELB\2016\APRM\160412 GALLAGHER GROUP LTD\CONDUCTED FILES\M160412C\GraphA.bmp
 t:L0191016 c1:C2840117 c2:C4440516 p:NONE a:NONE
 Site ID: Room#2,176 Harrick Rd, Keilor Park, Vic Test Officer: Chris Martin-Plot date: 05-31-2016 09:31:37
 Wkst:0-Wplt:160 Rev:12-Rx: Graph No. 1

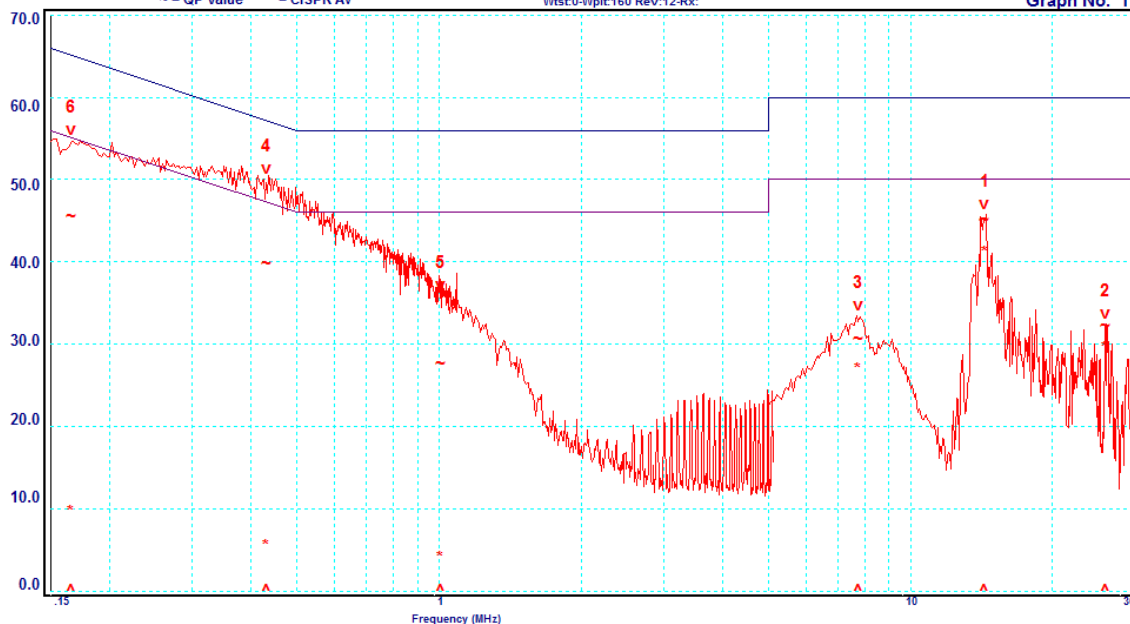

Point	Frequency (MHz)	Quasi-Peak (dBμV/m)	Limit (dBμV/m)	Margin (dB)	Average (dBμV/m)	Limit (dBμV/m)	Margin (dB)
1	14.34	45.1	60	-14.9	41.1	50	-8.9
2	25.88	32.2	60	-27.8	29.4	50	-20.6
3	7.739	30.6	60	-29.4	26.9	50	-23.1
4	0.431	39.8	57.2	-17.4	5.4	47.2	-41.8
5	1.009	27.6	56	-28.4	3.9	46	-42.1
6	0.166	45.5	65.1	-19.6	9.5	55.1	-45.6



Accredited for compliance with ISO/IEC 17025. The results of the test, calibrations and/or measurement included in this document are traceable to Australian/national standards. NATA is a signatory to the ILAC Mutual Recognition Arrangement for the mutual recognition of the equivalence of testing, calibration and inspection reports.

This document shall not be reproduced except in full.

3.2.5.2 Neutral Line

Gallagher Group Ltd.
 Conducted Emissions (0.15-30 MHz)
 T10 Milfare Reader (Loaded)
 Neutral Line
 FCC 15.207
 Conducted Emissions (dBuV)
 ~ = QP Value * = CISPR Av

Job No: M160412
 Test Date: 20/04/2016

Limit1: FCC_BQPN
 Limit2: FCC_BAVN
 FCC PART 15 CLASS B CONDUCTED QP LIMITS (2002)
 FCC PART 15 CLASS B CONDUCTED AVERAGE LIMIT (2002)
 Trace 2: Neutral Line
 R:\F\MELB\2016\APRM160412 GALLAGHER GROUP LTD\CONDUCTED FILES\M160412C\GraphN.bmp
 t:L0191016 c1:C2840117 c2:C4440516 p:NONE a:NONE
 Site ID: Room#2,176 Harrick Rd, Keilor Park, Vic Test Officer: Chris Martin-Plot date: 05-31-2016 09:39:48
 Wkst:0-Wplt:160 Rev:12-Rx: Graph No. 2

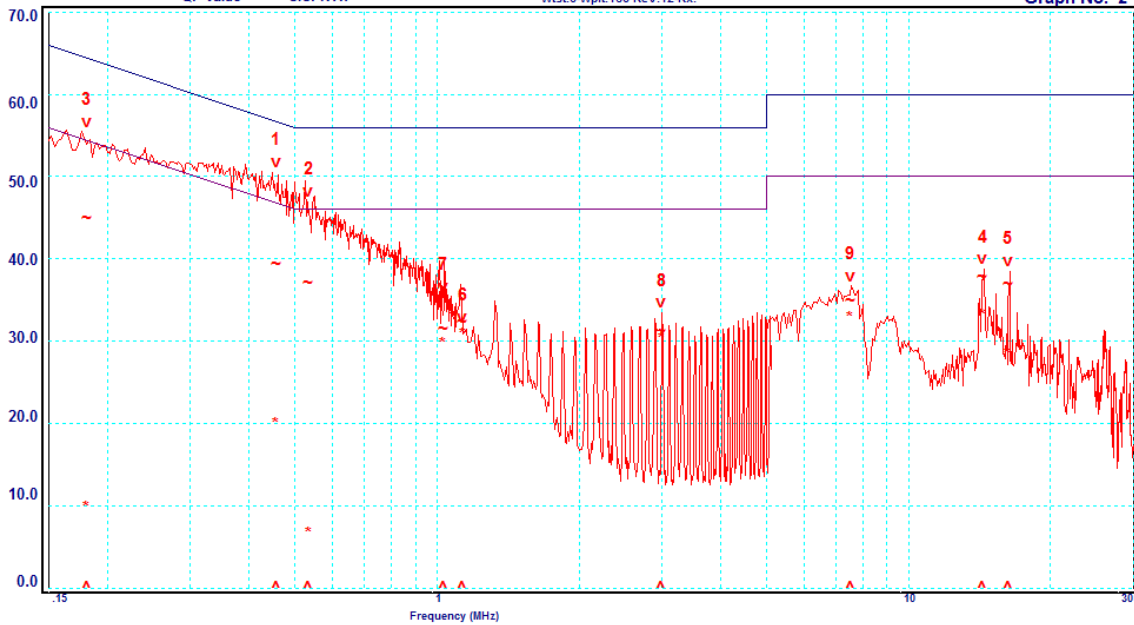

Point	Frequency (MHz)	Quasi-Peak (dBµV/m)	Limit (dBµV/m)	Margin (dB)	Average (dBµV/m)	Limit (dBµV/m)	Margin (dB)
1	0.456	39.3	46.8	-7.5	19.9	56.8	-36.9
2	0.534	37.1	46	-8.9	6.5	56	-49.5
3	0.181	44.9	54.4	-9.5	9.7	64.4	-54.7
4	14.34	37.8	50	-12.2	33.0	60	-27.0
5	16.23	36.9	50	-13.1	28.3	60	-31.7
6	1.135	32.4	46	13.6	30.8	56	-25.2
7	1.030	31.4	46	-14.6	29.6	56	-26.4
8	2.991	31.2	46	-14.8	30.1	56	-25.9
9	7.525	34.9	50	15.1	32.8	60	-27.2

3.2.6 Conclusion

The conducted emissions were below the average and quasi-peak limits of §15.207.

3.3 §15.209 Radiated emission limits; general requirements

The general requirement limits were applied to the measurements of §15.225(d).

3.4 §15.225(a) Fundamental Field Strength

The field strength of the fundamental transmitted frequency was measured inside a compliant CISPR16-1-4 semi-anechoic chamber. The EUT was positioned on a test turn-table and rotated through 360° to determine the highest emissions. The measurement antenna was also varied between 1 and 4 metres height. The measurements were made with the loop antenna in three orthogonal orientations.

3.4.1 Result

All measurements were made at a distance of 10 metres. The fundamental emissions were measured using a peak detector and as the level did not exceed the limit further measurements were not made.

Measure Antenna	Frequency MHz	E(peak) dBµV/m	E(peak) µV/m	30 m Limit µV/m	10 m Limit µV/m	Result
X	13.56	69.4	2,951	15,848	47,315	Complied
Y	13.56	68.1	2,541	15,848	47,315	Complied
Z	13.56	68.6	2,692	15,848	47,315	Complied

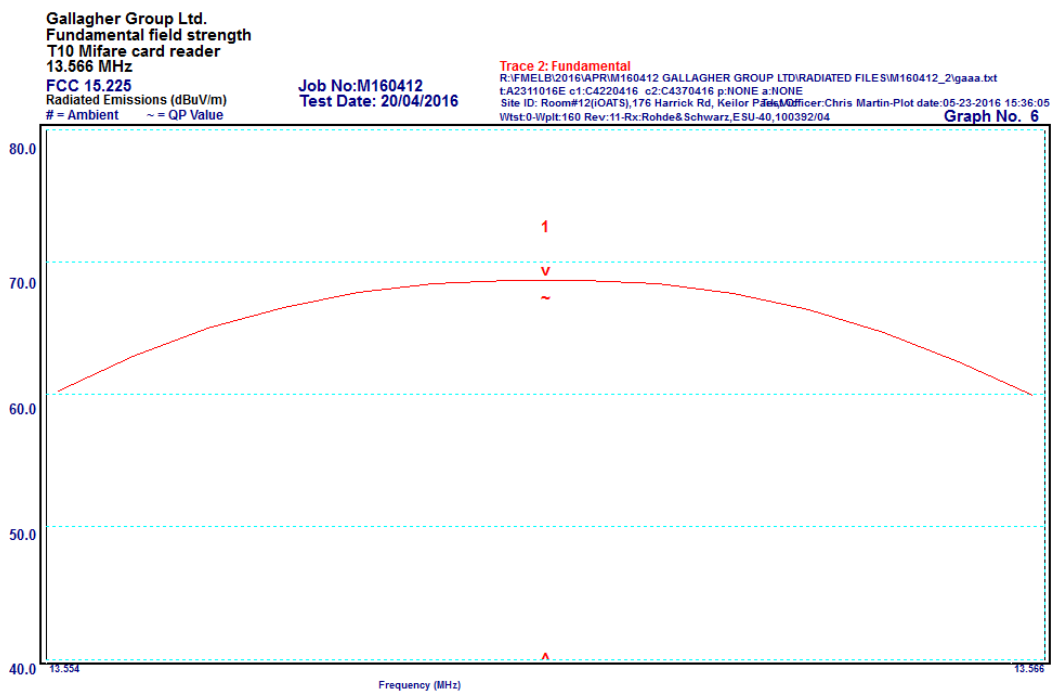

3.4.2 Conclusion

The field strength of the fundamental transmitted signal complied with the limit of §15.225(a).

3.5 §15.225(b and c) Transmission Mask 13.110-14.010 MHz

Measurements were made at 10 metres using a 0.6 metre loop antenna. Initial investigations were made to find the EUT and measuring antenna orientations that produce the highest reading on the EMI receiver/spectrum analyser. These measurements were made at the transmit frequency, 13.56 MHz.

With the EUT and measuring antenna orientated in the position giving maximum emission measurements with a bandwidth of 9 kHz were made between 13.110 MHz and 14.010 MHz. The following limit mask applied:

Frequency band (MHz)	Field strength limit at 30 m (µV/m)	Equivalent field strength at 10 m (dBµV/m)
13.110 to 13.410	106	59.6
13.410 to 13.553	334	69.6
13.553 to 13.567	15,848	103.1
13.567 to 13.710	334	69.6
13.710 to 14.010	106	59.6

3.5.1 Result

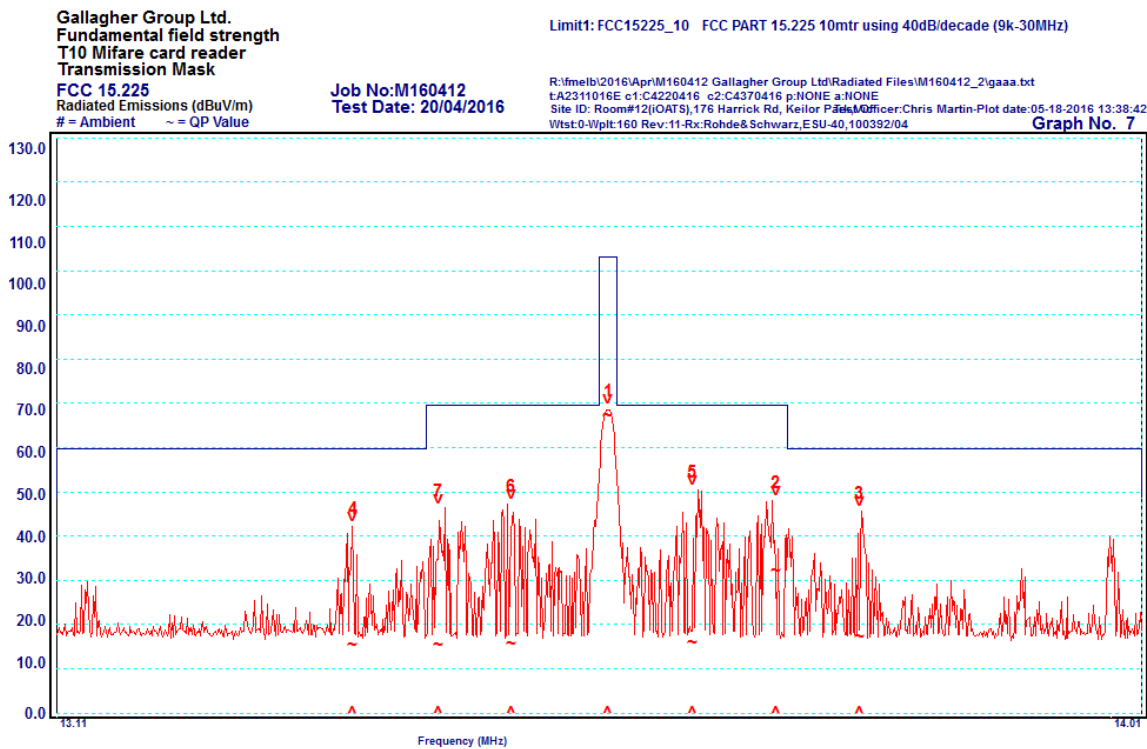

Point	Frequency (MHz)	Peak at 10 m (dBµV/m)	Limit at 10 m (dBµV/m)	Result
1	13.56	68.6	103.1	Complied
2	13.70	48.0	69.6	Complied
3	13.77	45.7	59.6	Complied
4	13.35	42.2	59.6	Complied
5	13.63	50.4	69.6	Complied
6	13.48	47.2	69.6	Complied
7	13.42	46.2	69.6	Complied

3.5.2 Conclusion

The transmitted signal complied with the limit mask of §15.225(b and c).

 <p>Accreditation No. 5292</p>	<p>Accredited for compliance with ISO/IEC 17025. The results of the test, calibrations and/or measurement included in this document are traceable to Australian/national standards. NATA is a signatory to the ILAC Mutual Recognition Arrangement for the mutual recognition of the equivalence of testing, calibration and inspection reports.</p> <p style="text-align: center;">This document shall not be reproduced except in full.</p>
---	--

3.6 §15.225(d) Spurious Emissions

Radiated EMI tests were performed in a semi-anechoic chamber compliant with CISPR16-1-4. The chamber allows a 2m x 2m x 2m test volume up to 6 GHz, at a test distance of 3 metres and 10 metres.

The test frequency range was sub-divided into smaller bands with sufficient frequency resolution to permit reliable display and identification of possible EMI peaks. Measurements between 9 KHz and 30 MHz were made at 10 metres using a 0.6 metre loop antenna and calibrated Biconilog antenna for measurements between 30 MHz and 1000 MHz. Calibrated EMCO 3115, EMCO 3116 and ETS standard gain horn antennas were used for measurements between 1 to 25 GHz.

The EUT was slowly rotated with the spectrum analyser was set to Max-Hold. This was performed for two antenna heights. When an emission was located, it was positively identified and its maximum level found by rotating the automated turntable and by varying the antenna height. The procedure was repeated with the device orientated in three orthogonal axis to further maximise the emission.

Each significant peak was investigated with the Peak/Average Detectors. The measurement data for each frequency range was corrected for cable losses, antenna factors and preamplifier gain. This process was performed for both horizontal and vertical antenna polarisations.

3.6.1 Calculation of field strength

The field strength was calculated automatically by the software using all the pre-stored calibration data. The method of calculation is shown below:

$$E = V + AF - G + L$$

Where:

- E** = Radiated Field Strength in dB μ V/m.
- V** = EMI Receiver Voltage in dB μ V. (measured value)
- AF** = Antenna Factor in dB. (stored as a data array)
- G** = Preamplifier Gain in dB. (stored as a data array)
- L** = Cable loss in dB. (stored as a data array of Insertion Loss versus frequency)



Accredited for compliance with ISO/IEC 17025. The results of the test, calibrations and/or measurement included in this document are traceable to Australian/national standards. NATA is a signatory to the ILAC Mutual Recognition Arrangement for the mutual recognition of the equivalence of testing, calibration and inspection reports.

This document shall not be reproduced except in full.

3.6.2 Frequency Band: 9 kHz - 30 MHz

Measurements were made at a distance of 10 metres. The measurement of emissions between 9 kHz – 150 kHz were made with a resolution bandwidth (RBW) of 200 Hz and the video bandwidth (VBW) of 3 kHz, 150 kHz – 30 MHz were measured with the resolution bandwidth (RBW) of 9 kHz and the video bandwidth (VBW) of 30 kHz.

3.6.2.1 Results

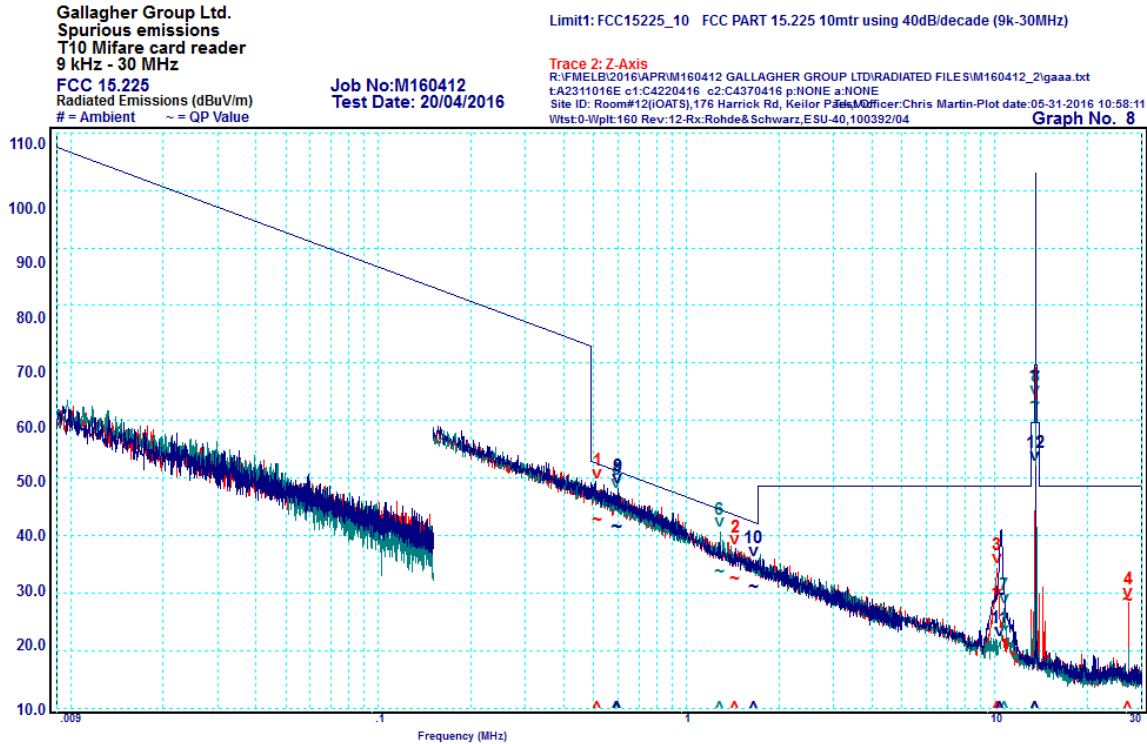

Point	Frequency (MHz)	Loop Orientation	Quasi-Peak (dBµV/m)	Limit (dBµV/m)	Margin (dB)
1	0.515	Z	42.7	52.46	-9.76
2	1.440	Z	32.3	43.56	-11.26
3	10.17	Z	30.3	48.6	-18.3
4	27.12	Z	28.7	48.6	-19.9
5	0.592	Y	41.4	51.26	-9.86
6	1.278	Y	33.6	44.6	-11.0
7	10.75	Y	24.1	48.6	-24.5
8	13.56	Y	62.9	103.1	-40.2
9	0.598	X	41.3	51.18	-9.88
10	1.647	X	30.9	42.4	-11.5
11	29.80	X	29.8	48.6	-18.8
12	68.10	X	68.1	103.1	-35.0



Accredited for compliance with ISO/IEC 17025. The results of the test, calibrations and/or measurement included in this document are traceable to Australian/national standards. NATA is a signatory to the ILAC Mutual Recognition Arrangement for the mutual recognition of the equivalence of testing, calibration and inspection reports.

This document shall not be reproduced except in full.

3.6.3 Frequency Band: 30 - 1000 MHz

Measurements were made at a distance of 10 metres. The measurement of emissions between 30 - 1000 MHz were made with a resolution bandwidth (RBW) of 120 kHz and the video bandwidth (VBW) of 300 kHz.

3.6.3.1 Vertical Polarisation

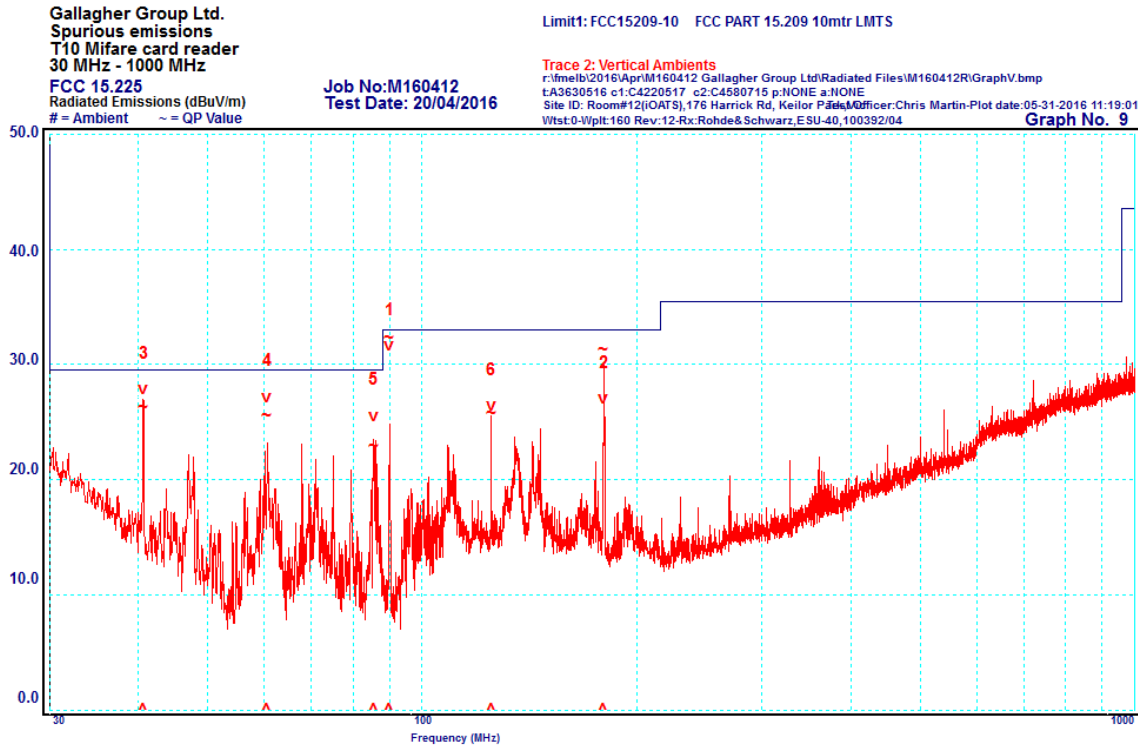

Point	Frequency (MHz)	Quasi-Peak (dBµV/m)	Limit (dBµV/m)	Margin (dB)
1	90.01	32.2	33	-0.8
2	179.99	31.2	33	-1.8
3	40.68	26.3	29.5	-3.2
4	60.68	25.6	29.5	-3.9
5	85.49	22.8	29.5	-6.7
6	125.01	25.7	33	-7.3



Accredited for compliance with ISO/IEC 17025. The results of the test, calibrations and/or measurement included in this document are traceable to Australian/national standards. NATA is a signatory to the ILAC Mutual Recognition Arrangement for the mutual recognition of the equivalence of testing, calibration and inspection reports.

This document shall not be reproduced except in full.

3.6.3.2 Horizontal Polarisation

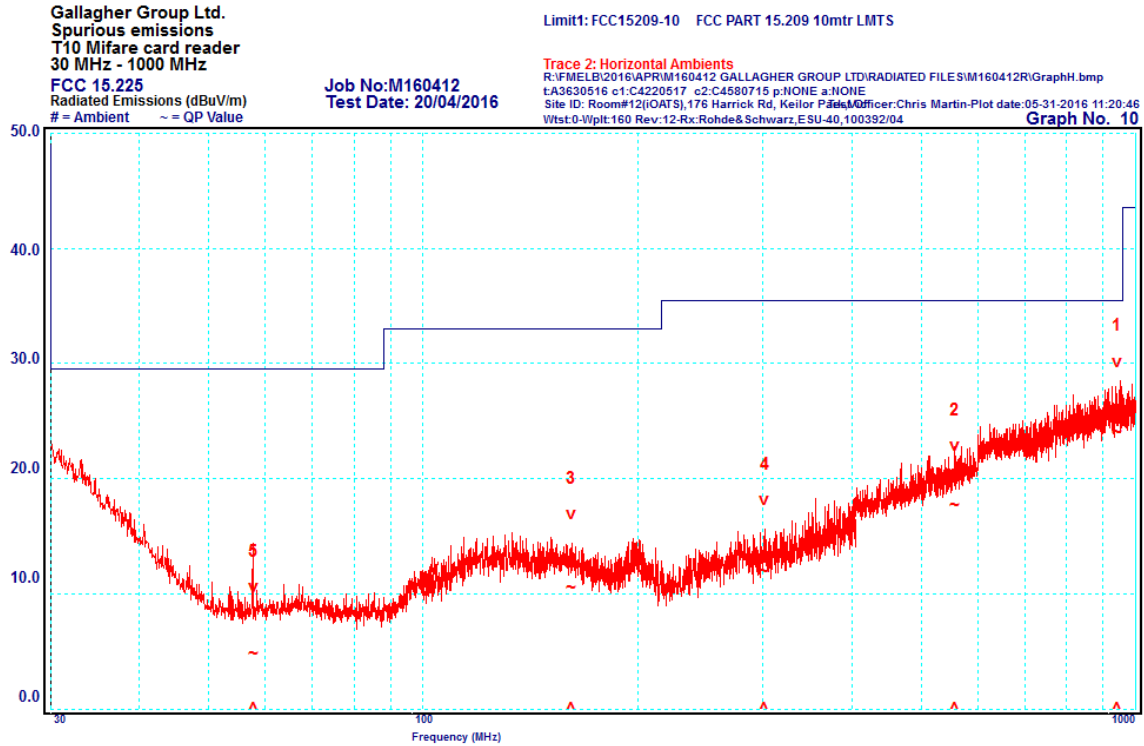

Point	Frequency (MHz)	Quasi-Peak (dBμV/m)	Limit (dBμV/m)	Margin (dB)
1	941.85	24.0	35.5	-11.5
2	557.39	17.7	35.5	-17.8
3	161.26	10.5	33.0	-22.5
4	301.87	12.0	35.5	-23.5
5	57.81	4.8	29.5	-24.7

3.6.4 Conclusion

The spurious emissions complied with the general limits of §15.209 by a margin of 0.8 dB.

3.7 §15.225(e) Frequency Tolerance

The frequency tolerance of the carrier signal shall be maintained within ±0.01% of the operating frequency over a temperature variation of -20 °C to + 50 °C at normal supply voltage, and for a variation in the primary supply voltage from 85% to 115% of the rated supply voltage at a temperature of 20 °C. For battery operated equipment, the equipment tests shall be performed using a new battery.

Limit (MHz)	Temperature (°C)	Frequency (MHz)	Result
13.558644 < f < 13.561356	-20	13.559529	Complied
	20	13.559487	Complied
	50	13.559484	Complied

Limit (MHz)	Supply voltage (V)	Frequency (MHz)	Result
13.558644 < f < 13.561356	10.2V	13.559487	Complied
	12V	13.559487	Complied
	13.8V	13.559493	Complied



Accredited for compliance with ISO/IEC 17025. The results of the test, calibrations and/or measurement included in this document are traceable to Australian/national standards. NATA is a signatory to the ILAC Mutual Recognition Arrangement for the mutual recognition of the equivalence of testing, calibration and inspection reports.

This document shall not be reproduced except in full.

4.0 COMPLIANCE STATEMENT

The T10 Mifare Reader, Model C305400, tested on behalf of Gallagher Group Ltd. **complied** with the requirements of 47 CFR, Part 15 Subpart C - Rules for Radio Frequency Devices (intentional radiators), Section 15.225 - Operation within the band 13.110-14.010 MHz.

Results were as follows:

FCC Part 15 Subpart C	Test Performed	Results
15.203	Antenna Requirement	Complied
15.207	Conducted Limits	Complied
15.209	Radiated Emissions Limits; General Requirements	Complied
15.225(a)	Fundamental Field Strength	Complied
15.225(b and c)	Transmission Mask 13.110-14.010 MHz	Complied
15.225(d)	Spurious Emissions	Complied
15.225(e)	Frequency Tolerance	Complied

5.0 MEASUREMENT UNCERTAINTY

EMC Technologies has evaluated the equipment and the methods used to perform the emissions testing. The estimated measurement uncertainties for emissions tests shown within this report are as follows:

Conducted Emissions:	9 kHz to 30 MHz	±3.2 dB
Radiated Emissions:	9 kHz to 30 MHz	±4.1 dB
	30 MHz to 300 MHz	±5.1 dB
	300 MHz to 1000 MHz	±4.7 dB
	1 GHz to 18 GHz	±4.6 dB
Peak Output Power:		±1.5 dB

The above expanded uncertainties are based on standard uncertainties multiplied by a coverage factor of k=2, providing a level of confidence of approximately 95%.



Accredited for compliance with ISO/IEC 17025. The results of the test, calibrations and/or measurement included in this document are traceable to Australian/national standards. NATA is a signatory to the ILAC Mutual Recognition Arrangement for the mutual recognition of the equivalence of testing, calibration and inspection reports.

This document shall not be reproduced except in full.