



# SPORTON International Inc.

No. 52, Hwa Ya 1st Rd., Kwei-Shan Hsiang, TaoYuan Hsien, Taiwan, R.O.C.  
Ph: 886-3-327-3456 / FAX: 886-3-327-0973 / www.sporton.com.tw

## FCC RADIO TEST REPORT

Applicant's company	Z-Com, Inc.
Applicant Address	7F-2, No. 9. Prosperity RD.I Science-Based Industrial, Park Hsinchu, 300 Taiwan
FCC ID	M4Y-ZCN1523H516V2
Manufacturer's company	Z-Com, Inc.
Manufacturer Address	7F-2, No. 9. Prosperity RD.I Science-Based Industrial, Park Hsinchu, 300 Taiwan

Product Name	IEEE 802.11a/n WIRELESS OUTDOOR CPE
Brand Name	Z-COM
Model Name	ZCN-1523H-5-16
Test Rule Part(s)	47 CFR FCC Part 15 Subpart C § 15.247
Test Freq. Range	5725 ~ 5850MHz
Received Date	Jul. 19, 2010
Final Test Date	Aug. 04, 2010
Submission Type	Original Equipment



### Statement

**Test result included is only for the IEEE 802.11n and IEEE 802.11a (5725 ~ 5850MHz) of the product.**

The test result in this report refers exclusively to the presented test model / sample.

Without written approval of SPORTON International Inc., the test report shall not be reproduced except in full.

The measurements and test results shown in this test report were made in accordance with the procedures and found in compliance with the limit given in **ANSI C63.4-2003** and **47 CFR FCC Part 15 Subpart C**.

The test equipment used to perform the test is calibrated and traceable to NML/ROC.



Testing Laboratory  
1190

## Table of Contents

<b>1. CERTIFICATE OF COMPLIANCE .....</b>	<b>1</b>
<b>2. SUMMARY OF THE TEST RESULT .....</b>	<b>2</b>
<b>3. GENERAL INFORMATION .....</b>	<b>3</b>
3.1. Product Details.....	3
3.2. Accessories.....	5
3.3. Table for Filed Antenna.....	5
3.4. Table for Carrier Frequencies .....	6
3.5. Table for Test Modes .....	7
3.6. Table for Testing Locations.....	7
3.7. Table for Supporting Units .....	8
3.8. Table for Parameters of Test Software Setting .....	8
3.9. Test Configurations .....	9
<b>4. TEST RESULT .....</b>	<b>12</b>
4.1. AC Power Line Conducted Emissions Measurement.....	12
4.2. Maximum Conducted Output Power Measurement.....	16
4.3. Power Spectral Density Measurement .....	23
4.4. 6dB Spectrum Bandwidth Measurement .....	28
4.5. Radiated Emissions Measurement .....	33
4.6. Band Edge Emissions Measurement .....	47
4.7. Antenna Requirements .....	51
<b>5. LIST OF MEASURING EQUIPMENTS .....</b>	<b>52</b>
<b>TEST LOCATION .....</b>	<b>53</b>
<b>6. TAF CERTIFICATE OF ACCREDITATION .....</b>	<b>54</b>
<b>APPENDIX A. PHOTOGRAPHS OF EUT.....</b>	<b>A1 ~ A16</b>
<b>APPENDIX B. TEST PHOTOS.....</b>	<b>B1 ~ B5</b>
<b>APPENDIX C. MAXIMUM PERMISSIBLE EXPOSURE.....</b>	<b>C1 ~C3</b>





## 1. CERTIFICATE OF COMPLIANCE

Product Name : IEEE 802.11a/n WIRELESS OUTDOOR CPE  
Brand Name : Z-COM  
Model Name : ZCN-1523H-5-16  
Applicant : Z-Com, Inc.  
Test Rule Part(s) : 47 CFR FCC Part 15 Subpart C § 15.247

Sporton International as requested by the applicant to evaluate the EMC performance of the product sample received on Jul. 19, 2010 would like to declare that the tested sample has been evaluated and found to be in compliance with the tested rule parts. The data recorded as well as the test configuration specified is true and accurate for showing the sample's EMC nature.

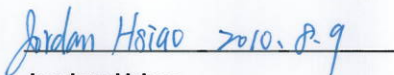

Jordan Hsiao

SPORTON INTERNATIONAL INC.

## 2. SUMMARY OF THE TEST RESULT

Applied Standard: 47 CFR FCC Part 15 Subpart C				
Part	Rule Section	Description of Test	Result	Under Limit
4.1	15.207	AC Power Line Conducted Emissions	Complies	6.09 dB
4.2	15.247(b)(3)	Maximum Conducted Output Power	Complies	4.46 dB
4.3	15.247(e)	Power Spectral Density	Complies	5.71 dB
4.4	15.247(a)(2)	6dB Spectrum Bandwidth	Complies	-
4.5	15.247(d)	Radiated Emissions	Complies	3.10 dB
4.6	15.247(d)	Band Edge Emissions	Complies	-
4.7	15.203	Antenna Requirements	Complies	-

Test Items	Uncertainty	Remark
AC Power Line Conducted Emissions	±2.3dB	Confidence levels of 95%
Maximum Conducted Output Power	±0.8dB	Confidence levels of 95%
Power Spectral Density	±0.5dB	Confidence levels of 95%
6dB Spectrum Bandwidth	±8.5×10 <sup>-8</sup>	Confidence levels of 95%
Radiated Emissions (9kHz~30MHz)	±0.8dB	Confidence levels of 95%
Radiated Emissions (30MHz~1000MHz)	±1.9dB	Confidence levels of 95%
Radiated / Band Edge Emissions (1GHz~18GHz)	±1.9dB	Confidence levels of 95%
Radiated Emissions (18GHz~40GHz)	±1.9dB	Confidence levels of 95%
Temperature	±0.7°C	Confidence levels of 95%
Humidity	±3.2%	Confidence levels of 95%
DC / AC Power Source	±1.4%	Confidence levels of 95%

### 3. GENERAL INFORMATION

#### 3.1. Product Details

##### IEEE 802.11n

Items	Description
Product Type	WLAN (2TX, 2RX)
Radio Type	Intentional Transceiver
Power Type	From adapter and POE
Modulation	see the below table for IEEE 802.11n
Data Modulation	OFDM (BPSK / QPSK / 16QAM / 64QAM)
Data Rate (Mbps)	see the below table for IEEE 802.11n
Frequency Range	5725 ~ 5850MHz
Channel Number	5 for 20MHz bandwidth ; 2 for 40MHz bandwidth
Channel Band Width (99%)	MCS8 (20MHz): 17.84 MHz ; MCS8 (40MHz): 36.40 MHz
Conducted Output Power	MCS8 (20MHz): 25.54 dBm ; MCS8 (40MHz): 25.12 dBm
Carrier Frequencies	Please refer to section 3.4
Antenna	Please refer to section 3.3

##### IEEE 802.11a

Items	Description
Product Type	WLAN (2TX, 2RX)
Radio Type	Intentional Transceiver
Power Type	From adapter and POE
Modulation	OFDM for IEEE 802.11a
Data Modulation	OFDM (BPSK / QPSK / 16QAM / 64QAM)
Data Rate (Mbps)	OFDM (6/9/12/18/24/36/48/54)
Frequency Range	5725 ~ 5850MHz
Channel Number	5
Channel Band Width (99%)	17.56 MHz
Conducted Output Power	25.42 dBm
Carrier Frequencies	Please refer to section 3.4
Antenna	Please refer to section 3.3

**Note:**

Point-to-point function is provided for this EUT.

**Antenna & Band width**

Antenna	Single (TX)		Two (TX)	
	20 MHz	40 MHz	20 MHz	40 MHz
IEEE 802.11a	X	X	V	X
IEEE 802.11n	X	X	V	V

**IEEE 802.11n spec**

MCS Index	Nss	Modulation	R	NBPS	NCBPS		NDBPS		Datarate(Mbps)			
					20MHz	40MHz	20MHz	40MHz	800nsGI		400nsGI	
									20MHz	40MHz	20MHz	40MHz
0	1	BPSK	1/2	1	52	108	26	54	6.5	13.5	7.200	15
1	1	QPSK	1/2	2	104	216	52	108	13.0	27.0	14.400	30
2	1	QPSK	3/4	2	104	216	78	162	19.5	40.5	21.700	45
3	1	16-QAM	1/2	4	208	432	104	216	26.0	54.0	28.900	60
4	1	16-QAM	3/4	4	208	432	156	324	39.0	81.0	43.300	90
5	1	64-QAM	2/3	6	312	648	208	432	52.0	108.0	57.800	120
6	1	64-QAM	3/4	6	312	648	234	486	58.5	121.5	65.000	135
7	1	64-QAM	5/6	6	312	648	260	540	65.0	135.0	72.200	150
8	2	BPSK	1/2	1	104	216	52	108	13.0	27.0	14.444	30
9	2	QPSK	1/2	2	208	432	104	216	26.0	54.0	28.889	60
10	2	QPSK	3/4	2	208	432	156	324	39.0	81.0	43.333	90
11	2	16-QAM	1/2	4	416	864	208	432	52.0	108.0	57.778	120
12	2	16-QAM	3/4	4	416	864	312	648	78.0	162.0	86.667	180
13	2	64-QAM	2/3	6	624	1296	416	864	104.0	216.0	115.556	240
14	2	64-QAM	3/4	6	624	1296	468	972	117.0	243.0	130.000	270
15	2	64-QAM	5/6	6	624	1296	520	1080	130.0	270.0	144.444	300

Symbol	Explanation
NSS	Number of spatial streams
R	Code rate
NBPS	Number of coded bits per single carrier
NCBPS	Number of coded bits per symbol
NDBPS	Number of data bits per symbol
GI	guard interval

### 3.2. Accessories

Power	Brand	Model	Rating
Adapter 1	TOUCH ELECTRONIC CO., LTD.	SA06-30S12R-V	Input: 100-240VAC, 1.0A, 50-60Hz Output: 15VDC, 2.0A
Adapter 2	OEM	ADS10-W 150080	Input: 100-240VAC, 0.5A, 50-60Hz Output: 15VDC, 800mA
POE	JYH ENG TECHNOLOGY CO., LTD.	AMEBA0000000201	Voltage Input: 5V~57VDC Current Output: 1300mA
Others			
There is a RJ-45 Cable with a core in the middle. The core brand is King core (K5B RC 13*23*7).			

### 3.3. Table for Filed Antenna

Ant.	Brand	Model Name	Antenna Type	Connector	Gain (dBi)	Remark
A	ZCOM	ZCN-1523H-5-16	Patch Antenna	NA	15.00	TX/RX
B	ZCOM	ZCN-1523H-5-16	Patch Antenna	NA	15.00	TX/RX

Note: The EUT has two Antennas.

Both antenna A and B can be used as transmitting/receiving antenna.

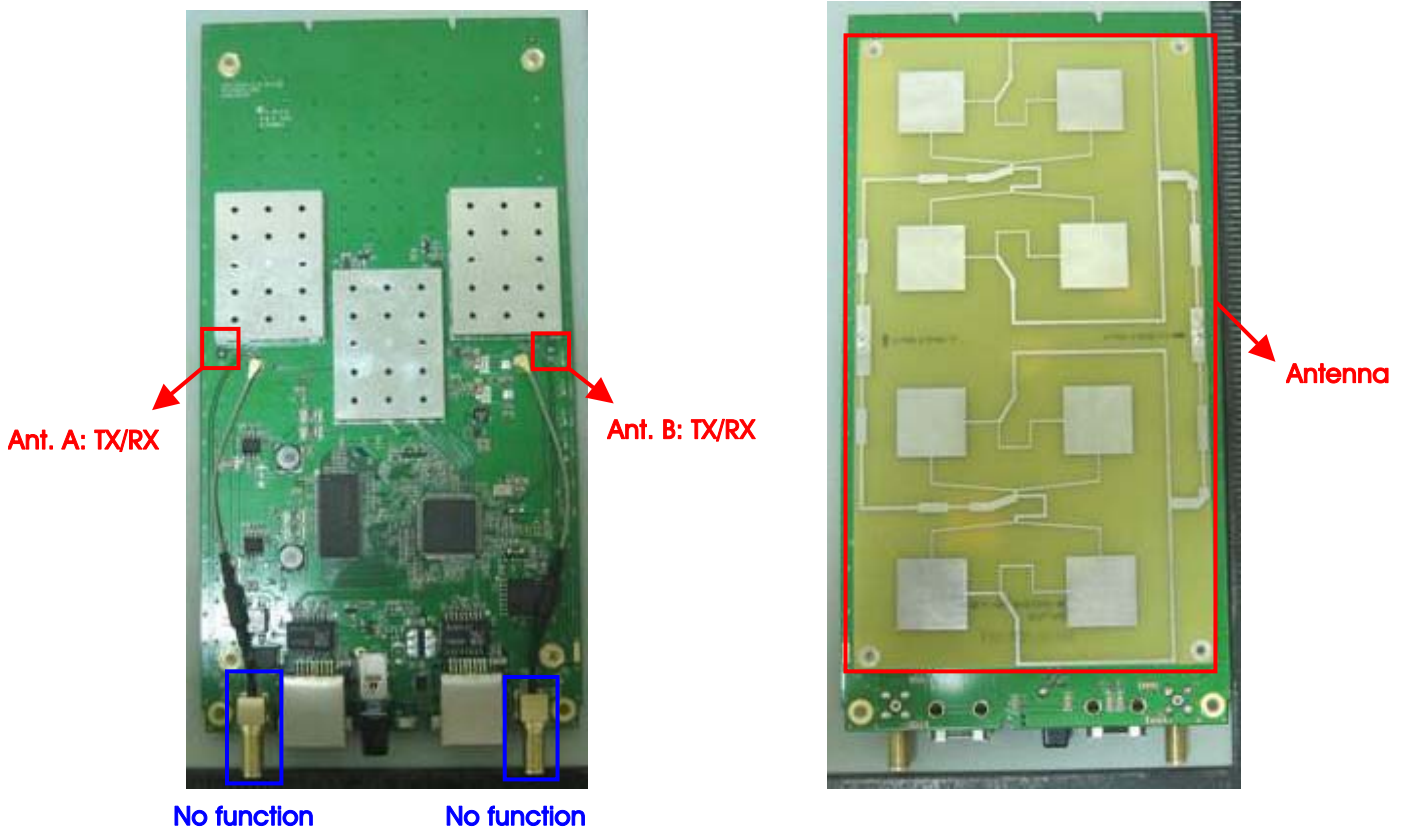



### 3.4. Table for Carrier Frequencies

For IEEE 802.11a, use Channel 149, 153, 157, 161, 165.

There are two bandwidth systems for IEEE 802.11n.

For 20MHz bandwidth systems, use Channel 149, 153, 157, 161, 165.

For 40MHz bandwidth systems, use Channel 151, 159.

Frequency Band	Channel No.	Frequency	Channel No.	Frequency
5725~5850 MHz	149	5745 MHz	159	5795 MHz
	151	5755 MHz	161	5805 MHz
	153	5765 MHz	165	5825 MHz
	157	5785 MHz	-	-

### 3.5. Table for Test Modes

Preliminary tests were performed in different data rate to find the worst radiated emission. The data rate shown in the table below is the worst-case rate with respect to the specific test item. Investigation has been done on all the possible configurations for searching the worst cases. The following table is a list of the test modes shown in this test report.

Test Items	Mode	Data Rate	Channel	Antenna
AC Power Line Conducted Emissions	Normal Link	Auto	-	-
Max. Peak Conducted Output Power	MCS8/20MHz	13 Mbps	149/157/165	A/B/A+B
	MCS8/40MHz	27 Mbps	151/159	
	11a/BPSK	6 Mbps	149/157/165	
Power Spectral Density 6dB Spectrum Bandwidth	MCS8/20MHz	13 Mbps	149/157/165	A+B
	MCS8/40MHz	27 Mbps	151/159	
	11a/BPSK	6 Mbps	149/157/165	
Radiated Emissions Below 1GHz	Normal Link	Auto	-	-
Radiated Emissions Above 1GHz	MCS8/20MHz	13 Mbps	149/157/165	A+B
	MCS8/40MHz	27 Mbps	151/159	
	11a/BPSK	6 Mbps	149/157/165	
Band Edge Emissions	MCS8/20MHz	13 Mbps	149/157/165	A+B
	MCS8/40MHz	27 Mbps	151/159	
	11a/BPSK	6 Mbps	149/157/165	

The following test modes were performed for all tests:

Test Mode 1. EUT + Adapter 1

Test Mode 2. EUT + Adapter 2

**For Conducted Emissions Test:**

Due to Mode 1 generated the worst test result, so it was recorded in this report.

**For Radiated Emissions Test Above 1GHz:**

Due to Mode 2 generated the worst test result, so it was recorded in this report.

### 3.6. Table for Testing Locations

Test Site No.	Site Category	Location	FCC Reg. No.	IC File No.	VCCI Reg. No
03CH03-HY	SAC	Hwa Ya	879474	IC 4086	-
CO04-HY	Conduction	Hwa Ya	879474	IC 4086	-
TH01-HY	OVEN Room	Hwa Ya	-	-	-

Open Area Test Site (OATS); Semi Anechoic Chamber (SAC); Fully Anechoic Chamber (FAC).

Please refer section 6 for Test Site Address.

### 3.7. Table for Supporting Units

Support Unit	Brand	Model	FCC ID
Notebook	DELL	D400	E2K24GBRL
Mouse	iCooky	AMS0706W	DoC
Modem	ACEEX	DM1414	IFAXDM1414
Notebook	DELL	D400	E2K24GBRL

### 3.8. Table for Parameters of Test Software Setting

During testing, Channel & Power Controlling Software provided by the customer was used to control the operating channel as well as the output power level. The RF output power selection is for the setting of RF output power expected by the customer and is going to be fixed on the firmware of the final end product.

#### Power Parameters of IEEE 802.11n

Test Software Version	ART (Revisiom 0.9 BUILD #21 ART_11n)		
Frequency	5745 MHz	5785 MHz	5825 MHz
MCS8 20MHz	26	26	26
Frequency	5755 MHz	5795 MHz	-
MCS8 40MHz	22.5	25	-

#### Power Parameters of IEEE 802.11a

Test Software Version	ART (Revisiom 0.9 BUILD #21 ART_11n)		
Frequency	5745 MHz	5785 MHz	5825 MHz
IEEE 802.11a	26	26	26

An executive program, EMCTEST.EXE under WIN XP, which generates a complete line of continuously repeating “ H ” pattern was used as the test software.

The program was executed as follows:

- a. Turn on the power of all equipment.
- b. The NB sends “ H ” messages to the panel, and the panel displays “ H ” patterns on the screen.
- c. The NB sends “ H ” messages to the printer, then the printer prints them on the paper.
- d. The NB sends “ H ” messages to the modem.
- e. Repeat the steps from b to d.

At the same time, “ART (Revisiom 0.9 BUILD #21 ART\_11n)” was executed to control the EUT continuously transmit RF signal.

### 3.9. Test Configurations

#### 3.9.1. Radiation Emissions Test Configuration

Test Configuration: 9kHz~1GHz

Test Mode: Mode 2

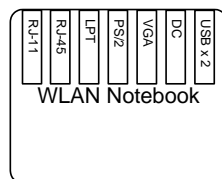
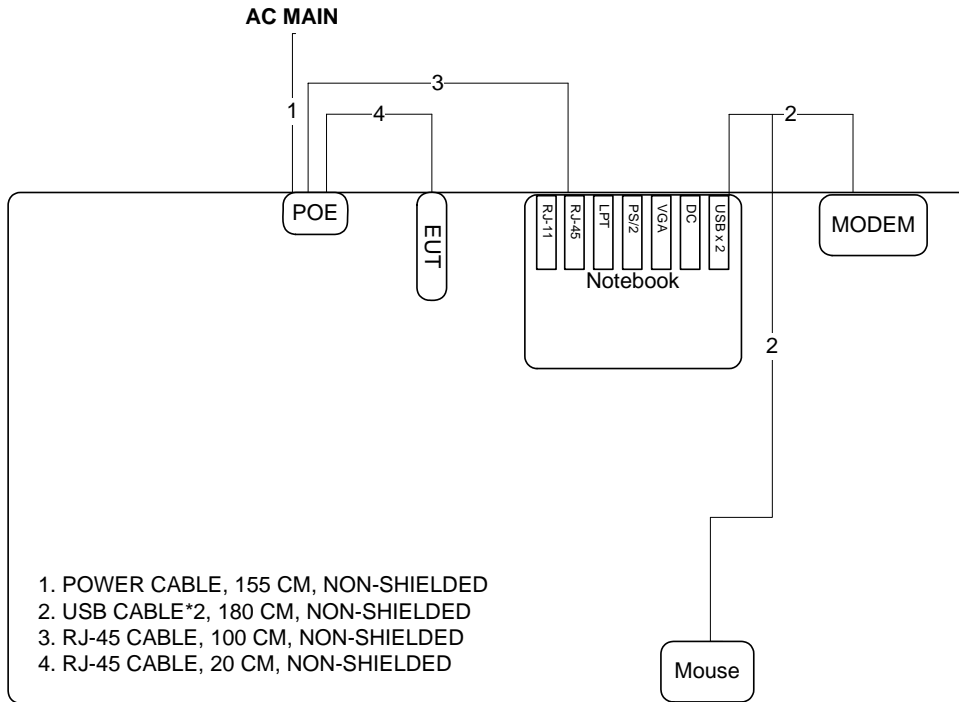

Test Configuration: above 1GHz

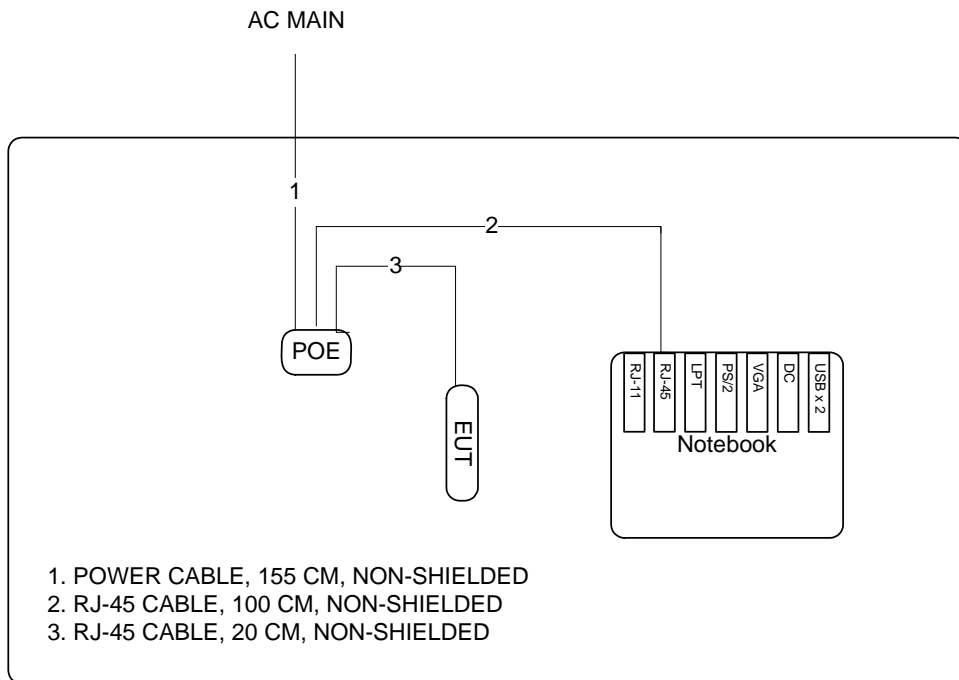

### 3.9.2. AC Power Line Conduction Emissions Test Configuration

Test Mode: Mode 1

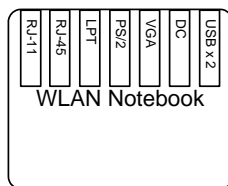
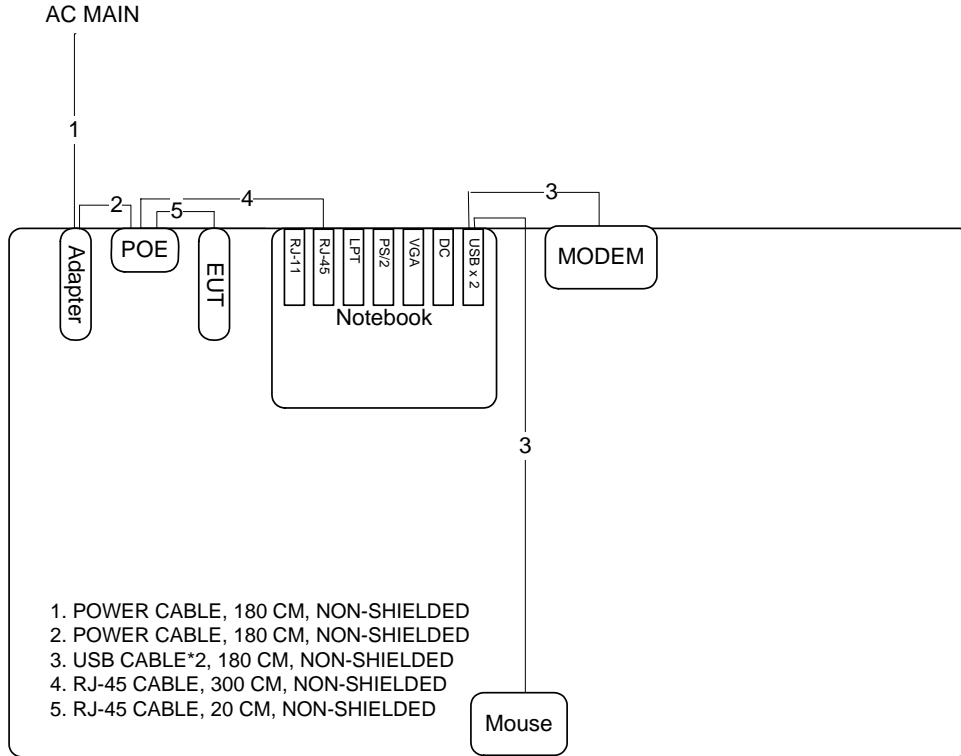

## 4. TEST RESULT

### 4.1. AC Power Line Conducted Emissions Measurement

#### 4.1.1. Limit

For this product which is designed to be connected to the AC power line, the radio frequency voltage that is conducted back onto the AC power line on any frequency or frequencies within the band 150 kHz to 30 MHz shall not exceed below limits table.

Frequency (MHz)	QP Limit (dBuV)	AV Limit (dBuV)
0.15~0.5	66~56	56~46
0.5~5	56	46
5~30	60	50

#### 4.1.2. Measuring Instruments and Setting

Please refer to section 5 of equipments list in this report. The following table is the setting of the receiver.

Receiver Parameters	Setting
Attenuation	10 dB
Start Frequency	0.15 MHz
Stop Frequency	30 MHz
IF Bandwidth	9 KHz

#### 4.1.3. Test Procedures

1. Configure the EUT according to ANSI C63.4. The EUT or host of EUT has to be placed 0.4 meter far from the conducting wall of the shielding room and at least 80 centimeters from any other grounded conducting surface.
2. Connect EUT or host of EUT to the power mains through a line impedance stabilization network (LISN).
3. All the support units are connected to the other LISNs. The LISN should provide 50uH/50ohms coupling impedance.
4. The frequency range from 150 KHz to 30 MHz was searched.
5. Set the test-receiver system to Peak Detect Function and Specified Bandwidth with Maximum Hold Mode.
6. The measurement has to be done between each power line and ground at the power terminal.

#### 4.1.4. Test Setup Layout

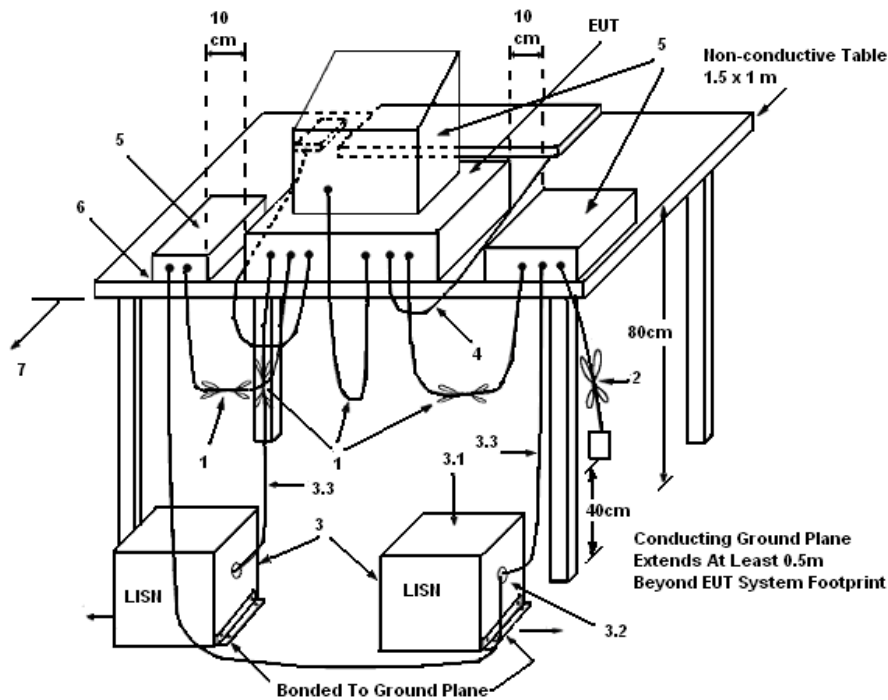

#### LEGEND:

- (1) Interconnecting cables that hang closer than 40 cm to the ground plane shall be folded back and forth in the center forming a bundle 30 to 40 cm long.
- (2) I/O cables that are not connected to a peripheral shall be bundled in the center. The end of the cable may be terminated, if required, using the correct terminating impedance. The overall length shall not exceed 1 m.
- (3) EUT connected to one LISN. Unused LISN measuring port connectors shall be terminated in  $50\ \Omega$ . LISN can be placed on top of, or immediately beneath, reference ground plane.
  - (3.1) All other equipment powered from additional LISN(s).
  - (3.2) Multiple outlet strip can be used for multiple power cords of non-EUT equipment.
  - (3.3) LISN at least 80 cm from nearest part of EUT chassis.
- (4) Cables of hand-operated devices, such as keyboards, mice, etc., shall be placed as for normal use.
- (5) Non-EUT components of EUT system being tested.
- (6) Rear of EUT, including peripherals, shall all be aligned and flush with rear of tabletop.
- (7) Rear of tabletop shall be 40 cm removed from a vertical conducting plane that is bonded to the ground plane.

#### 4.1.5. Test Deviation

There is no deviation with the original standard.

#### 4.1.6. EUT Operation during Test

The EUT was placed on the test table and programmed in normal function.



4.1.7. Results of AC Power Line Conducted Emissions Measurement

Temperature	22.6°C	Humidity	49.5%
Test Engineer	Beck Wu	Phase	Line
Configuration	Normal Link / Mode 1		

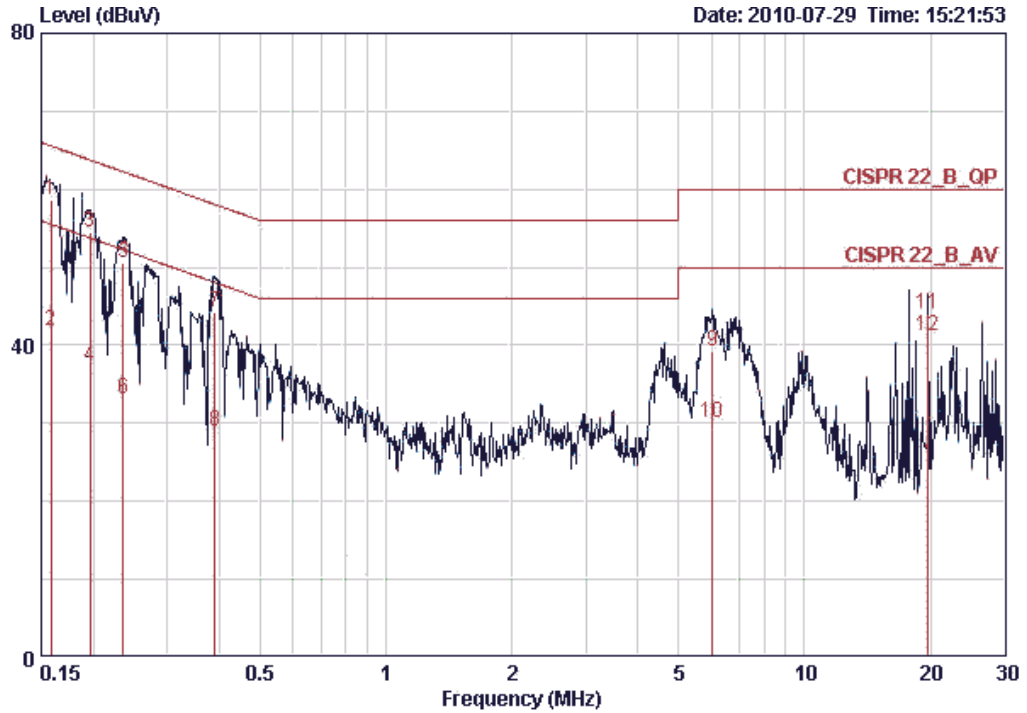

	Freq	Level	Over Limit	Limit Line	Read Level	LISN Factor	Cable Loss	Remark
	MHz	dBuV	dB	dBuV	dBuV	dB	dB	
1	0.15816	58.55	-7.01	65.56	58.28	0.07	0.20	QP
2	0.15816	41.83	-13.73	55.56	41.56	0.07	0.20	AVERAGE
3	0.19654	54.40	-9.35	63.76	54.15	0.05	0.20	QP
4	0.19654	37.34	-16.41	53.76	37.09	0.05	0.20	AVERAGE
5	0.23533	50.52	-11.74	62.26	50.27	0.05	0.20	QP
6	0.23533	33.20	-19.06	52.26	32.95	0.05	0.20	AVERAGE
7	0.38929	44.27	-13.81	58.08	44.04	0.03	0.20	QP
8	0.38929	28.97	-19.11	48.08	28.74	0.03	0.20	AVERAGE
9	6.024	39.23	-20.77	60.00	38.71	0.21	0.31	QP
10	6.024	30.10	-19.90	50.00	29.58	0.21	0.31	AVERAGE
11	19.708	43.93	-16.07	60.00	42.62	0.81	0.50	QP
12	19.708	41.17	-8.83	50.00	39.86	0.81	0.50	AVERAGE

Temperature	22.6°C	Humidity	49.5%
Test Engineer	Beck Wu	Phase	Neutral
Configuration	Normal Link / Mode 1		

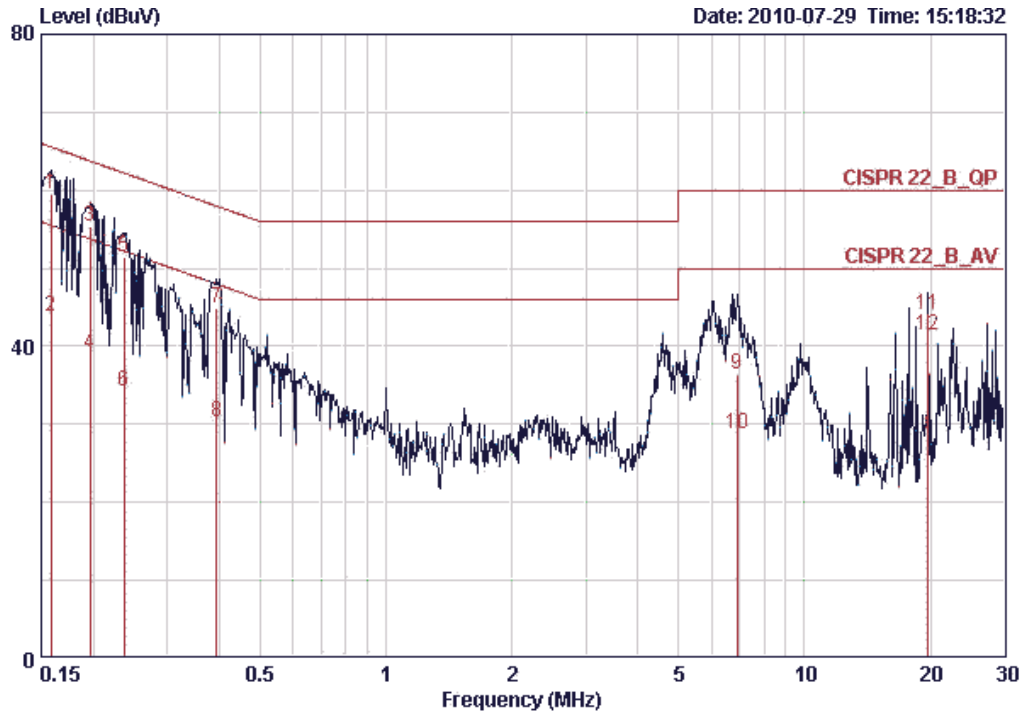

	Freq	Level	Over Limit	Limit Line	Read Level	LISN Factor	Cable Loss	Remark
	MHz	dBuV	dB	dBuV	dBuV	dB	dB	
1	0.15816	59.47	-6.09	65.56	59.17	0.10	0.20	QP
2	0.15816	43.78	-11.78	55.56	43.48	0.10	0.20	AVERAGE
3	0.19654	55.45	-8.30	63.76	55.17	0.08	0.20	QP
4	0.19654	38.93	-14.82	53.76	38.65	0.08	0.20	AVERAGE
5	0.23658	51.53	-10.69	62.22	51.25	0.08	0.20	QP
6	0.23658	34.16	-18.06	52.22	33.88	0.08	0.20	AVERAGE
7	0.39344	44.83	-13.16	57.99	44.56	0.07	0.20	QP
8	0.39344	30.20	-17.79	47.99	29.93	0.07	0.20	AVERAGE
9	6.914	36.29	-23.71	60.00	35.69	0.29	0.31	QP
10	6.914	28.87	-21.13	50.00	28.27	0.29	0.31	AVERAGE
11	19.708	43.95	-16.05	60.00	42.66	0.79	0.50	QP
12	19.708	41.31	-8.69	50.00	40.02	0.79	0.50	AVERAGE

Note:

Level = Read Level + LISN Factor + Cable Loss

## 4.2. Maximum Conducted Output Power Measurement

### 4.2.1. Limit

For systems using digital modulation in the 2400-2483.5MHz, the limit for peak output power is 30dBm. The limited has to be reduced by the amount in dB that the gain of the antenna exceed 6dBi. In case of point-to-point operation, the limit has to be reduced by 1dB for every 3dB that the directional gain of the antenna exceeds 6dBi. Systems operating in the 5725-5850 MHz band that are used exclusively for fixed, point-to-point operations may employ transmitting antennas with directional gain greater than 6 dBi without any corresponding reduction in transmitter conducted output power.

### 4.2.2. Measuring Instruments and Setting

Please refer to section 5 of equipments list in this report. The following table is the setting of the spectrum analyzer.

Spectrum Parameter	Setting
Attenuation	Auto
Span Frequency	Encompass the entire emissions bandwidth (EBW) of the signal
RB	1MHz
VB	3MHz
Detector	RMS
Trace	Max Hold
Sweep Time	Auto

### 4.2.3. Test Procedures

1. The transmitter output (antenna port) was connected to the spectrum analyzer.
2. Test was performed in accordance with Measurement of Digital Transmission Systems Operating under Section 15.247 March 23, 2005.
3. When measuring maximum conducted output power with multiple antenna systems, add every result of the values by mathematic formula.

### 4.2.4. Test Setup Layout

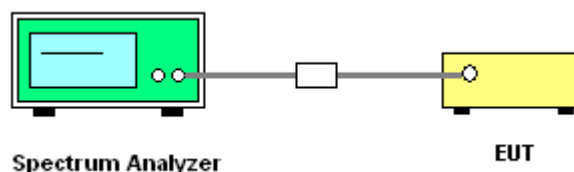

### 4.2.5. Test Deviation

There is no deviation with the original standard.

#### 4.2.6. EUT Operation during Test

The EUT was programmed to be in continuously transmitting mode.

#### 4.2.7. Test Result of Maximum Conducted Output Power

Temperature	23°C	Humidity	62%
Test Engineer	Alan Huang	Configurations	IEEE 802.11n

##### Configuration IEEE 802.11n MCS8 20MHz Ant. A

Channel	Frequency	Conducted Power (dBm)	Max. Limit (dBm)	Result
149	5745 MHz	22.81	30.00	Complies
157	5785 MHz	22.53	30.00	Complies
165	5825 MHz	22.50	30.00	Complies

##### Configuration IEEE 802.11n MCS8 20MHz Ant. B

Channel	Frequency	Conducted Power (dBm)	Max. Limit (dBm)	Result
149	5745 MHz	22.23	30.00	Complies
157	5785 MHz	22.23	30.00	Complies
165	5825 MHz	22.16	30.00	Complies

##### Configuration IEEE 802.11n MCS8 20MHz Ant. A + Ant. B

Channel	Frequency	Conducted Power (dBm)	Max. Limit (dBm)	Result
149	5745 MHz	25.54	30.00	Complies
157	5785 MHz	25.39	30.00	Complies
165	5825 MHz	25.34	30.00	Complies

**Configuration IEEE 802.11n MCS8 40MHz Ant. A**

Channel	Frequency	Conducted Power (dBm)	Max. Limit (dBm)	Result
151	5755 MHz	21.12	30.00	Complies
159	5795 MHz	22.19	30.00	Complies

**Configuration IEEE 802.11n MCS8 40MHz Ant. B**

Channel	Frequency	Conducted Power (dBm)	Max. Limit (dBm)	Result
151	5755 MHz	20.14	30.00	Complies
159	5795 MHz	22.03	30.00	Complies

**Configuration IEEE 802.11n MCS8 40MHz Ant. A + Ant. B**

Channel	Frequency	Conducted Power (dBm)	Max. Limit (dBm)	Result
151	5755 MHz	23.67	30.00	Complies
159	5795 MHz	25.12	30.00	Complies

<b>Temperature</b>	23°C	<b>Humidity</b>	62%
<b>Test Engineer</b>	Alan Huang	<b>Configurations</b>	IEEE 802.11a

**Configuration IEEE 802.11a Ant. A**

Channel	Frequency	Conducted Power (dBm)	Max. Limit (dBm)	Result
149	5745 MHz	22.62	30.00	Complies
157	5785 MHz	22.19	30.00	Complies
165	5825 MHz	22.02	30.00	Complies

**Configuration IEEE 802.11a Ant. B**

Channel	Frequency	Conducted Power (dBm)	Max. Limit (dBm)	Result
149	5745 MHz	22.19	30.00	Complies
157	5785 MHz	22.07	30.00	Complies
165	5825 MHz	21.79	30.00	Complies

**Configuration IEEE 802.11a Ant. A + Ant. B**

Channel	Frequency	Conducted Power (dBm)	Max. Limit (dBm)	Result
149	5745 MHz	25.42	30.00	Complies
157	5785 MHz	25.14	30.00	Complies
165	5825 MHz	24.92	30.00	Complies

Note: All the test values were listed in the report.

For plots, only the worse case of OFDM modulation was listed in the report.

**Channel Output Power Plot on Configuration 11a IEEE 802.11n MCS0 20MHz Ant. A / 5745 MHz**

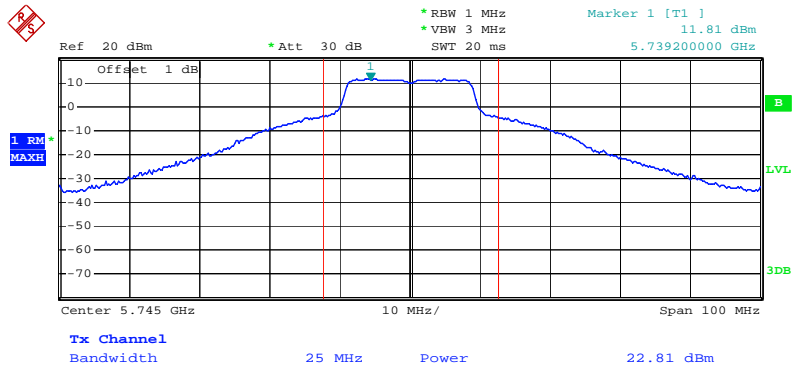

Date: 4.AUG.2010 19:26:03

**Channel Output Power Plot on Configuration 11a IEEE 802.11n MCS0 20MHz Ant. A / 5785MHz**

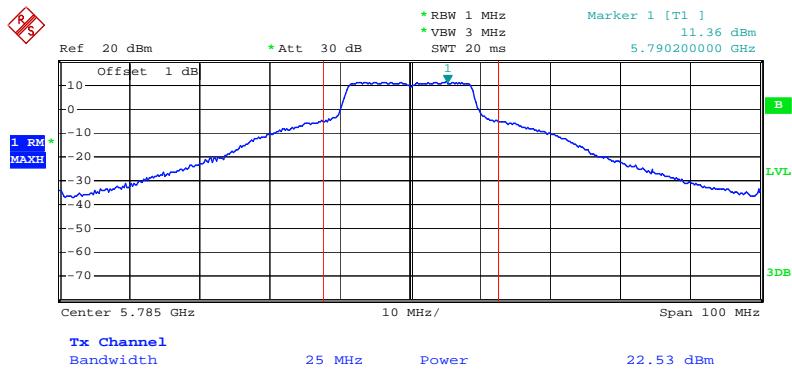

Date: 4.AUG.2010 19:26:39

Channel Output Power Plot on Configuration 11a IEEE 802.11n MCS0 20MHz Ant. A / 5825 MHz

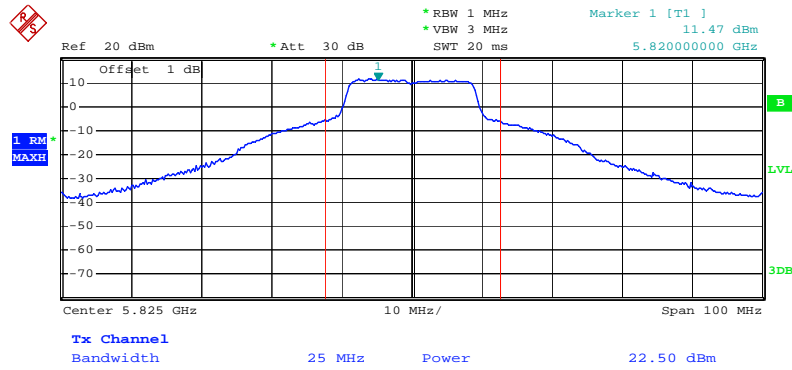

Date: 4.AUG.2010 19:28:53

Channel Output Power Plot on Configuration 11a IEEE 802.11n MCS0 20MHz Ant. B / 5745 MHz

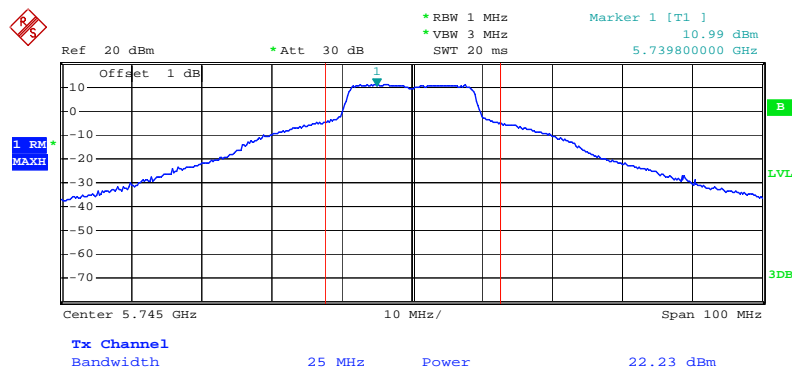

Date: 4.AUG.2010 19:25:14



Channel Output Power Plot on Configuration 11a IEEE 802.11n MCS0 20MHz Ant. B / 5785MHz

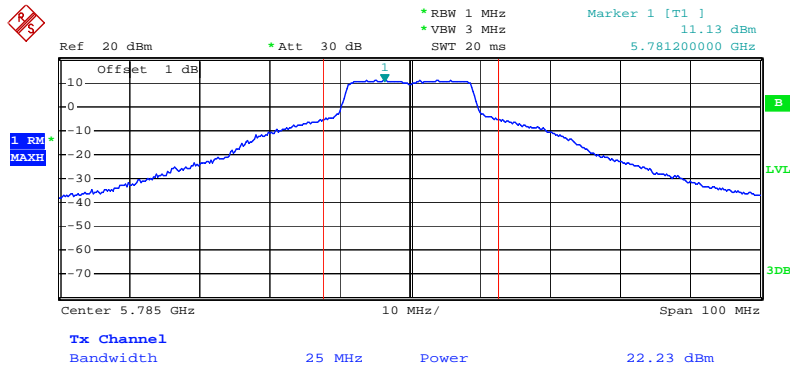

Date: 4.AUG.2010 19:27:21

Channel Output Power Plot on Configuration 11a IEEE 802.11n MCS0 20MHz Ant. B / 5825 MHz

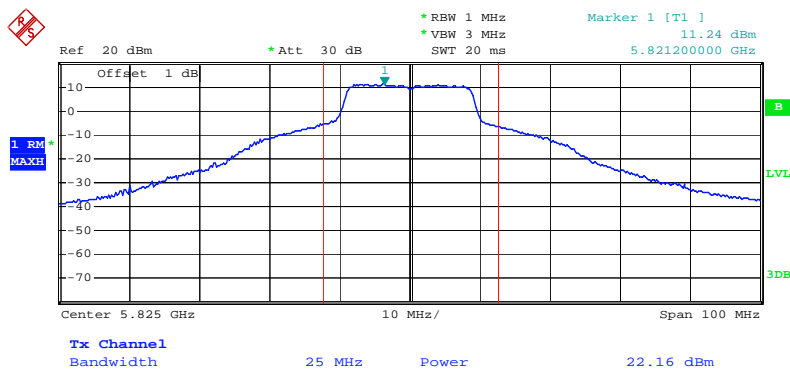

Date: 4.AUG.2010 19:27:57

### 4.3. Power Spectral Density Measurement

#### 4.3.1. Limit

For digitally modulated systems, the power spectral density conducted from the intentional radiator to the antenna shall not be greater than 8dBm in any 3 kHz band during any time interval of continuous transmission.

#### 4.3.2. Measuring Instruments and Setting

Please refer to section 5 of equipments list in this report. The following table is the setting of the spectrum analyzer.

Spectrum Parameter	Setting
Attenuation	Auto
Span Frequency	30 kHz
RB	3 kHz
VB	30 kHz
Detector	Peak
Trace	Max Hold
Sweep Time	10s

#### 4.3.3. Test Procedures

1. The transmitter output (antenna port) was connected to the spectrum analyzer.
2. Set RBW of spectrum analyzer to 3kHz and VBW to 30kHz. Set Detector to Peak, Trace to Max Hold.
3. Mark the frequency with maximum peak power as the center of the display of the spectrum.
4. Set the span to 30kHz and the sweep time to 10s and record the maximum peak value.
5. Measuring multiple antennas, the connector is required to link with spectrum analyzer through a combiner.

#### 4.3.4. Test Setup Layout

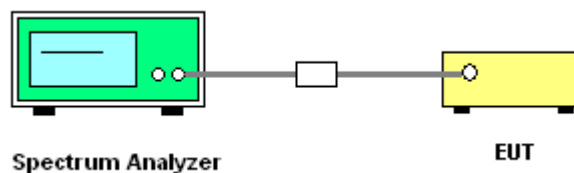

#### 4.3.5. Test Deviation

There is no deviation with the original standard.

#### 4.3.6. EUT Operation during Test

The EUT was programmed to be in continuously transmitting mode.

#### 4.3.7. Test Result of Power Spectral Density

<b>Temperature</b>	23°C	<b>Humidity</b>	62%
<b>Test Engineer</b>	Alan Huang	<b>Configurations</b>	IEEE 802.11n

##### Configuration 11a IEEE 802.11n MCS8 20MHz Ant. A + Ant. B

Channel	Frequency	Power Density (dBm/3kHz)	Max. Limit (dBm/3kHz)	Result
149	5745 MHz	1.06	8.00	Complies
157	5785 MHz	0.61	8.00	Complies
165	5825 MHz	0.42	8.00	Complies

##### Configuration 11a IEEE 802.11n MCS8 40MHz Ant. A + Ant. B

Channel	Frequency	Power Density (dBm/3kHz)	Max. Limit (dBm/3kHz)	Result
151	5755 MHz	-1.56	8.00	Complies
159	5795 MHz	-2.99	8.00	Complies

<b>Temperature</b>	23°C	<b>Humidity</b>	62%
<b>Test Engineer</b>	Alan Huang	<b>Configurations</b>	IEEE 802.11a

**Configuration IEEE 802.11a Ant. A + Ant. B**

<b>Channel</b>	<b>Frequency</b>	<b>Power Density (dBm/3kHz)</b>	<b>Max. Limit (dBm/3kHz)</b>	<b>Result</b>
149	5745 MHz	2.28	8.00	<b>Complies</b>
157	5785 MHz	3.29	8.00	<b>Complies</b>
165	5825 MHz	2.31	8.00	<b>Complies</b>

Note: All the test values were listed in the report.

For plots, only the worse case of OFDM modulation was listed in the report.

**Power Density Plot on Configuration IEEE 802.11a Ant. A + Ant. B / 5745 MHz**

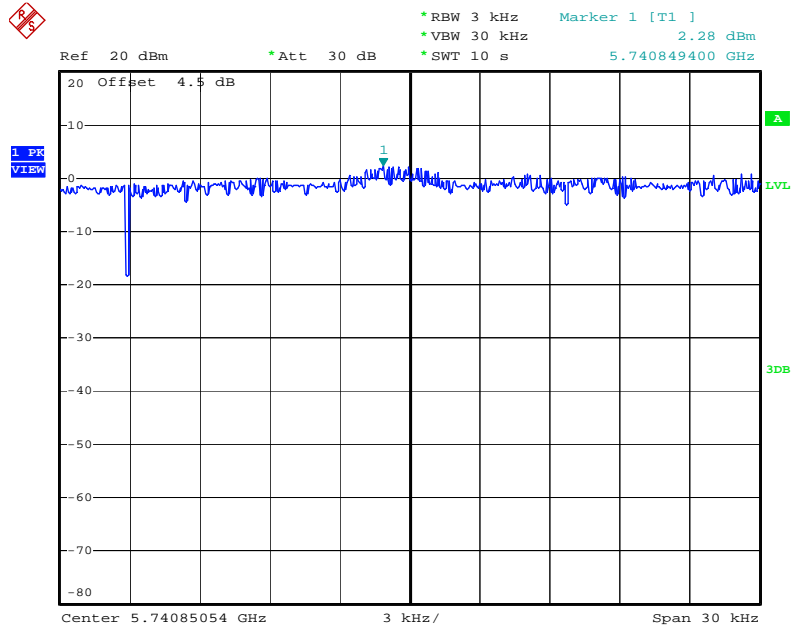

Date: 4.AUG.2010 19:58:24

**Power Density Plot on Configuration IEEE 802.11a Ant. A + Ant. B / 5785 MHz**

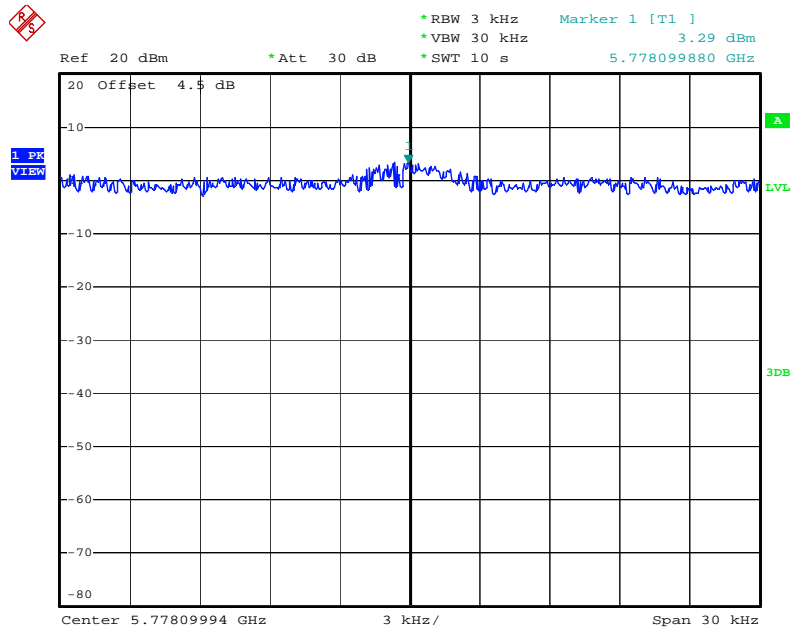

Date: 4.AUG.2010 19:56:08

### Power Density Plot on Configuration IEEE 802.11a Ant. A + Ant. B / 5825 MHz

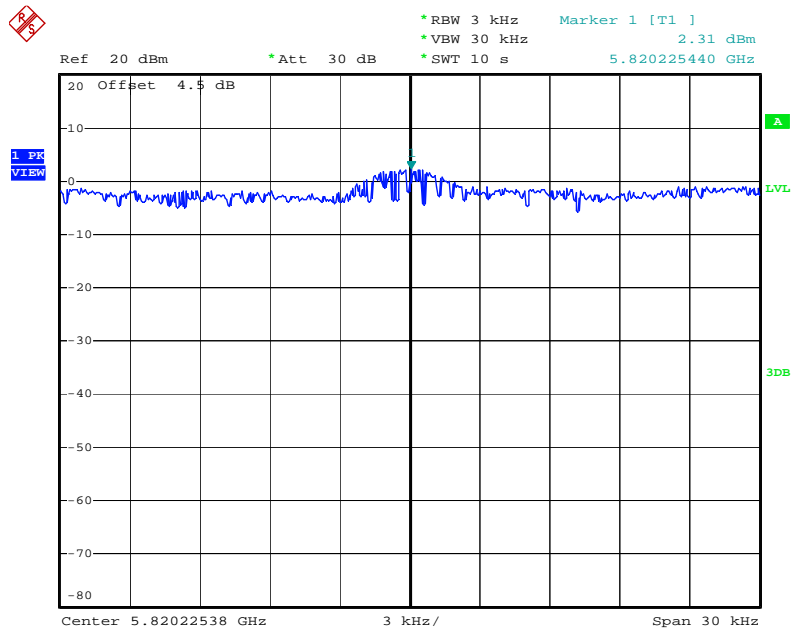

Date: 4.AUG.2010 19:53:58

#### 4.4. 6dB Spectrum Bandwidth Measurement

##### 4.4.1. Limit

For digital modulation systems, the minimum 6dB bandwidth shall be at least 500 kHz.

##### 4.4.2. Measuring Instruments and Setting

Please refer to section 5 of equipments list in this report. The following table is the setting of the spectrum analyzer.

Spectrum Parameters	Setting
Attenuation	Auto
Span Frequency	> 6dB Bandwidth
RB	100 kHz
VB	100 kHz
Detector	Peak
Trace	Max Hold
Sweep Time	Auto

##### 4.4.3. Test Procedures

1. The transmitter output (antenna port) was connected to the spectrum analyzer in peak hold mode.
2. The resolution bandwidth of 100 kHz and the video bandwidth of 100 kHz were used.
3. Measured the spectrum width with power higher than 6dB below carrier.
4. Measuring multiple antennas, the connector is required to link with spectrum analyzer through a combiner.

##### 4.4.4. Test Setup Layout

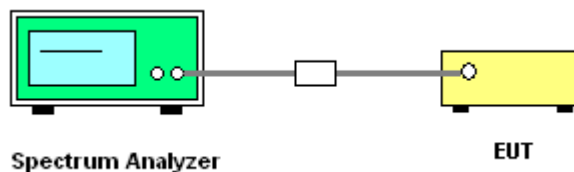

##### 4.4.5. Test Deviation

There is no deviation with the original standard.

##### 4.4.6. EUT Operation during Test

The EUT was programmed to be in continuously transmitting mode.

## 4.4.7. Test Result of 6dB Spectrum Bandwidth

<b>Temperature</b>	23°C	<b>Humidity</b>	62%
<b>Test Engineer</b>	Alan Huang	<b>Configurations</b>	IEEE 802.11n

## Configuration 11a IEEE 802.11n MCS8 20MHz Ant. A+ Ant. B

Channel	Frequency	6dB Bandwidth (MHz)	99% Occupied Bandwidth (MHz)	Min. Limit (kHz)	Test Result
149	5745 MHz	17.08	17.84	500	Complies
157	5785 MHz	16.96	17.80	500	Complies
165	5825 MHz	16.88	17.76	500	Complies

## Configuration 11a IEEE 802.11n MCS8 40MHz Ant. A+ Ant. B

Channel	Frequency	6dB Bandwidth (MHz)	99% Occupied Bandwidth (MHz)	Min. Limit (kHz)	Test Result
151	5755 MHz	36.32	36.32	500	Complies
159	5795 MHz	36.32	36.40	500	Complies



<b>Temperature</b>	23°C	<b>Humidity</b>	62%
<b>Test Engineer</b>	Alan Huang	<b>Configurations</b>	IEEE 802.11a

**Configuration IEEE 802.11a Ant. A + Ant. B**

Channel	Frequency	6dB Bandwidth (MHz)	99% Occupied Bandwidth (MHz)	Min. Limit (kHz)	Test Result
149	5745 MHz	16.36	17.56	500	<b>Complies</b>
157	5785 MHz	16.36	17.32	500	<b>Complies</b>
165	5825 MHz	16.36	17.04	500	<b>Complies</b>

Note: All the test values were listed in the report.

For plots, only the worse case of OFDM modulation was listed in the report.

### 6 dB Bandwidth Plot on Configuration IEEE 802.11a Ant. A+ Ant. B / 5745 MHz

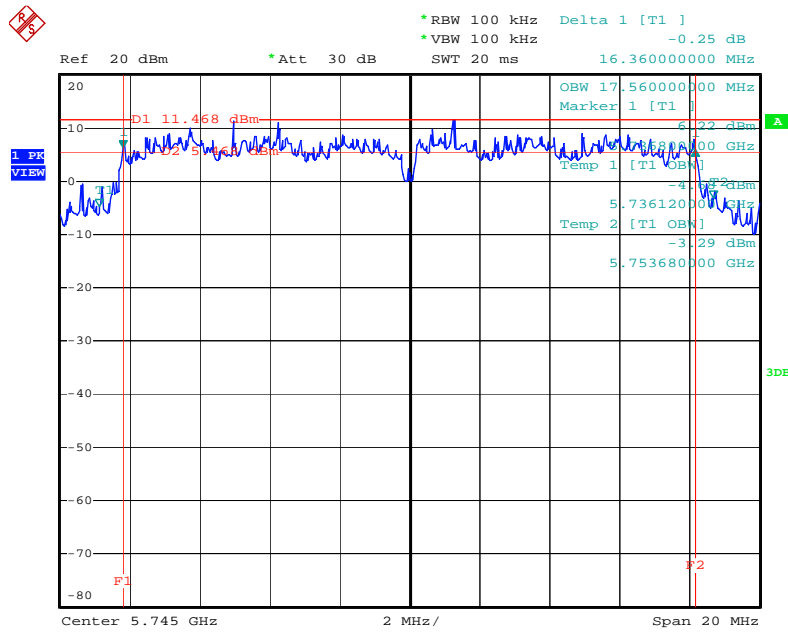

Date: 4.AUG.2010 19:56:55

### 6 dB Bandwidth Plot on Configuration IEEE 802.11a Ant. A+ Ant. B / 5785 MHz

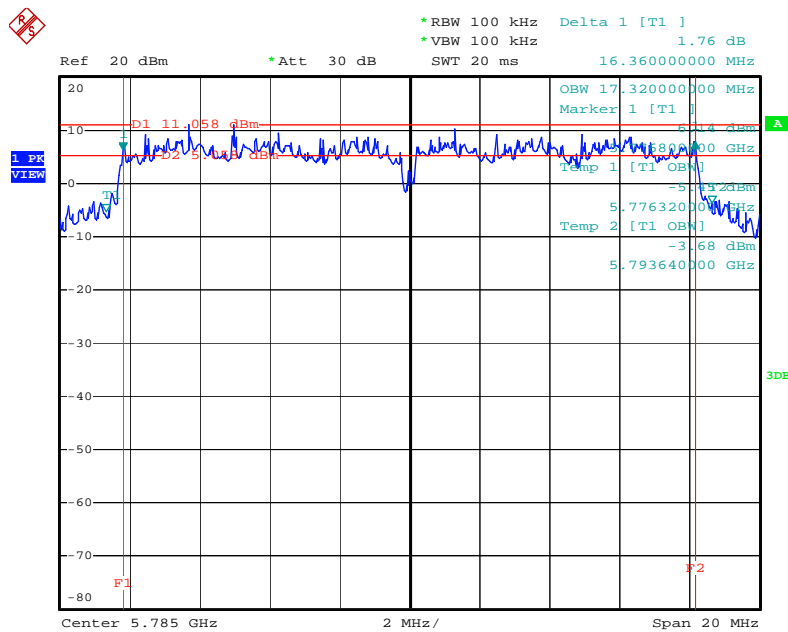

Date: 4.AUG.2010 19:54:39

6 dB Bandwidth Plot on Configuration IEEE 802.11a Ant. A+ Ant. B / 5825 MHz

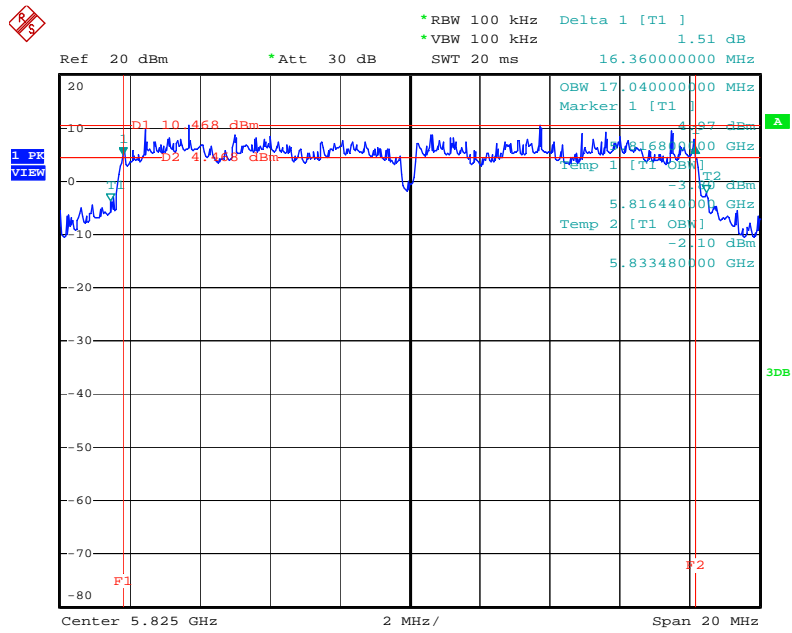

Date: 4.AUG.2010 19:52:28

## 4.5. Radiated Emissions Measurement

### 4.5.1. Limit

20dBc in any 100 kHz bandwidth outside the operating frequency band. In case the emission fall within the restricted band specified on 15.205(a), then the 15.209(a) limit in the table below has to be followed.

Frequencies (MHz)	Field Strength (micровolts/meter)	Measurement Distance (meters)
0.009~0.490	2400/F(KHz)	300
0.490~1.705	24000/F(KHz)	30
1.705~30.0	30	30
30~88	100	3
88~216	150	3
216~960	200	3
Above 960	500	3

### 4.5.2. Measuring Instruments and Setting

Please refer to section 5 of equipments list in this report. The following table is the setting of spectrum analyzer and receiver.

Spectrum Parameter	Setting
Attenuation	Auto
Start Frequency	1000 MHz
Stop Frequency	10th carrier harmonic
RB / VB (Emission in restricted band)	1MHz / 1MHz for Peak, 1 MHz / 10Hz for Average
RB / VB (Emission in non-restricted band)	1MHz / 1MHz for peak

Receiver Parameter	Setting
Attenuation	Auto
Start ~ Stop Frequency	9kHz~150kHz / RB 200Hz for QP
Start ~ Stop Frequency	150kHz~30MHz / RB 9kHz for QP
Start ~ Stop Frequency	30MHz~1000MHz / RB 120kHz for QP

#### 4.5.3. Test Procedures

1. Configure the EUT according to ANSI C63.4. The EUT was placed on the top of the turntable 0.8 meter above ground. The phase center of the receiving antenna mounted on the top of a height-variable antenna tower was placed 3 meters far away from the turntable.
2. Power on the EUT and all the supporting units. The turntable was rotated by 360 degrees to determine the position of the highest radiation.
3. The height of the broadband receiving antenna was varied between one meter and four meters above ground to find the maximum emissions field strength of both horizontal and vertical polarization.
4. For each suspected emissions, the antenna tower was scan (from 1 M to 4 M) and then the turntable was rotated (from 0 degree to 360 degrees) to find the maximum reading.
5. Set the test-receiver system to Peak or CISPR quasi-peak Detect Function with specified bandwidth under Maximum Hold Mode.
6. For emissions above 1GHz, use 1MHz VBW and RBW for peak reading. Then 1MHz RBW and 10Hz VBW for average reading in spectrum analyzer.
7. When the radiated emissions limits are expressed in terms of the average value of the emissions, and pulsed operation is employed, the measurement field strength shall be determined by averaging over one complete pulse train, including blanking intervals, as long as the pulse train does not exceed 0.1 seconds. As an alternative (provided the transmitter operates for longer than 0.1 seconds) or in cases where the pulse train exceeds 0.1 seconds, the measured field strength shall be determined from the average absolute voltage during a 0.1 second interval during which the field strength is at its maximum value.
8. If the emissions level of the EUT in peak mode was 3 dB lower than the average limit specified, then testing will be stopped and peak values of EUT will be reported, otherwise, the emissions which do not have 3 dB margin will be repeated one by one using the quasi-peak method for below 1GHz.
9. For testing above 1GHz, the emissions level of the EUT in peak mode was lower than average limit (that means the emissions level in peak mode also complies with the limit in average mode), then testing will be stopped and peak values of EUT will be reported, otherwise, the emissions will be measured in average mode again and reported.
10. In case the emission is lower than 30MHz, loop antenna has to be used for measurement and the recorded data should be QP measured by receiver. High – Low scan is not required in this case.

#### 4.5.4. Test Setup Layout

For radiated emissions below 30MHz

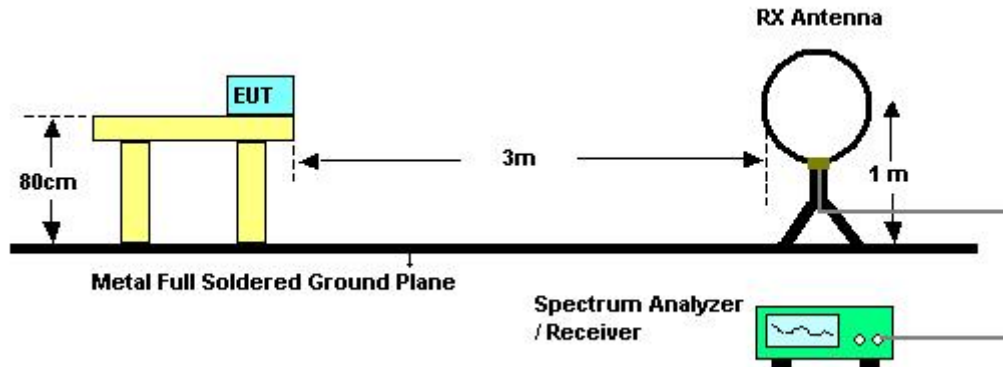

For radiated emissions above 30MHz

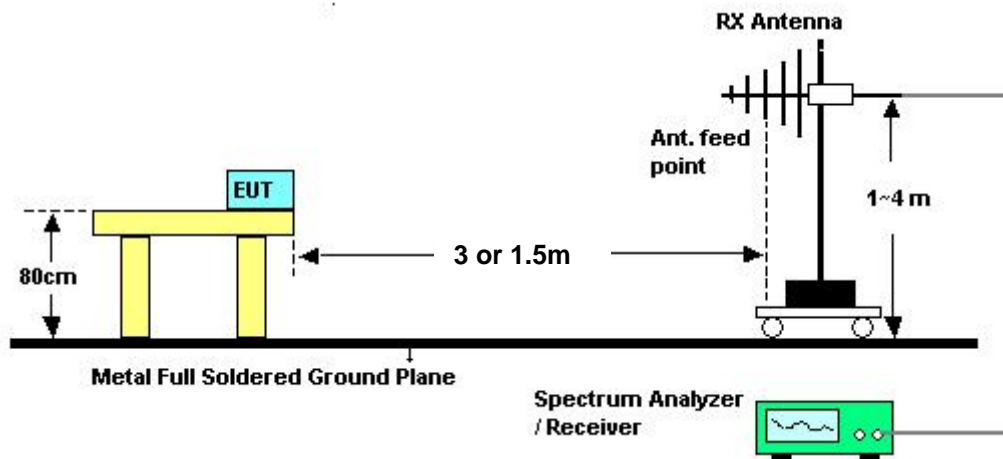

Above 10 GHz shall be extrapolated to the specified distance using an extrapolation factor of 20 dB/decade from 3m to 1.5m.

Distance extrapolation factor =  $20 \log (\text{specific distance [3m]} / \text{test distance [1.5m]})$  (dB);

Limit line = specific limits (dBuV) + distance extrapolation factor [6 dB].

#### 4.5.5. Test Deviation

There is no deviation with the original standard.

#### 4.5.6. EUT Operation during Test

The EUT was programmed to be in continuously transmitting mode.

#### 4.5.7. Results of Radiated Emissions (9kHz~30MHz)

<b>Temperature</b>	22°C	<b>Humidity</b>	56%
<b>Test Engineer</b>	Johnson Chang	<b>Test Date</b>	Jul. 27, 2010

<b>Freq. (MHz)</b>	<b>Level (dBuV)</b>	<b>Over Limit (dB)</b>	<b>Limit Line (dBuV)</b>	<b>Remark</b>
-	-	-	-	See Note

Note:

The amplitude of spurious emissions that are attenuated by more than 20 dB below the permissible value has no need to be reported.

Distance extrapolation factor =  $40 \log(\text{specific distance} / \text{test distance})$  (dB);

Limit line = specific limits (dBuV) + distance extrapolation factor.

4.5.8. Results of Radiated Emissions (30MHz~1GHz)

Temperature	22°C	Humidity	56%
Test Engineer	Johnson Chang	Configurations	Normal Link / Mode 2

Horizontal

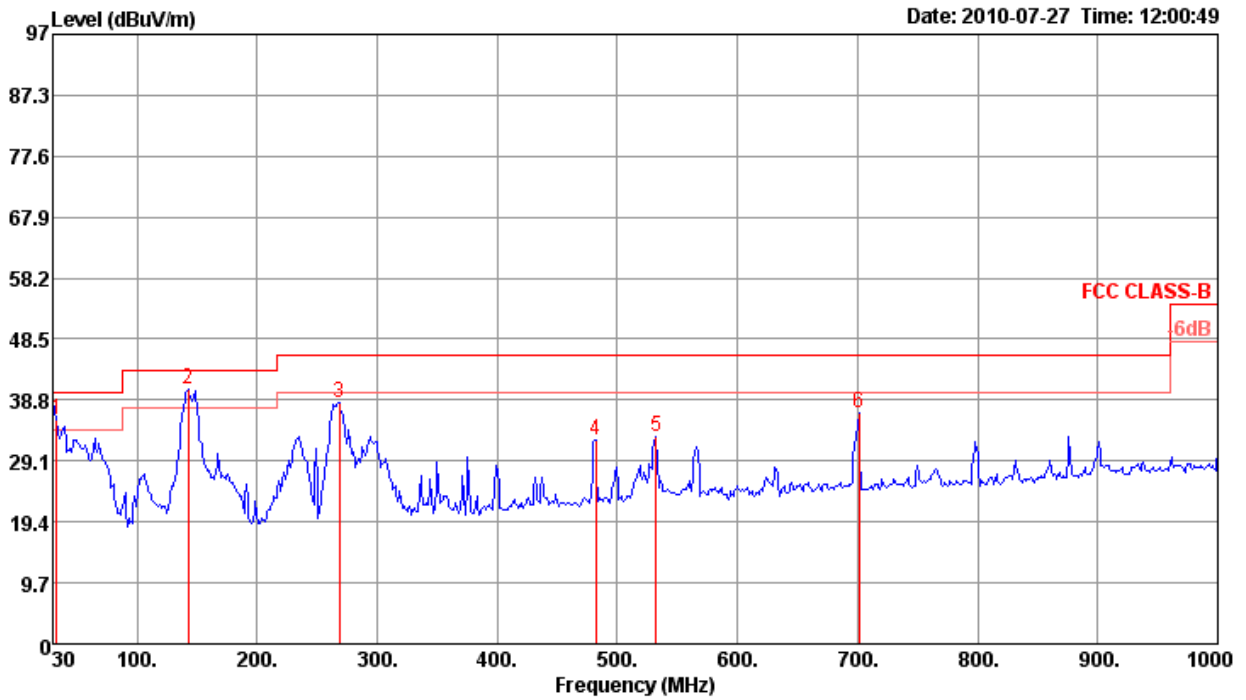

	Freq	Level	Limit	Over	Read	Cable	Preamp	Antenna	Aux	T/Pos	A/Pos	Remark	Pol/Phase
	MHz	dBuV/m	dBuV/m	dB	dBuV	dB	dB	dB/m	dB	deg	cm		
1	32.91	35.71	40.00	-4.29	45.86	0.50	27.80	17.15	0.00	0	100	Peak	HORIZONTAL
2	142.52	40.40	43.50	-3.10	54.17	1.41	27.39	12.21	0.00	0	100	Peak	HORIZONTAL
3	268.62	38.37	46.00	-7.63	50.37	1.97	26.96	12.99	0.00	0	100	Peak	HORIZONTAL
4	482.02	32.41	46.00	-13.59	40.42	2.66	28.01	17.34	0.00	0	100	Peak	HORIZONTAL
5	532.46	32.89	46.00	-13.11	40.23	2.76	28.10	18.00	0.00	0	100	Peak	HORIZONTAL
6	701.24	36.74	46.00	-9.26	42.33	3.30	27.99	19.10	0.00	0	100	Peak	HORIZONTAL



**Vertical**

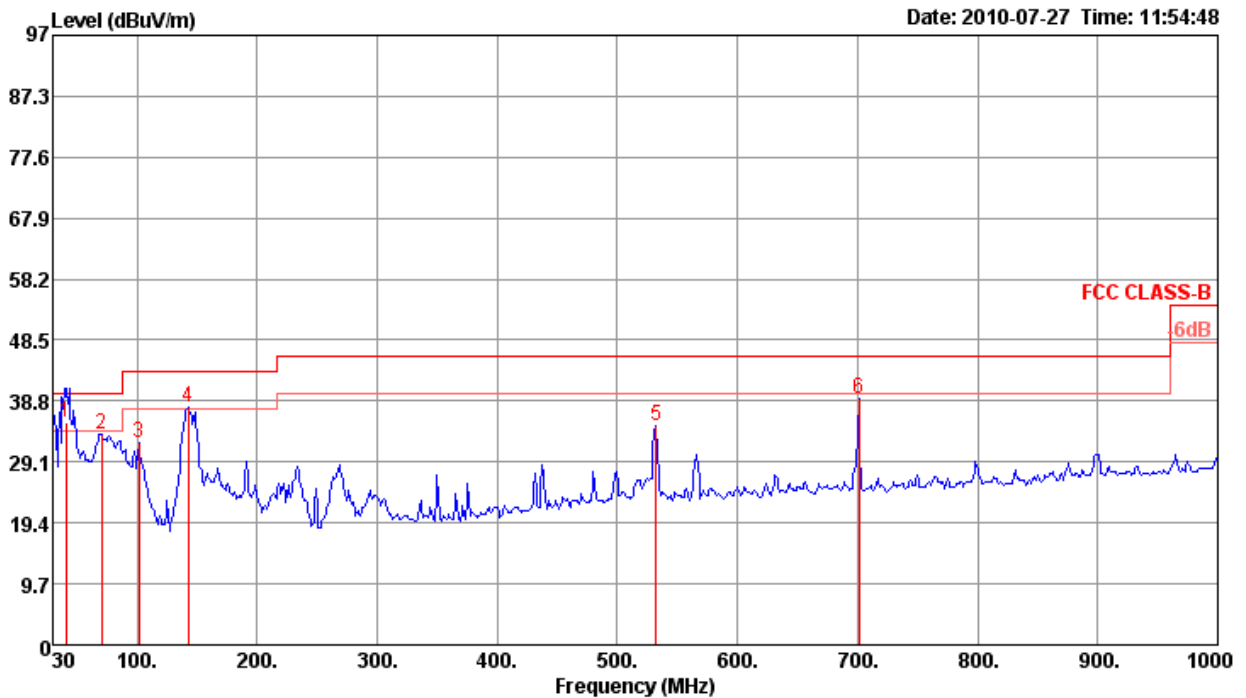

	Freq	Level	Limit Line	Over Limit	Read Level	Cable Loss	Preamp Factor	Antenna Factor	Aux Factor	T/Pos	A/Pos	Remark	Pol/Phase
	MHz	dBuV/m	dBuV/m	dB	dBuV	dB	dB	dB/m	dB	deg	cm		
1	40.79	35.51	40.00	-4.49	50.06	0.70	27.80	12.55	0.00	268	100	QP	VERTICAL
2	70.74	33.47	40.00	-6.53	53.68	0.82	27.72	6.69	0.00	0	400	Peak	VERTICAL
3	101.78	32.19	43.50	-11.31	47.44	1.20	27.59	11.14	0.00	0	400	Peak	VERTICAL
4	142.52	37.91	43.50	-5.59	51.68	1.41	27.39	12.21	0.00	0	400	Peak	VERTICAL
5	532.46	34.97	46.00	-11.03	42.31	2.76	28.10	18.00	0.00	0	400	Peak	VERTICAL
6	701.24	39.07	46.00	-6.93	44.66	3.30	27.99	19.10	0.00	0	400	Peak	VERTICAL

**Note:**

The amplitude of spurious emissions that are attenuated by more than 20dB below the permissible value has no need to be reported.

Emission level (dBuV/m) = 20 log Emission level (uV/m).

Corrected Reading: Antenna Factor + Cable Loss + Read Level - Preamp Factor = Level.

4.5.9. Results for Radiated Emissions (1GHz~10<sup>th</sup> Harmonic)

<b>Temperature</b>	22°C	<b>Humidity</b>	56%
<b>Test Engineer</b>	Johnson Chang	<b>Configurations</b>	11a IEEE 802.11n MCS8 20MHz CH 149 / Ant. A + Ant. B
<b>Test Date</b>	Aug. 04, 2010		

**Horizontal**

	Freq	Level	Limit Line	Over Limit	Read Level	Cable Loss	Preamp Factor	Antenna Factor	T/Pos	A/Pos	Remark	Pol/Phase
	MHz	dBuV/m	dBuV/m	dB	dBuV	dB	dB	dB/m	deg	cm		
1	11489.50	54.16	60.00	-5.84	45.65	4.76	34.75	38.50	98	100	Average	HORIZONTAL
2	11489.66	68.70	80.00	-11.30	60.19	4.76	34.75	38.50	98	100	Peak	HORIZONTAL

**Vertical**

	Freq	Level	Limit Line	Over Limit	Read Level	Cable Loss	Preamp Factor	Antenna Factor	T/Pos	A/Pos	Remark	Pol/Phase
	MHz	dBuV/m	dBuV/m	dB	dBuV	dB	dB	dB/m	deg	cm		
1	11489.58	53.05	60.00	-6.95	44.54	4.76	34.75	38.50	77	100	Average	VERTICAL
2	11490.33	66.96	80.00	-13.04	58.45	4.76	34.75	38.50	77	100	Peak	VERTICAL

<b>Temperature</b>	22°C	<b>Humidity</b>	56%
<b>Test Engineer</b>	Johnson Chang	<b>Configurations</b>	11a IEEE 802.11n MCS8 20MHz CH 157 / Ant. A + Ant. B
<b>Test Date</b>	Aug. 04, 2010		

### Horizontal

	Freq	Level	Limit	Over	Read	Cable	Preamp	Antenna	T/Pos	A/Pos	Remark	Pol/Phase
	MHz	dBuV/m	dBuV/m	dB	dBuV	dB	dB	dB/m	deg	cm		
1	11569.61	66.00	80.00	-14.00	57.43	4.86	34.80	38.51	100	100	Peak	HORIZONTAL
2	11570.48	51.06	60.00	-8.94	42.46	4.91	34.82	38.51	100	100	Average	HORIZONTAL

### Vertical

	Freq	Level	Limit	Over	Read	Cable	Preamp	Antenna	T/Pos	A/Pos	Remark	Pol/Phase
	MHz	dBuV/m	dBuV/m	dB	dBuV	dB	dB	dB/m	deg	cm		
1	11569.50	50.18	60.00	-9.82	41.61	4.86	34.80	38.51	78	100	Average	VERTICAL
2	11569.90	64.24	80.00	-15.76	55.64	4.91	34.82	38.51	78	100	Peak	VERTICAL

<b>Temperature</b>	22°C	<b>Humidity</b>	56%
<b>Test Engineer</b>	Johnson Chang	<b>Configurations</b>	11a IEEE 802.11n MCS8 20MHz CH 165 / Ant. A + Ant. B
<b>Test Date</b>	Aug. 04, 2010		

**Horizontal**

	Freq	Level	Limit Line	Over Limit	Read Level	Cable Loss	Preamp Factor	Antenna Factor	T/Pos	A/Pos	Remark	Pol/Phase
	MHz	dBuV/m	dBuV/m	dB	dBuV	dB	dB	dB/m	deg	cm		
1	11650.27	63.49	80.00	-16.51	54.83	5.03	34.90	38.53	99	100	Peak	HORIZONTAL
2	11650.38	48.84	60.00	-11.16	40.18	5.03	34.90	38.53	99	100	Average	HORIZONTAL

**Vertical**

	Freq	Level	Limit Line	Over Limit	Read Level	Cable Loss	Preamp Factor	Antenna Factor	T/Pos	A/Pos	Remark	Pol/Phase
	MHz	dBuV/m	dBuV/m	dB	dBuV	dB	dB	dB/m	deg	cm		
1	11649.68	56.54	80.00	-23.46	47.88	5.03	34.90	38.53	63	100	Peak	VERTICAL
2	11649.75	47.54	60.00	-12.46	38.88	5.03	34.90	38.53	63	100	Average	VERTICAL

<b>Temperature</b>	22°C	<b>Humidity</b>	56%
<b>Test Engineer</b>	Johnson Chang	<b>Configurations</b>	11a IEEE 802.11n MCS8 40MHz CH 151 / Ant. A + Ant. B
<b>Test Date</b>	Aug. 04, 2010		

**Horizontal**

	Freq	Level	Limit	Over	Read	Cable	Preamp	Antenna	T/Pos	A/Pos	Remark	Pol/Phase
	MHz	dBuV/m	dBuV/m	dB	dBuV	dB	dB	dB/m	deg	cm		
1	11509.52	49.51	60.00	-10.49	40.98	4.78	34.75	38.50	99	100	Average	HORIZONTAL
2	11510.07	63.14	80.00	-16.86	54.61	4.78	34.75	38.50	99	100	Peak	HORIZONTAL

**Vertical**

	Freq	Level	Limit	Over	Read	Cable	Preamp	Antenna	T/Pos	A/Pos	Remark	Pol/Phase
	MHz	dBuV/m	dBuV/m	dB	dBuV	dB	dB	dB/m	deg	cm		
1	11509.52	48.21	60.00	-11.79	39.68	4.78	34.75	38.50	78	100	Average	VERTICAL
2	11510.48	62.41	80.00	-17.59	53.88	4.78	34.75	38.50	78	100	Peak	VERTICAL

<b>Temperature</b>	22°C	<b>Humidity</b>	56%
<b>Test Engineer</b>	Johnson Chang	<b>Configurations</b>	11a IEEE 802.11n MCS8 40MHz CH 159 / Ant. A + Ant. B
<b>Test Date</b>	Aug. 04, 2010		

**Horizontal**

	Freq	Level	Limit Line	Over Limit	Read Level	Cable Loss	Preamp Factor	Antenna Factor	T/Pos	A/Pos	Remark	Pol/Phase
	MHz	dBuV/m	dBuV/m	dB	dBuV	dB	dB	dB/m	deg	cm		
1	11590.37	57.06	80.00	-22.94	48.45	4.91	34.82	38.52	99	100	Peak	HORIZONTAL
2	11590.48	47.80	60.00	-12.20	39.19	4.91	34.82	38.52	99	100	Average	HORIZONTAL

**Vertical**

	Freq	Level	Limit Line	Over Limit	Read Level	Cable Loss	Preamp Factor	Antenna Factor	T/Pos	A/Pos	Remark	Pol/Phase
	MHz	dBuV/m	dBuV/m	dB	dBuV	dB	dB	dB/m	deg	cm		
1	11589.58	46.48	60.00	-13.52	37.87	4.91	34.82	38.52	79	100	Average	VERTICAL
2	11590.24	60.48	80.00	-19.52	51.87	4.91	34.82	38.52	79	100	Peak	VERTICAL

<b>Temperature</b>	22°C	<b>Humidity</b>	56%
<b>Test Engineer</b>	Johnson Chang	<b>Configurations</b>	IEEE 802.11a CH 149 / Ant. A + Ant. B
<b>Test Date</b>	Aug. 04, 2010		

#### Horizontal

	Freq	Level	Limit Line	Over Limit	Read Level	Cable Loss	Preamp Factor	Antenna Factor	T/Pos	A/Pos	Remark	Pol/Phase
	MHz	dBuV/m	dBuV/m	dB	dBuV	dB	dB	dB/m	deg	cm		
1	11489.52	56.52	60.00	-3.48	48.01	4.76	34.75	38.50	99	100	Average	HORIZONTAL
2	11489.89	71.32	80.00	-8.68	62.81	4.76	34.75	38.50	99	100	Peak	HORIZONTAL

#### Vertical

	Freq	Level	Limit Line	Over Limit	Read Level	Cable Loss	Preamp Factor	Antenna Factor	T/Pos	A/Pos	Remark	Pol/Phase
	MHz	dBuV/m	dBuV/m	dB	dBuV	dB	dB	dB/m	deg	cm		
1	11489.50	54.96	60.00	-5.04	46.45	4.76	34.75	38.50	78	100	Average	VERTICAL
2	11489.56	69.96	80.00	-10.04	61.45	4.76	34.75	38.50	78	100	Peak	VERTICAL

<b>Temperature</b>	22°C	<b>Humidity</b>	56%
<b>Test Engineer</b>	Johnson Chang	<b>Configurations</b>	IEEE 802.11a CH 157 / Ant. A + Ant. B
<b>Test Date</b>	Aug. 04, 2010		

#### Horizontal

	Freq	Level	Limit Line	Over Limit	Read Level	Cable Loss	Preamp Factor	Antenna Factor	T/Pos	A/Pos	Remark	Pol/Phase
	MHz	dBuV/m	dBuV/m	dB	dBuV	dB	dB	dB/m	deg	cm		
1	11570.03	53.63	60.00	-6.37	45.03	4.91	34.82	38.51	100	100	Average	HORIZONTAL
2	11570.48	68.95	80.00	-11.05	60.35	4.91	34.82	38.51	100	100	Peak	HORIZONTAL

#### Vertical

	Freq	Level	Limit Line	Over Limit	Read Level	Cable Loss	Preamp Factor	Antenna Factor	T/Pos	A/Pos	Remark	Pol/Phase
	MHz	dBuV/m	dBuV/m	dB	dBuV	dB	dB	dB/m	deg	cm		
1	11569.50	51.76	60.00	-8.24	43.19	4.86	34.80	38.51	79	100	Average	VERTICAL
2	11569.52	67.16	80.00	-12.84	58.59	4.86	34.80	38.51	79	100	Peak	VERTICAL



<b>Temperature</b>	22°C	<b>Humidity</b>	56%
<b>Test Engineer</b>	Johnson Chang	<b>Configurations</b>	IEEE 802.11a CH 165 / Ant. A + Ant. B
<b>Test Date</b>	Aug. 04, 2010		

#### Horizontal

	Freq	Level	Limit Line	Over Limit	Read Level	Cable Loss	Preamp Factor	Antenna Factor	T/Pos	A/Pos	Remark	Pol/Phase
	MHz	dBuV/m	dBuV/m	dB	dBuV	dB	dB	dB/m	deg	cm		
1	11650.44	51.87	60.00	-8.13	43.21	5.03	34.90	38.53	99	100	Average	HORIZONTAL
2	11650.49	61.82	80.00	-18.18	53.16	5.03	34.90	38.53	99	100	Peak	HORIZONTAL

#### Vertical

	Freq	Level	Limit Line	Over Limit	Read Level	Cable Loss	Preamp Factor	Antenna Factor	T/Pos	A/Pos	Remark	Pol/Phase
	MHz	dBuV/m	dBuV/m	dB	dBuV	dB	dB	dB/m	deg	cm		
1	11650.34	62.06	80.00	-17.94	53.40	5.03	34.90	38.53	63	100	Peak	VERTICAL
2	11650.50	47.47	60.00	-12.53	38.81	5.03	34.90	38.53	63	100	Average	VERTICAL

#### Note:

The amplitude of spurious emissions that are attenuated by more than 20dB below the permissible value has no need to be reported.

Emission level (dBuV/m) = 20 log Emission level (uV/m).

Corrected Reading: Antenna Factor + Cable Loss + Read Level - Preamp Factor = Level.

## 4.6. Band Edge Emissions Measurement

### 4.6.1. Limit

20dBc in any 100 kHz bandwidth outside the operating frequency band. In case the emission fall within the restricted band specified on 15.205(a), then the 15.209(a) limit in the table below has to be followed.

Frequencies (MHz)	Field Strength (micovolts/meter)	Measurement Distance (meters)
0.009~0.490	2400/F(KHz)	300
0.490~1.705	24000/F(KHz)	30
1.705~30.0	30	30
30~88	100	3
88~216	150	3
216~960	200	3
Above 960	500	3

### 4.6.2. Measuring Instruments and Setting

Please refer to section 5 of equipments list in this report. The following table is the setting of the spectrum analyzer.

Spectrum Parameter	Setting
Attenuation	Auto
Span Frequency	100 MHz
RB / VB (Emission in restricted band)	1 MHz / 1MHz for Peak, 1 MHz / 10Hz for Average
RB / VB (Emission in non-restricted band)	100 KHz /100 KHz for Peak

### 4.6.3. Test Procedures

1. The test procedure is the same as section 4.5.3, only the frequency range investigated is limited to 100MHz around bandedges.
2. In case the emission is fail due to the used RB/VB is too wide, marker-delta method of FCC Public Notice DA00-705 will be followed.

### 4.6.4. Test Setup Layout

This test setup layout is the same as that shown in section 4.5.4.

### 4.6.5. Test Deviation

There is no deviation with the original standard.

### 4.6.6. EUT Operation during Test

The EUT was programmed to be in continuously transmitting mode.

#### 4.6.7. Test Result of Band Edge and Fundamental Emissions

For Emission not in Restricted Band

Low Band Edge Plot on Configuration 11a IEEE 802.11n MCS8 20MHz / 5745 MHz

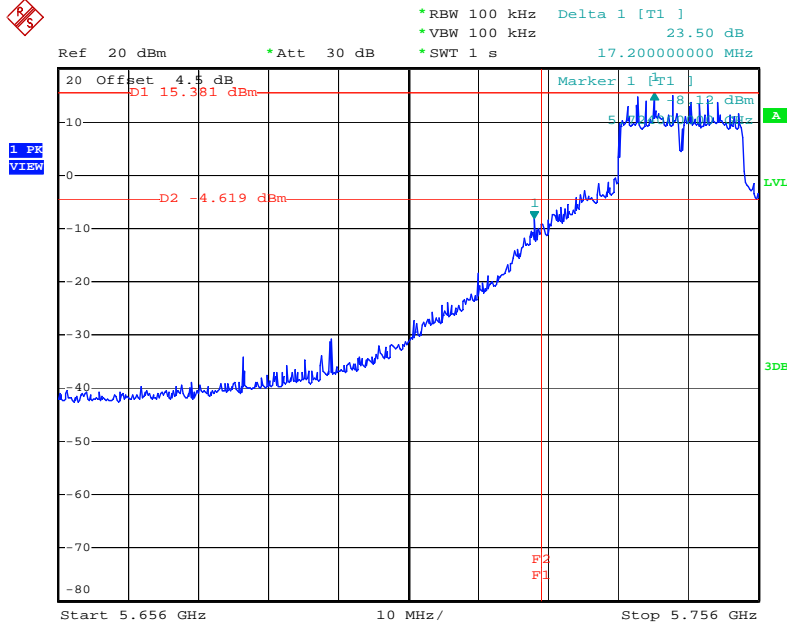

Date: 4.AUG.2010 19:47:43

High Band Edge Plot on Configuration 11a IEEE 802.11n MCS8 20MHz / 5825 MHz

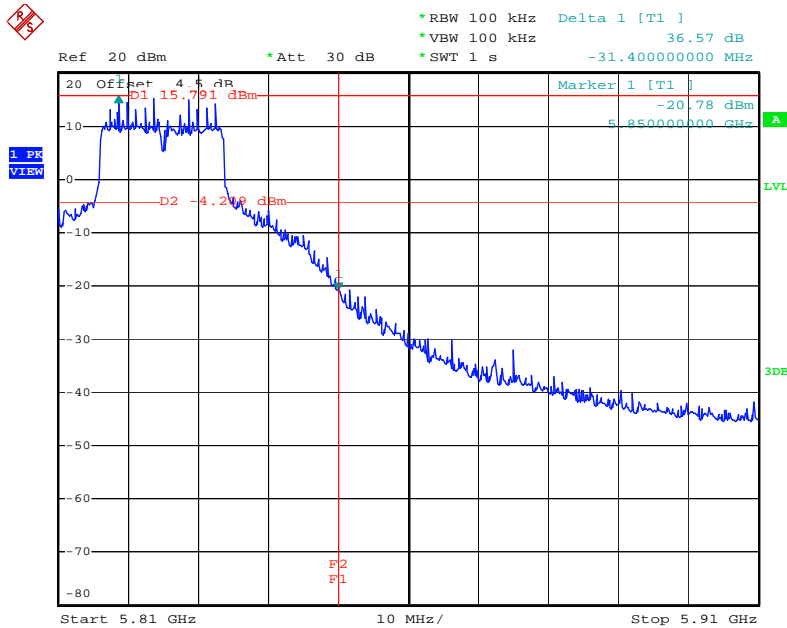

Date: 4.AUG.2010 19:52:04

**For Emission not in Restricted Band**

**Low Band Edge Plot on Configuration 11a IEEE 802.11n MCS8 40MHz / 5755 MHz**

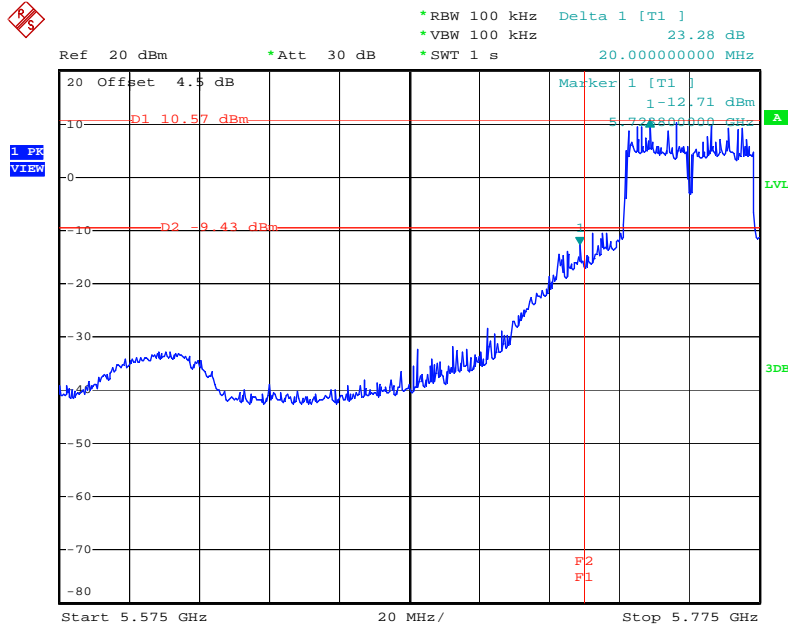

Date: 4.AUG.2010 21:46:53

**High Band Edge Plot on Configuration 11a IEEE 802.11n MCS8 40MHz / 5795 MHz**

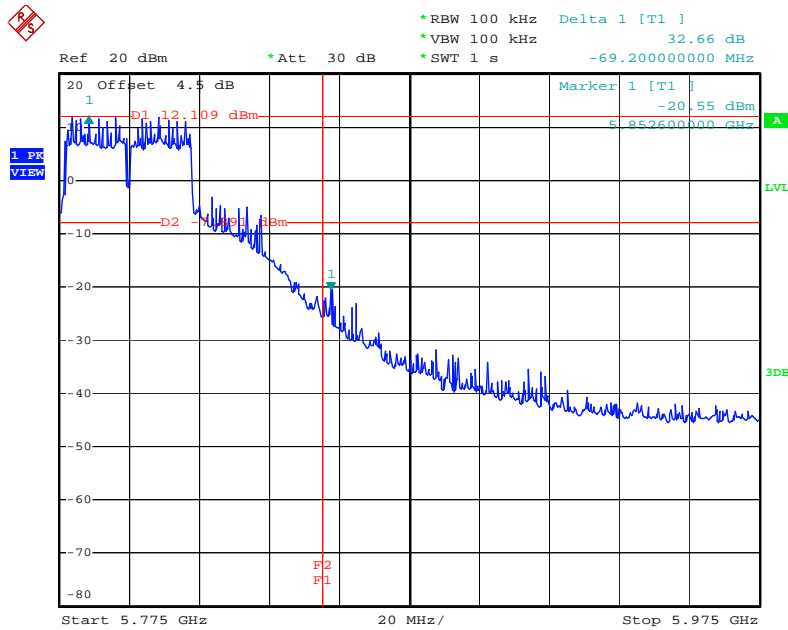

Date: 4.AUG.2010 19:42:00

**For Emission not in Restricted Band**

**Low Band Edge Plot on Configuration IEEE 802.11a / 5745 MHz**

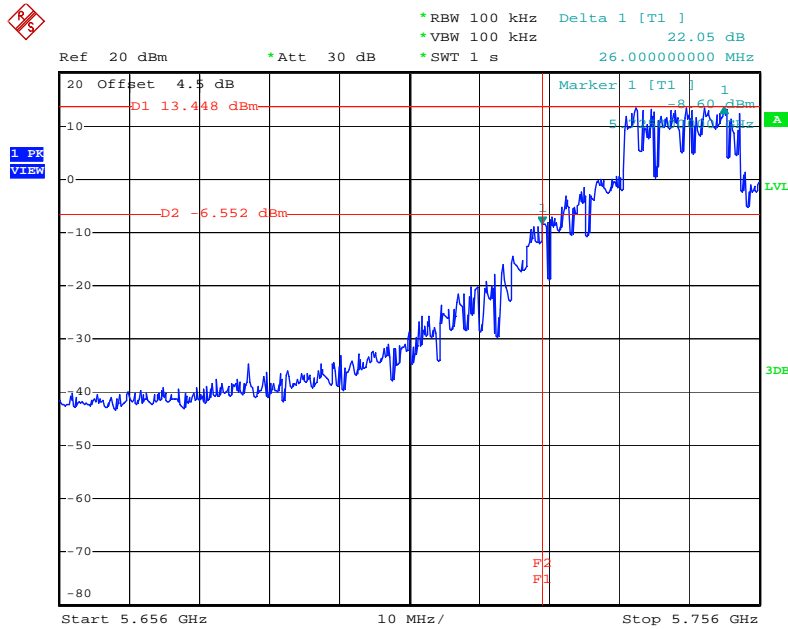

Date: 4.AUG.2010 19:58:34

**High Band Edge Plot on Configuration IEEE 802.11a / 5825 MHz**

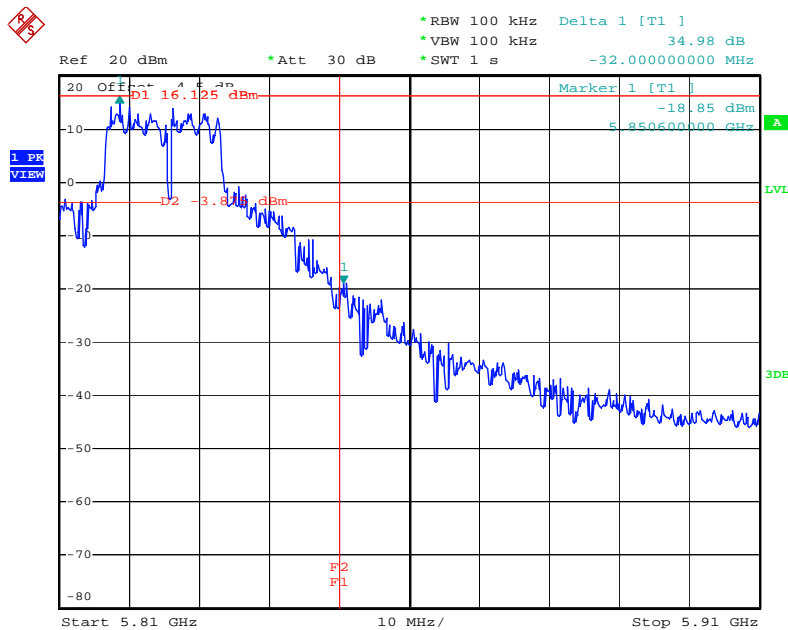

Date: 4.AUG.2010 19:54:10

## 4.7. Antenna Requirements

### 4.7.1. Limit

Except for special regulations, the Low-power Radio-frequency Devices must not be equipped with any jacket for installing an antenna with extension cable. An intentional radiator shall be designed to ensure that no antenna other than that furnished by the responsible party shall be used with the device. The use of a permanently attached antenna or of an antenna that uses a unique coupling to the intentional radiator shall be considered sufficient to comply with the provisions of this Section. The manufacturer may design the unit so that the user can replace a broken antenna, but the use of a standard antenna jack or electrical connector is prohibited. Further, this requirement does not apply to intentional radiators that must be professionally installed.

### 4.7.2. Antenna Connector Construction

Please refer to section 3.3 in this test report; antenna connector complied with the requirements.

## 5. LIST OF MEASURING EQUIPMENTS

Instrument	Manufacturer	Model No.	Serial No.	Characteristics	Calibration Date	Remark
EMC Receiver	R&S	ESCS 30	100174	9kHz – 2.75GHz	Apr. 06, 2010	Conduction (CO04-HY)
LISN	MessTec	NNB-2/16Z	99041	9kHz – 30MHz	Mar. 23, 2010	Conduction (CO04-HY)
LISN (Support Unit)	EMCO	3810/2NM	9703-1839	9kHz – 30MHz	Apr. 29, 2010	Conduction (CO04-HY)
RF Cable-CON	UTIFLEX	3102-26886-4	CB049	9kHz – 30MHz	Apr. 20, 2010	Conduction (CO04-HY)
ISN	SCHAFFNER	ISN T400	21653	9kHz – 30MHz	Jun. 10, 2010	Conduction (CO04-HY)
EMI Filter	LINDGREN	LRE-2030	2651	< 450 Hz	N/A	Conduction (CO04-HY)
3m Semi Anechoic Chamber	SIDT FRANKONIA	SAC-3M	03CH03-HY	30 MHz - 1 GHz 3m	Jun. 18, 2010	Radiation (03CH03-HY)
Amplifier	SCHAFFNER	COA9231A	18667	9 kHz - 2 GHz	Jan. 24, 2010	Radiation (03CH03-HY)
Amplifier	Agilent	8449B	3008A02120	1 GHz - 26.5 GHz	Jul. 21, 2010	Radiation (03CH03-HY)
Spectrum Analyzer	R&S	FSP40	100004	9 kHz - 40 GHz	Oct. 03, 2009	Radiation (03CH03-HY)
Bilog Antenna	SCHAFFNER	CBL 6112D	22237	30 MHz – 1 GHz	Sep. 26, 2009	Radiation (03CH03-HY)
Horn Antenna	EMCO	3115	6741	1GHz ~ 18GHz	May 20, 2010	Radiation (03CH03-HY)
Horn Antenna	SCHWARZBECK	BBHA9170	BBHA9170154	15 GHz - 40 GHz	Jan.11, 2010	Radiation (03CH03-HY)
RF Cable-R03m	Jye Bao	RG142	CB021	30 MHz - 1 GHz	Jan. 05, 2010	Radiation (03CH03-HY)
RF Cable-HIGH	SUHNER	SUCOFLEX 106	03CH03-HY	1 GHz - 40 GHz	Jan. 05, 2010	Radiation (03CH03-HY)
Turn Table	HD	DS 420	420/650/00	0 – 360 degree	N/A	Radiation (03CH03-HY)
Antenna Mast	HD	MA 240	240/560/00	1 m - 4 m	N/A	Radiation (03CH03-HY)
Loop Antenna	R&S	HFH2-Z2	860004/001	9 kHz - 30 MHz	Jul. 20, 2009*	Radiation (03CH03-HY)
Spectrum Analyzer	R&S	FSU26.5	100015	20Hz ~ 26.5GHz	Oct. 29, 2009	Conducted (TH01-HY)
Power Meter	R&S	NRVS	100444	DC ~ 40GHz	Jul. 25, 2010	Conducted (TH01-HY)
Power Sensor	R&S	NRV-Z51	100666	DC ~ 30GHz	Jul. 26, 2010	Conducted (TH01-HY)
Power Sensor	R&S	NRV-Z32	100057	30MHz ~ 6GHz	Jul. 25, 2010	Conducted (TH01-HY)
AC Power Source	HPC	HPA-500W	HPA-9100024	AC 0 ~ 300V	Jul. 26, 2009*	Conducted (TH01-HY)
DC Power Source	G.W.	GPC-6030D	C671845	DC 1V ~ 60V	Apr. 16, 2010	Conducted (TH01-HY)
Temp. and Humidity Chamber	Giant Force	GTH-225-20-S	MAB0103-001	N/A	Aug. 06, 2009	Conducted (TH01-HY)
RF CABLE-1m	Jye Bao	RG142	CB034-1m	20MHz ~ 7GHz	Dec. 02, 2009	Conducted (TH01-HY)
RF CABLE-2m	Jye Bao	RG142	CB035-2m	20MHz ~ 1GHz	Dec. 02, 2009	Conducted (TH01-HY)
Vector Signal Generator	R&S	SMU200A	102098	100kHz ~ 6GHz	Feb. 13, 2010	Conducted (TH01-HY)
Signal Generator	R&S	SMR40	100116	10MHz ~ 40GHz	Mar. 30, 2010	Conducted (TH01-HY)

Note: Calibration Interval of instruments listed above is one year.

Note: For "\*" Calibration Interval of instruments listed above is two years.

## TEST LOCATION

SHIJR	ADD : 6Fl., No. 106, Sec. 1, Shintai 5th Rd., Shijr City, Taipei, Taiwan 221, R.O.C. TEL : 886-2-2696-2468 FAX : 886-2-2696-2255
HWA YA	ADD : No. 52, Hwa Ya 1st Rd., Kwei-Shan Hsiang, Tao Yuan Hsien, Taiwan, R.O.C. TEL : 886-3-327-3456 FAX : 886-3-318-0055
LINKOU	ADD : No. 30-2, Dingfu Tsuen, Linkou Shiang, Taipei, Taiwan 244, R.O.C TEL : 886-2-2601-1640 FAX : 886-2-2601-1695
DUNGHU	ADD : No. 3, Lane 238, Kangle St., Neihu Chiu, Taipei, Taiwan 114, R.O.C. TEL : 886-2-2631-4739 FAX : 886-2-2631-9740
JUNGHE	ADD : 7Fl., No. 758, Jungjeng Rd., Junghe City, Taipei, Taiwan 235, R.O.C. TEL : 886-2-8227-2020 FAX : 886-2-8227-2626
NEIHU	ADD : 4Fl., No. 339, Hsin Hu 2 <sup>nd</sup> Rd., Taipei 114, Taiwan, R.O.C. TEL : 886-2-2794-8886 FAX : 886-2-2794-9777
JHUBEI	ADD : No.8, Lane 728, Bo-ai St., Jhubei City, HsinChu County 302, Taiwan, R.O.C. TEL : 886-3-656-9065 FAX : 886-3-656-9085



## 6. TAF CERTIFICATE OF ACCREDITATION



Certificate No. : L1190-091230

財團法人全國認證基金會  
Taiwan Accreditation Foundation

### Certificate of Accreditation

This is to certify that

**Sporton International Inc.**  
**EMC & Wireless Communications Laboratory**  
No.52, Hwa Ya 1st Rd., Hwa Ya Technology Park, Kwei-Shan Hsiang, Tao Yuan Hsien,  
Taiwan, R.O.C.

**is accredited in respect of laboratory**

<b>Accreditation Criteria</b>	: ISO/IEC 17025:2005
<b>Accreditation Number</b>	: 1190
<b>Originally Accredited</b>	: December 15, 2003
<b>Effective Period</b>	: January 10, 2010 to January 09, 2013
<b>Accredited Scope</b>	: Testing Field, see described in the Appendix
<b>Specific Accreditation Program</b>	: Accreditation Program for Designated Testing Laboratory for Commodities Inspection Accreditation Program for Telecommunication Equipment Testing Laboratory Accreditation Program for BSMI Mutual Recognition Arrangement with Foreign Authorities

*Jay-san Chen*

Jay-San Chen  
President, Taiwan Accreditation Foundation  
Date : December 30, 2009

Pl, total 22 pages

The Appendix forms an integral part of this Certificate, which shall be invalid when use without the Appendix