



FCC TEST REPORT

REPORT NO.: RF930216H01

MODEL NO.: XG-702B

RECEIVED: Feb. 17, 2004

TESTED: Feb. 25, 2004

APPLICANT: Z-COM, INC.

ADDRESS: 7F-2, No.9. Prosperity RD. I , Science-Based
Industrial Park Hsinchu, 300 Taiwan

ISSUED BY: Advance Data Technology Corporation

LAB LOCATION: No. 81-1, Lu Liao Keng, 9 Ling, Wu Lung Tsuen,
Chiung Lin Hsiang, Hsin Chu Hsien,
Taiwan, R.O.C.

This test report consists of 58 pages in total. It may be duplicated completely for legal use with the approval of the applicant. It should not be reproduced except in full, without the written approval of our laboratory. The test results in the report only apply to the tested sample.



0536
ILAC MRA



Table of Contents

1	CERTIFICATION.....	4
2	SUMMARY OF TEST RESULTS.....	5
3	GENERAL INFORMATION	6
3.1	GENERAL DESCRIPTION OF EUT.....	6
3.2	DESCRIPTION OF TEST MODES.....	7
3.3	GENERAL DESCRIPTION OF APPLIED STANDARDS	7
3.4	DESCRIPTION OF SUPPORT UNITS.....	8
4	TEST TYPES AND RESULTS.....	9
4.1	CONDUCTED EMISSION MEASUREMENT	9
4.1.1	LIMITS OF CONDUCTED EMISSION MEASUREMENT	9
4.1.2	TEST INSTRUMENTS	9
4.1.3	TEST SETUP	10
4.1.4	EUT OPERATING CONDITIONS.....	11
4.1.5	TEST RESULTS.....	12
4.2	RADIATED EMISSION MEASUREMENT	14
4.2.1	LIMITS OF RADIATED EMISSION MEASUREMENT.....	14
4.2.2	TEST INSTRUMENTS	15
4.2.3	TEST PROCEDURES.....	16
4.2.4	TEST SETUP	17
4.2.5	EUT OPERATING CONDITIONS.....	17
4.2.6	TEST RESULTS.....	18
4.2.7	TEST RESULTS - DSSS.....	19
4.2.8	TEST RESULTS -OFDM	22
4.3	6dB BANDWIDTH MEASUREMENT	25
4.3.1	LIMITS OF 6dB BANDWIDTH MEASUREMENT	25
4.3.2	TEST INSTRUMENTS	25
4.3.3	TEST PROCEDURE	26
4.3.4	TEST SETUP	26
4.3.5	EUT OPERATING CONDITIONS.....	26
4.3.6	TEST RESULTS-DSSS.....	27
4.3.7	TEST RESULTS-OFDM	31
4.4	MAXIMUM PEAK OUTPUT POWER	35
4.4.1	LIMITS OF MAXIMUM PEAK OUTPUT POWER MEASUREMENT	35
4.4.2	TEST INSTRUMENTS	35
4.4.3	TEST PROCEDURES.....	36



4.4.4 TEST SETUP 36

4.4.5 EUT OPERATING CONDITIONS 36

4.4.6 TEST RESULTS- DSSS 37

4.4.7 TEST RESULTS- OFDM 37

4.5 POWER SPECTRAL DENSITY MEASUREMENT 38

4.5.1 LIMITS OF POWER SPECTRAL DENSITY MEASUREMENT 38

4.5.2 TEST INSTRUMENTS 38

4.5.3 TEST PROCEDURE 39

4.5.4 TEST SETUP 39

4.5.5 EUT OPERATING CONDITIONS 39

4.5.6 TEST RESULTS-DSSS 40

4.5.7 TEST RESULTS-OFDM 44

4.6 BAND EDGES MEASUREMENT 48

4.6.1 LIMITS OF BAND EDGES MEASUREMENT 48

4.6.2 TEST INSTRUMENTS 48

4.6.3 TEST PROCEDURE 48

4.6.4 EUT OPERATING CONDITION 48

4.6.5 TEST RESULTS - DSSS 49

4.6.6 TEST RESULTS-OFDM 52

4.7 ANTENNA REQUIREMENT 55

4.7.1 STANDARD APPLICABLE 55

4.7.2 ANTENNA CONNECTED CONSTRUCTION 55

5 PHOTOGRAPHS OF THE TEST CONFIGURATION 56

6 INFORMATION ON THE TESTING LABORATORIES 58



1 CERTIFICATION

PRODUCT : IEEE 802.11b/g 54Mbps WLAN USB 2.0 Adapter
BRAND NAME : Z-Com
MODEL NO. : XG-702B
APPLICANT : Z-COM, INC.
STANDARDS : 47 CFR Part 15, Subpart C (Section 15.247),
ANSI C63.4-1992

We, **Advance Data Technology Corporation**, hereby certify that one sample (Model:XG-702B) of the designation has been tested in our facility on Feb. 25, 2004. The test record, data evaluation and Equipment Under Test (EUT) configurations represented herein are true and accurate accounts of the measurements of the sample's characteristics under the conditions herein specified.

PREPARED BY: Midoli Peng, **DATE:** Mar. 02, 2004
(Midoli Peng)

APPROVED BY: Eric Lin, **DATE:** Mar. 02, 2004
(Eric Lin, Manager)



2 SUMMARY OF TEST RESULTS

The EUT has been tested according to the following specifications:

APPLIED STANDARD: 47 CFR Part 15, Subpart C			
Standard Section	Test Type and Limit	Result	REMARK
15.207	AC Power Conducted Emission Limit: 48dBuV	PASS	Meet the requirement of limit Minimum passing margin is -14.62 dBuV at 0.177 MHz
15.247(a)(2)	Spectrum Bandwidth of a Direct Sequence Spread Spectrum System Limit: min. 500kHz	PASS	Meet the requirement of limit
15.247(b)	Maximum Peak Output Power Limit: max. 30dBm	PASS	Meet the requirement of limit
15.247(c)	Transmitter Radiated Emissions Limit: Table 15.209	PASS	Meet the requirement of limit Minimum passing margin is -6.4 dBuV at 719.99MHz
15.247(d)	Power Spectral Density Limit: max. 8dBm	PASS	Meet the requirement of limit
15.247(c)	Band Edge Measurement Limit: 20 dB less than the peak value of fundamental frequency	PASS	Meet the requirement of limit



3 GENERAL INFORMATION

3.1 GENERAL DESCRIPTION OF EUT

PRODUCT	IEEE 802.11b/g 54Mbps WLAN USB2.0 Adapter
MODEL NO.	XG-702B
POWER SUPPLY	5VDC from host equipment
MODULATION TYPE	CCK, OFDM, DBPSK, DQPSK
RADIO TECHNOLOGY	DSSS, OFDM
TRANSFER RATE	1/2/5.5/6/9/11/12/18/24/36/48/54Mbps
FREQUENCY RANGE	2412MHz ~ 2462MHz
NUMBER OF CHANNEL	11
OUTPUT POWER	16.20dBm
ANTENNA TYPE	PIFA Antenna(only for Rx) Dipole Antenna(for Rx & Tx)
DATA CABLE	USB Cable(Shielded,1.8m with one core)
I/O PORTS	NA
ASSOCIATED DEVICES	NA

NOTE:

1. The EUT operates in the 2.4GHz frequency spectrum with throughput of up to 54Mbps.
2. The EUT complies with IEEE 802.11g draft standards, and backwards compatible with IEEE 802.11b products.
3. For a more detailed features description, please refer to the manufacturer's specifications or User's Manual.



3.2 DESCRIPTION OF TEST MODES

Eleven channels are provided in this EUT.

Channel	Frequency	Channel	Frequency
1	2412 MHz	7	2442 MHz
2	2417 MHz	8	2447 MHz
3	2422 MHz	9	2452 MHz
4	2427 MHz	10	2457 MHz
5	2432 MHz	11	2462 MHz
6	2437 MHz		

NOTE:

1. Below 1 GHz, the channel 1, 6, and 11 were pre-tested in chamber. The channel 11, worst case one, was chosen for final test.
2. Above 1 GHz, the channel 1, 6, and 11 were tested individually.
3. Test result, which were mentioned on section 3.1.
4. Transfer rate, 11Mbps with CCK technique and 6Mbps with OFDM technique, the worst case, were chosen for final test.

3.3 GENERAL DESCRIPTION OF APPLIED STANDARDS

The EUT is an IEEE 802.11b/g 54Mbps WLAN USB 2.0 Adapter. According to the specifications of the manufacturer, it must comply with the requirements of the following standards:

47 CFR Part 15, Subpart C. (15.247)
ANSI C63.4 : 1992

All tests have been performed and recorded as per the above standards.

NOTE: The EUT is also considered as a kind of computer peripheral, because the connection to computer is necessary for typical use. It has been verified to comply with the requirements of 47 CFR Part 15, Subpart B, Class B (DoC). The test report has been issued separately.



3.4 DESCRIPTION OF SUPPORT UNITS

The EUT has been tested as an independent unit together with other necessary accessories or support units. The following support units or accessories were used to form a representative test configuration during the tests.

No.	Product	Brand	Model No.	Serial No.	FCC ID
1	NOTEBOOK	DELL	PP01L	TW-09c748-12800-165-3171	FCC DoC
2	PRINTER	EPSON	LQ-300+	DCGY017082	FCC DoC
3	MODEM	ACEEX	1414	980020552	IFAXDM1414

No.	Signal cable description
1	NA
2	1.8 m braid shielded wire, terminated with DB25 and Centronics connector via metallic frame, w/o core.
3	1.2 m braid shielded wire, terminated with DB25 and DB9 connector via metallic frame, w/o core.

Note: 1. All power cords of the above support units are unshielded (1.8m).

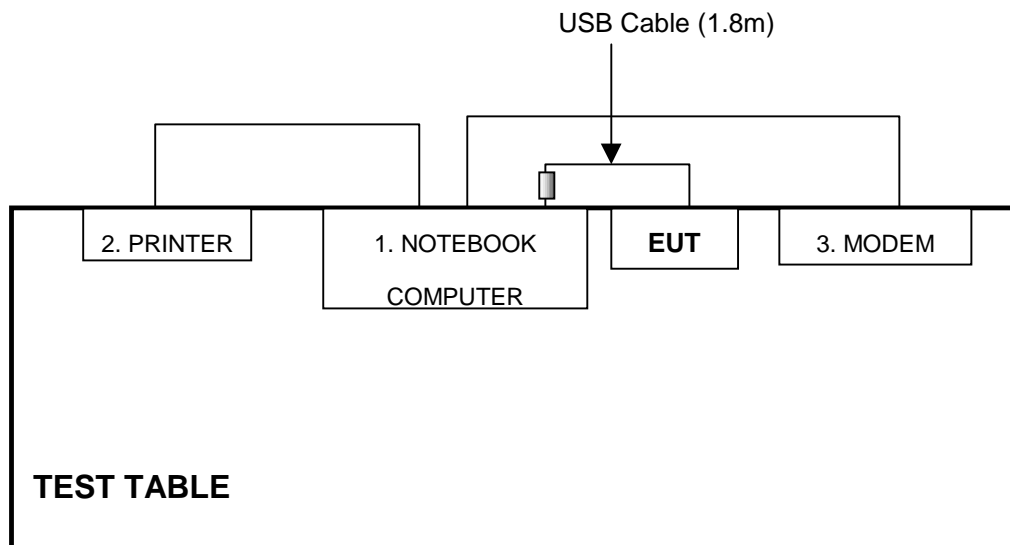

NOTE: 1. Please refer to the photos of test configuration in Item 5 also.



4 TEST TYPES AND RESULTS

4.1 CONDUCTED EMISSION MEASUREMENT

4.1.1 LIMITS OF CONDUCTED EMISSION MEASUREMENT

FREQUENCY OF EMISSION (MHz)	CONDUCTED LIMIT (dB μ V)	
	Quasi-peak	Average
0.15-0.5	66 to 56	56 to 46
0.5-5	56	46
5-30	60	50

NOTE:

1. The lower limit shall apply at the transition frequencies.
2. All emanations from a class B digital device or system, including any network of conductors and apparatus connected thereto, shall not exceed the level of field strengths specified above.

4.1.2 TEST INSTRUMENTS

DESCRIPTION & MANUFACTURER	MODEL NO.	SERIAL NO.	CALIBRATED UNTIL
ROHDE & SCHWARZ Test Receiver	ESCS 30	847124/029	Dec. 04, 2004
ROHDE & SCHWARZ LISN (for EUT)	ESHS-Z5	848773/004	Nov. 04, 2004
KYORITSU LISN (for peripheral)	KNW-407	8/1395/12	Jul. 27, 2004
RF Cable (JETBAO)	RG233/U	Cable_CA_01	Jul. 03, 2004
Terminator(for KYORITSU)	50	3	Apr. 11, 2004
Software	Cond-V2e	NA	NA

- NOTE: 1. The calibration interval of the above test instruments is 12 months and the calibrations are traceable to NML/ROC and NIST/USA.
 2. The test was performed in ADT Shielded Room No. A.
 3. The VCCI Con A Registration No. is C-817.

3. TEST PROCEDURES

- The EUT was placed 0.4 meters from the conducting wall of the shielded room with EUT being connected to the power mains through a line impedance stabilization network (LISN). Other support units were connected to the power mains through another LISN. The two LISNs provide 50 ohm/ 50uH of coupling impedance for the measuring instrument.
- Both lines of the power mains connected to the EUT were checked for maximum conducted interference.
- The frequency range from 150 kHz to 30 MHz was searched. Emission levels over 10dB under the prescribed limits could not be reported

4.1.3 TEST SETUP

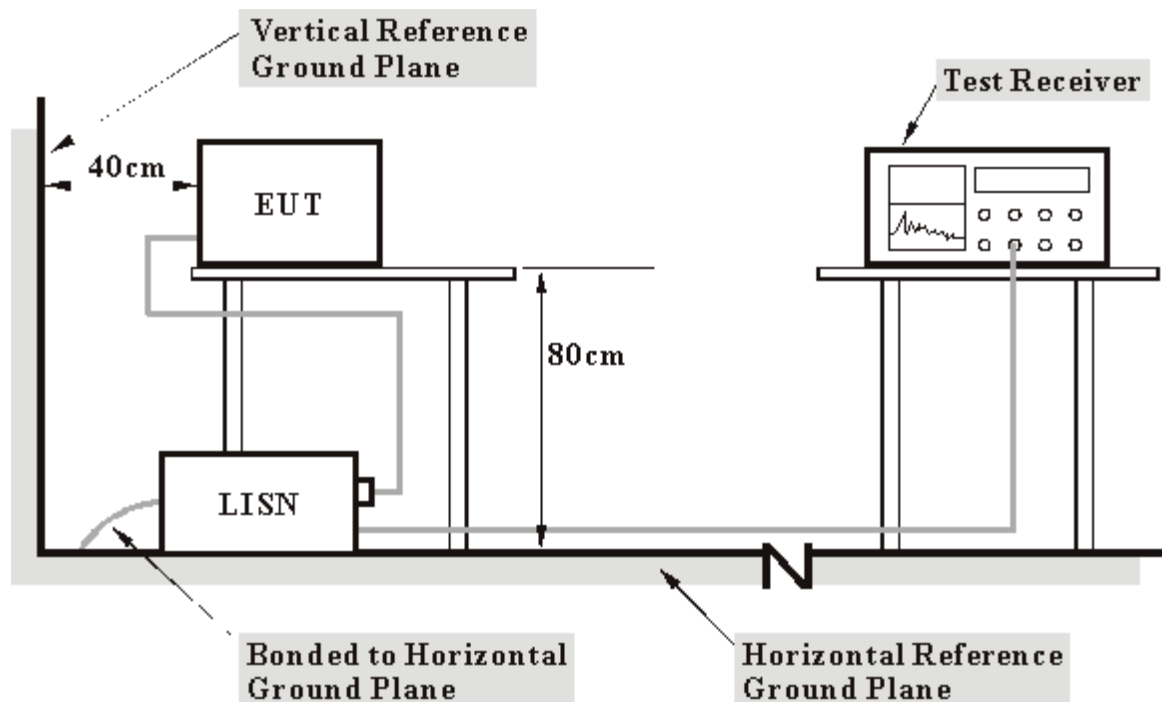

- Note:**
- Support units were connected to second LISN.
 - Both of LISNs (AMN) 80 cm from EUT and at the least 80 cm from other units and other metal planes support units.

For the actual test configuration, please refer to the related item – Photographs of the Test Configuration.



4.1.4 EUT OPERATING CONDITIONS

- a. The support unit 1 (Notebook computer) ran a test program "Prism Engineering Toll Ver 1:4:46" to enable EUT under transmission condition continuously at specific channel frequency.
- b. Notebook computer sends "H" messages to modem.
- c. Notebook computer sends "H" messages to printer, and the printer prints them on paper.



4.1.5 TEST RESULTS

EUT	IEEE 802.11b/g 54Mbps WLAN USB2.0 Adapter		
MODEL	XG-702B		
MODE	Channel 11	6dB BANDWIDTH	9 kHz
INPUT POWER (SYSTEM)	120Vac, 60 Hz	PHASE	Line (L)
ENVIRONMENTAL CONDITIONS	25 deg. C, 58 %RH 971 hPa	TESTED BY	Eric Lee

No	Freq. [MHz]	Corr. Factor (dB)	Reading Value [dB (uV)]		Emission Level [dB (uV)]		Limit [dB (uV)]		Margin (dB)	
			Q.P.	AV.	Q.P.	AV.	Q.P.	AV.	Q.P.	AV.
1	0.177	0.20	49.79	-	49.99	-	64.61	54.61	-14.62	-
2	0.474	0.21	34.64	-	34.85	-	56.44	46.44	-21.59	-
3	1.720	0.30	27.85	-	27.35	-	56.00	46.00	-28.65	-
4	5.105	0.47	29.28	-	29.75	-	60.00	50.00	-30.25	-
5	22.719	1.21	27.52	-	28.73	-	60.00	50.00	-31.27	-
6	26.609	1.30	33.68	-	34.98	-	60.00	50.00	-25.02	-

- NOTES:** (1) "": Undetectable
 (2) Q.P. and AV. are abbreviations of quasi-peak and average.
 (3) "-": The Quasi-peak reading value also meets an average limit, thus measurement with the average detector is unnecessary.
 (4) The emission levels of other frequencies were very low against the limit.
 (5) Correction Factor = Insertion loss + Cable loss
 (6) Margin value = Emission level - Limit value

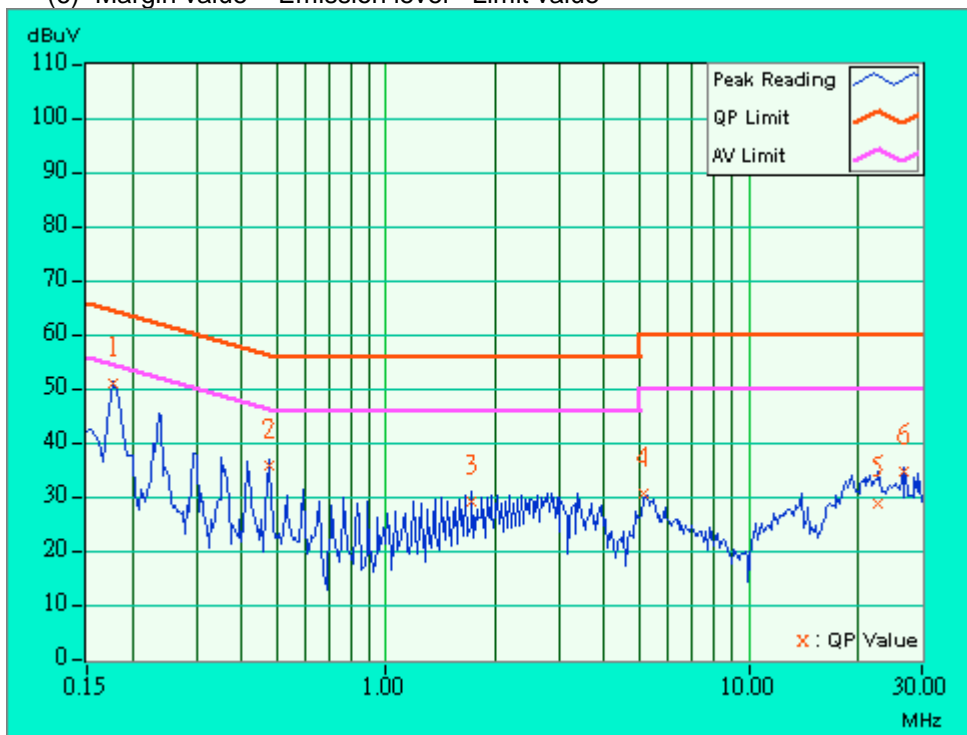



EUT	IEEE 802.11b/g 54Mbps WLAN USB2.0 Adapter		
MODEL	XG-702B		
MODE	Channel 11	6dB BANDWIDTH	9 kHz
INPUT POWER (SYSTEM)	120Vac, 60 Hz	PHASE	Neutral (N)
ENVIRONMENTAL CONDITIONS	25 deg. C, 58 %RH 971 hPa	TESTED BY	Eric Lee

No	Freq. [MHz]	Corr. Factor (dB)	Reading Value [dB (uV)]		Emission Level [dB (uV)]		Limit [dB (uV)]		Margin (dB)	
			Q.P.	AV.	Q.P.	AV.	Q.P.	AV.	Q.P.	AV.
1	0.200	0.20	44.53	-	44.73	-	63.62	53.62	-18.89	-
2	0.200	0.20	44.29	-	44.49	-	63.60	53.60	-19.11	-
3	0.853	0.28	35.29	-	35.57	-	56.00	46.00	-20.43	-
4	2.912	0.35	37.04	-	37.39	-	56.00	46.00	-18.61	-
5	5.852	0.49	36.06	-	36.55	-	60.00	50.00	-23.45	-
6	11.539	0.79	29.94	-	30.73	-	60.00	50.00	-29.27	-

- NOTES:** (1) "**": Undetectable
 (2) Q.P. and AV. are abbreviations of quasi-peak and average.
 (3) "-": The Quasi-peak reading value also meets an average limit, thus measurement with the average detector is unnecessary.
 (4) The emission levels of other frequencies were very low against the limit.
 (5) Correction Factor = Insertion loss + Cable loss
 (6) Margin value = Emission level - Limit value

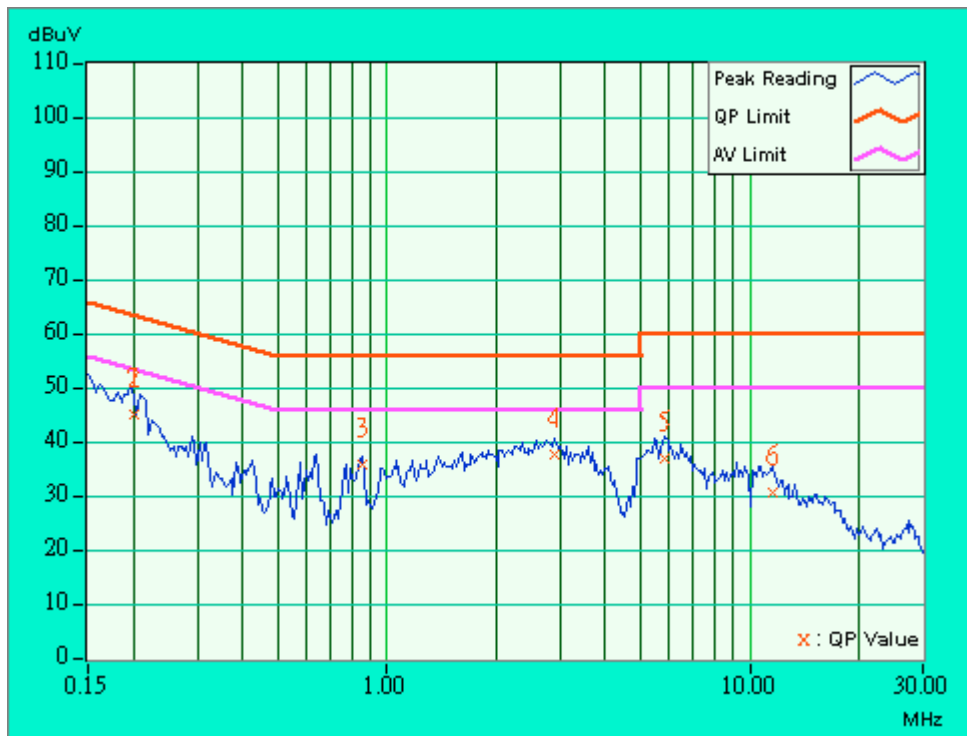



4.2 RADIATED EMISSION MEASUREMENT

4.2.1 LIMITS OF RADIATED EMISSION MEASUREMENT

Field strength limits are at the distance of 3 meters, emissions radiated outside of the specified bands, shall be according to the general radiated limits in 15.209 as following:

Frequencies (MHz)	Field strength (microvolts/meter)	Measurement distance (meters)
0.009-0.490	2400/F(kHz)	300
0.490-1.705	24000/F(kHz)	30
1.705-30.0	30	30
30-88	100	3
88-216	150	3
216-960	200	3
Above 960	500	3

NOTE:

1. The lower limit shall apply at the transition frequencies.
2. Emission level (dBuV/m) = 20 log Emission level (uV/m).
3. As shown in 15.35(b), for frequencies above 1000MHz, the field strength limits are based on average detector, however, the peak field strength of any emission shall not exceed the maximum permitted average limits, specified above by more than 20dB under any condition of modulation.



4.2.2 TEST INSTRUMENTS

DESCRIPTION & MANUFACTURER	MODEL NO.	SERIAL NO.	CALIBRATED UNTIL
HP Spectrum Analyzer	8594ER	3829U04676	Aug. 30, 2004
ADVANTEST Spectrum Analyzer	R3271A	85060311	Jun. 16, 2004
CHASE RF Pre_Amplifier	CPA9232	1057	May. 10, 2004
HP Pre_Amplifier	8449B	3008A01922	Oct. 13, 2004
ROHDE & SCHWARZ Test Receiver	ESVS 10	849231 /019	Sep. 30, 2004
CHASE Broadband Antenna	CBL6111c	2730	Jul 30, 2004
Schwarzbeck Horn_Antenna	3115	5619	Jul. 17, 2004
Schwarzbeck Horn_Antenna	BBHA 9170	BBHA9170192	Feb. 16, 2005
SCHWARZBECK Tunable Dipole Antenna	UHAP	897	Mar. 07, 2005
SCHWARZBECK Tunable Dipole Antenna	VHAP	880	Mar. 07, 2005
RF Switches (ARNITSU)	CS-201	1565157	Dec. 01, 2004
RF CABLE (Chaintek) 1GHz-20GHz	SF102	22054-2	Feb. 10. 2004
RF Cable(RICHTEC)	9913-30M	STCCAB-30M- 1GHz-021	Dec. 01, 2004
Software	AS60P8	NA	NA
CHANCE MOST Antenna Tower	AT-100	0203	NA
CHANCE MOST Turn Table	TT-100	0203	NA

Note: 1. The calibration interval of the above test instruments is 12 months (36 months for Tunable Dipole Antenna) and the calibrations are traceable to NML/ROC and NIST/USA.

2. * = These equipment are used for the final measurement.
3. The horn antenna and HP preamplifier (model: 8449B) are used only for the measurement of emission frequency above 1GHz if tested.
4. The test was performed in ADT Open Site No. C.
5. The FCC Site Registration No. is 656396.
6. The VCCI Site Registration No. is R-1626.
7. The CANADA Site Registration No. is IC 4284-3.



4.2.3 TEST PROCEDURES

- a. The EUT was placed on the top of a rotating table 0.8 meters above the ground at a 10 meter open area test site. The table was rotated 360 degrees to determine the position of the highest radiation.
- b. The EUT was set 3 meters away from the interference-receiving antenna, which was mounted on the top of a variable-height antenna tower.
- c. The antenna is a broadband antenna, and its height is varied from one meter to four meters above the ground to determine the maximum value of the field strength. Both horizontal and vertical polarizations of the antenna are set to make the measurement.
- d. For each suspected emission, the EUT was arranged to its worst case and then the antenna was tuned to heights from 1 meter to 4 meters and the rotatable table was turned from 0 degrees to 360 degrees to find the maximum reading.
- e. The test-receiver system was set to Peak Detect Function and Specified Bandwidth with Maximum Hold Mode.
- f. If the emission level of the EUT in peak mode was 10 dB lower than the limit specified, then testing could be stopped and the peak values of the EUT would be reported. Otherwise the emissions that did not have 10 dB margin would be re-tested one by one using peak, quasi-peak or average method as specified and then reported in a data sheet.

NOTE:

1. The resolution bandwidth and video bandwidth of test receiver/spectrum analyzer is 120kHz for Peak detection (PK) and Quasi-peak detection (QP) at frequency below 1GHz.
2. The resolution bandwidth and video bandwidth of test receiver/spectrum analyzer is 1 MHz for Peak detection at frequency above 1GHz.
3. The resolution bandwidth of test receiver/spectrum analyzer is 1 MHz and the video bandwidth is 300 Hz for Average detection (AV) at frequency above 1GHz.

4.2.4 TEST SETUP

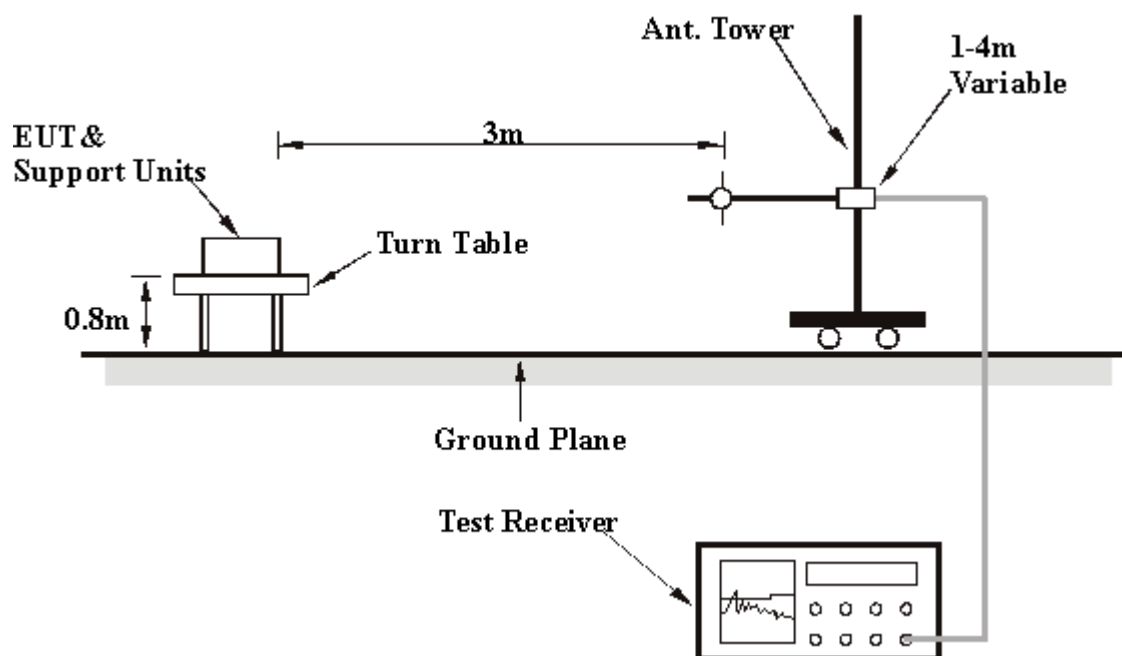

For the actual test configuration, please refer to the related item – Photographs of the Test Configuration.

4.2.5 EUT OPERATING CONDITIONS

Same as 4.1.5.



4.2.6 TEST RESULTS

EUT	IEEE 802.11b/g 54Mbps WLAN USB2.0 Adapter		
MODEL	XG-702B		
MODE	Channel 11	FREQUENCY RANGE	30-1000 MHz
INPUT POWER (SYSTEM)	120Vac, 60 Hz	DETECTOR FUNCTION	Quasi-Peak
ENVIRONMENTAL CONDITIONS	27 deg. C, 46 %RH, 971 hPa	TESTED BY	Eric Lee

ANTENNA POLARITY & TEST DISTANCE: HORIZONTAL AT 3 M

No.	Freq. (MHz)	Emission Level (dBuV/m)	Limit (dBuV/m)	Margin (dB)	Antenna Height (m)	Table Angle (Degree)	Raw Value (dBuV)	Correction Factor (dB/m)
1	240.00	32.40 QP	46.00	-13.60	1.27 H	262	19.60	12.80
2	360.00	32.00 QP	46.00	-14.00	1.00 H	244	15.00	16.90
3	440.00	35.30 QP	46.00	-10.70	1.00 H	275	16.20	19.10
4	480.00	37.40 QP	46.00	-8.60	1.00 H	260	17.10	20.30
5	520.00	34.40 QP	46.00	-11.60	1.00 H	321	13.10	21.30
6	600.00	34.80 QP	46.00	-11.20	1.49 H	58	11.90	23.00
7	659.99	32.40 QP	46.00	-13.60	1.33 H	320	8.30	24.10
8	719.99	39.60 QP	46.00	-6.40	1.14 H	327	14.80	24.80
9	791.99	35.30 QP	46.00	-10.70	1.00 H	2	9.20	26.10

ANTENNA POLARITY & TEST DISTANCE: VERTICAL AT 3 M

No.	Freq. (MHz)	Emission Level (dBuV/m)	Limit (dBuV/m)	Margin (dB)	Antenna Height (m)	Table Angle (Degree)	Raw Value (dBuV)	Correction Factor (dB/m)
1	200.00	31.80 QP	43.50	-11.70	1.00 V	99	20.60	11.20
2	240.00	35.00 QP	46.00	-11.00	1.04 V	138	22.10	12.80
3	360.00	29.70 QP	46.00	-16.30	1.44 V	22	12.80	16.90
4	420.00	32.70 QP	46.00	-13.30	1.23 V	20	14.10	18.60
5	440.00	33.20 QP	46.00	-12.80	1.00 V	48	14.10	19.10
6	480.00	37.10 QP	46.00	-8.90	1.00 V	37	16.80	20.30
7	520.00	34.30 QP	46.00	-11.70	1.00 V	337	13.00	21.30
8	720.00	32.80 QP	46.00	-13.20	1.05 V	244	8.00	24.80

- REMARKS:**
1. Emission level(dBuV/m)=Raw Value(dBuV) + Correction Factor(dB)
 2. Correction Factor(dB/m) = Antenna Factor (dB/m) + Cable Factor (dB)
 3. The other emission levels were very low against the limit.
 4. Margin value = Emission level – Limit value.



4.2.7 TEST RESULTS - DSSS

EUT	IEEE 802.11b/g 54Mbps WLAN USB2.0 Adapter		
MODEL	XG-702B		
MODE	Channel 1	FREQUENCY RANGE	1000~25000MHz
INPUT POWER (SYSTEM)	120Vac, 60 Hz	DETECTOR FUNCTION	Peak(PK) Average(AV)
ENVIRONMENTAL CONDITIONS	25 deg. C, 60%RH, 971 hPa	TESTED BY	Eric Lee

ANTENNA POLARITY & TEST DISTANCE: HORIZONTAL AT 3 M

No.	Freq. (MHz)	Emission Level (dBuV/m)	Limit (dBuV/m)	Margin (dB)	Antenna Height (m)	Table Angle (Degree)	Raw Value (dBuV)	Correction Factor (dB/m)
1	2375.00	44.40 PK	74.00	-29.60	1.13 H	352	14.00	30.40
2	2390.00	43.70 PK	74.00	-30.30	1.07 H	354	13.20	30.40
3	*2412.00	100.80 PK			1.07 H	354	70.20	30.50
3	*2412.00	94.30 AV			1.07 H	354	63.80	30.50
4	4824.00	44.90 PK	74.00	-29.10	1.28 H	40	8.60	36.20
5	7236.00	47.80 PK	74.00	-26.20	1.13 H	354	6.10	41.70
6	9648.00	52.40 PK	74.00	-21.60	1.10 H	352	7.50	44.90
6	9648.00	40.80 AV	54.00	-13.20	1.10 H	352	-4.10	44.90

ANTENNA POLARITY & TEST DISTANCE: VERTICAL AT 3 M

No.	Freq. (MHz)	Emission Level (dBuV/m)	Limit (dBuV/m)	Margin (dB)	Antenna Height (m)	Table Angle (Degree)	Raw Value (dBuV)	Correction Factor (dB/m)
1	2375.00	50.50 PK	74.00	-23.50	1.22 V	23	20.10	30.40
2	2390.00	50.20 PK	74.00	-23.80	1.14 V	0	19.80	30.40
3	*2412.00	107.40 PK			1.14 V	0	76.90	30.50
3	*2412.00	100.40 AV			1.14 V	0	69.90	30.50
4	4824.00	47.50 PK	74.00	-26.50	1.12 V	356	11.30	36.20
5	7236.00	47.80 PK	74.00	-26.20	1.21 V	20	6.10	41.70
6	9648.00	53.40 PK	74.00	-20.60	1.20 V	55	8.50	44.90
6	9648.00	42.40 AV	54.00	-11.60	1.20 V	55	-2.50	44.90

- REMARKS:**
1. Emission level(dBuV/m)=Raw Value(dBuV) + Correction Factor(dB)
 2. Correction Factor(dB/m) = Antenna Factor (dB/m) + Cable Factor (dB)
 3. The other emission levels were very low against the limit.
 4. Margin value = Emission level – Limit value.
 5. The limit value is defined as per 15.247
 6. " * " : Fundamental frequency



EUT	IEEE 802.11b/g 54Mbps WLAN USB2.0 Adapter		
MODEL	XG-702B		
MODE	Channel 6	FREQUENCY RANGE	1000~25000MHz
INPUT POWER (SYSTEM)	120Vac, 60 Hz	DETECTOR FUNCTION	Peak(PK) Average (AV)
ENVIRONMENTAL CONDITIONS	25 deg. C, 60%RH, 971 hPa	TESTED BY	Eric Lee

ANTENNA POLARITY & TEST DISTANCE: HORIZONTAL AT 3 M

No.	Freq. (MHz)	Emission Level (dBuV/m)	Limit (dBuV/m)	Margin (dB)	Antenna Height (m)	Table Angle (Degree)	Raw Value (dBuV)	Correction Factor (dB/m)
1	*2437.00	100.90 PK			1.16 H	322	70.20	30.70
1	*2437.00	94.50 AV			1.16 H	322	63.80	30.70
2	4874.00	45.20 PK	74.00	-28.80	1.55 H	48	8.70	36.50
3	7311.00	47.70 PK	74.00	-26.30	1.18 H	300	5.90	41.80
4	9748.00	51.30 PK	74.00	-22.70	1.15 H	346	6.60	44.60
4	9748.00	40.30 AV	54.00	-13.70	1.15 H	346	-4.40	44.60

ANTENNA POLARITY & TEST DISTANCE: VERTICAL AT 3 M

No.	Freq. (MHz)	Emission Level (dBuV/m)	Limit (dBuV/m)	Margin (dB)	Antenna Height (m)	Table Angle (Degree)	Raw Value (dBuV)	Correction Factor (dB/m)
1	*2437.00	107.50 PK			1.19 V	1	76.80	30.70
1	*2437.00	101.60 AV			1.19 V	1	70.90	30.70
2	4874.00	47.50 PK	74.00	-26.50	1.21 V	9	11.00	36.50
3	7311.00	51.00 PK	74.00	-23.00	1.20 V	5	9.20	41.80
3	7311.00	40.10 AV	54.00	-13.90	1.20 V	5	-1.70	41.80
4	9748.00	54.30 PK	74.00	-19.70	1.22 V	42	9.70	44.60
4	9748.00	43.60 AV	54.00	-10.40	1.22 V	42	-1.00	44.60

- REMARKS:**
1. Emission level(dBuV/m)=Raw Value(dBuV) + Correction Factor(dB)
 2. Correction Factor(dB/m) = Antenna Factor (dB/m) + Cable Factor (dB)
 3. The other emission levels were very low against the limit.
 4. Margin value = Emission level – Limit value.
 5. The limit value is defined as per 15.247
 6. “ * “ : Fundamental frequency



EUT	IEEE 802.11b/g 54Mbps WLAN USB2.0 Adapter		
MODEL	XG-702B		
MODE	Channel 11	FREQUENCY RANGE	1000~25000MHz
INPUT POWER (SYSTEM)	120Vac, 60 Hz	DETECTOR FUNCTION	Peak(PK) Average (AV)
ENVIRONMENTAL CONDITIONS	25 deg. C, 60%RH, 971 hPa	TESTED BY	Eric Lee

ANTENNA POLARITY & TEST DISTANCE: HORIZONTAL AT 3 M

No.	Freq. (MHz)	Emission Level (dBuV/m)	Limit (dBuV/m)	Margin (dB)	Antenna Height (m)	Table Angle (Degree)	Raw Value (dBuV)	Correction Factor (dB/m)
1	*2462.00	102.10 PK			1.05 H	7	71.30	30.80
1	*2462.00	94.60 AV			1.05 H	7	63.80	30.80
2	2483.50	44.50 PK	74.00	-29.50	1.05 H	7	13.50	31.00
3	2498.00	45.10 PK	74.00	-28.90	1.07 H	10	14.30	30.70
4	4924.00	45.00 PK	74.00	-29.00	1.09 H	22	8.30	36.70
5	7386.00	48.90 PK	74.00	-25.10	1.06 H	13	7.00	41.80
6	9848.00	51.80 PK	74.00	-22.20	1.10 H	22	7.40	44.40
6	9848.00	40.00 AV	54.00	-14.00	1.10 H	22	-4.30	44.40

ANTENNA POLARITY & TEST DISTANCE: VERTICAL AT 3 M

No.	Freq. (MHz)	Emission Level (dBuV/m)	Limit (dBuV/m)	Margin (dB)	Antenna Height (m)	Table Angle (Degree)	Raw Value (dBuV)	Correction Factor (dB/m)
1	*2462.00	108.90 PK			1.13 V	358	78.10	30.80
1	*2462.00	101.70 AV			1.13 V	358	70.90	30.80
2	2483.50	51.30 PK	74.00	-22.70	1.13 V	358	20.30	31.00
2	2483.50	44.10 AV	54.00	-9.90	1.13 V	358	13.10	31.00
3	2498.00	52.20 PK	74.00	-21.80	1.10 V	358	21.40	30.70
3	2498.00	41.70 AV	54.00	-12.30	1.10 V	358	11.00	30.70
4	4924.00	47.90 PK	74.00	-26.10	1.08 V	0	11.20	36.70
5	7386.00	50.60 PK	74.00	-23.40	1.12 V	360	8.80	41.80
6	9848.00	54.70 PK	74.00	-19.30	1.10 V	345	10.30	44.40
6	9848.00	43.20 AV	54.00	-10.80	1.10 V	345	-1.10	44.40

- REMARKS:**
1. Emission level(dBuV/m)=Raw Value(dBuV) + Correction Factor(dB)
 2. Correction Factor(dB/m) = Antenna Factor (dB/m) + Cable Factor (dB)
 3. The other emission levels were very low against the limit.
 4. Margin value = Emission level – Limit value.
 5. The limit value is defined as per 15.247
 6. " * " : Fundamental frequency



4.2.8 TEST RESULTS -OFDM

EUT	IEEE 802.11b/g 54Mbps WLAN USB2.0 Adapter		
MODEL	XG-702B		
MODE	Channel 1	FREQUENCY RANGE	1000~25000MHz
INPUT POWER (SYSTEM)	120Vac, 60 Hz	DETECTOR FUNCTION	Peak(PK) Average(AV)
ENVIRONMENTAL CONDITIONS	25 deg. C, 60%RH, 971 hPa	TESTED BY	Eric Lee

ANTENNA POLARITY & TEST DISTANCE: HORIZONTAL AT 3 M

No.	Freq. (MHz)	Emission Level (dBuV/m)	Limit (dBuV/m)	Margin (dB)	Antenna Height (m)	Table Angle (Degree)	Raw Value (dBuV)	Correction Factor (dB/m)
1	2375.00	44.00 PK	74.00	-30.00	1.12 H	349	13.60	30.40
2	2390.00	48.60 PK	74.00	-25.40	1.08 H	3	18.20	30.40
3	*2412.00	98.40 PK			1.08 H	3	67.90	30.50
3	*2412.00	90.40 AV			1.08 H	3	59.90	30.50
4	4824.00	44.80 PK	74.00	-29.20	1.16 H	32	8.60	36.20
5	7236.00	49.10 PK	74.00	-24.90	1.12 H	356	7.40	41.70
6	9648.00	51.70 PK	74.00	-22.30	1.10 H	350	6.80	44.90
6	9648.00	40.40 AV	54.00	-13.60	1.10 H	350	-4.50	44.90

ANTENNA POLARITY & TEST DISTANCE: VERTICAL AT 3 M

No.	Freq. (MHz)	Emission Level (dBuV/m)	Limit (dBuV/m)	Margin (dB)	Antenna Height (m)	Table Angle (Degree)	Raw Value (dBuV)	Correction Factor (dB/m)
1	2375.00	47.70 PK	74.00	-26.30	1.17 V	58	17.30	30.40
2	2390.00	55.40 PK	74.00	-18.60	1.00 V	131	25.00	30.40
2	2390.00	47.20 AV	54.00	-6.80	1.00 V	131	16.80	30.40
3	*2412.00	104.20 PK			1.00 V	131	73.60	30.50
3	*2412.00	96.00 AV			1.00 V	131	65.50	30.50
4	4824.00	46.70 PK	74.00	-27.30	1.16 V	338	10.50	36.20
5	7236.00	48.80 PK	74.00	-25.20	1.12 V	50	7.10	41.70
6	9648.00	53.00 PK	74.00	-21.00	1.23 V	46	8.10	44.90
6	9648.00	42.40 AV	54.00	-11.60	1.23 V	46	-2.50	44.90

- REMARKS:**
1. Emission level(dBuV/m)=Raw Value(dBuV) + Correction Factor(dB)
 2. Correction Factor(dB/m) = Antenna Factor (dB/m) + Cable Factor (dB)
 3. The other emission levels were very low against the limit.
 4. Margin value = Emission level – Limit value.
 5. The limit value is defined as per 15.247
 6. “ * “ : Fundamental frequency



EUT	IEEE 802.11b/g 54Mbps WLAN USB2.0 Adapter		
MODEL	XG-702B		
MODE	Channel 6	FREQUENCY RANGE	1000~25000MHz
INPUT POWER (SYSTEM)	120Vac, 60 Hz	DETECTOR FUNCTION	Peak(PK) Average (AV)
ENVIRONMENTAL CONDITIONS	25 deg. C, 60%RH, 971 hPa	TESTED BY	Eric Lee

ANTENNA POLARITY & TEST DISTANCE: HORIZONTAL AT 3 M

No.	Freq. (MHz)	Emission Level (dBuV/m)	Limit (dBuV/m)	Margin (dB)	Antenna Height (m)	Table Angle (Degree)	Raw Value (dBuV)	Correction Factor (dB/m)
1	*2437.00	99.50 PK			1.36 H	2	68.80	30.70
1	*2437.00	91.40 AV			1.36 H	2	60.70	30.70
2	4874.00	44.80 PK	74.00	-29.20	1.55 H	48	8.40	36.50
3	7311.00	48.70 PK	74.00	-25.30	1.52 H	50	6.90	41.80
4	9748.00	51.70 PK	74.00	-22.30	1.50 H	22	7.10	44.60
4	9748.00	40.30 AV	54.00	-13.70	1.50 H	22	-4.30	44.60

ANTENNA POLARITY & TEST DISTANCE: VERTICAL AT 3 M

No.	Freq. (MHz)	Emission Level (dBuV/m)	Limit (dBuV/m)	Margin (dB)	Antenna Height (m)	Table Angle (Degree)	Raw Value (dBuV)	Correction Factor (dB/m)
1	*2437.00	106.70 PK			1.00 V	22	76.10	30.70
1	*2437.00	98.10 AV			1.00 V	22	67.40	30.70
2	4874.00	46.40 PK	74.00	-27.60	1.56 V	0	10.00	36.50
3	7311.00	48.70 PK	74.00	-25.30	1.52 V	2	6.90	41.80
4	9748.00	52.30 PK	74.00	-21.70	1.50 V	66	7.60	44.60
4	9748.00	41.30 AV	54.00	-12.70	1.50 V	66	-3.30	44.60

- REMARKS:**
1. Emission level(dBuV/m)=Raw Value(dBuV) + Correction Factor(dB)
 2. Correction Factor(dB/m) = Antenna Factor (dB/m) + Cable Factor (dB)
 3. The other emission levels were very low against the limit.
 4. Margin value = Emission level – Limit value.
 5. The limit value is defined as per 15.247
 6. “ * “ : Fundamental frequency



EUT	IEEE 802.11b/g 54Mbps WLAN USB2.0 Adapter		
MODEL	XG-702B		
MODE	Channel 11	FREQUENCY RANGE	1000~25000MHz
INPUT POWER (SYSTEM)	120Vac, 60 Hz	DETECTOR FUNCTION	Peak(PK) Average (AV)
ENVIRONMENTAL CONDITIONS	25 deg. C, 60%RH, 971 hPa	TESTED BY	Eric Lee

ANTENNA POLARITY & TEST DISTANCE: HORIZONTAL AT 3 M

No.	Freq. (MHz)	Emission Level (dBuV/m)	Limit (dBuV/m)	Margin (dB)	Antenna Height (m)	Table Angle (Degree)	Raw Value (dBuV)	Correction Factor (dB/m)
1	*2462.00	99.60 PK			1.09 H	351	68.80	30.80
1	*2462.00	91.10 AV			1.09 H	351	60.30	30.80
2	2483.50	49.40 PK	74.00	-24.60	1.09 H	351	18.50	31.00
3	2498.00	47.60 PK	74.00	-26.40	1.06 H	354	16.90	30.70
4	4924.00	44.80 PK	74.00	-29.20	1.22 H	26	8.20	36.70
5	7386.00	49.20 PK	74.00	-24.80	1.05 H	333	7.40	41.80
6	9848.00	51.30 PK	74.00	-22.70	1.02 H	358	7.00	44.40
6	9848.00	40.30 AV	54.00	-13.70	1.02 H	358	-4.00	44.40

ANTENNA POLARITY & TEST DISTANCE: VERTICAL AT 3 M

No.	Freq. (MHz)	Emission Level (dBuV/m)	Limit (dBuV/m)	Margin (dB)	Antenna Height (m)	Table Angle (Degree)	Raw Value (dBuV)	Correction Factor (dB/m)
1	*2462.00	103.00 PK			1.13 V	52	72.10	30.80
1	*2462.00	94.60 AV			1.13 V	52	63.80	30.80
2	2483.50	52.80 PK	74.00	-21.20	1.13 V	52	21.80	31.00
2	2483.50	44.50 AV	54.00	-9.50	1.13 V	52	13.50	31.00
3	2498.00	52.70 PK	74.00	-21.30	1.00 V	23	21.90	30.70
3	2498.00	43.20 AV	54.00	-10.80	1.00 V	23	12.50	30.70
4	4924.00	48.30 PK	74.00	-25.70	1.22 V	0	11.60	36.70
5	7386.00	49.50 PK	74.00	-24.50	1.02 V	25	7.70	41.80
6	9848.00	53.00 PK	74.00	-21.00	1.05 V	33	8.60	44.40
6	9848.00	42.60 AV	54.00	-11.40	1.05 V	33	-1.70	44.40

- REMARKS:**
1. Emission level(dBuV/m)=Raw Value(dBuV) + Correction Factor(dB)
 2. Correction Factor(dB/m) = Antenna Factor (dB/m) + Cable Factor (dB)
 3. The other emission levels were very low against the limit.
 4. Margin value = Emission level – Limit value.
 5. The limit value is defined as per 15.247
 6. “ * “ : Fundamental frequency



4.3 6dB BANDWIDTH MEASUREMENT

4.3.1 LIMITS OF 6dB BANDWIDTH MEASUREMENT

The minimum of 6dB Bandwidth Measurement is 0.5 MHz.

4.3.2 TEST INSTRUMENTS

Description & Manufacturer	Model No.	Serial No.	Calibrated Until
R&S SPECTRUM ANALYZER	FSP40	100037	May. 06, 2004

NOTE:

- 1.The measurement uncertainty is less than +/- 2.6dB, which is calculated as per the NAMAS document NIS81.
- 2.The calibration interval of the above test instruments is 12 months and the calibrations are traceable to NML/ROC and NIST/USA.

4.3.3 TEST PROCEDURE

The transmitter output was connected to the spectrum analyzer through an attenuator. The bandwidth of the fundamental frequency was measured by spectrum analyzer with 100 kHz RBW and 100 kHz VBW. The 6 dB bandwidth is defined as the total spectrum the power of which is higher than peak power minus 6 dB.

4.3.4 TEST SETUP



For the actual test configuration, please refer to the related Item – Photographs of the Test Configuration.

4.3.5 EUT OPERATING CONDITIONS

The software provided by client to enable the EUT under transmission condition continuously at lowest, middle and highest channel frequencies individually.



4.3.6 TEST RESULTS-DSSS

EUT	IEEE 802.11b/g 54Mbps WLAN USB2.0 Adapter		
MODEL	XG-702B	ENVIRONMENTAL CONDITIONS	21 deg. C, 60%RH, 971 hPa
INPUT POWER (SYSTEM)	120Vac, 60 Hz	TESTED BY	Eric Lee

CHANNEL	CHANNEL FREQUENCY (MHz)	6 dB BANDWIDTH (MHz)	MINIMUM LIMIT (MHz)	PASS/FAIL
1	2412	11.55	0.5	PASS
6	2437	11.55	0.5	PASS
11	2462	11.55	0.5	PASS



CH1

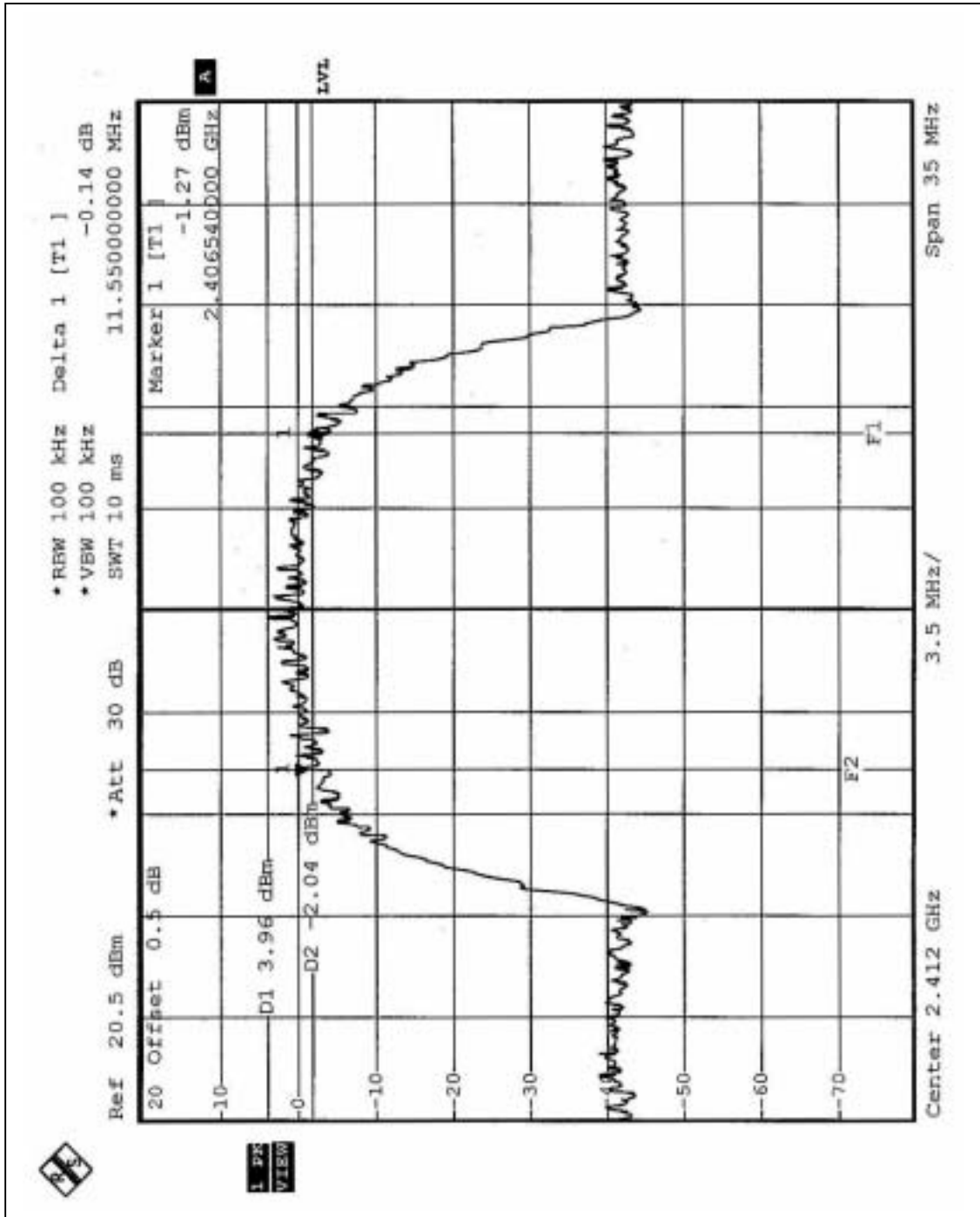



CH6

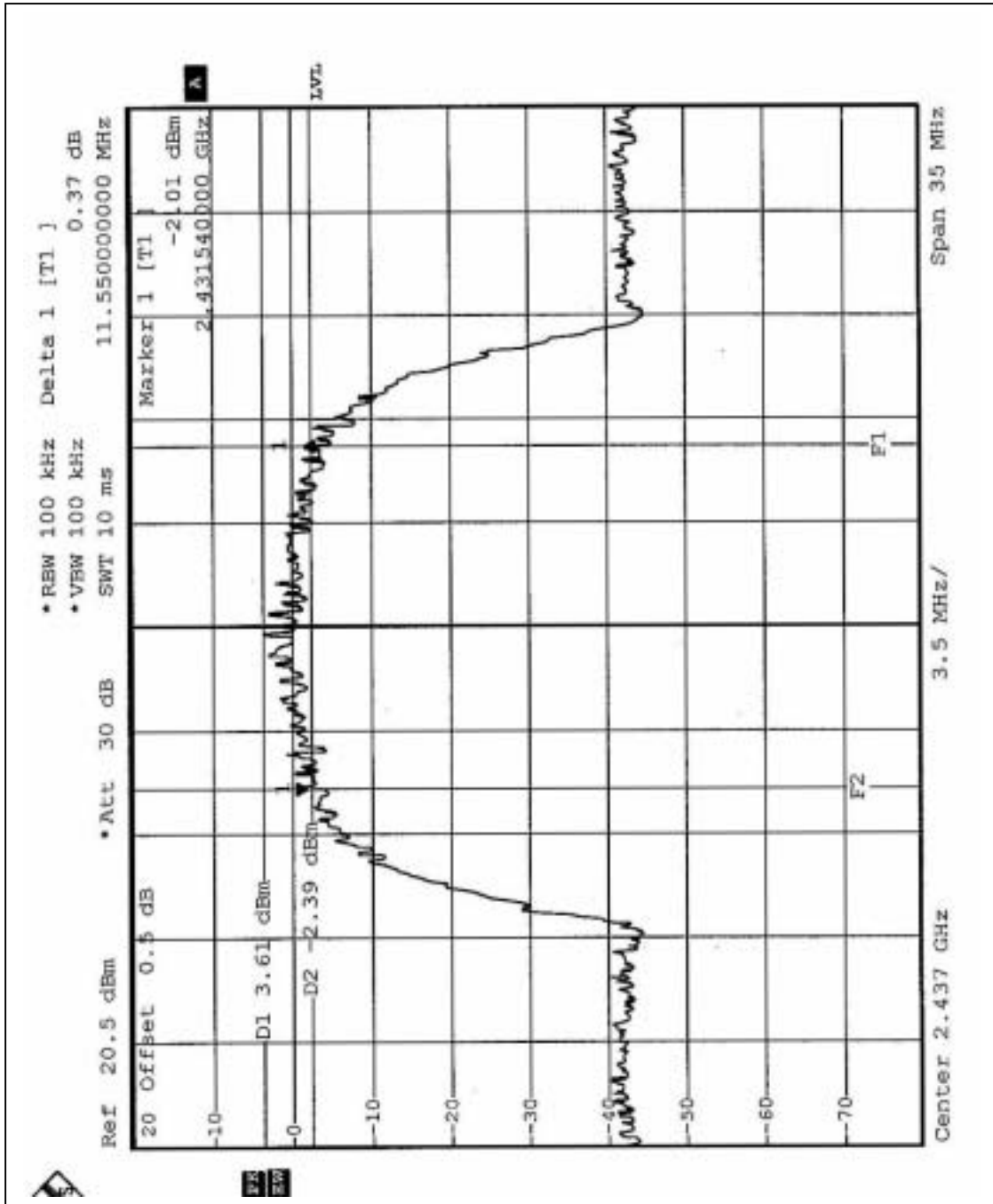



CH11

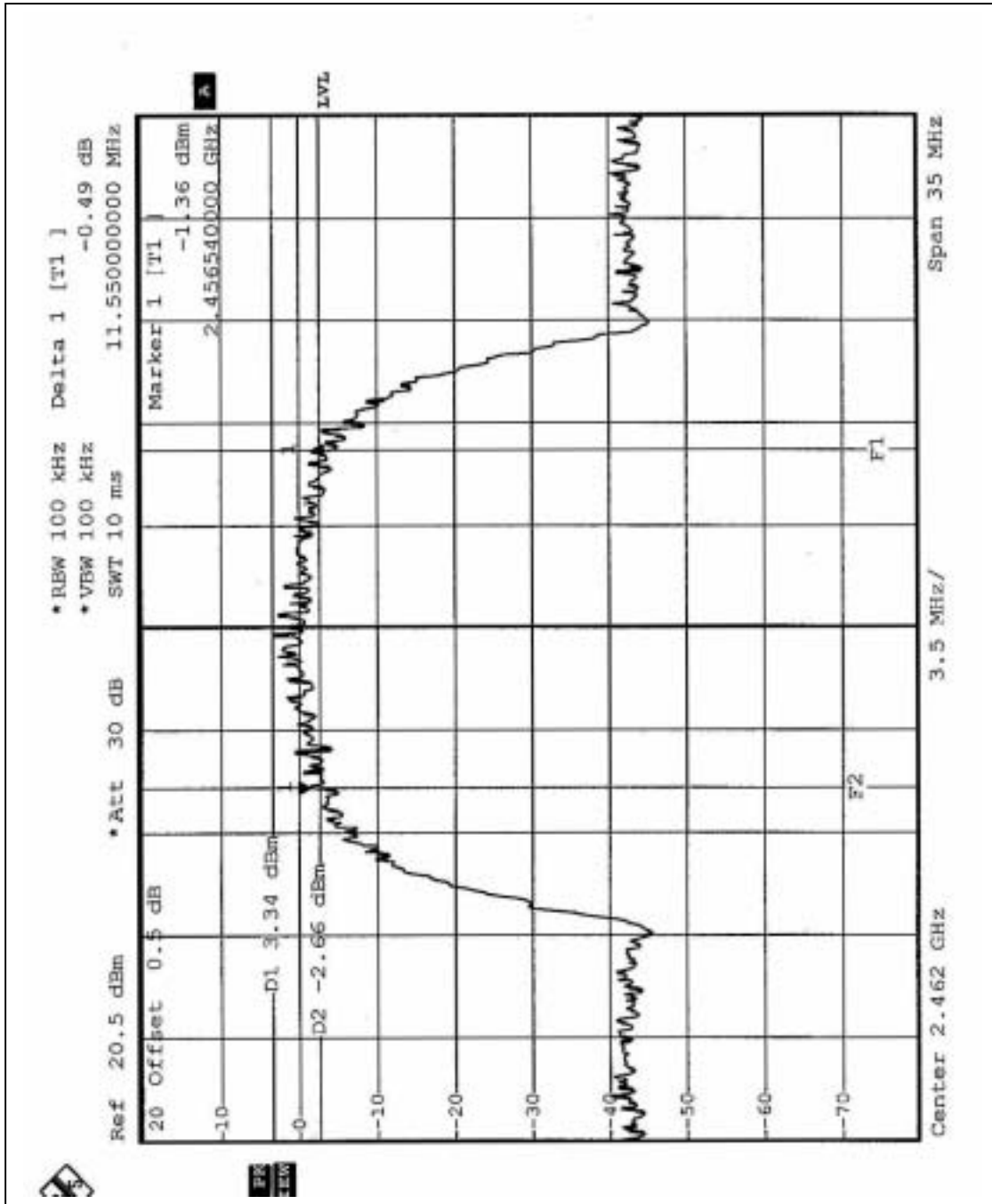



4.3.7 TEST RESULTS-OFDM

EUT	IEEE 802.11b/g 54Mbps WLAN USB2.0 Adapter		
MODEL	XG-702B	ENVIRONMENTAL CONDITIONS	21 deg. C, 60%RH, 971 hPa
INPUT POWER (SYSTEM)	120Vac, 60 Hz	TESTED BY	Eric Lee

CHANNEL	CHANNEL FREQUENCY (MHz)	6 dB BANDWIDTH (MHz)	MINIMUM LIMIT (MHz)	PASS/FAIL
1	2412	16.45	0.5	PASS
6	2437	16.38	0.5	PASS
11	2462	16.38	0.5	PASS



CH1

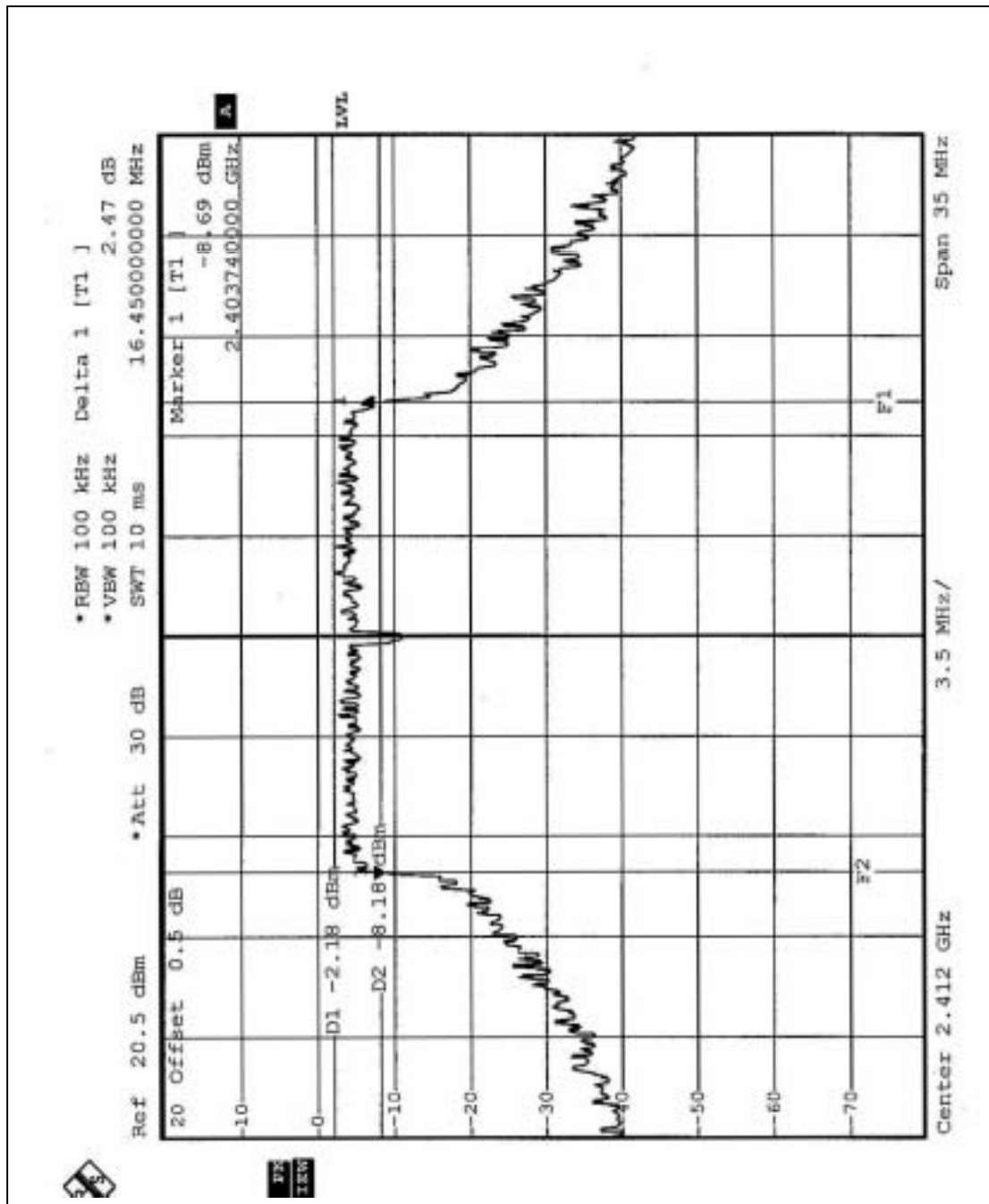



CH6

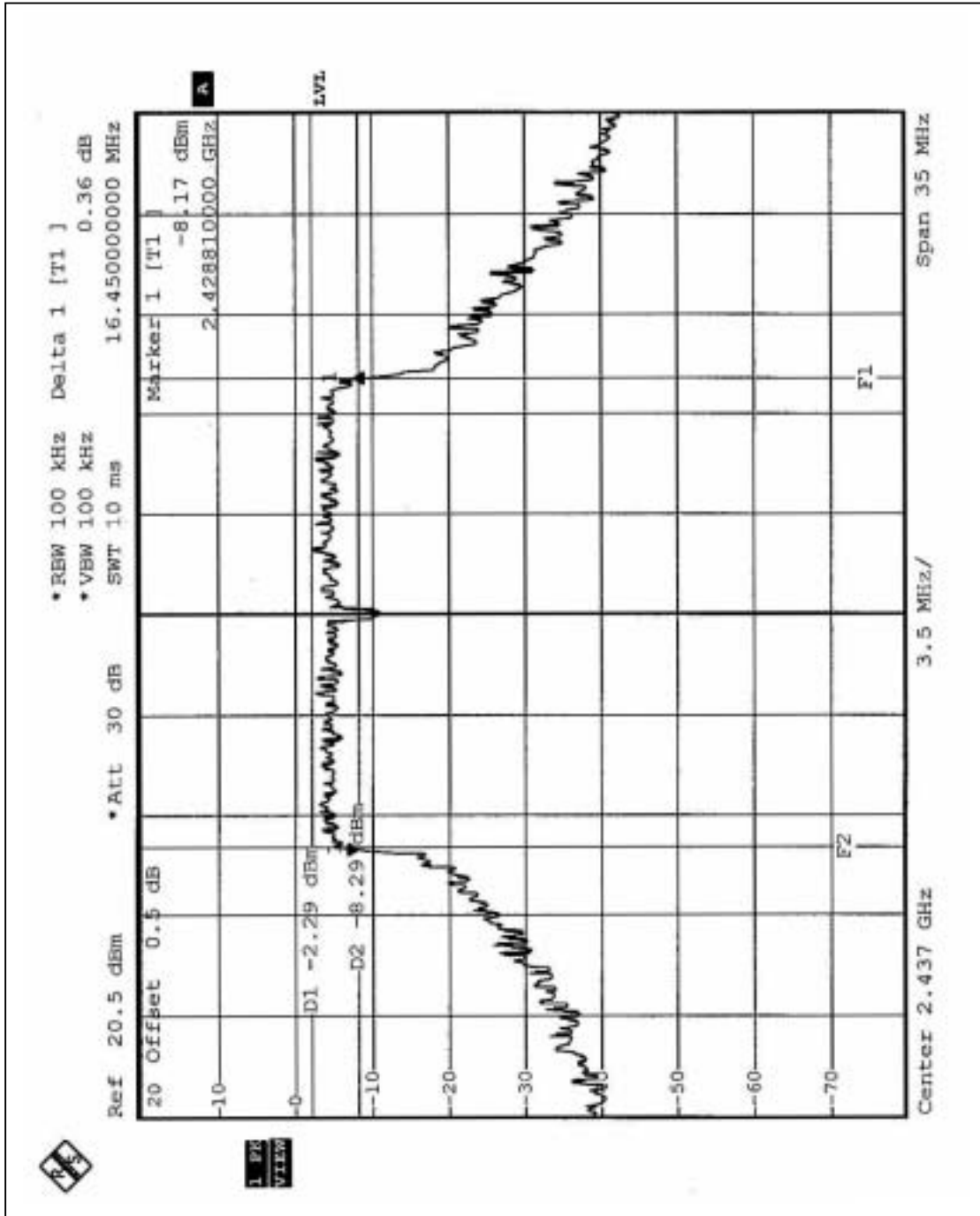



CH11

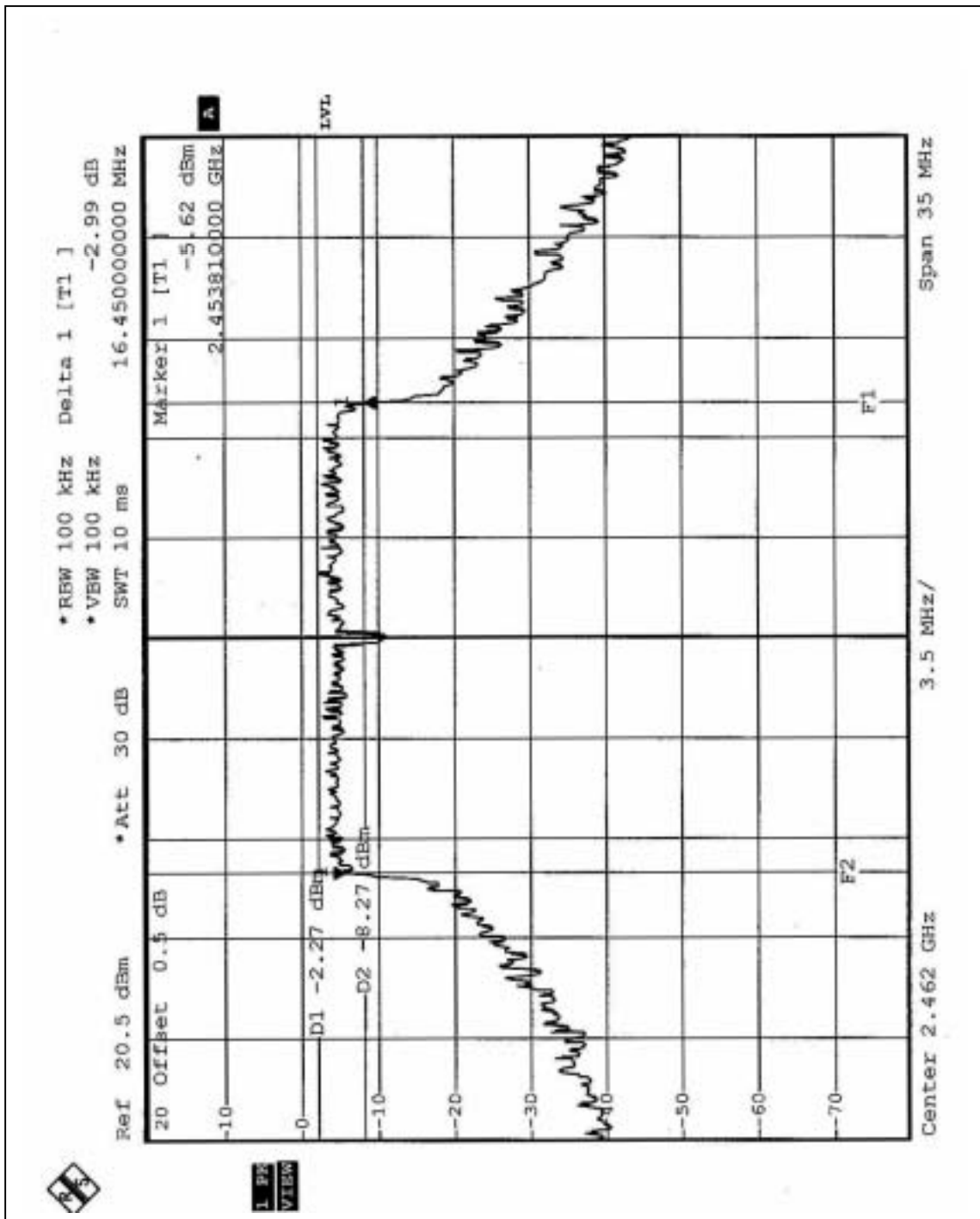



4.4 MAXIMUM PEAK OUTPUT POWER

4.4.1 LIMITS OF MAXIMUM PEAK OUTPUT POWER MEASUREMENT

The Maximum Peak Output Power Measurement is 30dBm.

4.4.2 TEST INSTRUMENTS

Description & Manufacturer	Model No.	Serial No.	Calibrated Until
R&S SPECTRUM ANALYZER	FSP40	100037	May. 06, 2004
R&S SIGNAL GENERATOR	SMP04	100011	May 28, 2004
TEKTRONIX OSCILLOSCOPE	TDS 220	B048470	Mar. 05, 2004
NARDA DETECTOR	4503A	FSCM99899	NA

NOTE:

The calibration interval of the above test instruments is 12 months and the calibrations are traceable to NML/ROC and NIST/USA.



4.4.3 TEST PROCEDURES

1. A detector was used on the output port of the EUT. An oscilloscope was used to read the peak response of the detector.
2. Replaced the EUT by the signal generator. The center frequency of the S.G was adjusted to the center frequency of the measured channel.
3. Adjusted the power to have the same peak reading on oscilloscope. Record the power level.

4.4.4 TEST SETUP

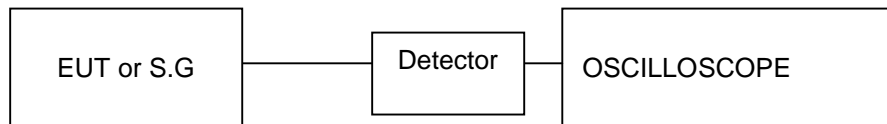

4.4.5 EUT OPERATING CONDITIONS

Same as Item 4.3.5



4.4.6 TEST RESULTS- DSSS

EUT	IEEE 802.11b/g 54Mbps WLAN USB2.0 Adapter		
MODEL	XG-702B	ENVIRONMENTAL CONDITIONS	21 deg. C, 60%RH, 971 hPa
INPUT POWER (SYSTEM)	120Vac, 60 Hz	TESTED BY	Eric Lee

CHANNEL	CHANNEL FREQUENCY (MHz)	PEAK POWER OUTPUT (dBm)	PEAK POWER LIMIT (dBm)	PASS/FAIL
1	2412	16.02	30	PASS
6	2437	16.20	30	PASS
11	2462	16.11	30	PASS

4.4.7 TEST RESULTS- OFDM

EUT	IEEE 802.11b/g 54Mbps WLAN USB2.0 Adapter		
MODEL	XG-702B	ENVIRONMENTAL CONDITIONS	21 deg. C, 60%RH, 971 hPa
INPUT POWER (SYSTEM)	120Vac, 60 Hz	TESTED BY	Eric Lee

CHANNEL	CHANNEL FREQUENCY (MHz)	PEAK POWER OUTPUT (dBm)	PEAK POWER LIMIT (dBm)	PASS/FAIL
1	2412	16.01	30	PASS
6	2437	16.18	30	PASS
11	2462	16.20	30	PASS



4.5 POWER SPECTRAL DENSITY MEASUREMENT

4.5.1 LIMITS OF POWER SPECTRAL DENSITY MEASUREMENT

The Maximum of Power Spectral Density Measurement is 8dBm.

4.5.2 TEST INSTRUMENTS

Description & Manufacturer	Model No.	Serial No.	Calibrated Until
R&S SPECTRUM ANALYZER	FSP40	100037	May. 06, 2004

NOTE:

- 1.The measurement uncertainty is less than +/- 2.6dB, which is calculated as per the NAMAS document NIS81.
- 2.The calibration interval of the above test instruments is 12 months and the calibrations are traceable to NML/ROC and NIST/USA.

4.5.3 TEST PROCEDURE

The transmitter output was connected to the spectrum analyzer through an attenuator, the bandwidth of the fundamental frequency was measured with the spectrum analyzer using 3 kHz RBW and 30 kHz VBW, set sweep time=span/3kHz. The power spectral density was measured and recorded. The sweep time is allowed to be longer than span/3KHz for a full response of the mixer in the spectrum analyzer.

4.5.4 TEST SETUP

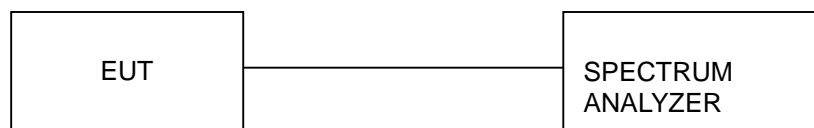

4.5.5 EUT OPERATING CONDITIONS

Same as 4.3.5



4.5.6 TEST RESULTS-DSSS

EUT	IEEE 802.11b/g 54Mbps WLAN USB2.0 Adapter		
MODEL	XG-702B	ENVIRONMENTAL CONDITIONS	21 deg. C, 60%RH, 971 hPa
INPUT POWER (SYSTEM)	120Vac, 60 Hz	TESTED BY	Eric Lee

CHANNEL NUMBER	CHANNEL FREQUENCY (MHz)	RF POWER LEVEL IN 3 KHz BW (dBm)	MAXIMUM LIMIT (dBm)	PASS/FAIL
1	2412	-10.34	8	PASS
6	2437	-10.34	8	PASS
11	2462	-10.42	8	PASS



CH1

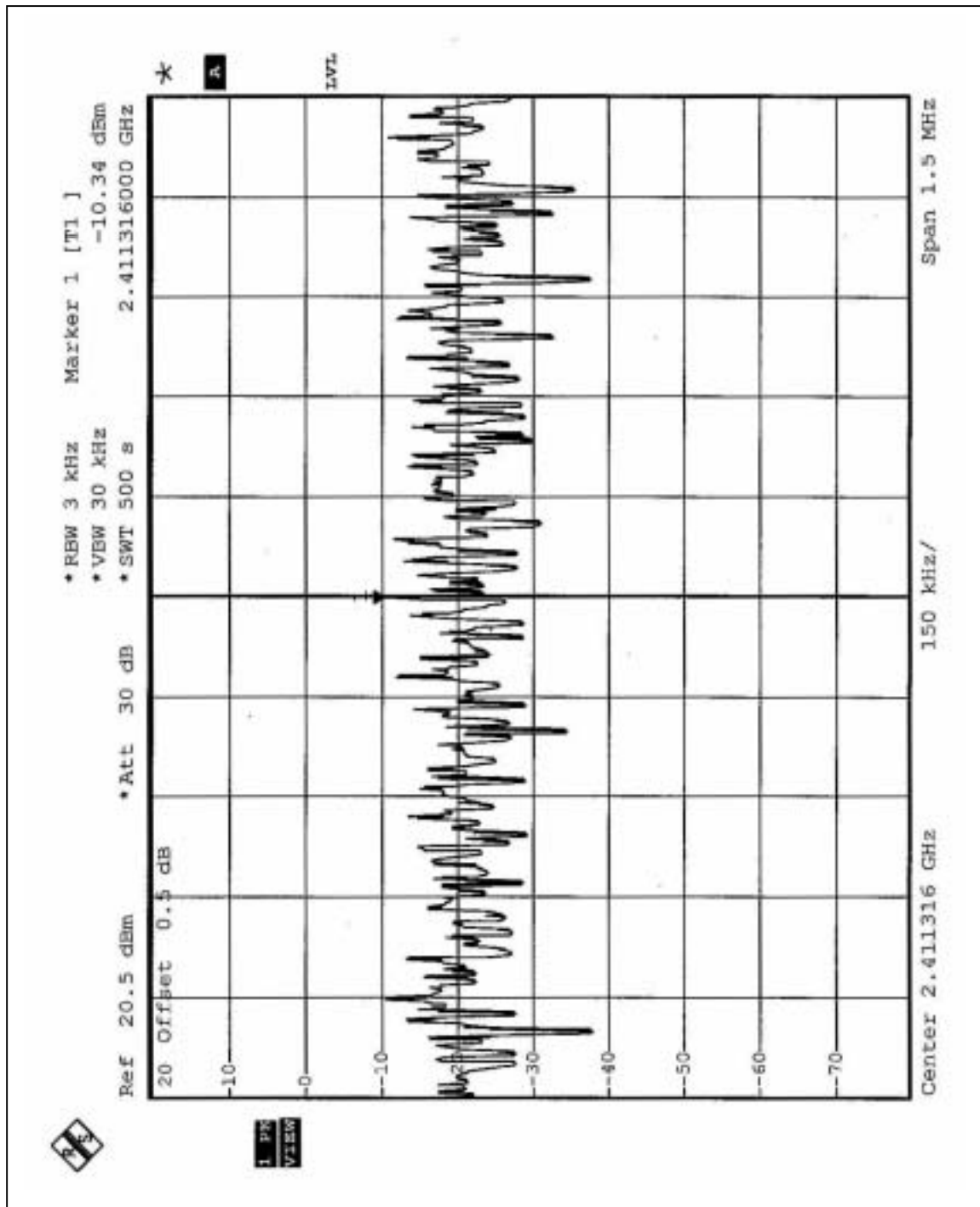



CH6

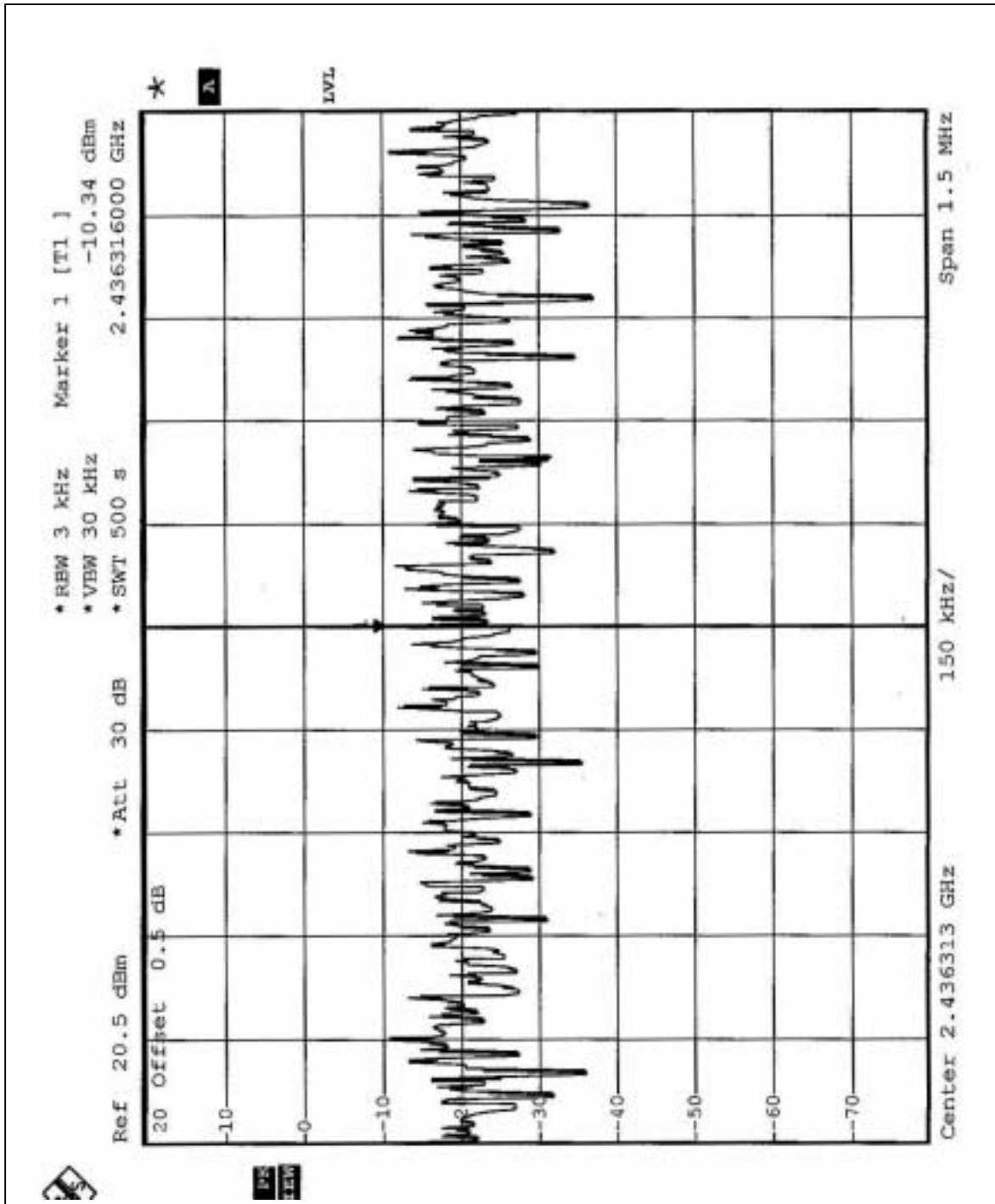



CH11

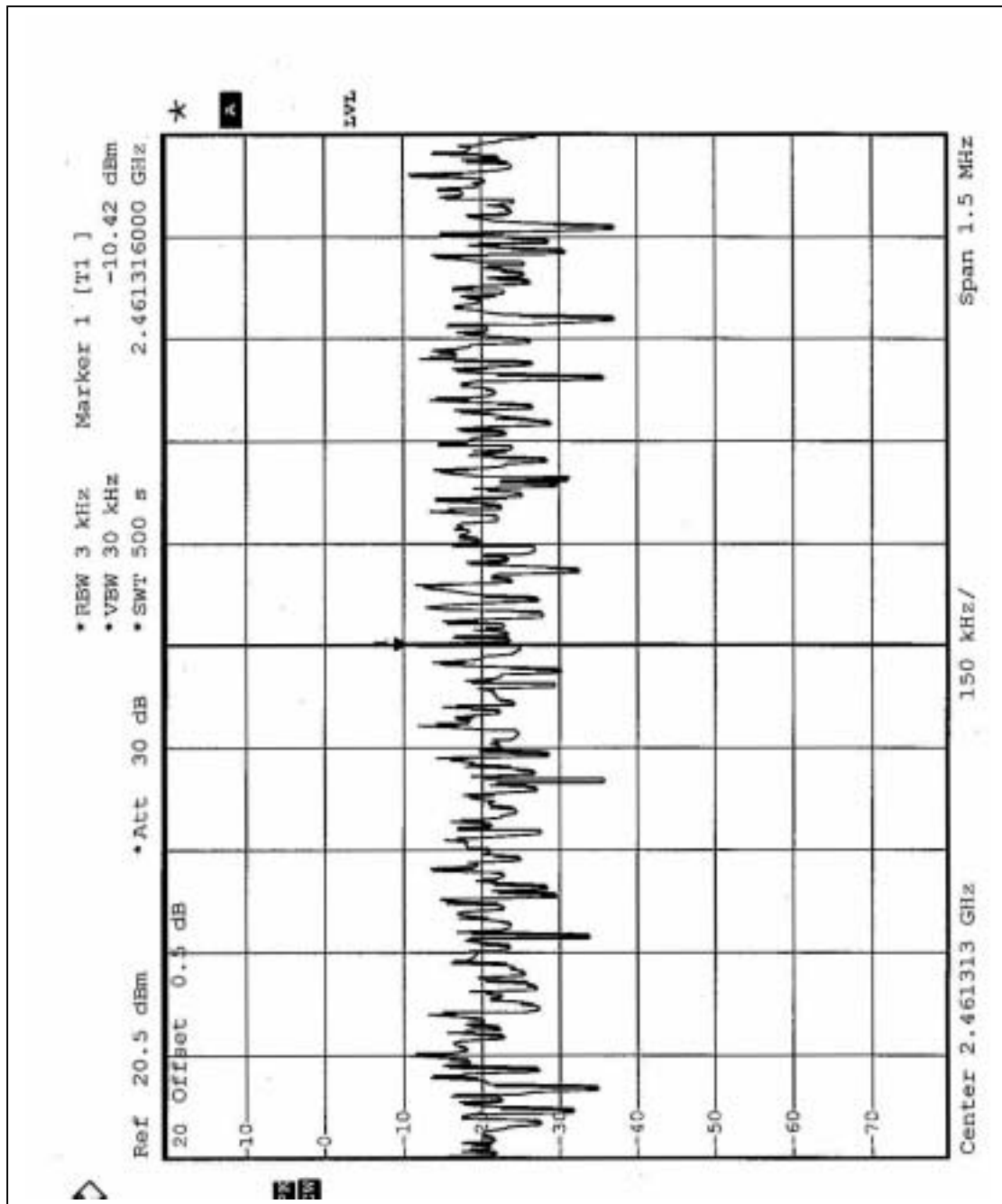



4.5.7 TEST RESULTS-OFDM

EUT	IEEE 802.11b/g 54Mbps WLAN USB2.0 Adapter		
MODEL	XG-702B	ENVIRONMENTAL CONDITIONS	21 deg. C, 60%RH, 971 hPa
INPUT POWER (SYSTEM)	120Vac, 60 Hz	TESTED BY	Eric Lee

CHANNEL NUMBER	CHANNEL FREQUENCY (MHz)	RF POWER LEVEL IN 3 KHz BW (dBm)	MAXIMUM LIMIT (dBm)	PASS/FAIL
1	2412	-16.77	8	PASS
6	2437	-16.80	8	PASS
11	2462	-16.86	8	PASS



CH1

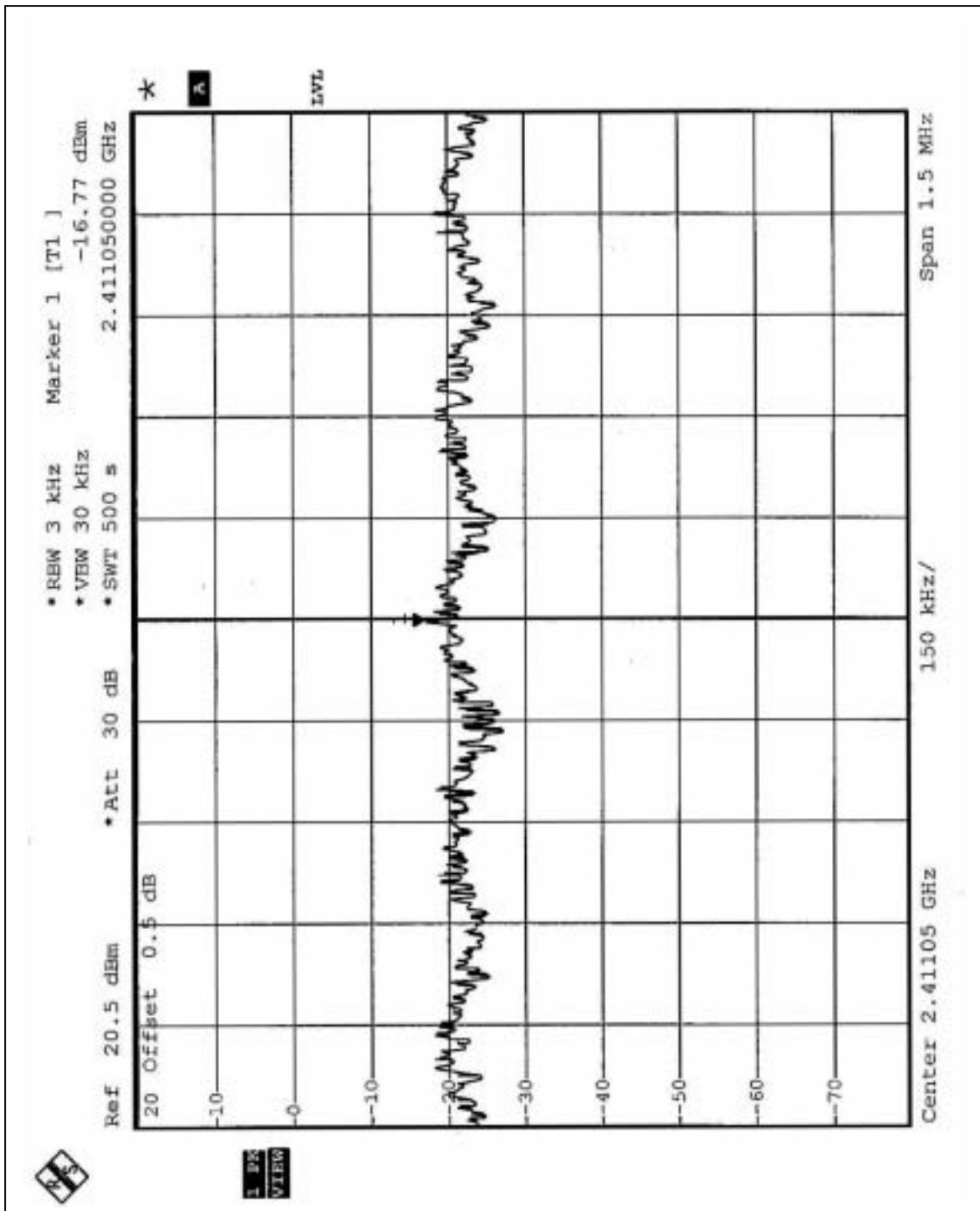



CH6

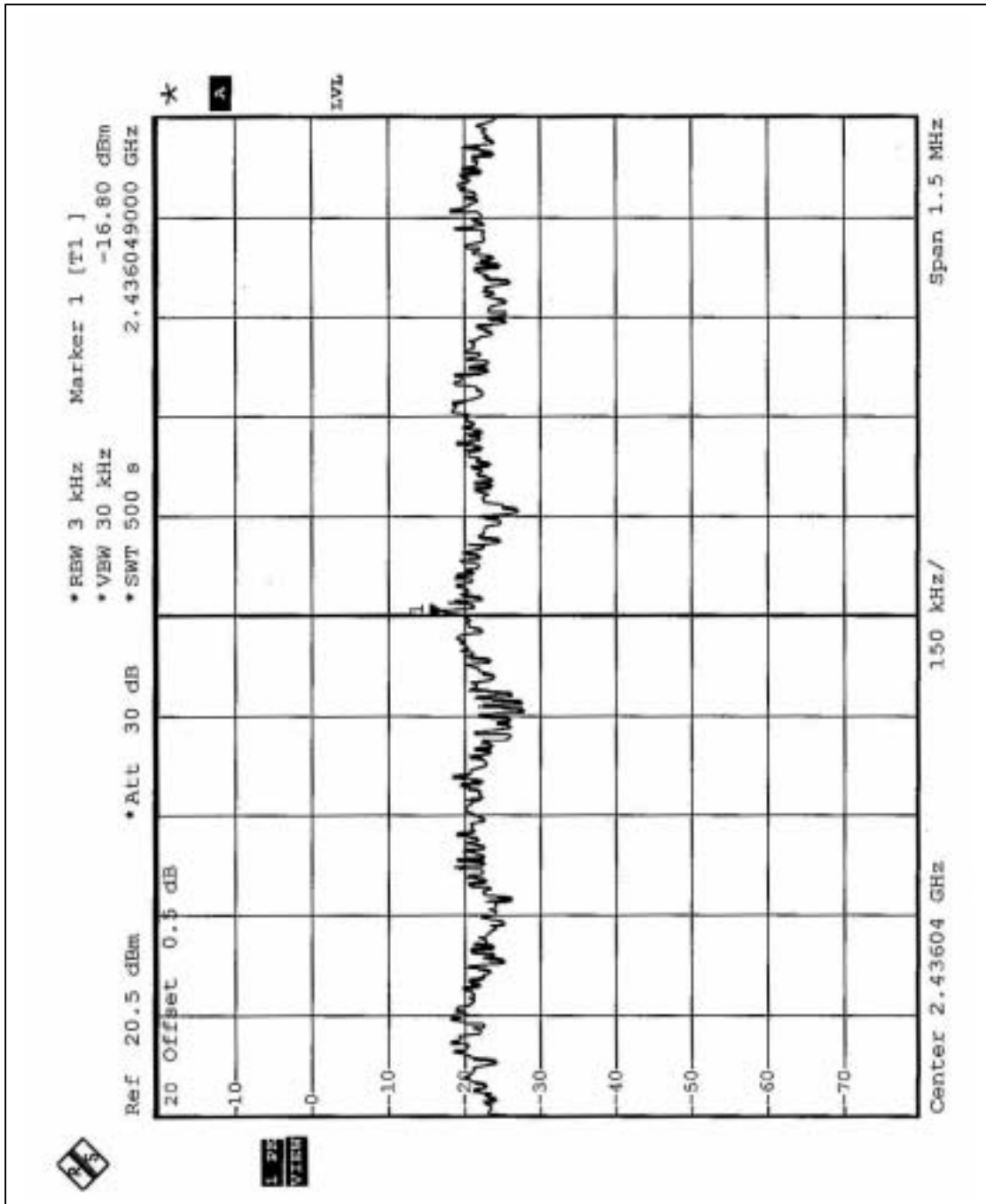



CH11

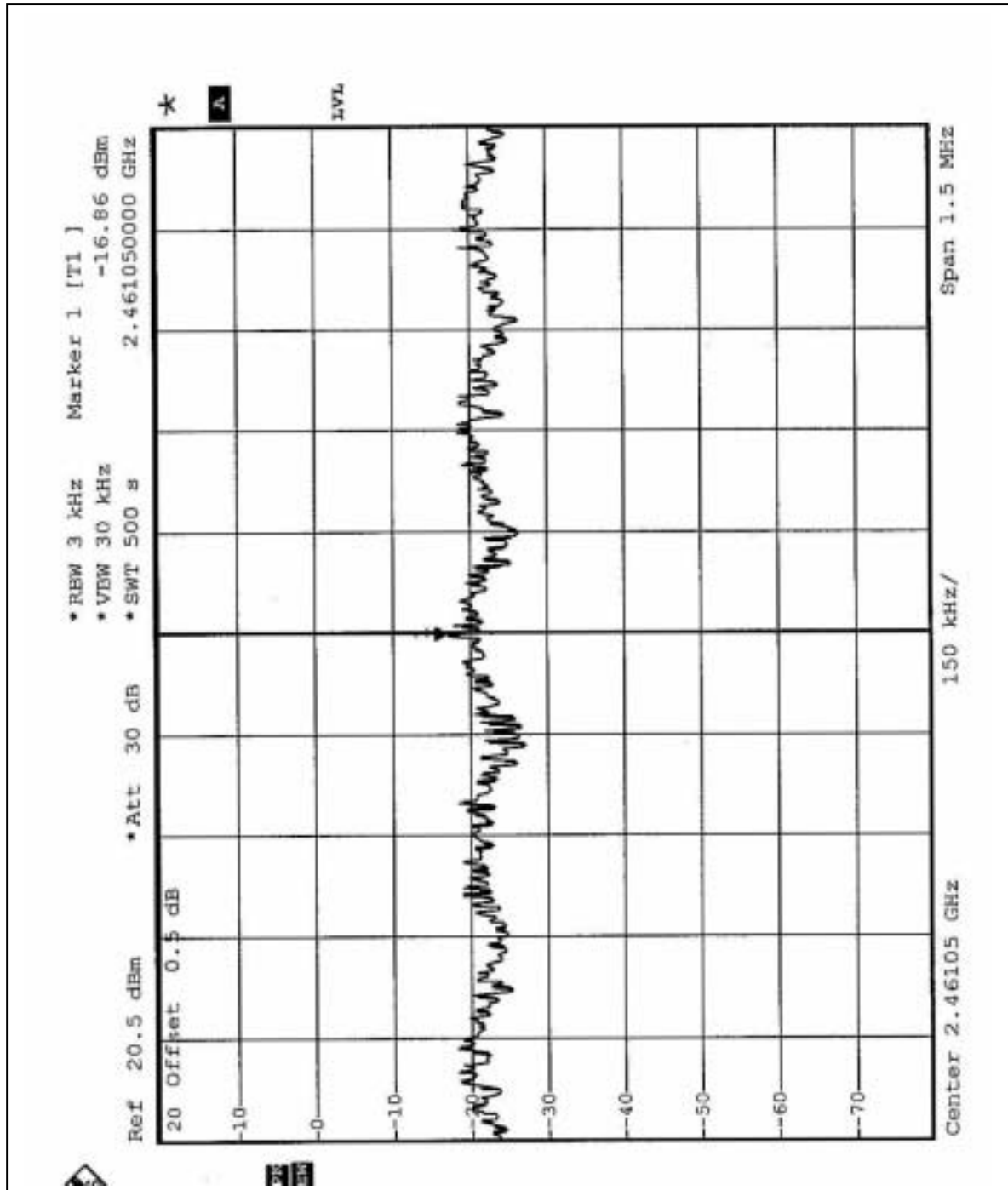



4.6 BAND EDGES MEASUREMENT

4.6.1 LIMITS OF BAND EDGES MEASUREMENT

Below -20dB of the highest emission level of operating band (in 100KHz Resolution Bandwidth).

4.6.2 TEST INSTRUMENTS

Description & Manufacturer	Model No.	Serial No.	Calibrated Until
R&S SPECTRUM ANALYZER	FSP40	100037	May. 06, 2004

NOTE:

- 1.The measurement uncertainty is less than $\pm 2.6\text{dB}$, which is calculated as per the NAMAS document NIS81.
- 2.The calibration interval of the above test instruments is 12 months and the calibrations are traceable to NML/ROC and NIST/USA.

4.6.3 TEST PROCEDURE

The transmitter output was connected to the spectrum analyzer via a low lose cable. Set both RBW and VBW of spectrum analyzer to 100 kHz with suitable frequency span including 100 kHz bandwidth from band edge. The band edges was measured and recorded.

4.6.4 EUT OPERATING CONDITION

Same as Item 4.3.5



4.6.5 TEST RESULTS - DSSS

The spectrum plots are attached on the following 2 pages. D1 line indicates the highest level, D2 line indicates the 20dB offset below D1. It shows compliance with the requirement in part 15.247(C).

Note - The delta method is only used up to 2 MHz away from the restricted bandage, The radiated emissions which located in other restricted frequency band, the result, please refer to 4.2.7.

NOTE (1): The band edge emission plot on the following first page shows 57.31dB delta between carrier maximum power and local maximum emission in restrict band (2.3900GHz). The emission of carrier strength list in the test result of channel 1 at the item 4.2.7 is 100.40dBuV/m, so the maximum field strength in restrict band is $100.40-57.31=43.09$ dBuV/m which is under 54 dBuV/m limit.

NOTE (2): The band edge emission plot on the following second page shows 56.79dB delta between carrier maximum power and local maximum emission in restrict band (2.4835GHz). The emission of carrier strength list in the test result of channel 11 at the item 4.2.7 is 101.70dBuV/m, so the maximum field strength in restrict band is $101.70-56.79=44.91$ dBuV/m which is under 54 dBuV/m limit.

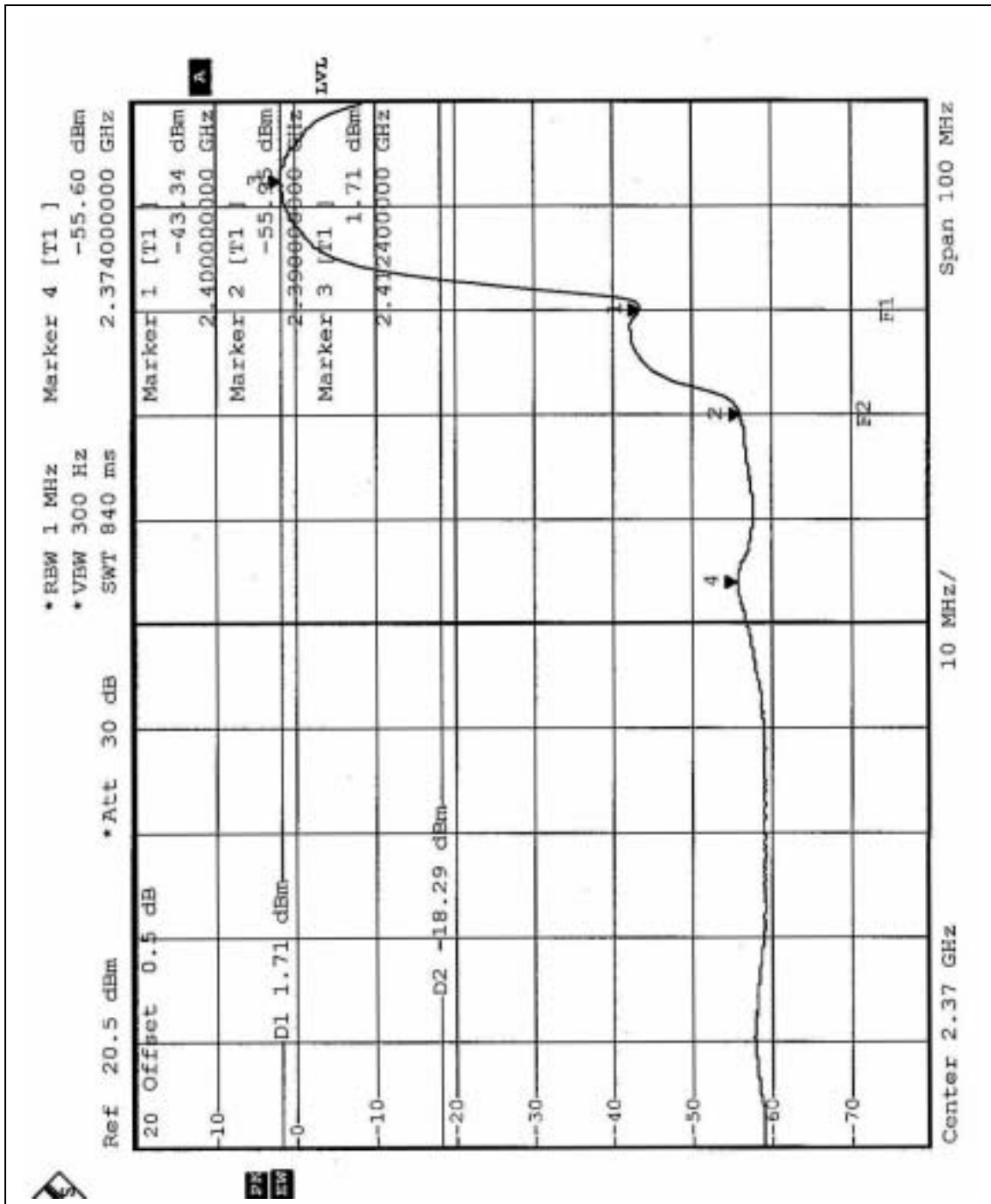

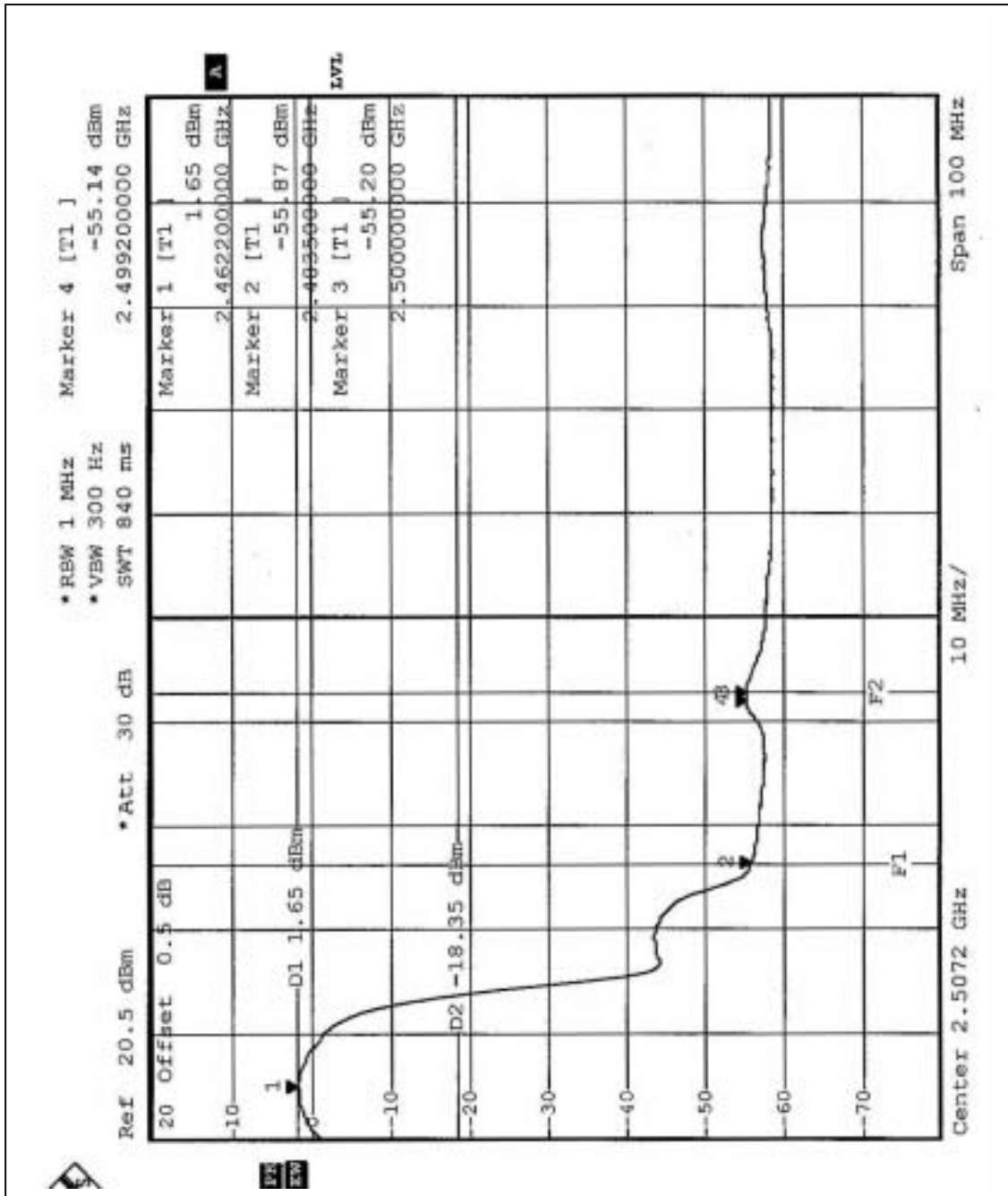



4.6.6 TEST RESULTS-OFDM

The spectrum plots are attached on the following 2 pages. D1 line indicates the highest level, D2 line indicates the 20dB offset below D1. It shows compliance with the requirement in part 15.247(C).

Note - The delta method is only used up to 2 MHz away from the restricted bandage, The radiated emissions which located in other restricted frequency band, the result, please refer to 4.2.8.

NOTE (1): The band edge emission plot on the following first page shows 50.43dB delta between carrier maximum power and local maximum emission in restrict band (2.390GHz). The emission of carrier strength list in the test result of channel 1 at the item 4.2.8 is 96.0dBuV/m, so the maximum field strength in restrict band is $96.0 - 50.43 = 45.57$ dBuV/m which is under 54 dBuV/m limit.

NOTE (2): The band edge emission plot on the following second page shows 50.74dB delta between carrier maximum power and local maximum emission in restrict band (2.4835GHz). The emission of carrier strength list in the test result of channel 11 at the item 4.2.8 is 94.60dBuV/m, so the maximum field strength in restrict band is $94.60 - 50.74 = 43.86$ dBuV/m which is under 54 dBuV/m limit.

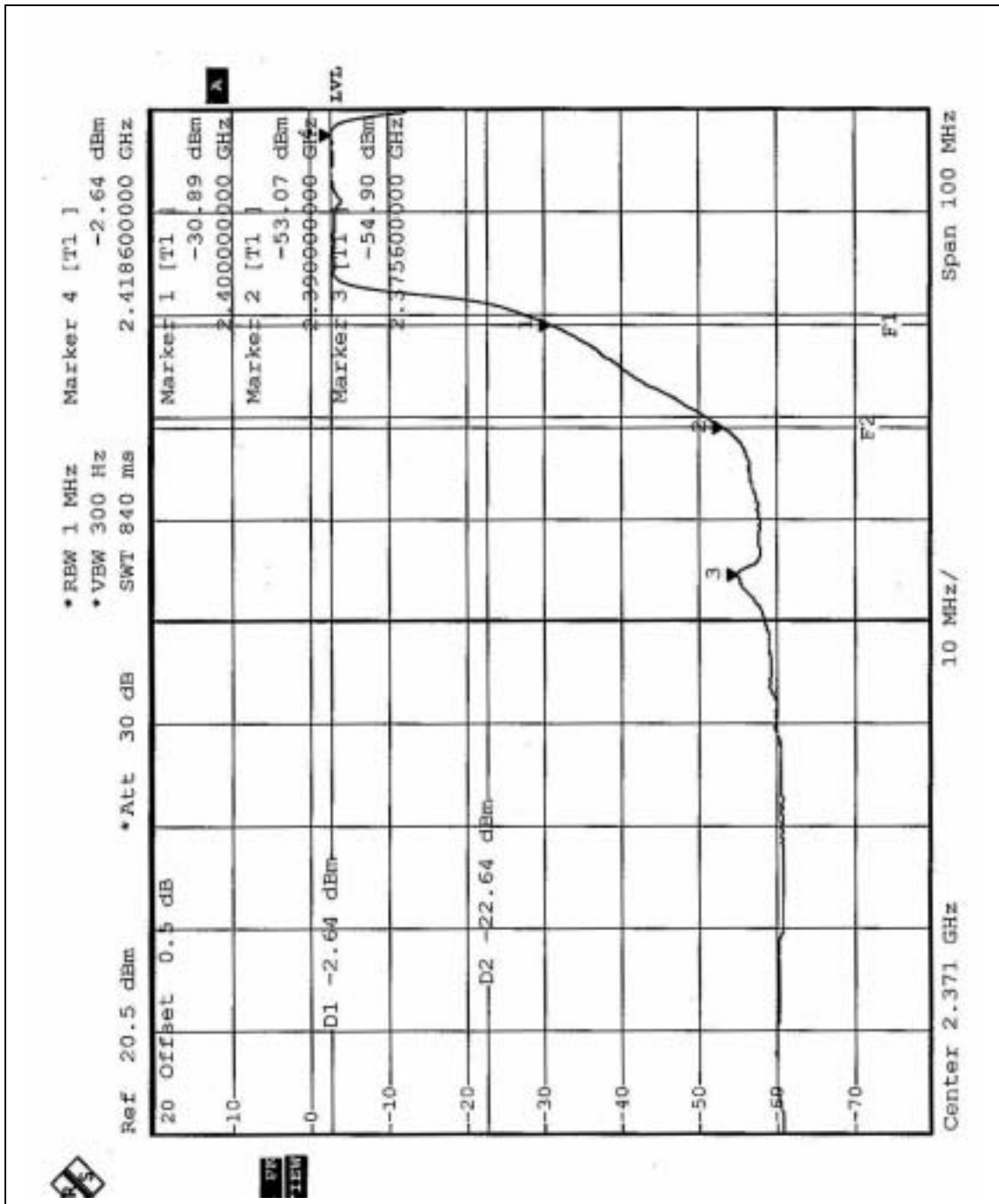

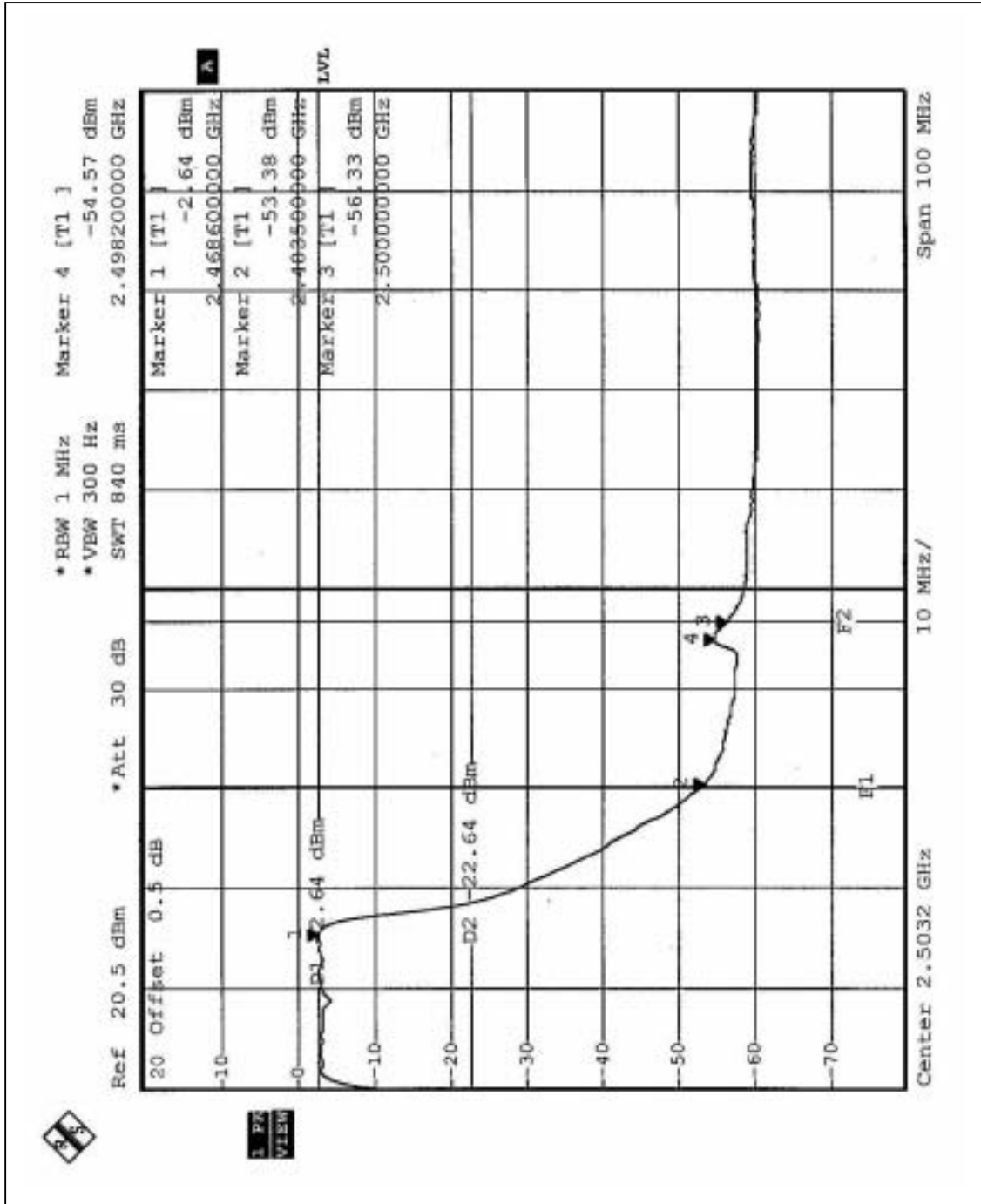



4.7 ANTENNA REQUIREMENT

4.7.1 STANDARD APPLICABLE

For intentional device, according to FCC 47 CFR Section 15.203, an intentional radiator shall be designed to ensure that no antenna other than that furnished by the responsible party shall be used with the device.

And according to FCC 47 CFR Section 15.247 (b), if transmitting antennas of directional gain greater than 6dBi are used, the power shall be reduced by the amount in dB that the directional gain of the antenna exceeds 6dBi.

4.7.2 ANTENNA CONNECTED CONSTRUCTION

The antenna type used in this product is PIFA antenna(only for Rx) without connector and Dipole Antenna(for Rx & Tx) without connector.

The maximum Gain of PIFA antenna is 3.78 dBi and the maximum Gain of Dipole antenna is 1.77 dBi.

5 PHOTOGRAPHS OF THE TEST CONFIGURATION CONDUCTED EMISSION TEST



RADIATED EMISSION TEST





6 INFORMATION ON THE TESTING LABORATORIES

We, ADT Corp., were founded in 1988 to provide our best service in EMC, Radio, Telecom and Safety consultation. Our laboratories are accredited and approved by the following approval agencies according to ISO/IEC 17025, Guide 25 or EN 45001:

USA	FCC, NVLAP, UL
Germany	TUV Rheinland
Japan	VCCI
Norway	NEMKO
Canada	INDUSTRY CANADA , CSA
R.O.C.	CNLA, BSMI, DGT
Netherlands	Telefication
Singapore	PSB , GOST-ASIA(MOU)
Russia	CERTIS(MOU)

Copies of accreditation certificates of our laboratories obtained from approval agencies can be downloaded from our web site:

www.adt.com.tw/index.5/phtml. If you have any comments, please feel free to contact us at the following:

Linko EMC/RF Lab:

Tel: 886-2-26052180

Fax: 886-2-26052943

Hsin Chu EMC/RF Lab:

Tel: 886-3-5935343

Fax: 886-3-5935342

Hwa Ya EMC/RF/Safety Lab:

Tel: 886-3-3183232

Fax: 886-3-3185050

Linko RF & Telecom Lab.

Tel: 886-3-3270910

Fax: 886-3-3270892

Email: service@mail.adt.com.tw

Web Site: www.adt.com.tw

The address and road map of all our labs can be found in our web site also.