



TEST REPORT

Product Name : IEEE 802.11g 54Mbps Wireless Router

Model Number : XG-2000

Applicant : Z-Com, Inc.

Address : 7F-2, No. 9. Prosperity RD.I Science-Based
Industrial, Park Hsinchu, 300 Taiwan.

Received Date : May 11, 2004

Tested Date : July 24~August 25, 2003 ; May 11~17, 2004

Notes :

1. This report will be invalid if duplicated or photocopied in part.
2. This report refers only to the specimen(s) submitted to testing, and be invalid as seperately used.
3. This report is invalid without examination stamp and signature of this institute.
4. The tested specimen(s) will be preserved for thirty days from the data issued.
5. The report must not be used to claim product certification, approval, or endorsement by NVLAP, NIST, or any agency of the federal government.
6. **This report is modified from ER03-07-066.**



Ecom Sertech Corp.

Rm. 258, Bldg. 17, NO.195, Sec. 4 Chung Hsing Rd., ChuTung Chen, Hsinchu, Taiwan 310, R.O.C
TEL:886-3-5918012 FAX: 886-3-5825720

FCC ID : M4Y-XG2000
Report No. : ER04-05-023FRF
Page 2 of 64

Test Report Certification

Product Name : IEEE 802.11g 54Mbps Wireless Router

Model Number : XG-2000

Applicant : Z-Com, Inc.

Measurement Standard :

FCC 47 C.F.R. Part 15, Subpart B and Subpart C (2003),
ANSI C63.4 (2001)

Tested By : Alan Fan , **Date** : May 18, 2004
(Alan Fan)

Reviewed By : Roger Sheng , **Date** : May 18, 2004
(Roger Sheng)

Approved By : Chieh-De Tsai , **Date** : May 18, 2004
(Chieh-De Tsai, Manager)

WE HEREBY CERTIFY THAT: The measurements shown in the attachment were made in accordance with the procedures indicated, and the energy emitted by the equipment was found to be within the limits applicable. We assume full responsibility for the accuracy and completeness of these measurements and vouch for the qualifications of all persons taking them.



TABLE OF CONTENTS

TITLE	PAGE NO.
1. GENERAL INFORMATION.....	5
1.1 General Statement	5
1.2 General Description of EUT & Power	5
1.3 Description of EUT	5
1.4 Description of Peripherals.....	6
1.5 EUT & Peripherals Setup Diagram.....	7
1.6 EUT Operating Condition.....	8
1.7 Description of Test Site	8
1.8 Summary of Test Results	9
2. CONDUCTED POWERLINE TEST	10
2.1 Test Equipments	10
2.2 Test Setup	10
2.3 Conducted Power Line Emission Limit.....	11
2.4 Test Procedure	11
2.5 Uncertainty of Conducted Emission	11
2.6 Conducted Power Line Emission.....	12-13
2.7 Photos of Conduction Test.....	14
3. RADIATED EMISSION TEST.....	15
3.1 Test Equipments	15
3.2 Test Setup	15
3.3 Radiation Limit	16
3.4 Test Procedures.....	17
3.5 Uncertainty of Radiated Emission	17
3.6 Radiated RF Noise Measurement	18-43
3.7 Photos of Open Site	44-45
4. 6dB BANDWIDTH MEASUREMENT.....	46
4.1 Test Equipments	46
4.2 Test Setup	46
4.3 Limits of 6dB Bandwidth Measurement.....	46
4.4 Test Procedure	46
4.5 Uncertainty of Conducted Emission	46
4.6 Test Results.....	47
4.7 Photo of 6db Bandwidth Measurement.....	48-49
5. MAXIMUM PEAK OUTPUT POWER.....	50
5.1 Test Equipments	50
5.2 Test Setup	50
5.3 Limits of Maximum Peak Output Power	50
5.4 Test Procedure	51
5.5 Uncertainty of Conducted Emission	51
5.6 Test Results.....	51
6. POWER SPECTRAL DENSITY MEASUREMENT	52
6.1 Test Equipments	52
6.2 Test Setup	52
6.3 Limits of Power Spectral Density Measurement	52
6.4 Test Procedure	53
6.5 Uncertainty of Conducted Emission	53
6.6 Test Results.....	54
6.7 Photo of Power Spectral Density Measurement	55-56



TABLE OF CONTENTS

TITLE	PAGE NO.
7. OUT OF BAND MEASUREMENT	57
7.1 Test Equipments	57
7.2 Test Setup	57
7.3 Limits of Out of Band Emissions Measurement	57
7.4 Test Procedure	58
7.5 Uncertainty of Conducted Emission	58
7.6 Test Results	58-59
7.7 Photo of Out of Band Measurement	60-61
8. ANTENNA REQUIREMENT	62
8.1 Standard Applicable	62
8.2 Antenna Connected Construction	62
9. RF EXPOSURE EVALUATION	63
9.1 Friis Formula	63
9.2 EUT Operating Condition	63
9.3 Test Result of RF Exposure Evaluation	64
9.3.1 Antenna Gain	64
9.3.2 Output Power into Antenna & RF Exposure Evaluation Distance	64



1. GENERAL INFORMATION

1.1 General Statement

MEASUREMENT DEVIATION : Comply with standard in full

TRACEABILITY : This test result is traceable to National or International std.

1.2 General Description of EUT & Power

1.3 Description of EUT

MANUFACTURER : Z-Com, Inc.

SAMPLE NAME : IEEE 802.11g 54Mbps Wireless Router

MODEL NAME : XG-2000

FREQUENCY CHANNEL : 2412MHz to 2462MHz

CHANNEL SPACING : 5MHz

CHANNEL NUMBER : 1~11CH

AIR DATA RATE : 54Mbps (802.11g Mode), 11Mbps(802.11b Mode)

TYPE OF MODULATION : Orthogonal Frequency Division Multiplex or Direct
Sequence Spread Spectrum

FREQUENCY SELECTION : BY SOFTWARE

ANTENNA TYPE : 1/2λ Dipole ANTENNA, 2dBi, reversed SMA connector.

POWER SOURCE : 12VDC(From Adapter)

POWER ADAPTER :

MANUFACTURER : AC ADAPTOR

MODEL NUMBER : SCP48-121000

INPUT POWER : 120VAC/60Hz, 19W

OUTPUT POWER : 12VDC, 1000mA



1.4 Description of Peripherals

(1) PC

MANUFACTURER : HP CORP.
MODEL NUMBER : VECTRA VEI8DT
SERIAL NUMBER : SG1202412
FCC : DOC

(2) PC

MANUFACTURER : HP CORP.
MODEL NUMBER : VECTRA VEI8DT
SERIAL NUMBER : SG1202415
FCC : DOC

(3) PC

MANUFACTURER : HP CORP.
MODEL NUMBER : VECTRA VEI8DT
SERIAL NUMBER : SG1202416
FCC : DOC

(4) Notebook PC

MANUFACTURER : DELL CORP.
MODEL NUMBER : PP01L
SERIAL NUMBER : CN-09C748-48155-1AP-6630
FCC : DOC
POWER CORD : Unshielded, Detachable, 1.8m

(5) CABLE

	Type	Connector	shielded	Length
(A)	Cat5 twisted-pair	RJ-45, Plastic	NO	15m

1.5 EUT & Peripherals Setup Diagram

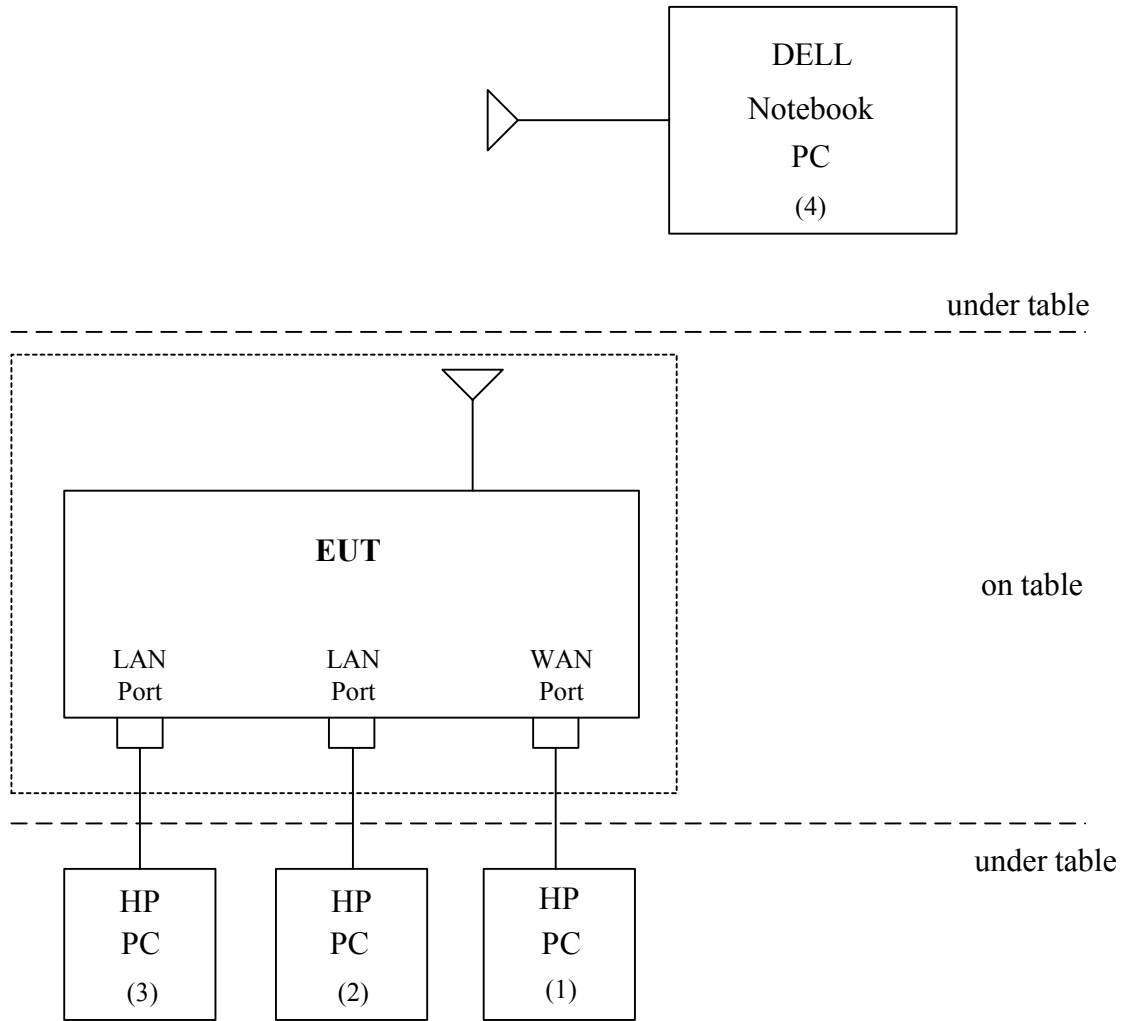



1.6 EUT Operating Condition

1. Set up all computers like the setup diagram.
2. PC (1) ping 192.168.62.1 -t to EUT.
3. PC (2) ping 192.168.1.80 -t to PC (3).
4. Notebook PC (4) ping 192.168.62.1 -t to EUT.
5. All of the function are under run.
6. Start test.

1.7 Description of Test Site

SITE DESCRIPTION

FCC Certificate NO. : 90585
BSMI Certificate NO. : SL2-IN-E-0002
NVLAP Lab code : 200118-0
CNLA Certificate NO. : CNLA-ZL97018
VCCI Certificate NO. : R-1189, C-1250
TÜV Certificate NO. : 10008375

NAME OF SITE : Ecom Sertech Corp. Hsin-Chu Lab.
(Spin-off from ITRI / ERSO on Apr. 01, 2003)
SITE LOCATION : Rm.258, Bldg.17, NO.195 , Sec. 4, Chung Hsing Rd.,
Chu-Tung Chen. Hsin-Chu, Taiwan 310 R.O.C.



1.8 Summary of Test Results

The EUT has been tested according to the following specifications :

APPLIED STANDARD : FCC 47 C.F.R. Part 15, Subpart B and Subpart C			
Standard Section	Test Type and Limit	Result	REMARK
15.107 15.207	AC Power Conducted Emission Limit : 15.107	PASS	Meet the requirement of limit
15.247(a)(2)	Spectrum Bandwidth of a Orthogonal Frequency Division Multiplex System Limit : 6dB bandwidth > 500KHz	PASS	Meet the requirement of limit
15.247(b)	Maximum Peak Output Power Limit : max. 30dBm	PASS	Meet the requirement of limit
15.109 15.205 15.209	Transmitter Radiated Emissions Limit : Table 15.209	PASS	Meet the requirement of limit
15.247(d)	Power Spectral Density Limit : max. 8dBm	PASS	Meet the requirement of limit
15.247(c)	Out of Band Emission and Restricted Band Radiation Limit:20dB less than peak value of fundamental frequency Restricted band Limit:Table 15.209	PASS	Meet the requirement of limit



2. CONDUCTED POWERLINE TEST

2.1 Test Equipments

The following test equipments are used during the conducted powerline tests :

Manufacturer or Type	Model No.	Serial No.	Date of Calibration	Calibration Period	Remark
HP SPECTRUM ANALYZER & DISPLAY	8568A	2235A02320	November 14, 2003	1 Year	PRETEST
HP QUASI-PEAK ADAPTER	85650 A	2341A00672	November 14, 2003	1 Year	PRETEST
SOLAR ISOLATION TRANSFORMER	7032-1	N/A	N/A	N/A	FINAL
EMCO L.I.S.N.	3850/2	9311-1025 9401-1028	January 08, 2004 For Characteristic impedance	1 Year	FINAL
			May 18, 2004 For Insertion loss		
R & S TEST RECEIVER	ESHS 30	838550/003	February 11, 2004	1 Year	FINAL
KEENE SHIELDED ROOM	5983	No.1	N/A	N/A	FINAL
R & S PULSE LIMIT	EHS3Z2	357.8810.52	July 10, 2003	1 Year	FINAL
N TYPE COAXIAL CABLE	-----	-----	July 10, 2003	1 Year	FINAL
50Ω TERMINATOR	-----	-----	July 10, 2003	1 Year	FINAL

2.2 Test Setup

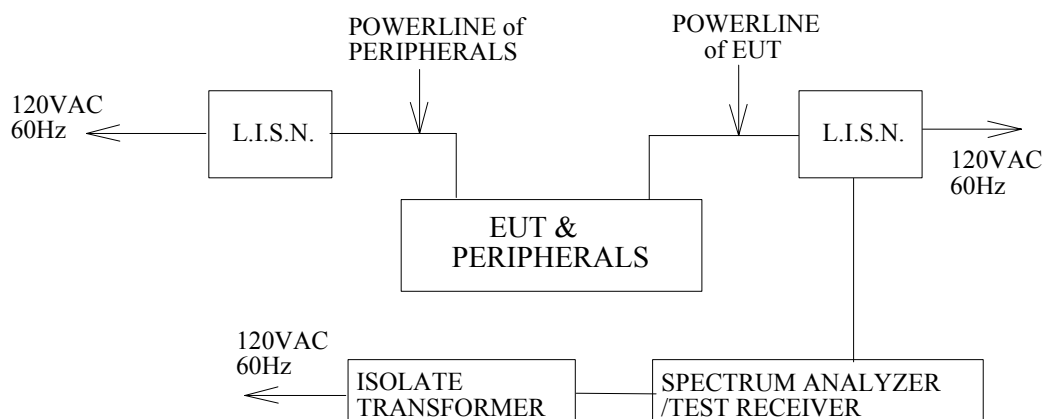



2.3 Conducted Power Line Emission Limit

For unintentional device, according to § 15.107(a) Line Conducted Emission Limits is as following :

Frequency (MHz)	Maximum RF Line Voltage (dB μ v)			
	CLASS A		CLASS B	
	Q.P.	Ave.	Q.P.	Ave.
0.15 - 0.50	79	66	66-56	56-46
0.50 - 5.00	73	60	56	46
5.00 - 30.0	73	60	60	50

For intentional device, according to § 15.207(a) Line Conducted Emission Limit is same as above table.

2.4 Test Procedure

The test procedure is performed in a 12ft×12ft×8ft(L×W×H) shielded room. the EUT along with its peripherals were placed on a 1.0m(W)× 1.5m(L) and 0.8m in height wooden table and the EUT was adjusted to maintain a 0.4 meter space from a vertical reference plane. The EUT was connected to power mains through a line impedance stabilization network (LISN) which provides 50 ohm coupling impedance for measuring instrument and the chasis ground was bounded to the horizontal ground plane of shielded room. All peripherals were connected to the second LISN and the chasis ground also bounded to the horizontal ground plane of shielded room. The excess power cable between the EUT and the LISN was bundled. The power cables of peripherals were unbundled. All connecting cables of EUT and peripherals were moved to find the maximum emission.

2.5 Uncertainty of Conducted Emission

The uncertainty of conducted emission is ±1.36dB.



2.6 Conducted Power Line Emission

The frequency spectrum from 0.15 MHz to 30 MHz was investigated. All emissions not reported are much lower than the prescribed limits.

Temperature : 24 °C

Humidity : 64 % RH

Frequency (MHz)	Loss(dB)		Measurement				L1 Emission (dBμV)		L2 Emission (dBμV)		Limits (dBμV)	
			L1(dBμV)		L2(dBμV)		Q.P.	A.V.	Q.P.	A.V.	Q.P.	A.V.
	L1	L2	Q.P.	A.V.	Q.P.	A.V.						
0.150	0.1	0.2	*	*	*	*	*	*	*	*	66.00	56.00
0.156	0.1	0.2	*	*	47.30	*	*	*	47.50	*	65.67	55.67
0.168	0.1	0.2	48.00	18.50	*	*	48.10	18.60	*	*	65.06	55.06
0.486	0.1	0.2	*	*	45.00	15.45	*	*	45.20	15.65	56.24	46.24
0.555	0.1	0.2	44.90	15.80	*	*	45.00	15.90	*	*	56.00	46.00
0.615	0.1	0.2	*	*	40.80	12.30	*	*	41.00	12.50	56.00	46.00
0.642	0.1	0.2	43.10	20.20	*	*	43.20	20.30	*	*	56.00	46.00
1.101	0.1	0.2	29.00	*	*	*	29.10	*	*	*	56.00	46.00
1.857	0.1	0.2	*	*	30.70	*	*	*	30.90	*	56.00	46.00
2.598	0.2	0.2	*	*	31.00	*	*	*	31.20	*	56.00	46.00
3.711	0.2	0.2	32.40	*	*	*	32.60	*	*	*	56.00	46.00
5.937	0.3	0.3	34.80	*	*	*	35.10	*	*	*	60.00	50.00
7.422	0.3	0.3	*	*	34.40	*	*	*	34.70	*	60.00	50.00
10.764	0.5	0.5	37.50	*	*	*	38.00	*	*	*	60.00	50.00
11.133	0.5	0.5	*	*	37.40	*	*	*	37.90	*	60.00	50.00
15.585	0.7	0.7	*	*	32.80	*	*	*	33.50	*	60.00	50.00
15.957	0.7	0.7	32.20	*	*	*	32.90	*	*	*	60.00	50.00

- REMARKS : 1. * Undetectable or the Q.P. value is lower than the limits of Ave.
 2. According to technical experiences, the power line emissions of the EUT in transmitting and receiving mode are almost the same. The EUT was set to transmitting mode at channel 1 (2412MHz) while performing final test.
 3. For 802.11b mode.



Ecom Sertech Corp.

Rm. 258, Bldg. 17, NO.195, Sec. 4 Chung Hsing Rd., ChuTung Chen, Hsinchu, Taiwan 310, R.O.C
 TEL:886-3-5918012 FAX : 886-3-5825720

FCC ID : M4Y-XG2000

Report No. : ER04-05-023FRF

Page 13 of 64

The frequency spectrum from 0.15 MHz to 30 MHz was investigated. All emissions not reported are much lower than the prescribed limits.

Temperature : 24 °C

Humidity : 64 % RH

Frequency (MHz)	Loss(dB)		Measurement				L1 Emission (dBµV)		L2 Emission (dBµV)		Limits (dBµV)	
			L1(dBµV)		L2(dBµV)		Q.P.	A.V.	Q.P.	A.V.	Q.P.	A.V.
	L1	L2	Q.P.	A.V.	Q.P.	A.V.						
0.150	0.1	0.2	*	*	*	*	*	*	*	66.00	56.00	
0.156	0.1	0.2	*	*	47.50	17.80	*	*	47.70	18.00	65.67	55.67
0.186	0.1	0.2	46.30	16.40	*	*	46.40	16.50	*	*	64.21	54.21
0.480	0.1	0.2	*	*	45.30	15.60	*	*	45.50	15.80	56.34	46.34
0.498	0.1	0.2	46.50	16.50	*	*	46.60	16.60	*	*	56.03	46.03
0.594	0.1	0.2	*	*	41.70	13.10	*	*	41.90	13.30	56.00	46.00
0.645	0.1	0.2	43.80	20.30	*	*	43.90	20.40	*	*	56.00	46.00
1.140	0.1	0.2	29.30	*	*	*	29.40	*	*	*	56.00	46.00
1.482	0.1	0.2	*	*	32.70	*	*	*	32.90	*	56.00	46.00
2.598	0.2	0.2	32.70	*	*	*	32.90	*	*	*	56.00	46.00
3.711	0.2	0.2	*	*	31.60	*	*	*	31.80	*	56.00	46.00
4.824	0.2	0.2	32.80	*	*	*	33.00	*	*	*	56.00	46.00
7.422	0.3	0.3	*	*	34.60	*	*	*	34.90	*	60.00	50.00
10.389	0.5	0.5	*	*	37.60	*	*	*	38.10	*	60.00	50.00
10.395	0.5	0.5	37.00	*	*	*	37.50	*	*	*	60.00	50.00
15.588	0.7	0.7	*	*	32.70	*	*	*	33.40	*	60.00	50.00
15.594	0.7	0.7	33.10	*	*	*	33.80	*	*	*	60.00	50.00
30.000	1.4	1.8	*	*	*	*	*	*	*	*	60.00	50.00

- REMARKS : 1. * Undetectable or the Q.P. value is lower than the limits of Ave.
 2. According to technical experiences, the power line emissions of the EUT in transmitting and receiving mode are almost the same. The EUT was set to transmitting mode at channel 1 (2412MHz) while performing final test.
 3. For 802.11g mode.

2.7 Photos of Conduction Test



3. RADIATED EMISSION TEST

3.1 Test Equipments

The following test equipments are utilized in making the measurements contained in this report.

Manufacturer or Type	Model No	Serial No	Date of Calibration	Calibration Period	Remark
CHASE BI-LOG ANTENNA	CBL6112B	2421	May 07, 2004	1 Year	FINAL
R/S SPECTRUM ANALYZER	FSEK30	835253/002	June 17, 2003	1 Year	FINAL
OPEN SITE	-----	No.2	May 07, 2004	1 Year	FINAL
N TYPE COAXIAL CABLE	CHA9525	4	July 13, 2003	1 Year	FINAL
Horn Antenna	AH-118	10089	February 25, 2004	1 Year	FINAL
HP Pre-amplifier	8449B	3008A01471	October 11, 2003	1 Year	FINAL
HP High pass filter	84300/80038	011	CAL. ON USE	1 Year	FINAL
Horn Antenna	AH-840	03077	February 25, 2004	1 Year	FINAL

3.2 Test Setup

The diagram below shows the test setup that is utilized to make the measurements for emission from 30 to 1GHz.

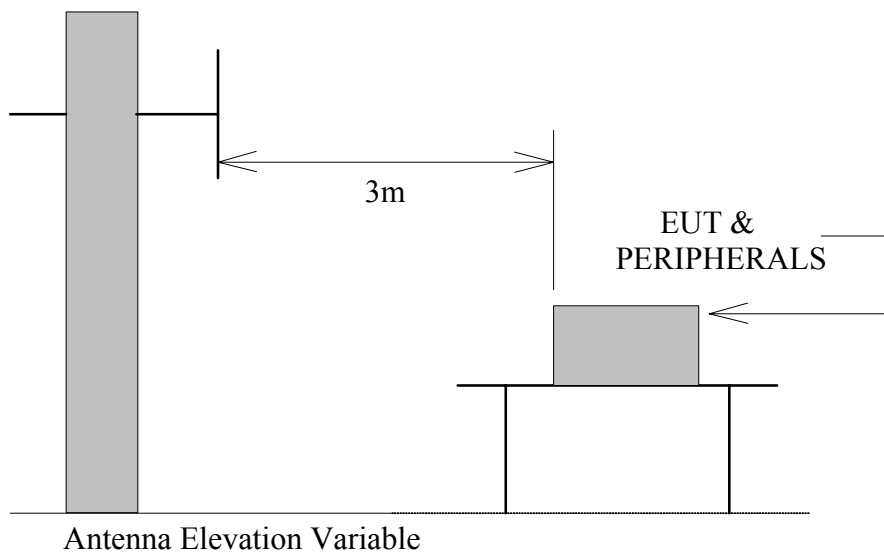

The diagram below shows the test setup that is utilized to make the measurements for emission above 1GHz.

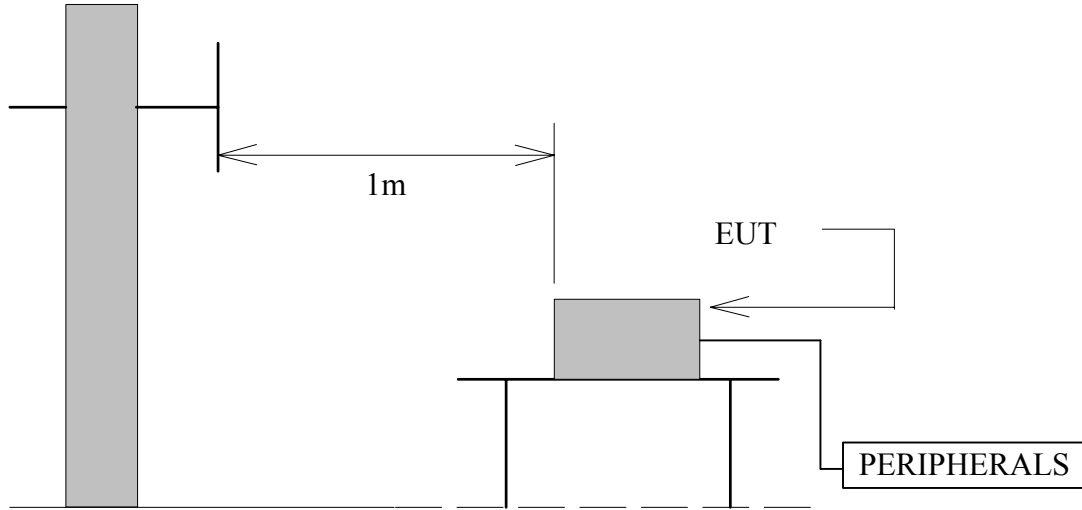

Antenna Elevation Variable

3.3 Radiation Limit

For unintentional device, according to § 15.109(a), except for Class A digital devices, the field strength of radiated emissions from unintentional radiators at a distance of 3 meters shall not exceed the following values :

Frequency (MHz)	Distance (Meters)	Radiated (dB μ V/M)	Radiated (μ V/M)
30-88	3	40.0	100
88-216	3	43.5	150
216-960	3	46.0	200
Above 960	3	54.0	500

For intentional device, according to § 15.209(a), the general requirement of field strength of radiated emissions from intentional radiators at a distance of 3 meters shall not exceed the above table.



3.4 Test Procedures

- a. The EUT was placed on the top of a rotating table 0.8 meters above the ground at a 10 meter open area test site. The table was rotated 360 degrees to determine the position of the highest radiation.
- b. During performing radiated emission below 1GHz, the EUT was set 3 meters away from the interference-receiving antenna, which was mounted on the top of a variable-height antenna tower. During performing radiated emission above 1GHz, the EUT was set 1 meter away from the interference-receiving antenna.
- c. The antenna is a broadband antenna, and its height is varied from one meter to four meters above the ground to determine the maximum value of the field strength. Both horizontal and vertical polarization of the antenna are set to make the measurement.
- d. For each suspected emission, the EUT was arranged to its worst case and then the antenna was tuned to heights from 1 meter to 4 meters and the rotatable table was turned from 0 degrees to 360 degrees to find the maximum reading.
- e. The test-receiver system was set to Peak Detect Function and Specified Bandwidth with Maximum Hold Mode.
- f. If the emission level of the EUT in peak mode was 10 dB lower than the limit specified, then testing could be stopped and the peak values of the EUT would be reported. Otherwise the emissions that did not have 10 dB margin would be re-tested one by one using peak, quasi-peak or average method as specified and then reported in a data sheet.

NOTE :

1. The resolution bandwidth and video bandwidth of test receiver/spectrum analyzer is 120 KHz for Peak detection (PK) and Quasi-peak detection (QP) at frequency below 1GHz.
2. The resolution bandwidth and video bandwidth of test receiver/spectrum analyzer is 1 MHz for Peak detection and frequency above 1GHz.
3. The resolution bandwidth of test receiver/spectrum analyzer is 1 MHz and the video bandwidth is 10 Hz for Average detection (AV) at frequency above 1GHz.

3.5 Uncertainty of Radiated Emission

The uncertainty of radiated emission is ± 2.72 dB.



3.6 Radiated RF Noise Measurement

Test Requirement: 15.109, 15.209

The frequency spectrum from 30 MHz to 1000 MHz was investigated. All emissions not reported are much lower than the prescribed limits.

All readings are quasi-peak values.

Temperature : 32.4°C

Humidity : 46 % RH

Frequency (MHz)	Antenna Factor (dB)	Cable Loss (dB)	Meter Reading at 3m(dBμV/M)		Limits at 3m (dBμV/M)	Emission Level at 3m(dBμV/M)	
			Horizontal	Vertical		Horizontal	Vertical
30.00	21.39	0.90	*	*	40.00	*	*
124.98	13.33	2.10	15.00	15.50	43.50	30.43	30.93
199.99	10.39	2.80	14.00	16.80	43.50	27.19	29.99
249.99	13.09	3.20	19.70	19.20	46.00	35.99	35.49
263.99	13.20	3.31	17.00	14.10	46.00	33.52	30.62
299.99	13.50	3.60	9.00	11.20	46.00	26.10	28.30
374.99	16.30	4.05	11.80	12.00	46.00	32.15	32.35
399.98	17.24	4.20	11.30	12.50	46.00	32.74	33.94
500.01	18.32	4.90	16.20	14.80	46.00	39.42	38.02
527.99	18.66	5.04	7.00	8.20	46.00	30.70	31.90
593.99	19.47	5.37	16.20	12.00	46.00	41.04	36.84
659.99	19.47	5.70	16.30	12.40	46.00	41.47	37.57
749.95	19.98	6.15	9.00	4.00	46.00	35.13	30.13
791.99	20.44	6.36	12.40	7.20	46.00	39.20	34.00
1000.00	21.58	7.00	*	*	54.00	*	*

REMARKS : 1. *Undetectable

2. Emission level (dBμV/M) =Antenna Factor (dB/m) + Cable loss (dB) + Meter Reading (dBμV).

3. The EUT was operated in stand-by, receiving and transmitting mode, after a preliminary scan, we found the EUT in transmitting mode generate the highest emission power. The EUT is set transmitting mode at final test to get the worst-case emission.

4. Mode : Transmitting test

5. For Wireless 802.11b mode.



Ecom Sertech Corp.

Rm. 258, Bldg. 17, NO.195, Sec. 4 Chung Hsing Rd., ChuTung Chen, Hsinchu, Taiwan 310, R.O.C
TEL:886-3-5918012 FAX : 886-3-5825720

FCC ID : M4Y-XG2000

Report No. : ER04-05-023FRF

Page 19 of 64

Test Requirement: 15.109, 15.209

The frequency spectrum from 30 MHz to 1000 MHz was investigated. All emissions not reported are much lower than the prescribed limits.

All readings are quasi-peak values.

Temperature : 32.4°C

Humidity : 46 % RH

Frequency (MHz)	Antenna Factor (dB)	Cable Loss (dB)	Meter Reading at 3m(dBμV/M)		Limits at 3m (dBμV/M)	Emission Level at 3m(dBμV/M)	
			Horizontal	Vertical		Horizontal	Vertical
30.00	21.39	0.90	*	*	40.00	*	*
124.98	13.33	2.10	15.20	15.60	43.50	30.63	31.03
199.99	10.39	2.80	14.10	16.50	43.50	27.29	29.69
249.99	13.09	3.20	19.50	18.90	46.00	35.79	35.19
263.99	13.20	3.31	17.20	14.00	46.00	33.72	30.52
299.99	13.50	3.60	8.60	11.80	46.00	25.70	28.90
374.99	16.30	4.05	12.00	12.10	46.00	32.35	32.45
399.98	17.24	4.20	11.00	12.20	46.00	32.44	33.64
500.01	18.32	4.90	16.00	15.00	46.00	39.22	38.22
527.99	18.66	5.04	6.60	8.60	46.00	30.30	32.30
593.99	19.47	5.37	16.50	12.20	46.00	41.34	37.04
659.99	19.47	5.70	16.00	12.00	46.00	41.17	37.17
749.95	19.98	6.15	9.20	3.70	46.00	35.33	29.83
791.99	20.44	6.36	13.00	7.50	46.00	39.80	34.30
1000.00	21.58	7.00	*	*	54.00	*	*

REMARKS : 1. *Undetectable

2. Emission level (dBμV/M) =Antenna Factor (dB/m) + Cable loss (dB) + Meter Reading (dBμV).

3. The EUT was operated in stand-by, receiving and transmitting mode, after a preliminary scan, we found the EUT in transmitting mode generate the highest emission power. The EUT is set transmitting mode at final test to get the worst-case emission.

4. Mode : Transmitting test.

5. For Wireless 802.11g mode.



Ecom Sertech Corp.

Rm. 258, Bldg. 17, NO.195, Sec. 4 Chung Hsing Rd., ChuTung Chen, Hsinchu, Taiwan 310, R.O.C
 TEL:886-3-5918012 FAX : 886-3-5825720

FCC ID : M4Y-XG2000
 Report No. : ER04-05-023FRF
 Page 20 of 64

Test Requirement: 15.109 ,15.209

The frequency spectrum above 1 GHz was investigated. All emissions not reported below are more than 40 dB below the prescribed limits. Readings are both peak and average values.

Company	Z-Com, Inc	Test Date :	2003/8/20
Product Name	IEEE 802.11g 54Mbps Wireless Router	Test By:	Alan Fan
Model Name	XG-2000	TEMP&Humidity :	25.4°C , 57%

CH1 RX				Measurement Distance at 1m				Horizontal polarity			
Freq.	Reading	AF	Cable	Pre-amp	Dist	Filter	Level	Limit	Margin	Mark	Height
(MHz)	(dBuV)	(dBuV)	(dB)	(dB)	dB	dB	(dBuV/m)	(dBuV/m)	(dB)	(P/Q/A)	(Meter)
4823.89	48.02	34.44	2.77	35.38	9.5	0	40.35	74	-33.65	P	1.00
4823.89	40.78	34.44	2.77	35.38	9.5	0	33.11	54	-20.89	A	1.00
7237.43	44.80	39.81	3.95	35.56	9.5	0	43.49	74	-30.51	P	1.05
7237.43	33.94	39.81	3.95	35.56	9.5	0	32.63	54	-21.37	A	1.05
9647.99	53.70	38.54	4.10	35.67	9.5	0	51.16	74	-22.84	P	1.10
9647.99	49.84	38.54	4.10	35.67	9.5	0	47.30	54	-6.70	A	1.10

1. AF: Antenna Factor, Cable: Cable Loss, Pre-Amp: Preamplifier gain, Filter: High Pass Filter Insertion Loss (3.5GHz)
2. Analyzer setting P(Peak): RBW=1MHz, VBW=1MHz, A(Average): RBW=1MHz,VBW=10Hz
3. Dist : correction to extra plate reading to 3m specification distance 1m measurement distance = -9.5dB
4. The result basic equation calculation as follow :

$$\text{Level} = \text{Reading} + \text{AF} + \text{Cable} - \text{Preamp} + \text{Filter} - \text{Dist}, \text{Margin} = \text{Level} - \text{Limit}$$
5. The test limit is 3M limit.
6. The frequency was searched to 18GHz.
7. The other emission levels were very low against the limit.
8. For 802.11b mode at 11Mbps.



Ecom Sertech Corp.

Rm. 258, Bldg. 17, NO.195, Sec. 4 Chung Hsing Rd., ChuTung Chen, Hsinchu, Taiwan 310, R.O.C
 TEL:886-3-5918012 FAX : 886-3-5825720

FCC ID : M4Y-XG2000
 Report No. : ER04-05-023FRF
 Page 21 of 64

Test Requirement: 15.109 ,15.209

The frequency spectrum above 1 GHz was investigated. All emissions not reported below are more than 40 dB below the prescribed limits. Readings are both peak and average values.

Company	Z-Com, Inc	Test Date :	2003/8/20
Product Name	IEEE 802.11g 54Mbps Wireless Router	Test By:	Alan Fan
Model Name	XG-2000	TEMP&Humidity :	25.4°C , 57%

CH1 RX				Measurement Distance at 1m					Vertical polarity			
Freq.	Reading	AF	Cable	Pre-amp	Dist	Filter	Level	Limit	Margin	Mark	Height	
(MHz)	(dBuV)	(dBuV)	(dB)	(dB)	dB	dB	(dBuV/m)	(dBuV/m)	(dB)	(P/Q/A)	(Meter)	
4823.89	53.31	34.44	2.77	35.38	9.5	0	45.64	74	-28.36	P	1.08	
4823.89	49.91	34.44	2.77	35.38	9.5	0	42.24	54	-11.76	A	1.08	
7236.28	44.09	39.81	3.94	35.56	9.5	0	42.78	74	-31.22	P	1.06	
7236.28	33.64	39.81	3.94	35.56	9.5	0	32.33	54	-21.67	A	1.06	
9647.95	57.97	38.54	4.10	35.67	9.5	0	55.43	74	-18.57	P	1.02	
9647.95	55.09	38.54	4.10	35.67	9.5	0	52.55	54	-1.45	A	1.02	

1. AF: Antenna Factor, Cable: Cable Loss, Pre-Amp: Preamplifier gain, Filter: High Pass Filter Insertion Loss (3.5GHz)
2. Analyzer setting P(Peak): RBW=1MHz, VBW=1MHz, A(Average): RBW=1MHz,VBW=10Hz
3. Dist : correction to extra plate reading to 3m specification distance 1m measurement distance = -9.5dB
4. The result basic equation calculation as follow :

$$\text{Level} = \text{Reading} + \text{AF} + \text{Cable} - \text{Preamp} + \text{Filter} - \text{Dist}, \text{Margin} = \text{Level} - \text{Limit}$$
5. The test limit is 3M limit.
6. The frequency was searched to 18GHz.
7. The other emission levels were very low against the limit.
8. For 802.11b mode at 11Mbps.
9. The test data marked in gray background means the EUT emission data is located in the margin uncertainty range of emission limits.



Ecom Sertech Corp.

Rm. 258, Bldg. 17, NO.195, Sec. 4 Chung Hsing Rd., ChuTung Chen, Hsinchu, Taiwan 310, R.O.C
 TEL:886-3-5918012 FAX : 886-3-5825720

FCC ID : M4Y-XG2000
 Report No. : ER04-05-023FRF
 Page 22 of 64

Test Requirement: 15.109 ,15.209

The frequency spectrum above 1 GHz was investigated. All emissions not reported below are more than 40 dB below the prescribed limits. Readings are both peak and average values.

Company	Z-Com, Inc.	Test Date :	2003/8/20
Product Name	IEEE 802.11g 54Mbps Wireless Router	Test By:	Alan Fan
Model Name	XG-2000	TEMP&Humidity :	25.4°C , 57%

CH6 RX				Measurement Distance at 1m				Horizontal polarity			
Freq.	Reading	AF	Cable	Pre-amp	Dist	Filter	Level	Limit	Margin	Mark	Height
(MHz)	(dBuV)	(dBuV)	(dB)	(dB)	dB	dB	(dBuV/m)	(dBuV/m)	(dB)	(P/Q/A)	(Meter)
4873.93	47.02	34.77	2.80	35.40	9.5	0	39.69	74	-34.31	P	1.02
4873.93	39.27	34.77	2.80	35.40	9.5	0	31.94	54	-22.06	A	1.02
7310.99	44.84	39.78	4.00	35.57	9.5	0	43.55	74	-30.45	P	1.10
7310.99	33.70	39.78	4.00	35.57	9.5	0	32.41	54	-21.59	A	1.10
9748.09	52.77	38.53	4.02	35.72	9.5	0	50.09	74	-23.91	P	1.03
9748.09	49.55	38.53	4.02	35.72	9.5	0	46.87	54	-7.13	A	1.03

1. AF: Antenna Factor, Cable: Cable Loss, Pre-Amp: Preamplifier gain, Filter: High Pass Filter Insertion Loss (3.5GHz)
2. Analyzer setting P(Peak): RBW=1MHz, VBW=1MHz, A(Average): RBW=1MHz,VBW=10Hz
3. Dist : correction to extra plate reading to 3m specification distance 1m measurement distance = -9.5dB
4. The result basic equation calculation as follow :

$$\text{Level} = \text{Reading} + \text{AF} + \text{Cable} - \text{Preamp} + \text{Filter} - \text{Dist}, \text{Margin} = \text{Level} - \text{Limit}$$
5. The test limit is 3M limit.
6. The frequency was searched to 18GHz.
7. The other emission levels were very low against the limit.
8. For 802.11b mode at 11Mbps.



Ecom Sertech Corp.

Rm. 258, Bldg. 17, NO.195, Sec. 4 Chung Hsing Rd., ChuTung Chen, Hsinchu, Taiwan 310, R.O.C
 TEL:886-3-5918012 FAX : 886-3-5825720

FCC ID : M4Y-XG2000
 Report No. : ER04-05-023FRF
 Page 23 of 64

Test Requirement: 15.109 ,15.209

The frequency spectrum above 1 GHz was investigated. All emissions not reported below are more than 40 dB below the prescribed limits. Readings are both peak and average values.

Company	Z-Com, Inc.	Test Date :	2003/8/20
Product Name	IEEE 802.11g 54Mbps Wireless Router	Test By:	Alan Fan
Model Name	XG-2000	TEMP&Humidity :	25.4°C , 57%

CH6 RX				Measurement Distance at 1m					Vertical polarity			
Freq.	Reading	AF	Cable	Pre-amp	Dist	Filter	Level	Limit	Margin	Mark	Height	
(MHz)	(dBuV)	(dBuV)	(dB)	(dB)	dB	dB	(dBuV/m)	(dBuV/m)	(dB)	(P/Q/A)	(Meter)	
4873.99	51.69	34.77	2.80	35.40	9.5	0	44.36	74	-29.64	P	1.00	
4873.99	48.54	34.77	2.80	35.40	9.5	0	41.21	54	-12.79	A	1.00	
7311.45	43.82	39.78	4.00	35.57	9.5	0	42.53	74	-31.47	P	1.00	
7311.45	33.11	39.78	4.00	35.57	9.5	0	31.82	54	-22.18	A	1.00	
9747.97	57.61	38.53	4.02	35.72	9.5	0	54.93	74	-19.07	P	1.00	
9747.97	55.38	38.53	4.02	35.72	9.5	0	52.70	54	-1.30	A	1.00	

1. AF: Antenna Factor, Cable: Cable Loss, Pre-Amp: Preamplifier gain, Filter: High Pass Filter Insertion Loss (3.5GHz)
2. Analyzer setting P(Peak): RBW=1MHz, VBW=1MHz, A(Average): RBW=1MHz,VBW=10Hz
3. Dist : correction to extra plate reading to 3m specification distance 1m measurement distance = -9.5dB
4. The result basic equation calculation as follow :

$$\text{Level} = \text{Reading} + \text{AF} + \text{Cable} - \text{Preamp} + \text{Filter} - \text{Dist}, \text{Margin} = \text{Level} - \text{Limit}$$
5. The test limit is 3M limit.
6. The frequency was searched to 18GHz.
7. The other emission levels were very low against the limit.
8. For 802.11b mode at 11Mbps.
9. The test data marked in gray background means the EUT emission data is located in the margin uncertainty range of emission limits.



Ecom Sertech Corp.

Rm. 258, Bldg. 17, NO.195, Sec. 4 Chung Hsing Rd., ChuTung Chen, Hsinchu, Taiwan 310, R.O.C
 TEL:886-3-5918012 FAX : 886-3-5825720

FCC ID : M4Y-XG2000
 Report No. : ER04-05-023FRF
 Page 24 of 64

Test Requirement: 15.109 ,15.209

The frequency spectrum above 1 GHz was investigated. All emissions not reported below are more than 40 dB below the prescribed limits. Readings are both peak and average values.

Company	Z-Com, Inc.	Test Date :	2003/8/20
Product Name	IEEE 802.11g 54Mbps Wireless Router	Test By:	Alan Fan
Model Name	XG-2000	TEMP&Humidity :	25.4°C , 57%

CH11 RX				Measurement Distance at 1m				Horizontal polarity			
Freq.	Reading	AF	Cable	Pre-amp	Dist	Filter	Level	Limit	Margin	Mark	Height
(MHz)	(dBuV)	(dBuV)	(dB)	(dB)	dB	dB	(dBuV/m)	(dBuV/m)	(dB)	(P/Q/A)	(Meter)
4923.89	47.52	35.10	2.83	35.41	9.5	0	40.54	74	-33.46	P	1.00
4923.89	40.24	35.10	2.83	35.41	9.5	0	33.26	54	-20.74	A	1.00
7386.23	43.57	39.75	4.06	35.57	9.5	0	42.30	74	-31.70	P	1.01
7386.23	32.77	39.75	4.06	35.57	9.5	0	31.50	54	-22.50	A	1.01
9847.88	53.71	38.52	3.93	35.77	9.5	0	50.89	74	-23.11	P	1.02
9847.88	50.24	38.52	3.93	35.77	9.5	0	47.42	54	-6.58	A	1.02

1. AF: Antenna Factor, Cable: Cable Loss, Pre-Amp: Preamplifier gain, Filter: High Pass Filter Insertion Loss (3.5GHz)
2. Analyzer setting P(Peak): RBW=1MHz, VBW=1MHz, A(Average): RBW=1MHz,VBW=10Hz
3. Dist : correction to extra plate reading to 3m specification distance 1m measurement distance = -9.5dB
4. The result basic equation calculation as follow :

$$\text{Level} = \text{Reading} + \text{AF} + \text{Cable} - \text{Preamp} + \text{Filter} - \text{Dist}, \text{Margin} = \text{Level} - \text{Limit}$$
5. The test limit is 3M limit.
6. The frequency was searched to 18GHz.
7. The other emission levels were very low against the limit.
8. For 802.11b mode at 11Mbps.



Ecom Sertech Corp.

Rm. 258, Bldg. 17, NO.195, Sec. 4 Chung Hsing Rd., ChuTung Chen, Hsinchu, Taiwan 310, R.O.C
 TEL:886-3-5918012 FAX : 886-3-5825720

FCC ID : M4Y-XG2000
 Report No. : ER04-05-023FRF
 Page 25 of 64

Test Requirement: 15.109 ,15.209

The frequency spectrum above 1 GHz was investigated. All emissions not reported below are more than 40 dB below the prescribed limits. Readings are both peak and average values.

Company	Z-Com, Inc.	Test Date :	2003/8/20
Product Name	IEEE 802.11g 54Mbps Wireless Router	Test By:	Alan Fan
Model Name	XG-2000	TEMP&Humidity :	25.4°C , 57%

CH11 RX				Measurement Distance at 1m					Vertical polarity			
Freq.	Reading	AF	Cable	Pre-amp	Dist	Filter	Level	Limit	Margin	Mark	Height	
(MHz)	(dBuV)	(dBuV)	(dB)	(dB)	dB	dB	(dBuV/m)	(dBuV/m)	(dB)	(P/Q/A)	(Meter)	
4924.01	51.52	35.10	2.83	35.41	9.5	0	44.54	74	-29.46	P	1.06	
4924.01	48.32	35.10	2.83	35.41	9.5	0	41.34	54	-12.66	A	1.06	
7386.45	43.23	39.75	4.06	35.57	9.5	0	41.96	74	-32.04	P	1.03	
7386.45	32.88	39.75	4.06	35.57	9.5	0	31.61	54	-22.39	A	1.03	
9847.91	57.53	38.52	3.93	35.77	9.5	0	54.71	74	-19.29	P	1.00	
9847.91	55.36	38.52	3.93	35.77	9.5	0	52.54	54	-1.46	A	1.00	

1. AF: Antenna Factor, Cable: Cable Loss, Pre-Amp: Preamplifier gain, Filter: High Pass Filter Insertion Loss (3.5GHz)
2. Analyzer setting P(Peak): RBW=1MHz, VBW=1MHz, A(Average): RBW=1MHz,VBW=10Hz
3. Dist : correction to extra plate reading to 3m specification distance 1m measurement distance = -9.5dB
4. The result basic equation calculation as follow :

$$\text{Level} = \text{Reading} + \text{AF} + \text{Cable} - \text{Preamp} + \text{Filter} - \text{Dist}, \text{Margin} = \text{Level} - \text{Limit}$$
5. The test limit is 3M limit.
6. The frequency was searched to 18GHz.
7. The other emission levels were very low against the limit.
8. For 802.11b mode at 11Mbps.
9. The test data marked in gray background means the EUT emission data is located in the margin uncertainty range of emission limits.



Ecom Sertech Corp.

Rm. 258, Bldg. 17, NO.195, Sec. 4 Chung Hsing Rd., ChuTung Chen, Hsinchu, Taiwan 310, R.O.C
 TEL:886-3-5918012 FAX : 886-3-5825720

FCC ID : M4Y-XG2000
 Report No. : ER04-05-023FRF
 Page 26 of 64

Test Requirement: 15.109 ,15.209

The frequency spectrum above 1 GHz was investigated. All emissions not reported below are more than 40 dB below the prescribed limits. Readings are both peak and average values.

Company	Z-Com, Inc.	Test Date :	2003/8/20
Product Name	IEEE 802.11g 54Mbps Wireless Router	Test By:	Alan Fan
Model Name	XG-2000	TEMP&Humidity :	25.4°C , 57%

CH1 RX				Measurement Distance at 1m					Horizontal polarity		
Freq.	Reading	AF	Cable	Pre-amp	Dist	Filter	Level	Limit	Margin	Mark	Height
(MHz)	(dBuV)	(dBuV)	(dB)	(dB)	dB	dB	(dBuV/m)	(dBuV/m)	(dB)	(P/Q/A)	(Meter)
4823.92	45.59	34.44	2.77	35.38	9.5	0	37.92	74	-36.08	P	1.00
4823.92	39.35	34.44	2.77	35.38	9.5	0	31.68	54	-22.32	A	1.00
7236.28	43.69	39.81	3.94	35.56	9.5	0	42.38	74	-31.62	P	1.05
7236.28	33.01	39.81	3.94	35.56	9.5	0	31.70	54	-22.30	A	1.05
9647.89	51.97	38.54	4.10	35.67	9.5	0	49.43	74	-24.57	P	1.10
9647.89	47.93	38.54	4.10	35.67	9.5	0	45.39	54	-8.61	A	1.10

1. AF: Antenna Factor, Cable: Cable Loss, Pre-Amp: Preamplifier gain, Filter: High Pass Filter Insertion Loss (3.5GHz)
2. Analyzer setting P(Peak): RBW=1MHz, VBW=1MHz, A(Average): RBW=1MHz,VBW=10Hz
3. Dist : correction to extra plate reading to 3m specification distance 1m measurement distance = -9.5dB
4. The result basic equation calculation as follow :

$$\text{Level} = \text{Reading} + \text{AF} + \text{Cable} - \text{Preamp} + \text{Filter} - \text{Dist}, \text{Margin} = \text{Level} - \text{Limit}$$
5. The test limit is 3M limit.
6. The frequency was searched to 18GHz.
7. The other emission levels were very low against the limit.
8. For 802.11g mode at 6Mbps.



Ecom Sertech Corp.

Rm. 258, Bldg. 17, NO.195, Sec. 4 Chung Hsing Rd., ChuTung Chen, Hsinchu, Taiwan 310, R.O.C
 TEL:886-3-5918012 FAX : 886-3-5825720

FCC ID : M4Y-XG2000
 Report No. : ER04-05-023FRF
 Page 27 of 64

Test Requirement: 15.109 ,15.209

The frequency spectrum above 1 GHz was investigated. All emissions not reported below are more than 40 dB below the prescribed limits. Readings are both peak and average values.

Company	Z-Com, Inc.	Test Date :	2003/8/20
Product Name	IEEE 802.11g 54Mbps Wireless Router	Test By:	Alan Fan
Model Name	XG-2000	TEMP&Humidity :	25.4°C , 57%

CH1 RX				Measurement Distance at 1m					Vertical polarity		
Freq.	Reading	AF	Cable	Pre-amp	Dist	Filter	Level	Limit	Margin	Mark	Height
(MHz)	(dBuV)	(dBuV)	(dB)	(dB)	dB	dB	(dBuV/m)	(dBuV/m)	(dB)	(P/Q/A)	(Meter)
4823.96	52.16	34.44	2.77	35.38	9.5	0	44.49	74	-29.51	P	1.08
4823.96	48.52	34.44	2.77	35.38	9.5	0	40.85	54	-13.15	A	1.08
7236.37	43.61	39.81	3.94	35.56	9.5	0	42.30	74	-31.70	P	1.06
7236.37	33.28	39.81	3.94	35.56	9.5	0	31.97	54	-22.03	A	1.06
9647.88	56.42	38.54	4.10	35.67	9.5	0	53.88	74	-20.12	P	1.02
9647.88	54.36	38.54	4.10	35.67	9.5	0	51.82	54	-2.18	A	1.02

1. AF: Antenna Factor, Cable: Cable Loss, Pre-Amp: Preamplifier gain, Filter: High Pass Filter Insertion Loss (3.5GHz)
2. Analyzer setting P(Peak): RBW=1MHz, VBW=1MHz, A(Average): RBW=1MHz,VBW=10Hz
3. Dist : correction to extra plate reading to 3m specification distance 1m measurement distance = -9.5dB
4. The result basic equation calculation as follow :

$$\text{Level} = \text{Reading} + \text{AF} + \text{Cable} - \text{Preamp} + \text{Filter} - \text{Dist}, \text{Margin} = \text{Level} - \text{Limit}$$
5. The test limit is 3M limit.
6. The frequency was searched to 18GHz.
7. The other emission levels were very low against the limit.
8. For 802.11g mode at 6Mbps.



Ecom Sertech Corp.

Rm. 258, Bldg. 17, NO.195, Sec. 4 Chung Hsing Rd., ChuTung Chen, Hsinchu, Taiwan 310, R.O.C
 TEL:886-3-5918012 FAX : 886-3-5825720

FCC ID : M4Y-XG2000
 Report No. : ER04-05-023FRF
 Page 28 of 64

Test Requirement: 15.109 ,15.209

The frequency spectrum above 1 GHz was investigated. All emissions not reported below are more than 40 dB below the prescribed limits. Readings are both peak and average values.

Company	Z-Com, Inc.	Test Date :	2003/8/20
Product Name	IEEE 802.11g 54Mbps Wireless Router	Test By:	Alan Fan
Model Name	XG-2000	TEMP&Humidity :	25.4°C , 57%

CH6 RX				Measurement Distance at 1m					Horizontal polarity		
Freq.	Reading	AF	Cable	Pre-amp	Dist	Filter	Level	Limit	Margin	Mark	Height
(MHz)	(dBuV)	(dBuV)	(dB)	(dB)	dB	dB	(dBuV/m)	(dBuV/m)	(dB)	(P/Q/A)	(Meter)
4873.93	46.51	34.77	2.80	35.40	9.5	0	39.18	74	-34.82	P	1.02
4873.93	38.48	34.77	2.80	35.40	9.5	0	31.15	54	-22.85	A	1.02
7311.73	43.71	39.78	4.00	35.57	9.5	0	42.42	74	-31.58	P	1.10
7311.73	33.15	39.78	4.00	35.57	9.5	0	31.86	54	-22.14	A	1.10
9747.98	54.19	38.53	4.02	35.72	9.5	0	51.51	74	-22.49	P	1.03
9747.98	51.03	38.53	4.02	35.72	9.5	0	48.35	54	-5.65	A	1.03

1. AF: Antenna Factor, Cable: Cable Loss, Pre-Amp: Preamplifier gain, Filter: High Pass Filter Insertion Loss (3.5GHz)
2. Analyzer setting P(Peak): RBW=1MHz, VBW=1MHz, A(Average): RBW=1MHz,VBW=10Hz
3. Dist : correction to extra plate reading to 3m specification distance 1m measurement distance = -9.5dB
4. The result basic equation calculation as follow :

$$\text{Level} = \text{Reading} + \text{AF} + \text{Cable} - \text{Preamp} + \text{Filter} - \text{Dist}, \text{Margin} = \text{Level} - \text{Limit}$$
5. The test limit is 3M limit.
6. The frequency was searched to 18GHz.
7. The other emission levels were very low against the limit.
8. For 802.11g mode at 6Mbps.



Ecom Sertech Corp.

Rm. 258, Bldg. 17, NO.195, Sec. 4 Chung Hsing Rd., ChuTung Chen, Hsinchu, Taiwan 310, R.O.C
 TEL:886-3-5918012 FAX : 886-3-5825720

FCC ID : M4Y-XG2000
 Report No. : ER04-05-023FRF
 Page 29 of 64

Test Requirement: 15.109 ,15.209

The frequency spectrum above 1 GHz was investigated. All emissions not reported below are more than 40 dB below the prescribed limits. Readings are both peak and average values.

Company	Z-Com, Inc.	Test Date :	2003/8/20
Product Name	IEEE 802.11g 54Mbps Wireless Router	Test By:	Alan Fan
Model Name	XG-2000	TEMP&Humidity :	25.4°C , 57%

CH6 RX				Measurement Distance at 1m					Vertical polarity		
Freq.	Reading	AF	Cable	Pre-amp	Dist	Filter	Level	Limit	Margin	Mark	Height
(MHz)	(dBuV)	(dBuV)	(dB)	(dB)	dB	dB	(dBuV/m)	(dBuV/m)	(dB)	(P/Q/A)	(Meter)
4873.94	51.23	34.77	2.80	35.40	9.5	0	43.90	74	-30.10	P	1.00
4873.94	47.59	34.77	2.80	35.40	9.5	0	40.26	54	-13.74	A	1.00
7311.27	43.07	39.78	4.00	35.57	9.5	0	41.78	74	-32.22	P	1.00
7311.27	32.93	39.78	4.00	35.57	9.5	0	31.64	54	-22.36	A	1.00
9747.97	57.71	38.53	4.02	35.72	9.5	0	55.03	74	-18.97	P	1.00
9747.97	55.17	38.53	4.02	35.72	9.5	0	52.49	54	-1.51	A	1.00

1. AF: Antenna Factor, Cable: Cable Loss, Pre-Amp: Preamplifier gain, Filter: High Pass Filter Insertion Loss (3.5GHz)
2. Analyzer setting P(Peak): RBW=1MHz, VBW=1MHz, A(Average): RBW=1MHz,VBW=10Hz
3. Dist : correction to extra plate reading to 3m specification distance 1m measurement distance = -9.5dB
4. The result basic equation calculation as follow :

$$\text{Level} = \text{Reading} + \text{AF} + \text{Cable} - \text{Preamp} + \text{Filter} - \text{Dist}, \text{Margin} = \text{Level} - \text{Limit}$$
5. The test limit is 3M limit.
6. The frequency was searched to 18GHz.
7. The other emission levels were very low against the limit.
8. For 802.11g mode at 6Mbps.
9. The test data marked in gray background means the EUT emission data is located in the margin uncertainty range of emission limits.



Ecom Sertech Corp.

Rm. 258, Bldg. 17, NO.195, Sec. 4 Chung Hsing Rd., ChuTung Chen, Hsinchu, Taiwan 310, R.O.C
 TEL:886-3-5918012 FAX : 886-3-5825720

FCC ID : M4Y-XG2000
 Report No. : ER04-05-023FRF
 Page 30 of 64

Test Requirement: 15.109 ,15.209

The frequency spectrum above 1 GHz was investigated. All emissions not reported below are more than 40 dB below the prescribed limits. Readings are both peak and average values.

Company	Z-Com, Inc.	Test Date :	2003/8/20
Product Name	IEEE 802.11g 54Mbps Wireless Router	Test By:	Alan Fan
Model Name	XG-2000	TEMP&Humidity :	25.4°C , 57%

CH11 RX				Measurement Distance at 1m					Horizontal polarity		
Freq.	Reading	AF	Cable	Pre-amp	Dist	Filter	Level	Limit	Margin	Mark	Height
(MHz)	(dBuV)	(dBuV)	(dB)	(dB)	dB	dB	(dBuV/m)	(dBuV/m)	(dB)	(P/Q/A)	(Meter)
4923.97	46.52	35.10	2.83	35.41	9.5	0	39.54	74	-34.46	P	1.00
4923.97	38.79	35.10	2.83	35.41	9.5	0	31.81	54	-22.19	A	1.00
7385.94	43.79	39.75	4.06	35.57	9.5	0	42.52	74	-31.48	P	1.01
7385.94	32.77	39.75	4.06	35.57	9.5	0	31.50	54	-22.50	A	1.01
9847.87	54.14	38.52	3.93	35.77	9.5	0	51.32	74	-22.68	P	1.02
9847.87	50.66	38.52	3.93	35.77	9.5	0	47.84	54	-6.16	A	1.02

1. AF: Antenna Factor, Cable: Cable Loss, Pre-Amp: Preamplifier gain, Filter: High Pass Filter Insertion Loss (3.5GHz)
2. Analyzer setting P(Peak): RBW=1MHz, VBW=1MHz, A(Average): RBW=1MHz,VBW=10Hz
3. Dist : correction to extra plate reading to 3m specification distance 1m measurement distance = -9.5dB
4. The result basic equation calculation as follow :

$$\text{Level} = \text{Reading} + \text{AF} + \text{Cable} - \text{Preamp} + \text{Filter} - \text{Dist}, \text{Margin} = \text{Level} - \text{Limit}$$
5. The test limit is 3M limit.
6. The frequency was searched to 18GHz.
7. The other emission levels were very low against the limit.
8. For 802.11g mode at 6Mbps.



Ecom Sertech Corp.

Rm. 258, Bldg. 17, NO.195, Sec. 4 Chung Hsing Rd., ChuTung Chen, Hsinchu, Taiwan 310, R.O.C
 TEL:886-3-5918012 FAX : 886-3-5825720

FCC ID : M4Y-XG2000
 Report No. : ER04-05-023FRF
 Page 31 of 64

Test Requirement: 15.109 ,15.209

The frequency spectrum above 1 GHz was investigated. All emissions not reported below are more than 40 dB below the prescribed limits. Readings are both peak and average values.

Company	Z-Com, Inc.	Test Date :	2003/8/20
Product Name	IEEE 802.11g 54Mbps Wireless Router	Test By:	Alan Fan
Model Name	XG-2000	TEMP&Humidity :	25.4°C , 57%

CH11 RX				Measurement Distance at 1m					Vertical polarity		
Freq.	Reading	AF	Cable	Pre-amp	Dist	Filter	Level	Limit	Margin	Mark	Height
(MHz)	(dBuV)	(dBuV)	(dB)	(dB)	dB	dB	(dBuV/m)	(dBuV/m)	(dB)	(P/Q/A)	(Meter)
4923.91	51.69	35.10	2.83	35.41	9.5	0	44.71	74	-29.29	P	1.06
4923.91	47.81	35.10	2.83	35.41	9.5	0	40.83	54	-13.17	A	1.06
7386.12	42.92	39.75	4.06	35.57	9.5	0	41.65	74	-32.35	P	1.03
7386.12	32.44	39.75	4.06	35.57	9.5	0	31.17	54	-22.83	A	1.03
9847.94	57.54	38.52	3.93	35.77	9.5	0	54.72	74	-19.28	P	1.00
9847.94	55.63	38.52	3.93	35.77	9.5	0	52.81	54	-1.19	A	1.00

1. AF: Antenna Factor, Cable: Cable Loss, Pre-Amp: Preamplifier gain, Filter: High Pass Filter Insertion Loss (3.5GHz)
2. Analyzer setting P(Peak): RBW=1MHz, VBW=1MHz, A(Average): RBW=1MHz,VBW=10Hz
3. Dist : correction to extra plate reading to 3m specification distance 1m measurement distance = -9.5dB
4. The result basic equation calculation as follow :

$$\text{Level} = \text{Reading} + \text{AF} + \text{Cable} - \text{Preamp} + \text{Filter} - \text{Dist}, \text{Margin} = \text{Level} - \text{Limit}$$
5. The test limit is 3M limit.
6. The frequency was searched to 18GHz.
7. The other emission levels were very low against the limit.
8. For 802.11g mode at 6Mbps.
9. The test data marked in gray background means the EUT emission data is located in the margin uncertainty range of emission limits.



Ecom Sertech Corp.

Rm. 258, Bldg. 17, NO.195, Sec. 4 Chung Hsing Rd., ChuTung Chen, Hsinchu, Taiwan 310, R.O.C
 TEL:886-3-5918012 FAX: 886-3-5825720

FCC ID : M4Y-XG2000
 Report No. : ER04-05-023FRF
 Page 32 of 64

Test Requirement: 15.205

The frequency spectrum above 1 GHz was investigated. All emissions not reported below are more than 40 dB below the prescribed limits. Readings are both peak and average values.

Company	Z-Com, Inc.	Test Date :	2003/8/20
Product Name	IEEE 802.11g 54Mbps Wireless Router	Test By:	Alan Fan
Model Name	XG-2000	TEMP&Humidity :	25.4°C , 57%

CH1 TX				Measurement Distance at 1m				Horizontal polarity			
Freq.	Reading	AF	Cable	Pre-amp	Dist	Filter	Level	Limit	Margin	Mark	Height
(MHz)	(dBuV)	(dBuV)	(dB)	(dB)	dB	dB	(dBuV/m)	(dBuV/m)	(dB)	(P/Q/A)	(Meter)
*2387.54	51.21	(delta between carrier and local max emission)					50.90	74	-23.10	P	1.00
*2387.54	51.21	(delta between carrier and local max emission)					43.83	54	-10.17	A	1.00
2413.29	77.46	31.79	2.36	0.00	9.50	0.00	102.11	Fundamental Frequency		P	1.03
2413.29	70.39	31.79	2.36	0.00	9.50	0.00	95.04			A	1.03
*4824.04	50.37	34.44	2.77	35.38	9.50	1.00	43.70	74	-30.30	P	1.01
*4824.04	44.40	34.44	2.77	35.38	9.50	1.00	37.73	54	-16.27	A	1.01
7238.57	49.05	39.80	3.95	35.56	9.50	1.00	48.74	74	-25.26	P	1.17
7238.57	34.03	39.80	3.95	35.56	9.50	1.00	33.72	54	-20.28	A	1.17
9647.98	51.29	38.54	4.10	35.67	9.50	1.00	49.75	74	-24.25	P	1.07
9647.98	46.33	38.54	4.10	35.67	9.50	1.00	44.79	54	-9.21	A	1.07
*12066.45	-----	-----	-----	-----	9.50	1.00	-----	-----	-----	-----	1.00
*14479.74	-----	-----	-----	-----	9.50	1.00	-----	-----	-----	-----	1.00
16893.03	-----	-----	-----	-----	9.50	1.00	-----	-----	-----	-----	1.00
*19306.32	-----	-----	-----	-----	9.50	1.00	-----	-----	-----	-----	1.00
21719.61	-----	-----	-----	-----	9.50	1.00	-----	-----	-----	-----	1.00
24132.90	-----	-----	-----	-----	9.50	1.00	-----	-----	-----	-----	1.00

Note :

- The measurement was searched to 10th harmonic, Remark “---” means that the emissions level is too low to be measured.
- AF: Antenna Factor, Cable: Cable Loss, Pre-Amp: Preamplifier gain, Filter: High Pass Filter Insertion Loss (3.5GHz)
- Analyzer setting P(Peak): RBW=1MHz, VBW=1MHz, A(Average): RBW=1MHz, VBW=10Hz
- Remark “*” means the Restricted band.
- Dist : correction to extra plate reading to 3m specification distance 1m measurement distance = -9.5dB
- The result basic equation calculation is as follow:
 $Level = Reading + AF + Cable - Preamp + Filter - Dist$, $Margin = Level - Limit$
- The other emission levels were very low against the limit
- The test limit distance is 3M limit.
- For 802.11b mode at 11Mbps.



Ecom Sertech Corp.

Rm. 258, Bldg. 17, NO.195, Sec. 4 Chung Hsing Rd., ChuTung Chen, Hsinchu, Taiwan 310, R.O.C
 TEL:886-3-5918012 FAX : 886-3-5825720

FCC ID : M4Y-XG2000

Report No. : ER04-05-023FRF

Page 33 of 64

Test Requirement: 15.205

The frequency spectrum above 1 GHz was investigated. All emissions not reported below are more than 40 dB below the prescribed limits. Readings are both peak and average values.

Company	Z-Com, Inc.	Test Date :	2003/8/20
Product Name	IEEE 802.11g 54Mbps Wireless Router	Test By:	Alan Fan
Model Name	XG-2000	TEMP&Humidity :	27.9°C , 46%

CH1 TX				Measurement Distance at 1m				Vertical polarity			
Freq.	Reading	AF	Cable	Pre-amp	Dist	Filter	Level	Limit	Margin	Mark	Height
(MHz)	(dBuV)	(dBuV)	(dB)	(dB)	dB	dB	(dBuV/m)	(dBuV/m)	(dB)	(P/Q/A)	(Meter)
*2387.54	51.21	(delta between carrier and local max emission)					60.06	74	-13.94	P	1.00
*2387.54	51.21	(delta between carrier and local max emission)					52.86	54	-1.14	A	1.00
2413.29	86.62	31.79	2.36	0.00	9.50	0.00	111.27	Fundamental Frequency		P	1.04
2413.29	79.42	31.79	2.36	0.00	9.50	0.00	104.07			A	1.04
*4823.91	52.45	34.44	2.77	35.38	9.50	1.00	45.78	74	-28.22	P	1.00
*4823.91	44.41	34.44	2.77	35.38	9.50	1.00	37.74	54	-16.26	A	1.00
7239.85	52.31	39.80	3.95	35.56	9.50	1.00	52.00	74	-22.00	P	1.00
7239.85	34.35	39.80	3.95	35.56	9.50	1.00	34.04	54	-19.96	A	1.00
9647.91	55.17	38.54	4.10	35.67	9.50	1.00	53.63	74	-20.37	P	1.12
9647.91	53.37	38.54	4.10	35.67	9.50	1.00	51.83	54	-2.17	A	1.12
*12066.45	-----	-----	-----	-----	9.50	1.00	-----	-----	-----	-----	1.00
*14479.74	-----	-----	-----	-----	9.50	1.00	-----	-----	-----	-----	1.00
16893.03	-----	-----	-----	-----	9.50	1.00	-----	-----	-----	-----	1.00
*19306.32	-----	-----	-----	-----	9.50	1.00	-----	-----	-----	-----	1.00
21719.61	-----	-----	-----	-----	9.50	1.00	-----	-----	-----	-----	1.00
24132.90	-----	-----	-----	-----	9.50	1.00	-----	-----	-----	-----	1.00

Note :

- The measurement was searched to 10th harmonic, Remark “---” means that the emissions level is too low to be measured.
- AF: Antenna Factor, Cable: Cable Loss, Pre-Amp: Preamplifier gain, Filter: High Pass Filter Insertion Loss (3.5GHz)
- Analyzer setting P(Peak): RBW=1MHz, VBW=1MHz, A(Average): RBW=1MHz, VBW=10Hz
- Remark “*” means the Restricted band.
- Dist : correction to extra plate reading to 3m specification distance 1m measurement distance = -9.5dB
- The result basic equation calculation is as follow:
 $Level = Reading + AF + Cable - Preamp + Filter - Dist$, $Margin = Level - Limit$
- The other emission levels were very low against the limit
- The test limit distance is 3M limit.
- For 802.11b mode at 11Mbps.



Ecom Sertech Corp.

Rm. 258, Bldg. 17, NO.195, Sec. 4 Chung Hsing Rd., ChuTung Chen, Hsinchu, Taiwan 310, R.O.C
 TEL:886-3-5918012 FAX : 886-3-5825720

FCC ID : M4Y-XG2000
 Report No. : ER04-05-023FRF
 Page 34 of 64

Test Requirement: 15.205

The frequency spectrum above 1 GHz was investigated. All emissions not reported below are more than 40 dB below the prescribed limits. Readings are both peak and average values.

Company	Z-Com, Inc.	Test Date :	2003/8/20
Product Name	IEEE 802.11g 54Mbps Wireless Router	Test By:	Alan Fan
Model Name	XG-2000	TEMP&Humidity :	27.9°C , 46%

CH6 TX				Measurement Distance at 1m				Horizontal polarity			
Freq.	Reading	AF	Cable	Pre-amp	Dist	Filter	Level	Limit	Margin	Mark	Height
(MHz)	(dBuV)	(dBuV)	(dB)	(dB)	dB	dB	(dBuV/m)	(dBuV/m)	(dB)	(P/Q/A)	(Meter)
2438.29	77.43	31.76	2.43	0.00	9.50	0.00	102.12	Fundamental Frequency		P	1.08
2438.29	70.36	31.76	2.43	0.00	9.50	0.00	95.05			A	1.08
*4873.98	51.31	34.77	2.80	35.40	9.50	1.00	44.98	74	-29.02	P	1.00
*4873.98	45.46	34.77	2.80	35.40	9.50	1.00	39.13	54	-14.87	A	1.00
*7311.06	44.97	39.78	4.00	35.57	9.50	1.00	44.68	74	-29.32	P	1.00
*7311.06	34.46	39.78	4.00	35.57	9.50	1.00	34.17	54	-19.83	A	1.00
9748.03	52.64	38.53	4.02	35.72	9.50	1.00	50.96	74	-23.04	P	1.00
9748.03	46.83	38.53	4.02	35.72	9.50	1.00	45.15	54	-8.85	A	1.00
*12191.45	-----	-----	-----	-----	9.50	1.00	-----	-----	-----	-----	1.00
14629.74	-----	-----	-----	-----	9.50	1.00	-----	-----	-----	-----	1.00
17068.03	-----	-----	-----	-----	9.50	1.00	-----	-----	-----	-----	1.00
*19506.32	-----	-----	-----	-----	9.50	1.00	-----	-----	-----	-----	1.00
21944.61	-----	-----	-----	-----	9.50	1.00	-----	-----	-----	-----	1.00
24382.90	-----	-----	-----	-----	9.50	1.00	-----	-----	-----	-----	1.00

Note :

- The measurement was searched to 10th harmonic, Remark “---” means that the emissions level is too low to be measured.
- AF: Antenna Factor, Cable: Cable Loss, Pre-Amp: Preamplifier gain, Filter: High Pass Filter Insertion Loss (3.5GHz)
- Analyzer setting P(Peak): RBW=1MHz, VBW=1MHz, A(Average): RBW=1MHz, VBW=10Hz
- Remark “*” means the Restricted band.
- Dist : correction to extra plate reading to 3m specification distance 1m measurement distance = -9.5dB
- The result basic equation calculation is as follow:
 $Level = Reading + AF + Cable - Preamp + Filter - Dist$, $Margin = Level - Limit$
- The other emission levels were very low against the limit
- The test limit distance is 3M limit.
- For 802.11b mode at 11Mbps.



Ecom Sertech Corp.

Rm. 258, Bldg. 17, NO.195, Sec. 4 Chung Hsing Rd., ChuTung Chen, Hsinchu, Taiwan 310, R.O.C
 TEL:886-3-5918012 FAX: 886-3-5825720

FCC ID : M4Y-XG2000
 Report No. : ER04-05-023FRF
 Page 35 of 64

Test Requirement: 15.205

The frequency spectrum above 1 GHz was investigated. All emissions not reported below are more than 40 dB below the prescribed limits. Readings are both peak and average values.

Company	Z-Com, Inc.	Test Date :	2003/8/20
Product Name	IEEE 802.11g 54Mbps Wireless Router	Test By:	Alan Fan
Model Name	XG-2000	TEMP&Humidity :	27.9°C , 46%

CH6 TX				Measurement Distance at 1m					Vertical polarity			
Freq.	Reading	AF	Cable	Pre-amp	Dist	Filter	Level	Limit	Margin	Mark	Height	
(MHz)	(dBuV)	(dBuV)	(dB)	(dB)	dB	dB	(dBuV/m)	(dBuV/m)	(dB)	(P/Q/A)	(Meter)	
2438.29	85.68	31.76	2.43	0.00	9.50	0.00	110.37	Fundamental Frequency		P	1.17	
2438.29	78.68	31.76	2.43	0.00	9.50	0.00	103.37			A	1.17	
*4874.05	53.69	34.77	2.80	35.40	9.50	1.00	47.36	74	-26.64	P	1.04	
*4874.05	50.42	34.77	2.80	35.40	9.50	1.00	44.09	54	-9.91	A	1.04	
*7310.04	51.16	39.78	4.00	35.57	9.50	1.00	50.87	74	-23.13	P	1.02	
*7310.04	33.56	39.78	4.00	35.57	9.50	1.00	33.27	54	-20.73	A	1.02	
9747.94	55.62	38.53	4.02	35.72	9.50	1.00	53.94	74	-20.06	P	1.08	
9747.94	52.61	38.53	4.02	35.72	9.50	1.00	50.93	54	-3.07	A	1.08	
*12191.45	-----	-----	-----	-----	9.50	1.00	-----	-----	-----	-----	1.00	
14629.74	-----	-----	-----	-----	9.50	1.00	-----	-----	-----	-----	1.00	
17068.03	-----	-----	-----	-----	9.50	1.00	-----	-----	-----	-----	1.00	
*19506.32	-----	-----	-----	-----	9.50	1.00	-----	-----	-----	-----	1.00	
21944.61	-----	-----	-----	-----	9.50	1.00	-----	-----	-----	-----	1.00	
24382.90	-----	-----	-----	-----	9.50	1.00	-----	-----	-----	-----	1.00	

Note :

- The measurement was searched to 10th harmonic, Remark “---” means that the emissions level is too low to be measured.
- AF: Antenna Factor, Cable: Cable Loss, Pre-Amp: Preamplifier gain, Filter: High Pass Filter Insertion Loss (3.5GHz)
- Analyzer setting P(Peak): RBW=1MHz, VBW=1MHz, A(Average): RBW=1MHz, VBW=10Hz
- Remark “*” means the Restricted band.
- Dist : correction to extra plate reading to 3m specification distance 1m measurement distance = -9.5dB
- The result basic equation calculation is as follow:
 $Level = Reading + AF + Cable - Preamp + Filter - Dist, Margin = Level - Limit$
- The other emission levels were very low against the limit
- The test limit distance is 3M limit.
- For 802.11b mode at 11Mbps.



Ecom Sertech Corp.

Rm. 258, Bldg. 17, NO.195, Sec. 4 Chung Hsing Rd., ChuTung Chen, Hsinchu, Taiwan 310, R.O.C
 TEL:886-3-5918012 FAX : 886-3-5825720

FCC ID : M4Y-XG2000
 Report No. : ER04-05-023FRF
 Page 36 of 64

Test Requirement: 15.205

The frequency spectrum above 1 GHz was investigated. All emissions not reported below are more than 40 dB below the prescribed limits. Readings are both peak and average values.

Company	Z-Com, Inc.	Test Date :	2003/8/20
Product Name	IEEE 802.11g 54Mbps Wireless Router	Test By:	Alan Fan
Model Name	XG-2000	TEMP&Humidity :	27.9°C , 46%

CH11 TX				Measurement Distance at 1m				Horizontal polarity			
Freq.	Reading	AF	Cable	Pre-amp	Dist	Filter	Level	Limit	Margin	Mark	Height
(MHz)	(dBuV)	(dBuV)	(dB)	(dB)	dB	dB	(dBuV/m)	(dBuV/m)	(dB)	(P/Q/A)	(Meter)
2463.29	76.70	31.74	2.49	0.00	9.50	0.00	101.43	Fundamental Frequency		P	1.03
2463.29	69.35	31.74	2.49	0.00	9.50	0.00	94.08			A	1.03
*2483.65	50.18	(delta between carrier and local max emission)					51.25	74	-22.75	P	1.00
*2483.65	50.18	(delta between carrier and local max emission)					43.90	54	-10.10	A	1.00
*4924.04	49.00	35.10	2.83	35.41	9.50	1.00	43.02	74	-30.98	P	1.01
*4924.04	42.97	35.10	2.83	35.41	9.50	1.00	36.99	54	-17.01	A	1.01
*7386.04	42.07	39.75	4.06	35.57	9.50	1.00	41.80	74	-32.20	P	1.01
*7386.04	30.58	39.75	4.06	35.57	9.50	1.00	30.31	54	-23.69	A	1.01
9847.92	52.71	38.52	3.93	35.77	9.50	1.00	50.89	74	-23.11	P	1.04
9847.92	48.69	38.52	3.93	35.77	9.50	1.00	46.87	54	-7.13	A	1.04
*12316.45	-----	-----	-----	-----	9.50	1.00	-----	-----	-----	-----	1.00
14779.74	-----	-----	-----	-----	9.50	1.00	-----	-----	-----	-----	1.00
17243.03	-----	-----	-----	-----	9.50	1.00	-----	-----	-----	-----	1.00
*19706.32	-----	-----	-----	-----	9.50	1.00	-----	-----	-----	-----	1.00
*22169.61	-----	-----	-----	-----	9.50	1.00	-----	-----	-----	-----	1.00
24632.90	-----	-----	-----	-----	9.50	1.00	-----	-----	-----	-----	1.00

Note :

- The measurement was searched to 10th harmonic, Remark “---” means that the emissions level is too low to be measured.
- AF: Antenna Factor, Cable: Cable Loss, Pre-Amp: Preamplifier gain, Filter: High Pass Filter Insertion Loss (3.5GHz)
- Analyzer setting P(Peak): RBW=1MHz, VBW=1MHz, A(Average): RBW=1MHz, VBW=10Hz
- Remark “*” means the Restricted band.
- Dist : correction to extra plate reading to 3m specification distance 1m measurement distance = -9.5dB
- The result basic equation calculation is as follow:
 Level = Reading + AF + Cable - Preamp + Filter - Dist, Margin = Level - Limit
- The other emission levels were very low against the limit
- The test limit distance is 3M limit.
- For 802.11b mode at 11Mbps.



Ecom Sertech Corp.

Rm. 258, Bldg. 17, NO.195, Sec. 4 Chung Hsing Rd., ChuTung Chen, Hsinchu, Taiwan 310, R.O.C
 TEL:886-3-5918012 FAX : 886-3-5825720

FCC ID : M4Y-XG2000
 Report No. : ER04-05-023FRF
 Page 37 of 64

Test Requirement: 15.205

The frequency spectrum above 1 GHz was investigated. All emissions not reported below are more than 40 dB below the prescribed limits. Readings are both peak and average values.

Company	Z-Com, Inc.	Test Date :	2003/8/20
Product Name	IEEE 802.11g 54Mbps Wireless Router	Test By:	Alan Fan
Model Name	XG-2000	TEMP&Humidity :	27.9°C , 46%

CH11 TX				Measurement Distance at 1m				Vertical polarity			
Freq.	Reading	AF	Cable	Pre-amp	Dist	Filter	Level	Limit	Margin	Mark	Height
(MHz)	(dBuV)	(dBuV)	(dB)	(dB)	dB	dB	(dBuV/m)	(dBuV/m)	(dB)	(P/Q/A)	(Meter)
2463.29	85.41	31.74	2.49	0.00	9.50	0.00	110.14	Fundamental Frequency		P	1.00
2463.29	78.37	31.74	2.49	0.00	9.50	0.00	103.10			A	1.00
*2483.65	50.18	(delta between carrier and local max emission)					59.96	74	-14.04	P	1.00
*2483.65	50.18	(delta between carrier and local max emission)					52.92	54	-1.08	A	1.00
*4923.92	52.75	35.10	2.83	35.41	9.50	1.00	46.77	74	-27.23	P	1.00
*4923.92	49.09	35.10	2.83	35.41	9.50	1.00	43.11	54	-10.89	A	1.00
*7389.34	53.71	39.74	4.06	35.57	9.50	1.00	53.44	74	-20.56	P	1.00
*7389.34	32.70	39.74	4.06	35.57	9.50	1.00	32.43	54	-21.57	A	1.00
9848.11	55.21	38.52	3.93	35.77	9.50	1.00	53.39	74	-20.61	P	1.89
9848.11	51.41	38.52	3.93	35.77	9.50	1.00	49.59	54	-4.41	A	1.89
*12316.45	-----	-----	-----	-----	9.50	1.00	-----	-----	-----	-----	1.00
14779.74	-----	-----	-----	-----	9.50	1.00	-----	-----	-----	-----	1.00
17243.03	-----	-----	-----	-----	9.50	1.00	-----	-----	-----	-----	1.00
*19706.32	-----	-----	-----	-----	9.50	1.00	-----	-----	-----	-----	1.00
*22169.61	-----	-----	-----	-----	9.50	1.00	-----	-----	-----	-----	1.00
24632.90	-----	-----	-----	-----	9.50	1.00	-----	-----	-----	-----	1.00

Note :

- The measurement was searched to 10th harmonic, Remark “---” means that the emissions level is too low to be measured.
- AF: Antenna Factor, Cable: Cable Loss, Pre-Amp: Preamplifier gain, Filter: High Pass Filter Insertion Loss (3.5GHz)
- Analyzer setting P(Peak): RBW=1MHz, VBW=1MHz, A(Average): RBW=1MHz, VBW=10Hz
- Remark “*” means the Restricted band.
- Dist : correction to extra plate reading to 3m specification distance 1m measurement distance = -9.5dB
- The result basic equation calculation is as follow:
 Level = Reading + AF + Cable - Preamp + Filter - Dist, Margin = Level - Limit
- The other emission levels were very low against the limit
- The test limit distance is 3M limit.
- For 802.11b mode at 11Mbps.



Ecom Sertech Corp.

Rm. 258, Bldg. 17, NO.195, Sec. 4 Chung Hsing Rd., ChuTung Chen, Hsinchu, Taiwan 310, R.O.C
 TEL:886-3-5918012 FAX : 886-3-5825720

FCC ID : M4Y-XG2000
 Report No. : ER04-05-023FRF
 Page 38 of 64

Test Requirement: 15.205
 The frequency spectrum above 1 GHz was investigated. All emissions not reported below are more than 40 dB below the prescribed limits. Readings are both peak and average values.

Company	Z-Com, Inc.	Test Date :	2003/8/20
Product Name	IEEE 802.11g 54Mbps Wireless Router	Test By:	Alan Fan
Model Name	XG-2000	TEMP&Humidity :	25.4°C , 57%

CH1 TX				Measurement Distance at 1m				Horizontal polarity			
Freq.	Reading	AF	Cable	Pre-amp	Dist	Filter	Level	Limit	Margin	Mark	Height
(MHz)	(dBuV)	(dBuV)	(dB)	(dB)	dB	dB	(dBuV/m)	(dBuV/m)	(dB)	(P/Q/A)	(Meter)
*2389.35	50.57	(delta between carrier and local max emission)					52.38	74	-21.62	P	1.00
*2389.35	50.57	(delta between carrier and local max emission)					42.84	54	-11.16	A	1.00
2412.69	78.30	31.79	2.36	0.00	9.50	0.00	102.95	Fundamental Frequency		P	1.03
2412.69	68.76	31.79	2.36	0.00	9.50	0.00	93.41			A	1.03
*4824.04	47.07	34.44	2.77	35.38	9.50	1.00	40.40	74	-33.60	P	1.01
*4824.04	38.13	34.44	2.77	35.38	9.50	1.00	31.46	54	-22.54	A	1.01
7236.95	39.16	39.81	3.94	35.56	9.50	1.00	38.85	74	-35.15	P	1.17
7236.95	29.04	39.81	3.94	35.56	9.50	1.00	28.73	54	-25.27	A	1.17
9647.94	52.95	38.54	4.10	35.67	9.50	1.00	51.41	74	-22.59	P	1.07
9647.94	49.26	38.54	4.10	35.67	9.50	1.00	47.72	54	-6.28	A	1.07
*12063.45	-----	-----	-----	-----	9.50	1.00	-----	-----	-----	-----	1.00
*14476.14	-----	-----	-----	-----	9.50	1.00	-----	-----	-----	-----	1.00
16888.83	-----	-----	-----	-----	9.50	1.00	-----	-----	-----	-----	1.00
*19301.52	-----	-----	-----	-----	9.50	1.00	-----	-----	-----	-----	1.00
21714.21	-----	-----	-----	-----	9.50	1.00	-----	-----	-----	-----	1.00
24126.90	-----	-----	-----	-----	9.50	1.00	-----	-----	-----	-----	1.00

Note :

- The measurement was searched to 10th harmonic, Remark “---” means that the emissions level is too low to be measured.
- AF: Antenna Factor, Cable: Cable Loss, Pre-Amp: Preamplifier gain, Filter: High Pass Filter Insertion Loss (3.5GHz)
- Analyzer setting P(Peak): RBW=1MHz, VBW=1MHz, A(Average): RBW=1MHz, VBW=10Hz
- Remark “*” means the Restricted band.
- Dist : correction to extra plate reading to 3m specification distance 1m measurement distance = -9.5dB
- The result basic equation calculation is as follow:
 $Level = Reading + AF + Cable - Preamp + Filter - Dist$, $Margin = Level - Limit$
- The other emission levels were very low against the limit
- The test limit distance is 3M limit.
- For 802.11g mode at 6Mbps.



Ecom Sertech Corp.

Rm. 258, Bldg. 17, NO.195, Sec. 4 Chung Hsing Rd., ChuTung Chen, Hsinchu, Taiwan 310, R.O.C
 TEL:886-3-5918012 FAX : 886-3-5825720

FCC ID : M4Y-XG2000
 Report No. : ER04-05-023FRF
 Page 39 of 64

Test Requirement: 15.205

The frequency spectrum above 1 GHz was investigated. All emissions not reported below are more than 40 dB below the prescribed limits. Readings are both peak and average values.

Company	Z-Com, Inc.	Test Date :	2003/8/20
Product Name	IEEE 802.11g 54Mbps Wireless Router	Test By:	Alan Fan
Model Name	XG-2000	TEMP&Humidity :	25.4°C , 57%

CH1 TX				Measurement Distance at 1m				Vertical polarity			
Freq.	Reading	AF	Cable	Pre-amp	Dist	Filter	Level	Limit	Margin	Mark	Height
(MHz)	(dBuV)	(dBuV)	(dB)	(dB)	dB	dB	(dBuV/m)	(dBuV/m)	(dB)	(P/Q/A)	(Meter)
*2389.35	50.57	(delta between carrier and local max emission)					55.75	74	-18.25	P	1.00
*2389.35	50.57	(delta between carrier and local max emission)					46.20	54	-7.80	A	1.00
2413.70	81.67	31.79	2.36	0.00	9.50	0.00	106.32	Fundamental Frequency		P	1.04
2413.70	72.12	31.79	2.36	0.00	9.50	0.00	96.77			A	1.04
*4823.97	50.30	34.44	2.77	35.38	9.50	1.00	43.63	74	-30.37	P	1.00
*4823.97	43.20	34.44	2.77	35.38	9.50	1.00	36.53	54	-17.47	A	1.00
7234.79	43.62	39.81	3.94	35.56	9.50	1.00	43.31	74	-30.69	P	1.00
7234.79	33.90	39.81	3.94	35.56	9.50	1.00	33.59	54	-20.41	A	1.00
9647.92	56.15	38.54	4.10	35.67	9.50	1.00	54.61	74	-19.39	P	1.12
9647.92	53.90	38.54	4.10	35.67	9.50	1.00	52.36	54	-1.64	A	1.12
*12068.50	-----	-----	-----	-----	9.50	1.00	-----	-----	-----	-----	1.00
*14482.20	-----	-----	-----	-----	9.50	1.00	-----	-----	-----	-----	1.00
16895.90	-----	-----	-----	-----	9.50	1.00	-----	-----	-----	-----	1.00
*19309.60	-----	-----	-----	-----	9.50	1.00	-----	-----	-----	-----	1.00
21723.30	-----	-----	-----	-----	9.50	1.00	-----	-----	-----	-----	1.00
24137.00	-----	-----	-----	-----	9.50	1.00	-----	-----	-----	-----	1.00

Note :

- The measurement was searched to 10th harmonic, Remark “---” means that the emissions level is too low to be measured.
- AF: Antenna Factor, Cable: Cable Loss, Pre-Amp: Preamplifier gain, Filter: High Pass Filter Insertion Loss (3.5GHz)
- Analyzer setting P(Peak): RBW=1MHz, VBW=1MHz, A(Average): RBW=1MHz, VBW=10Hz
- Remark “*” means the Restricted band.
- Dist : correction to extra plate reading to 3m specification distance 1m measurement distance = -9.5dB
- The result basic equation calculation is as follow:
 $Level = Reading + AF + Cable - Preamp + Filter - Dist$, $Margin = Level - Limit$
- The other emission levels were very low against the limit
- The test limit distance is 3M limit.
- For 802.11g mode at 6Mbps.
- The test data marked in gray background means the EUT emission data is located in the margin uncertainty range of emission limits.



Ecom Sertech Corp.

Rm. 258, Bldg. 17, NO.195, Sec. 4 Chung Hsing Rd., ChuTung Chen, Hsinchu, Taiwan 310, R.O.C
 TEL:886-3-5918012 FAX : 886-3-5825720

FCC ID : M4Y-XG2000
 Report No. : ER04-05-023FRF
 Page 40 of 64

Test Requirement: 15.205

The frequency spectrum above 1 GHz was investigated. All emissions not reported below are more than 40 dB below the prescribed limits. Readings are both peak and average values.

Company	Z-Com, Inc.	Test Date :	2003/8/20
Product Name	IEEE 802.11g 54Mbps Wireless Router	Test By:	Alan Fan
Model Name	XG-2000	TEMP&Humidity :	25.4°C , 57%

CH6 TX				Measurement Distance at 1m					Horizontal polarity			
Freq.	Reading	AF	Cable	Pre-amp	Dist	Filter	Level	Limit	Margin	Mark	Height	
(MHz)	(dBuV)	(dBuV)	(dB)	(dB)	dB	dB	(dBuV/m)	(dBuV/m)	(dB)	(P/Q/A)	(Meter)	
2439.30	76.12	31.76	2.43	0.00	9.50	0.00	100.81	Fundamental Frequency		P	1.08	
2439.30	67.94	31.76	2.43	0.00	9.50	0.00	92.63			A	1.08	
*4874.08	46.16	34.77	2.80	35.40	9.50	1.00	39.83	74	-34.17	P	1.00	
*4874.08	46.27	34.77	2.80	35.40	9.50	1.00	39.94	54	-14.06	A	1.00	
*7311.72	42.85	39.78	4.00	35.57	9.50	1.00	42.56	74	-31.44	P	1.00	
*7311.72	33.47	39.78	4.00	35.57	9.50	1.00	33.18	54	-20.82	A	1.00	
9747.93	52.47	38.53	4.02	35.72	9.50	1.00	50.79	74	-23.21	P	1.00	
9747.93	49.11	38.53	4.02	35.72	9.50	1.00	47.43	54	-6.57	A	1.00	
*12196.50	-----	-----	-----	-----	9.50	1.00	-----	-----	-----	-----	1.00	
14635.80	-----	-----	-----	-----	9.50	1.00	-----	-----	-----	-----	1.00	
17075.10	-----	-----	-----	-----	9.50	1.00	-----	-----	-----	-----	1.00	
*19514.40	-----	-----	-----	-----	9.50	1.00	-----	-----	-----	-----	1.00	
21953.70	-----	-----	-----	-----	9.50	1.00	-----	-----	-----	-----	1.00	
24393.00	-----	-----	-----	-----	9.50	1.00	-----	-----	-----	-----	1.00	

- Note :
- The measurement was searched to 10th harmonic, Remark “---” means that the emissions level is too low to be measured.
 - AF: Antenna Factor, Cable: Cable Loss, Pre-Amp: Preamplifier gain, Filter: High Pass Filter Insertion Loss (3.5GHz)
 - Analyzer setting P(Peak): RBW=1MHz, VBW=1MHz, A(Average): RBW=1MHz, VBW=10Hz
 - Remark “*” means the Restricted band.
 - Dist : correction to extra plate reading to 3m specification distance 1m measurement distance = -9.5dB
 - The result basic equation calculation is as follow:
 $Level = Reading + AF + Cable - Preamp + Filter - Dist$, $Margin = Level - Limit$
 - The other emission levels were very low against the limit
 - The test limit distance is 3M limit.
 - For 802.11g mode at 6Mbps.



Ecom Sertech Corp.

Rm. 258, Bldg. 17, NO.195, Sec. 4 Chung Hsing Rd., ChuTung Chen, Hsinchu, Taiwan 310, R.O.C
 TEL:886-3-5918012 FAX: 886-3-5825720

FCC ID : M4Y-XG2000
 Report No. : ER04-05-023FRF
 Page 41 of 64

Test Requirement: 15.205

The frequency spectrum above 1 GHz was investigated. All emissions not reported below are more than 40 dB below the prescribed limits. Readings are both peak and average values.

Company	Z-Com, Inc.	Test Date :	2003/8/20
Product Name	IEEE 802.11g 54Mbps Wireless Router	Test By:	Alan Fan
Model Name	XG-2000	TEMP&Humidity :	25.4°C , 57%

CH6 TX				Measurement Distance at 1m					Vertical polarity		
Freq.	Reading	AF	Cable	Pre-amp	Dist	Filter	Level	Limit	Margin	Mark	Height
(MHz)	(dBuV)	(dBuV)	(dB)	(dB)	dB	dB	(dBuV/m)	(dBuV/m)	(dB)	(P/Q/A)	(Meter)
2439.30	79.41	31.76	2.43	0.00	9.50	0.00	104.10	Fundamental Frequency		P	1.17
2439.30	71.13	31.76	2.43	0.00	9.50	0.00	95.82			A	1.17
*4873.90	50.87	34.77	2.80	35.40	9.50	1.00	44.54	74	-29.46	P	1.04
*4873.90	44.62	34.77	2.80	35.40	9.50	1.00	38.29	54	-15.71	A	1.04
*7311.75	43.22	39.78	4.00	35.57	9.50	1.00	42.93	74	-31.07	P	1.02
*7311.75	33.28	39.78	4.00	35.57	9.50	1.00	32.99	54	-21.01	A	1.02
9747.91	56.83	38.53	4.02	35.72	9.50	1.00	55.15	74	-18.85	P	1.08
9747.91	54.11	38.53	4.02	35.72	9.50	1.00	52.43	54	-1.57	A	1.08
*12196.50	-----	-----	-----	-----	9.50	1.00	-----	-----	-----	-----	1.00
14635.80	-----	-----	-----	-----	9.50	1.00	-----	-----	-----	-----	1.00
17075.10	-----	-----	-----	-----	9.50	1.00	-----	-----	-----	-----	1.00
*19514.40	-----	-----	-----	-----	9.50	1.00	-----	-----	-----	-----	1.00
21953.70	-----	-----	-----	-----	9.50	1.00	-----	-----	-----	-----	1.00
24393.00	-----	-----	-----	-----	9.50	1.00	-----	-----	-----	-----	1.00

Note :

- The measurement was searched to 10th harmonic, Remark “---” means that the emissions level is too low to be measured.
- AF: Antenna Factor, Cable: Cable Loss, Pre-Amp: Preamplifier gain, Filter: High Pass Filter Insertion Loss (3.5GHz)
- Analyzer setting P(Peak): RBW=1MHz, VBW=1MHz, A(Average): RBW=1MHz, VBW=10Hz
- Remark “*” means the Restricted band.
- Dist : correction to extra plate reading to 3m specification distance 1m measurement distance = -9.5dB
- The result basic equation calculation is as follow:
 $Level = Reading + AF + Cable - Preamp + Filter - Dist, Margin = Level - Limit$
- The other emission levels were very low against the limit
- The test limit distance is 3M limit.
- For 802.11g mode at 6Mbps.
- The test data marked in gray background means the EUT emission data is located in the margin uncertainty range of emission limits.



Ecom Sertech Corp.

Rm. 258, Bldg. 17, NO.195, Sec. 4 Chung Hsing Rd., ChuTung Chen, Hsinchu, Taiwan 310, R.O.C
 TEL:886-3-5918012 FAX: 886-3-5825720

FCC ID : M4Y-XG2000
 Report No. : ER04-05-023FRF
 Page 42 of 64

Test Requirement: 15.205

The frequency spectrum above 1 GHz was investigated. All emissions not reported below are more than 40 dB below the prescribed limits. Readings are both peak and average values.

Company	Z-Com, Inc.	Test Date :	2003/8/20
Product Name	IEEE 802.11g 54Mbps Wireless Router	Test By:	Alan Fan
Model Name	XG-2000	TEMP&Humidity :	25.4°C , 57%

CH11 TX				Measurement Distance at 1m				Horizontal polarity				
Freq.	Reading	AF	Cable	Pre-amp	Dist	Filter	Level	Limit	Margin	Mark	Height	
(MHz)	(dBuV)	(dBuV)	(dB)	(dB)	dB	dB	(dBuV/m)	(dBuV/m)	(dB)	(P/Q/A)	(Meter)	
2464.40	76.23	31.736	2.50	0.00	9.50	0.00	100.96	Fundamental Frequency		P	1.03	
2464.40	68.18	31.736	2.50	0.00	9.50	0.00	92.91			A	1.03	
*2483.65	49.74	(delta between carrier and local max emission)					51.22	74	-22.78		P	1.00
*2483.65	49.74	(delta between carrier and local max emission)					43.17	54	-10.83		A	1.00
*4923.99	45.11	35.10	2.83	35.41	9.50	1.00	39.13	74	-34.87		P	1.01
*4923.99	36.29	35.10	2.83	35.41	9.50	1.00	30.31	54	-23.69		A	1.01
*7386.12	42.04	39.75	4.06	35.57	9.50	1.00	41.77	74	-32.23		P	1.01
*7386.12	32.15	39.75	4.06	35.57	9.50	1.00	31.88	54	-22.12		A	1.01
9847.47	52.78	38.52	3.94	35.77	9.50	1.00	50.96	74	-23.04		P	1.04
9847.47	48.47	38.52	3.94	35.77	9.50	1.00	46.65	54	-7.35		A	1.04
*12322.00	-----	-----	-----	-----	9.50	1.00	-----	-----	-----	-----	-----	1.00
14786.40	-----	-----	-----	-----	9.50	1.00	-----	-----	-----	-----	-----	1.00
17250.80	-----	-----	-----	-----	9.50	1.00	-----	-----	-----	-----	-----	1.00
*19715.20	-----	-----	-----	-----	9.50	1.00	-----	-----	-----	-----	-----	1.00
*22179.60	-----	-----	-----	-----	9.50	1.00	-----	-----	-----	-----	-----	1.00
24644.00	-----	-----	-----	-----	9.50	1.00	-----	-----	-----	-----	-----	1.00

Note :

- The measurement was searched to 10th harmonic, Remark “---” means that the emissions level is too low to be measured.
- AF: Antenna Factor, Cable: Cable Loss, Pre-Amp: Preamplifier gain, Filter: High Pass Filter Insertion Loss (3.5GHz)
- Analyzer setting P(Peak): RBW=1MHz, VBW=1MHz, A(Average): RBW=1MHz, VBW=10Hz
- Remark “*” means the Restricted band.
- Dist : correction to extra plate reading to 3m specification distance 1m measurement distance = -9.5dB
- The result basic equation calculation is as follow:
 Level = Reading + AF + Cable - Preamp + Filter - Dist, Margin = Level - Limit
- The other emission levels were very low against the limit
- The test limit distance is 3M limit.
- For 802.11g mode at 6Mbps.



Ecom Sertech Corp.

Rm. 258, Bldg. 17, NO.195, Sec. 4 Chung Hsing Rd., ChuTung Chen, Hsinchu, Taiwan 310, R.O.C
 TEL:886-3-5918012 FAX: 886-3-5825720

FCC ID : M4Y-XG2000
 Report No. : ER04-05-023FRF
 Page 43 of 64

Test Requirement: 15.205

The frequency spectrum above 1 GHz was investigated. All emissions not reported below are more than 40 dB below the prescribed limits. Readings are both peak and average values.

Company	Z-Com, Inc.	Test Date :	2003/8/20
Product Name	IEEE 802.11g 54Mbps Wireless Router	Test By:	Alan Fan
Model Name	XG-2000	TEMP&Humidity :	25.4°C , 57%

CH11 TX				Measurement Distance at 1m					Vertical polarity		
Freq.	Reading	AF	Cable	Pre-amp	Dist	Filter	Level	Limit	Margin	Mark	Height
(MHz)	(dBuV)	(dBuV)	(dB)	(dB)	dB	dB	(dBuV/m)	(dBuV/m)	(dB)	(P/Q/A)	(Meter)
2464.10	79.15	31.74	2.50	0.00	9.50	0.00	103.88	Fundamental Frequency		P	1.00
2464.10	70.79	31.74	2.50	0.00	9.50	0.00	95.52			A	1.00
*2483.65	49.74	(delta between carrier and local max emission)					54.14	74	-19.86	P	1.00
*2483.65	49.74	(delta between carrier and local max emission)					45.78	54	-8.22	A	1.00
*4923.87	48.29	35.10	2.83	35.41	9.50	1.00	42.31	74	-31.69	P	1.00
*4923.87	42.68	35.10	2.83	35.41	9.50	1.00	36.70	54	-17.30	A	1.00
*7386.60	43.78	39.75	4.06	35.57	9.50	1.00	43.51	74	-30.49	P	1.00
*7386.60	33.75	39.75	4.06	35.57	9.50	1.00	33.48	54	-20.52	A	1.00
9847.99	56.64	38.52	3.93	35.77	9.50	1.00	54.82	74	-19.18	P	1.89
9847.99	54.18	38.52	3.93	35.77	9.50	1.00	52.36	54	-1.64	A	1.89
*12320.50	-----	-----	-----	-----	9.50	1.00	-----	-----	-----	-----	1.00
14784.60	-----	-----	-----	-----	9.50	1.00	-----	-----	-----	-----	1.00
17248.70	-----	-----	-----	-----	9.50	1.00	-----	-----	-----	-----	1.00
*19712.80	-----	-----	-----	-----	9.50	1.00	-----	-----	-----	-----	1.00
*22176.90	-----	-----	-----	-----	9.50	1.00	-----	-----	-----	-----	1.00
24641.00	-----	-----	-----	-----	9.50	1.00	-----	-----	-----	-----	1.00

Note :

- The measurement was searched to 10th harmonic, Remark “---” means that the emissions level is too low to be measured.
- AF: Antenna Factor, Cable: Cable Loss, Pre-Amp: Preamplifier gain, Filter: High Pass Filter Insertion Loss (3.5GHz)
- Analyzer setting P(Peak): RBW=1MHz, VBW=1MHz, A(Average): RBW=1MHz, VBW=10Hz
- Remark “*” means the Restricted band.
- Dist : correction to extra plate reading to 3m specification distance 1m measurement distance = -9.5dB
- The result basic equation calculation is as follow:
 Level = Reading + AF + Cable - Preamp + Filter - Dist, Margin = Level - Limit
- The other emission levels were very low against the limit
- The test limit distance is 3M limit.
- For 802.11g mode at 6Mbps.
- The test data marked in gray background means the EUT emission data is located in the margin uncertainty range of emission limits.

3.7 Photos of Open Site





Ecom Sertech Corp.

Rm. 258, Bldg. 17, NO.195, Sec. 4 Chung Hsing Rd., ChuTung Chen, Hsinchu, Taiwan 310, R.O.C
TEL:886-3-5918012 FAX : 886-3-5825720

FCC ID : M4Y-XG2000
Report No. : ER04-05-023FRF
Page 45 of 64



4. 6dB BANDWIDTH MEASUREMENT

4.1 Test Equipments

Description & Manufacturer	Model No.	Serial No.	Date Of Calibration
ROHDE & SCHWARZ SPECTRUM ANALYZER	FSEK30	835253/002	June 17, 2003
HP ATTENUATOR	8496B	3247A18505	CAL. ON USE
HP PLOTTER	7750A	725A 852141	N/A

NOTE :

1. The measurement uncertainty is less than +/- 2.6dB, which is calculated as per the NAMAS document NIS81.
2. The calibration interval of the above test instruments is 12 months and the calibrations are traceable to NML/ROC and NIST/USA.

4.2 Test Setup

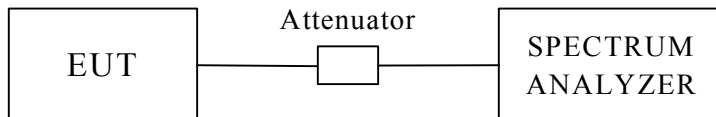

4.3 Limits of 6dB Bandwidth Measurement

The minimum of 6dB Bandwidth Measurement is >500KHz

4.4 Test Procedure

The transmitter output was connected to the spectrum analyzer through an attenuator. The bandwidth of the fundamental frequency was measured by spectrum analyzer with 100 KHz RBW and 100 KHz VBW. The 6dB bandwidth is defined as the total spectrum the power of which is higher than peak power minus 6dB.

4.5 Uncertainty of Conducted Emission

The uncertainty of conducted emission is ± 200KHz.



Ecom Sertech Corp.

Rm. 258, Bldg. 17, NO.195, Sec. 4 Chung Hsing Rd., ChuTung Chen, Hsinchu, Taiwan 310, R.O.C
TEL:886-3-5918012 FAX: 886-3-5825720

FCC ID : M4Y-XG2000
Report No. : ER04-05-023FRF
Page 47 of 64

4.6 Test Results

Input Power (System)	12VDC (Form Adapter)	Environmental Conditions	30.1°C, 47%RH,
Tested By	Alan Fan		

Channel	Channel Frequency (MHz)	6dB Bandwidth (MHz)	Minimum Limit (MHz)	Pass / Fail
1	2412	11.50	0.5	PASS
6	2437	11.08	0.5	PASS
11	2462	11.48	0.5	PASS

Note: For 802.11b mode.

Channel	Channel Frequency (MHz)	6dB Bandwidth (MHz)	Minimum Limit (MHz)	Pass / Fail
1	2412	15.05	0.5	PASS
6	2437	15.01	0.5	PASS
11	2462	14.88	0.5	PASS

Note: For 802.11g mode.



4.7 Photo of 6db Bandwidth Measurement

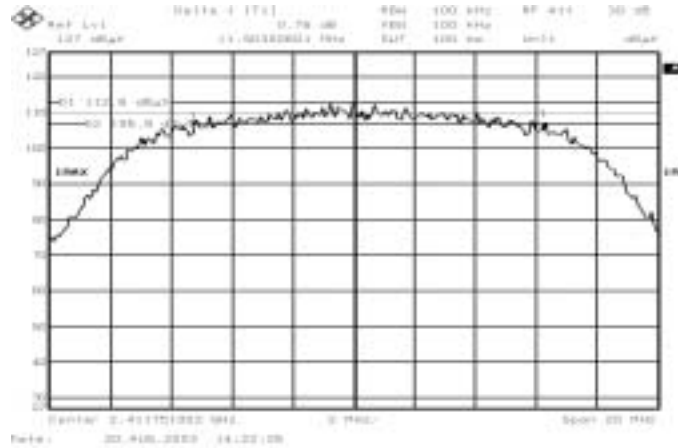

Channel 1

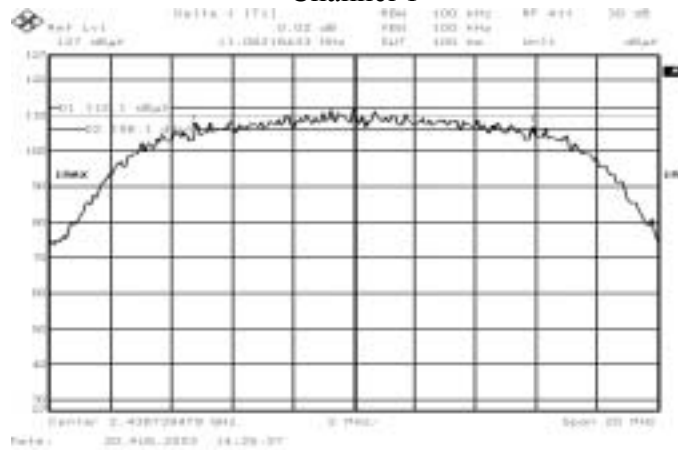

Channel 6

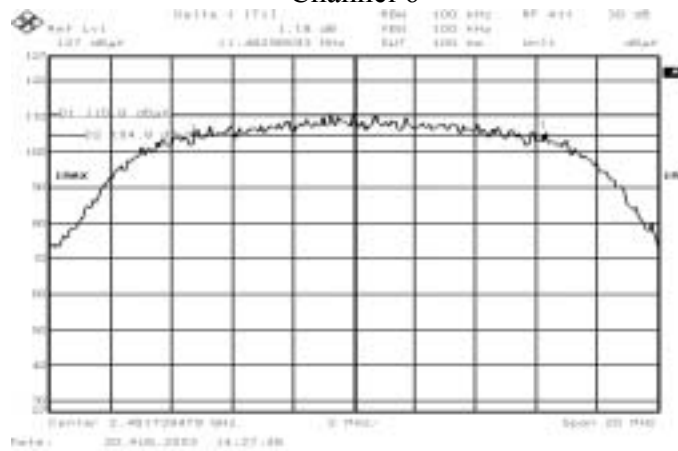

Channel 11

Note : For 11Mbps (802.11b mode)



Ecom Sertech Corp.

Rm. 258, Bldg. 17, NO.195, Sec. 4 Chung Hsing Rd., ChuTung Chen, Hsinchu, Taiwan 310, R.O.C
TEL:886-3-5918012 FAX : 886-3-5825720

FCC ID : M4Y-XG2000
Report No. : ER04-05-023FRF
Page 49 of 64

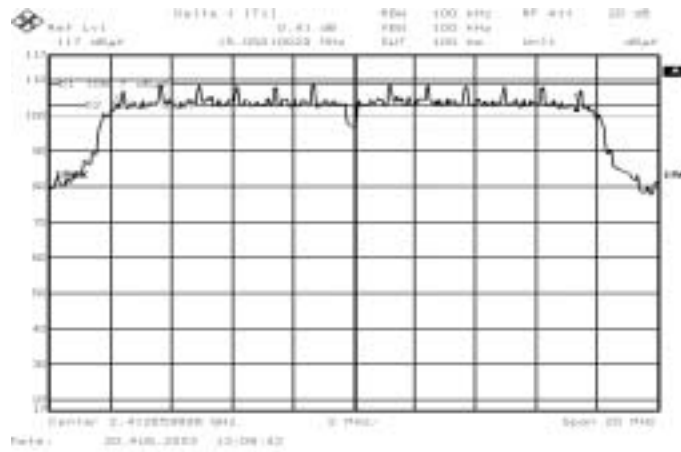

Channel 1

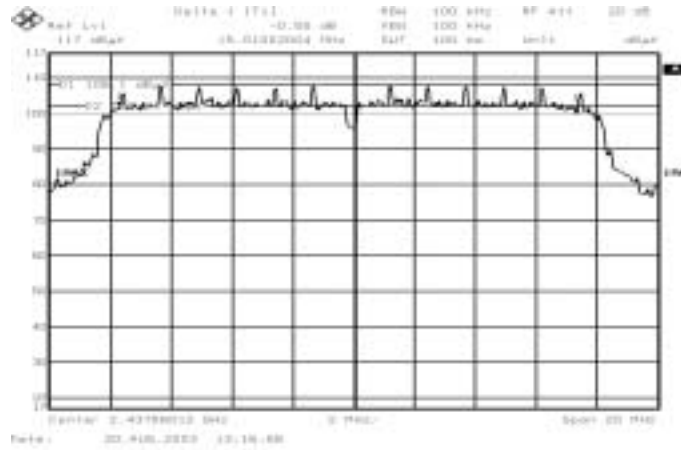

Channel 6

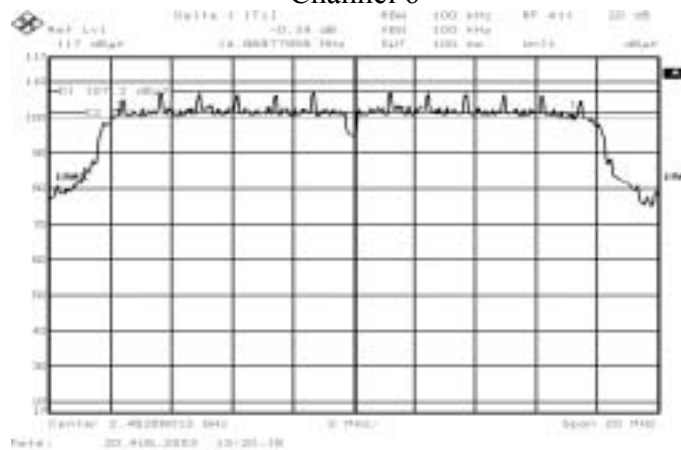

Channel 11

Note : For 54Mbps (802.11g mode)

5. MAXIMUM PEAK OUTPUT POWER

5.1 Test Equipments

Description & Manufacturer	Model No.	Serial No.	Date Of Calibration
ROHDE & SCHWARZ SPECTRUM ANALYZER	FSEK30	835253/002	June 17, 2003
HP ATTENUATOR	8496B	3247A18505	CAL. ON USE
HP PLOTTER	7750A	725A 852141	N/A

NOTE :

1. The measurement uncertainty is less than +/- 2.6dB, which is calculated as per the NAMAS document NIS81.
2. The calibration interval of the above test instruments is 12 months and the calibrations are traceable to NML/ROC and NIST/USA.

5.2 Test Setup

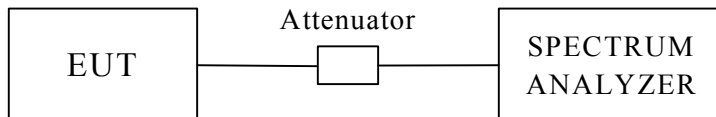

5.3 Limits of Maximum Peak Output Power

The Maximum Peak Output Power Measurement is 30dBm.



5.4 Test Procedure

The RF power output was measured with a Power meter connected to the RF Antenna connector (conducted measurement) while EUT was operating in transmit mode at the appropriate center frequency.

5.5 Uncertainty of Conducted Emission

The uncertainty of conducted emission is ± 1.82 dB.

5.6 Test Results

Input Power (System)	12VDC(Form Adapter)	Environmental Conditions	30.1°C, 47%RH,
Tested By	Alan Fan		

Channel	Channel Frequency (MHz)	Peak Power Output (dBm)	Peak Power Limit (dBm)	Pass / Fail
1	2412	18.95	30	PASS
6	2437	18.04	30	PASS
11	2462	17.12	30	PASS

Note : 1. For 802.11b mode.
 2. At final test to get the worst-case emission at 11Mbps.
 3. The results are calculated as the following equation :
 $Peak\ Power\ Output = Peak\ Power\ Reading + Cable\ loss + Attenuator$

Channel	Channel Frequency (MHz)	Peak Power Output (dBm)	Peak Power Limit (dBm)	Pass / Fail
1	2412	16.55	30	PASS
6	2437	15.79	30	PASS
11	2462	14.99	30	PASS

Note : 1. For 802.11g mode.
 2. At final test to get the worst-case emission at 11Mbps.
 3. The results are calculated as the following equation :
 $Peak\ Power\ Output = Peak\ Power\ Reading + Cable\ loss + Attenuator$

6. POWER SPECTRAL DENSITY MEASUREMENT

6.1 Test Equipments

Description & Manufacturer	Model No.	Serial No.	Date Of Calibration
ROHDE & SCHWARZ SPECTRUM ANALYZER	FSEK30	835253/002	June 17, 2003
HP ATTENUATOR	8496B	3247A18505	CAL. ON USE
HP PLOTTER	7750A	725A 852141	N/A

NOTE :

1. The measurement uncertainty is less than +/- 2.6dB, which is calculated as per the NAMAS document NIS81.
2. The calibration interval of the above test instruments is 12 months and the calibrations are traceable to NML/ROC and NIST/USA.

6.2 Test Setup

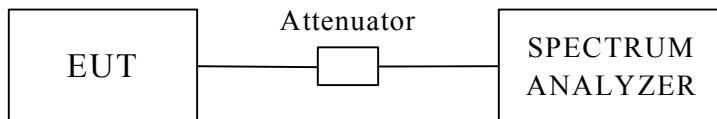

6.3 Limits of Power Spectral Density Measurement

The Maximum Power Spectral Density Measurement is 8dBm.



6.4 Test Procedure

The transmitter output was connected to the spectrum analyzer through an attenuator, the bandwidth of the fundamental frequency was measured with the spectrum analyzer using 3KHz RBW and 30KHz VBW, set sweep time=span / 3KHz.

The power spectral density was measured and recorded.

The sweep time is allowed to be longer than span / 3KHz for a full response of the mixer in the spectrum analyzer.

6.5 Uncertainty of Conducted Emission

The uncertainty of conducted emission is $\pm 1.82\text{dB}$.



6.6 Test Results

Input Power (System)	12VDC(Form Adapter)	Environmental Conditions	30.1°C, 47%RH,
Tested By	Alan Fan		

Channel	Channel Frequency (MHz)	Final RF Power Level in 3KHz BW (dBm)	Maxmum Limit (dBm)	Pass / Fail
1	2412	-7.66	8	PASS
6	2437	-8.94	8	PASS
11	2462	-9.92	8	PASS

- Note: 1. For 11Mbps (802.11b mode) at final test to get the worst-case emission at 11Mbps.
2. Power Spectral Density= Power spectral density reading + attenuator + cable loss.
3. The measurement value of RF Power Level + 10dB attenuator = Final RF Power Level.

Channel	Channel Frequency (MHz)	Final RF Power Level in 3KHz BW (dBm)	Maxmum Limit (dBm)	Pass / Fail
1	2412	-13.34	8	PASS
6	2437	-14.89	8	PASS
11	2462	-15.71	8	PASS

- Note: 1. For 54Mbps (802.11g mode) at final test to get the worst-case emission at 11Mbps.
2. Power Spectral Density= Power spectral density reading + attenuator + cable loss.
3. The measurement value of RF Power Level + 10dB attenuator = Final RF Power Level.



6.7 Photo of Power Spectral Density Measurement

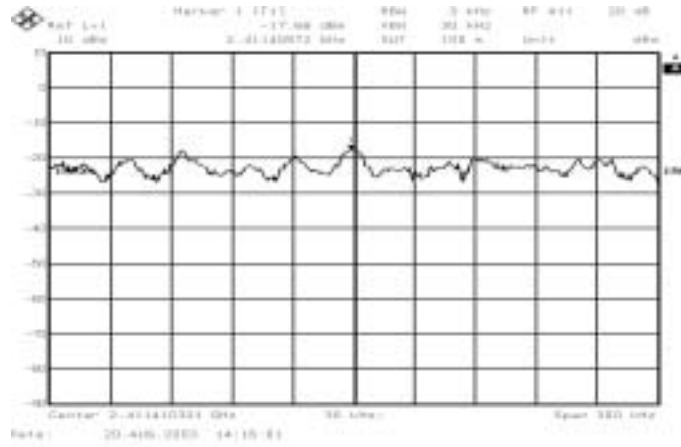

Channel 1

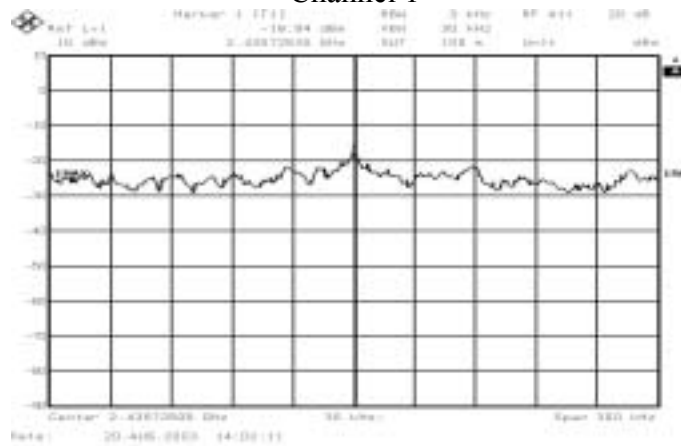

Channel 6

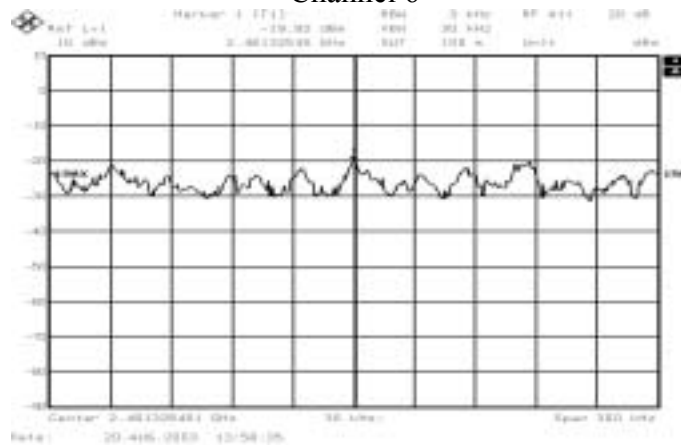

Channel 11
For 802.11b mode (11Mbps)



Ecom Sertech Corp.

Rm. 258, Bldg. 17, NO.195, Sec. 4 Chung Hsing Rd., ChuTung Chen, Hsinchu, Taiwan 310, R.O.C
TEL:886-3-5918012 FAX : 886-3-5825720

FCC ID : M4Y-XG2000
Report No. : ER04-05-023FRF
Page 56 of 64

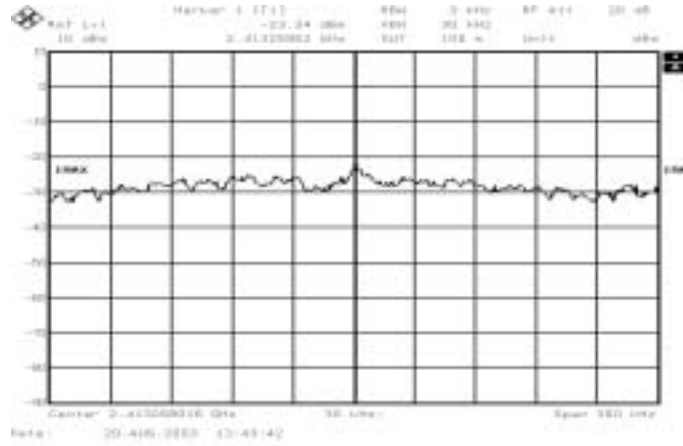

Channel 1

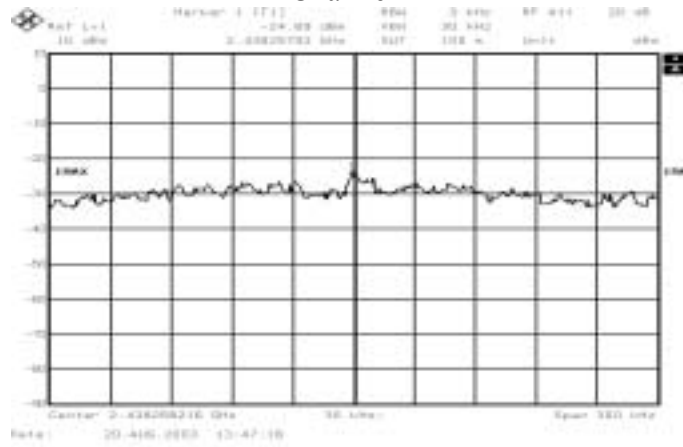

Channel 6

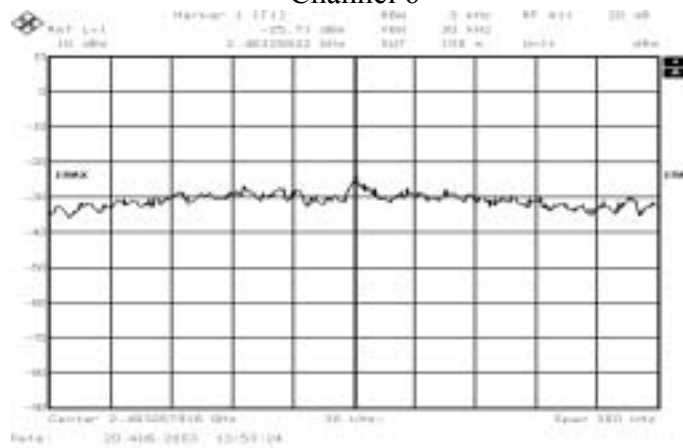

Channel 11
For 802.11g mode (6Mbps)

7. OUT OF BAND MEASUREMENT

7.1 Test Equipments

Description & Manufacturer	Model No.	Serial No.	Date Of Calibration
ROHDE & SCHWARZ SPECTRUM ANALYZER	FSEK30	835253/002	JUN. 17, 2003
HP ATTENUATOR	8496B	3247A18505	CAL. ON USE
HP PLOTTER	7750A	725A 852141	N/A

NOTE :

1. The measurement uncertainty is less than +/- 2.6dB, which is calculated as per the NAMAS document NIS81.
2. The calibration interval of the above test instruments is 12 months and the calibrations are traceable to NML/ROC and NIST/USA.

7.2 Test Setup

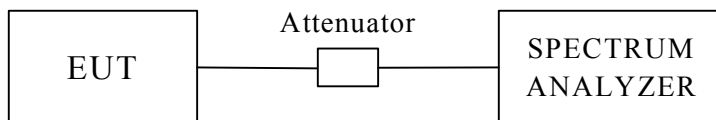

7.3 Limits of Out of Band Emissions Measurement

1. Below -20dB of the highest emission level of operating band (in 100KHz Resolution Bandwidth).
2. Fall in the restricted bands listed in section 15.205. The maximum permitted average field strength is listed in section 15.209.



7.4 Test Procedure

The transmitter output was connected to the spectrum analyzer via a low lose cable. Set both RBW and VBW of spectrum analyzer with suitable frequency span including 100KHz bandwidth from band edge. The band edges was measured and recorded.

7.5 Uncertainty of Conducted Emission

The uncertainty of conducted emission is ± 1.82 dB.

7.6 Test Results

A. Conducted

Refer to 7.7 photo of band edge Emission measurement

B. Radiated

For 802.11b Mode

Refer to the section 3.6, the measured radiated band edge emissions are listed below :

Input Power (System)	12VDC (From Adapter)	Environmental Conditions	30.1°C, 47%RH
Tested By	Alan Fan		

Band edge		Measured radiated band edge field strength (dBuV/m)		Radiated band edge field strength limit (dBuV/m)		Test result
		Horizontal	Vertical	Horizontal	Vertical	
2400.00	PK	60.56	69.72	82.11	91.27	PASS
	AVG	53.49	62.52	75.04	84.07	
2483.50	PK	52.02	60.73	74.00	74.00	PASS
	AVG	44.67	53.69	54.00	54.00	

Note : Radiated band edge field strength is measured with FCC recommended mark-delta method.

Measured radiated band edge field strength Test Results = Radiated fundamental emission field strength - DELTA.

DELTA = Relative measurement between conducted measured peak level of fundamental emission and relevant band edge emission. Please refer to 7.7 photo of band edge Measurement.

**Ecom Sertech Corp.**

Rm. 258, Bldg. 17, NO.195, Sec. 4 Chung Hsing Rd., ChuTung Chen, Hsinchu, Taiwan 310, R.O.C
 TEL:886-3-5918012 FAX: 886-3-5825720

FCC ID : M4Y-XG2000

Report No. : ER04-05-023FRF

Page 59 of 64

For 802.11g Mode

Refer to the section 3.6, the measured radiated band edge emissions are listed below :

Input Power (System)	12VDC (From Adapter)	Environmental Conditions	30.1°C, 47%RH
Tested By	Alan Fan		

Band edge		Measured radiated band edge field strength (dBuV/m)		Radiated band edge field strength limit (dBuV/m)		Test result
		Horizontal	Vertical	Horizontal	Vertical	
2400.00	PK	69.01	72.38	82.95	86.32	PASS
	AVG	59.47	62.83	73.41	76.77	
2483.50	PK	51.89	54.81	74.00	74.00	PASS
	AVG	43.84	46.45	54.00	54.00	

Note : Radiated band edge field strength is measured with FCC recommended mark-delta method.

Measured radiated band edge field strength Test Results = Radiated fundamental emission field strength - DELTA.

DELTA = Relative measurement between conducted measured peak level of fundamental emission and relevant band edge emission. Please refer to 7.7 photo of band edge Measurement.

7.7 Photo of Out of Band Measurement

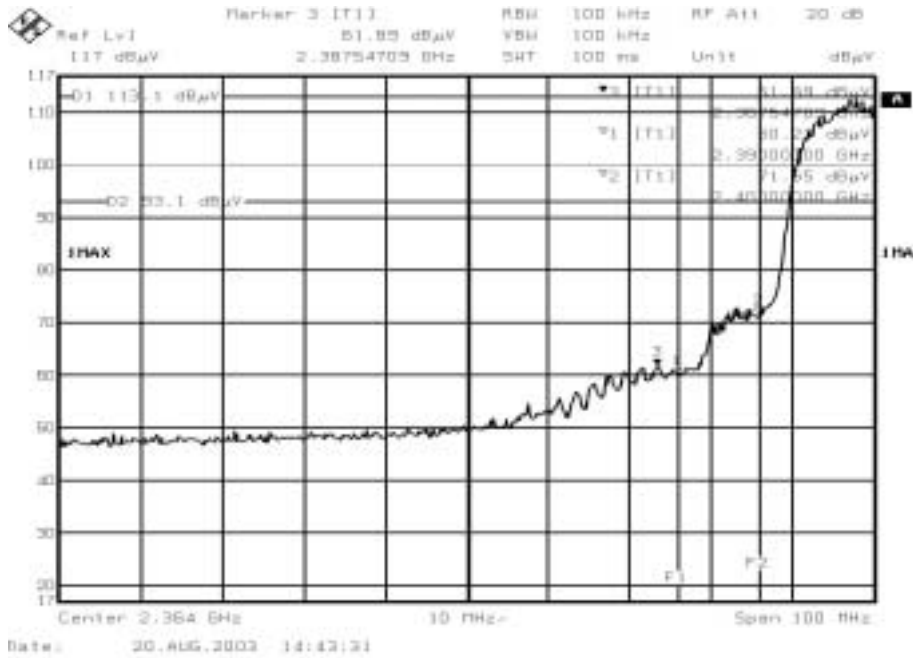

FRONT

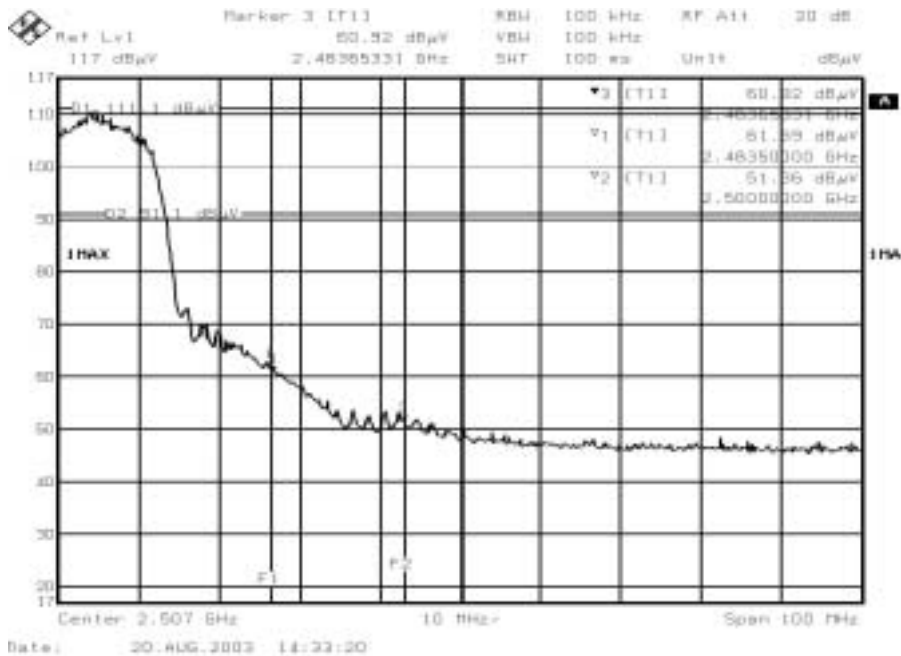

BACK

Note : For 11Mbps (802.11b mode)



Ecom Sertech Corp.

Rm. 258, Bldg. 17, NO.195, Sec. 4 Chung Hsing Rd., ChuTung Chen, Hsinchu, Taiwan 310, R.O.C
TEL:886-3-5918012 FAX : 886-3-5825720

FCC ID : M4Y-XG2000
Report No. : ER04-05-023FRF
Page 61 of 64

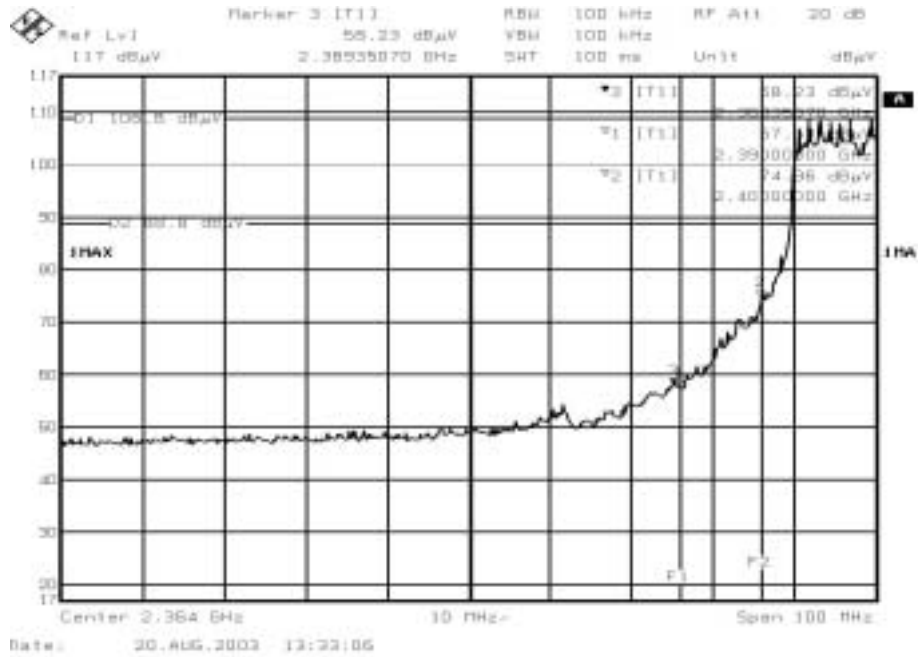

FRONT

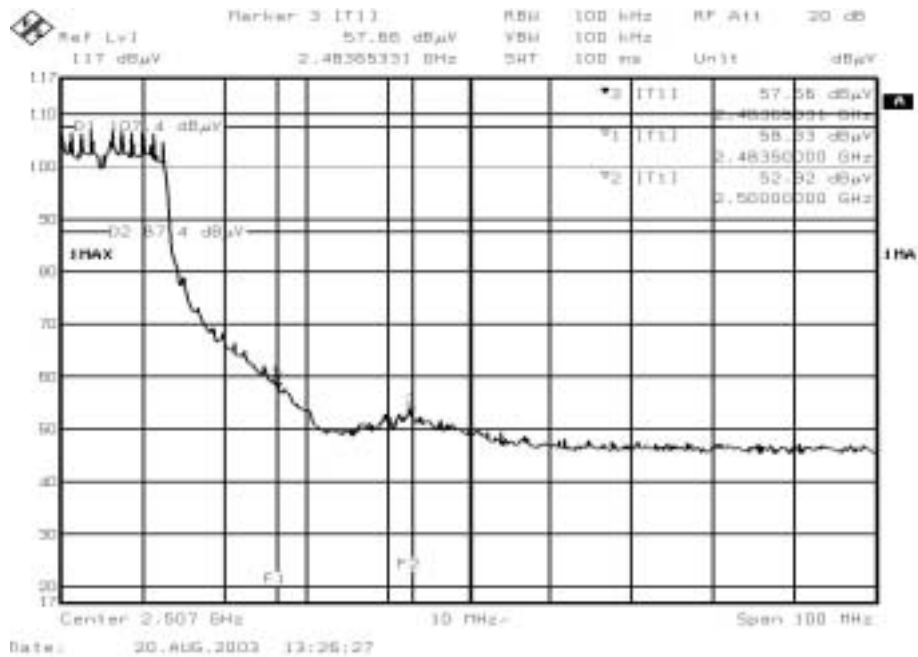

BACK

Note : For 54Mbps (802.11g mode)



8. ANTENNA REQUIREMENT

8.1 Standard Applicable

For intentional device, according to FCC 47 CFR Section 15.203, an intentional radiator shall be designed to ensure that no antenna other than that furnished by the responsible party shall be used with the device.

And according to FCC 47 CFR Section 15.247 (b), if transmitting antennas of directional gain greater than 6dBi are used, the power shall be reduced by the amount in dB that the directional gain of the antenna exceeds 6dBi.

8.2 Antenna Connected Construction

The antenna used in this product is dipole antenna. The dipole antenna connector is Reversed SMA. The maximum Gain of these antennas are only 2dBi.



9. RF EXPOSURE EVALUATION

According to FCC 1.1310 : The criteria listed in the following table shall be used to evaluate the environment impact of human exposure to radio frequency (RF) radiation as specified in 1.1307(b)
LIMITS FOR MAXIMUM PERMISSIBLE EXPOSURE (MPE)

Frequency Range (MHz)	Electric Field Strength (V/m)	Magnetic Field Strength (A/m)	Power Density (mW/cm ²)	Average Time
(A) Limits for Occupational / Control Exposures				
300-1,500	--	--	F/300	6
1,500-100,000	--	--	5	6
(B) Limits for General Population / Uncontrol Exposures				
300-1,500	--	--	F/1500	6
1,500-100,000	--	--	1	30

9.1 Friis Formula

Friis transmission formula : $Pd = (Pout * G) / (4 * pi * r^2)$

Where

Pd = power density in mW/cm²

Pout = output power to antenna in mW

G = gain of antenna in linear scale

Pi = 3.1416

R = distance between observation point and center of the radiator in cm

Pd is the limit of MPE, 1 mW/cm². If we know the maximum gain of the antenna and the total power input to the antenna, through the calculation, we will know the distance r where the MPE limit is reached.

9.2 EUT Operating Condition

A software provided by client enabled the EUT to transmit and receive data at lowest, middle and highest channel individually.



9.3 Test Result of RF Exposure Evaluation

Test Item : RF Exposure Evaluation Data
Test Mode : Normal Operation

9.3.1 Antenna Gain

Antenna Gain : The maximum Gain measured in fully anechoic chamber is 2dBi linear scale.

9.3.2 Output Power into Antenna & RF Exposure Evaluation Distance

Channel	Channel Frequency (MHz)	Output Power to Antenna (dBm)	Power Density at 20cm (mW/cm ²)	LIMITS (mW/cm ²)
CH1	2412.00	18.95	0.024759	1
CH6	2437.00	18.04	0.020078	1
CH11	2462.00	17.12	0.016245	1

Note : 1. For 802.11b mode (11Mbps).
2. The power density Pd (4th column) at a distance of 20cm calculated from the Friis transmission formula is far below the limit of 1 mW/cm² . The EUT is classified as mobile product. So, RF exposure limit warning or SAR test are not required.

Channel	Channel Frequency (MHz)	Output Power to Antenna (dBm)	Power Density at 20cm (mW/cm ²)	LIMITS (mW/cm ²)
CH1	2412.00	16.55	0.014247	1
CH6	2437.00	15.79	0.011960	1
CH11	2462.00	14.99	0.009948	1

Note : 1. For 802.11g mode (54Mbps).
2. The power density Pd (4th column) at a distance of 20cm calculated from the Friis transmission formula is far below the limit of 1 mW/cm² . The EUT is classified as mobile product. So, RF exposure limit warning or SAR test are not required.