

EMC TEST REPORT

Report No.: TS09010011-EME
Model No.: VUS100,VUS100SI,
VUS-100P, VUS-100V
Issued Date: Mar. 17, 2009

Applicant: Z-Com, Inc.
7F-2, No. 9. Prosperity RD. I Science-Based Industrial
Park, Hsinchu, 300 Taiwan

**Test Method/
Standard:** 47 CFR FCC Part 15.247 & ANSI C63.4 2003

Test By: Intertek Testing Services Taiwan Ltd.
No. 11, Lane 275, Ko-Nan 1 Street, Chia-Tung Li,
Shiang-Shan District, Hsinchu City, Taiwan

It may be duplicated completely for legal use with the allowance of the applicant.
It shall not be reproduced except in full, without the written approval of Intertek
Laboratory. The test result(s) in this report only applies to the tested sample(s).

The test report was prepared by: Sign on File
Sammi Liu/ Assistant

These measurements were taken by: Sign on File
Leon Cheng/ Engineer

The test report was reviewed by:

Name Kevin Chen
Title Chief Engineer

Table of Contents

1. Summary of Test Data.....	3
2. General Information	4
3. Maximum 6 dB Bandwidth	8
4. 99 % Occupied Bandwidth	16
5. Maximum Output Power	24
6. Power Spectral Density	26
7. RF Antenna conducted Spurious.....	34
8. Radiated Spurious Emission	53
9. Emission on Band Edge.....	62
Appendix A: Test Equipment List.....	77

1. Summary of Test Data

Test/Requirement Description	Applicable Rule	Result
Minimum 6 dB Bandwidth	15.247(a)(2)	Pass
Maximum Output Power	15.247(b)	Pass
Power Spectral Density	15.247(e)	Pass
RF Antenna Conducted Spurious	15.247(d)	Pass
Radiated Spurious Emission	15.247(d), 15.205, 15.209	Pass
Emission on the Band Edge	15.247(d)	Pass
AC Power Line Conducted Emission	15.207	Pass

2. General Information

Identification of the EUT

Applicant:	Z-Com, Inc.
Product:	IEEE 802.11b/g/n Wireless Media Adapter
Model No.:	VUS-100
FCC ID.:	M4Y-VUS100V03
Frequency Range:	2412MHz ~ 2462MHz
Channel Number:	11 channels for 2412MHz ~ 2462MHz
Rated Power:	DC 5V from adapter model No.: AMS1-0501000FU I/P: 100-240 Vac, 50/60 Hz
Power Cord:	N/A
Data Cable:	USB shielded cable 0.5 meter x1
Sample Received:	Dec. 25, 2008
Test Date(s):	Dec. 25, 2008 ~ Jan. 21, 2009
Note 1:	This report is for the exclusive use of Intertek's Client and is provided pursuant to the agreement between Intertek and its Client. Intertek's responsibility and liability are limited to the terms and conditions of the agreement. Intertek assumes no liability to any party, other than to the Client in accordance with the agreement, for any loss, expense or damage occasioned by the use of this report. Only the Client is authorized to permit copying or distribution of this report and then only in its entirety. Any use of the Intertek name or one of its marks for the sale or advertisement of the tested material, product or service must first be approved in writing by Intertek. The observations and test results in this report are relevant only to the sample tested. This report by itself does not imply that the material, product, or service is or has ever been under an Intertek certification program.
Note 2:	When determining the test conclusion, the Measurement Uncertainty of test has been considered.

Description of EUT

The EUT is an IEEE 802.11b/g/n (1T1R) Wireless Media Adapter, and was defined as information technology equipment.

The customer confirmed the models listed as below are series model to model VUS-100 (EUT), the difference between main model and series model are listed as below.

<u>Model Number</u>	<u>Different firmware</u>
VUS-100	Photo & Video functions
VUS-100SI	Photo & Video functions
VUS-100P	Photo function only
VUS-100V	Video function only

For more detail features, please refer to User's manual as file name "Installation guide.pdf"

Antenna description

The EUT uses a permanently connected antenna.

Antenna Gain : 2.31dBi max
Antenna Type : PCB Printed
Connector Type : N/A

Operation mode

The EUT was supplied with DC 5 V from adapter (test voltage: 120 Vac, 60 Hz) and it was running in operating mode.

The EUT was transmitted continuously during the test.

With individual verifying, the maximum output power was found out 1Mbps data rate for 802.11b mode, 6Mbps data rate for 802.11g mode, 6.5Mbps data rate for 802.11n HT20, 13.5Mbps data rate for 802.11n HT40. The final tests were executed under these conditions and recorded in this report individually. Please refer to following table.

802.11b ch6	
Data rate (Mbps)	PK (dBm)
1	18.50
2	18.32
5.5	18.25
11	17.93

802.11g ch6	
Data rate (Mbps)	PK (dBm)
6	24.01
9	23.88
12	23.85
18	23.70
24	23.55
36	23.35
48	23.21
54	23.08

802.11n(HT20) ch6	
Data rate (Mbps)	PK (dBm)
6.5	21.28
13	21.20
19.5	21.05
26	20.84
39	20.75
52	20.40
58.5	20.15
65	19.98

802.11(HT40) ch6	
Data rate (Mbps)	PK (dBm)
13.5	22.62
27	22.54
40.5	22.44
54	22.57
81	22.35
108	22.18
121.5	22.10
135	21.88

3. Maximum 6 dB Bandwidth

Name of Test	Maximum 6 dB Bandwidth
Base Standard	FCC 15.247 (a)(2)

Test Result: Complies
Measurement Data: See Table 1 & plots below

Method of Measurement:
Reference FCC document: KDB558074

A portion of the transmitted signal is coupled to a Spectrum Analyzer with a resolution bandwidth of at least 1 % of the bandwidth of the transmitted signal. The resolution bandwidth is chosen so as not to reduce the peak level of the measured waveform. The appropriate bandwidth mask is applied to the output waveform to verify compliance.

Test Diagram:

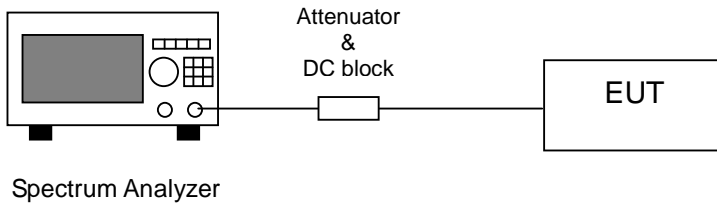

Note: The EUT was tested while in a continuous transmit mode and the worst case data rates are 1 Mbps for 802.11b, 6 Mbps for 802.11g, 6.5Mbps data rate for 802.11n HT20 and 13.5Mbps data rate for 802.11n HT40. The EUT was tuned to a low, middle and high channel.

Table1. Maximum 6 dB Bandwidth

Mode	Channel	Frequency (MHz)	Bandwidth (MHz)	Min. Limit (MHz)	Pass/Fail
802.11b	1	2412	12.24	0.5	Pass
	6	2437	12.64	0.5	Pass
	11	2462	13.12	0.5	Pass
802.11g	1	2412	16.56	0.5	Pass
	6	2437	16.64	0.5	Pass
	11	2462	16.64	0.5	Pass
802.11n HT20	1	2412	17.84	0.5	Pass
	6	2437	17.84	0.5	Pass
	11	2462	17.92	0.5	Pass
802.11n HT40	3	2422	36.80	0.5	Pass
	6	2437	36.80	0.5	Pass
	9	2452	36.80	0.5	Pass

6 dB Bandwidth @ 802.11b mode channel 1

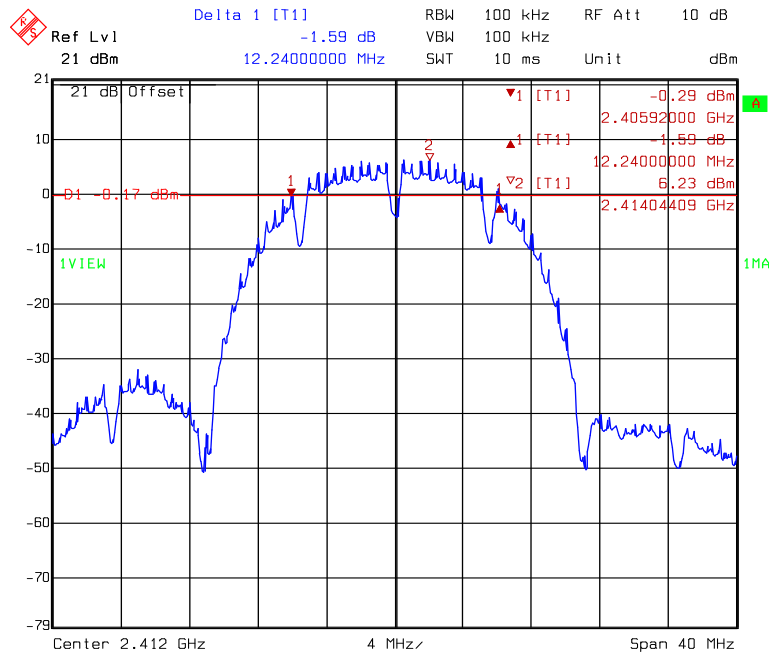

Title: 6dB Band-Width
Comment A: CH 1 at 802.11b mode
Date: 22.JAN.2009 11:58:58

6 dB Bandwidth @ 802.11b mode channel 6

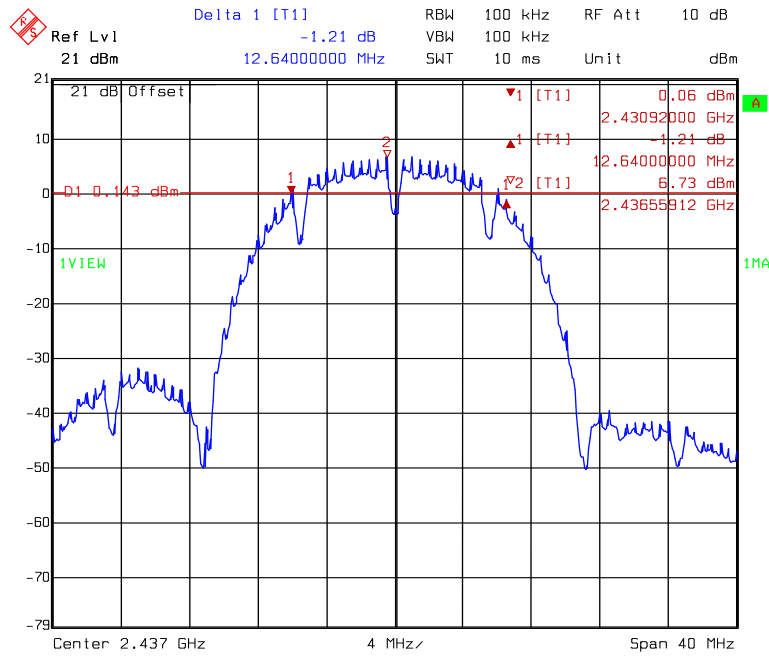

Title: 6dB Band-Width
Comment A: CH 6 at 802.11b mode
Date: 22.JAN.2009 12:02:21

6 dB Bandwidth @ 802.11b mode channel 11

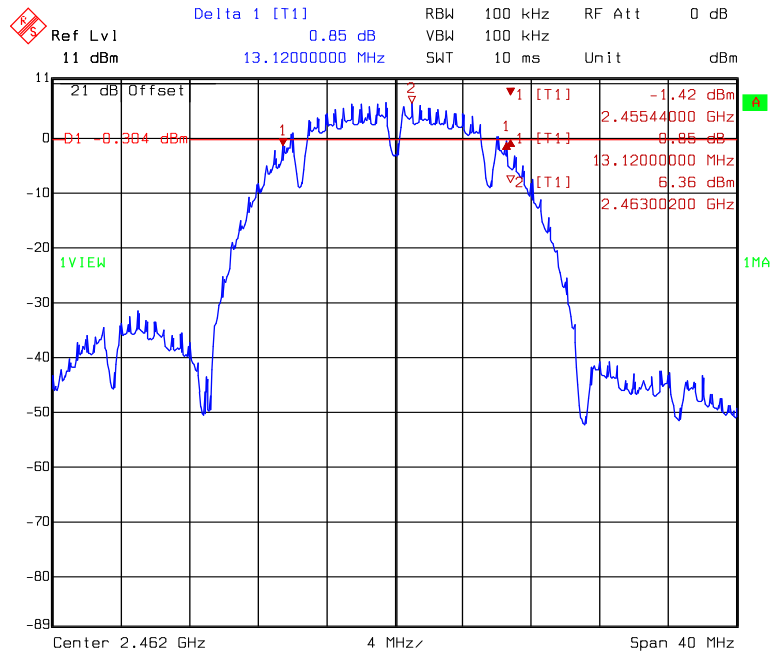

Title: 6dB Band-Width
Comment A: CH 11 at 802.11b mode
Date: 22.JAN.2009 12:05:55

6 dB Bandwidth @ 802.11g mode channel 1

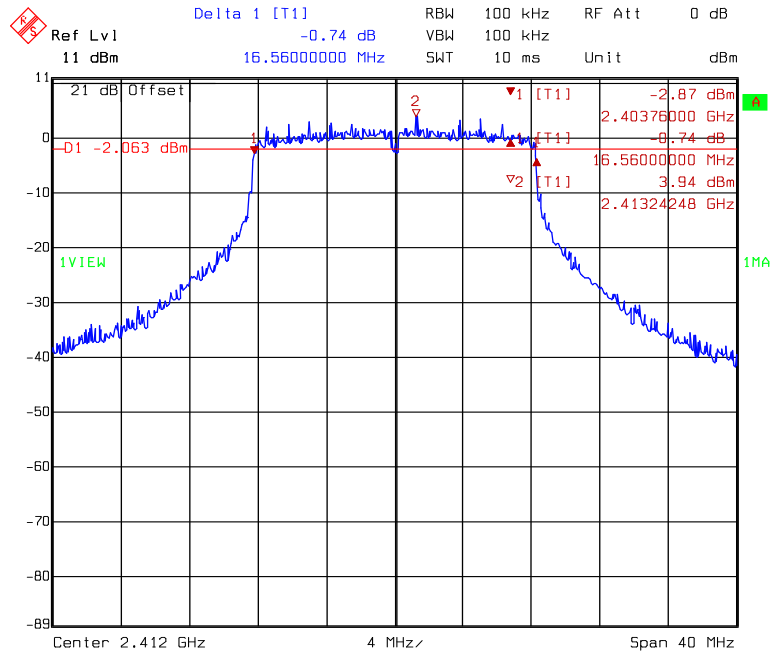

Title: 6dB Band-Width
Comment A: CH 1 at 802.11g mode
Date: 22.JAN.2009 12:09:32

6 dB Bandwidth @ 802.11g mode channel 6

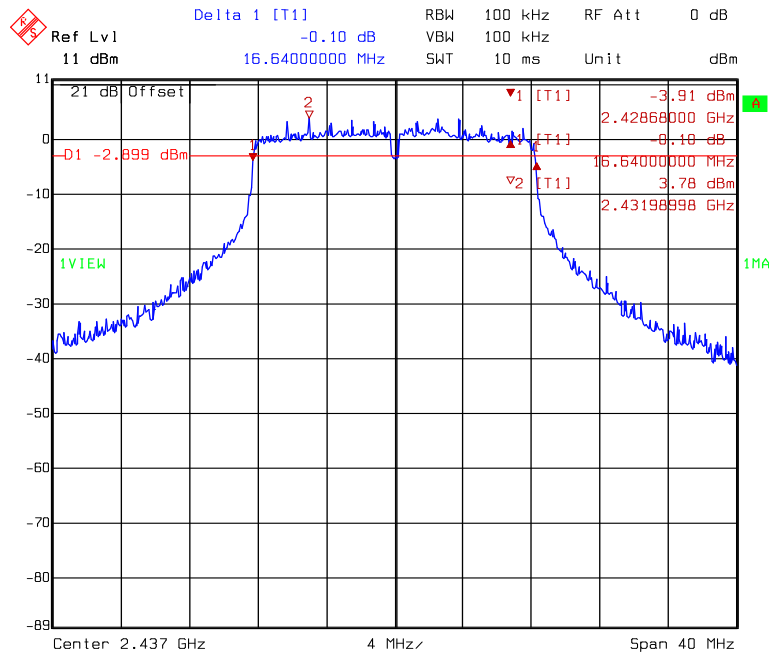

Title: 6dB Band-Width
Comment A: CH 6 at 802.11g mode
Date: 22.JAN.2009 12:14:51

6 dB Bandwidth @ 802.11g mode channel 11

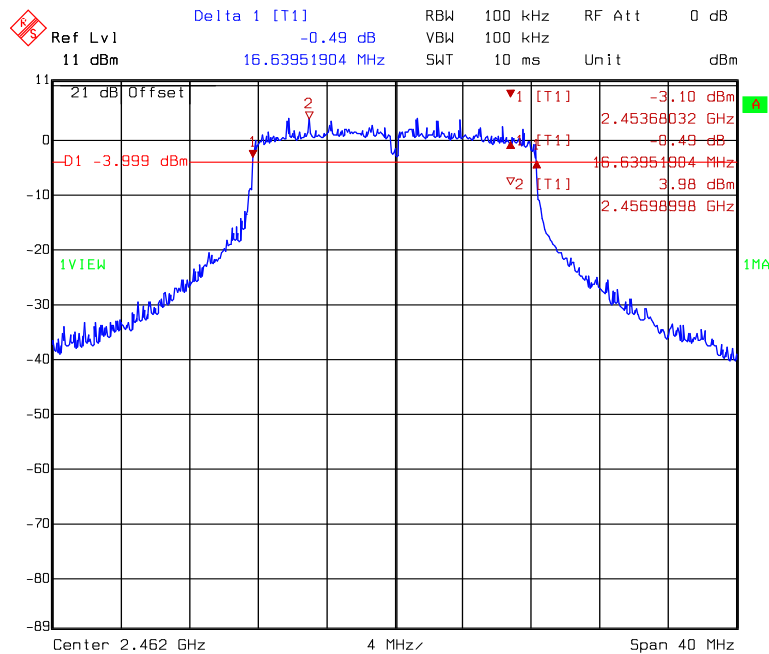

Title: 6dB Band-Width
Comment A: CH 11 at 802.11g mode
Date: 22.JAN.2009 12:17:21

6dB Bandwidth @ 802.11n HT20 mode channel 1

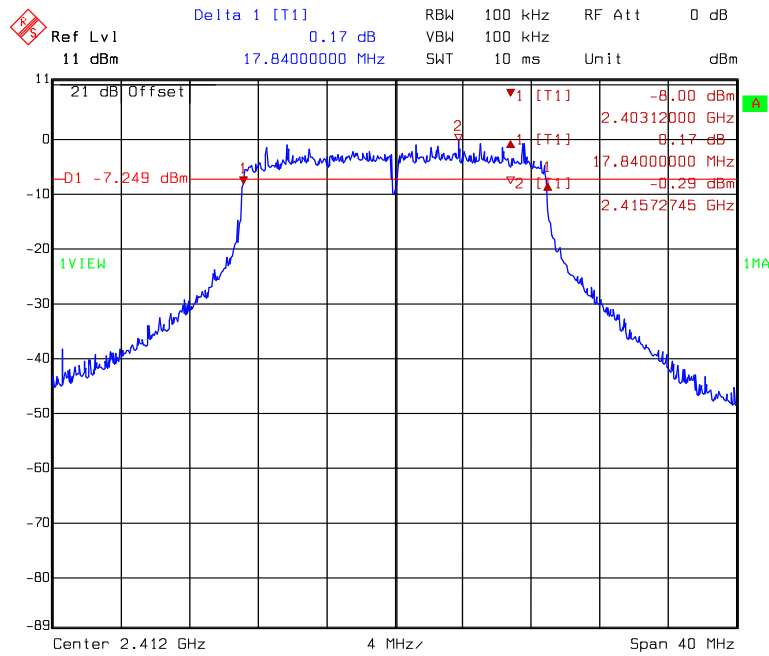

Title: 6dB Band-Width
 Comment A: CH 1 at 802.11n 20MHz mode
 Date: 22.JAN.2009 11:45:16

6dB Bandwidth @ 802.11n HT20 mode channel 6

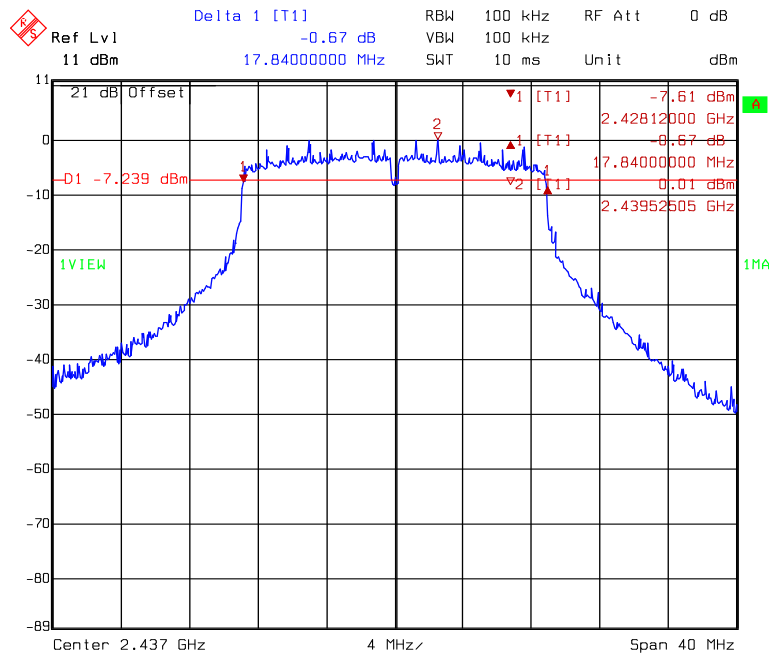

Title: 6dB Band-Width
 Comment A: CH 6 at 802.11n 20MHz mode
 Date: 22.JAN.2009 11:48:14

6dB Bandwidth @ 802.11n HT20 mode channel 11

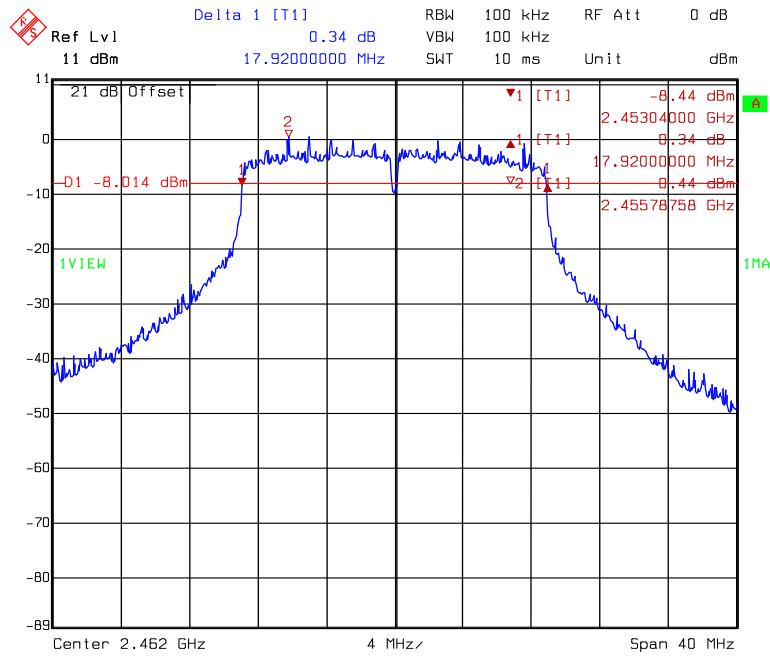

Title: 6dB Band-Width
Comment A: CH 11 at 802.11n 20MHz mode
Date: 22.JAN.2009 11:53:50

6dB Bandwidth @ 802.11n HT40 mode channel 3

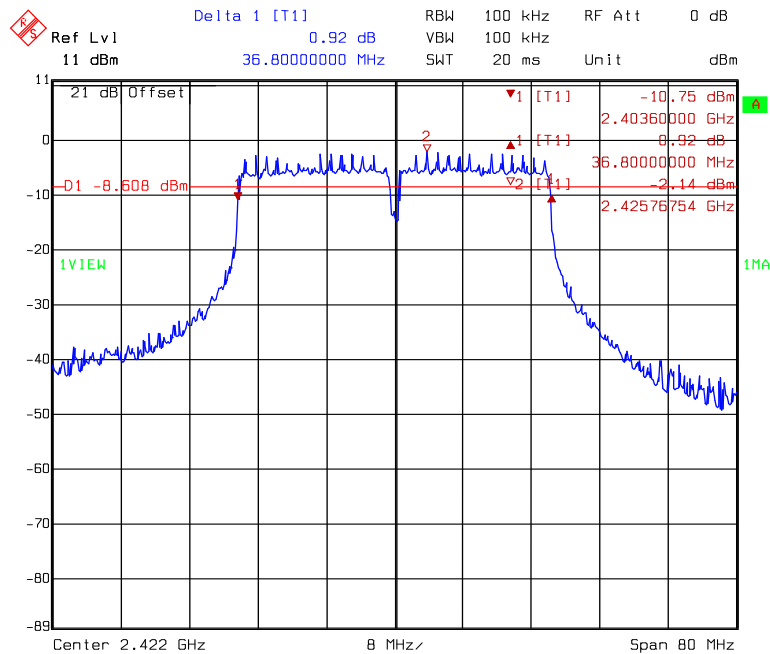

Title: 6dB Band-Width
Comment A: CH 3 at 802.11n 40MHz mode
Date: 22.JAN.2009 11:40:06

6dB Bandwidth @ 802.11n HT40 mode channel 6

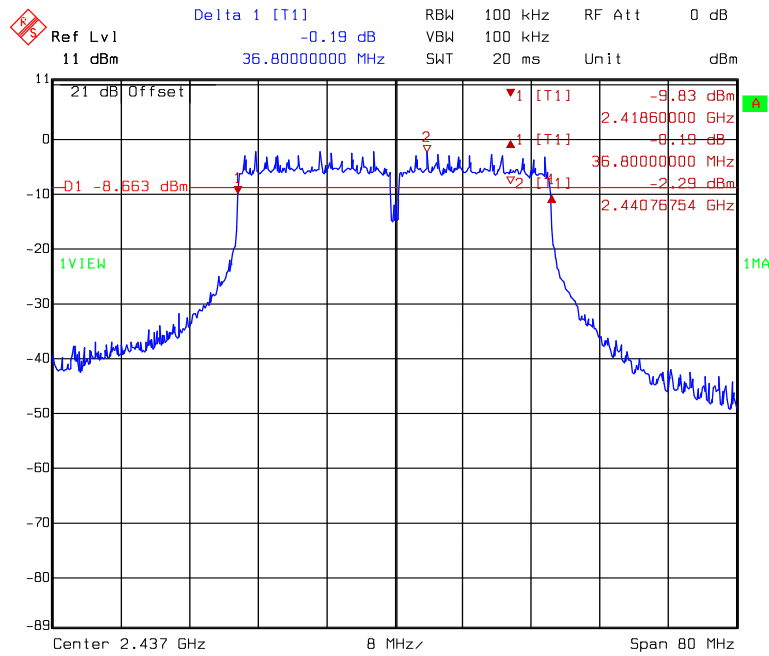

Title: 6dB Band-Width
 Comment A: CH 6 at 802.11n 40MHz mode
 Date: 22.JAN.2009 11:36:18

6dB Bandwidth @ 802.11n HT40 mode channel 9

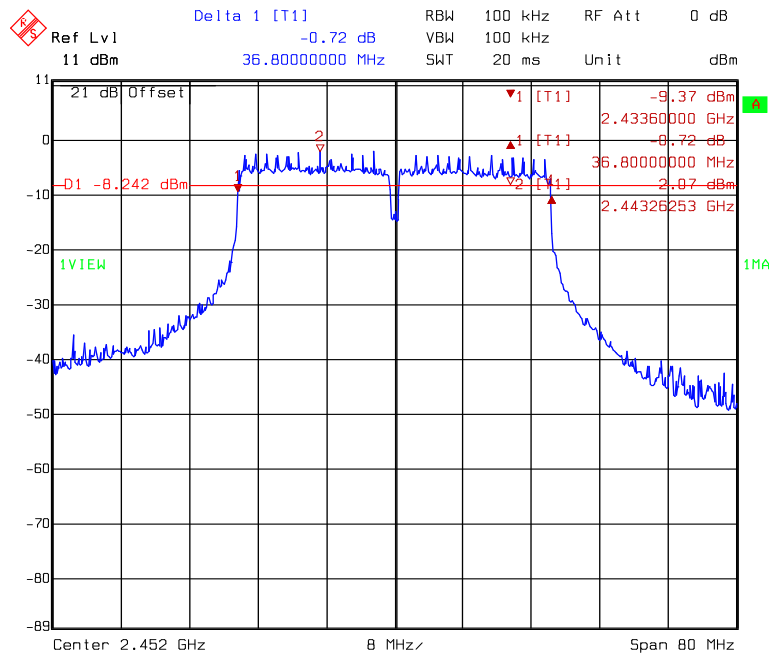

Title: 6dB Band-Width
 Comment A: CH 9 at 802.11n 40MHz mode
 Date: 22.JAN.2009 11:34:51

4. 99 % Occupied Bandwidth

Name of Test	99 % Occupied Bandwidth
Base Standard	None; for reporting purposes only

Test Result: Complies
Measurement Data: See Table & plots below

Method of Measurement:

Reference FCC document: KDB558074

A portion of the transmitted signal is coupled to a Spectrum Analyzer with a resolution bandwidth of at least 1 % of the bandwidth of the transmitted signal. The resolution bandwidth is chosen so as not to reduce the peak level of the measured waveform. The appropriate bandwidth mask is applied to the output waveform to verify compliance.

Test Diagram:

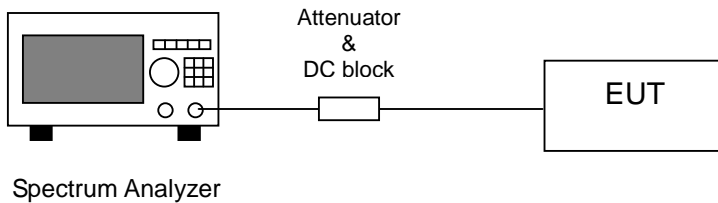

Note: The EUT was tested while in a continuous transmit mode and the worst case data rates are 1 Mbps for 802.11b, 6 Mbps for 802.11g, 6.5Mbps data rate for 802.11n HT20 and 13.5Mbps data rate for 802.11n HT40. The EUT was tuned to a low, middle and high channel.

Table 2. 99 % Occupied Bandwidth

Mode	Channel	Frequency (MHz)	Occupied Bandwidth (MHz)
802.11b	1	2412	15.15
	6	2437	15.23
	11	2462	15.23
802.11g	1	2412	16.51
	6	2437	16.51
	11	2462	16.51
802.11n HT20	1	2412	17.72
	6	2437	17.72
	11	2462	17.72
802.11n HT40	3	2422	36.39
	6	2437	36.39
	9	2452	36.39

99 % Occupied Bandwidth @ 802.11b mode channel 1

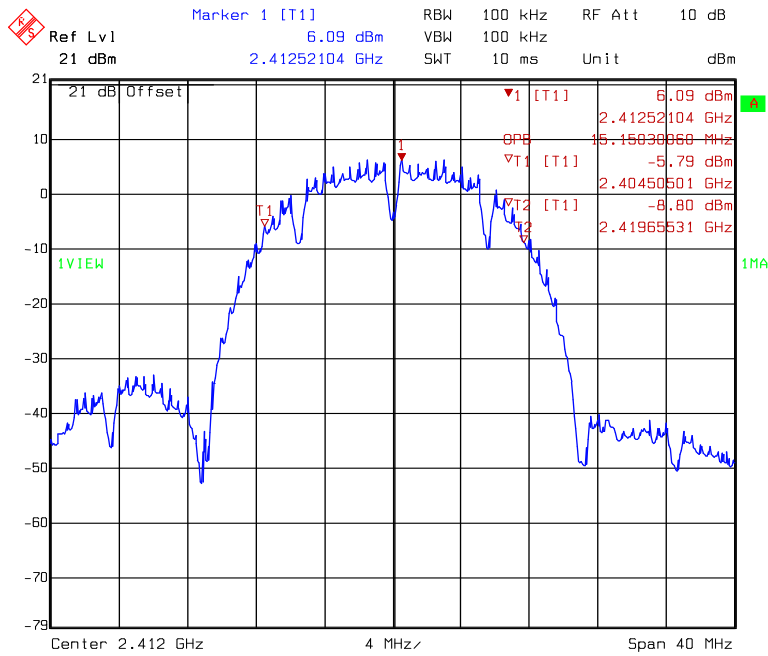

Title: Occupied Band-Width
 Comment A: CH 1 at 802.11b mode
 Date: 22.JAN.2009 12:00:51

99 % Occupied Bandwidth @ 802.11b mode channel 6

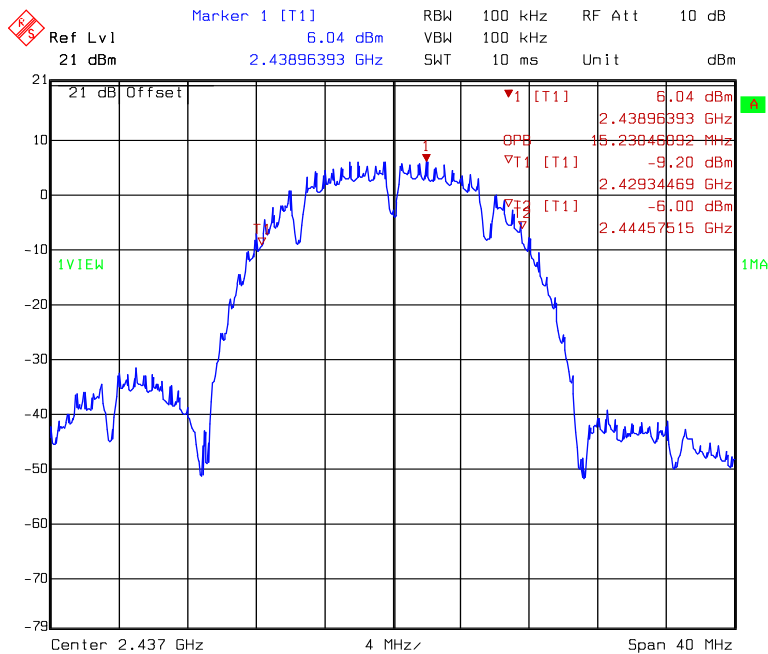

Title: Occupied Band-Width
 Comment A: CH 6 at 802.11b mode
 Date: 22.JAN.2009 12:04:13

99 % Occupied Bandwidth @ 802.11b mode channel 11

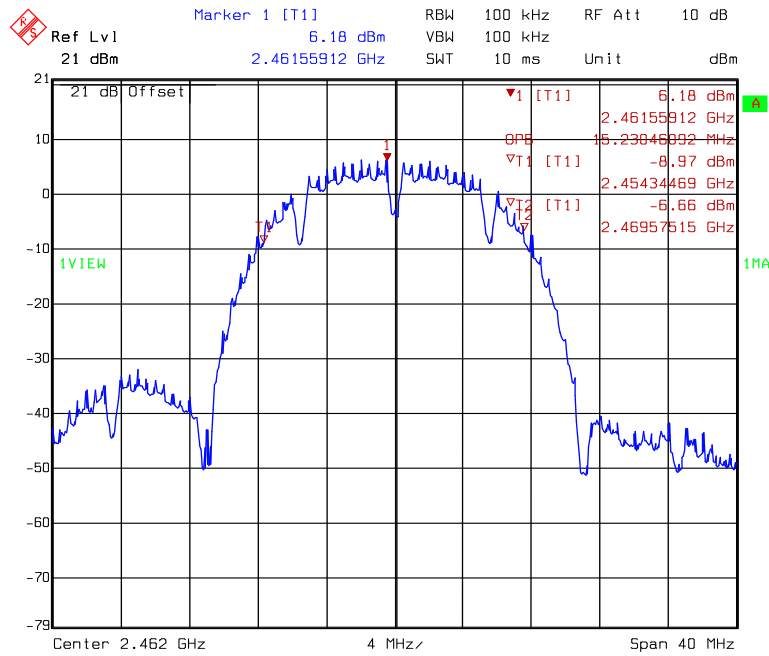

Title: Occupied Band-Width
 Comment A: CH 11 at 802.11b mode
 Date: 22.JAN.2009 12:07:48

99 % Occupied Bandwidth @ 802.11g mode channel 1

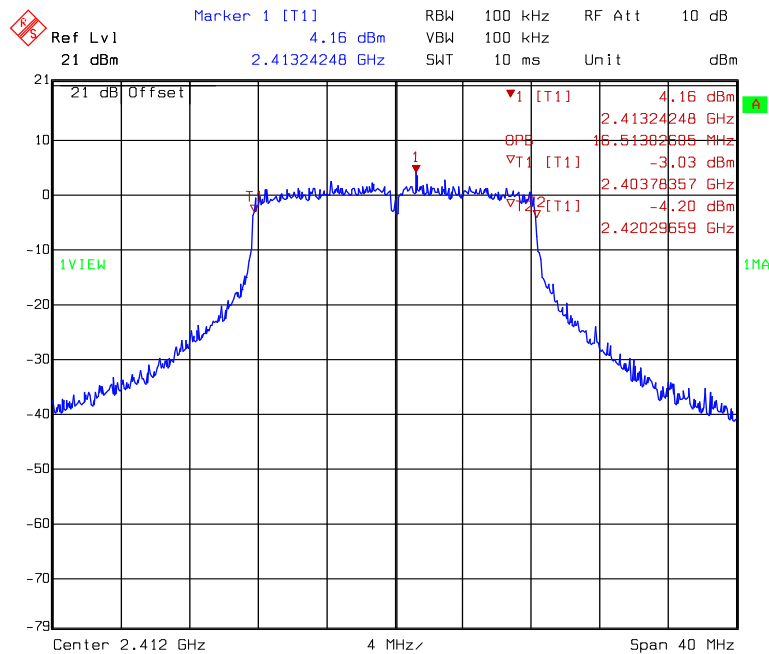

Title: Occupied Band-Width
 Comment A: CH 1 at 802.11g mode
 Date: 22.JAN.2009 12:11:21

99 % Occupied Bandwidth @ 802.11g mode channel 6

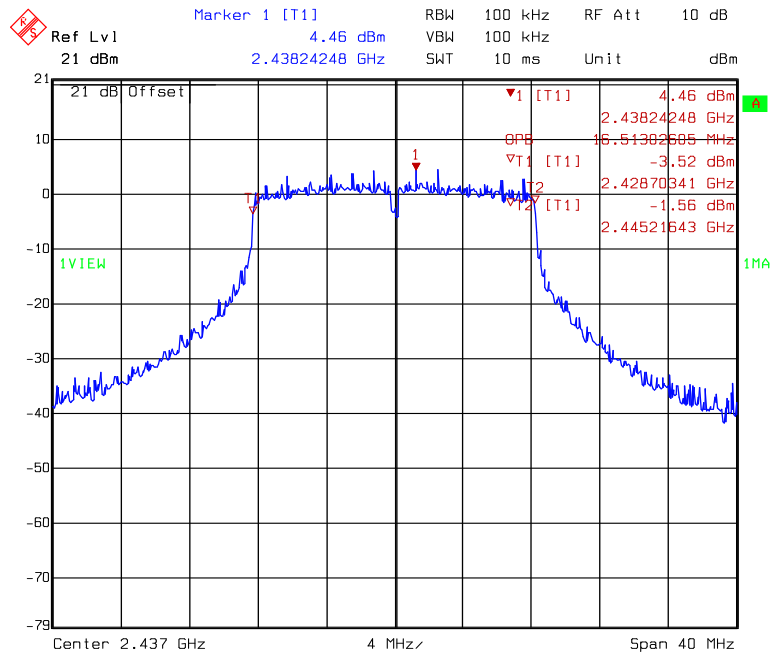

Title: Occupied Band-Width
Comment A: CH 6 at 802.11g mode
Date: 22.JAN.2009 12:14:05

99 % Occupied Bandwidth @ 802.11g mode channel 11

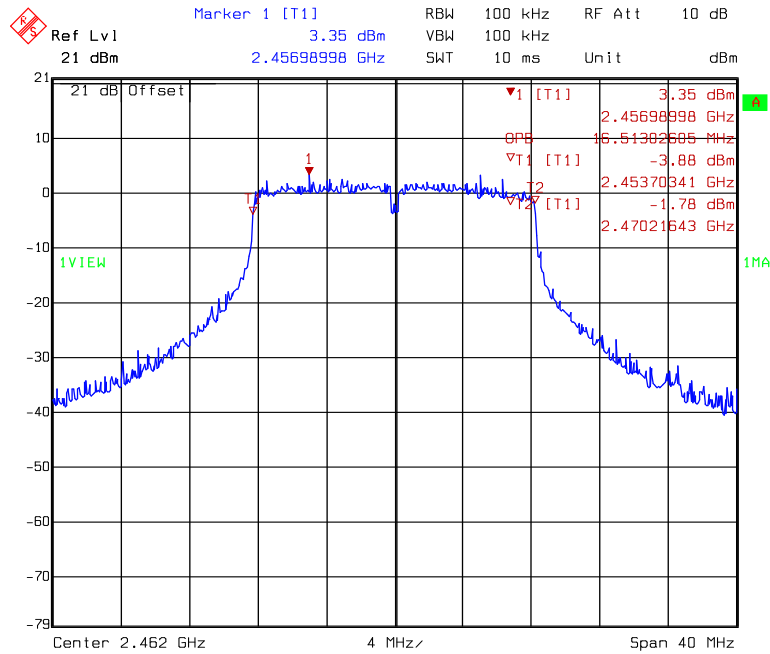

Title: Occupied Band-Width
Comment A: CH 11 at 802.11g mode
Date: 22.JAN.2009 12:19:41

99% Occupied Bandwidth @ 802.11n HT20 mode channel 1

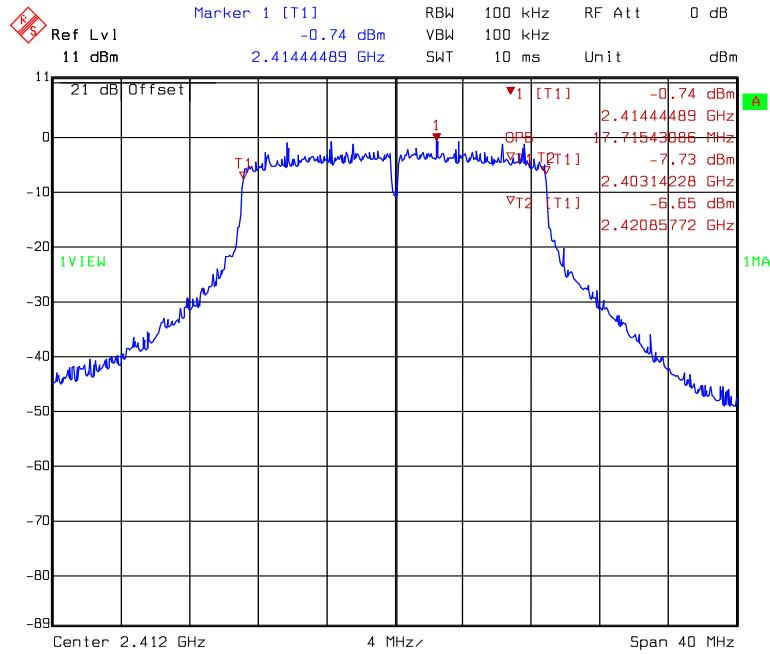

Title: Occupied Band-Width
 Comment A: CH 1 at 802.11n 20MHz mode
 Date: 22.JAN.2009 11:47:01

99% Occupied Bandwidth @ 802.11n HT20 mode channel 6

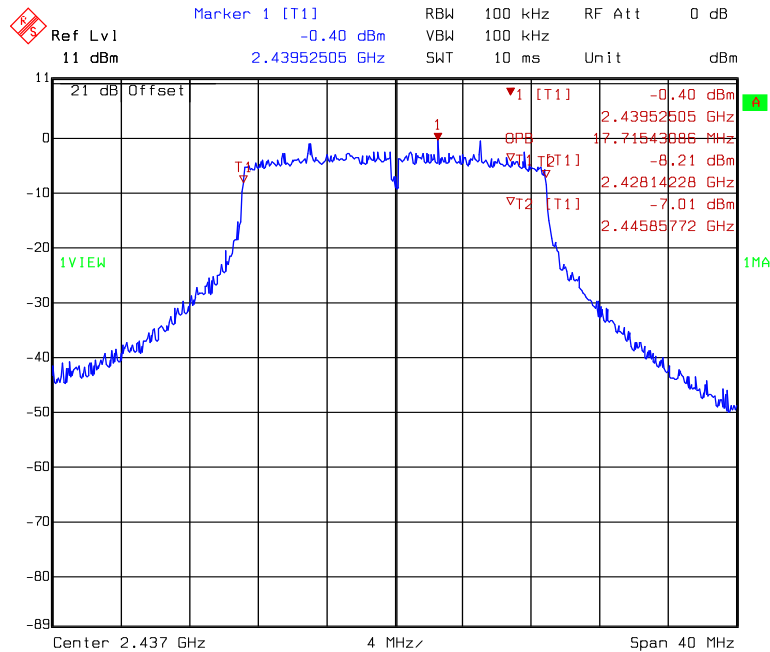

Title: Occupied Band-Width
 Comment A: CH 6 at 802.11n 20MHz mode
 Date: 22.JAN.2009 11:49:57

99% Occupied Bandwidth @ 802.11n HT20 mode channel 11

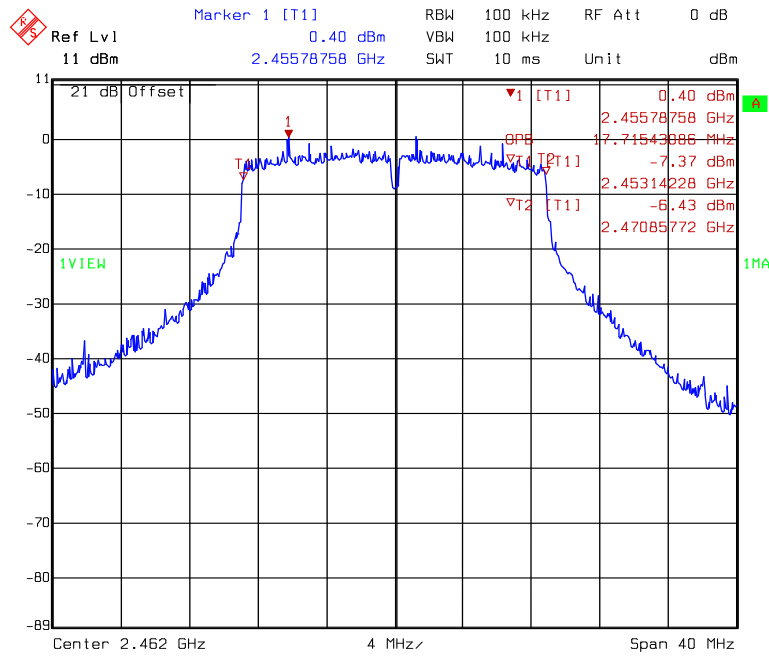

Title: Occupied Band-Width
Comment A: CH 11 at 802.11n 20MHz mode
Date: 22.JAN.2009 11:52:51

99% Occupied Bandwidth @ 802.11n HT40 mode channel 3

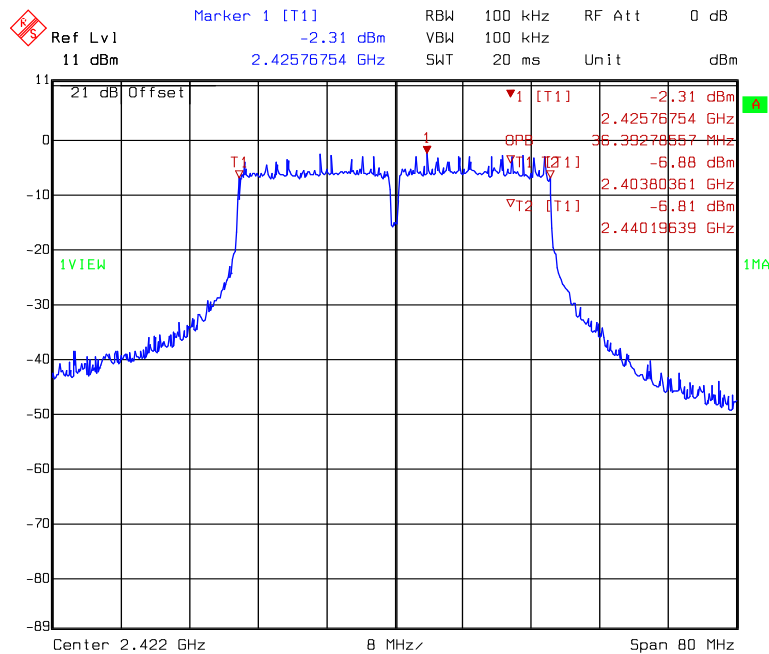

Title: Occupied Band-Width
Comment A: CH 3 at 802.11n 40MHz mode
Date: 22.JAN.2009 11:41:53

99% Occupied Bandwidth @ 802.11n HT40 mode channel 6

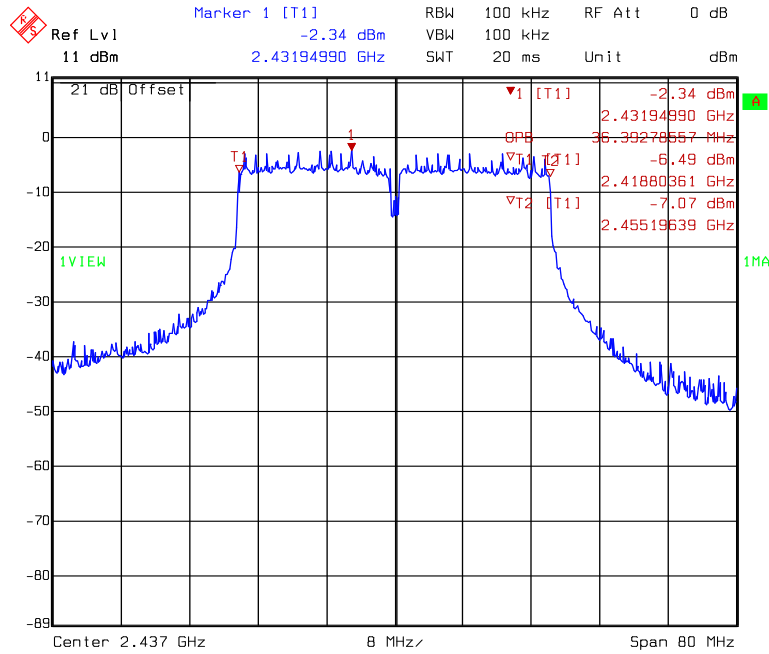

Title: Occupied Band-Width
Comment A: CH 6 at 802.11n 40MHz mode
Date: 22.JAN.2009 11:38:58

99% Occupied Bandwidth @ 802.11n HT40 mode channel 9

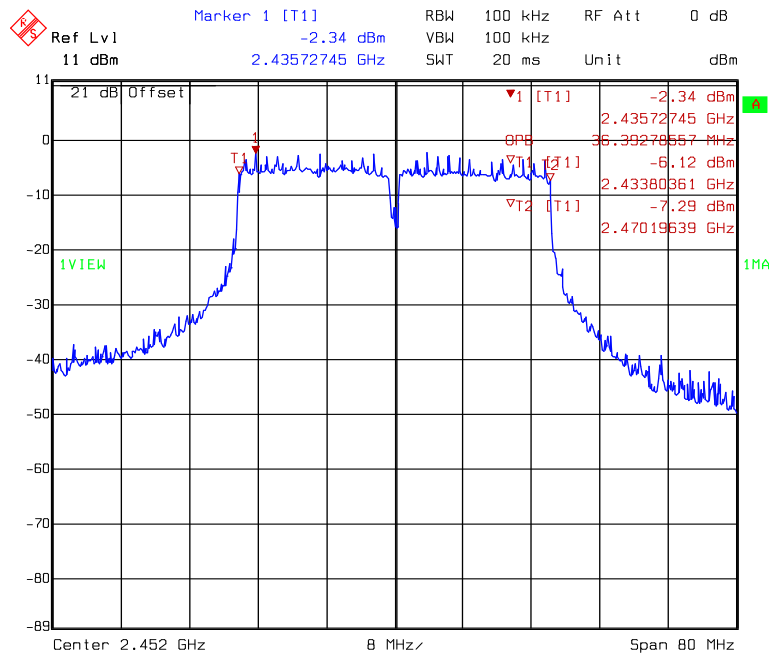

Title: Occupied Band-Width
Comment A: CH 9 at 802.11n 40MHz mode
Date: 22.JAN.2009 11:32:25

5. Maximum Output Power

Name of Test	Maximum output power
Base Standard	FCC 15.247(b)

Measurement Uncertainty: ±2dB (k=2)
Test Result: Complies
Measurement Data: See Table below

Method of Measurement:

Reference FCC document: KDB558074

The peak power at antenna terminals is measured using a Wideband Peak Power Meter which the video bandwidth can be up to 65MHz. Power output is measured with the maximum rated input level.

- Note: 1. The above equipments are within the valid calibration period.
 2. The test antennas (receiving antenna) are calibration per 3 years.
 3. The video bandwidth of the power meter and sensor can be up to 65 MHz

Test Diagram:

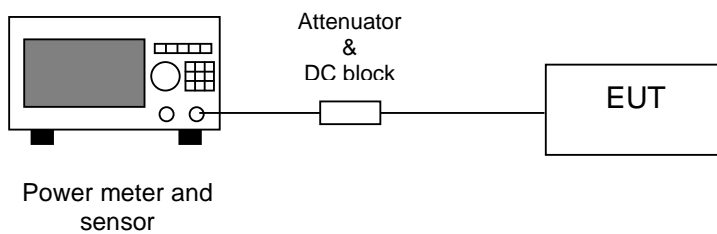

Note 1: The EUT was tested while in a continuous transmit mode and the worst case data rates are 1 Mbps for 802.11b, 6 Mbps for 802.11g, 6.5Mbps data rate for 802.11n HT20 and 13.5Mbps data rate for 802.11n HT40. The EUT was tuned to a low, middle and high channel.

Note 2: §15.247 (b) (4) Except as shown in paragraphs (b)(3) (i), (ii) and (iii) of this section, if transmitting antennas of directional gain greater than 6 dBi are used the peak output power from the intentional radiator shall be reduced below the stated values in paragraphs (b)(1) or (b)(2) of this section, as appropriate, by the amount in dB that the directional gain of the antenna exceeds 6 dBi.

Table 3. Maximum output power

Mode	Channel	Frequency (MHz)	C.L. (dB)	Reading (dBm)	Conducted Peak Output Power		Limit (W)
					(dBm)	(mW)	
802.11b	1	2412	2	16.27	18.27	67.14	1
	6	2437	2	16.50	18.50	70.79	1
	11	2462	2	16.69	18.69	73.96	1
802.11g	1	2412	2	22.03	24.03	252.93	1
	6	2437	2	22.01	24.01	251.77	1
	11	2462	2	21.76	23.76	237.68	1
802.11n HT20	1	2412	2	19.57	21.57	143.55	1
	6	2437	2	19.28	21.28	134.28	1
	11	2462	2	19.54	21.54	142.56	1
802.11n HT40	3	2422	2	20.75	22.75	188.36	1
	6	2437	2	20.62	22.62	182.81	1
	9	2452	2	21.35	23.35	216.27	1

6. Power Spectral Density

Name of Test	Power Spectral Density
Base Standard	FCC 15.247(e)

Test Result: Complies
Measurement Data: See Table & plots below

Method of Measurement:

Reference FCC document: KDB558074

A portion of the transmitted signal is coupled to a Spectrum Analyzer with a resolution bandwidth of at least 1 % of the bandwidth of the transmitted signal. The resolution bandwidth is chosen so as not to reduce the peak level of the measured waveform. The appropriate bandwidth mask is applied to the output waveform to verify compliance.

Test Diagram:

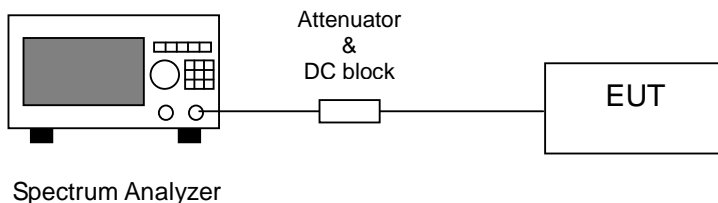

Note: The EUT was tested while in a continuous transmit mode and the worst case data rates are 1 Mbps for 802.11b, 6 Mbps for 802.11g, 6.5Mbps data rate for 802.11n HT20 and 13.5Mbps data rate for 802.11n HT40. The EUT was tuned to a low, middle and high channel.

Table 4. Power Spectral Density

Mode	Channel	Frequency (MHz)	Power spectrum density (dBm)	Limit (dBm)
802.11b	1	2412	-7.68	8
	6	2437	-6.58	8
	11	2462	-7.75	8
802.11g	1	2412	-8.67	8
	6	2437	-8.93	8
	11	2462	-8.28	8
802.11n HT20	1	2412	-13.03	8
	6	2437	-13.23	8
	11	2462	-14.37	8
802.11n HT40	3	2422	-15.73	8
	6	2437	-14.73	8
	9	2452	-15.74	8

Power Spectral Density @ 802.11b mode channel 1

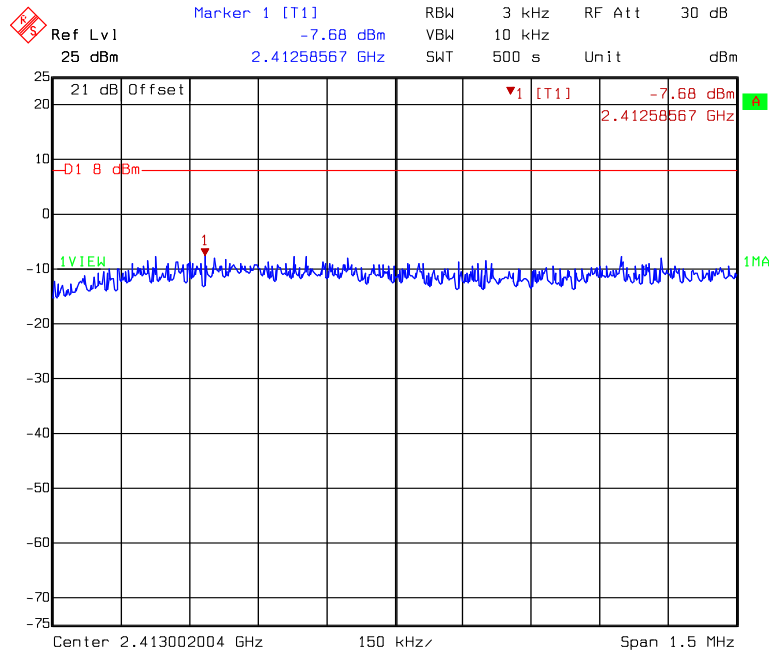

Title: Power density
 Comment A: CH 1 at 802.11b mode
 Date: 22.JAN.2009 11:59:14

Power Spectral Density @ 802.11b mode channel 6

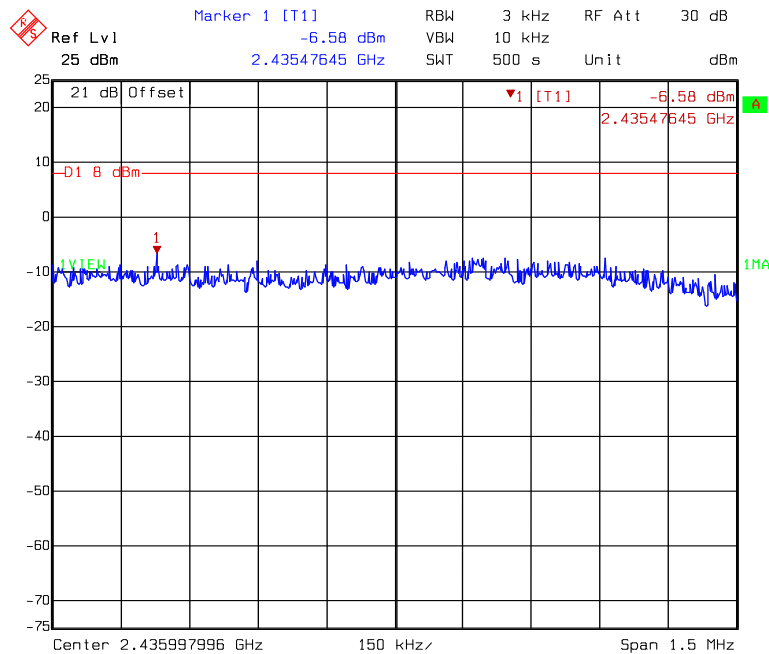

Title: Power density
 Comment A: CH 6 at 802.11b mode
 Date: 22.JAN.2009 12:02:36

Power Spectral Density @ 802.11b mode channel 11

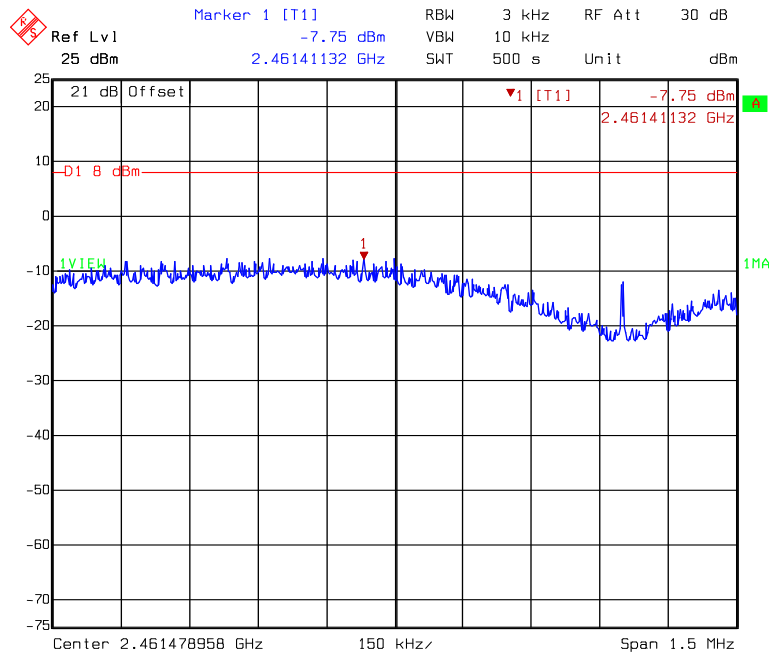

Title: Power density
 Comment A: CH 11 at 802.11b mode
 Date: 22.JAN.2009 12:06:10

Power Spectral Density @ 802.11g mode channel 1

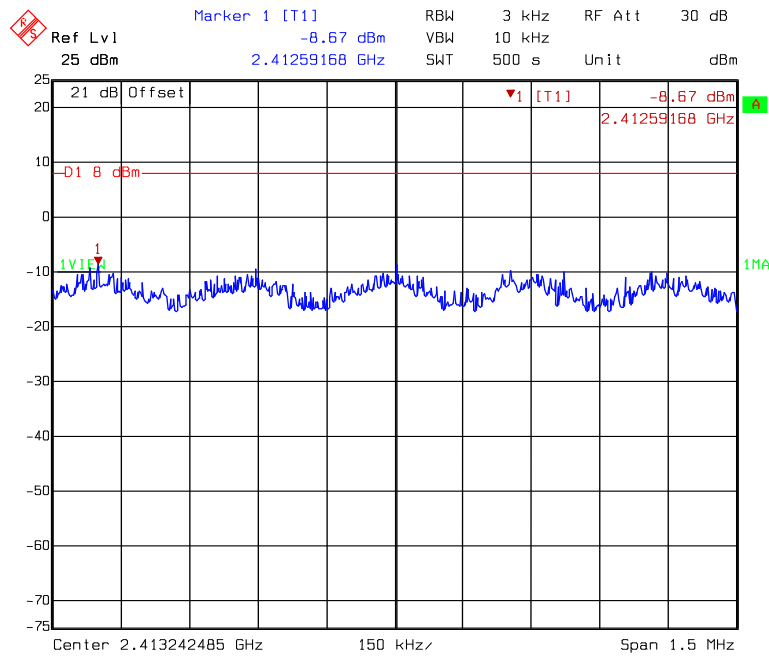

Title: Power density
 Comment A: CH 1 at 802.11g mode
 Date: 22.JAN.2009 12:09:47

Power Spectral Density @ 802.11g mode channel 6

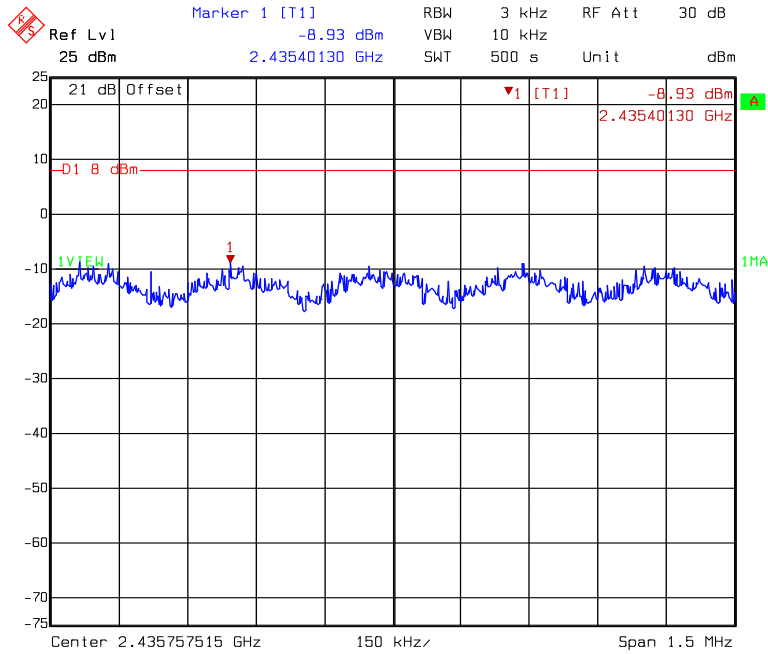

Title: Power density
 Comment A: CH 6 at 802.11g mode
 Date: 22.JAN.2009 12:12:32

Power Spectral Density @ 802.11g mode channel 11

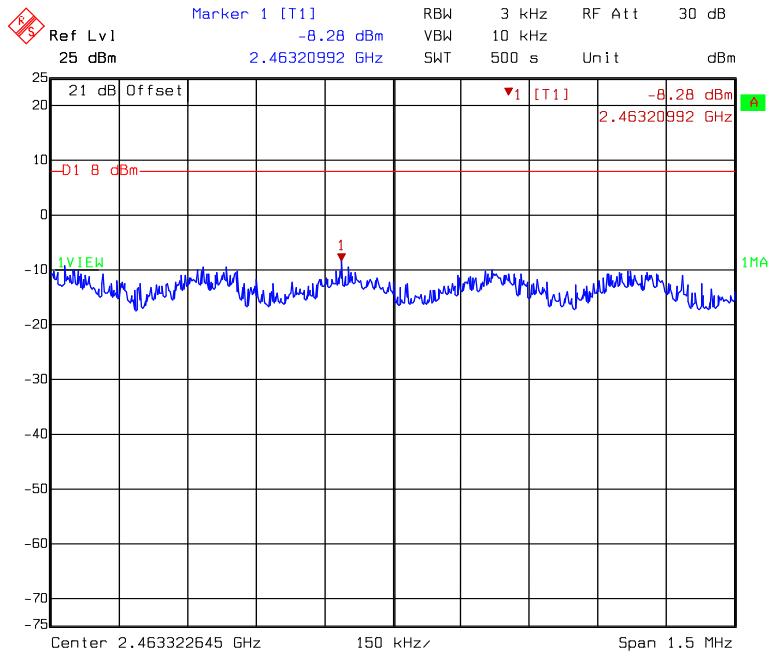

Title: Power density
 Comment A: CH 11 at 802.11g mode
 Date: 22.JAN.2009 12:18:07

Power Spectral Density @ 802.11n HT20 mode channel 1

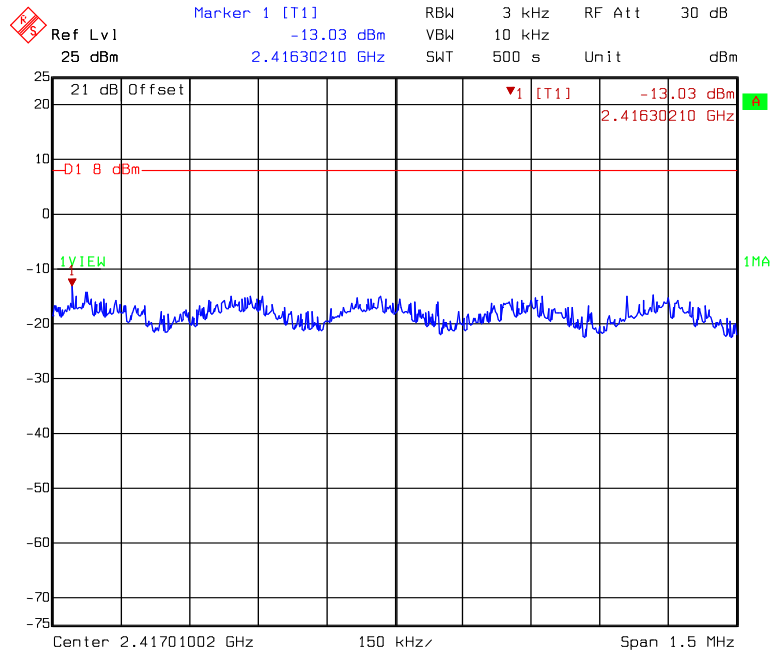

Title: Power density
 Comment A: CH 1 at 802.11n 20MHz mode
 Date: 22.JAN.2009 11:45:32

Power Spectral Density @ 802.11n HT20 mode channel 6

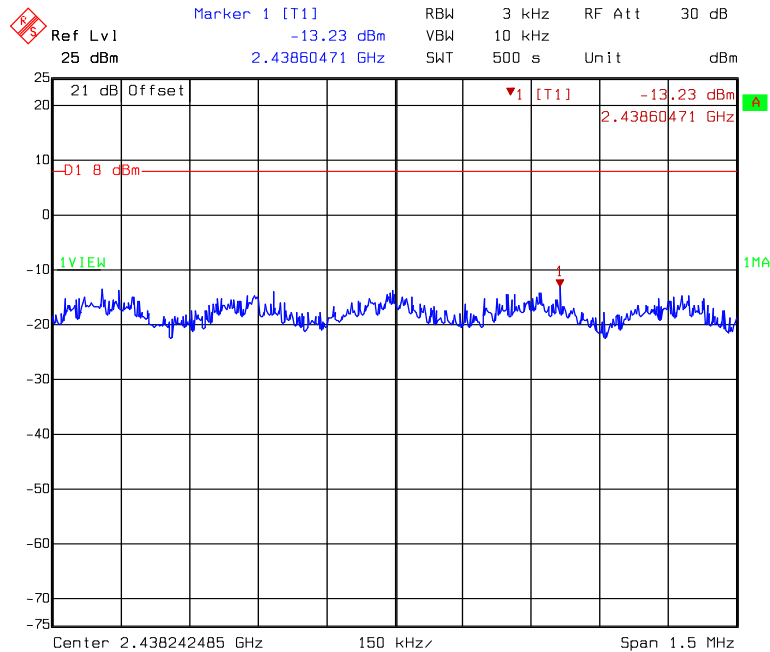

Title: Power density
 Comment A: CH 6 at 802.11n 20MHz mode
 Date: 22.JAN.2009 11:48:29

Power Spectral Density @ 802.11n HT20 mode channel 11

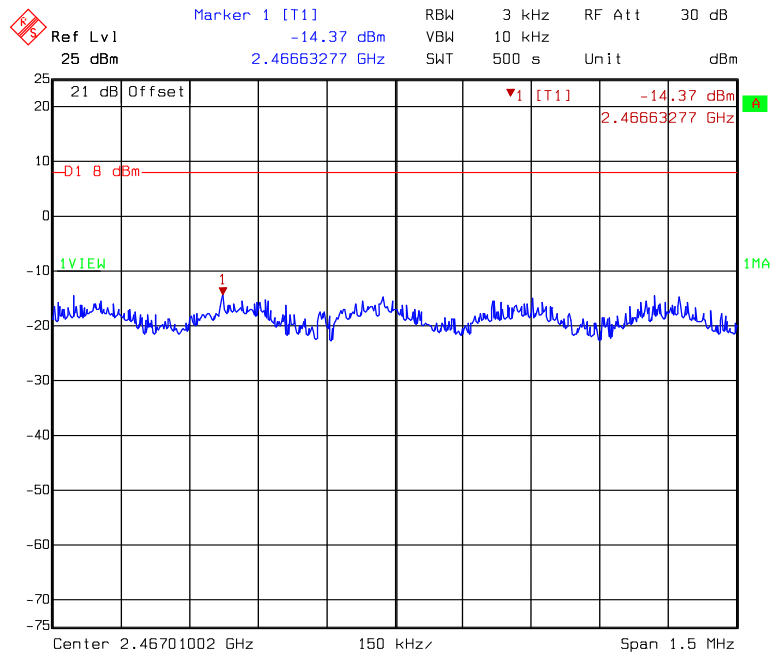

Title: Power density
 Comment A: CH 11 at 802.11n 20MHz mode
 Date: 22.JAN.2009 11:51:23

Power Spectral Density @ 802.11n HT40 mode channel 3

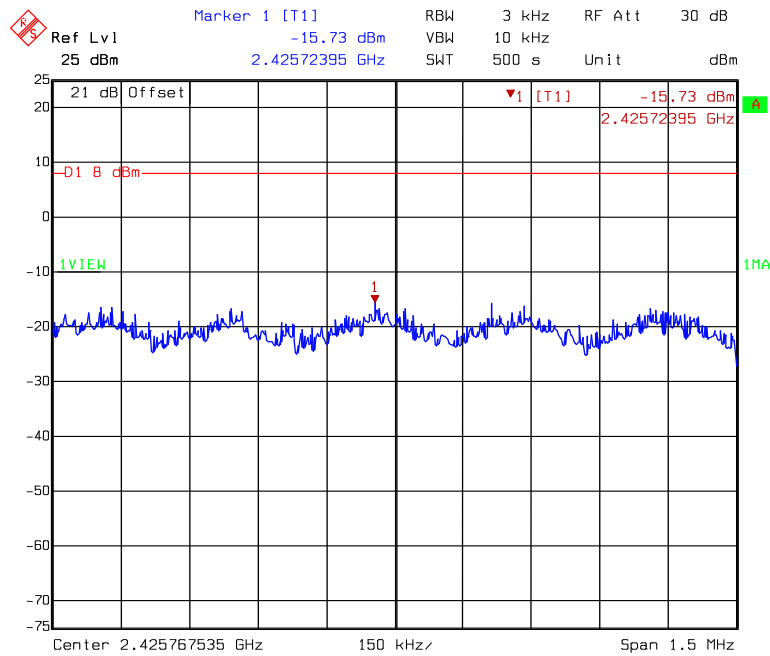

Title: Power density
 Comment A: CH 3 at 802.11n 40MHz mode
 Date: 22.JAN.2009 11:40:23

Power Spectral Density @ 802.11n HT40 mode channel 6

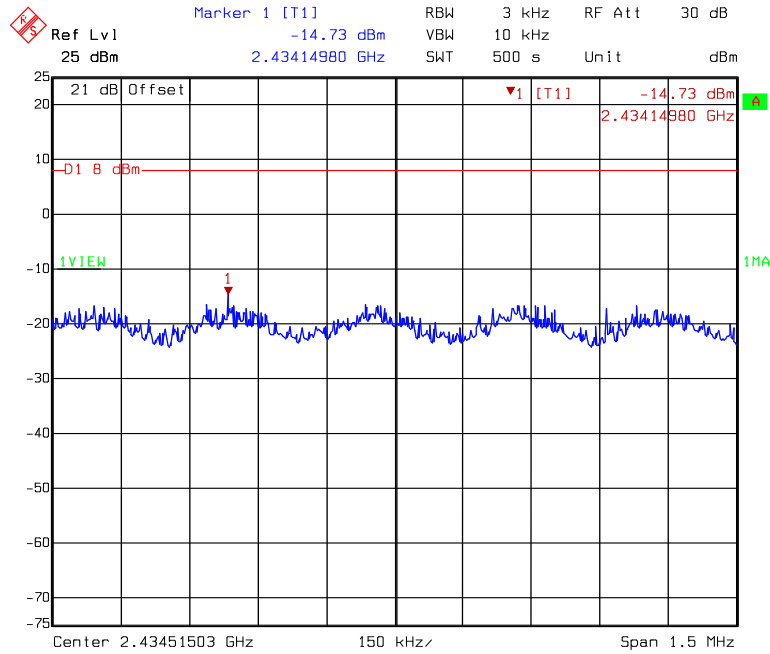

Title: Power density
 Comment A: CH 6 at 802.11n 40MHz mode
 Date: 22.JAN.2009 11:37:28

Power Spectral Density @ 802.11n HT40 mode channel 9

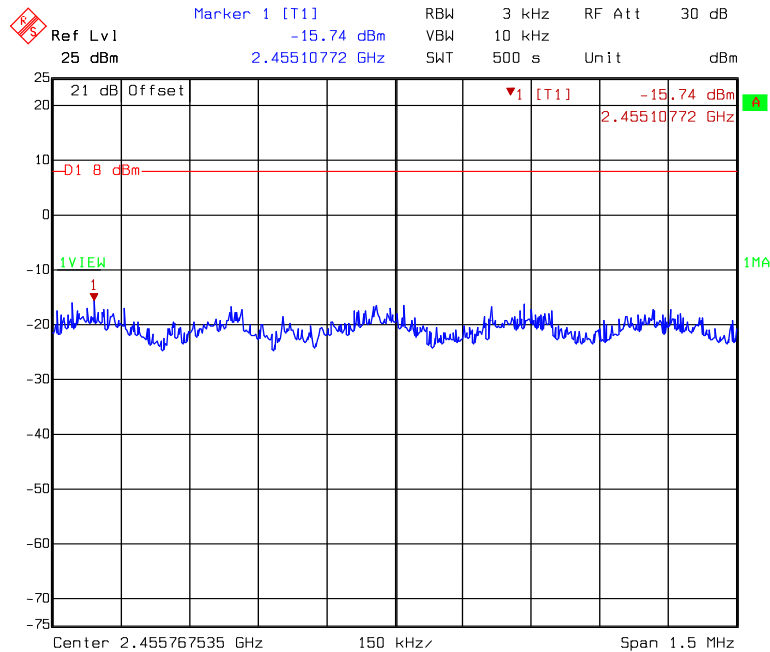

Title: Power density
 Comment A: CH 9 at 802.11n 40MHz mode
 Date: 22.JAN.2009 11:34:13

7. RF Antenna conducted Spurious

Name of Test	RF Antenna Conducted Spurious
Base Standard	FCC 15.247(d)

Test Result: Complies
Measurement Data: See plots below

Method of Measurement:

Reference FCC document: KDB558074

The measurements were performed from 30 MHz to 25 GHz RF antenna conducted per FCC 15.247 (d) was measured from the EUT antenna port using a 50 ohm spectrum analyzer with the resolution bandwidth set at 100 kHz, and the video bandwidth set at 100 kHz. Harmonics and spurious noise must be at least 20 dB down from the highest emission level within the authorized band as measured with a 100 kHz RBW. The table below is the results from the highest emission for each channel within the authorized band. This table was used to determine the spurious limits for each channel.

Test Diagram:

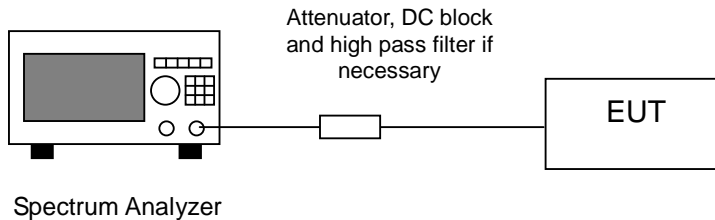

- Note:**
- (1) The EUT was tested while in a continuous transmit mode and the worst case data rates are 1Mbps for 802.11b, 6Mbps for 802.11g, 6.5 Mbps for 802.11n HT20 and 13.5 Mbps for 802.11n HT40 . The EUT was tuned to a low, middle and high channel.
 - (2) The EUT operating at 2.4 GHz ISM band. Frequency Range scanned from 30 MHz to 25 GHz.

conducted spurious @ 802.11b mode channel 1 (1 of 3)

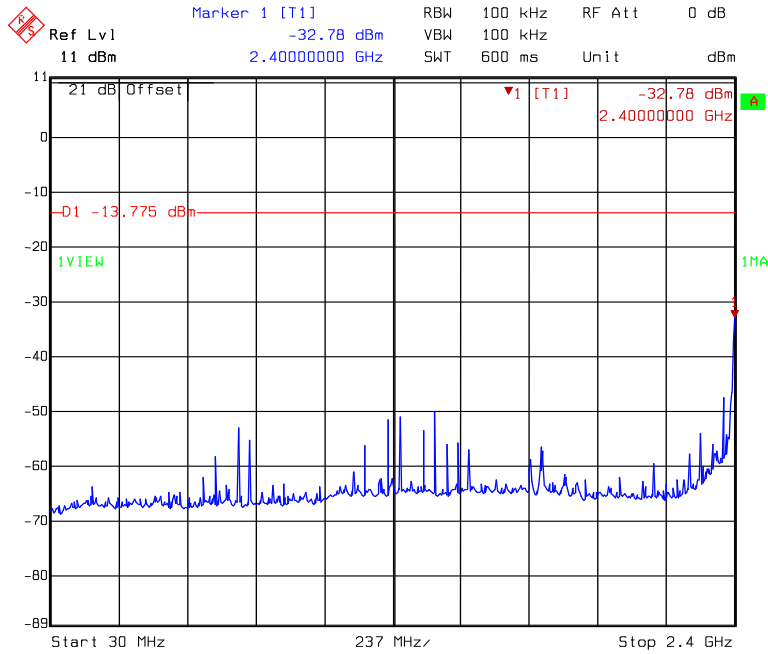

Title: Conductive-Spurious
Comment A: CH 1 at 802.11b mode 30MHz~2400MHz
Date: 22.JAN.2009 11:59:59

conducted spurious @ 802.11b mode channel 1 (2 of 3)

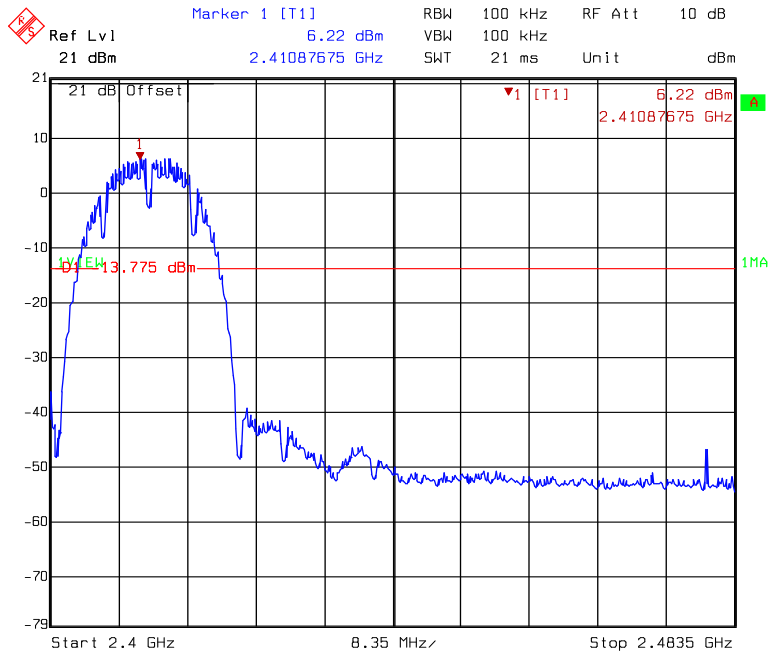

Title: Conductive-Spurious
Comment A: CH 1 at 802.11b mode 2400MHz~2483.5MHz
Date: 22.JAN.2009 11:59:37

conducted spurious @ 802.11b mode channel 1 (3 of 3)

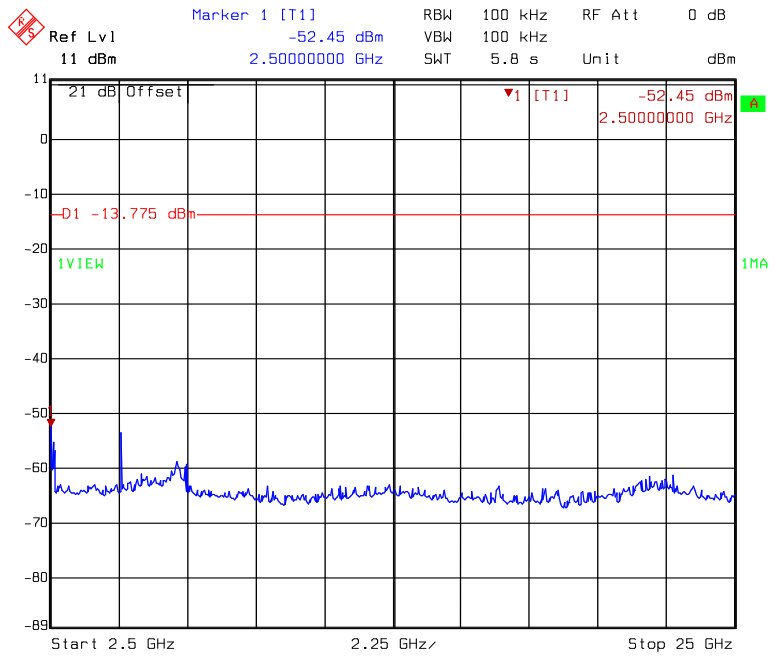

Title: Conductive-Spurious
 Comment A: CH 1 at 802.11b mode 2483.5MHz~25GHz
 Date: 22.JAN.2009 12:00:26

conducted spurious @ 802.11b mode channel 6 (1 of 3)

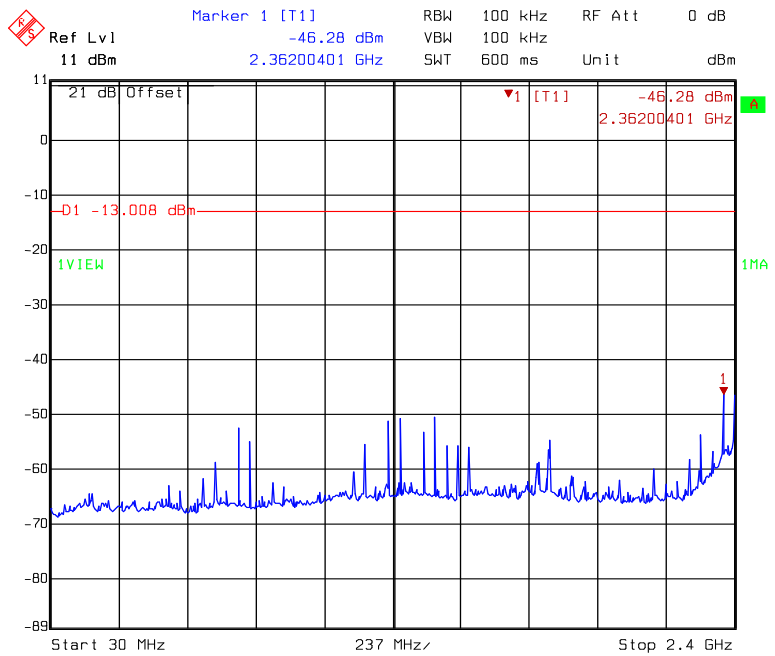

Title: Conductive-Spurious
 Comment A: CH 6 at 802.11b mode 30MHz~2400MHz
 Date: 22.JAN.2009 12:03:21

conducted spurious @ 802.11b mode channel 6 (2 of 3)

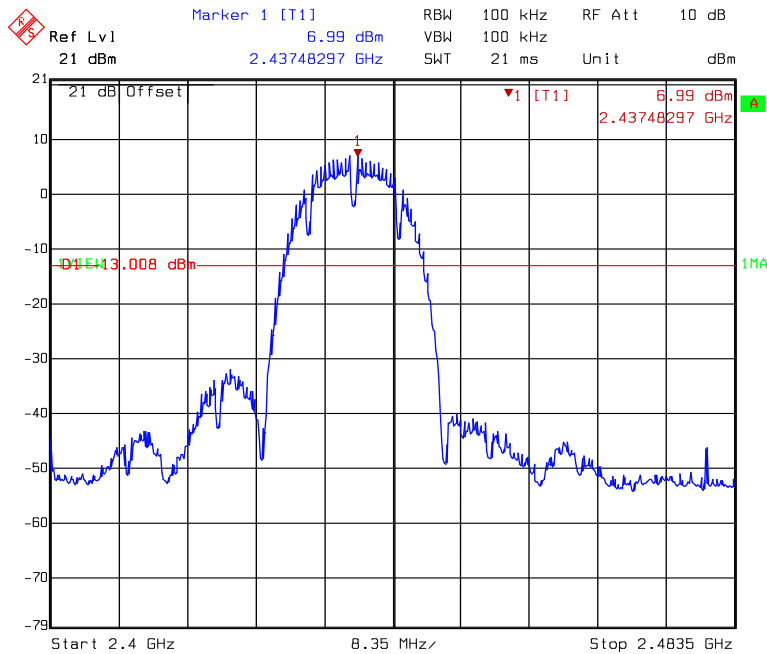

conducted spurious @ 802.11b mode channel 6 (3 of 3)

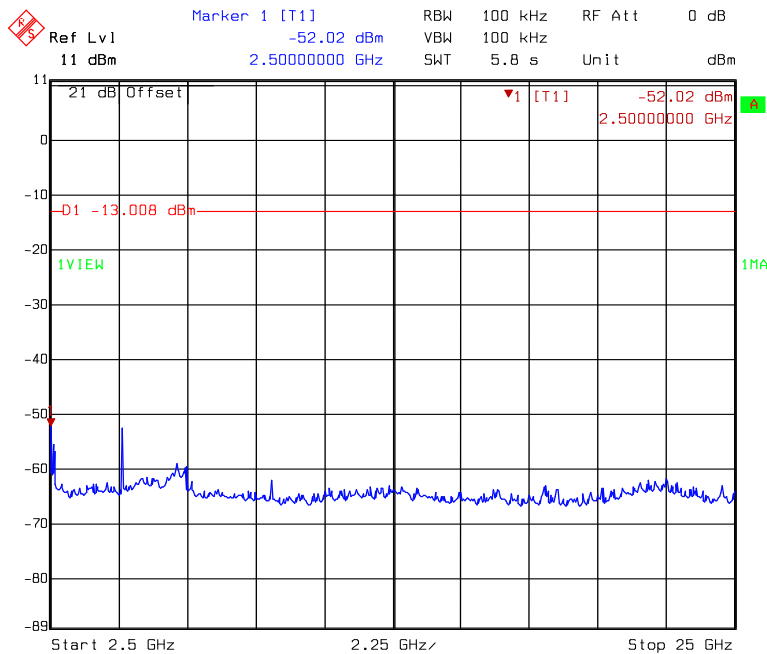

conducted spurious @ 802.11b mode channel 11 (1 of 3)

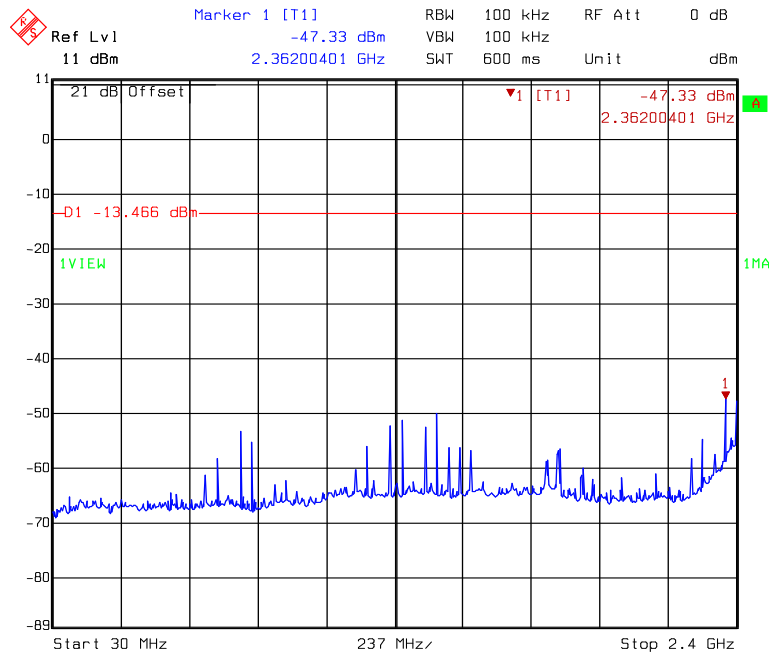

conducted spurious @ 802.11b mode channel 11 (2 of 3)

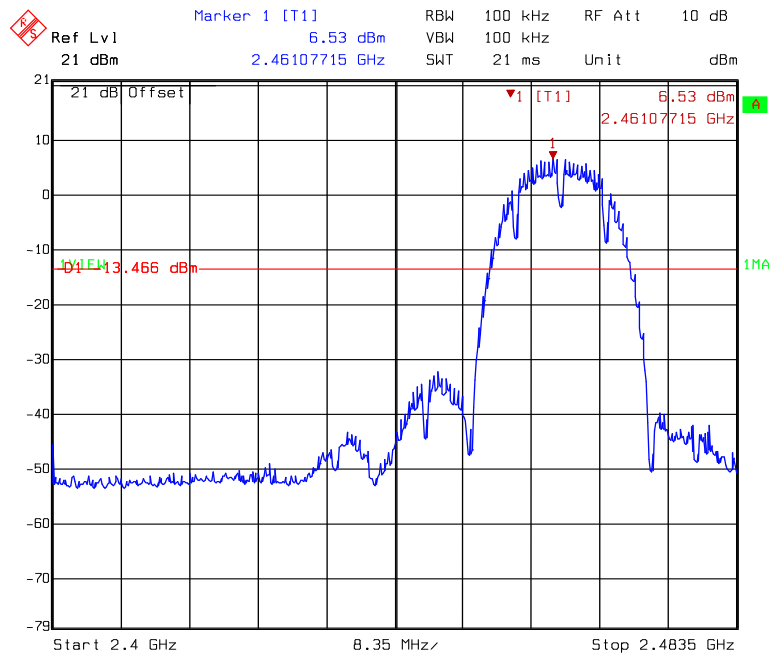

conducted spurious @ 802.11b mode channel 11 (3 of 3)

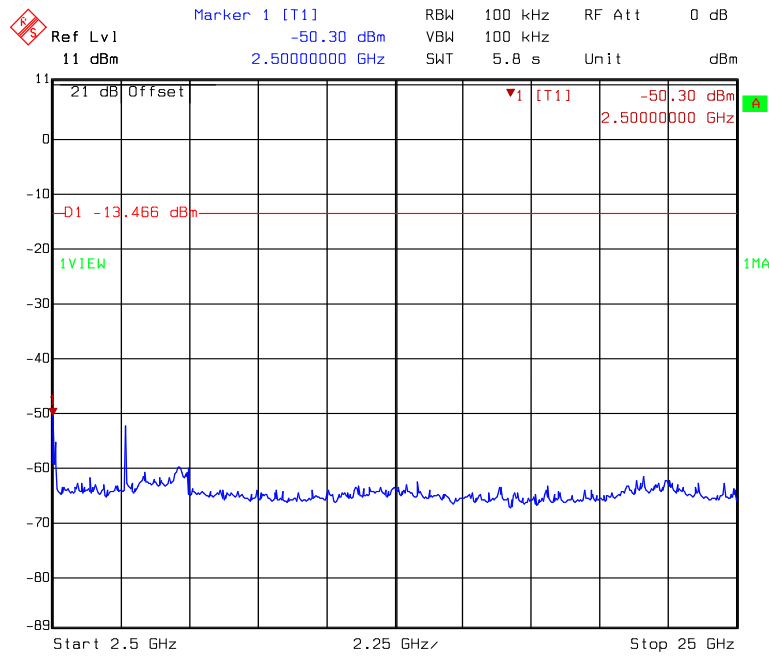

Title: Conductive-Spurious
Comment A: CH 11 at 802.11b mode 2483.5MHz~25GHz
Date: 22.JAN.2009 12:07:22

conducted spurious @ 802.11g mode channel 1 (1 of 3)

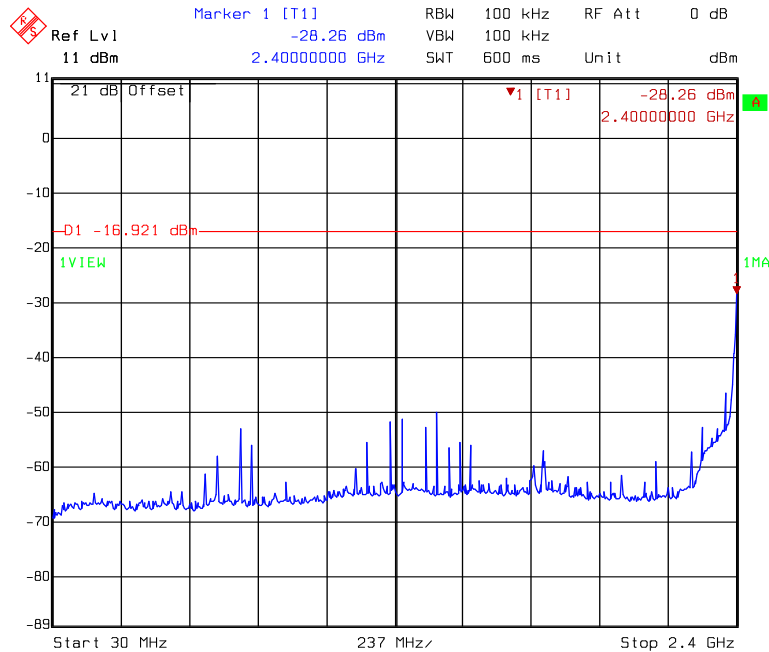

Title: Conductive-Spurious
Comment A: CH 1 at 802.11g mode 30MHz~2400MHz
Date: 22.JAN.2009 12:10:29

conducted spurious @ 802.11g mode channel 1 (2 of 3)

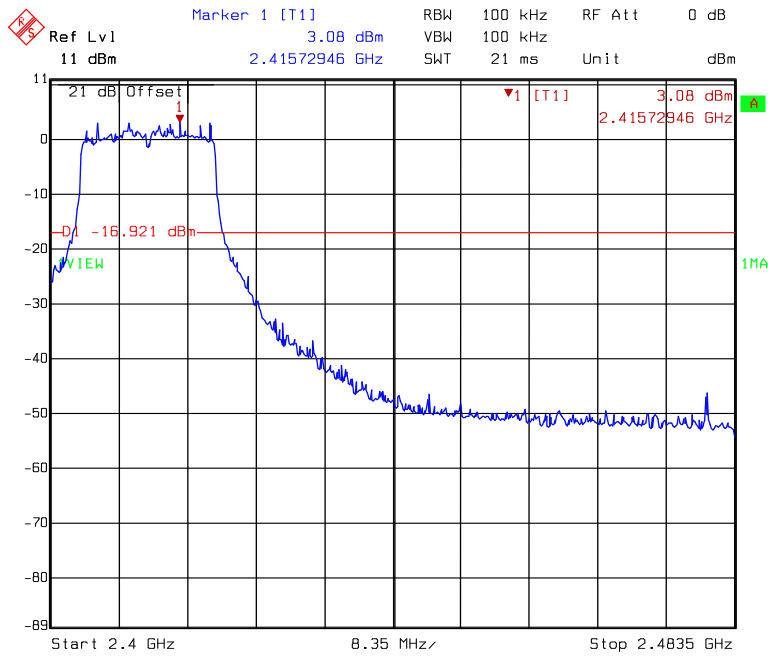

Title: Conductive-Spurious
 Comment A: CH 1 at 802.11g mode 2400MHz~2483.5MHz
 Date: 22.JAN.2009 12:10:07

conducted spurious @ 802.11g mode channel 1 (3 of 3)

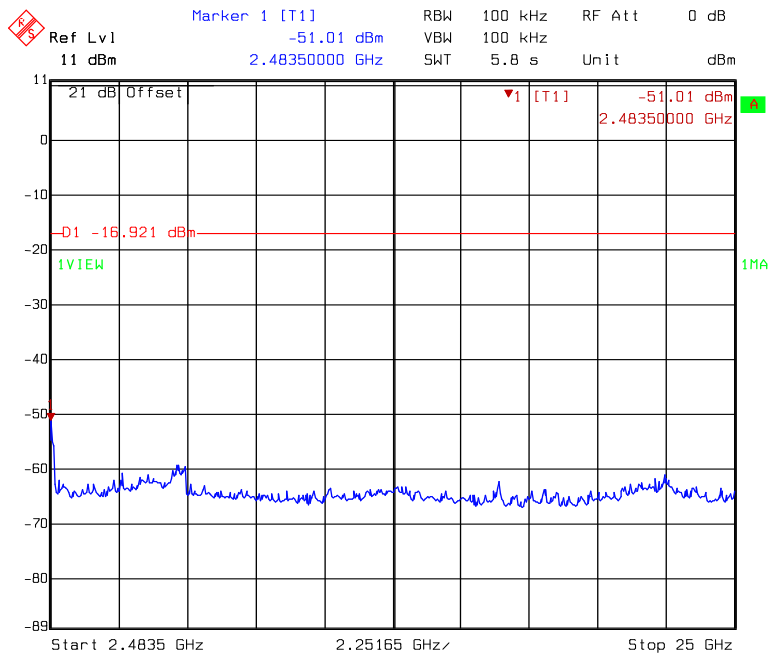

Title: Conductive-Spurious
 Comment A: CH 1 at 802.11g mode 2483.5MHz~25000MHz
 Date: 22.JAN.2009 12:10:56

conducted spurious @ 802.11g mode channel 6 (1 of 3)

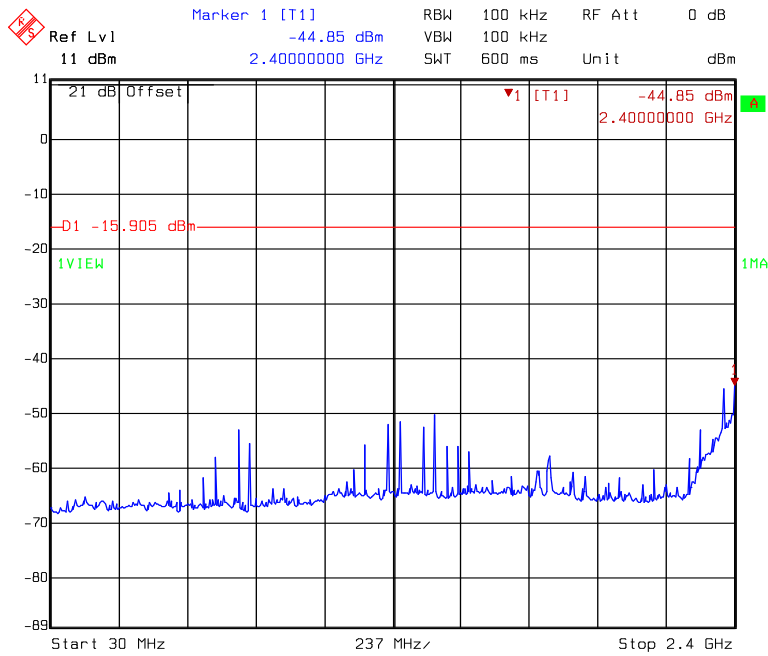

Title: Conductive-Spurious
 Comment A: CH 6 at 802.11g mode 30MHz~2400MHz
 Date: 22.JAN.2009 12:13:13

conducted spurious @ 802.11g mode channel 6 (2 of 3)

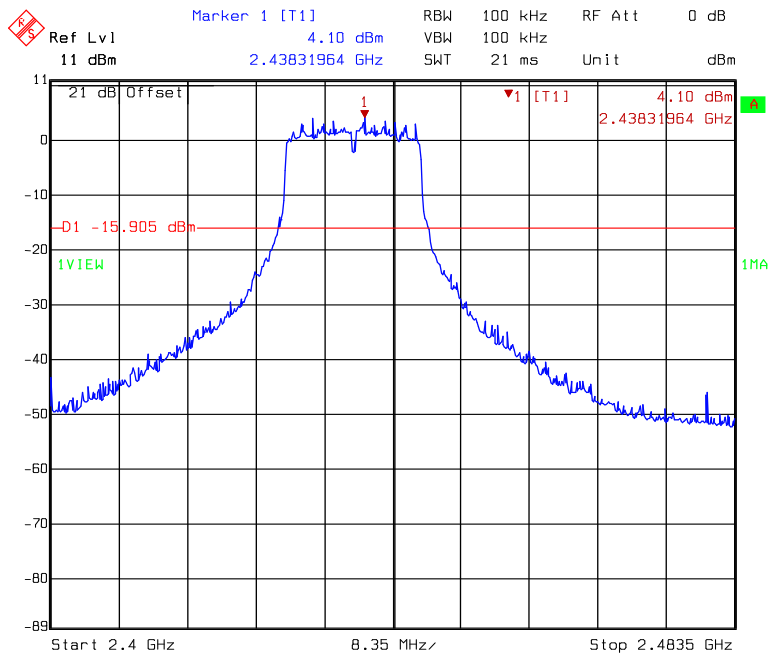

Title: Conductive-Spurious
 Comment A: CH 6 at 802.11g mode 2400MHz~2483.5MHz
 Date: 22.JAN.2009 12:12:52

conducted spurious @ 802.11g mode channel 6 (3 of 3)

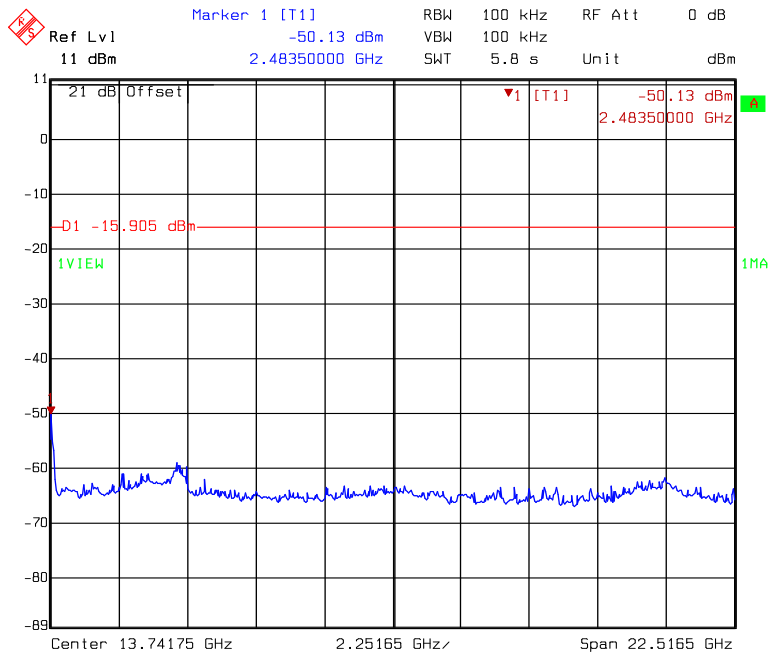

Title: Conductive-Spurious
 Comment A: CH 6 at 802.11g mode 2483.5MHz~25000MHz
 Date: 22.JAN.2009 12:13:40

conducted spurious @ 802.11g mode channel 11 (1 of 3)

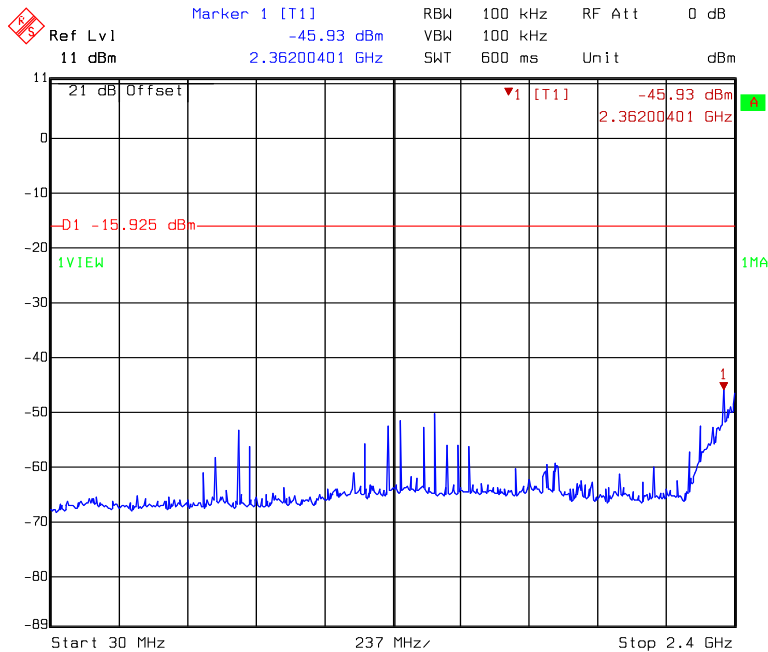

Title: Conductive-Spurious
 Comment A: CH 11 at 802.11g mode 30MHz~2400MHz
 Date: 22.JAN.2009 12:18:49

conducted spurious @ 802.11g mode channel 11 (2 of 3)

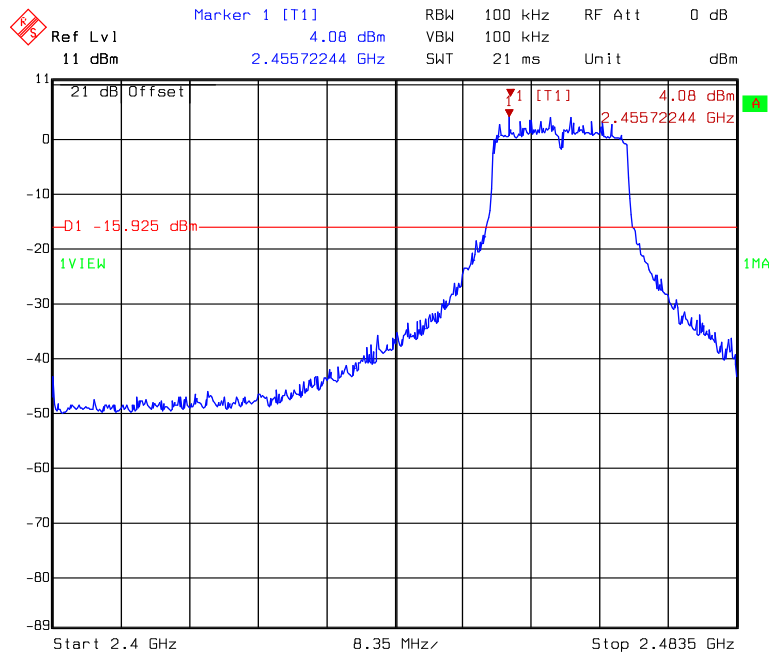

Title: Conductive-Spurious
 Comment A: CH 11 at 802.11g mode 2400MHz~2483.5MHz
 Date: 22.JAN.2009 12:18:28

conducted spurious @ 802.11g mode channel 11 (3 of 3)

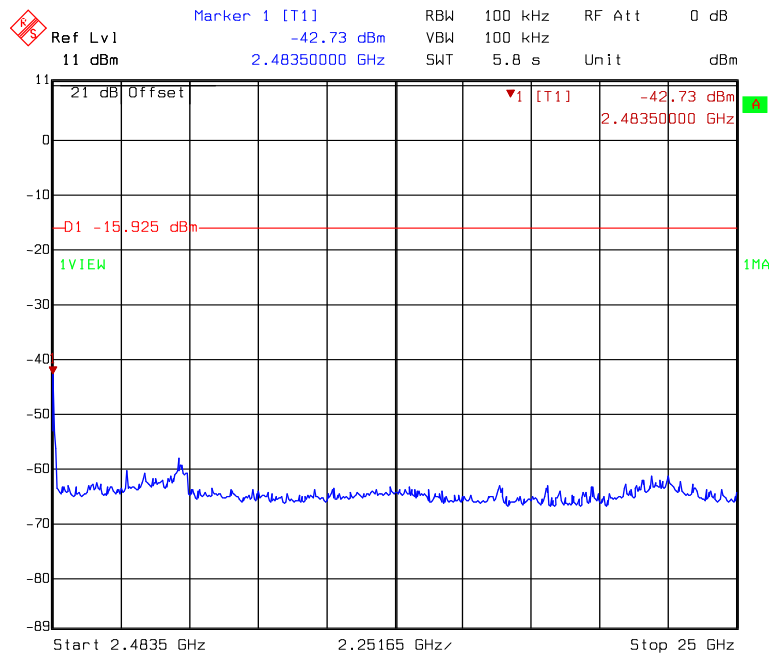

Title: Conductive-Spurious
 Comment A: CH 11 at 802.11g mode 2483.5MHz~2500MHz
 Date: 22.JAN.2009 12:19:16

conducted spurious @ 802.11n HT20 mode channel 1 (1of 3)

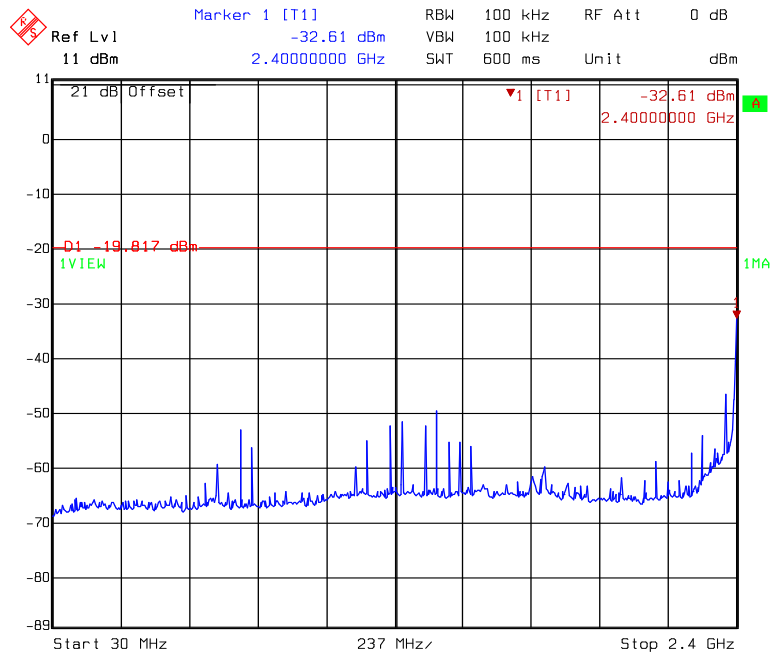

Title: Conductive-Spurious
 Comment A: CH 1 at 802.11n 20MHz mode
 Date: 22.JAN.2009 11:46:14

conducted spurious @ 802.11n HT20 mode channel 1 (2of 3)

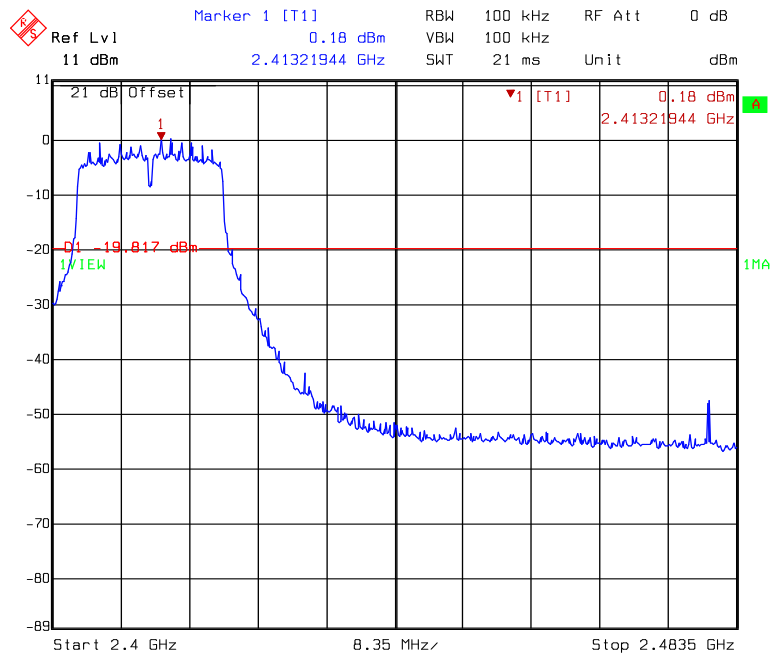

Title: Conductive-Spurious
 Comment A: CH 1 at 802.11n 20MHz mode
 Date: 22.JAN.2009 11:45:53

conducted spurious @ 802.11n HT20 mode channel 1 (3of 3)

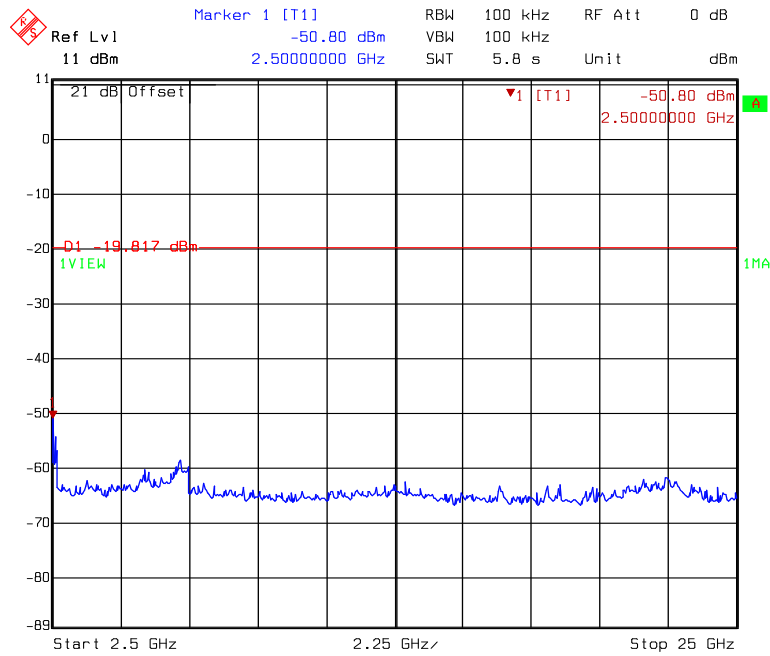

Title: Conductive-Spurious
 Comment A: CH 1 at 802.11n 20MHz mode
 Date: 22.JAN.2009 11:46:41

conducted spurious @ 802.11n HT20 mode channel 6 (1of 3)

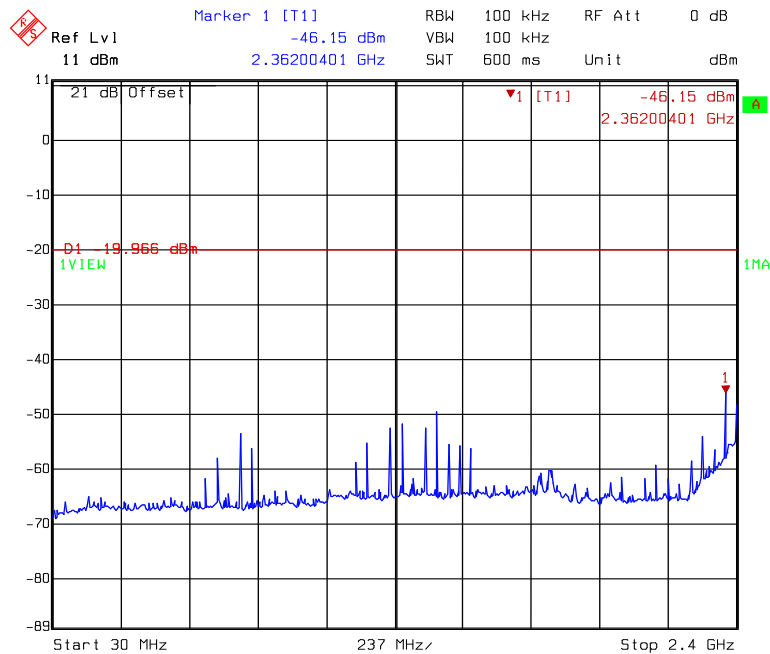

Title: Conductive-Spurious
 Comment A: CH 6 at 802.11n 20MHz mode
 Date: 22.JAN.2009 11:49:11

conducted spurious @ 802.11n HT20 mode channel 6 (2of 3)

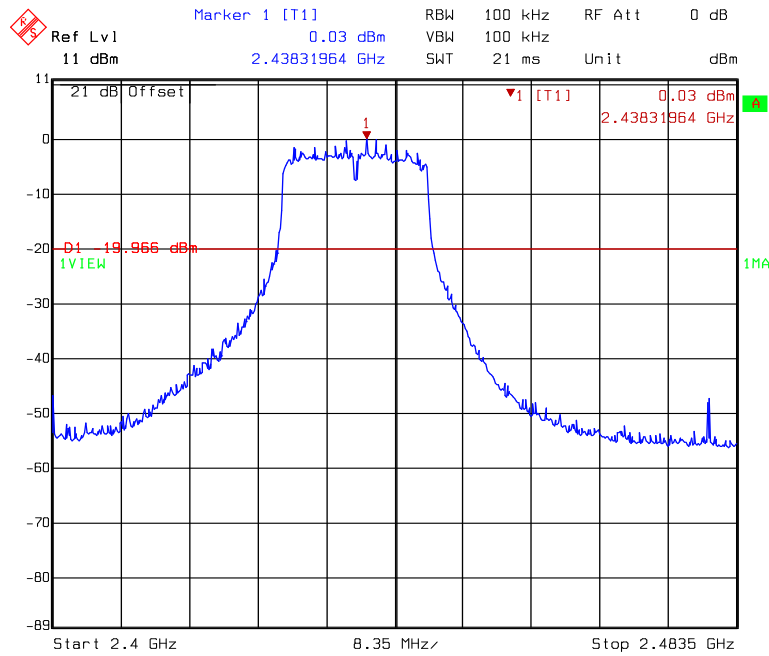

Title: Conductive-Spurious
 Comment A: CH 6 at 802.11n 20MHz mode
 Date: 22.JAN.2009 11:48:49

conducted spurious @ 802.11n HT20 mode channel 6 (3of 3)

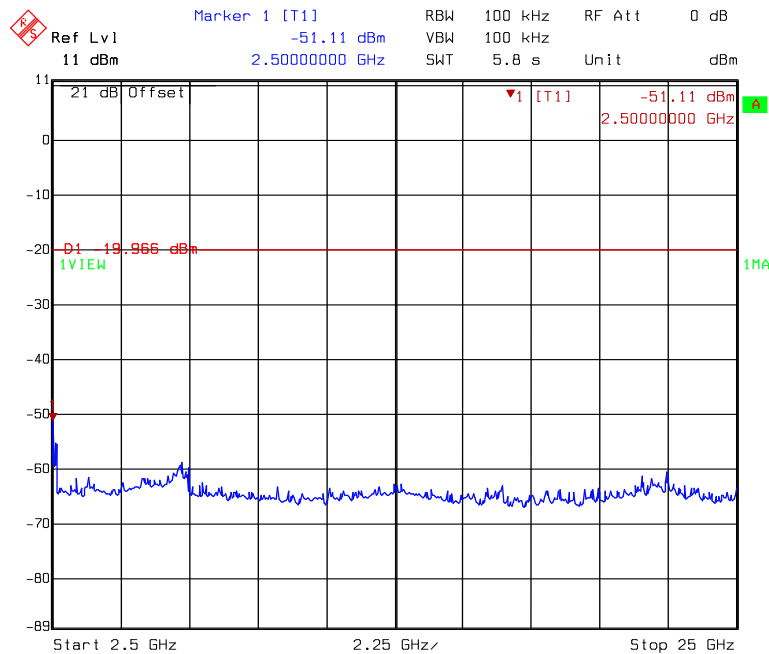

Title: Conductive-Spurious
 Comment A: CH 6 at 802.11n 20MHz mode
 Date: 22.JAN.2009 11:49:38

conducted spurious @ 802.11n HT20 mode channel 11 (1of 3)

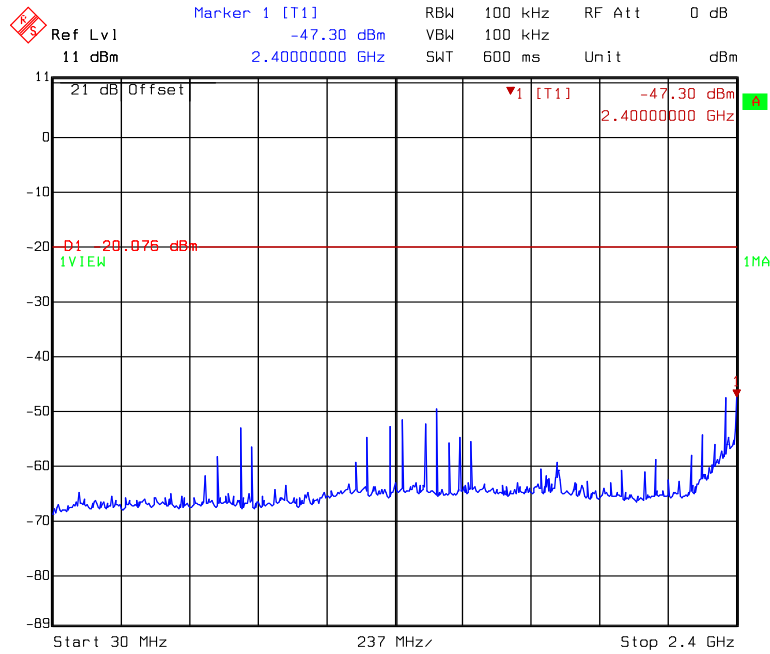

Title: Conductive-Spurious
 Comment A: CH 11 at 802.11n 20MHz mode
 Date: 22.JAN.2009 11:52:04

conducted spurious @ 802.11n HT20 mode channel 11 (2of 3)

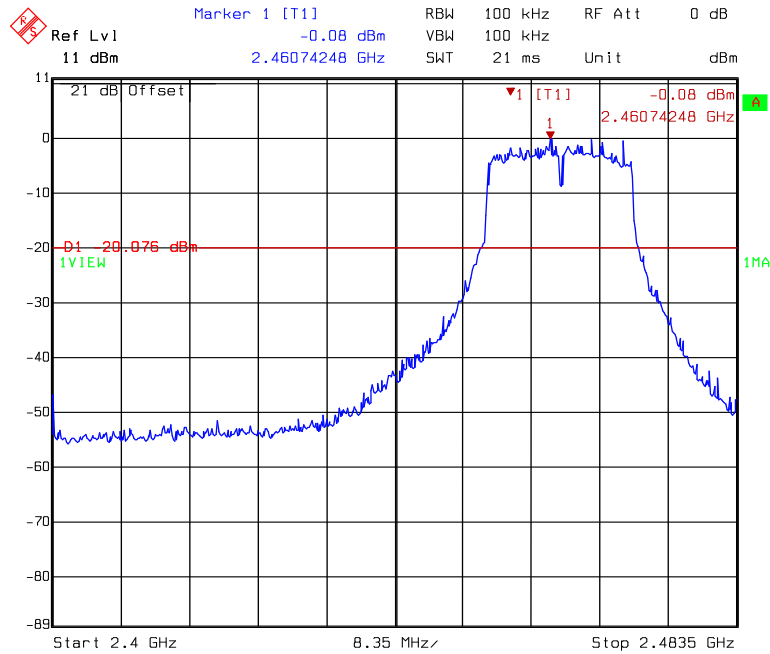

Title: Conductive-Spurious
 Comment A: CH 11 at 802.11n 20MHz mode
 Date: 22.JAN.2009 11:51:43

conducted spurious @ 802.11n HT20 mode channel 11 (3of 3)

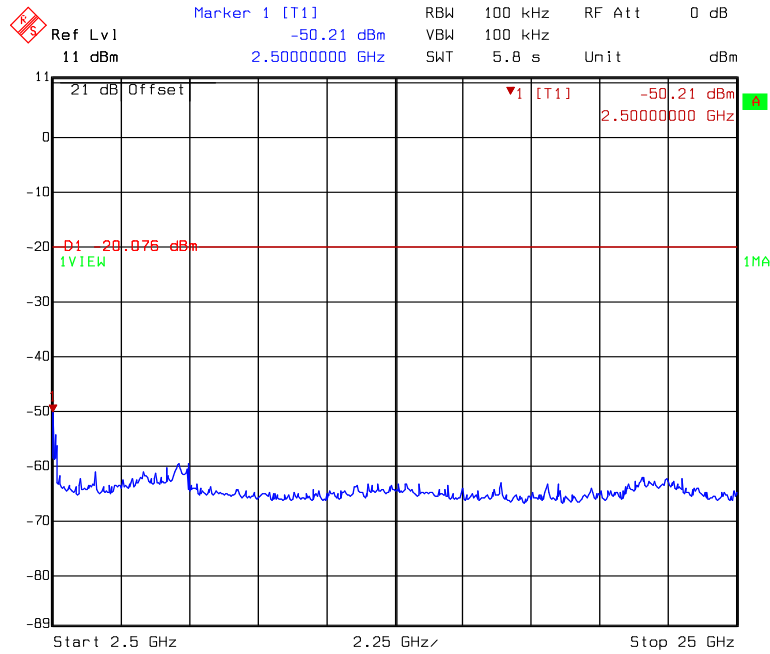

Title: Conductive-Spurious
 Comment A: CH 11 at 802.11n 20MHz mode
 Date: 22.JAN.2009 11:52:31

conducted spurious @ 802.11n HT40 mode channel 3 (1of 3)

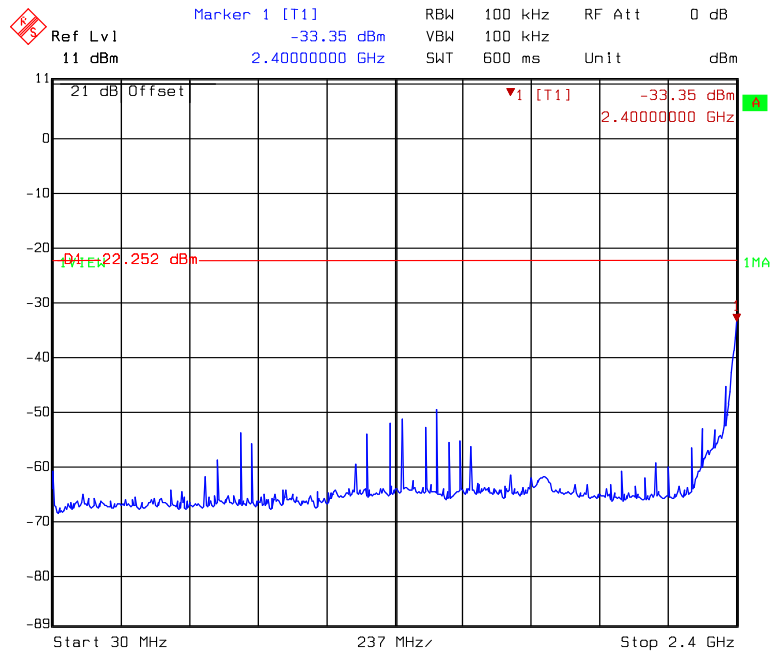

Title: Conductive-Spurious
 Comment A: CH 3 at 802.11n 40MHz mode
 Date: 22.JAN.2009 11:41:06

conducted spurious @ 802.11n HT40 mode channel 3 (2of 3)

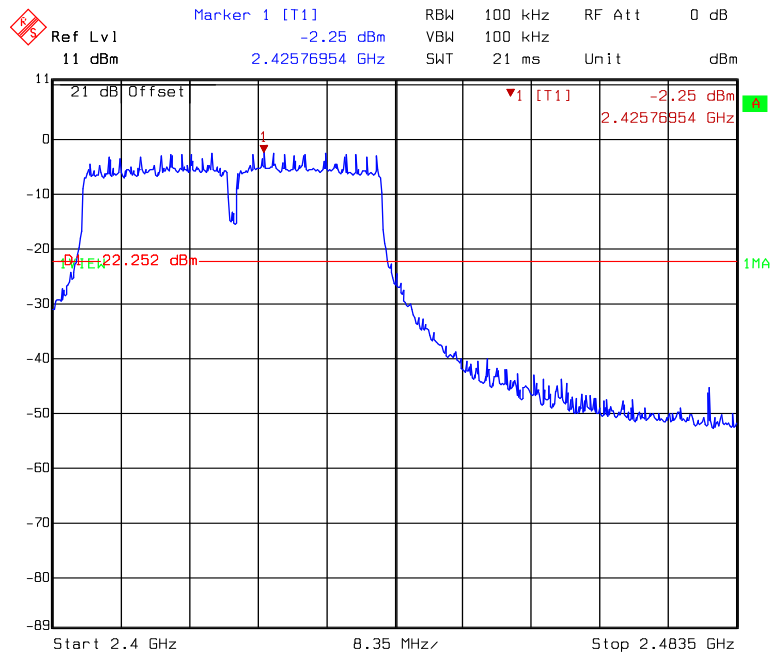

Title: Conductive-Spurious
 Comment A: CH 3 at 802.11n 40MHz mode
 Date: 22.JAN.2009 11:40:44

conducted spurious @ 802.11n HT40 mode channel 3 (3of 3)

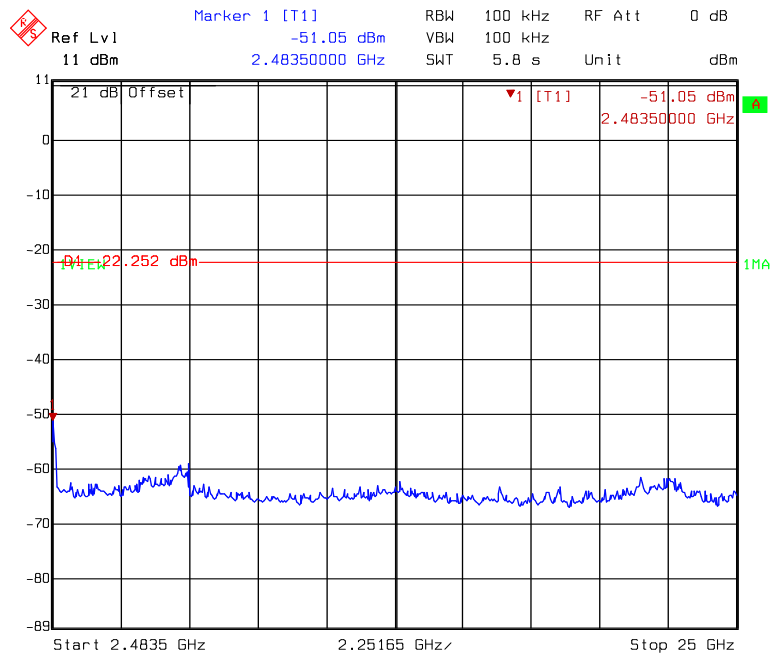

Title: Conductive-Spurious
 Comment A: CH 3 at 802.11n 40MHz mode
 Date: 22.JAN.2009 11:41:33

conducted spurious @ 802.11n HT40 mode channel 6 (1of 3)

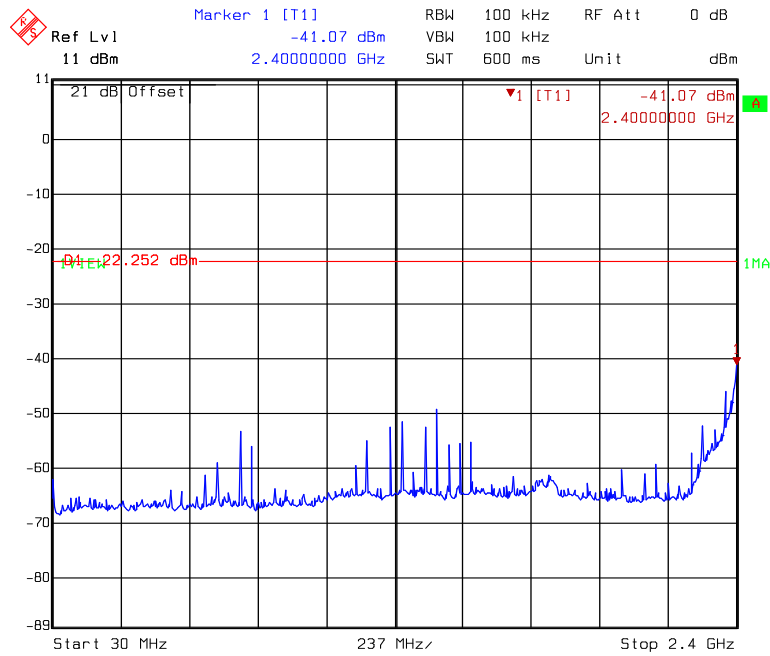

conducted spurious @ 802.11n HT40 mode channel 6 (2of 3)

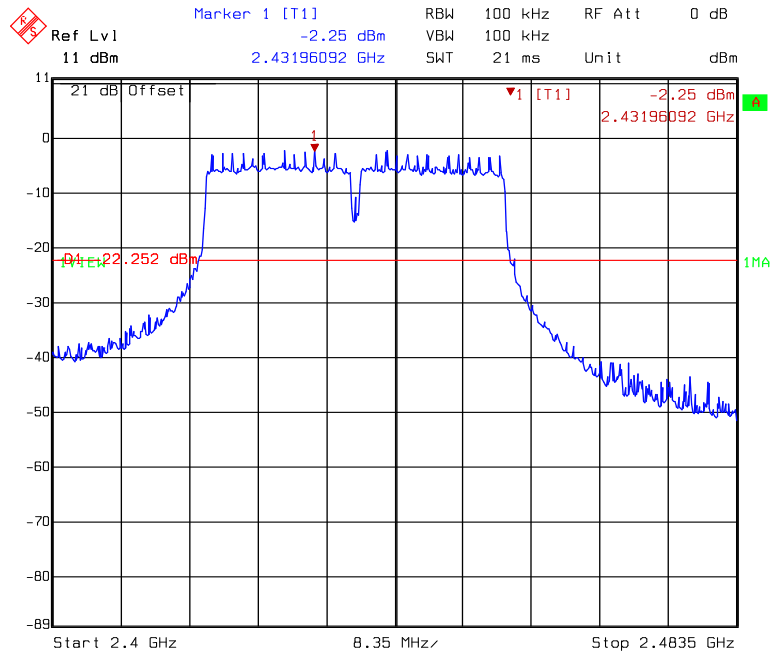

conducted spurious @ 802.11n HT40 mode channel 6 (3of 3)

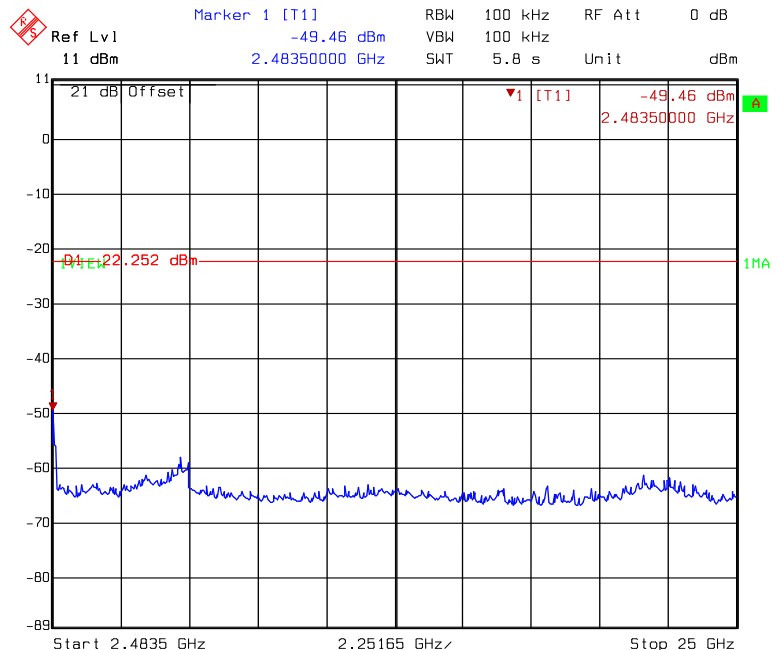

Title: Conductive-Spurious
Comment A: CH 6 at 802.11n 40MHz mode
Date: 22.JAN.2009 11:38:38

conducted spurious @ 802.11n HT40 mode channel 9 (1of 3)

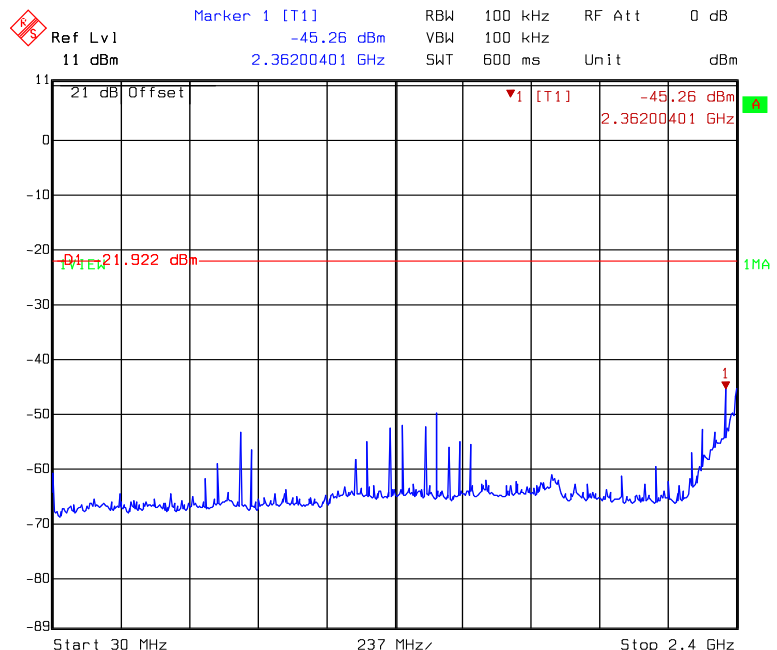

Title: Conductive-Spurious
Comment A: CH 9 at 802.11n 40MHz mode
Date: 22.JAN.2009 11:31:38

conducted spurious @ 802.11n HT40 mode channel 9 (2of 3)

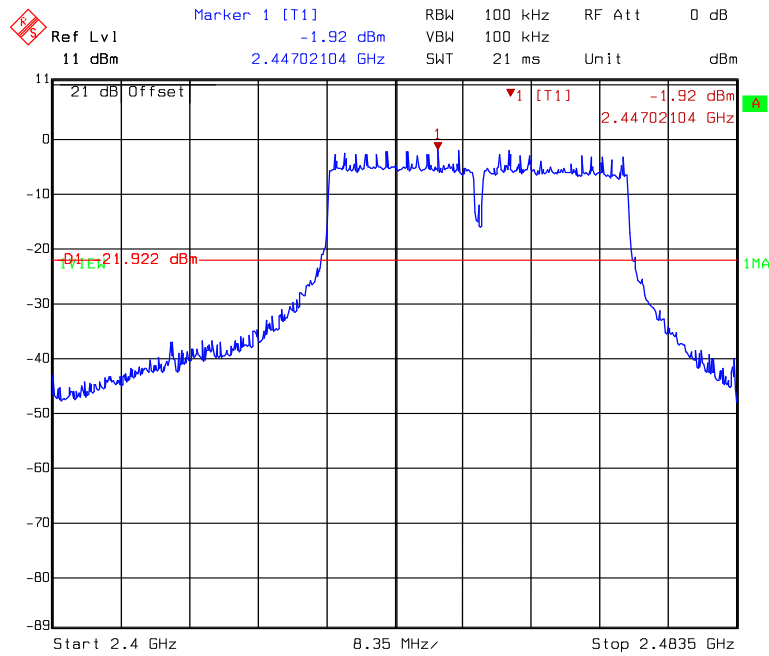

Title: Conductive-Spurious
 Comment A: CH 9 at 802.11n 40MHz mode
 Date: 22.JAN.2009 11:31:16

conducted spurious @ 802.11n HT40 mode channel 9 (3of 3)

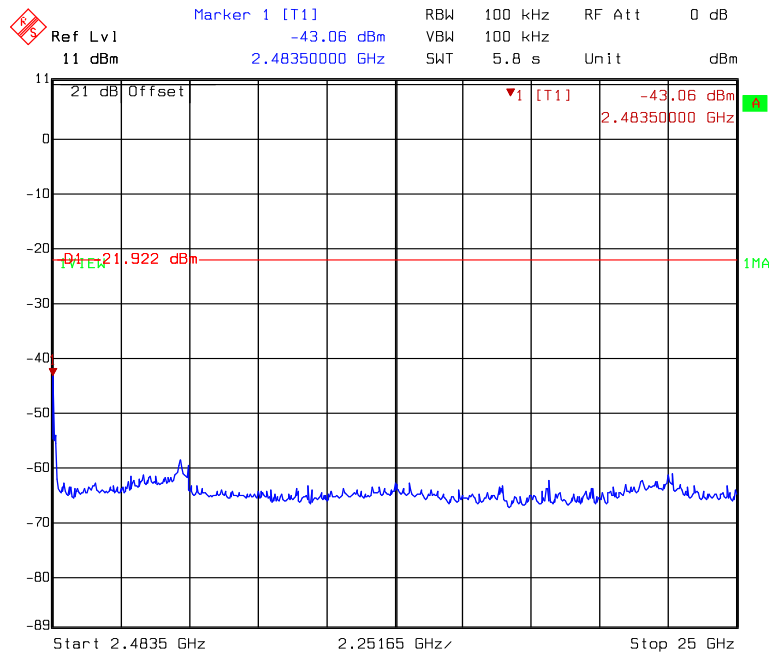

Title: Conductive-Spurious
 Comment A: CH 9 at 802.11n 40MHz mode
 Date: 22.JAN.2009 11:32:06

8. Radiated Spurious Emission

Name of Test	Radiated Spurious Emission
Base Standard	FCC 15.247(d), 15.209, 15.205

Test Result: Complies
Measurement Data: See Tables below

Method of Measurement:

Reference FCC document: KDB558074, ANSI C63.4

The frequency range from 30 MHz to 1000 MHz using Bilog Antenna.
The frequency range over 1 GHz using Horn Antenna.

Radiated emissions were investigated cover the frequency range from 30 MHz to 1000 MHz using a receiver RBW of 120 kHz record QP reading, and the frequency over 1 GHz using a spectrum analyzer RBW of 1 MHz and 10 Hz VBW record Average reading. (15.209 paragraph), the Peak reading (1 MHz RBW/VBW) recorded also on the report. The EUT for testing is arranged on a wooden turntable. If some peripherals apply to the EUT, the peripherals will be connected to EUT and the whole system. During the test, all cables were arranged to produce worst-case emissions. The signal is maximized through rotation. The height of antenna and polarization is changing constantly for exploring for maximum signal level. The height of antenna can be up to 4 meters and down to 1 meter. The measurement for radiated emission will be done at the distance of three meters unless the signal level is too low to measure at that distance. In the case of the reading under noise floor, a pre-amplifier is used and/or the test is conducted at a closer distance. And then all readings are extrapolated back to the equivalent 3 meters reading using inverse scaling with distance.

The EUT configuration please refer to the "Spurious set-up photo.pdf".

Test Diagram:

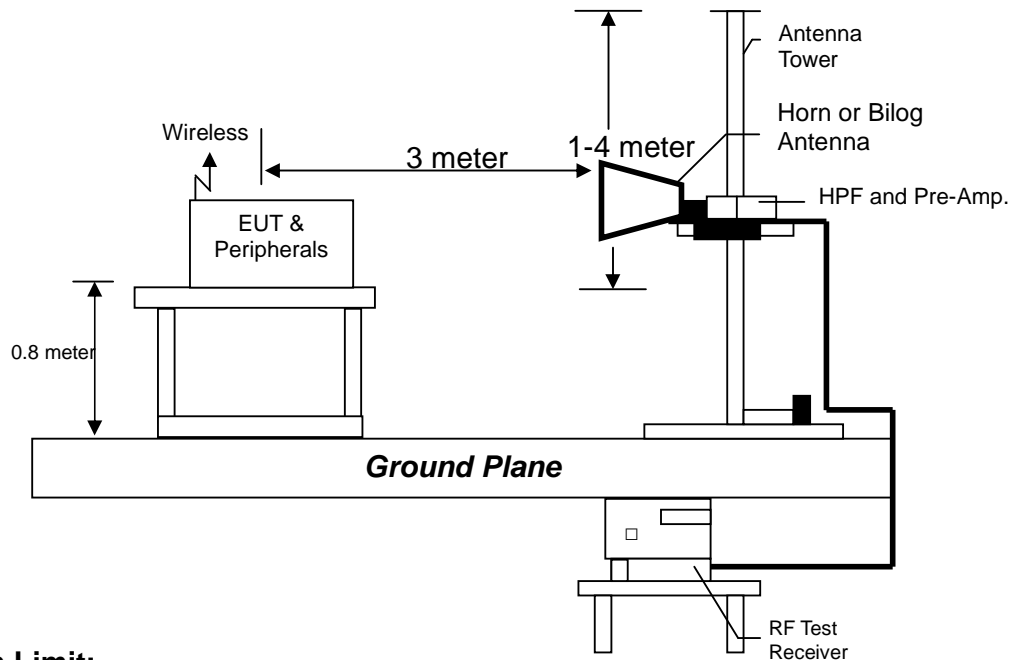

Emission Limit:

The spurious Emission shall test through the 10th harmonic. In addition, radiated emissions which fall in the restricted bands, as defined in §15.205(a), must also comply with the radiated emission limits specified in §15.209(a).

Frequency (MHz)	Limits (dB μ V/m@ 3 meter)
30-88	40
88-216	43.5
216-960	46
Above 960	54

Remark:

1. In the above table, the tighter limit applies at the band edges.
2. Distance refers to the distance in meters between the measuring instrument antenna and the closed point of any part of the device or system

- Note:**
- (1) The EUT was tested while in a continuous transmit mode and the worst case data rates are 1 Mbps for 802.11b, 6 Mbps for 802.11g, 6.5 Mbps for 802.11n HT20 and 13.5 Mbps for 802.11n HT40. The EUT was tuned to a low, middle and high channel.
 - (2) The EUT operating at 2.4 GHz ISM band. Frequency Range scanned from 30 MHz to 25 GHz.

Measurement results: frequencies equal to or less than 1 GHz

The test was performed on EUT under 802.11b, 802.11g, 802.11n HT20 and 802.11n HT40 continuously transmitting mode. The worst case occurred at 802.11b Tx channel 1.

EUT : VUS-100
 Worst Case : 802.11b Tx at channel 1

Antenna Polariz. (V/H)	Freq. (MHz)	Receiver Detector	Corr. Factor (dB/m)	Reading (dBuV)	Corrected Level (dBuV/m)	Limit @ 3 m (dBuV/m)	Margin (dB)
V	35.820	QP	12.62	22.33	34.95	40.00	-5.05
V	86.260	QP	8.50	22.85	31.34	40.00	-8.66
V	155.130	QP	15.83	20.20	36.03	43.50	-7.47
V	249.220	QP	12.22	17.76	29.97	46.00	-16.03
V	599.390	QP	20.71	13.48	34.19	46.00	-11.81
V	679.900	QP	22.33	7.73	30.05	46.00	-15.95
H	83.350	QP	9.45	26.00	35.44	40.00	-4.56
H	99.840	QP	7.93	26.85	34.77	43.50	-8.73
H	159.980	QP	13.60	21.81	35.41	43.50	-8.09
H	210.420	QP	11.10	26.11	37.20	43.50	-6.30
H	249.220	QP	12.36	24.35	36.71	46.00	-9.29
H	399.570	QP	16.74	21.28	38.02	46.00	-7.98

Remark:

1. Corr. Factor = Antenna Factor + Cable Loss
2. Corrected Level = Reading + Corr. Factor

Measurement results: frequency above 1GHz

EUT : VUS-100
 Test Condition : 802.11b Tx at channel 1

Frequency (MHz)	Spectrum Analyzer Detector	Antenna Polariz. (H/V)	Preamp. Gain (dB)	Correction Factor (dB/m)	Reading (dBuV)	Corrected Level (dBuV/m)	Limit @ 3 m (dBuV/m)	Margin (dB)
1238.00	PK	V	-	28.54	15.43	43.97	54	-10.03
1238.00	PK	H	-	28.54	15.24	43.78	54	-10.22
7236.00	PK	V	33.0	44.60	37.97	49.57	54	-4.43
9648.00	PK	V	32.7	49.30	34.89	51.49	54	-2.51
4824.00	PK	H	35.1	38.54	38.21	41.65	54	-12.35

Remark:

1. Correction Factor = Antenna Factor + Cable Loss
2. Corrected Level = Reading + Correction Factor – Preamp. Gain
3. The frequency measured ranges from 1 GHz to 25 GHz.The data value listed above which is higher than the system noise floor.

EUT : VUS-100SI
 Test Condition : 802.11b Tx at channel 6

Frequency (MHz)	Spectrum Analyzer Detector	Antenna Polariz. (H/V)	Preamp. Gain (dB)	Correction Factor (dB/m)	Reading (dBuV)	Corrected Level (dBuV/m)	Limit @ 3 m (dBuV/m)	Margin (dB)
7311.00	PK	V	33.0	44.60	38.20	49.80	54	-4.20
9748.00	PK	V	32.7	49.30	40.69	57.29	74	-16.71
9748.00	AV	V	32.7	49.30	36.74	53.34	54	-0.66
9748.00	PK	H	32.7	49.30	35.82	52.42	54	-1.58

Remark:

1. Correction Factor = Antenna Factor + Cable Loss
2. Corrected Level = Reading + Correction Factor – Preamp. Gain
3. The frequency measured ranges from 1 GHz to 25 GHz.The data value listed above which is higher than the system noise floor.

EUT : VUS-100
 Test Condition : 802.11b Tx at channel 11

Frequency (MHz)	Spectrum Analyzer Detector	Antenna Polariz. (H/V)	Preamp. Gain (dB)	Correction Factor (dB/m)	Reading (dBuV)	Corrected Level (dBuV/m)	Limit @ 3 m (dBuV/m)	Margin (dB)
7386.00	PK	V	33.0	44.6	37.22	48.82	54.00	-5.18
9848.00	PK	V	32.7	49.3	41.78	58.38	101.31	-42.93
9848.00	AV	V	32.7	49.3	38.80	55.40	81.31	-25.91
9848.00	PK	H	32.7	49.3	41.54	58.14	74.00	-15.86
9848.00	AV	H	32.7	49.3	36.72	53.32	54.00	-0.68

Remark:

1. Correction Factor = Antenna Factor + Cable Loss
2. Corrected Level = Reading + Correction Factor – Preamp. Gain
3. The frequency measured ranges from 1 GHz to 25 GHz. The data value listed above which is higher than the system noise floor.

EUT : VUS-100
 Test Condition : 802.11g Tx at channel 1

Frequency (MHz)	Spectrum Analyzer Detector	Antenna Polariz. (H/V)	Preamp. Gain (dB)	Correction Factor (dB/m)	Reading (dBuV)	Corrected Level (dBuV/m)	Limit @ 3 m (dBuV/m)	Margin (dB)
7236.00	PK	V	33.0	44.60	40.49	52.09	54	-1.91
4824.00	PK	H	35.1	38.54	37.82	41.26	54	-12.74

Remark:

1. Correction Factor = Antenna Factor + Cable Loss
2. Corrected Level = Reading + Correction Factor – Preamp. Gain
3. The frequency measured ranges from 1 GHz to 25 GHz. The data value listed above which is higher than the system noise floor.

EUT : VUS-100
 Test Condition : 802.11g Tx at channel 6

Frequency (MHz)	Spectrum Analyzer Detector	Antenna Polariz. (H/V)	Preamp. Gain (dB)	Correction Factor (dB/m)	Reading (dBuV)	Corrected Level (dBuV/m)	Limit @ 3 m (dBuV/m)	Margin (dB)
7311.00	PK	V	33.0	44.60	37.24	48.84	54	-5.16
9748.00	PK	V	32.7	49.30	34.58	51.18	54	-2.82
4874.00	PK	H	35.1	38.54	37.66	41.10	54	-12.90

Remark:

1. Correction Factor = Antenna Factor + Cable Loss
2. Corrected Level = Reading + Correction Factor – Preamp. Gain
3. The frequency measured ranges from 1 GHz to 25 GHz. The data value listed above which is higher than the system noise floor.

EUT : VUS-100
 Test Condition : 802.11g Tx at channel 11

Frequency (MHz)	Spectrum Analyzer Detector	Antenna Polariz. (H/V)	Preamp. Gain (dB)	Correction Factor (dB/m)	Reading (dBuV)	Corrected Level (dBuV/m)	Limit @ 3 m (dBuV/m)	Margin (dB)
7386.00	PK	V	33.0	44.60	37.52	49.12	54	-4.88
9848.00	PK	V	32.7	49.30	36.03	52.63	54	-1.37
4924.00	PK	H	35.1	38.54	38.07	41.51	54	-12.49

Remark:

1. Correction Factor = Antenna Factor + Cable Loss
2. Corrected Level = Reading + Correction Factor – Preamp. Gain
3. The frequency measured ranges from 1 GHz to 25 GHz. The data value listed above which is higher than the system noise floor.

EUT : VUS-100
 Test : 802.11n HT20 Tx at channel 1

Frequency (MHz)	Spectrum Analyzer Detector	Antenna Polariz. (H/V)	Preamp. Gain (dB)	Correction Factor (dB/m)	Reading (dBuV)	Corrected Level (dBuV/m)	Limit @ 3 m (dBuV/m)	Margin (dB)
4824.00	PK	V	35.1	38.54	37.57	41.01	54	-12.99
4824.00	PK	H	35.1	38.54	38.08	41.52	54	-12.48

Remark:

1. Correction Factor = Antenna Factor + Cable Loss
2. Corrected Level = Reading + Correction Factor – Preamp. Gain
3. The frequency measured ranges from 1GHz to 25GHz.The data value listed above which is higher than the system noise floor.

EUT : VUS-100
 Test : 802.11n HT20 Tx at channel 6

Frequency (MHz)	Spectrum Analyzer Detector	Antenna Polariz. (H/V)	Preamp. Gain (dB)	Correction Factor (dB/m)	Reading (dBuV)	Corrected Level (dBuV/m)	Limit @ 3 m (dBuV/m)	Margin (dB)
4874.00	PK	V	35.1	38.54	37.6	41.04	54	-12.96
4874.00	PK	H	35.1	38.54	37.2	40.64	54	-13.36

Remark:

1. Correction Factor = Antenna Factor + Cable Loss
2. Corrected Level = Reading + Correction Factor – Preamp. Gain
3. The frequency measured ranges from 1GHz to 25GHz.The data value listed above which is higher than the system noise floor.

EUT : VUS-100
 Test : 802.11n HT20 Tx at channel 11

Frequency (MHz)	Spectrum Analyzer Detector	Antenna Polariz. (H/V)	Preamp. Gain (dB)	Correction Factor (dB/m)	Reading (dBuV)	Corrected Level (dBuV/m)	Limit @ 3 m (dBuV/m)	Margin (dB)
4924.00	PK	V	35.1	38.54	37.26	40.70	54	-13.30
4924.00	PK	H	35.1	38.54	37.33	40.77	54	-13.23

Remark:

1. Correction Factor = Antenna Factor + Cable Loss
2. Corrected Level = Reading + Correction Factor – Preamp. Gain
3. The frequency measured ranges from 1GHz to 25GHz.The data value listed above which is higher than the system noise floor.

EUT : VUS-100
 Test : 802.11n HT40 Tx at channel 3

Frequency (MHz)	Spectrum Analyzer Detector	Antenna Polariz. (H/V)	Preamp. Gain (dB)	Correction Factor (dB/m)	Reading (dBuV)	Corrected Level (dBuV/m)	Limit @ 3 m (dBuV/m)	Margin (dB)
4844.00	PK	V	35.1	38.54	37.79	41.23	54	-12.77
4844.00	PK	H	35.1	38.54	37.72	41.16	54	-12.84

Remark:

1. Correction Factor = Antenna Factor + Cable Loss
2. Corrected Level = Reading + Correction Factor – Preamp. Gain
3. The frequency measured ranges from 1GHz to 25GHz.The data value listed above which is higher than the system noise floor.

EUT : VUS-100
 Test : 802.11n HT40 Tx at channel 6

Frequency (MHz)	Spectrum Analyzer Detector	Antenna Polariz. (H/V)	Preamp. Gain (dB)	Correction Factor (dB/m)	Reading (dBuV)	Corrected Level (dBuV/m)	Limit @ 3 m (dBuV/m)	Margin (dB)
4874.00	PK	V	35.1	38.54	37.17	40.61	54	-13.39
4874.00	PK	H	35.1	38.54	37.55	40.99	54	-13.01

Remark:

1. Correction Factor = Antenna Factor + Cable Loss
2. Corrected Level = Reading + Correction Factor – Preamp. Gain
3. The frequency measured ranges from 1GHz to 25GHz.The data value listed above which is higher than the system noise floor.

EUT : VUS-100
 Test : 802.11n HT40 Tx at channel 9

Frequency (MHz)	Spectrum Analyzer Detector	Antenna Polariz. (H/V)	Preamp. Gain (dB)	Correction Factor (dB/m)	Reading (dBuV)	Corrected Level (dBuV/m)	Limit @ 3 m (dBuV/m)	Margin (dB)
4904.00	PK	V	35.1	38.54	37.56	41.00	54	-13.00
4904.00	PK	H	35.1	38.54	37.09	40.53	54	-13.47

Remark:

1. Correction Factor = Antenna Factor + Cable Loss
2. Corrected Level = Reading + Correction Factor – Preamp. Gain
3. The frequency measured ranges from 1GHz to 25GHz.The data value listed above which is higher than the system noise floor.

9. Emission on Band Edge

Name of Test	Emission Band Edge
Base Standard	FCC 15.247(d)

Test Result: Complies
Measurement Data: See Tables & plots below

Method of Measurement:

Reference FCC document: KDB558074, ANSI C63.4

The frequency range from 30 MHz to 1000 MHz using Bilog Antenna.
The frequency range over 1 GHz using Horn Antenna.

Radiated emissions were investigated cover the frequency range from 30 MHz to 1000 MHz using a receiver RBW of 120 kHz record QP reading, and the frequency over 1 GHz using a spectrum analyzer RBW of 1 MHz and 10 Hz VBW record Average reading. (15.209 paragraph), the Peak reading (1 MHz RBW/VBW) recorded also on the report.

Note: The EUT was tested while in a continuous transmit mode and the worst case data rates are 1 Mbps for 802.11b, 6 Mbps for 802.11g, 6.5 Mbps for 802.11n HT20 and 13.5 Mbps for 802.11n HT40. The EUT was tuned to a low, middle and high channel.

Test Mode: 802.11b mode

Channel	Measurement Freq.Band (MHz)	Detector	The Max. Field Strength in Restrict Band (dBuV/m)	Limit @ 3 m (dBuV/m)	Margin (dB)
1 (lowest)	2310-2390	PK	61.66	74	-12.34
		AV	52.70	54	-1.30
11 (highest)	2483.5-2500	PK	59.48	74	-14.52
		AV	49.77	54	-4.23

Test Mode: 802.11g mode

Channel	Measurement Freq.Band (MHz)	Detector	The Max. Field Strength in Restrict Band (dBuV/m)	Limit @ 3 m (dBuV/m)	Margin (dB)
1 (lowest)	2310-2390	PK	68.96	74	-5.04
		AV	52.63	54	-1.37
11 (highest)	2483.5-2500	PK	69.51	74	-4.49
		AV	52.26	54	-1.74

Test Mode: 802.11n HT20

Channel	Measurement Freq.Band (MHz)	Detector	The Max. Field Strength in Restrict Band (dBuV/m)	Limit @ 3 m (dBuV/m)	Margin (dB)
1 (lowest)	2310-2390	PK	62.26	74	-11.74
		AV	49.41	54	-4.59
11 (highest)	2483.5-2500	PK	59.47	74	-14.53
		AV	47.76	54	-6.24

Test Mode: 802.11n HT40

Channel	Measurement Freq.Band (MHz)	Detector	The Max. Field Strength in Restrict Band (dBuV/m)	Limit @ 3 m (dBuV/m)	Margin (dB)
1 (lowest)	2310-2390	PK	69.92	74	-4.08
		AV	53.14	54	-0.86
11 (highest)	2483.5-2500	PK	72.19	74	-1.81
		AV	49.20	54	-4.80

Band edge @ 802.11b mode channel 1 PK

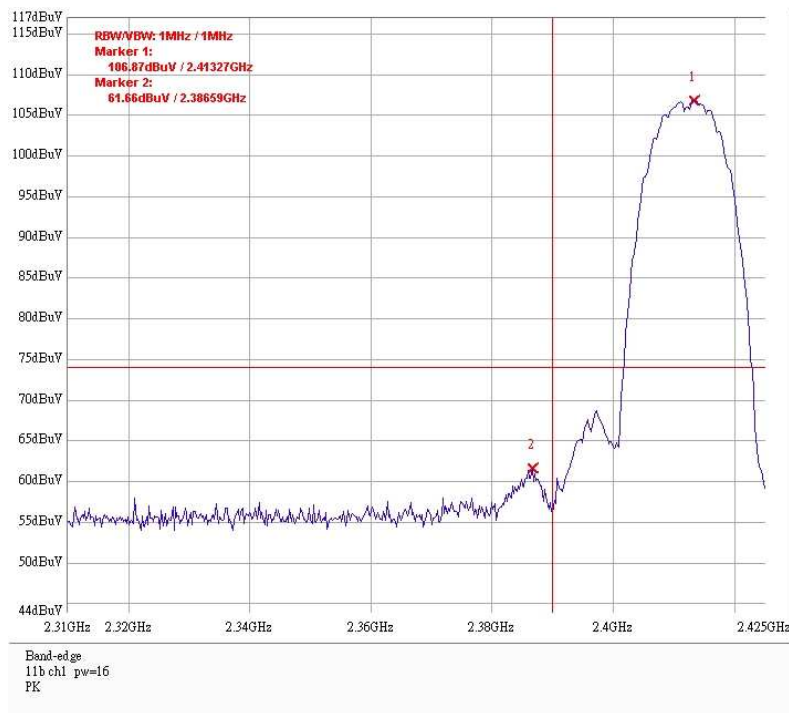

Band edge @ 802.11b mode channel 1 AV

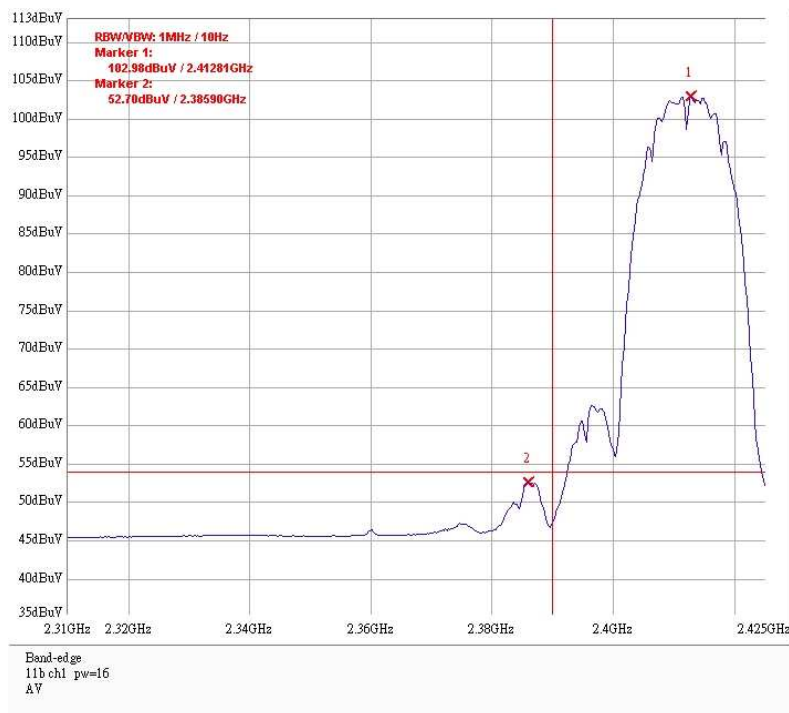

Band edge @ 802.11b mode channel 11 PK

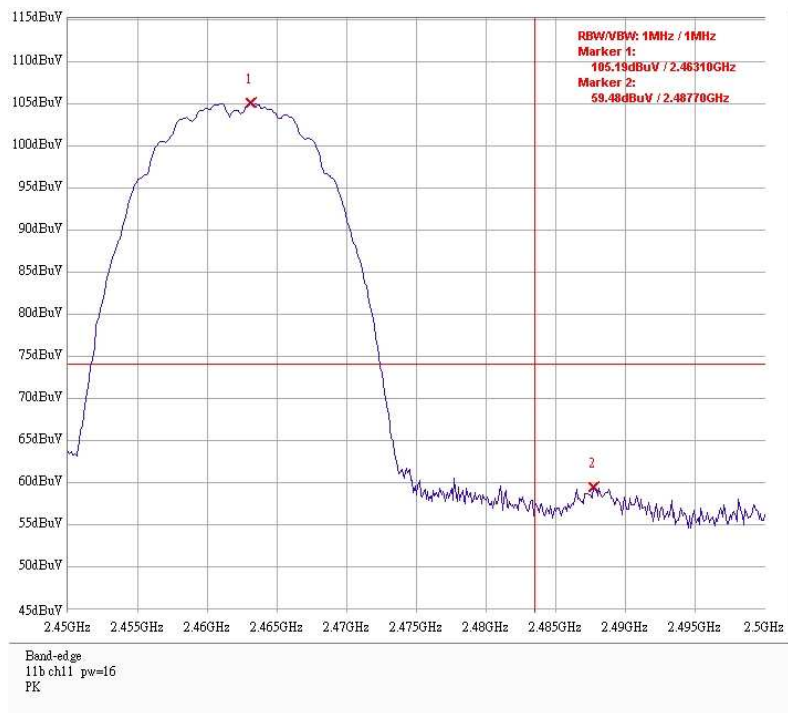

Band edge @ 802.11b mode channel 11 AV

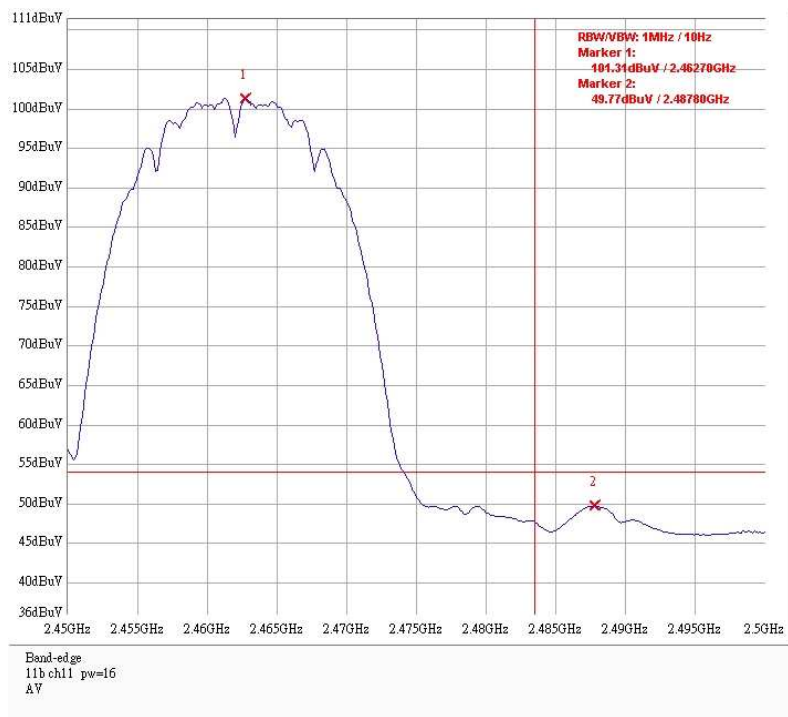

Band edge @ 802.11g mode channel 1 PK

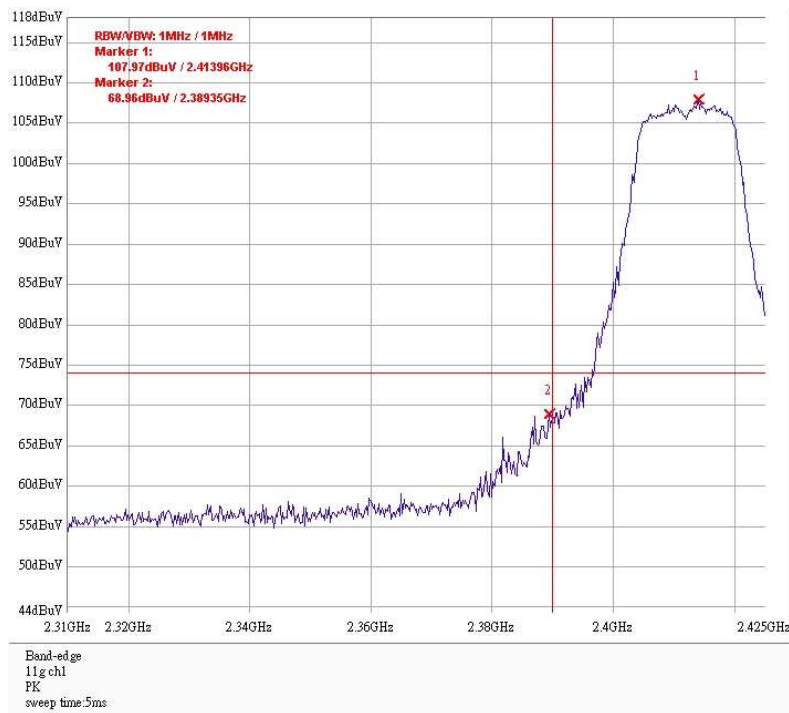

Band edge @ 802.11g mode channel 1 AV

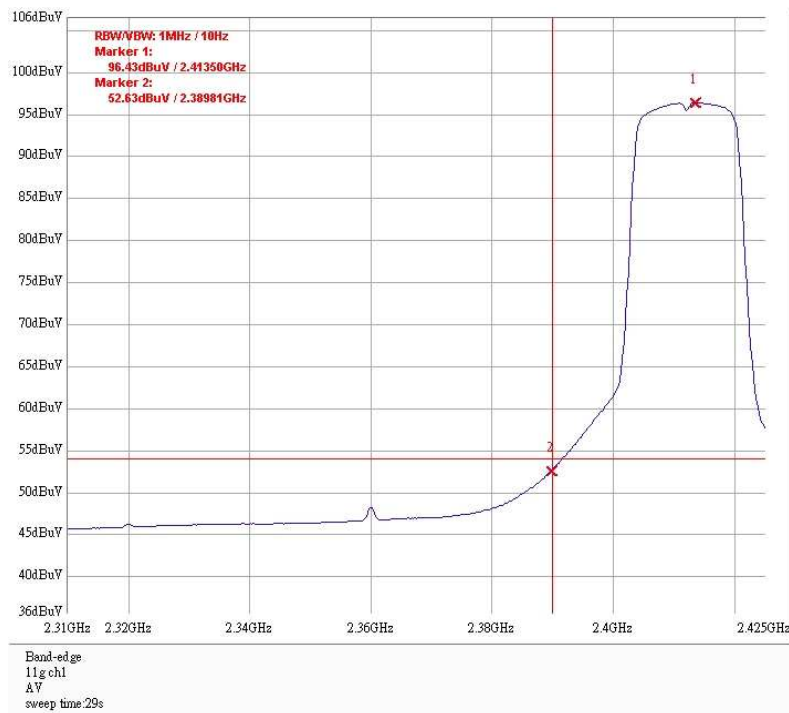

Band edge @ 802.11g mode channel 11 PK

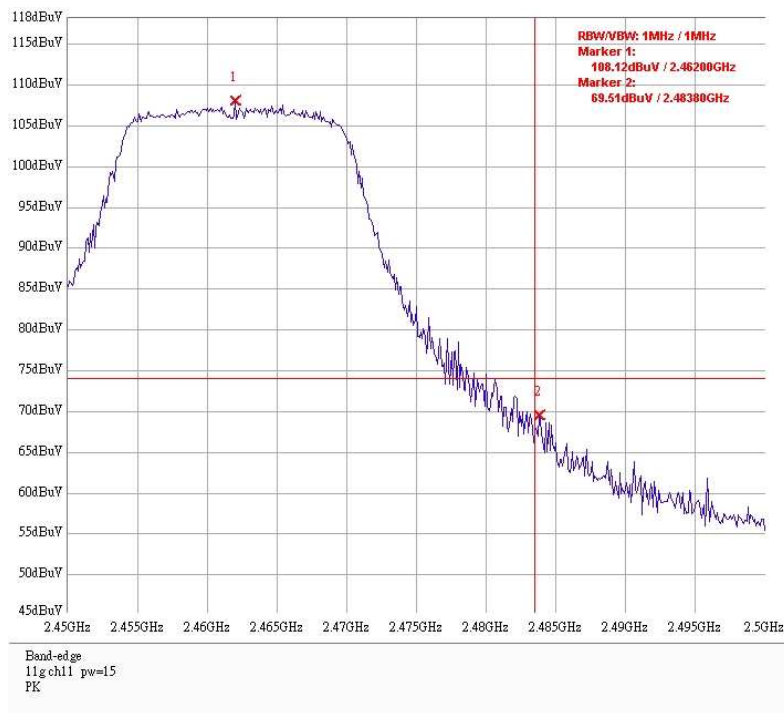

Band edge @ 802.11g mode channel 11 AV

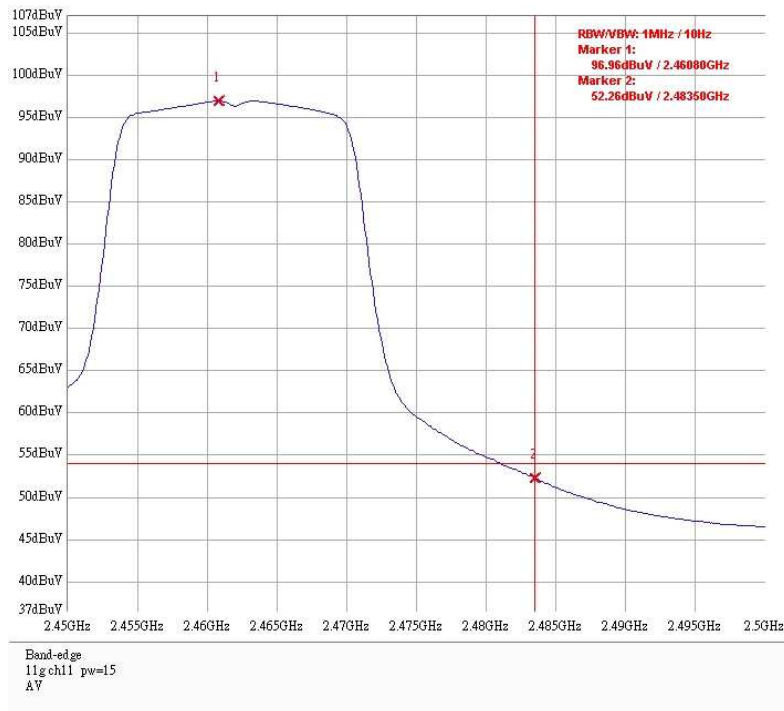

Band edge @802.11n HT20 mode channel 1 PK

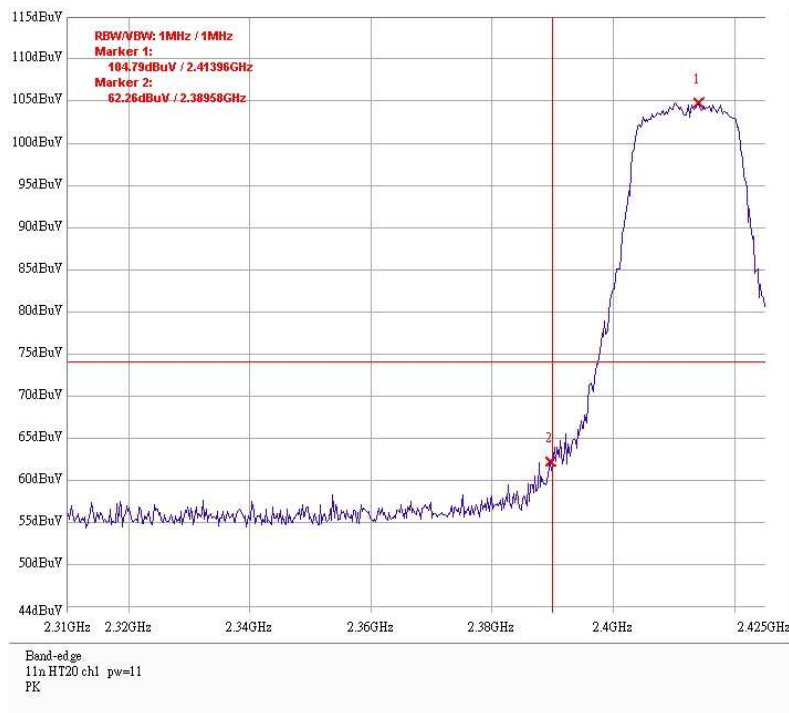

Band edge @802.11n HT20 mode channel 1 AV

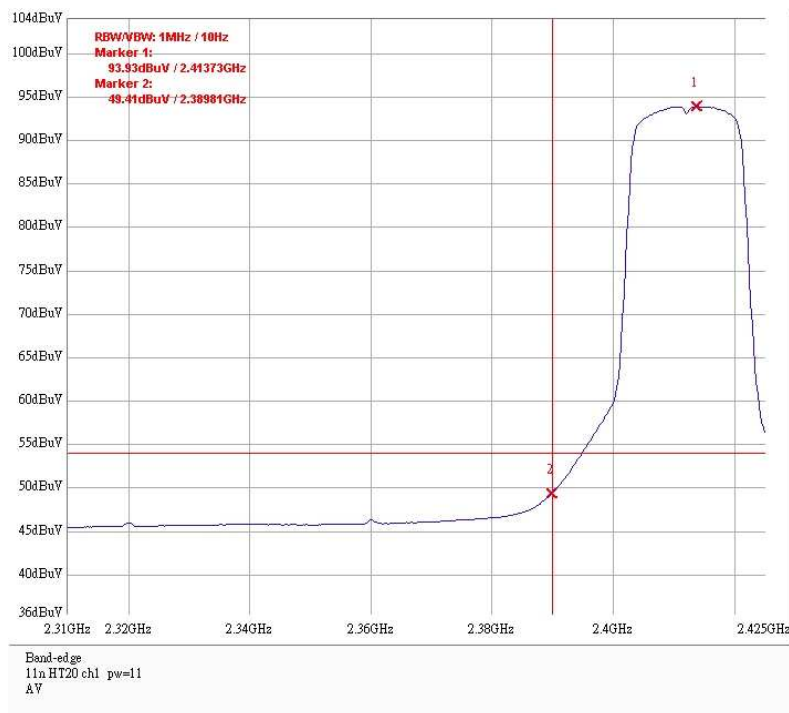

Band edge @802.11n HT20 mode channel 11 PK

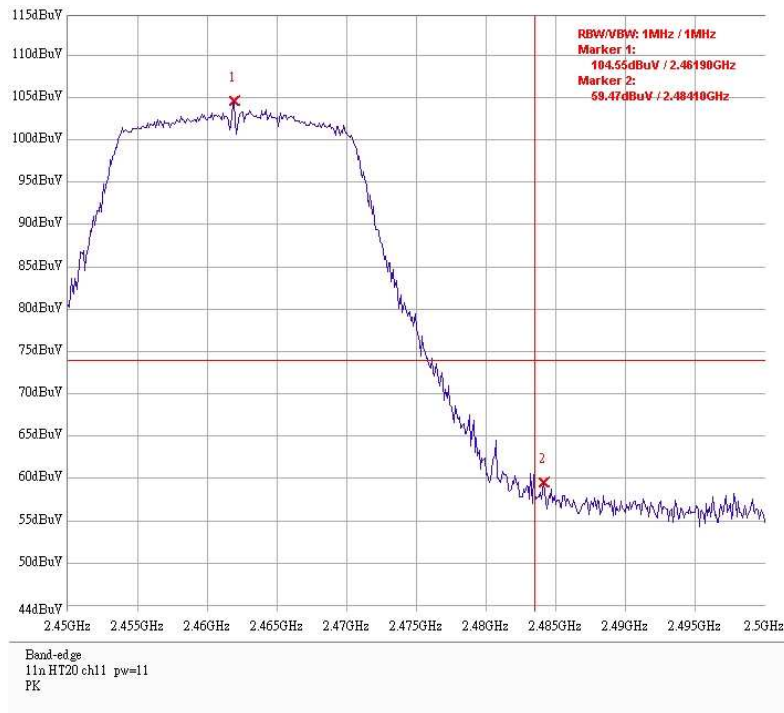

Band edge @802.11n HT20 mode channel 11 AV

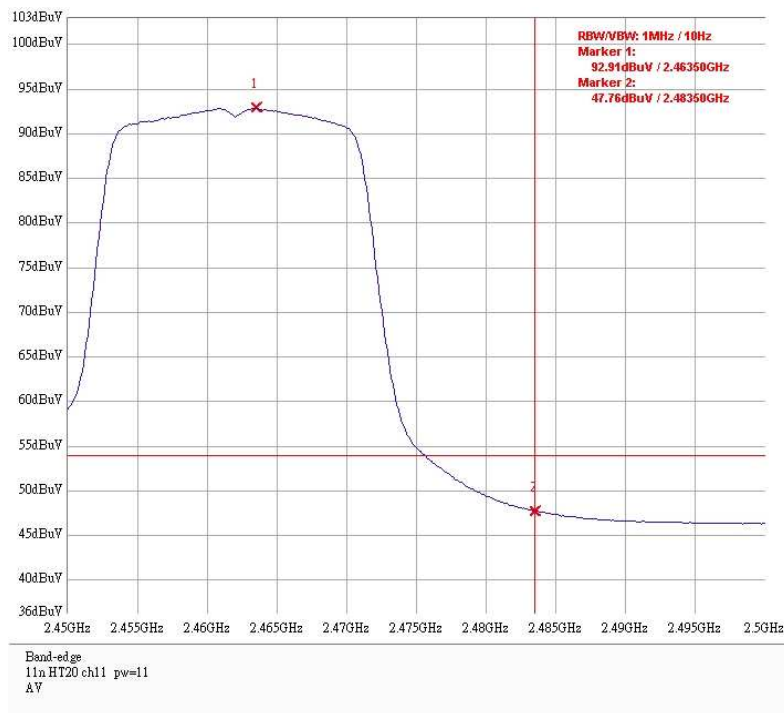

Band edge @802.11n HT40 mode channel 3 PK

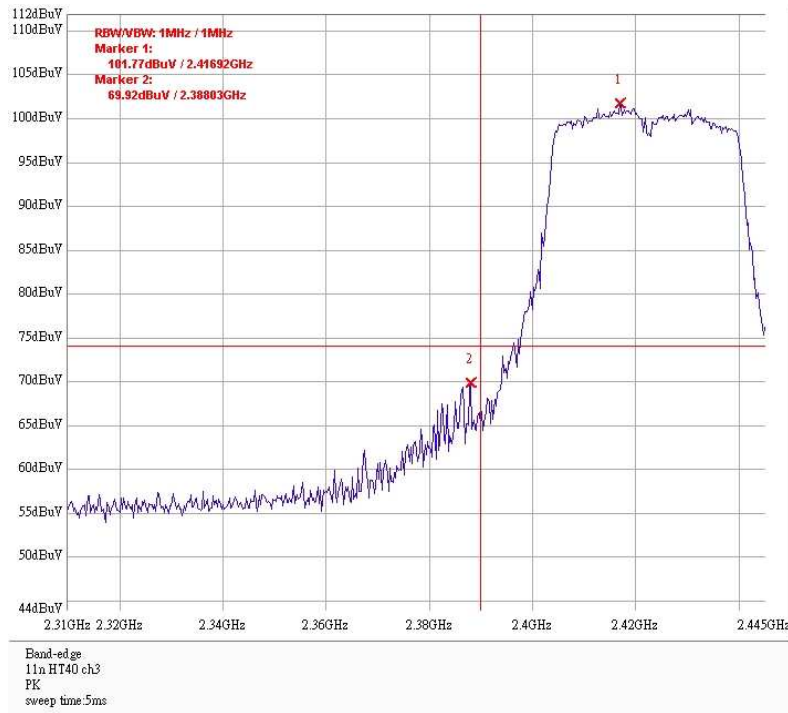

Band edge @802.11n HT40 mode channel 3 AV

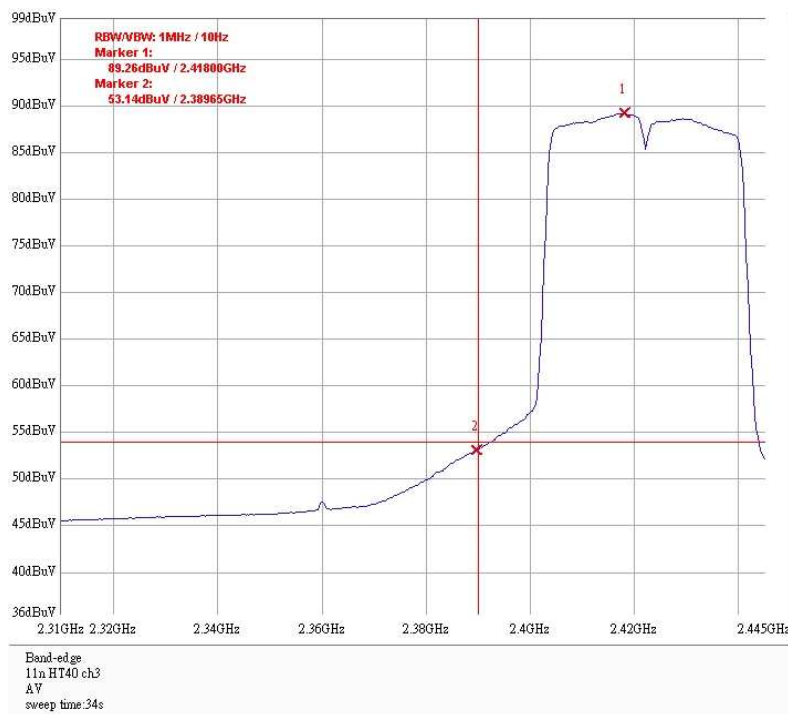

Band edge @802.11n HT40 mode channel 9 PK

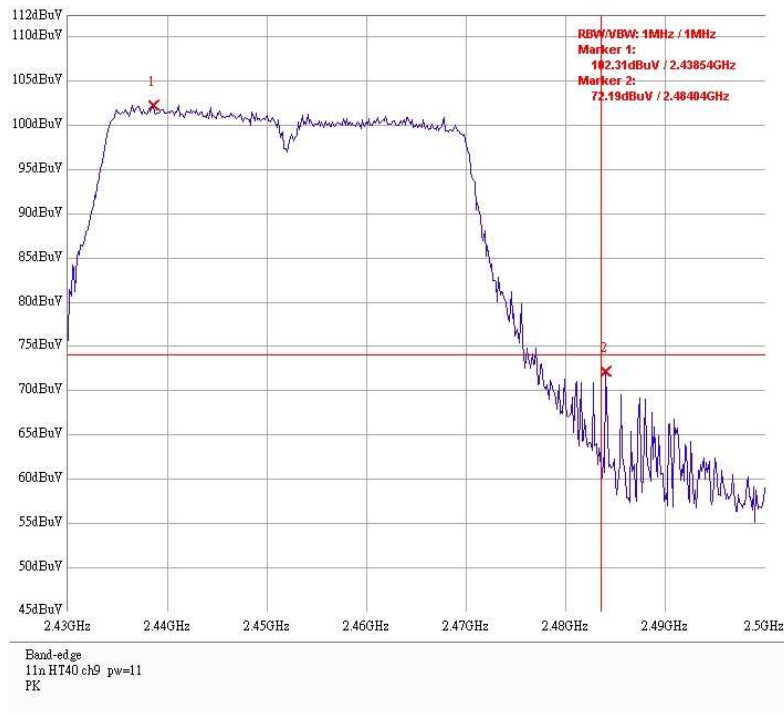

Band edge @802.11n HT40 mode channel 9 AV

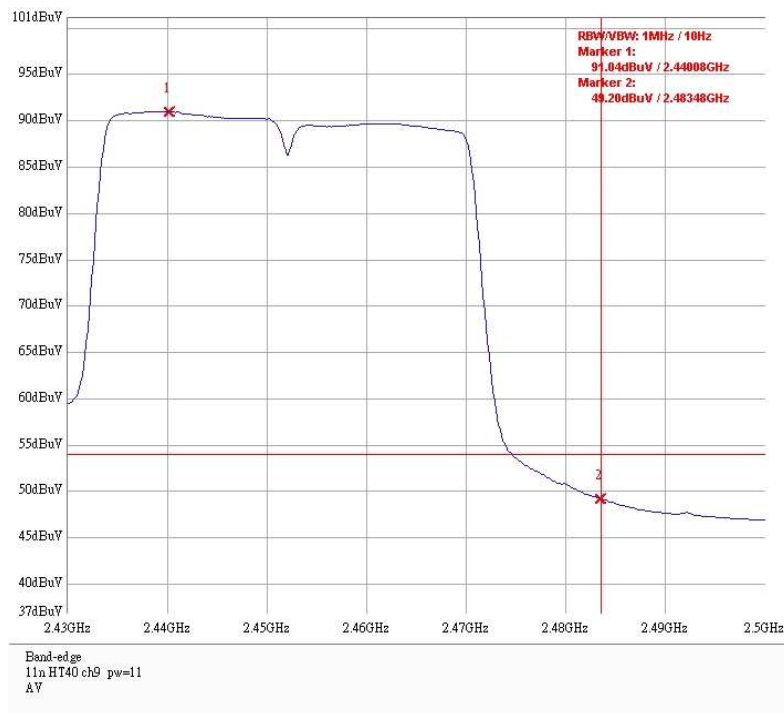

10. AC power line conducted emission

Name of Test	AC power line conducted emission
Base Standard	FCC 15.207

Test Result: Complies
Measurement Data: See Tables & plots below

Method of Measurement:
Reference FCC document: KDB558074, ANSI C63.4

The EUT are connected to the main power through a line impedance stabilization network (LISN). This provides a 50 ohm/50 uH coupling impedance for the measuring equipment. The peripheral devices are also connected to the main power through a LISN that provides a 50 ohm/ 50 uH coupling impedance with 50 ohm termination.

Both sides (Line and Neutral) of AC line are checked for maximum conducted interference. In order to find the maximum emission, the relative positions of equipment and all of the interface cables must be changed according to ANSI C63.4/2003 on conducted measurement.

The bandwidth of the field strength meter (R & S Test Receiver ESCS 30) is set at 9kHz.

The EUT configuration please refer to the “Conducted set-up photo.pdf”.

Test Diagram:

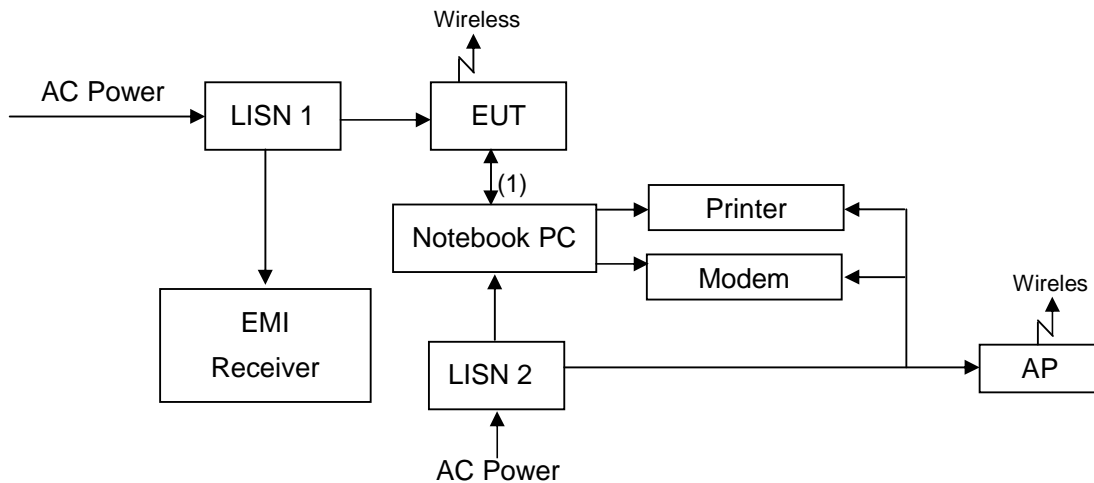

(1) USB shielded cable 0.5 meter

Emission Limit:

Freq. (MHz)	Conducted Limit (dBuV)	
	Q.P.	Ave.
0.15~0.50	66 – 56*	56 – 46*
0.50~5.00	56	46
5.00~30.0	60	50

*Decreases with the logarithm of the frequency.

Note: The EUT was tested while in normal communication mode.

Phase : Line
 EUT : VUS-100
 Test Condition : Normal operating mode

Frequency (MHz)	Corr. Factor (dB)	Level Qp (dBuV)	Limit Qp (dBuV)	Level Av (dBuV)	Limit Av (dBuV)	Margin (dB)	
						Qp	Av
0.16	0.81	27.10	65.47	6.95	55.47	-38.38	-48.53
0.45	0.11	33.64	56.85	16.50	46.85	-23.21	-30.35
1.81	0.14	23.38	56.00	7.47	46.00	-32.62	-38.53
4.61	0.33	28.08	56.00	22.12	46.00	-27.92	-23.88
7.69	0.45	34.68	60.00	24.11	50.00	-25.32	-25.89
9.35	0.49	34.96	60.00	20.41	50.00	-25.04	-29.59

Remark:

1. Correction Factor (dB)= LISN Factor (dB) + Cable Loss (dB)
2. Margin (dB) = Level (dBuV) – Limit (dBuV)

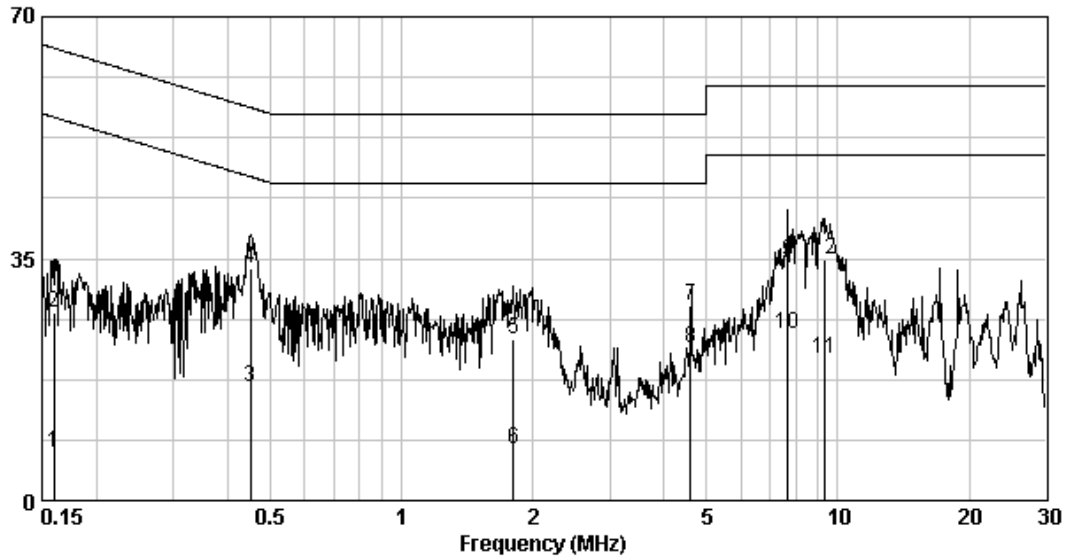

Phase : Neutral
 EUT : VUS-100
 Test Condition : Normal operating mode

Frequency (MHz)	Corr. Factor (dB)	Level Qp (dBuV)	Limit Qp (dBuV)	Level Av (dBuV)	Limit Av (dBuV)	Margin (dB)	
						Qp	Av
0.46	0.11	33.59	56.76	18.45	46.76	-23.17	-28.31
1.66	0.13	19.71	56.00	4.72	46.00	-36.29	-41.28
1.86	0.14	20.78	56.00	4.65	46.00	-35.22	-41.35
4.61	0.31	26.78	56.00	15.34	46.00	-29.22	-30.66
8.24	0.39	33.43	60.00	12.58	50.00	-26.57	-37.42
9.25	0.40	34.74	60.00	14.13	50.00	-25.26	-35.87

Remark:

1. Correction Factor (dB)= LISN Factor (dB) + Cable Loss (dB)
2. Margin (dB) = Level (dBuV) – Limit (dBuV)

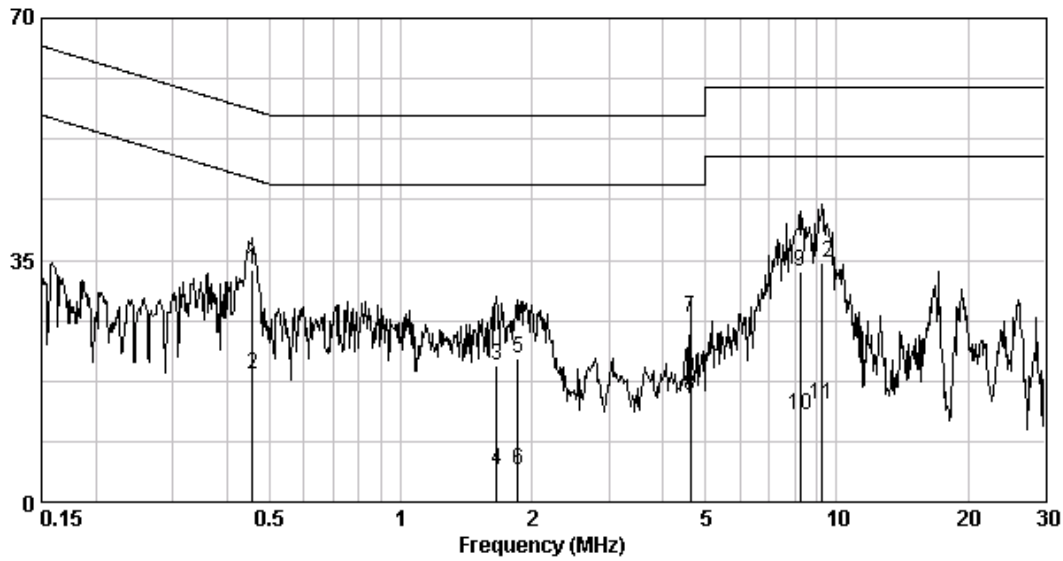

Appendix A: Test Equipment List

Equipment	Brand	Model No.
EMI Test Receiver	Rohde & Schwarz	ESCS 30
Spectrum Analyzer	Rohde & Schwarz	FSP 30
Spectrum Analyzer	Rohde & Schwarz	FSEK 30
Signal Generator	Rohde & Schwarz	SMR27
Horn Antenna	SCHWARZBECK	BBHA 9120 D
Horn Antenna	SCHWARZBECK	BBHA 9170
Bilog Antenna	SCHWARZBECK	VULB 9168
Pre-Amplifier	MITEQ	919981
Pre-Amplifier	MITEQ	828825
Controller	HDGmbH	CM 100
Antenna Tower	HDGmbH	MA 2400
LISN	Rohde & Schwarz	ESH3-Z5
Wideband Peak Power Meter/ Sensor	Anritsu	ML2495A/ MA2411B
Temperature Humidity Test Chamber	Juror	TR-4010

- Note: 1. The above equipments are within the valid calibration period.
 2. The test antennas (receiving antenna) are calibration per 3 years.
 3. The video bandwidth of the power meter and sensor can be up to 65 MHz.

Measurement Uncertainty:

Measurement uncertainty was calculated in accordance with NAMAS NIS 81.

Parameter	Uncertainty
Radiated Emission	±4.98 dB
Conducted Emission	±2.6 dB

This uncertainty represents an expanded uncertainty expressed at approximately the 95 % confidence level using a coverage factor of k=2.