

Supplemental “Transmit Simultaneously” Test Report

Report No.: RFBDMW-WTW-P22090030-2

FCC ID: M4Y-AS240

Test Model: AS240

Received Date: 2022/9/5

Test Date: 2022/10/13 ~ 2022/11/3

Issued Date: 2022/11/16

Applicant: Z-COM, INC.

Address: 5F, No.8, HSIN ANN RD., HSINCH SCIENCE PARK, HSINCHU, 300
TAIWAN

Issued By: Bureau Veritas Consumer Products Services (H.K.) Ltd., Taoyuan Branch
Hsin Chu Laboratory

Lab Address: E-2, No.1, Li Hsin 1st Road, Hsinchu Science Park, Hsinchu City 300,
Taiwan

Test Location: E-2, No.1, Li Hsin 1st Road, Hsinchu Science Park, Hsinchu City 300,
Taiwan

**FCC Registration /
Designation Number:** 723255 / TW2022



This report is governed by, and incorporates by reference, the Conditions of Testing as posted at the date of issuance of this report at <http://www.bureauveritas.com/home/about-us/our-business/cps/about-us/terms-conditions/> and is intended for your exclusive use. Any copying or replication of this report to or for any other person or entity, or use of our name or trademark, is permitted only with our prior written permission. This report sets forth our findings solely with respect to the test samples identified herein. The results set forth in this report are not indicative or representative of the quality or characteristics of the lot from which a test sample was taken or any similar or identical product unless specifically and expressly noted. Our report includes all of the tests requested by you and the results thereof based upon the information that you provided to us. Measurement uncertainty is only provided upon request for accredited tests. Statements of conformity are based on simple acceptance criteria without taking measurement uncertainty into account, unless otherwise requested in writing. You have 60 days from date of issuance of this report to notify us of any material error or omission caused by our negligence or if you require measurement uncertainty; provided, however, that such notice shall be in writing and shall specifically address the issue you wish to raise. A failure to raise such issue within the prescribed time shall constitute your unqualified acceptance of the completeness of this report, the tests conducted and the correctness of the report contents.

Table of Contents

Release Control Record	3
1 Certificate of Conformity	4
2 Summary of Test Results	5
2.1 Measurement Uncertainty.....	5
2.2 Modification Record.....	5
3 General Information	6
3.1 General Description of EUT.....	6
3.1.1 Test Mode Applicability and Tested Channel Detail.....	8
3.2 Description of Support Units.....	10
3.2.1 Configuration of System under Test.....	11
4 Test Types and Results	12
4.1 Radiated Emission and Bandedge Measurement.....	12
4.1.1 Limits of Radiated Emission and Bandedge Measurement.....	12
4.1.2 Test Instruments.....	13
4.1.3 Test Procedures.....	15
4.1.4 Deviation from Test Standard.....	16
4.1.5 Test Setup.....	16
4.1.6 EUT Operating Conditions.....	17
4.1.7 Test Results.....	18
4.2 Conducted Emission Measurement.....	21
4.2.1 Limits of Conducted Emission Measurement.....	21
4.2.2 Test Instruments.....	21
4.2.3 Test Procedures.....	22
4.2.4 Deviation from Test Standard.....	22
4.2.5 Test Setup.....	22
4.2.6 EUT Operating Conditions.....	22
4.2.7 Test Results.....	23
4.3 Conducted Out of Band Emission Measurement.....	25
4.3.1 Limits of Conducted Out of Band Emission Measurement.....	25
4.3.2 Test Setup.....	25
4.3.3 Test Instruments.....	25
4.3.4 Test Procedures.....	25
4.3.5 Deviation from Test Standard.....	25
4.3.6 EUT Operating Conditions.....	25
4.3.7 Test Results.....	25
5 Pictures of Test Arrangements	27
Appendix – Information of the Testing Laboratories	28

Release Control Record

Issue No.	Description	Date Issued
RFBDMW-WTW-P22090030-2	Original release.	2022/11/16

1 Certificate of Conformity

Product: 802.11ax Access Point

Brand: ZCOM

Test Model: AS240

Sample Status: Engineering sample

Applicant: Z-COM, INC.

Test Date: 2022/10/13 ~ 2022/11/3

Standards: 47 CFR FCC Part 15, Subpart C (Section 15.247)

47 CFR FCC Part 15, Subpart E (Section 15.407)

ANSI C63.10: 2013

The above equipment has been tested by **Bureau Veritas Consumer Products Services (H.K.) Ltd., Taoyuan Branch**, and found compliance with the requirement of the above standards. The test record, data evaluation & Equipment Under Test (EUT) configurations represented herein are true and accurate accounts of the measurements of the sample's EMC characteristics under the conditions specified in this report.

Prepared by : Vivian Huang , **Date:** 2022/11/16
Vivian Huang / Specialist

Approved by :  , **Date:** 2022/11/16
May Chen / Manager

2 Summary of Test Results

FCC Part 15, Subpart C, E (SECTION 15.247, 15.407)			
FCC Clause	Test Item	Result	Remarks
15.207 15.407(b)(6)	AC Power Conducted Emission	PASS	Meet the requirement of limit. Minimum passing margin is -3.14 dB at 21.58984 MHz.
15.205 / 15.209 / 15.247(d) 15.407(b) (1/2/3/4(i/ii)/6)	Radiated Emissions and Band Edge Measurement	PASS	Meet the requirement of limit. Minimum passing margin is -4.8 dB at 32.21 MHz.

Note:

- Determining compliance based on the results of the compliance measurement, not taking into account measurement instrumentation uncertainty.

2.1 Measurement Uncertainty

Where relevant, the following measurement uncertainty levels have been estimated for tests performed on the EUT as specified in CISPR 16-4-2:

Measurement	Frequency	Expanded Uncertainty (k=2) (±)
Conducted Emissions at mains ports	150kHz ~ 30MHz	1.9 dB
Radiated Emissions up to 1 GHz	9kHz ~ 30MHz	3.1 dB
	30MHz ~ 1GHz	5.1 dB
Radiated Emissions above 1 GHz	1GHz ~ 18GHz	5.1 dB
	18GHz ~ 40GHz	5.3 dB

2.2 Modification Record

There were no modifications required for compliance.

3 General Information

3.1 General Description of EUT

Product	802.11ax Access Point
Brand	ZCOM
Test Model	AS240
Status of EUT	Engineering sample
Power Supply Rating	48Vdc from POE
Modulation Type	CCK, DQPSK, DBPSK for DSSS 64QAM, 16QAM, QPSK, BPSK for OFDM 256QAM for OFDM in 11ac mode and VHT mode in 2.4GHz 1024QAM for OFDMA in 11ax mode
Modulation Technology	DSSS, OFDM, OFDMA
Transfer Rate	802.11b: up to 11Mbps 802.11a/g: up to 54Mbps 802.11n: up to 300Mbps 802.11ac: up to 866.7Mbps 802.11ax: up to 1201.0Mbps
Operating Frequency	2.4GHz: 2.412 ~ 2.462GHz 5GHz: 5.18~ 5.24GHz, 5.745 ~ 5.825GHz
Number of Channel	2.4GHz: 802.11b, 802.11g, 802.11n (HT20), VHT20 ,802.11ax (HE20): 11 802.11n (HT40), VHT40, 802.11ax (HE40): 7 5GHz: 802.11a, 802.11n (HT20), 802.11ac (VHT20), 802.11ax (HE20): 9 802.11n (HT40), 802.11ac (VHT40), 802.11ax (HE40): 4 802.11ac (VHT80), 802.11ax (HE80): 2
Antenna Type	Refer to Note
Antenna Connector	Refer to Note
Accessory Device	NA
Data Cable Supplied	NA

Note:

1. Simultaneously transmission condition.

Condition	Technology	
1	WLAN (2.4GHz)	WLAN (5GHz)

Note: The emission of the simultaneous operation has been evaluated and no non-compliance was found.

2. The antenna information is listed as below.

Antenna No.	RF Chain No.	Antenna Net Gain(dBi)	Frequency range (GHz)	Antenna Type	Connector Type
1	Chain 0	2.85	2.4~2.4835	PIFA PCB	none
		4.48	5.15~5.85		
2	Chain 1	3.97	2.4~2.4835	PIFA PCB	none
		3.65	5.15~5.85		

3. The EUT incorporates a MIMO function.

2.4 GHz Band		
Modulation Mode	TX & RX Configuration	
802.11b	2TX	2RX
802.11g	2TX	2RX
802.11n (HT20)	2TX	2RX
802.11n (HT40)	2TX	2RX
VHT20	2TX	2RX
VHT40	2TX	2RX
802.11ax (HE20)	2TX	2RX
802.11ax (HE40)	2TX	2RX
5 GHz Band		
Modulation Mode	TX & RX Configuration	
802.11a	2TX	2RX
802.11n (HT20)	2TX	2RX
802.11n (HT40)	2TX	2RX
802.11ac (VHT20)	2TX	2RX
802.11ac (VHT40)	2TX	2RX
802.11ac (VHT80)	2TX	2RX
802.11ax (HE20)	2TX	2RX
802.11ax (HE40)	2TX	2RX
802.11ax (HE80)	2TX	2RX

4. The above EUT information is declared by manufacturer and for more detailed features description, please refers to the manufacturer's specifications or user's manual.

5. Detail antenna specification please refer to antenna datasheet and/or antenna measurement report.

3.1.1 Test Mode Applicability and Tested Channel Detail

EUT CONFIGURE MODE	APPLICABLE TO				DESCRIPTION
	RE \geq 1G	RE $<$ 1G	PLC	OB	
-	√	√	√	√	-

Where **RE \geq 1G**: Radiated Emission above 1GHz & Bandedge Measurement

RE $<$ 1G: Radiated Emission below 1GHz

PLC: Power Line Conducted Emission

OB: Conducted Out-Band Emission Measurement

Note: The EUT had been pre-tested on the positioned of laying-flat and wall-mount. The worst case was found when positioned of on laying-flat.

Radiated Emission Test (Above 1GHz):

The tested configurations represent the worst-case mode from all possible combinations by the maximum power.

Following channel(s) was (were) selected for the final test as listed below.

MODE	AVAILABLE CHANNEL	TESTED CHANNEL	MODULATION TECHNOLOGY	MODULATION TYPE
802.11ax (HE20)	1 to 11	6	OFDMA	BPSK
+	36 to 48			
802.11ax (HE20)	149 to 165	165	OFDMA	BPSK

Radiated Emission Test (Below 1GHz):

The tested configurations represent the worst-case mode from all possible combinations by the maximum power.

Following channel(s) was (were) selected for the final test as listed below.

MODE	AVAILABLE CHANNEL	TESTED CHANNEL	MODULATION TECHNOLOGY	MODULATION TYPE
802.11ax (HE20)	1 to 11	6	OFDMA	BPSK
+	36 to 48			
802.11ax (HE20)	149 to 165	165	OFDMA	BPSK

Power Line Conducted Emission Test:

The tested configurations represent the worst-case mode from all possible combinations by the maximum power.

Following channel(s) was (were) selected for the final test as listed below.

MODE	AVAILABLE CHANNEL	TESTED CHANNEL	MODULATION TECHNOLOGY	MODULATION TYPE
802.11ax (HE20)	1 to 11	6	OFDMA	BPSK
+	36 to 48			
802.11ax (HE20)	149 to 165	165	OFDMA	BPSK

Conducted Out-Band Emission Measurement:

- The tested configurations represent the worst-case mode from all possible combinations by the maximum power.
- Following channel(s) was (were) selected for the final test as listed below.

MODE	AVAILABLE CHANNEL	TESTED CHANNEL	MODULATION TECHNOLOGY	MODULATION TYPE
802.11ax (HE20) +	1 to 11	6	OFDMA	BPSK
802.11ax (HE20)	36 to 48 149 to 165	165	OFDMA	BPSK

Test Condition:

Applicable To	Environmental Conditions	Input Power (System)	Tested By
RE \geq 1G	25deg. C, 66%RH	120Vac, 60Hz	Louis Yang
RE<1G	31deg. C, 76%RH	120Vac, 60Hz	Louis Yang
PLC	25deg. C, 66%RH	120Vac, 60Hz	Tom Yang
OB	25deg. C, 60%RH	120Vac, 60Hz	Kevin Ko

3.2 Description of Support Units

The EUT has been tested as an independent unit together with other necessary accessories or support units. The following support units or accessories were used to form a representative test configuration during the tests.

ID	Product	Brand	Model No.	Serial No.	FCC ID	Remarks
A	Laptop	Lenovo	20U5S01X00 L14	PF-1ANPYA	N/A	Provided by Lab
B	Laptop	Lenovo	20U5S01X00 L14	PF-28LKK7	N/A	Provided by Lab
C	PoE Adapter	Gigabit	PSE301G	N/A	N/A	Supplied by applicant

ID	Cable Descriptions	Qty.	Length (m)	Shielding (Yes/No)	Cores (Qty.)	Remarks
1	RJ-45 Cable	1	10	No	0	Provided by Lab
2	RJ-45 Cable	1	10	No	0	Provided by Lab
3	RJ-45 Cable	1	3	No	0	Provided by Lab
4	AC Power Cable	1	1.8	No	0	Provided by Lab

3.2.1 Configuration of System under Test

For AC Power Conducted Emission test

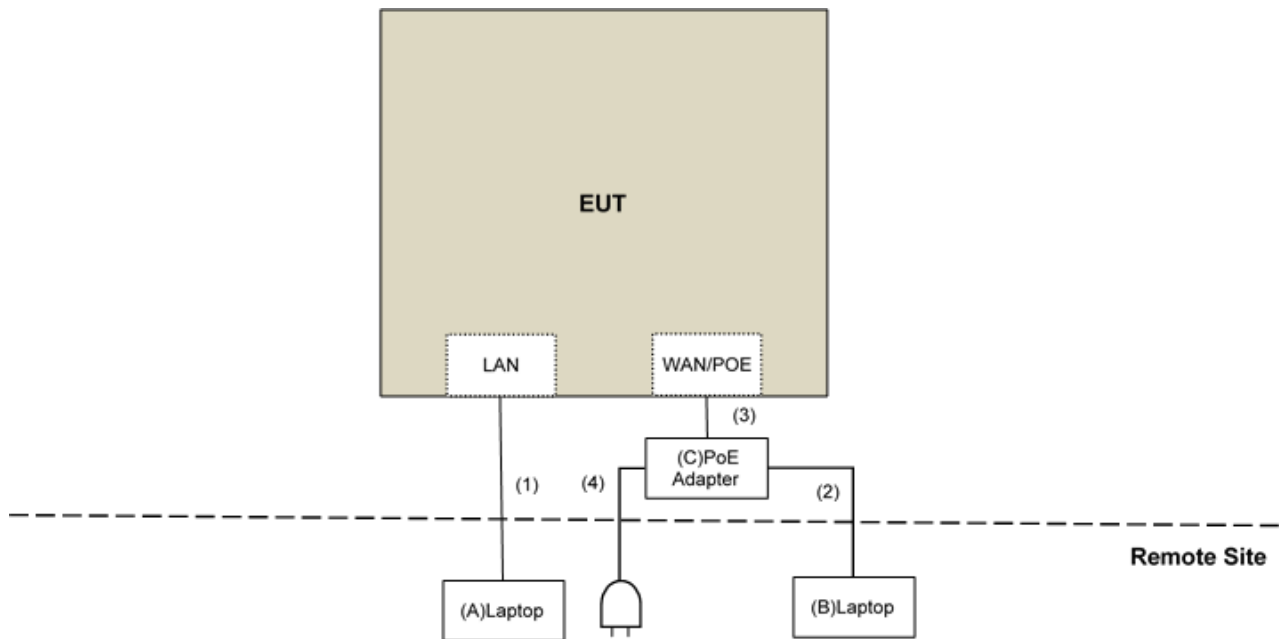

For Radiated Emission test

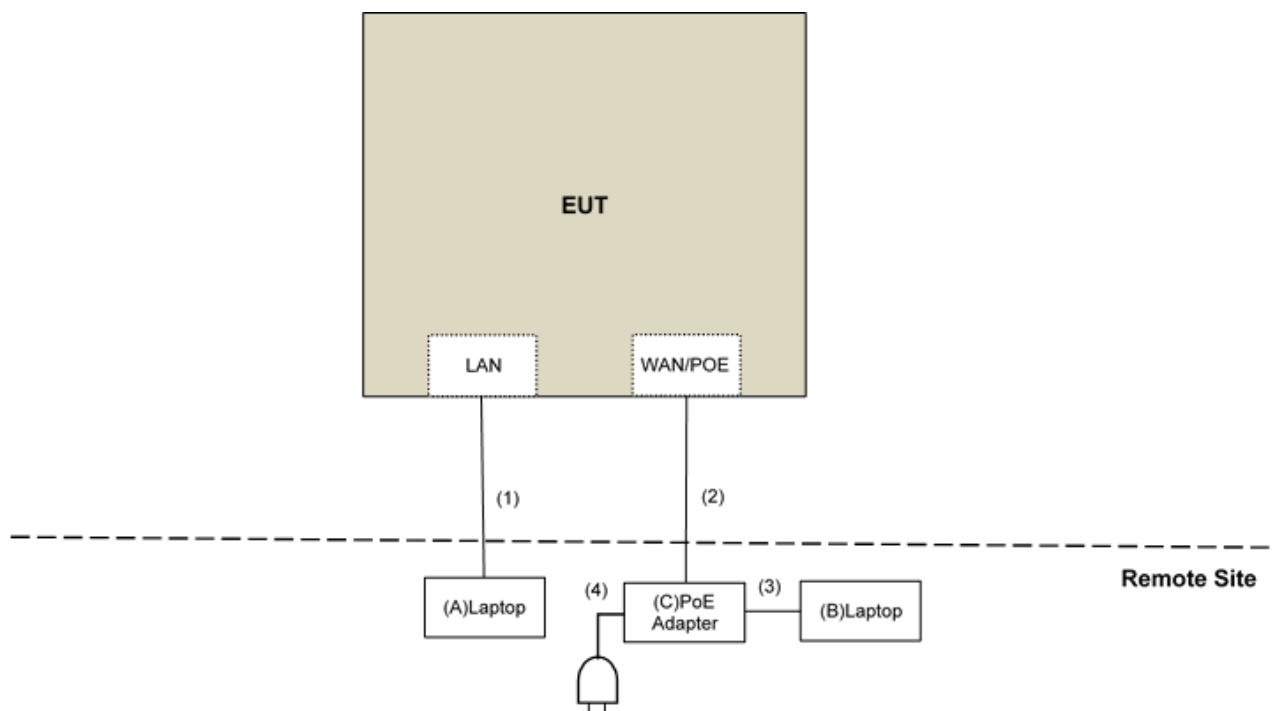

4 Test Types and Results

4.1 Radiated Emission and Bandedge Measurement

4.1.1 Limits of Radiated Emission and Bandedge Measurement

Radiated emissions which fall in the restricted bands must comply with the radiated emission limits specified as below table.

Frequencies (MHz)	Field Strength (microvolts/meter)	Measurement Distance (meters)
0.009 ~ 0.490	2400/F(kHz)	300
0.490 ~ 1.705	24000/F(kHz)	30
1.705 ~ 30.0	30	30
30 ~ 88	100	3
88 ~ 216	150	3
216 ~ 960	200	3
Above 960	500	3

Note:

1. The lower limit shall apply at the transition frequencies.
2. Emission level (dBuV/m) = 20 log Emission level (uV/m).
3. For frequencies above 1000MHz, the field strength limits are based on average detector, however, the peak field strength of any emission shall not exceed the maximum permitted average limits, specified above by more than 20dB under any condition of modulation.

Limits of unwanted emission out of the restricted bands

Applicable To		Limit	
789033 D02 General UNII Test Procedure New Rules v02r01		Field Strength at 3m	
		PK:74 (dBuV/m)	AV:54 (dBuV/m)
Frequency Band	Applicable To	EIRP Limit	Equivalent Field Strength at 3m
5150~5250 MHz	15.407(b)(1)	PK:-27 (dBm/MHz)	PK:68.2(dBuV/m)
5250~5350 MHz	15.407(b)(2)		
5470~5725 MHz	15.407(b)(3)		
5725~5850 MHz	15.407(b)(4)(i) 15.407(b)(4)(ii)	PK: -27 (dBm/MHz) ^{*1} PK: 10 (dBm/MHz) ^{*2} PK: 15.6 (dBm/MHz) ^{*3} PK: 27 (dBm/MHz) ^{*4}	PK: 68.2(dBuV/m) ^{*1} PK: 105.2 (dBuV/m) ^{*2} PK: 110.8(dBuV/m) ^{*3} PK: 122.2 (dBuV/m) ^{*4}
^{*1} beyond 75 MHz or more above of the band edge. ^{*3} below the band edge increasing linearly to a level of 15.6 dBm/MHz at 5 MHz above.		^{*2} below the band edge increasing linearly to 10 dBm/MHz at 25 MHz above. ^{*4} from 5 MHz above or below the band edge increasing linearly to a level of 27 dBm/MHz at the band edge.	

Note:

The following formula is used to convert the equipment isotropic radiated power (eirp) to field strength:

$$E = \frac{1000000\sqrt{30P}}{3} \mu\text{V/m, where P is the eirp (Watts).}$$

4.1.2 Test Instruments

For Radiated emission test (below 1 GHz):

Description & Manufacturer	Model No.	Serial No.	Calibrated Date	Calibrated Until
Test Receiver R&S	ESR3	102528	2022/2/25	2023/2/24
Spectrum Analyzer Keysight	N9020B	MY60112410	2022/3/13	2023/3/12
Software	ADT_Radiated_V8.7.08	NA	NA	NA
Boresight Antenna Tower & Turn Table Max-Full	MF-7802BS	MF780208530	NA	NA
Pre_Amplifier Agilent	8447D	2944A10636	2022/3/19	2023/3/18
LOOP ANTENNA Electro-Metrics	EM-6879	264	2022/3/18	2023/3/17
RF Coaxial Cable JYEBO	5D-FB	LOOPCAB-001	2022/1/6	2023/1/5
RF Coaxial Cable JYEBO	5D-FB	LOOPCAB-002	2022/1/6	2023/1/5
Pre_Amplifier EMCI	EMC330N	980538	2022/4/25	2023/4/24
Bilog Antenna Schwarzbeck	VULB 9168	9168-0842	2021/10/26	2022/10/25
RF Coaxial Cable COMMATE/PEWC	8D	966-5-1	2022/4/25	2023/4/24
RF Coaxial Cable COMMATE/PEWC	8D	966-5-2	2022/4/25	2023/4/24
RF Coaxial Cable COMMATE/PEWC	8D	966-5-3	2022/4/25	2023/4/24
Fixed attenuator Mini-Circuits	UNAT-5+	PAD-ATT5-02	2022/1/10	2023/1/9

Note:

1. The calibration interval of the above test instruments is 12 months and the calibrations are traceable to NML/ROC and NIST/USA.
2. The test was performed in 966 Chamber No. 5.
3. Tested Date: 2022/10/13

For Radiated emission test (above 1 GHz):

Description & Manufacturer	Model No.	Serial No.	Calibrated Date	Calibrated Until
Test Receiver R&S	ESR3	102528	2022/2/25	2023/2/24
Spectrum Analyzer Keysight	N9020B	MY60112410	2022/3/13	2023/3/12
Software	ADT_Radiated_V8.7.08	NA	NA	NA
Boresight Antenna Tower & Turn Table Max-Full	MF-7802BS	MF780208530	NA	NA
Horn Antenna Schwarzbeck	BBHA 9120D	9120D-1819	2021/11/14	2022/11/13
Pre_Amplifier EMCI	EMC12630SE	980509	2022/4/25	2023/4/24
RF Coaxial Cable EMCI	EMC104-SM-SM-1500	180503	2022/4/25	2023/4/24
RF Coaxial Cable EMCI	EMC104-SM-SM-2000	180501	2022/4/25	2023/4/24
RF Coaxial Cable EMCI	EMC104-SM-SM-6000	180506	2022/4/25	2023/4/24
Pre_Amplifier EMCI	EMC184045SE	980387	2022/1/10	2023/1/9
Horn Antenna Schwarzbeck	BBHA 9170	9170-739	2021/11/14	2022/11/13
RF Cable-Frequency range: 1-40GHz EMCI	EMC102-KM-KM-1200	160924	2022/1/10	2023/1/9
RF Coaxial Cable EMCI	EMC-KM-KM-4000	200214	2022/3/8	2023/3/7

Note:

1. The calibration interval of the above test instruments is 12 months and the calibrations are traceable to NML/ROC and NIST/USA.
2. The test was performed in 966 Chamber No. 5.
3. Tested Date: 2022/11/3

For other test items:

DESCRIPTION & MANUFACTURER	MODEL NO.	SERIAL NO.	CALIBRATED DATE	CALIBRATED UNTIL
Spectrum Analyzer R&S	FSV40	101516	2022/3/7	2023/3/6
Attenuator WOKEN	MDCS18N-10	MDCS18N-10-01	2022/4/5	2023/4/4
Software	ADT_RF Test Software V6.6.5.4	N/A	N/A	N/A

- NOTE:**
1. The test was performed in Oven room 2.
 2. The calibration interval of the above test instruments is 12 months and the calibrations are traceable to NML/ROC and NIST/USA.
 3. Tested Date: 2022/10/24

4.1.3 Test Procedures

For Radiated emission below 30MHz

- a. The EUT was placed on the top of a rotating table 0.8 meters above the ground at a 3 meter chamber room. The table was rotated 360 degrees to determine the position of the highest radiation.
- b. The EUT was set 3 meters away from the interference-receiving antenna, which was mounted on the top of a variable-height antenna tower.
- c. Parallel, perpendicular, and ground-parallel orientations of the antenna are set to make the measurement.
- d. For each suspected emission, the EUT was arranged to its worst case and the rotatable table was turned from 0 degrees to 360 degrees to find the maximum reading.
- e. The test-receiver system was set to Quasi-Peak Detect Function and Specified Bandwidth with Maximum Hold Mode.

Note:

1. The resolution bandwidth and video bandwidth of test receiver/spectrum analyzer is 9kHz at frequency below 30MHz.

For Radiated emission above 30MHz

- a. The EUT was placed on the top of a rotating table 0.8 meters (for 30MHz ~ 1GHz) above the ground at 3 meter chamber room for test. The table was rotated 360 degrees to determine the position of the highest radiation.
- b. The EUT was set 3 meters away from the interference-receiving antenna, which was mounted on the top of a variable-height antenna tower.
- c. The height of antenna is varied from one meter to four meters above the ground to determine the maximum value of the field strength. Both horizontal and vertical polarizations of the antenna are set to make the measurement.
- d. For each suspected emission, the EUT was arranged to its worst case and then the antenna was tuned to heights from 1 meter to 4 meters and the rotatable table was turned from 0 degrees to 360 degrees to find the maximum reading.
- e. The test-receiver system was set to quasi-peak detect function and specified bandwidth with maximum hold mode when the test frequency is below 1 GHz.
- f. The test-receiver system was set to peak and average detect function and specified bandwidth with maximum hold mode when the test frequency is above 1 GHz. If the peak reading value also meets average limit, measurement with the average detector is unnecessary.

Note:

1. The resolution bandwidth and video bandwidth of test receiver/spectrum analyzer is 120kHz for Quasi-peak detection (QP) at frequency below 1GHz.
2. The resolution bandwidth of test receiver/spectrum analyzer is 1 MHz and the video bandwidth is 3 MHz for Peak detection (PK) at frequency above 1GHz.
3. The resolution bandwidth of test receiver/spectrum analyzer is 1MHz and the video bandwidth is $\geq 1/T$ (Duty cycle < 98%) or 10Hz (Duty cycle $\geq 98\%$) for Average detection (AV) at frequency above 1GHz.
4. All modes of operation were investigated and the worst-case emissions are reported.

4.1.4 Deviation from Test Standard

No deviation.

4.1.5 Test Setup

For Radiated emission below 30MHz

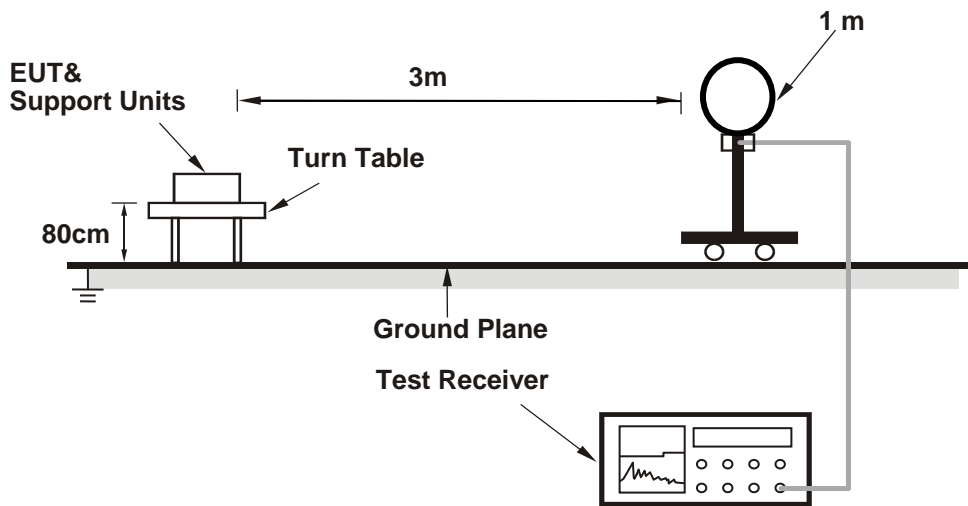

For Radiated emission 30MHz to 1GHz

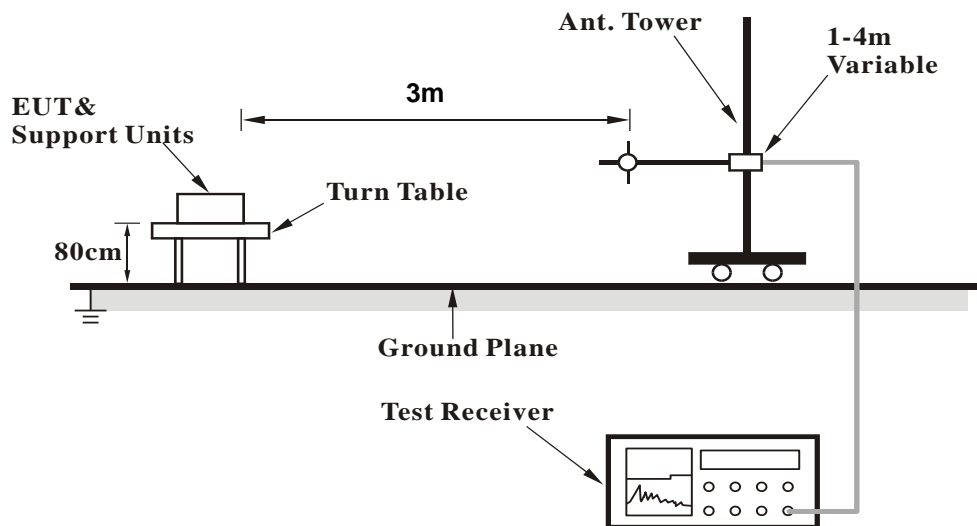

For Radiated emission above 1GHz

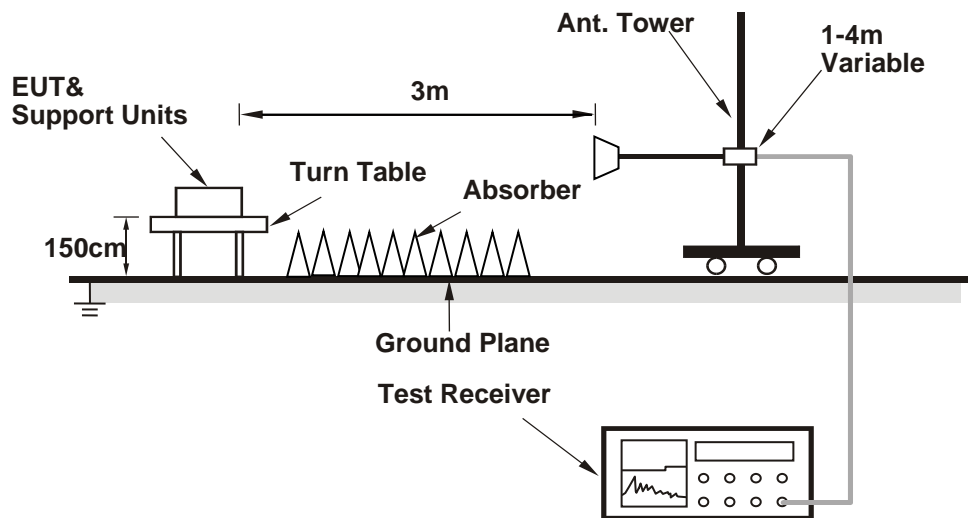

For the actual test configuration, please refer to the attached file (Test Setup Photo).

4.1.6 EUT Operating Conditions

- a. Placed the EUT on the testing table.
- b. Controlling software (qdart_conn.win.1.0_installer_00077.1) has been activated to set the EUT on specific status.

4.1.7 Test Results

Above 1GHz Data

Frequency Range	1GHz ~ 40GHz	Detector Function	Peak (PK) Average (AV)
-----------------	--------------	-------------------	---------------------------

Antenna Polarity & Test Distance : Horizontal at 3 m								
No	Frequency (MHz)	Emission Level (dBuV/m)	Limit (dBuV/m)	Margin (dB)	Antenna Height (m)	Table Angle (Degree)	Raw Value (dBuV)	Correction Factor (dB/m)
1	4874.00	58.1 PK	74.0	-15.9	2.23 H	183	56.6	1.5
2	4874.00	44.9 AV	54.0	-9.1	2.23 H	183	43.4	1.5
3	7311.00	43.0 PK	74.0	-31.0	1.38 H	285	35.8	7.2
4	7311.00	32.7 AV	54.0	-21.3	1.38 H	285	25.5	7.2
5	11650.00	47.5 PK	74.0	-26.5	1.66 H	112	35.6	11.9
6	11650.00	35.4 AV	54.0	-18.6	1.66 H	112	23.5	11.9
7	#17475.00	46.5 PK	68.2	-21.7	2.19 H	261	28.0	18.5
Antenna Polarity & Test Distance : Vertical at 3 m								
No	Frequency (MHz)	Emission Level (dBuV/m)	Limit (dBuV/m)	Margin (dB)	Antenna Height (m)	Table Angle (Degree)	Raw Value (dBuV)	Correction Factor (dB/m)
1	4874.00	55.4 PK	74.0	-18.6	1.42 V	166	53.9	1.5
2	4874.00	44.7 AV	54.0	-9.3	1.42 V	166	43.2	1.5
3	7311.00	44.3 PK	74.0	-29.7	1.21 V	360	37.1	7.2
4	7311.00	33.7 AV	54.0	-20.3	1.21 V	360	26.5	7.2
5	11650.00	45.7 PK	74.0	-28.3	1.10 V	327	33.8	11.9
6	11650.00	33.7 AV	54.0	-20.3	1.10 V	327	21.8	11.9
7	#17475.00	45.4 PK	68.2	-22.8	4.00 V	256	26.9	18.5

Remarks:

1. Emission Level(dBuV/m) = Raw Value(dBuV) + Correction Factor(dB/m)
2. Correction Factor(dB/m) = Antenna Factor(dB/m) + Cable Factor(dB) – Pre-Amplifier Factor(dB)
3. Margin value = Emission Level – Limit value
4. The other emission levels were very low against the limit.
5. " # ": The radiated frequency is out of the restricted band.

Below 1GHz Data:

Frequency Range	30 MHz ~ 1 GHz	Detector Function	Quasi-Peak (QP)
-----------------	----------------	-------------------	-----------------

Antenna Polarity & Test Distance : Horizontal at 3 m								
No	Frequency (MHz)	Emission Level (dBuV/m)	Limit (dBuV/m)	Margin (dB)	Antenna Height (m)	Table Angle (Degree)	Raw Value (dBuV)	Correction Factor (dB/m)
1	32.21	35.2 QP	40.0	-4.8	1.00 H	151	49.0	-13.8
2	57.61	26.2 QP	40.0	-13.8	3.00 H	262	39.4	-13.2
3	106.21	34.2 QP	43.5	-9.3	2.00 H	256	50.5	-16.3
4	138.40	18.9 QP	43.5	-24.6	2.00 H	248	32.2	-13.3
5	226.12	14.2 QP	46.0	-31.8	1.00 H	72	30.0	-15.8
6	274.30	17.2 QP	46.0	-28.8	1.00 H	148	30.2	-13.0

Remarks:

1. Emission Level(dBuV/m) = Raw Value(dBuV) + Correction Factor(dB/m)
2. Correction Factor(dB/m) = Antenna Factor(dB/m) + Cable Factor(dB) – Pre-Amplifier Factor(dB)
3. Margin value = Emission Level – Limit value
4. The other emission levels were very low against the limit of frequency range 30 MHz ~ 1 GHz.
5. The emission levels were very low against the limit of frequency range 9 kHz ~ 30 MHz: the amplitude of spurious emissions attenuated more than 20 dB below the permissible value to be report.

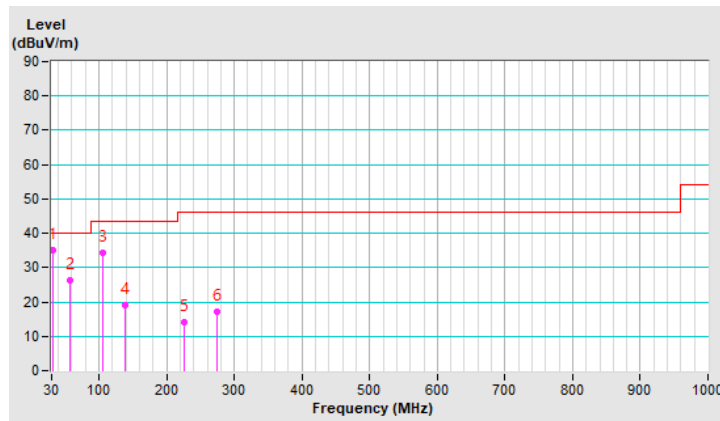

Frequency Range	30 MHz ~ 1 GHz	Detector Function	Quasi-Peak (QP)
-----------------	----------------	-------------------	-----------------

Antenna Polarity & Test Distance : Vertical at 3 m								
No	Frequency (MHz)	Emission Level (dBuV/m)	Limit (dBuV/m)	Margin (dB)	Antenna Height (m)	Table Angle (Degree)	Raw Value (dBuV)	Correction Factor (dB/m)
1	39.52	33.4 QP	40.0	-6.6	1.00 V	152	46.7	-13.3
2	65.32	34.2 QP	40.0	-5.8	1.00 V	351	48.5	-14.3
3	105.61	31.6 QP	43.5	-11.9	2.00 V	172	48.0	-16.4
4	149.20	16.2 QP	43.5	-27.3	1.00 V	206	28.9	-12.7
5	294.30	16.2 QP	46.0	-29.8	3.00 V	0	28.6	-12.4
6	388.40	18.3 QP	46.0	-27.7	3.00 V	360	28.5	-10.2

Remarks:

1. Emission Level(dBuV/m) = Raw Value(dBuV) + Correction Factor(dB/m)
2. Correction Factor(dB/m) = Antenna Factor(dB/m) + Cable Factor(dB) – Pre-Amplifier Factor(dB)
3. Margin value = Emission Level – Limit value
4. The other emission levels were very low against the limit of frequency range 30 MHz ~ 1 GHz.
5. The emission levels were very low against the limit of frequency range 9 kHz ~ 30 MHz: the amplitude of spurious emissions attenuated more than 20 dB below the permissible value to be report.

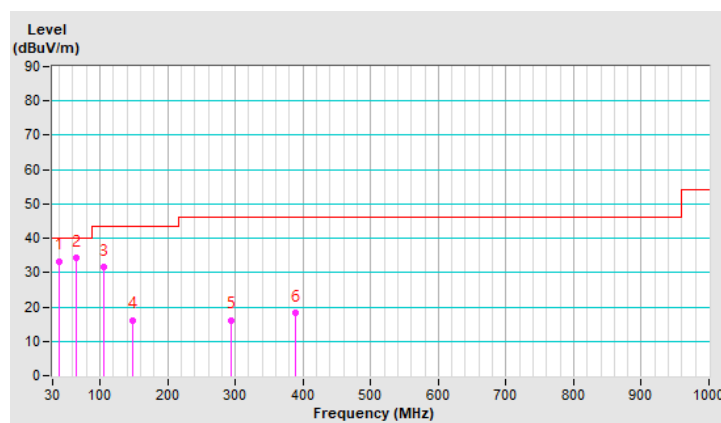

4.2 Conducted Emission Measurement

4.2.1 Limits of Conducted Emission Measurement

Frequency (MHz)	Conducted Limit (dBuV)	
	Quasi-peak	Average
0.15 - 0.5	66 - 56	56 - 46
0.50 - 5.0	56	46
5.0 - 30.0	60	50

Note: 1. The lower limit shall apply at the transition frequencies.

2. The limit decreases in line with the logarithm of the frequency in the range of 0.15 to 0.50MHz.

4.2.2 Test Instruments

Description & Manufacturer	Model No.	Serial No.	Calibrated Date	Calibrated Until
TEST RECEIVER R&S	ESCS 30	847124/029	2022/10/14	2023/10/13
LISN R&S	ESH3-Z5	848773/004	2022/10/18	2023/10/17
50 ohm terminal resistance NA	NA	EMC-01	2022/9/27	2023/9/26
RF Coaxial Cable JYEBO	5D-FB	COCCAB-001	2022/8/24	2023/8/23
Fixed attenuator STI	STI02-2200-10	005	2022/8/24	2023/8/23
Software BVADT	BVADT_Cond_V7.3.7.4	NA	NA	NA

Note:

1. The calibration interval of the above test instruments are 12 months and the calibrations are traceable to NML/ROC and NIST/USA.
2. The test was performed in Conduction 1.
- 3 Tested Date: 2022/11/3

4.2.3 Test Procedures

- The EUT was placed 0.4 meters from the conducting wall of the shielded room with EUT being connected to the power mains through a line impedance stabilization network (LISN). Other support units were connected to the power mains through another LISN. The two LISNs provide 50 ohm/ 50uH of coupling impedance for the measuring instrument.
- Both lines of the power mains connected to the EUT were checked for maximum conducted interference.
- The frequency range from 150kHz to 30MHz was searched. Emission levels under (Limit - 20dB) was not recorded.

Note: The resolution bandwidth and video bandwidth of test receiver is 9kHz for quasi-peak detection (QP) and average detection (AV) at frequency 0.15MHz-30MHz.

4.2.4 Deviation from Test Standard

No deviation.

4.2.5 Test Setup

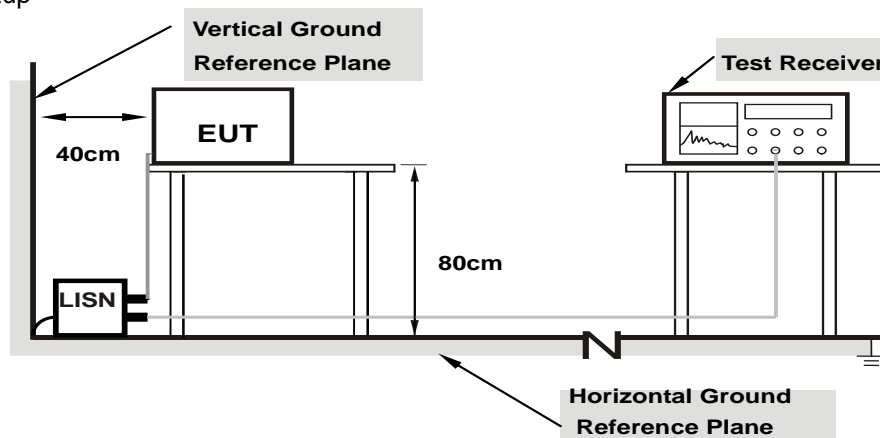

Note: 1.Support units were connected to second LISN.

For the actual test configuration, please refer to the attached file (Test Setup Photo).

4.2.6 EUT Operating Conditions

Same as 4.1.6.

4.2.7 Test Results

Frequency Range	150kHz ~ 30MHz	Detector Function & Resolution Bandwidth	Quasi-Peak (QP) / Average (AV), 9kHz
------------------------	----------------	---	--------------------------------------

Phase Of Power : Line (L)										
No	Frequency (MHz)	Correction Factor (dB)	Reading Value (dBuV)		Emission Level (dBuV)		Limit (dBuV)		Margin (dB)	
			Q.P.	AV.	Q.P.	AV.	Q.P.	AV.	Q.P.	AV.
1	0.15974	9.96	41.76	25.11	51.72	35.07	65.48	55.48	-13.76	-20.41
2	0.20154	9.96	40.15	26.13	50.11	36.09	63.55	53.55	-13.44	-17.46
3	0.41574	9.97	25.35	14.48	35.32	24.45	57.53	47.53	-22.21	-23.08
4	3.75619	10.14	29.34	20.58	39.48	30.72	56.00	46.00	-16.52	-15.28
5	10.63511	10.53	26.37	25.99	36.90	36.52	60.00	50.00	-23.10	-13.48
6	20.11980	11.10	41.85	35.43	52.95	46.53	60.00	50.00	-7.05	-3.47

Remarks:

1. Q.P. and AV. are abbreviations of quasi-peak and average individually.
2. The emission levels of other frequencies were very low against the limit.
3. Margin value = Emission level – Limit value
4. Correction factor = Insertion loss + Cable loss
5. Emission Level = Correction Factor + Reading Value

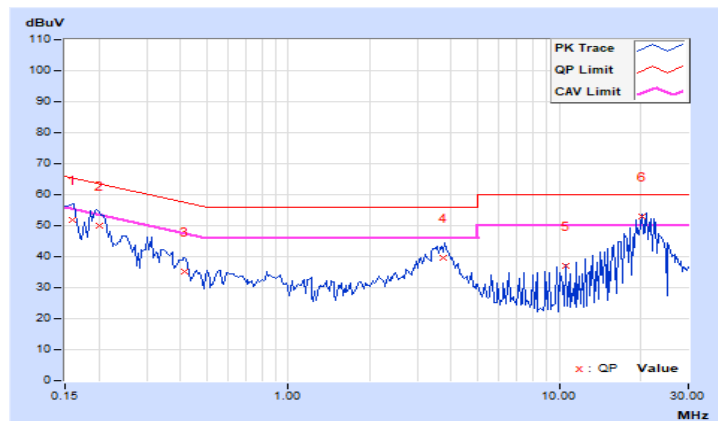

Frequency Range	150kHz ~ 30MHz	Detector Function & Resolution Bandwidth	Quasi-Peak (QP) / Average (AV), 9kHz
------------------------	----------------	---	--------------------------------------

Phase Of Power : Neutral (N)										
No	Frequency (MHz)	Correction Factor (dB)	Reading Value (dBuV)		Emission Level (dBuV)		Limit (dBuV)		Margin (dB)	
			Q.P.	AV.	Q.P.	AV.	Q.P.	AV.	Q.P.	AV.
1	0.15507	9.93	37.04	19.35	46.97	29.28	65.72	55.72	-18.75	-26.44
2	0.23971	9.94	25.76	6.93	35.70	16.87	62.11	52.11	-26.41	-35.24
3	0.58054	9.95	16.67	12.44	26.62	22.39	56.00	46.00	-29.38	-23.61
4	3.65437	10.09	27.34	19.67	37.43	29.76	56.00	46.00	-18.57	-16.24
5	20.09974	10.83	41.34	35.76	52.17	46.59	60.00	50.00	-7.83	-3.41
6	21.58984	10.84	40.95	36.02	51.79	46.86	60.00	50.00	-8.21	-3.14

Remarks:

1. Q.P. and AV. are abbreviations of quasi-peak and average individually.
2. The emission levels of other frequencies were very low against the limit.
3. Margin value = Emission level – Limit value
4. Correction factor = Insertion loss + Cable loss
5. Emission Level = Correction Factor + Reading Value

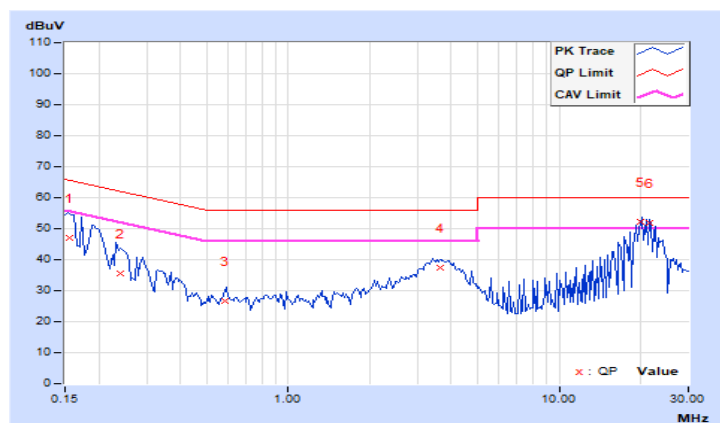

4.3 Conducted Out of Band Emission Measurement

4.3.1 Limits of Conducted Out of Band Emission Measurement

Below 20dB of the highest emission level of operating band (in 100kHz Resolution Bandwidth).

4.3.2 Test Setup

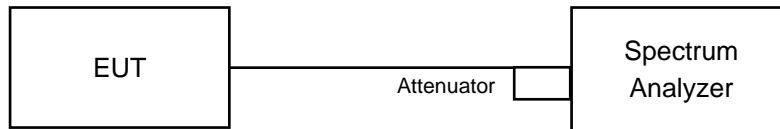

4.3.3 Test Instruments

Refer to section 4.1.2 to get information of above instrument.

4.3.4 Test Procedures

MEASUREMENT PROCEDURE REF

1. Set the RBW = 100 kHz.
2. Set the VBW \geq 300 kHz.
3. Detector = peak.
4. Sweep time = auto couple.
5. Trace mode = max hold.
6. Allow trace to fully stabilize.
7. Use the peak marker function to determine the maximum power level in any 100 kHz band segment within the fundamental EBW.

MEASUREMENT PROCEDURE OOBE

1. Set RBW = 100 kHz.
2. Set VBW \geq 300 kHz.
3. Detector = peak.
4. Sweep = auto couple.
5. Trace Mode = max hold.
6. Allow trace to fully stabilize.
7. Use the peak marker function to determine the maximum amplitude level.

4.3.5 Deviation from Test Standard

No deviation.

4.3.6 EUT Operating Conditions

The software provided by client to enable the EUT under transmission condition continuously at specific channel frequencies individually.

4.3.7 Test Results

The spectrum plots are attached on the following pages. D1 line indicates the highest level, and D2 line indicates the 20dB offset below D1. It shows compliance with the requirement.

2.4GHz_802.11ax (HE20) CH6 + 5GHz_802.11ax (HE20) CH165

Chain 0

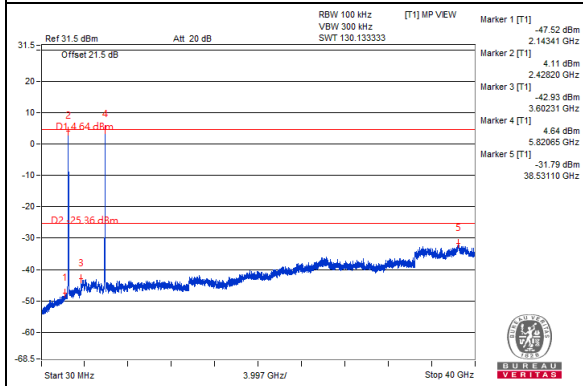

Chain 1

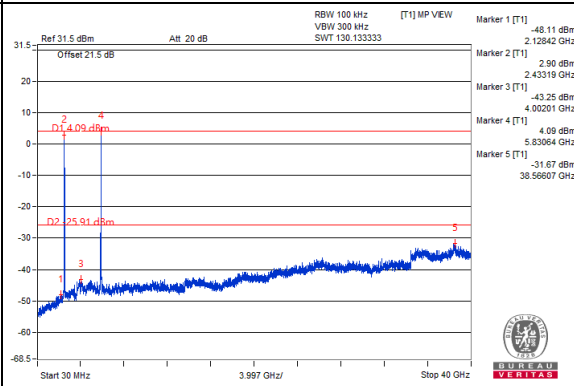

5 Pictures of Test Arrangements

Please refer to the attached file (Test Setup Photo).

Appendix – Information of the Testing Laboratories

We, Bureau Veritas Consumer Products Services (H.K.) Ltd., Taoyuan Branch, were founded in 1988 to provide our best service in EMC, Radio, Telecom and Safety consultation. Our laboratories are FCC recognized accredited test firms and accredited according to ISO/IEC 17025.

If you have any comments, please feel free to contact us at the following:

Lin Kou EMC/RF Lab

Tel: 886-2-26052180

Fax: 886-2-26051924

Hsin Chu EMC/RF/Telecom Lab

Tel: 886-3-6668565

Fax: 886-3-6668323

Hwa Ya EMC/RF/Safety Lab

Tel: 886-3-3183232

Fax: 886-3-3270892

Email: service.adt@tw.bureauveritas.com

Web Site: www.bureauveritas-adt.com

The address and road map of all our labs can be found in our web site also.

--- END ---