



SPORTON International Inc.

No. 52, Hwa Ya 1st Rd., Kwei-Shan Hsiang, TaoYuan Hsien, Taiwan, R.O.C.
Ph: 886-3-327-3456 / FAX: 886-3-327-0973 / www.sporton.com.tw

FCC RADIO TEST REPORT

Applicant's company	Z-Com, Inc.
Applicant Address	7F-2, No. 9. Prosperity RD.I Science-Based Industrial, Park Hsinchu, 300 Taiwan
FCC ID	M4Y-AG623C
Manufacturer's company	Z-Com, Inc.
Manufacturer Address	7F-2, No. 9. Prosperity RD.I Science-Based Industrial, Park Hsinchu, 300 Taiwan

Product Name	IEEE 802.11 a/b/g Wireless Network Mini PCI
Brand Name	ZCOM
Model Name	AG-623C
Test Rule Part(s)	47 CFR FCC Part 15 Subpart E § 15.407
Test Freq. Range	5150 ~ 5250MHz
Received Date	Sep. 26, 2006
Final Test Date	Sep. 28, 2006
Submission Type	Original Equipment

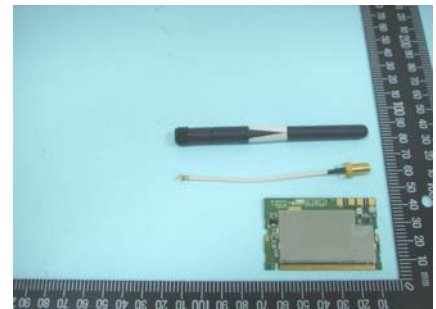

Statement

Test result included is only for the 802.11a (5150 ~ 5250MHz) of the product.

The test result in this report refers exclusively to the presented test model / sample.

Without written approval of SPORTON International Inc., the test report shall not be reproduced except in full.

The measurements and test results shown in this test report were made in accordance with the procedures and found in compliance with the limit given in **ANSI C63.4-2003** and **47 CFR FCC Part 15 Subpart E**.

The test equipment used to perform the test is calibrated and traceable to NML/ROC.

Table of Contents

1. CERTIFICATE OF COMPLIANCE	1
2. SUMMARY OF THE TEST RESULT	2
3. GENERAL INFORMATION	3
3.1. Product Details.....	3
3.2. Accessories.....	3
3.3. Table for Filed Antenna.....	3
3.4. Table for Carrier Frequencies	3
3.5. Table for Test Modes.....	4
3.6. Table for Testing Locations.....	4
3.7. Table for Supporting Units	5
3.8. Table for Parameters of Test Software Setting	5
3.9. Test Configurations	6
4. TEST RESULT	8
4.1. AC Power Line Conducted Emissions Measurement.....	8
4.2. 99% Occupied Bandwidth Measurement	12
4.3. Maximum Conducted Output Power Measurement.....	16
4.4. Power Spectral Density Measurement	20
4.5. Peak Excursion Measurement.....	24
4.6. Radiated Emissions Measurement	28
4.7. Band Edge Emissions Measurement	40
4.8. Frequency Stability Measurement	44
4.9. Antenna Requirements	46
5. LIST OF MEASURING EQUIPMENTS	47
6. TEST LOCATION.....	49
APPENDIX A. PHOTOGRAPHS OF EUT.....	A1 ~ A6
APPENDIX B. TEST PHOTOS.....	B1 ~ B8
APPENDIX C. MAXIMUM PERMISSIBLE EXPOSURE.....	C1 ~ C3



History of This Test Report

Original Issue Date: Sep. 29, 2006

Report No.: FR692606-AA

No additional attachment.

Additional attachment were issued as following record:

Attachment No.	Issue Date	Description



1. CERTIFICATE OF COMPLIANCE

Product Name : IEEE 802.11 a/b/g Wireless Network Mini PCI
Brand Name : ZCOM
Model Name : AG-623C
Applicant : Z-Com, Inc.
Test Rule Part(s) : 47 CFR FCC Part 15 Subpart E § 15.407

Sporton International as requested by the applicant to evaluate the EMC performance of the product sample received on Sep. 26, 2006 would like to declare that the tested sample has been evaluated and found to be in compliance with the tested rule parts. The data recorded as well as the test configuration specified is true and accurate for showing the sample's EMC nature.

 2.10.2006

Prepared By:
Mandy Liang / Specialist

 2.10.06

Tested By:
Steven Lu / Engineer

 2.10.06

Reviewed By:
Wayne Hsu

2. SUMMARY OF THE TEST RESULT

Applied Standard: 47 CFR FCC Part 15 Subpart E				
Part	Rule Section	Description of Test	Result	Under Limit
4.1	15.207	AC Power Line Conducted Emissions	Complies	9.18 dB
4.2	15.407(a)	26dB Spectrum Bandwidth	Complies	-
4.3	15.407(a)	Maximum Conducted Output Power	Complies	1.50 dB
4.4	15.407(a)	Power Spectral Density	Complies	5.12 dB
4.5	15.407(a)	Peak Excursion	Complies	7.22 dB
4.6	15.407(b)	Radiated Emissions	Complies	1.84 dB
4.7	15.407(b)	Band Edge Emissions	Complies	2.47 dB
4.8	15.407(g)	Frequency Stability	Complies	-
4.9	15.203	Antenna Requirements	Complies	-

Test Items	Uncertainty	Remark
AC Power Line Conducted Emissions	±2.26dB	Confidence levels of 95%
Maximum Conducted Output Power	±0.506dB	Confidence levels of 95%
Power Spectral Density	±0.506dB	Confidence levels of 95%
Peak Excursion	±0.506dB	Confidence levels of 95%
26dB Spectrum Bandwidth / Frequency Stability	±1.64×10 ⁻⁶	Confidence levels of 95%
Radiated Emissions (9kHz~30MHz)	±0.754dB	Confidence levels of 95%
Radiated Emissions (30MHz~1000MHz)	±1.89dB	Confidence levels of 95%
Radiated / Band Edge Emissions (1GHz~18GHz)	±1.89dB	Confidence levels of 95%
Radiated Emissions (18GHz~40GHz)	±1.86dB	Confidence levels of 95%
Temperature	±0.7°C	Confidence levels of 95%
Humidity	±3.2%	Confidence levels of 95%
DC / AC Power Source	±0.04%	Confidence levels of 95%

3. GENERAL INFORMATION

3.1. Product Details

Items	Description
Power Type	From Host system (Notebook)
Modulation	OFDM for IEEE 802.11a
Data Modulation	OFDM (BPSK / QPSK / 16QAM / 64QAM)
Data Rate (Mbps)	OFDM (6/9/12/18/24/36/48/54)
Frequency Range	5150 ~ 5250MHz
Channel Number	Band 1: 4
Channel Band Width (99%)	11a: 17.60 MHz
Conducted Output Power	Band 1: 15.50 dBm
Carrier Frequencies	Please refer to section 3.4
Antenna	Please refer to section 3.3

3.2. Accessories

N/A

3.3. Table for Filed Antenna

For 5GHz Band

Ant.	Brand	Model Name	Antenna Type	Connector	Gain (dBi)
1	Wha Yu	C356-510139-A	Dipole Antenna	Reversed-SMA	2.6

3.4. Table for Carrier Frequencies

Frequency Allocation for 802.11a

Frequency Band	Channel No.	Frequency
5150~5250 MHz	36	5180 MHz
	40	5200 MHz
	44	5220 MHz
	48	5240 MHz

3.5. Table for Test Modes

Preliminary tests were performed in different data rate to find the worst radiated emission. The data rate shown in the table below is the worst-case rate with respect to the specific test item. Investigation has been done on all the possible configurations for searching the worst cases. The following table is a list of the test modes shown in this test report.

Test Items	Mode	Data Rate	Channel	Antenna
AC Power Conducted Emission	Normal Link	54Mbps	48	1
26dB Spectrum Bandwidth 99% Occupied Bandwidth Measurement Max. Conducted Output Power Power Spectral Density Peak Excursion	Band 1/BPSK	6Mbps	36/40/48	NA
Radiated Emission Below 1GHz	Band 1/BPSK	6 Mbps	48	1
Radiated Emission Above 1GHz Band Edge Emission	Band 1/BPSK	6Mbps	36/40/48	1
Band Edge Emission	Band 1/BPSK	6Mbps	36	1
Frequency Stability	Un-modulation	-	36/48	NA

3.6. Table for Testing Locations

Test Site No.	Site Category	Location	FCC Reg. No.	IC File No.	VCCI Reg. No
03CH03-HY	SAC	Hwa Ya	101377	IC 4088	-
CO04-HY	Conduction	Hwa Ya	101377	IC 4088	-
TH01-HY	OVEN Room	Hwa Ya	-	-	-

Open Area Test Site (OATS); Semi Anechoic Chamber (SAC); Fully Anechoic Chamber (FAC).

Please refer section 6 for Test Site Address.

3.7. Table for Supporting Units

Support Unit	Brand	Model	FCC ID
Notebook	DELL	D505	E2K24GBRL
Printer	EPSON	LQ-300	DoC
Modem	ACEEX	DM1414	IFAXDM1414

3.8. Table for Parameters of Test Software Setting

During testing, Channel & Power Controlling Software provided by the customer was used to control the operating channel as well as the output power level. The RF output power selection is for the setting of RF output power expected by the customer and is going to be fixed on the firmware of the final end product.

Power Parameters of IEEE 802.11a

Test Software Version	ART		
	5180 MHz	5200 MHz	5240 MHz
IEEE 802.11a	12	12	12

An executive program, EMITEST.EXE under WIN XP, which generates a complete line of continuously repeating " H " pattern was used as the test software.

The program was executed as follows :

- a. Turn on the power of all equipment.
- b. The NB sends " H " messages to the panel, and the panel displays " H " patterns on the screen.
- c. The NB sends " H " messages to the printer, then the printer prints them on the paper.
- d. The NB sends " H " messages to the modem.
- e. Repeat the steps from b to d.

At the same time, "ART" was executed the test program to control the EUT continuously transmit RF signal.

3.9. Test Configurations

3.9.1. Radiation Emissions Test Configuration

Test Configurations: 9kHz~1GHz

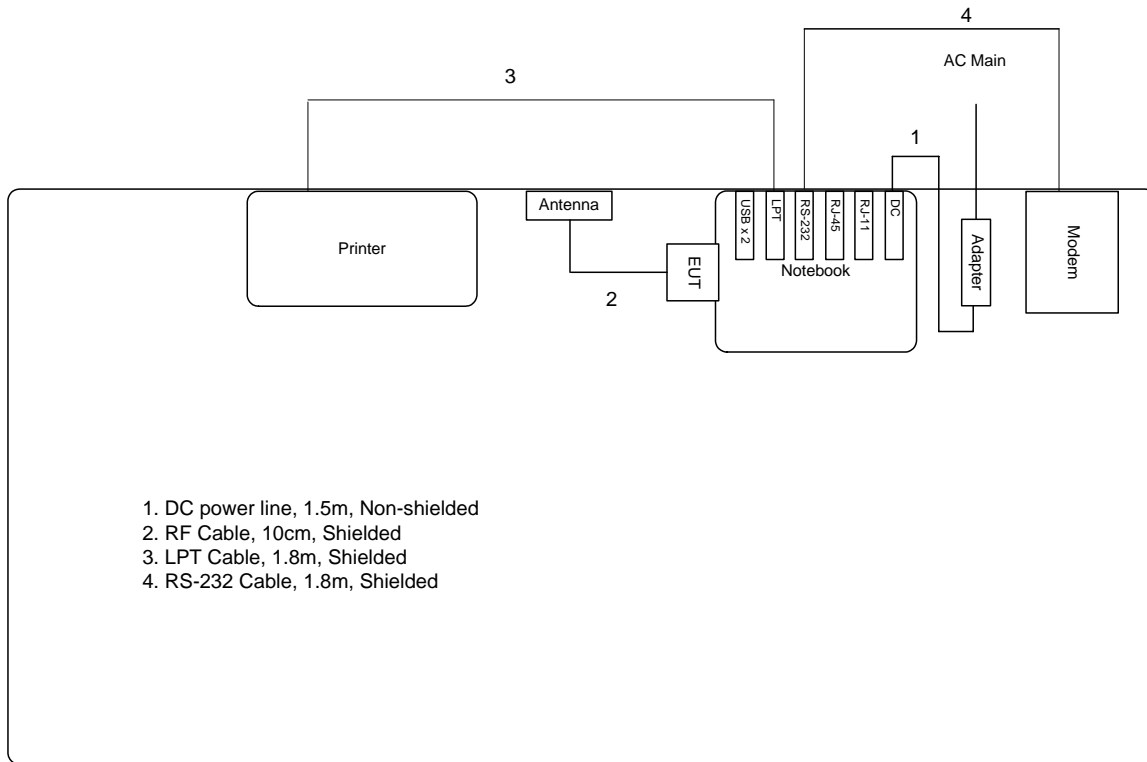

Test Configurations: Above 1GHz

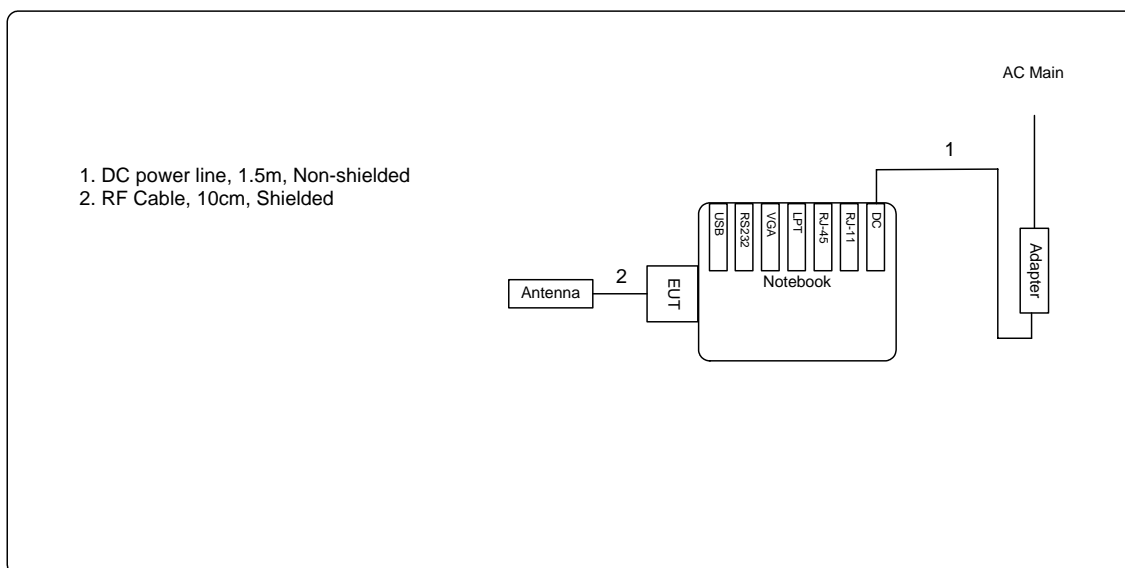

3.9.2. AC Power Line Conduction Emissions Test Configuration

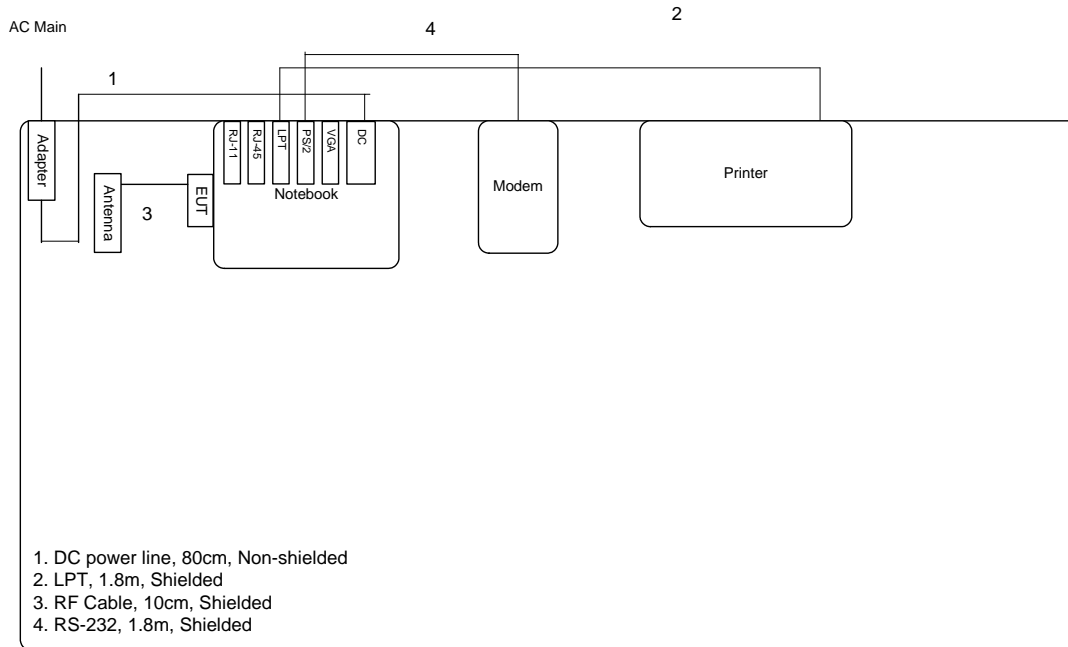

4. TEST RESULT

4.1. AC Power Line Conducted Emissions Measurement

4.1.1. Limit

For this product that is designed to connect to the AC power line, the radio frequency voltage that is conducted back onto the AC power line on any frequency or frequencies within the band 150 kHz to 30 MHz shall not exceed below limits table.

Frequency (MHz)	QP Limit (dBuV)	AV Limit (dBuV)
0.15~0.5	66~56	56~46
0.5~5	56	46
5~30	60	50

4.1.2. Measuring Instruments and Setting

Please refer to section 5 of equipments list in this report. The following table is the setting of the receiver.

Receiver Parameters	Setting
Attenuation	10 dB
Start Frequency	0.15 MHz
Stop Frequency	30 MHz
IF Bandwidth	9 KHz

4.1.3. Test Procedures

1. Configure the EUT according to ANSI C63.4. The EUT or host of EUT has to be placed 0.4 meter far from the conducting wall of the shielding room and at least 80 centimeters from any other grounded conducting surface.
2. Connect EUT or host of EUT to the power mains through a line impedance stabilization network (LISN).
3. All the support units are connected to the other LISNs. The LISN should provide 50uH/50ohms coupling impedance.
4. The frequency range from 150 KHz to 30 MHz was searched.
5. Set the test-receiver system to Peak Detect Function and Specified Bandwidth with Maximum Hold Mode.
6. The measurement has to be done between each power line and ground at the power terminal.

4.1.4. Test Setup Layout

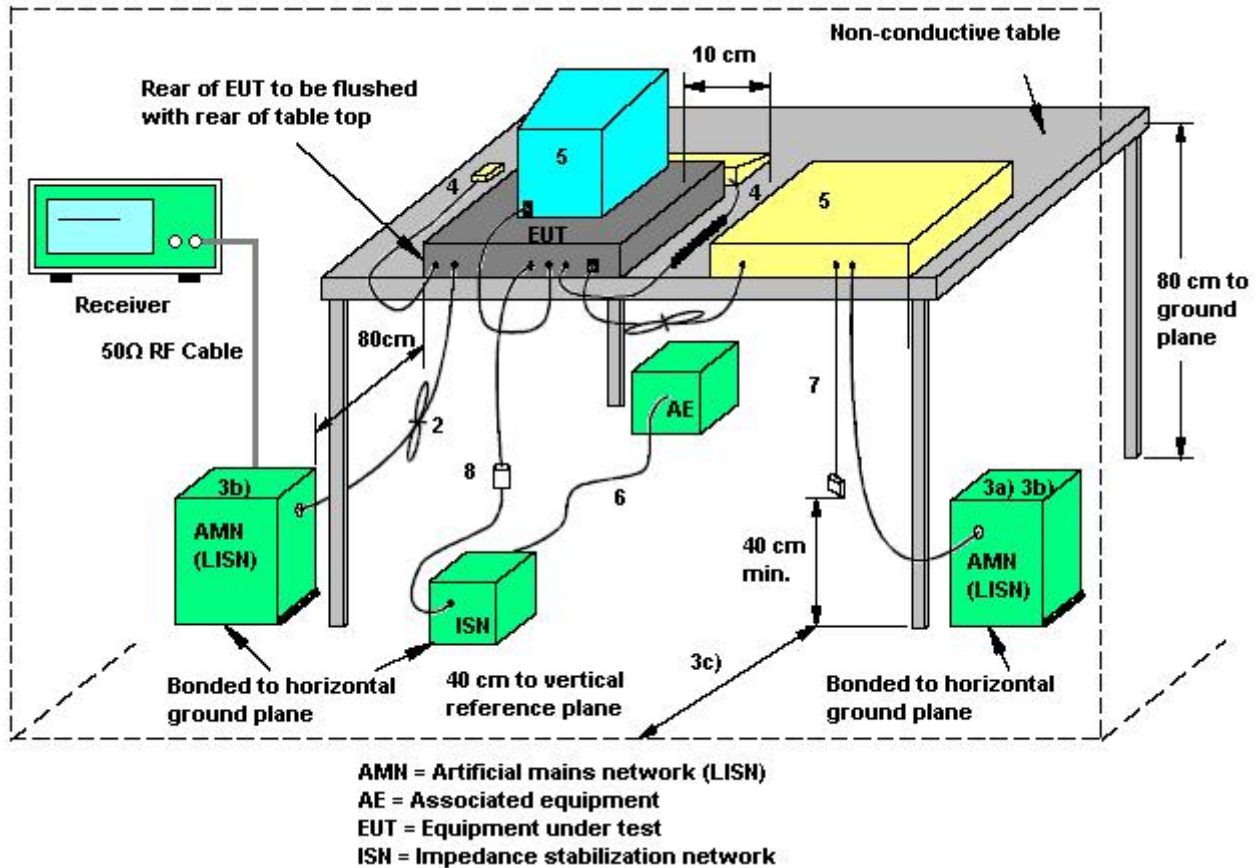

1. If cables, which hang closer than 40 cm to the horizontal metal groundplane, cannot be shortened to appropriate length, the excess shall be folded back and forth forming a bundle 30 cm to 40 cm long.
2. Excess mains cord shall be bundled in the centre or shortened to appropriate length.
3. EUT is connected to one artificial mains network (AMN). All AMNs and ISNs may alternatively be connected to a vertical reference plane or metal wall.
4. All other units of a system are powered from a second AMN. A multiple outlet strip can be used for multiple mains cords.
5. AMN and ISN are 80 cm from the EUT and at least 80 cm from other units and other metal planes.
6. Mains cords and signal cables shall be positioned for their entire lengths, as far as possible, at 40 cm from the vertical reference plane.
7. Cables of hand operated devices, such as keyboards, mice, etc. shall be placed as for normal usage.
8. Peripherals shall be placed at a distance of 10 cm from each other and from the controller, except for the monitor which, if this is an acceptable installation practice, shall be placed directly on the top of the controller.
9. I/O signal cable intended for external connection.
10. The end of the I/O signal cables which are not connected to an AE may be terminated, if required, using correct terminating impedance.
11. If used, the current probe shall be placed at 0,1 m from the ISN.

4.1.5. Test Deviation

There is no deviation with the original standard.

4.1.6. EUT Operation during Test

The EUT was placed on the test table and programmed in normal function.

4.1.7. Results of AC Power Line Conducted Emissions Measurement

Temperature	27.9°C	Humidity	54%
Test Engineer	Johnson Chang	Phase	Line
Configuration	Normal Link		

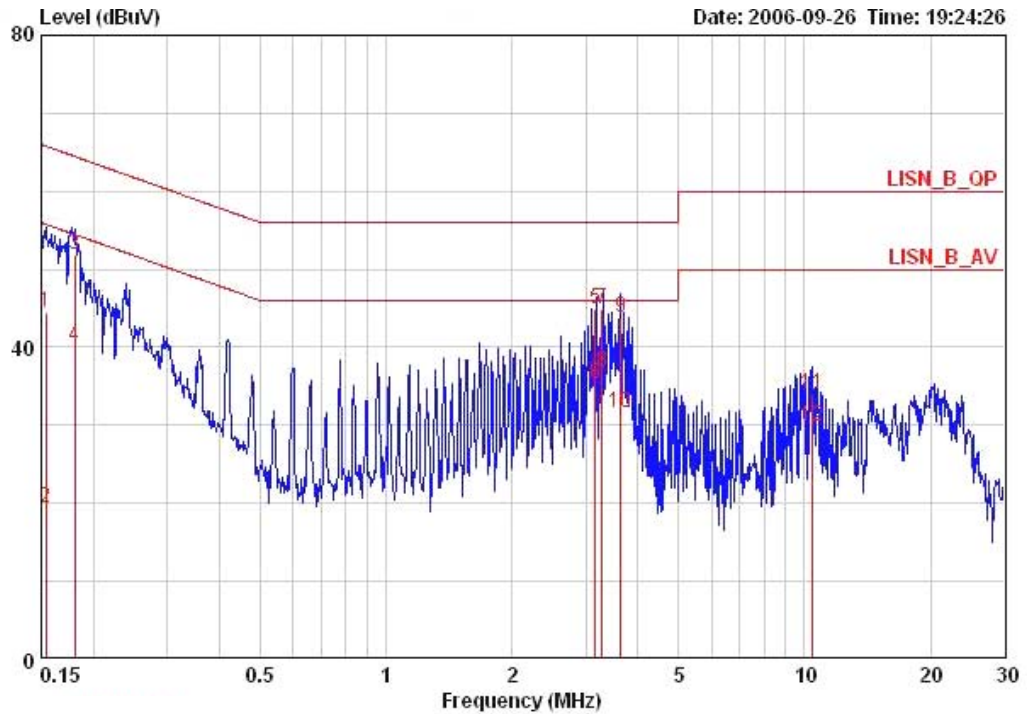

	Freq	Level	Over Limit	Limit Line	Read Level	LISN Factor	Cable Loss	Remark
	MHz	dBuV	dB	dBuV	dBuV	dB	dB	
1	0.15403	44.45	-21.33	65.78	42.21	2.04	0.20	QP
2	0.15403	19.41	-36.37	55.78	17.17	2.04	0.20	AVERAGE
3	0.18056	51.79	-12.67	64.46	49.94	1.65	0.20	QP
4	0.18056	40.20	-14.26	54.46	38.35	1.65	0.20	AVERAGE
5	3.160	44.84	-11.16	56.00	44.31	0.30	0.23	QP
6	3.160	35.30	-10.70	46.00	34.77	0.30	0.23	AVERAGE
7	3.278	44.88	-11.12	56.00	44.32	0.30	0.26	QP
8	3.278	36.82	-9.18	46.00	36.26	0.30	0.26	AVERAGE
9	3.637	43.92	-12.08	56.00	43.29	0.33	0.30	QP
10	3.637	31.61	-14.39	46.00	30.98	0.33	0.30	AVERAGE
11	10.483	34.09	-25.91	60.00	33.39	0.30	0.40	QP
12	10.483	29.79	-20.21	50.00	29.09	0.30	0.40	AVERAGE

Temperature	27.9°C	Humidity	54%
Test Engineer	Johnson Chang	Phase	Neutral
Configuration	Normal Link		

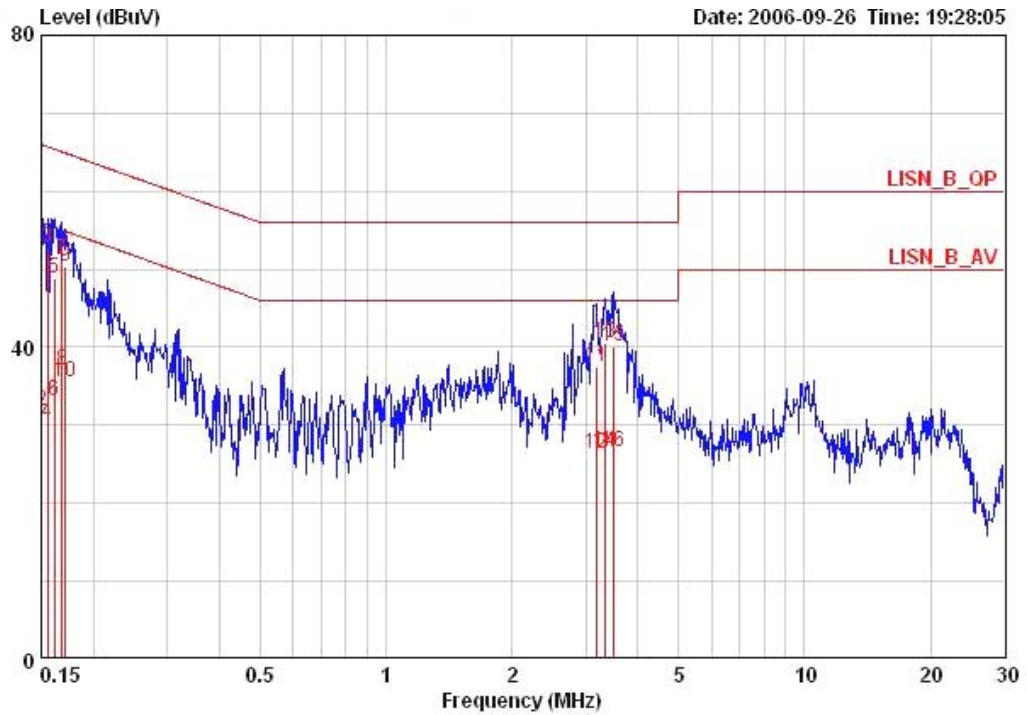

	Freq	Level	Over	Limit	Read	LISN	Cable	
	MHz	dBuV	Limit	Line	Level	Factor	Loss	Remark
			dB	dBuV	dBuV	dB	dB	
1	0.15000	51.25	-14.75	66.00	49.15	1.90	0.20	QP
2	0.15000	31.84	-24.16	56.00	29.74	1.90	0.20	AVERAGE
3	0.15567	52.78	-12.91	65.69	50.68	1.90	0.20	QP
4	0.15567	30.30	-25.39	55.69	28.20	1.90	0.20	AVERAGE
5	0.16155	48.80	-16.59	65.38	46.73	1.87	0.20	QP
6	0.16155	33.13	-22.26	55.38	31.06	1.87	0.20	AVERAGE
7	0.16854	51.30	-13.73	65.03	49.37	1.73	0.20	QP
8	0.16854	37.12	-17.91	55.03	35.19	1.73	0.20	AVERAGE
9	0.17125	50.27	-14.63	64.90	48.39	1.68	0.20	QP
10	0.17125	35.63	-19.27	54.90	33.75	1.68	0.20	AVERAGE
11	3.173	37.58	-18.42	56.00	37.04	0.30	0.24	QP
12	3.173	26.36	-19.64	46.00	25.82	0.30	0.24	AVERAGE
13	3.346	40.53	-15.47	56.00	39.96	0.30	0.27	QP
14	3.346	26.69	-19.31	46.00	26.12	0.30	0.27	AVERAGE
15	3.509	40.12	-15.88	56.00	39.52	0.30	0.30	QP
16	3.509	26.59	-19.41	46.00	25.99	0.30	0.30	AVERAGE

Note:

Level = Read Level + LISN Factor + Cable Loss.

4.2. 99% Occupied Bandwidth Measurement

4.2.1. Limit

No restriction limits. But resolution bandwidth within band edge measurement is 1% of the 99% occupied bandwidth.

4.2.2. Measuring Instruments and Setting

Please refer to section 5 of equipments list in this report. The following table is the setting of the Spectrum Analyzer.

Spectrum Parameters	Setting
Attenuation	Auto
Span Frequency	> 26dB Bandwidth
RB	300 kHz
VB	1000 kHz
Detector	Peak
Trace	Max Hold
Sweep Time	Auto

4.2.3. Test Procedures

1. The transmitter output (antenna port) was connected to the spectrum analyzer in peak hold mode.
2. The resolution bandwidth of 300 kHz and the video bandwidth of 1000 kHz were used.
3. Measured the spectrum width with power higher than 26dB below carrier.

4.2.4. Test Setup Layout

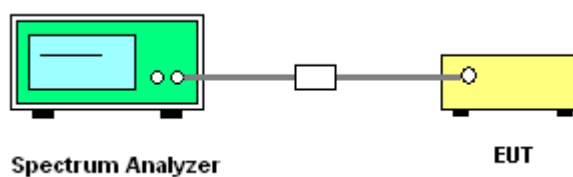

4.2.5. Test Deviation

There is no deviation with the original standard.

4.2.6. EUT Operation during Test

The EUT was programmed to be in continuously transmitting mode.

4.2.7. Test Result of 99% Occupied Bandwidth

Temperature	24°C	Humidity	56%
Test Engineer	Leo Hung	Configurations	802.11a

Configuration IEEE 802.11a

Channel	Frequency	26dB Bandwidth (MHz)	99% Occupied Bandwidth (MHz)
36	5180 MHz	24.16	17.28
40	5200 MHz	25.92	17.60
48	5240 MHz	25.92	17.28

26 dB Bandwidth Plot on Configuration IEEE 802.11a / 5180 MHz

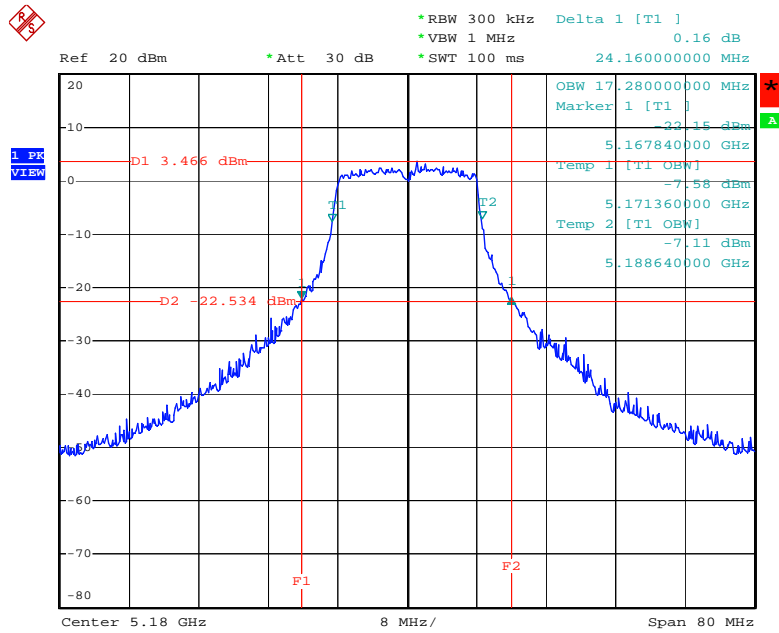

Date: 27.SEP.2006 03:52:41

26 dB Bandwidth Plot on Configuration IEEE 802.11a / 5200 MHz

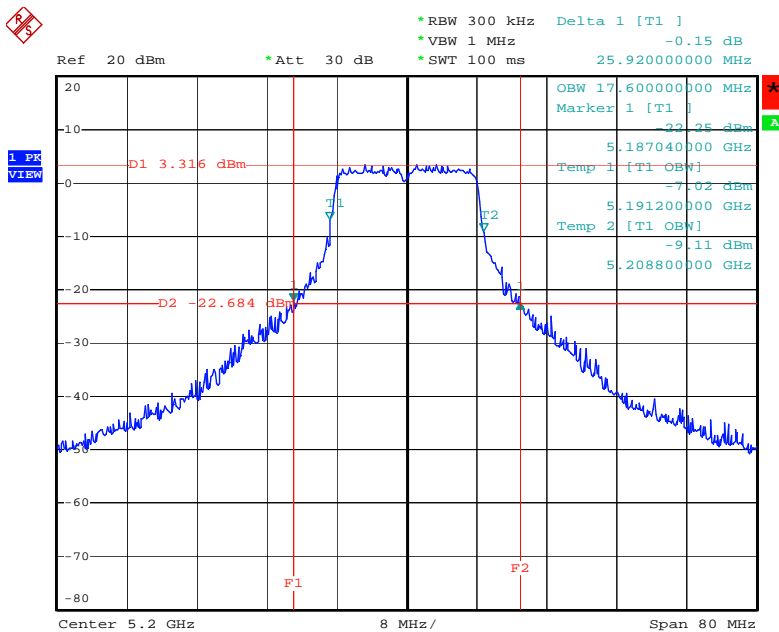

Date: 27.SEP.2006 03:53:58

26 dB Bandwidth Plot on Configuration IEEE 802.11a / 5240MHz

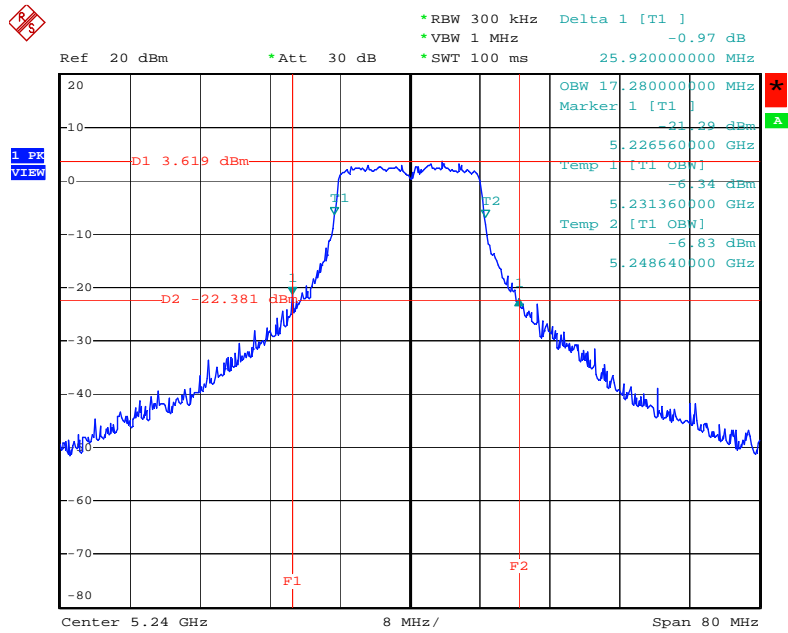

Date: 27.SEP.2006 03:55:20

4.3. Maximum Conducted Output Power Measurement

4.3.1. Limit

For the band 5.15~5.25 GHz, the maximum conducted output power over the frequency band of operation shall not exceed the lesser of 50 mW (17dBm) or $4 \text{ dBm} + 10\log B$, where B is the 26 dB emissions bandwidth in MHz. If transmitting antennas of directional gain greater than 6 dBi are used, the peak output power and power density from the intentional radiator shall be reduced by the amount in dB that the directional gain of the antenna exceeds 6 dBi.

4.3.2. Measuring Instruments and Setting

Please refer to section 5 of equipments list in this report. The following table is the setting of the spectrum.

Spectrum Parameter	Setting
Attenuation	Auto
Span Frequency	Encompass the entire emissions bandwidth (EBW) of the signal
RB	1000 kHz
VB	300 kHz
Detector	Sample
Trace	Max Hold
Sweep Time	60s

4.3.3. Test Procedures

1. The transmitter output (antenna port) was connected to the spectrum analyzer.
2. Test was performed in accordance with method #3 of FCC Public Notice DA-02-2138.

4.3.4. Test Setup Layout

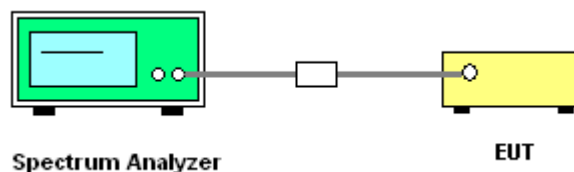

4.3.5. Test Deviation

There is no deviation with the original standard.

4.3.6. EUT Operation during Test

The EUT was programmed to be in continuously transmitting mode.

4.3.7. Test Result of Maximum Conducted Output Power

Temperature	24°C	Humidity	56%
Test Engineer	Leo Hung	Configurations	802.11a

Configuration IEEE 802.11a

Channel	Frequency	Conducted Power (dBm)	Max. Limit (dBm)	Result
36	5180 MHz	15.14	17.00	Complies
40	5200 MHz	15.22	17.00	Complies
48	5240 MHz	15.50	17.00	Complies

Channel Output Power Plot on Configuration IEEE 802.11a / 5180 MHz

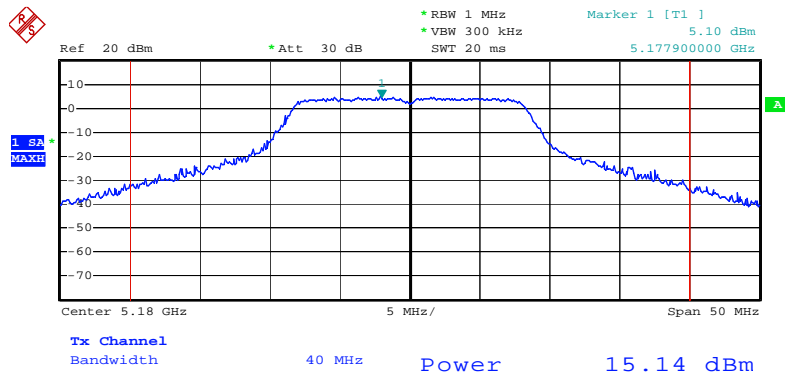

Date: 27.SEP.2006 03:53:23

Channel Output Power Plot on Configuration IEEE 802.11a / 5200 MHz

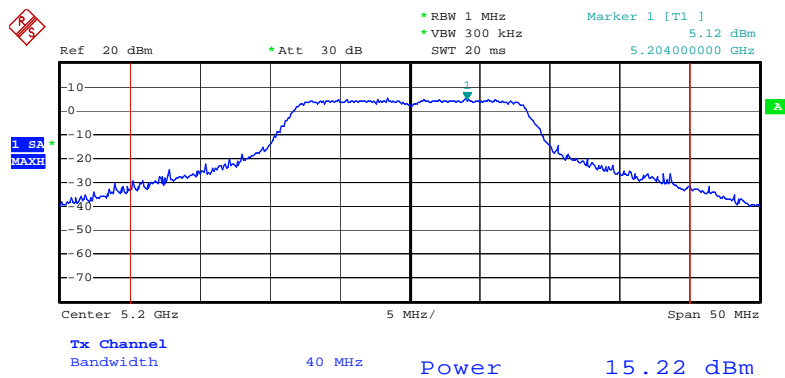

Date: 27.SEP.2006 03:54:39

4.4. Power Spectral Density Measurement

4.4.1. Limit

The power spectral density is defined as the highest level of power in dBm per MHz generated by the transmitter within the power envelope. The following table is power spectral density limits and decrease power density limit rule refer to section 4.3.1.

Frequency Range	Power Spectral Density limit (dBm/MHz)
5.15~5.25 GHz	4

4.4.2. Measuring Instruments and Setting

Please refer to section 5 of equipments list in this report. The following table is the setting of Spectrum Analyzer.

Spectrum Parameter	Setting
Attenuation	Auto
Span Frequency	Encompass the entire emissions bandwidth (EBW) of the signal
RB	1000 kHz
VB	3000 kHz
Detector	Peak
Trace	Max Hold
Sweep Time	Auto

4.4.3. Test Procedures

1. The transmitter output (antenna port) was connected to the spectrum analyzer.
2. Set RBW of spectrum analyzer to 1000kHz and VBW to 3000kHz. Set Detector to Peak, Trace to Max Hold. Mark the frequency with maximum peak power as the center of the display of the spectrum.

4.4.4. Test Setup Layout

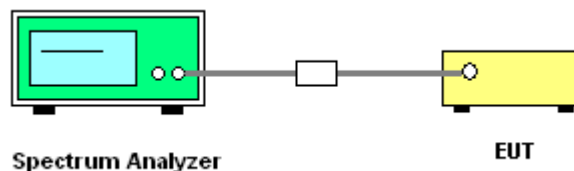

4.4.5. Test Deviation

There is no deviation with the original standard.

4.4.6. EUT Operation during Test

The EUT was programmed to be in continuously transmitting mode.

4.4.7. Test Result of Power Spectral Density

Temperature	24°C	Humidity	56%
Test Engineer	Leo Hung	Configurations	802.11a

Configuration IEEE 802.11a

Frequency	Power Density (dBm)	Max. Limit (dBm)	Result
5180 MHz	-2.05	4.00	Complies
5200 MHz	-1.12	4.00	Complies
5240 MHz	-1.74	4.00	Complies

Power Density Plot on Configuration IEEE 802.11a / 5180 MHz

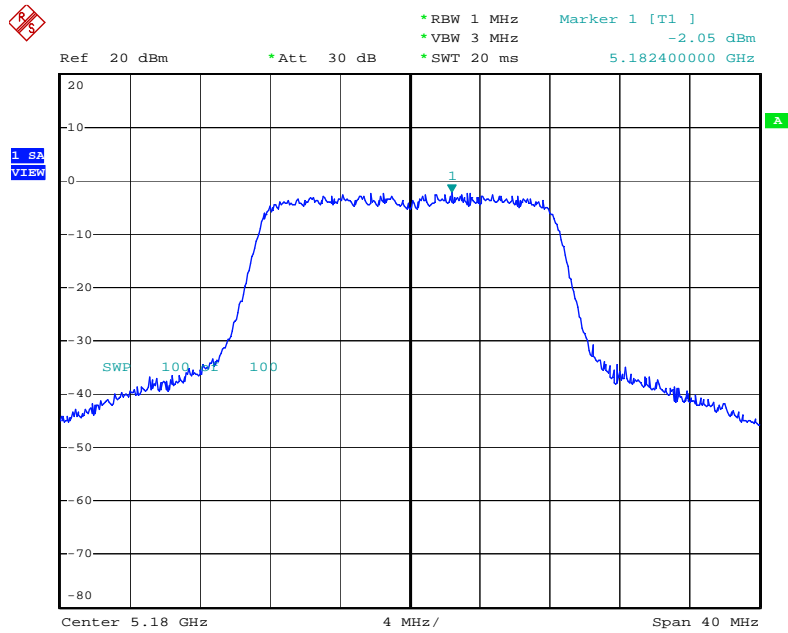

Date: 27.SEP.2006 04:31:03

Power Density Plot on Configuration IEEE 802.11a / 5200 MHz

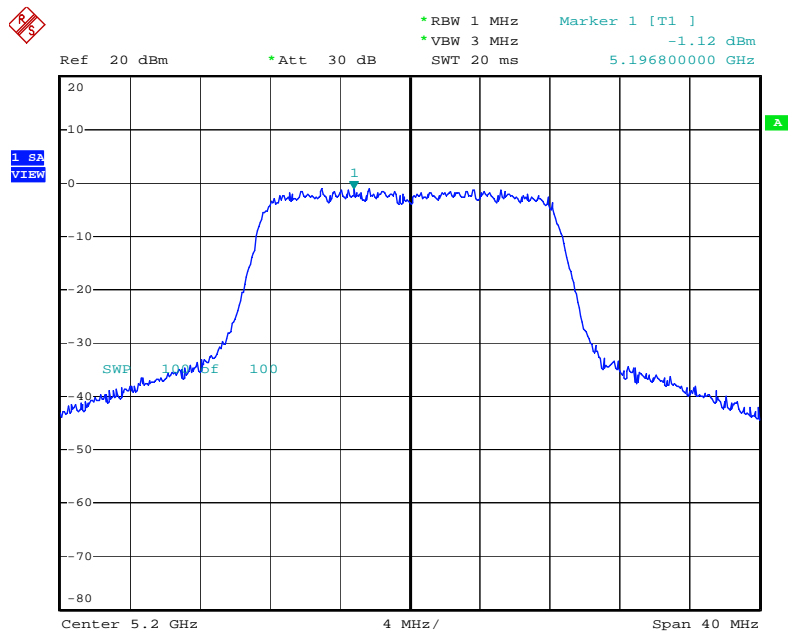

Date: 27.SEP.2006 03:54:05

Power Density Plot on Configuration IEEE 802.11a / 5240 MHz

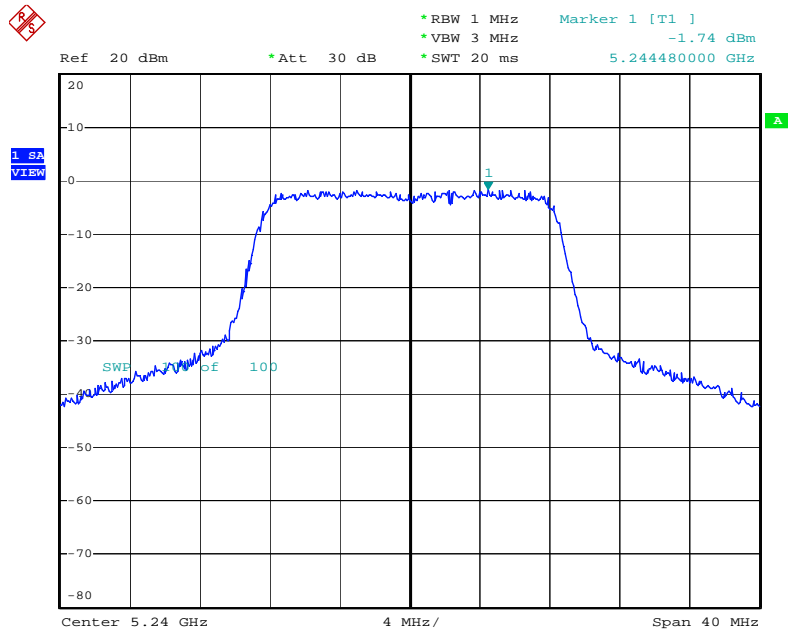

Date: 27.SEP.2006 04:31:30

4.5. Peak Excursion Measurement

4.5.1. Limit

The ratio of the peak excursion of the modulation envelope (measured using a peak hold function) to the maximum conducted output power (measured as specified above) shall not exceed 13 dB across any 1 MHz bandwidth or the emissions bandwidth whichever is less.

4.5.2. Measuring Instruments and Setting

Please refer to section 5 of equipments list in this report. The following table is the setting of Spectrum Analyzer.

Spectrum Parameter	Setting
Attenuation	Auto
Span Frequency	Encompass the entire emissions bandwidth (EBW) of the signal
RB	1000 kHz (Peak Trace) / 1000 kHz (Average Trace)
VB	3000 kHz (Peak Trace) / 300 kHz (Average Trace)
Detector	Peak (Peak Trace) / Sample (Average Trace)
Trace	Max Hold
Sweep Time	60s

4.5.3. Test Procedures

1. The transmitter output (antenna port) was connected to the spectrum analyzer.
2. Set the spectrum analyzer span to view the entire emissions bandwidth. The largest difference between the following two traces (Peak Trace and Average Trace) must be ≤ 13 dB for all frequencies across the emissions bandwidth. Submit a plot.
3. Peak Trace: Set RBW = 1 MHz, VBW ≥ 3 MHz with peak detector and max-hold settings.
4. Average Trace: Method #3—video averaging with max hold--and sum power across the band. Set span to encompass the entire emissions bandwidth (EBW) of the signal. Set sweep trigger to "free run". Set RBW = 1 MHz. Set VBW $\geq 1/T$ (IEEE 802.11a VBW = 300kHz $\geq 1/4 \mu s$). Use sample detector mode if bin width (i.e., span/number of points in spectrum) < 0.5 RBW. Otherwise use peak detector mode. Set max hold. Allow max hold to run for 60 seconds.

4.5.4. Test Setup Layout

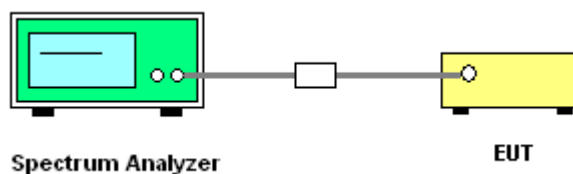

4.5.5. Test Deviation

There is no deviation with the original standard.

4.5.6. EUT Operation during Test

The EUT was programmed to be in continuously transmitting mode.

4.5.7. Test Result of Peak Excursion

Temperature	24°C	Humidity	56%
Test Engineer	Leo Hung	Configurations	802.11a

Configuration IEEE 802.11a

Frequency	Peak Excursion (dB)	Max. Limit (dB)	Result
5180 MHz	5.78	13	Complies
5200 MHz	5.38	13	Complies
5240 MHz	5.71	13	Complies

Peak Excursion Plot on Configuration IEEE 802.11 a / 5180 MHz

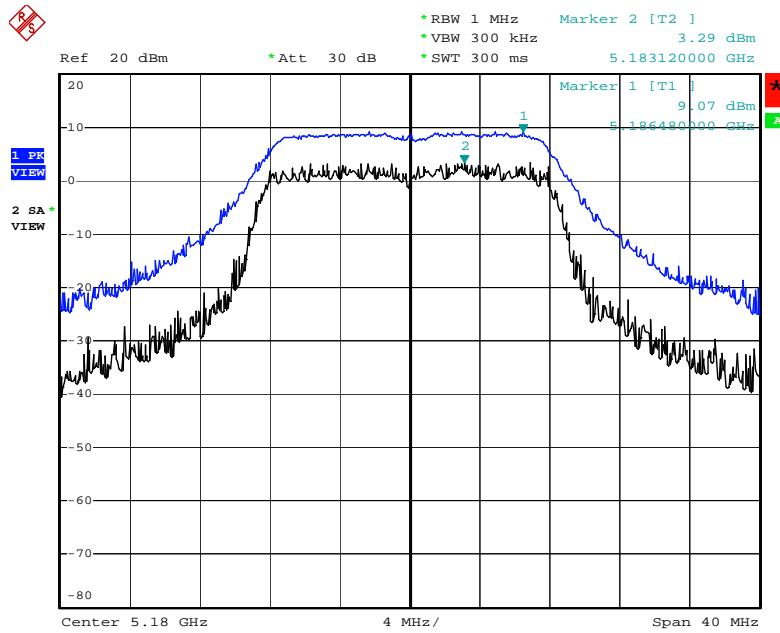

Date: 27.SEP.2006 03:53:35

Peak Excursion Plot on Configuration IEEE 802.11 a / 5200 MHz

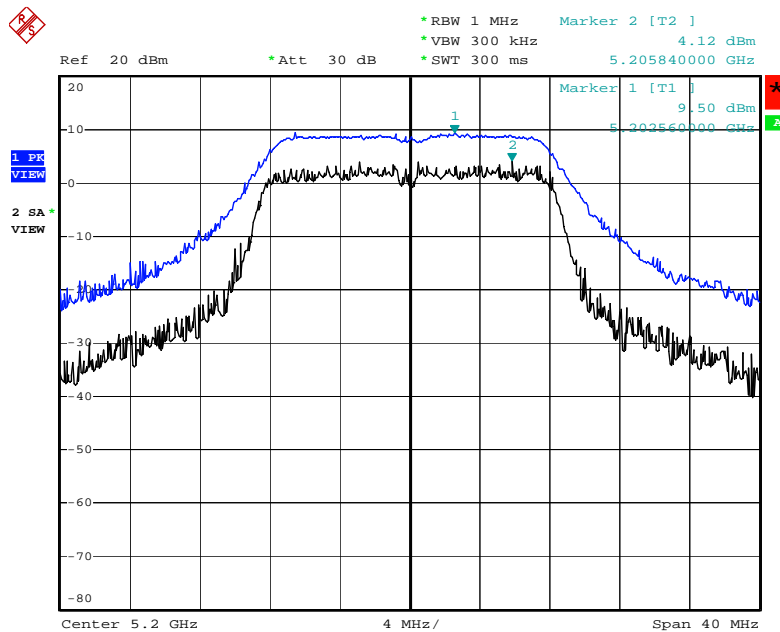

Date: 27.SEP.2006 03:54:51

Peak Excursion Plot on Configuration IEEE 802.11 a / 5240 MHz

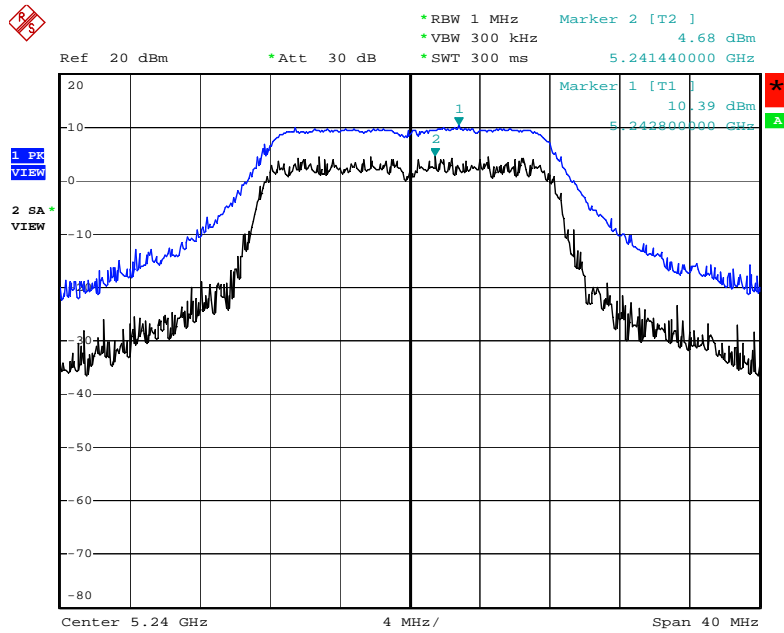

Date: 27.SEP.2006 03:56:14

4.6. Radiated Emissions Measurement

4.6.1. Limit

For transmitters operating in the 5.15-5.25 GHz band: all emissions outside of the 5.15-5.25 GHz band shall not exceed an EIRP of -27 dBm/MHz (68.3dBuV/m at 3m). In addition, In case the emission fall within the restricted band specified on 15.205(a), then the 15.209(a) limit in the table below has to be followed.

Frequencies (MHz)	Field Strength (micorvolts/meter)	Measurement Distance (meters)
0.009~0.490	2400/F(KHz)	300
0.490~1.705	24000/F(KHz)	30
1.705~30.0	30	30
30~88	100	3
88~216	150	3
216~960	200	3
Above 960	500	3

4.6.2. Measuring Instruments and Setting

Please refer to section 5 of equipments list in this report. The following table is the setting of spectrum analyzer and receiver.

Spectrum Parameter	Setting
Attenuation	Auto
Start Frequency	1000 MHz
Stop Frequency	40 GHz
RB / VB (Emission in restricted band)	1 MHz / 1MHz for Peak, 1 MHz / 10Hz for Average
RB / VB (Emission in non-restricted band)	1000KHz / 1000KHz for peak

Receiver Parameter	Setting
Attenuation	Auto
Start ~ Stop Frequency	9kHz~150kHz / RB 200Hz for QP
Start ~ Stop Frequency	150kHz~30MHz / RB 9kHz for QP
Start ~ Stop Frequency	30MHz~1000MHz / RB 120kHz for QP

4.6.3. Test Procedures

1. Configure the EUT according to ANSI C63.4. The EUT was placed on the top of the turntable 0.8 meter above ground. The phase center of the receiving antenna mounted on the top of a height-variable antenna tower was placed 3 meters far away from the turntable.
2. Power on the EUT and all the supporting units. The turntable was rotated by 360 degrees to determine the position of the highest radiation.
3. The height of the broadband receiving antenna was varied between one meter and four meters above ground to find the maximum emissions field strength of both horizontal and vertical polarization.
4. For each suspected emissions, the antenna tower was scan (from 1 M to 4 M) and then the turntable was rotated (from 0 degree to 360 degrees) to find the maximum reading.
5. Set the test-receiver system to Peak or CISPR quasi-peak Detect Function with specified bandwidth under Maximum Hold Mode.
6. For emissions above 1GHz, use 1MHz VBW and RBW for peak reading. Then 1MHz RBW and 10Hz VBW for average reading in spectrum analyzer.
7. When the radiated emissions limits are expressed in terms of the average value of the emissions, and pulsed operation is employed, the measurement field strength shall be determined by averaging over one complete pulse train, including blanking intervals, as long as the pulse train does not exceed 0.1 seconds. As an alternative (provided the transmitter operates for longer than 0.1 seconds) or in cases where the pulse train exceeds 0.1 seconds, the measured field strength shall be determined from the average absolute voltage during a 0.1 second interval during which the field strength is at its maximum value.
8. If the emissions level of the EUT in peak mode was 3 dB lower than the average limit specified, then testing will be stopped and peak values of EUT will be reported, otherwise, the emissions which do not have 3 dB margin will be repeated one by one using the quasi-peak method for below 1GHz.
9. For testing above 1GHz, the emissions level of the EUT in peak mode was lower than average limit (that means the emissions level in peak mode also complies with the limit in average mode), then testing will be stopped and peak values of EUT will be reported, otherwise, the emissions will be measured in average mode again and reported.
10. In case the emission is lower than 30MHz, loop antenna has to be used for measurement and the recorded data should be QP measured by receiver. High – Low scan is not required in this case.

4.6.4. Test Setup Layout

For radiated emissions below 30MHz

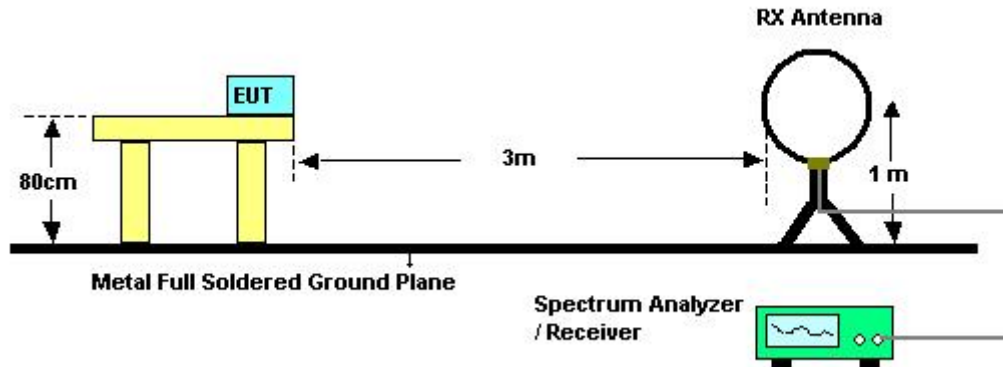

For radiated emissions above 30MHz

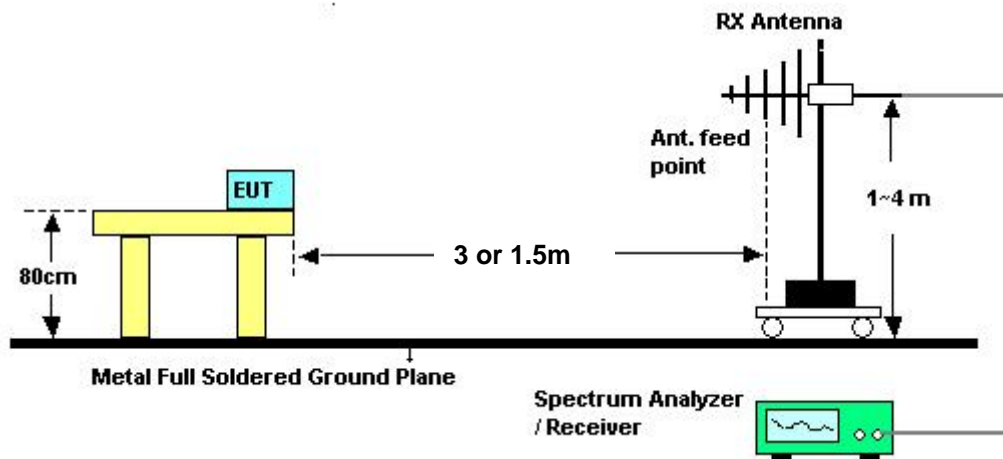

Above 5GHz shall be extrapolated to the specified distance using an extrapolation factor of 20 dB/decade from 3m to 1.5m.

Distance extrapolation factor = $20 \log (\text{specific distance [3m]} / \text{test distance [1.5m]})$ (dB);

Limit line = specific limits (dBuV) + distance extrapolation factor [6 dB].

4.6.5. Test Deviation

There is no deviation with the original standard.

4.6.6. EUT Operation during Test

The EUT was programmed to be in continuously transmitting mode.

4.6.7. Results of Radiated Emissions (9kHz~30MHz)

Temperature	23°C	Humidity	54%
Test Engineer	Beck Wu	Configurations	802.11a Ch 48

Freq. (MHz)	Level (dBuV)	Over Limit (dB)	Limit Line (dBuV)	Remark
-	-	-	-	See Note

Note:

The amplitude of spurious emissions that are attenuated by more than 20 dB below the permissible value has no need to be reported.

Distance extrapolation factor = $40 \log(\text{specific distance} / \text{test distance})$ (dB);

Limit line = specific limits (dBuV) + distance extrapolation factor.

4.6.8. Results of Radiated Emissions (30MHz~1GHz)

Temperature	23°C	Humidity	54%
Test Engineer	Beck Wu	Configurations	802.11a Ch 48

Vertical

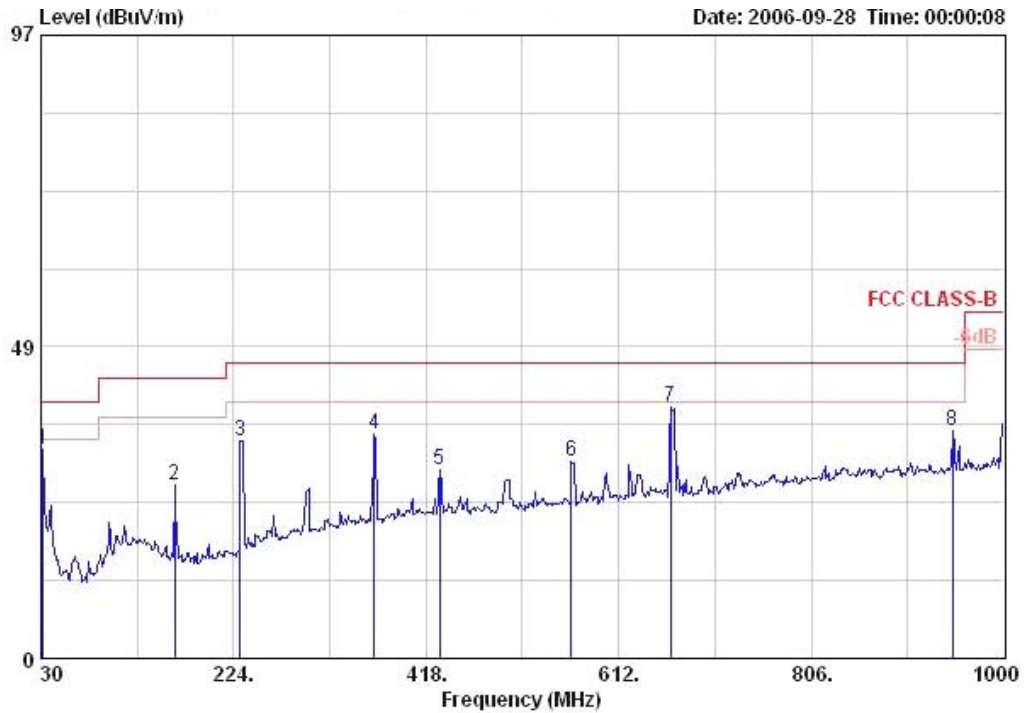

	Freq	Level	Over Limit	Limit Line	Read Level	Antenna Factor	Cable Loss	Preamp	Remark	Ant Pos	Table Pos
	MHz	dBuV/m	dB	dBuV/m	dBuV	dB/m	dB	dB		cm	deg
1	31.940	32.47	-7.53	40.00	39.68	18.96	0.32	26.49	Peak	400	0
2	164.830	27.05	-16.45	43.50	41.63	10.35	0.72	25.66	Peak	400	0
3	230.790	33.86	-12.14	46.00	46.83	11.39	1.08	25.44	Peak	400	0
4	365.620	34.82	-11.18	46.00	43.00	15.68	1.30	25.16	Peak	400	0
5	431.580	29.45	-16.55	46.00	36.81	16.94	1.49	25.79	Peak	400	0
6	564.470	30.60	-15.40	46.00	36.40	18.72	1.75	26.26	Peak	400	0
7	664.380	38.99	-7.01	46.00	43.34	19.63	2.14	26.12	Peak	400	0
8	948.590	35.31	-10.69	46.00	35.75	21.99	3.05	25.49	Peak	400	0

Horizontal

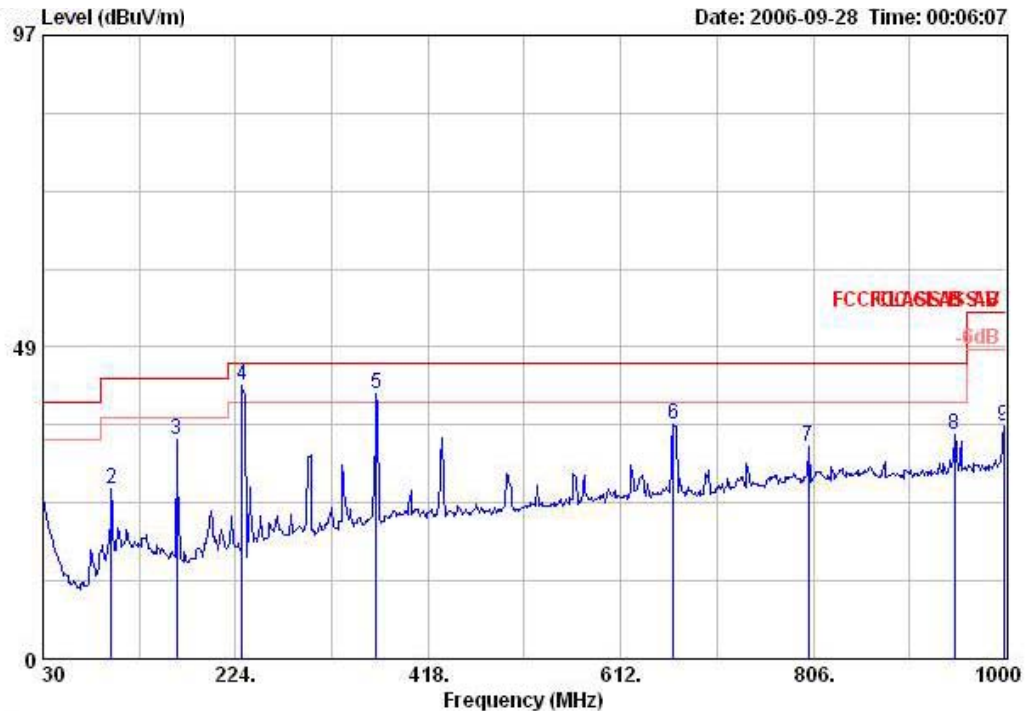

	Freq	Level	Over Limit	Limit Line	Read Level	Antenna Factor	Cable Loss	Preamp Factor	Remark	Ant Pos	Table Pos
	MHz	dBUV/m	dB	dBUV/m	dBUV	dB/m	dB	dB		cm	deg
1	30.000	24.95	-15.05	40.00	30.99	20.20	0.44	26.68	Peak	100	0
2	98.870	26.55	-16.95	43.50	41.14	11.01	0.36	25.96	Peak	100	0
3	164.830	34.17	-9.33	43.50	48.75	10.35	0.72	25.66	Peak	100	0
4 !	230.790	42.48	-3.52	46.00	55.45	11.39	1.08	25.44	Peak	100	0
5 !	365.620	41.24	-4.76	46.00	49.43	15.68	1.30	25.16	Peak	100	0
6	665.350	36.45	-9.55	46.00	40.79	19.63	2.14	26.12	Peak	100	0
7	801.150	32.97	-13.03	46.00	34.94	20.71	2.50	25.18	Peak	100	0
8	948.590	34.95	-11.05	46.00	35.39	21.99	3.05	25.49	Peak	100	0
9	998.060	36.14	-17.86	54.00	35.97	22.29	3.11	25.23	Peak	100	0

Note:

The amplitude of spurious emissions that are attenuated by more than 20 dB below the permissible value has no need to be reported.

Emission level (dBUV/m) = 20 log Emission level (uV/m).

Corrected Reading: Antenna Factor + Cable Loss + Read Level - Preamp Factor = Level.

4.6.9. Results for Radiated Emissions (1GHz~40GHz)

Temperature	23°C	Humidity	54%
Test Engineer	Beck Wu	Configurations	802.11a Ch 36

Vertical

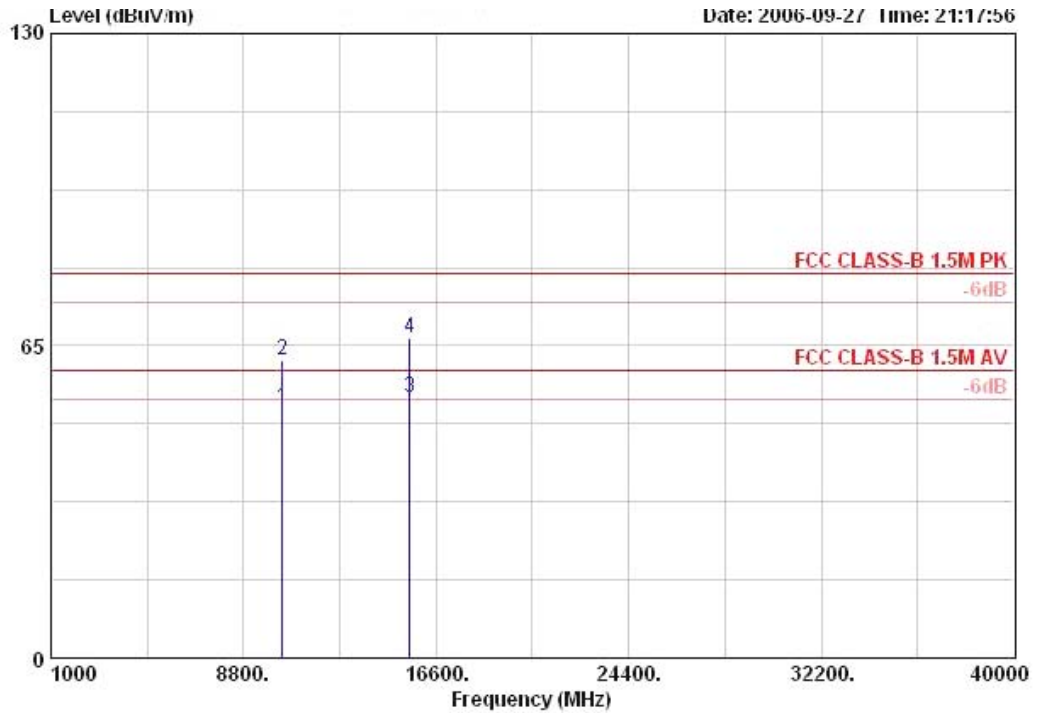

	Freq	Level	Over Limit	Limit Line	Read Level	Antenna Factor	Cable Loss	Preamp Factor	Remark	Ant Pos	Table Pos
	MHz	dBuV/m	dB	dBuV/m	dBuV	dB/m	dB	dB		cm	deg
1	10360.200	51.90	-8.10	60.00	35.44	39.34	10.54	33.42	AVERAGE	100	296
2	10360.200	62.09	-17.91	80.00	45.63	39.34	10.54	33.42	PEAK	100	296
3	15539.560	54.25	-5.75	60.00	35.66	38.15	13.45	33.01	AVERAGE	100	247
4	15539.560	66.73	-13.27	80.00	48.14	38.15	13.45	33.01	PEAK	100	247

Horizontal

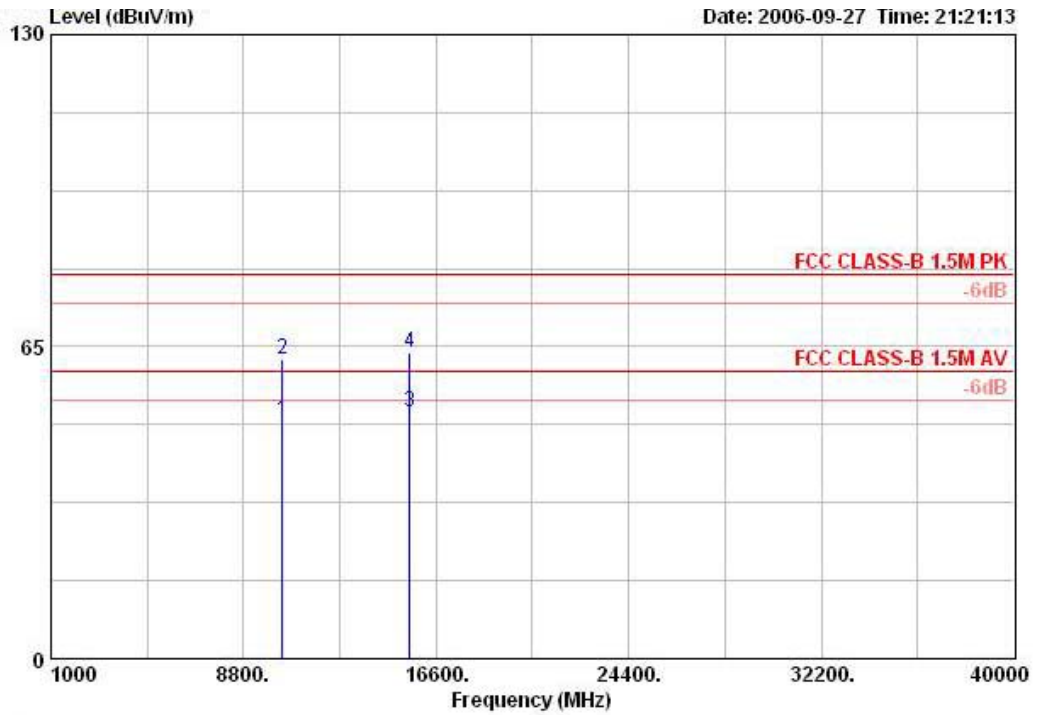

	Freq	Level	Over Limit	Limit Line	Read Level	Antenna Factor	Cable Loss	Preamp Factor	Remark	Ant Pos	Table Pos
	MHz	dBuV/m	dB	dBuV/m	dBuV	dB/m	dB	dB		cm	deg
1	10359.170	49.43	-10.57	60.00	32.97	39.34	10.54	33.42	AVERAGE	100	308
2	10359.170	62.35	-17.65	80.00	45.88	39.34	10.54	33.42	PEAK	100	308
3	15539.010	51.35	-8.65	60.00	32.76	38.15	13.45	33.01	AVERAGE	0	247
4	15539.010	63.93	-16.07	80.00	45.34	38.15	13.45	33.01	PEAK	100	247



Temperature	23°C	Humidity	54%
Test Engineer	Beck Wu	Configurations	802.11a Ch 40

Vertical

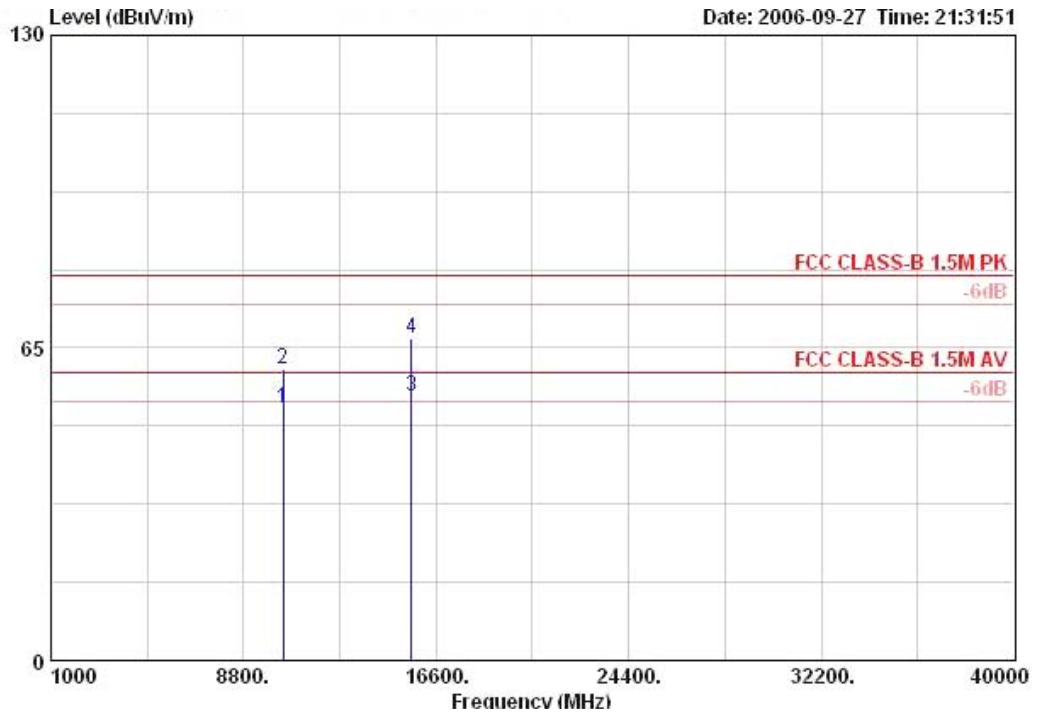

	Freq	Level	Over Limit	Limit Line	Read Level	Antenna Factor	Cable Loss	Preamp Factor	Remark	Ant Pos	Table Pos
	MHz	dBuV/m	dB	dBuV/m	dBuV	dB/m	dB	dB		cm	deg
1	10400.780	52.35	-7.65	60.00	35.78	39.38	10.57	33.38	AVERAGE	100	240
2	10400.780	60.66	-19.34	80.00	44.08	39.38	10.57	33.38	PEAK	100	240
3 !	15600.050	54.75	-5.25	60.00	36.24	38.06	13.50	33.04	AVERAGE	100	312
4	15600.050	66.96	-13.04	80.00	48.45	38.06	13.50	33.04	PEAK	100	312

Horizontal

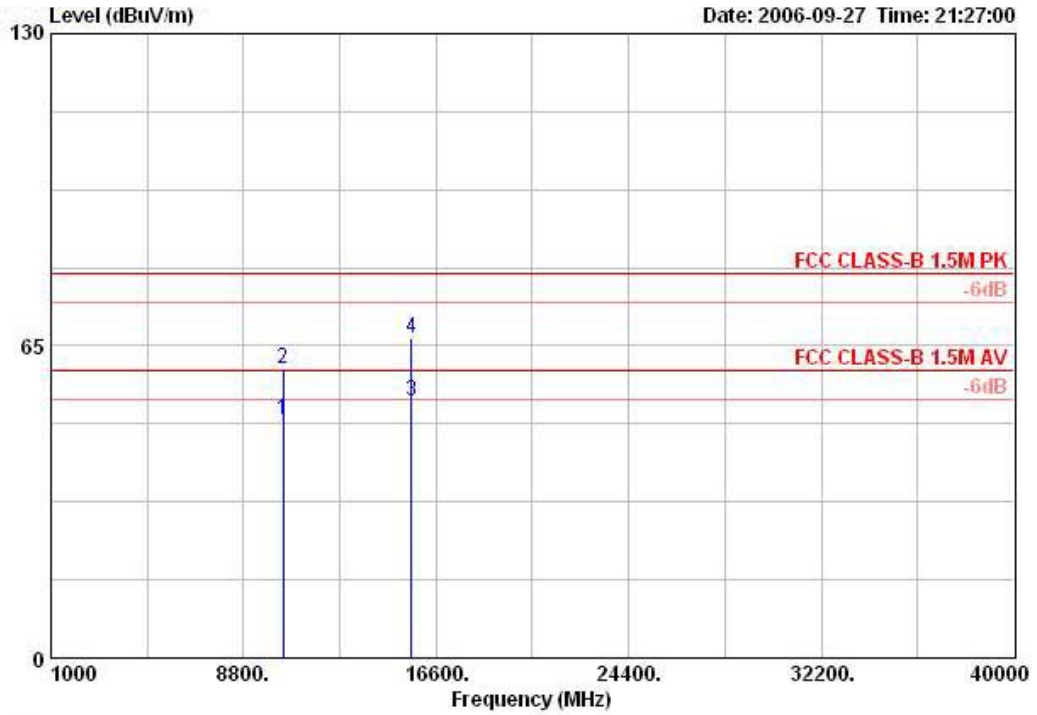

	Freq	Level	Over Limit	Limit Line	Read Level	Antenna Factor	Cable Loss	Preamp Factor	Remark	Ant Pos	Table Pos
	MHz	dBuV/m	dB	dBuV/m	dBuV	dB/m	dB	dB		cm	deg
1	10399.990	49.50	-10.50	60.00	32.93	39.38	10.57	33.38	AVERAGE	100	310
2	10399.990	60.26	-19.74	80.00	43.69	39.38	10.57	33.38	PEAK	100	310
3	15600.050	53.40	-6.60	60.00	34.89	38.06	13.50	33.04	AVERAGE	100	232
4	15600.050	66.50	-13.50	80.00	47.99	38.06	13.50	33.04	PEAK	100	232



Temperature	23°C	Humidity	54%
Test Engineer	Beck Wu	Configurations	802.11a Channel 48

Vertical

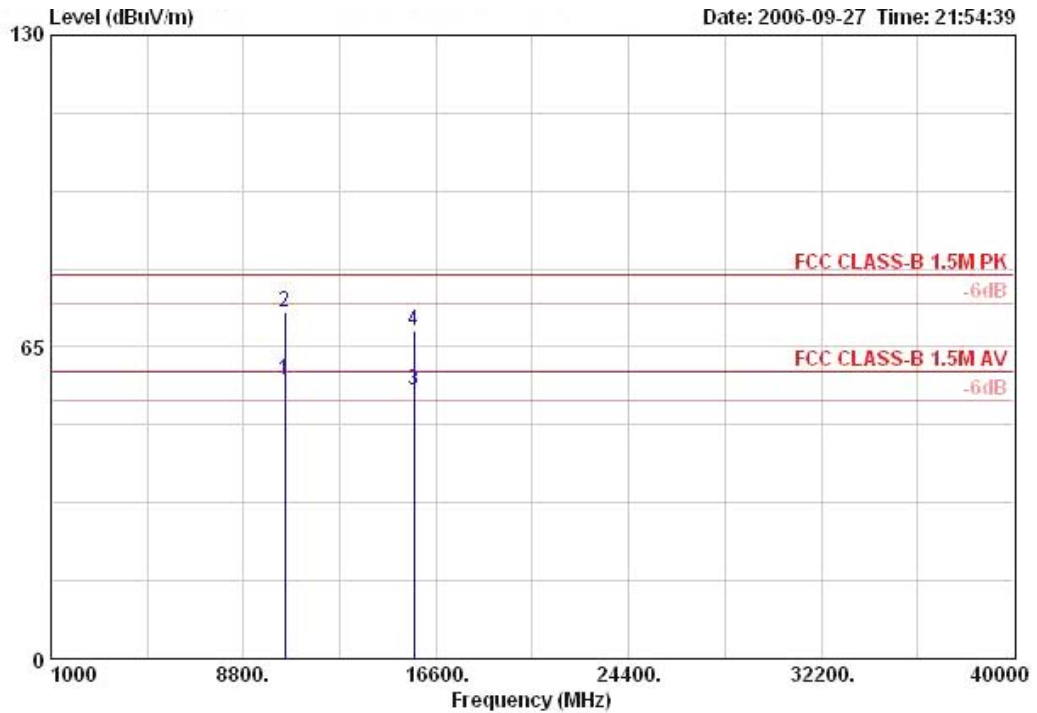

	Freq	Level	Over Limit	Limit Line	Read Level	Antenna Factor	Cable Loss	Preamplifier	Remark	Ant Pos	Table Pos
	MHz	dBuV/m	dB	dBuV/m	dBuV	dB/m	dB	dB		cm	deg
1 !	10479.950	58.16	-1.84	60.00	41.37	39.48	10.63	33.32	AVERAGE	104	241
2	10479.950	72.13	-7.87	80.00	55.34	39.48	10.63	33.32	PEAK	104	241
3 !	15719.570	55.95	-4.05	60.00	37.51	37.89	13.64	33.08	AVERAGE	104	295
4	15719.570	68.50	-11.50	80.00	50.06	37.89	13.64	33.08	PEAK	104	295

Horizontal

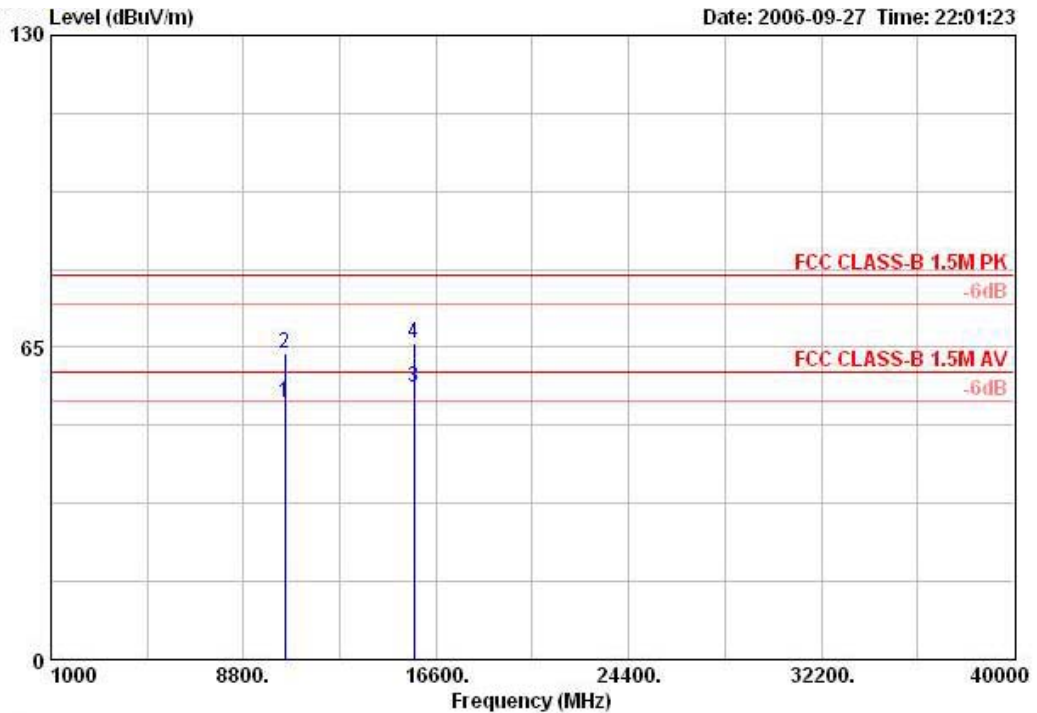

	Over	Limit	Read	Antenna	Cable	Preamp		Ant	Table		
Freq	Level	Limit	Level	Factor	Loss	Factor	Remark	Pos	Pos		
MHz	dBuV/m	dB	dBuV/m	dBuV	dB/m	dB	dB	cm	deg		
1	10480.190	53.64	-6.36	60.00	36.85	39.48	10.63	33.32	AVERAGE	0	252
2	10480.190	63.92	-16.08	80.00	47.13	39.48	10.63	33.32	PEAK	120	252
3 !	15719.570	56.72	-3.28	60.00	38.28	37.89	13.64	33.08	AVERAGE	101	230
4	15719.570	65.74	-14.26	80.00	47.30	37.89	13.64	33.08	PEAK	101	230

Note:

The amplitude of spurious emissions that are attenuated by more than 20 dB below the permissible value has no need to be reported.

Emission level (dBUV/m) = 20 log Emission level (uV/m).

Corrected Reading: Antenna Factor + Cable Loss + Read Level - Preamp Factor = Level.

The limits above 5GHz shall be extrapolated to the specified distance using an extrapolation factor of 20 dB/decade form 3m to 1.5m.

Distance extrapolation factor = 20 log (specific distanc [3m] / test distance [1.5m]) (dB);

Limit line = specific limits (dBUV) + distance extrapolation factor [6 dB].

4.7. Band Edge Emissions Measurement

4.7.1. Limit

For transmitters operating in the 5.15-5.25 GHz band: all emissions outside of the 5.15-5.25 GHz band shall not exceed an EIRP of -27 dBm/MHz (68.3dBuV/m at 3m). In addition, In case the emission fall within the restricted band specified on 15.205(a), then the 15.209(a) limit in the table below has to be followed.

Frequencies (MHz)	Field Strength (micровolts/meter)	Measurement Distance (meters)
0.009~0.490	2400/F(KHz)	300
0.490~1.705	24000/F(KHz)	30
1.705~30.0	30	30
30~88	100	3
88~216	150	3
216~960	200	3
Above 960	500	3

4.7.2. Measuring Instruments and Setting

Please refer to section 5 of equipments list in this report. The following table is the setting of the spectrum analyzer.

Spectrum Parameter	Setting
Attenuation	Auto
Span Frequency	100 MHz
RB / VB (Emission in restricted band)	1 MHz / 1 MHz for Peak, 1 MHz / 10Hz for Average
RB / VB (Emission in non-restricted band)	1 MHz / 1 MHz for Peak

4.7.3. Test Procedures

1. The test procedure is the same as section 4.6.3, only the frequency range investigated is limited to 100MHz around bandedges.
2. In case the emission is fail due to the used RB/VB is too wide, marker-delta method of FCC Public Notice DA00-705 will be followed.

4.7.4. Test Setup Layout

This test setup layout is the same as that shown in section 4.6.4.

4.7.5. Test Deviation

There is no deviation with the original standard.

4.7.6. EUT Operation during Test

The EUT was programmed to be in continuously transmitting mode.

4.7.7. Test Result of Band Edge and Fundamental Emissions

Temperature	23°C	Humidity	54%
Test Engineer	Beck Wu	Configurations	802.11a Channel 36, 48

Channel 36

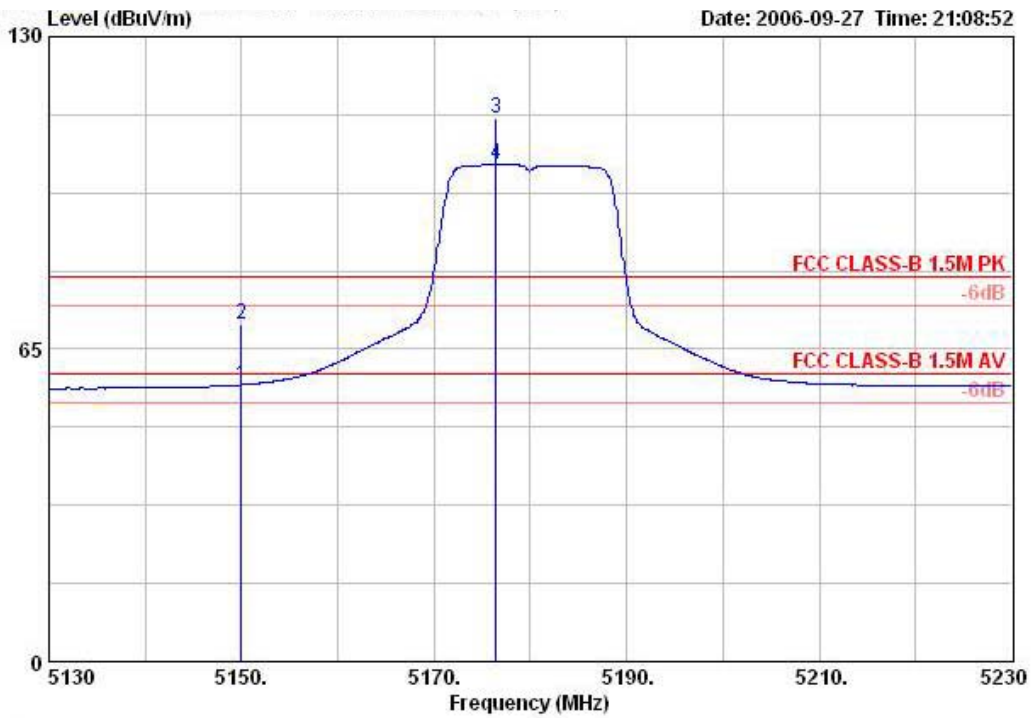

	Over	Limit	Read	Antenna	Cable	Preamp		Ant	Table		
Freq	Level	Limit	Level	Factor	Loss	Factor	Remark	Pos	Pos		
MHz	dBuV/m	dB	dBuV/m	dBuV	dB/m	dB	dB	cm	deg		
1 !	5150.000	57.53	-2.47	60.00	16.38	33.84	7.32	0.00	AVERAGE	100	180
2	5150.000	70.08	-9.92	80.00	28.92	33.84	7.32	0.00	PEAK	100	180
3	5176.400	113.13			71.91	33.89	7.33	0.00	PEAK	100	180
4	5176.400	103.39			62.16	33.89	7.33	0.00	AVERAGE	100	180

Channel 36 is fundamental frequency at 5180 MHz.

Channel 48

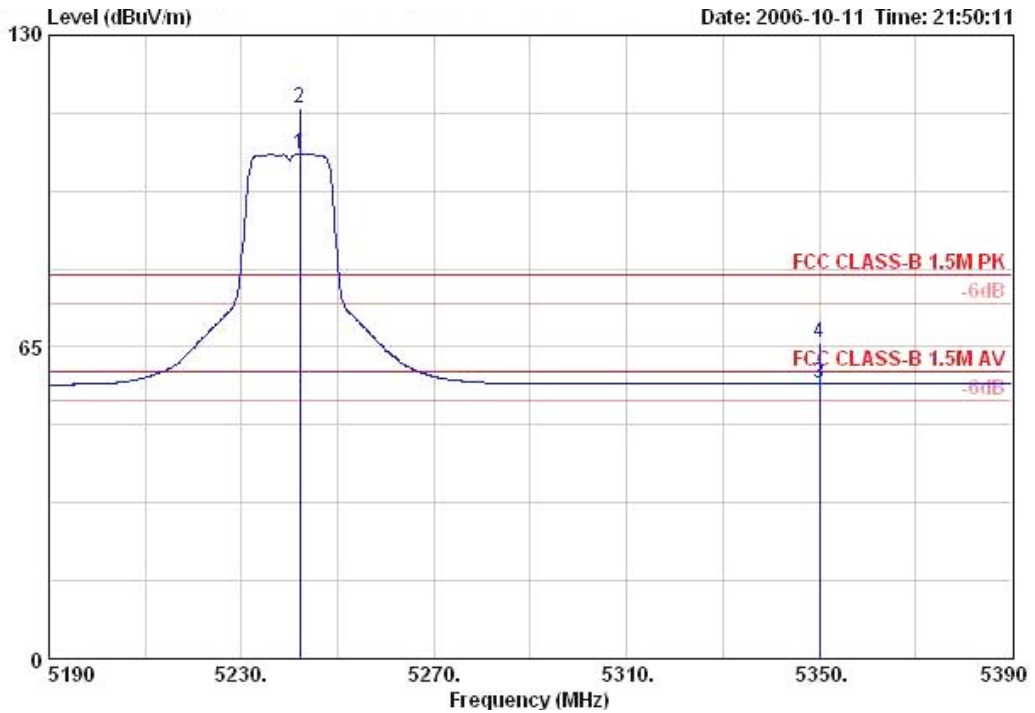

	Freq	Level	Over Limit	Limit Line	Read Level	Antenna Factor	Cable Loss	Preamp Factor	Remark	Ant Pos	Table Pos
	MHz	dBuV/m	dB	dBuV/m	dBuV	dB/m	dB	dB		cm	deg
1	5242.200	105.34			63.97	34.00	7.37	0.00	AVERAGE	104	5
2	5242.200	114.94			73.57	34.00	7.37	0.00	PEAK	104	5
3	5350.000	57.37	-2.63	60.00	15.81	34.16	7.40	0.00	AVERAGE	104	5
4	5350.000	65.72	-14.28	80.00	24.16	34.16	7.40	0.00	Peak	104	5

Channel 48 is fundamental frequency at 5240 MHz.

Note:

Emission level (dBUV/m) = 20 log Emission level (uV/m)

Corrected Reading: Antenna Factor + Cable Loss + Read Level - Preamp Factor = Level

The limits above 5GHz shall be extrapolated to the specified distance using an extrapolation factor of 20 dB/decade from 3m to 1.5m.

Distance extrapolation factor = 20 log (specific distance [3m] / test distance [1.5m]) (dB);

Limit line = specific limits (dBUV) + distance extrapolation factor [6 dB].

EIRP Emission in Band on Configuration IEEE 802.11a / 5180 MHz

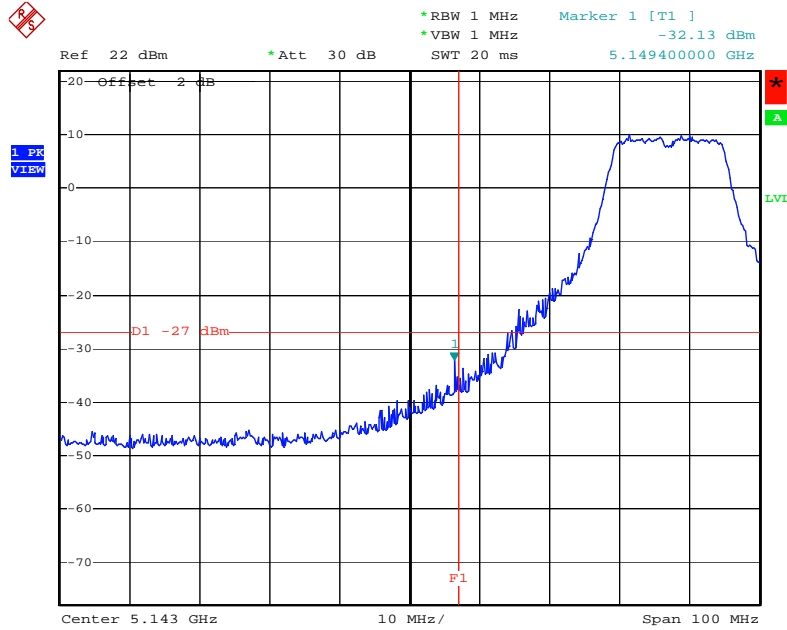

Date: 27.SEP.2006 03:58:32

EIRP Emission in Band on Configuration IEEE 802.11a / 5240 MHz

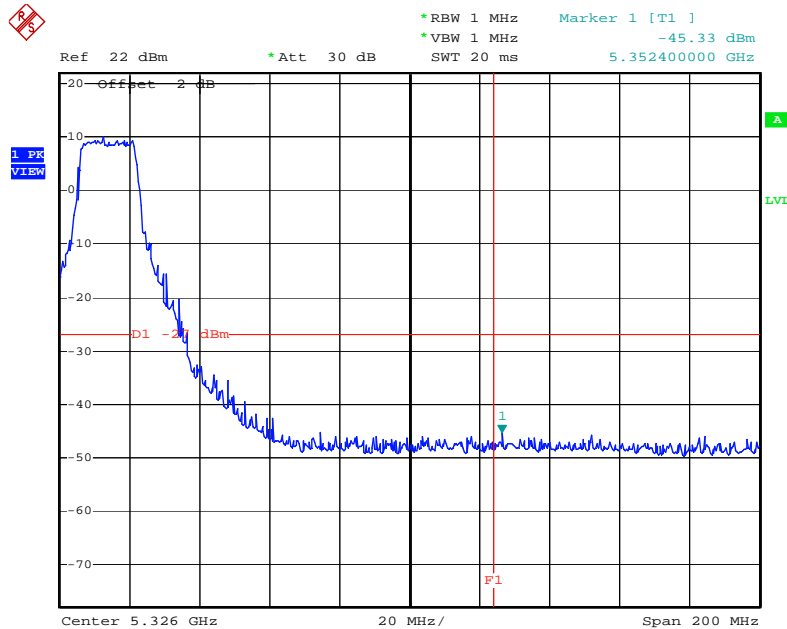

Date: 11.OCT.2006 11:57:05

4.8. Frequency Stability Measurement

4.8.1. Limit

Manufacturers of U-NII devices are responsible for ensuring frequency stability such that an emissions is maintained within the band of operation under all conditions of normal operation as specified in the user's manual or $\pm 20\text{ppm}$ (IEEE 802.11a specification).

4.8.2. Measuring Instruments and Setting

Please refer to section 5 of equipments list in this report. The following table is the setting of the spectrum analyzer.

Spectrum Parameter	Setting
Attenuation	Auto
Span Frequency	Entire absence of modulation emissions bandwidth
RB	10 kHz
VB	10 kHz
Sweep Time	Auto

4.8.3. Test Procedures

1. The transmitter output (antenna port) was connected to the spectrum analyser.
2. EUT have transmitted absence of modulation signal and fixed channelize.
3. Set the spectrum analyzer span to view the entire absence of modulation emissions bandwidth.
4. Set RBW = 10 kHz, VBW = 10 kHz with peak detector and maxhold settings.
5. f_c is declaring of channel frequency. Then the frequency error formula is $(f_c - f)/f_c \times 10^6$ ppm and the limit is less than $\pm 20\text{ppm}$ (IEEE 802.11a specification).
6. The test extreme voltage is to change the primary supply voltage from 85 to 115 percent of the nominal value
7. Extreme temperature rule is $-30^\circ\text{C} \sim 50^\circ\text{C}$.

4.8.4. Test Setup Layout

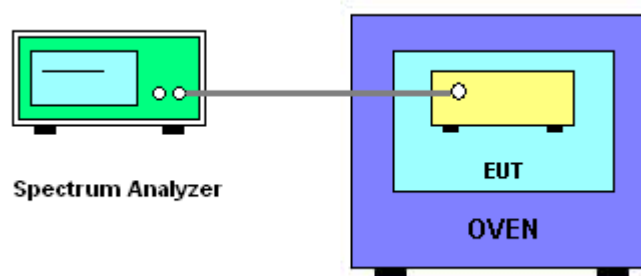

4.8.5. Test Deviation

There is no deviation with the original standard.

4.8.6. EUT Operation during Test

The EUT was programmed to be in continuously un-modulation transmitting mode.

4.8.7. Test Result of Frequency Stability

Voltage vs. Frequency Stability

Voltage	Measurement Frequency (MHz)
(V)	5240
126.50	5240.0166
110.00	5240.0168
93.50	5240.0142
Max. Deviation (MHz)	0.0168
Max. Deviation (ppm)	3.2061

Temperature vs. Frequency Stability

Temperature	Measurement Frequency (MHz)
(°C)	5240
-30	5240.0468
-20	5240.0432
-10	5240.0426
0	5240.0390
10	5240.0228
20	5240.0168
30	5240.0054
40	5239.9964
50	5239.9958
Max. Deviation (MHz)	0.0468
Max. Deviation (ppm)	8.9313

4.9. Antenna Requirements

4.9.1. Limit

Except for special regulations, the Low-power Radio-frequency Devices must not be equipped with any jacket for installing an antenna with extension cable. An intentional radiator shall be designed to ensure that no antenna other than that furnished by the responsible party shall be used with the device. The use of a permanently attached antenna or of an antenna that uses a unique coupling to the intentional radiator shall be considered sufficient to comply with the provisions of this Section. The manufacturer may design the unit so that the user can replace a broken antenna, but the use of a standard antenna jack or electrical connector is prohibited. Further, this requirement does not apply to intentional radiators that must be professionally installed.

4.9.2. Antenna Connector Construction

Please refer to section 3.3 in this test report; antenna connector complied with the requirements.

5. LIST OF MEASURING EQUIPMENTS

Instrument	Manufacturer	Model No.	Serial No.	Characteristics	Calibration Date	Remark
EMC Receiver	R&S	ESCS 30	100174	9kHz – 2.75GHz	Feb. 22, 2006	Conduction (CO04-HY)
LISN	MessTec	NNB-2/16Z	99079	9kHz – 30MHz	Dec. 19, 2005	Conduction (CO04-HY)
LISN (Support Unit)	EMCO	3810/2NM	9708-1839	9kHz – 30MHz	Mar. 18, 2006	Conduction (CO04-HY)
RF Cable-CON	UTIFLEX	3102-26886-4	CB049	9kHz – 30MHz	Apr. 20, 2006	Conduction (CO04-HY)
EMI Filter	LINDGREN	LRE-2030	2651	< 450 Hz	N/A	Conduction (CO04-HY)
3m Semi Anechoic Chamber	SIDT FRANKONIA	SAC-3M	03CH03-HY	30 MHz - 1 GHz 3m	Jun. 15, 2006	Radiation (03CH03-HY)
Amplifier	SCHAFFNER	CPA9231A	18667	9 kHz - 2 GHz	Jan. 18, 2006	Radiation (03CH03-HY)
Amplifier	Agilent	8449B	3008A02120	1 GHz - 26.5 GHz	May 29, 2006	Radiation (03CH03-HY)
Amplifier	MITEQ	AMF-6F-260400	923364	26.5 GHz - 40 GHz	Jan. 24, 2006*	Radiation (03CH03-HY)
Spectrum Analyzer	R&S	FSP40	100004/040	9 kHz - 40 GHz	Sep. 30, 2005	Radiation (03CH03-HY)
Loop Antenna	R&S	HFH2-Z2	860004/001	9 kHz - 30 MHz	May 23, 2006*	Radiation (03CH03-HY)
Bilog Antenna	SCHAFFNER	CBL 6112D	22237	30 MHz – 1 GHz	Jul. 24, 2006	Radiation (03CH03-HY)
Horn Antenna	EMCO	3115	6903	1GHz ~ 18GHz	Mar. 15, 2006	Radiation (03CH03-HY)
Horn Antenna	SCHWARZBECK	BBHA9170	BBHA9170154	15 GHz - 40 GHz	NCR	Radiation (03CH03-HY)
RF Cable-R03m	Jye Bao	RG142	CB021	30 MHz - 1 GHz	Dec.02, 2005	Radiation (03CH03-HY)
RF Cable-HIGH	SUHNER	SUCOFLEX 106	03CH03-HY	1 GHz - 40 GHz	Dec.02, 2005	Radiation (03CH03-HY)
Turn Table	HD	DS 420	420/650/00	0 – 360 degree	N/A	Radiation (03CH03-HY)
Antenna Mast	HD	MA 240	240/560/00	1 m - 4 m	N/A	Radiation (03CH03-HY)
Spectrum Analyzer	R&S	FSP30	100023	9kHz ~ 30GHz	Nov. 26, 2005	Conducted (TH01-HY)
Power Meter	R&S	NRVS	100764	DC ~ 40GHz	Jul, 20, 2006	Conducted (TH01-HY)
Power Sensor	R&S	NRV-Z51	100666	DC ~ 40GHz	Jul. 20, 2006	Conducted (TH01-HY)
Power Sensor	R&S	NRV-Z32	100057	30MHz ~ 6GHz	Jun, 10, 2006	Conducted (TH01-HY)
AC Power Source	HPC	HPA-500W	HPA-9100024	AC 0 ~ 300V	Apr. 21, 2005*	Conducted (TH01-HY)
DC Power Source	G.W.	GPC-6030D	C671845	DC 1V ~ 60V	Dec. 28, 2005	Conducted (TH01-HY)
Temp. and Humidity Chamber	KSON	THS-C3L	612	N/A	Oct. 01, 2005	Conducted (TH01-HY)
RF CABLE-1m	Jye Bao	RG142	CB034-1m	20MHz ~ 7GHz	Dec. 30, 2005	Conducted (TH01-HY)



Instrument	Manufacturer	Model No.	Serial No.	Characteristics	Calibration Date	Remark
RF CABLE-2m	Jye Bao	RG142	CB035-2m	20MHz ~ 1GHz	Dec. 30, 2005	Conducted (TH01-HY)
Oscilloscope	Tektronix	TDS1012	CO38515	100MHz / 1GS/s	Jun. 20, 2006	Conducted (TH01-HY)
Signal Generator	R&S	SMR40	100116	10MHz ~ 40GHz	Dec. 30, 2005	Conducted (TH01-HY)
Data Generator	Tektronix	DG2030	063-2920-50	0.1Hz~400MHz	Jun. 16, 2006	Conducted (TH01-HY)

Note: Calibration Interval of instruments listed above is one year.

Note: * Calibration Interval of instruments listed above is two year.

Note: NCR means Non-Calibration required.

6. TEST LOCATION

SHIJR	ADD : 6Fl., No. 106, Sec. 1, Shintai 5th Rd., Shijr City, Taipei, Taiwan 221, R.O.C. TEL : 886-2-2696-2468 FAX : 886-2-2696-2255
HWA YA	ADD : No. 52, Hwa Ya 1st Rd., Kwei-Shan Hsiang, Tao Yuan Hsien, Taiwan, R.O.C. TEL : 886-3-327-3456 FAX : 886-3-318-0055
LINKOU	ADD : No. 30-2, Dingfu Tsuen, Linkou Shiang, Taipei, Taiwan 244, R.O.C TEL : 886-2-2601-1640 FAX : 886-2-2601-1695
DUNGHU	ADD : No. 3, Lane 238, Kangle St., Neihu Chiu, Taipei, Taiwan 114, R.O.C. TEL : 886-2-2631-4739 FAX : 886-2-2631-9740
JUNGHE	ADD : 7Fl., No. 758, Jungjeng Rd., Junghe City, Taipei, Taiwan 235, R.O.C. TEL : 886-2-8227-2020 FAX : 886-2-8227-2626
NEIHU	ADD : 4Fl., No. 339, Hsin Hu 2 nd Rd., Taipei 114, Taiwan, R.O.C. TEL : 886-2-2794-8886 FAX : 886-2-2794-9777
JHUBEI	ADD : No.8, Lane 724, Bo-ai St., Jhubei City, HsinChu County 302, Taiwan, R.O.C. TEL : 886-3-656-9065 FAX : 886-3-656-9085