



FCC 47 CFR PART 15 SUBPART C AND ANSI C63.4 : 2003

TEST REPORT

For

802.11b/g Wireless mini-PCI Module

Model : XG-623

Issued for

Z-Com, Inc.

7F-2, No.9, Prosperity Rd. I, Science-Based Industrial,

Park Hsinchu, 300 Taiwan, R.O.C.

Issued by

Compliance Certification Services Inc.

Hsinchu Lab.

Rm. 258, Bldg. 17, NO.195, Sec.4 Chung Hsing Rd.,

Chu Tung Chen, Hsinchu, Taiwan 310, R.O.C

TEL: (03) 591-0068

FAX: (03) 582-5720



Note: This report shall not be reproduced except in full, without the written approval of Compliance Certification Services Inc. Ltd. This document may be altered or revised by Compliance Certification Services Inc. personnel only, and shall be noted in the revision section of the document.



TABLE OF CONTENTS

TITLE	PAGE NO.
1. TEST REPORT CERTIFICATION.....	3
2. EUT DESCRIPTION.....	4
2.1 DESCRIPTION OF EUT & POWER.....	4
3. DESCRIPTION OF TEST MODES.....	4
4. TEST METHODOLOGY.....	5
5. FACILITIES AND ACCREDITATIONS.....	5
5.1 FACILITIES.....	5
5.2 EQUIPMENT.....	5
5.3 LABORATORY ACCREDITATIONS LISTINGS.....	5
5.4 TABLE OF ACCREDITATIONS AND LISTINGS.....	6
6. CALIBRATION AND UNCERTAINTY.....	7
6.1 MEASURING INSTRUMENT CALIBRATION.....	7
6.2 MEASUREMENT UNCERTAINTY.....	7
7. SETUP OF EQUIPMENT UNDER TEST.....	8-9
8. APPLICABLE LIMITS AND TEST RESULTS.....	10
8.1 6dB BANDWIDTH.....	10-15
8.2 99% BANDWIDTH.....	16-21
8.3 MAXIMUM PEAK OUTPUT POWER.....	22-27
8.4 MAXIMUM PERMISSIBLE EXPOSURE.....	28-29
8.5 AVERAGE POWER.....	30-31
8.6 POWER SPECTRAL DENSITY.....	32-37
8.7 CONDUCTED SPURIOUS EMISSION.....	38-42
8.8 RADIATED EMISSIONS.....	43
8.8.1 TRANSMITTER RADIATED SUPURIOUS EMSSIONS.....	43-46
8.8.2 WORST-CASE RADIATED EMISSION BELOW 1 GHz.....	47
8.8.3 TRANSMITTER RADIATED EMISSION ABOVE 1 GHz.....	48-53
8.8.4 RESTRICTED BAND EDGES.....	54-61
8.9 POWERLINE CONDUCTED EMISSIONS.....	62-65
9. ANTENNA REQUIREMENT.....	66
9.1 STANDARD APPLICABLE.....	66
9.2 ANTENNA CONNECTED CONSTRUCTION.....	66
APPENDIX SETUP PHOTOS.....	67-70



1. TEST REPORT CERTIFICATION

Applicant : Z-Com, Inc.
Address : 7F-2, No.9, Prosperity Rd. I, Science-Based Industrial,
Park Hsinchu, 300 Taiwan, R.O.C.
Equipment Under Test : 802.11b/g Wireless mini-PCI Module
Model : XG-623
Tested Date : September 19 ~ 24, 2005

APPLICABLE STANDARD	
STANDARD	TEST RESULT
FCC Part 15 Subpart C : 2004 AND ANSI C63.4 : 2003	No non-compliance noted

Approved by:

C. F. Wu
Manager of Hsinchu Laboratory
Compliance Certification Services Inc.



Reviewed by:

Alan Fan
Test Engineer of Hsinchu Laboratory
Compliance Certification Services Inc.

WE HEREBY CERTIFY THAT: The measurements shown in the attachment were made in accordance with the procedures indicated, and the energy emitted by the equipment was found to be within the limits applicable. We assume full responsibility for the accuracy and completeness of these measurements and vouch for the qualifications of all persons taking them.



2. EUT DESCRIPTION

2.1 DESCRIPTION OF EUT & POWER

Product Name	802.11b/g Wireless mini-PCI Module
Model Number	XG-623
Frequency Range	IEEE 802.11b/g : 2400MHz to 2483.5MHz
Transmit Power	IEEE 802.11b : 23.06dBm IEEE 802.11g : 23.06dBm
Channel Spacing	5MHz
Channel Number	IEEE 802.11b/g : 11 Channels
Transmit Data Rate	IEEE 802.11b : 11, 5.5, 2, 1 Mbps IEEE 802.11g : 54, 48, 36, 24, 18, 12, 11, 9, 6, 5.5, 2, 1 Mbps
Type of Modulation	IEEE 802.11b : DSSS (CCK, DQPSK, DBPSK) IEEE 802.11g : DSSS/OFDM (64QAM, 16AQM, QPSK, BPSK, CCK, DQPSK, DBPSK)
Frequency Selection	by software / firmware
Antenna Type	PIFA Antenna, Antenna Gain : -1dBi Main: ANTB24-041A0(ANTENNA-L, Black Cable) Aux: ANTB24-042A0(ANTENNA-R, Gray Cable) Connector type: MHF connector
Power Source	3.3VDC(From Notebook PC, Powered From Host Device)

Remark :

1. The sample selected for test was engineering sample that approximated to production product and was provided by manufacturer.
2. This submittal(s) (test report) is intended for FCC ID: M4Y-0XG623 filing to comply with Section 15.207, 15.209 and 15.247 of the FCC Part 15, Subpart C Rules.
3. For more details, please refer to the User's manual of the EUT.

3. DESCRIPTION OF TEST MODES

The EUT (XG-623) had been tested under operating condition.

There are three channels have been tested as following :

Channel	Frequency (MHz)
Low	2412
Middle	2437
High	2462

IEEE 802.11b : 11Mbps data rate (worst case) were chosen for full testing.

IEEE 802.11g : 6Mbps data rate (worst case) were chosen for full testing.



4. TEST METHODOLOGY

- (1) The tests documented in this report were performed in accordance with ANSI C63.4 and FCC CFR 47 2.1046, 2046, 2.1047, 2.1049, 2.1051, 2.1053, 2.1055, 2.1057, 15.207, 15.209 and 15.247.
- (2) The services listed follow related standards specified in SOP ET-SP-001.

5. FACILITIES AND ACCREDITATIONS

5.1 FACILITIES

All measurement facilities used to collect the measurement data are located at Rm.258, Bldg.17, NO.195 , Sec. 4, Chung Hsing Rd., Chu-Tung Chen. Hsin-Chu, Taiwan 310 R.O.C.

The sites are constructed in conformance with the requirements of ANSI C63.7, ANSI C63.4 and CISPR Publication 22.

5.2 EQUIPMENT

Radiated emissions are measured with one or more of the following types of linearly polarized antennas: tuned dipole, biconical, log periodic, bi-log, and/or ridged waveguide, horn. Spectrum analyzers with preselectors and quasi-peak detectors are used to perform radiated measurements.

Conducted emissions are measured with Line Impedance Stabilization Networks and EMI Test Receivers.







Calibrated wideband preamplifiers, coaxial cables, and coaxial attenuators are also used for making measurements.

All receiving equipment conforms to CISPR Publication 16-1, "Radio Interference Measuring Apparatus and Measurement Methods."

5.3 LABORATORY ACCREDITATIONS LISTINGS

The test facilities used to perform radiated and conducted emissions tests are accredited by National Voluntary Laboratory Accreditation Program for the specific scope of accreditation under Lab Code: 200118-0 to perform Electromagnetic Interference tests according to FCC PART 15 AND CISPR 22 requirements. No part of this report may be used to claim or imply product endorsement by NVLAP or any agency of the US Government. In addition, the test facilities are listed with Federal Communications Commission (registration no: 90585 and 90584).

5.4 TABLE OF ACCREDITATIONS AND LISTINGS

Country	Agency	Scope of Accreditation	Logo
USA	NVLAP	EN 55014-1, AS/NZS 1044, CNS 13783-1, IEC/CISPR 14-1, IEC/CISPR 22, EN 55022, EN 61000-3-2, EN 61000-3-3, ANSI C63.4, AS/NZS CISPR 22, AS/NZS 3548, IEC 61000-4-2/3/4/5/6/8/11	 200118-0
USA	FCC	3/10 meter Open Area Test Sites to perform FCC Part 15/18 measurements	 90585, 90584
Japan	VCCI	3/10 meter Open Area Test Sites to perform conducted/radiated measurements	 R-1229/1189 C-1250/1294
Taiwan	CNLA	FCC Method-47 CFR Part 15 Subpart C,D,E CISPR 11, FCC METHOD-47 CFR Part 18, EN 55011, CNS 13803, CISPR 13, CNS 13439, FCC Method-47 CFR Part 15 Subpart B, CISPR 14-1, EN 55014-1, CNS 13783-1, EN 55015, CNS 14115, CISPR 22, EN 55022, VCCI CNS 13438, EN 61000-4-2/3/4/5/6/8/11	 0240 ILAC MRA
Taiwan	BSMI	CNS 13803, CNS 13438, CNS 13439, CNS 13783-1, CNS 14115	 SL2-IS-E-0002 SL2-IN-E-0002 SL2-A1-E-0002 SL2-R1-E-0002 SL2-R2-E-0002 SL2-L1-E-0002
Canada	Industry Canada	RSS212, Issue 1	 IC 4417-1

* No part of this report may be used to claim or imply product endorsement by NVLAP or any agency of the US Government.



6. CALIBRATION AND UNCERTAINTY

6.1 MEASURING INSTRUMENT CALIBRATION

The measuring equipment utilized to perform the tests documented in this report has been calibrated in accordance with the manufacturer's recommendations, and is traceable to recognized national standards.

6.2 MEASUREMENT UNCERTAINTY

Where relevant, the following measurement uncertainty levels have been estimated for tests performed on the apparatus:

PARAMETER	UNCERTAINTY
Radiated Emission, 30 to 1000 MHz	+/- 3.2 dB
Radiated Emission, 1 to 26.5 GHz	+/- 3.2 dB
Power Line Conducted Emission	+/- 2.9 dB

Uncertainty figures are valid to a confidence level of 95%



7. SETUP OF EQUIPMENT UNDER TEST

SUPPORT EQUIPMENT

No.	Product	Manufacturer	Model No.	Serial No.	FCC ID
1	Notebook PC	COMPAQ	N800V	5Y33KSQZM0W4 1YR	DoC
2	Notebook PC	COMPAQ	N800V	5Y31KSQZD1TJ 1YR	DoC
3	Wireless Card	BUFFALO	WLI-CB-G54A	14084330419469	FDI-09101744-0
4	Wireless Access Point	D-Link	DWL-7100AP	DQ6114B00002	KA22003040018-1
5	Modem	ZyXEL	Omni 56K	S1Z4107727	1880MN156K
6	Printer	HP	hp desk jet 948c	CN19S6S1XS	DoC

SETUP DIAGRAM FOR TESTS

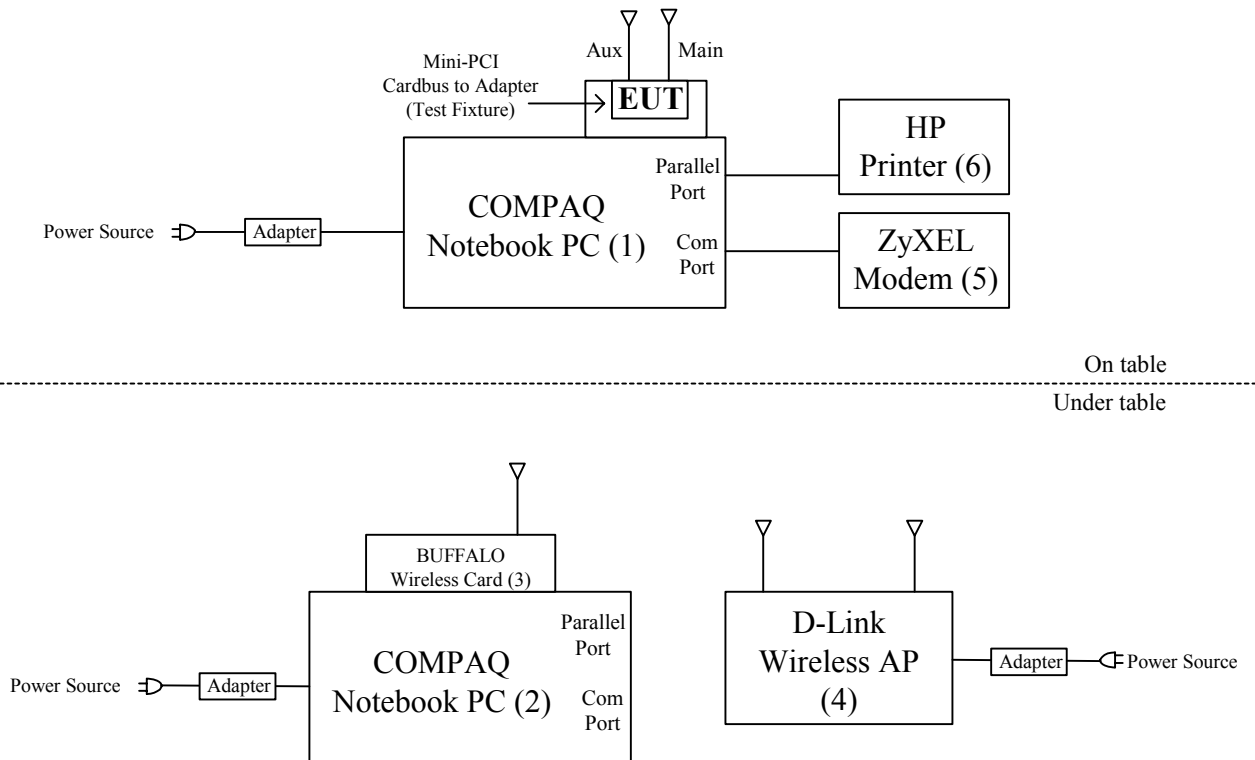



EUT OPERATING CONDITION

1. Set up all computers like the setup diagram.
2. All of the function are under run.
3. The “Atheros Radio Test <ART> Revision 5.2 BUILD #10” software was used for testing.

(1) TX Mode:

⇒ **Tx Data Rate: 11Mbps long** (IEEE 802.11b mode)

6Mbps (IEEE 802.11g mode)

⇒ **Toggle output mode = TX99**

Target Power: IEEE 802.11b mode Channel Low (2412MHz) = **19**

IEEE 802.11b mode Channel Middle (2437MHz) = **19**

IEEE 802.11b mode Channel High (2462MHz) = **19**

Target Power: IEEE 802.11g mode Channel Low (2412MHz) = **19**

IEEE 802.11g mode Channel Middle (2437MHz) = **19**

IEEE 802.11g mode Channel High (2462MHz) = **18.5**

(2) RX Mode :

⇒ **Continuous RF <R>eceive mode**

4. Notebook PC (2) ping 192.168.0.10 -t -l 5000 to Notebook PC(1).
5. Notebook PC (1) ping 192.168.0.20 -t -l 5000 to Notebook PC(2).
6. All of the function are under run.
7. Start test.



8. APPLICABLE LIMITS AND TEST RESULTS

8.1 6dB BANDWIDTH

LIMIT

§ 15.207(a) (2) For direct sequence systems, the minimum 6dB bandwidth shall be at least 500kHz

TEST EQUIPMENTS

Description & Manufacturer	Model No.	Serial No.	Date of Calibration
AGILENT SPECTRUM ANALYZER	E4446A	MY433601.32	January 26, 2005

TEST SETUP



TEST PROCEDURE

The transmitter output was connected to a spectrum analyzer. The bandwidth of the fundamental frequency was measured by spectrum analyzer with 100 KHz RBW and 1MHz VBW. The 6dB bandwidth is defined as the total spectrum the power of which is higher than peak power minus 6dB.

**TEST RESULTS**

No non-compliance noted

IEEE 802.11b MODE

Channel	Channel Frequency (MHz)	6dB Bandwidth (kHz)	Minimum Limit (kHz)	Pass / Fail
Low	2412	11370	500	PASS
Middle	2437	11570	500	PASS
High	2462	11930	500	PASS

IEEE 802.11g MODE

Channel	Channel Frequency (MHz)	6dB Bandwidth (kHz)	Minimum Limit (kHz)	Pass / Fail
Low	2412	16370	500	PASS
Middle	2437	16400	500	PASS
High	2462	16430	500	PASS



6dB BANDWIDTH (802.11b MODE)

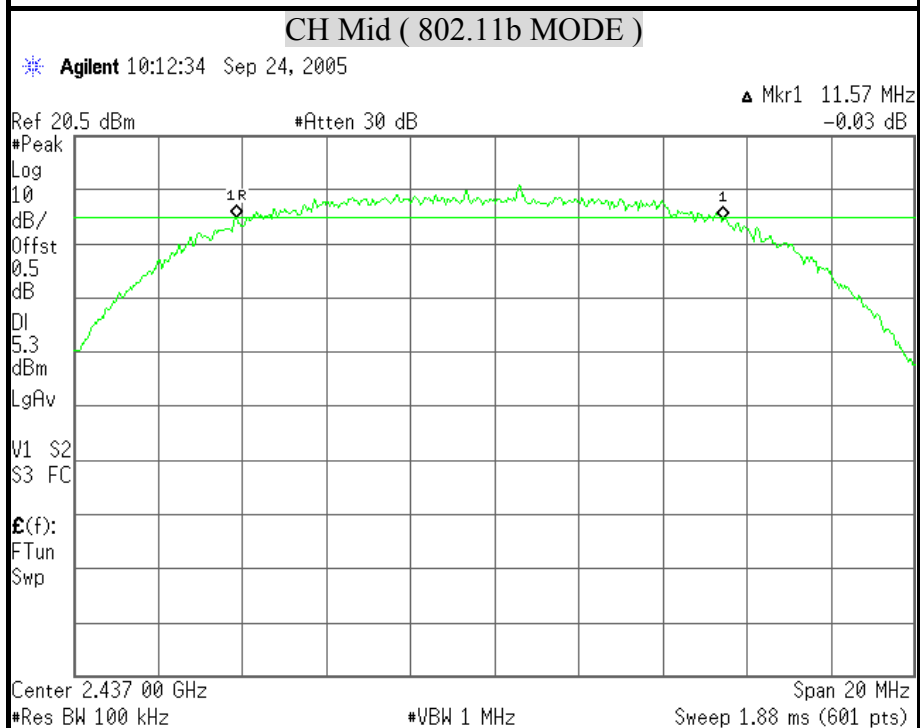
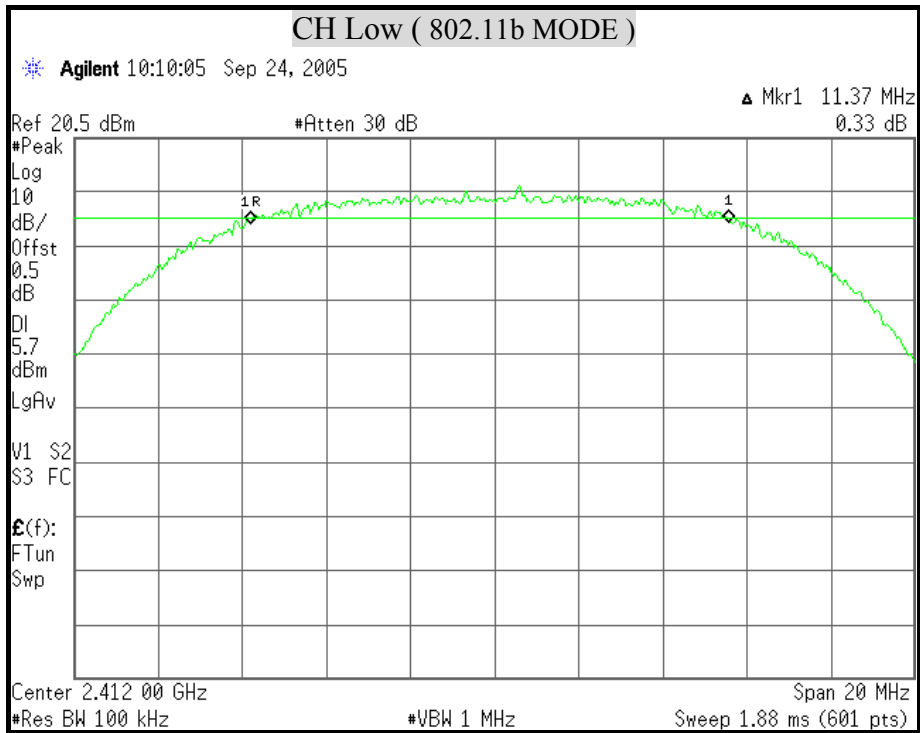

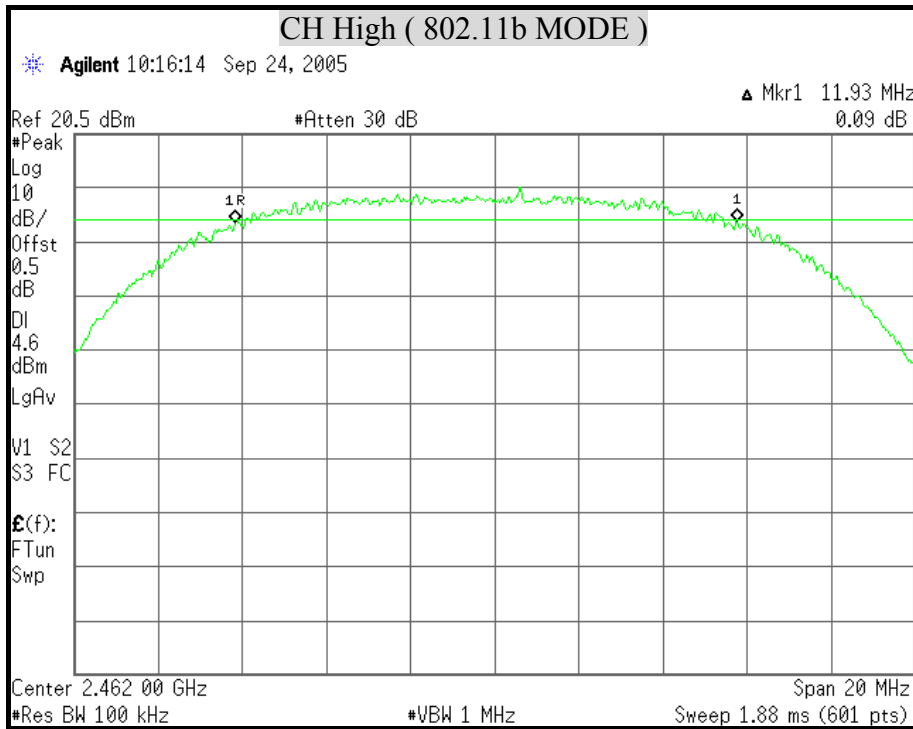



6dB BANDWIDTH (802.11g MODE)

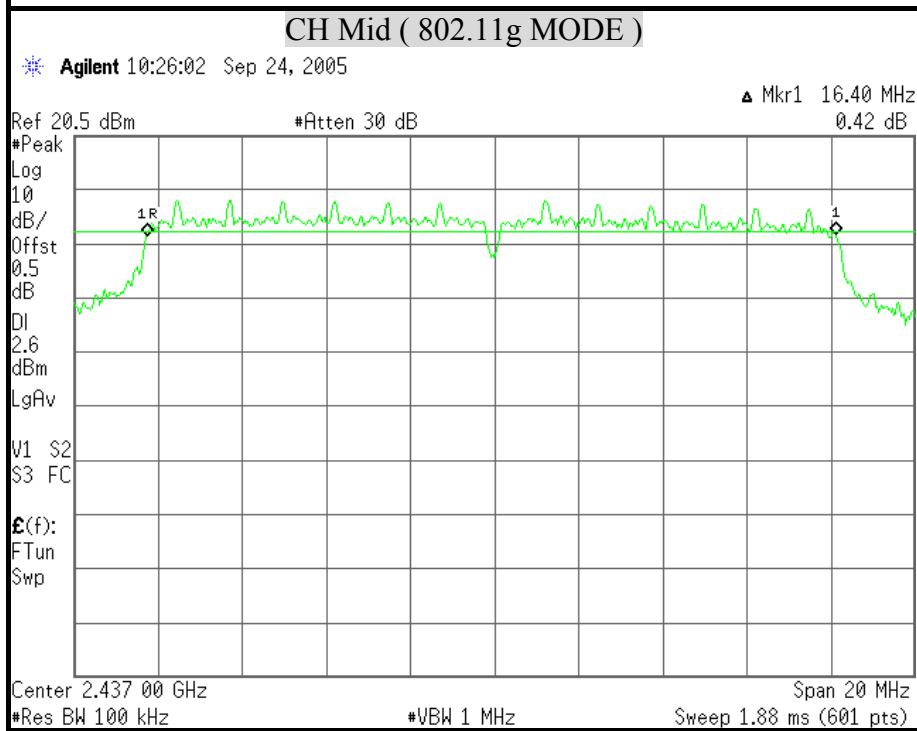
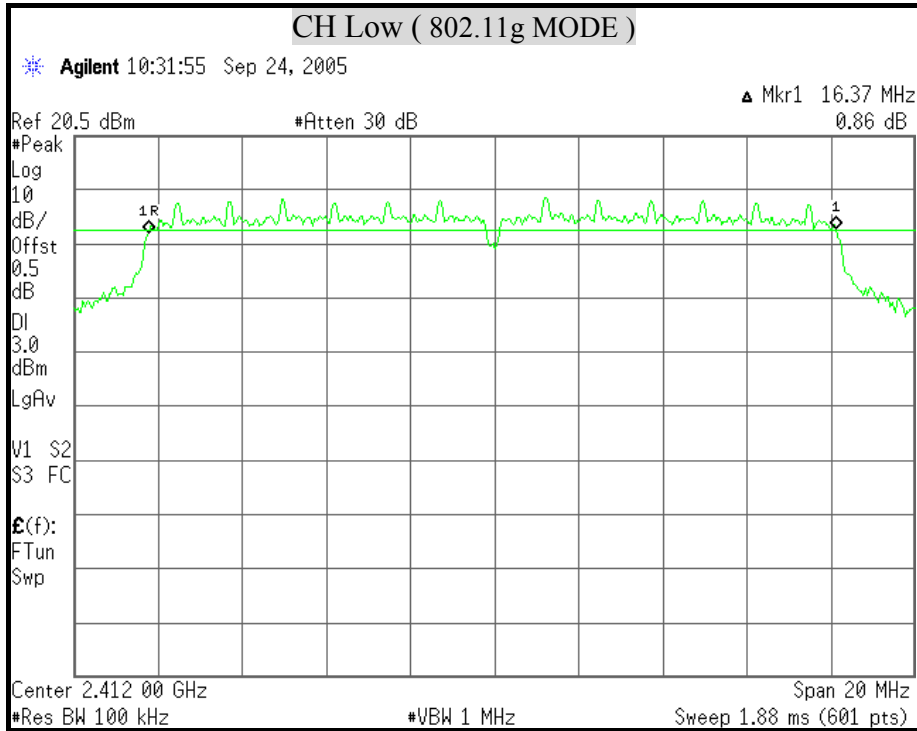

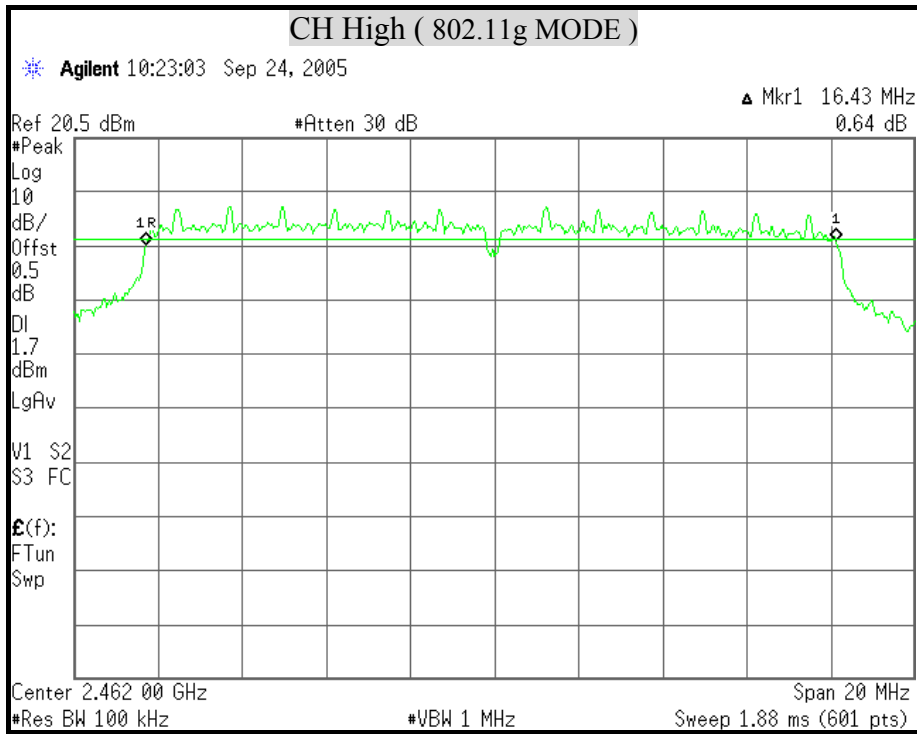



8.2 99% BANDWIDTH

LIMIT

None; for reporting purposes only.

TEST EQUIPMENTS

Description & Manufacturer	Model No.	Serial No.	Date of Calibration
AGILENT SPECTRUM ANALYZER	E4446A	MY433601.32	January 26, 2005

TEST SETUP

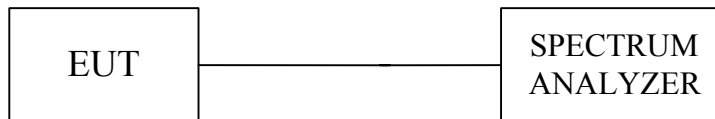

TEST PROCEDURE

1. The spectrum shall be set as follows :

Span : The minimum span to fully display the emission and approximately 20dB below peak level.

RBW : The set to 1% to 3% of the approximate emission width.

2. Compute the combined power of all signal responses contained in the trace by covering all the data points.

3. For 99% occupied BW, place the markers at the frequency at which 0.5% of the power lies to the right of the right marker and 0.5% of the power lies to the left of the left marker.

4. The 99% BW is the bandwidth between the right and left markers.

**TEST RESULTS**

No non-compliance noted

IEEE 802.11b MODE

Channel	Channel Frequency (MHz)	99% Occupied power bandwidth (MHz)
Low	2412.00	15.72
Middle	2437.00	15.78
High	2462.00	15.82

IEEE 802.11g MODE

Channel	Channel Frequency (MHz)	99% Occupied power bandwidth (MHz)
Low	2412.00	17.12
Middle	2437.00	17.05
High	2462.00	17.05



99% BANDWIDTH (802.11b MODE)

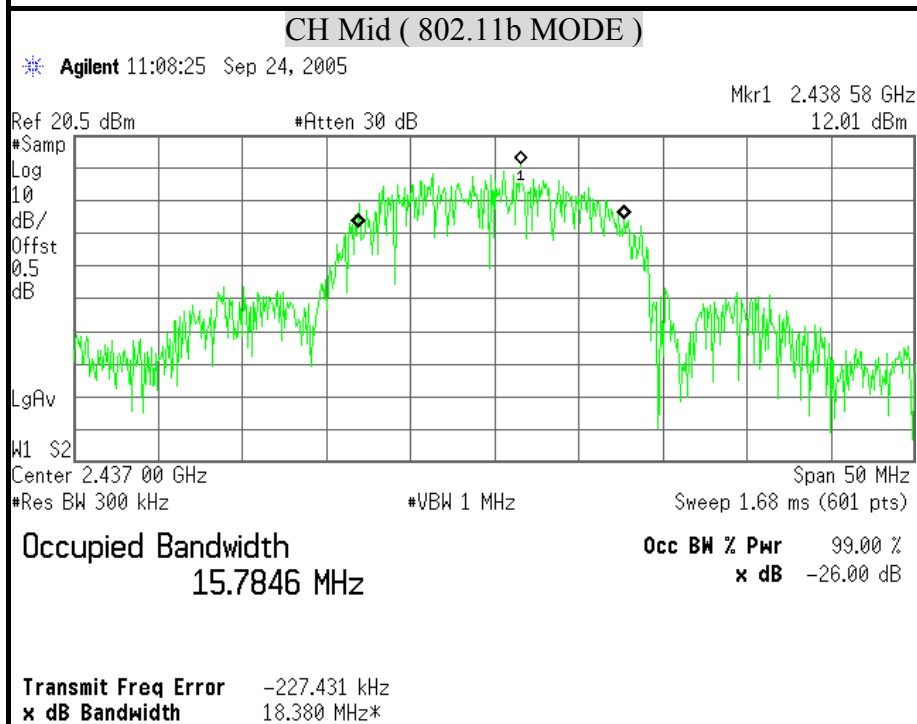
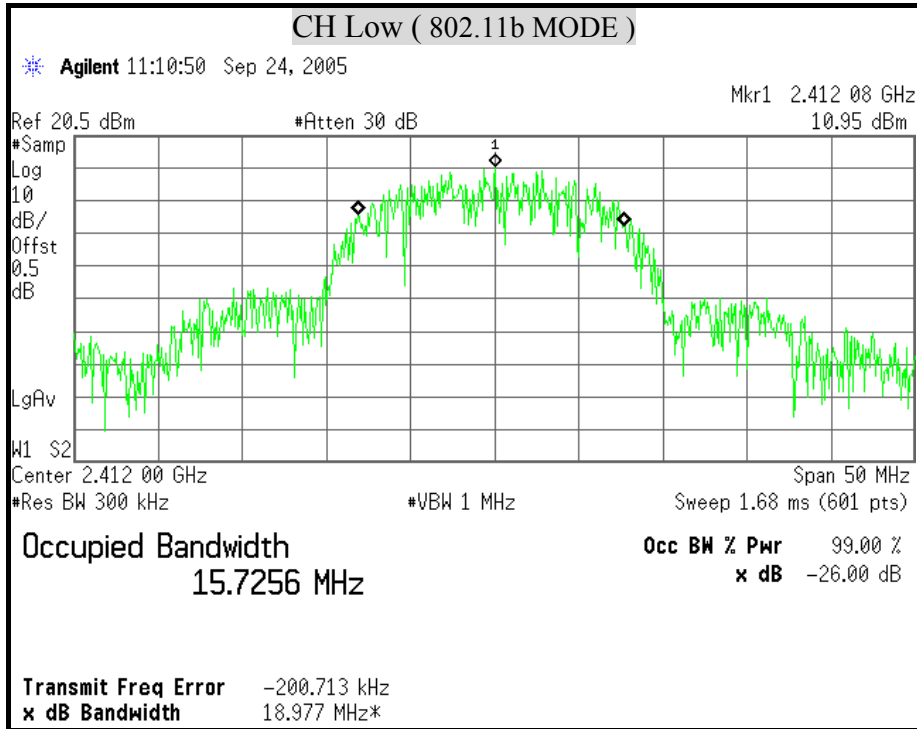

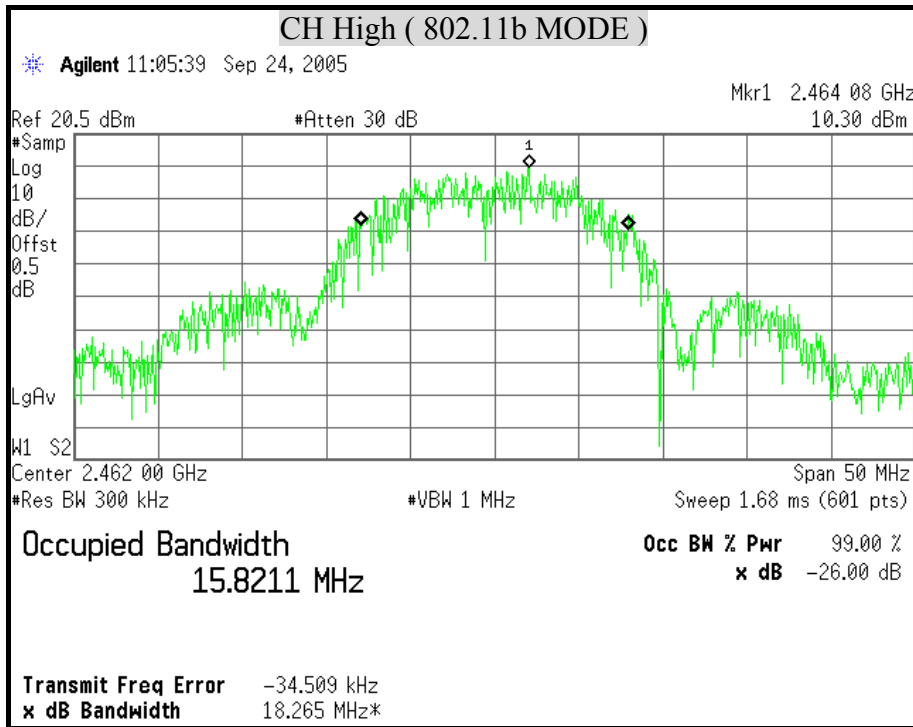



99% BANDWIDTH (802.11g MODE)

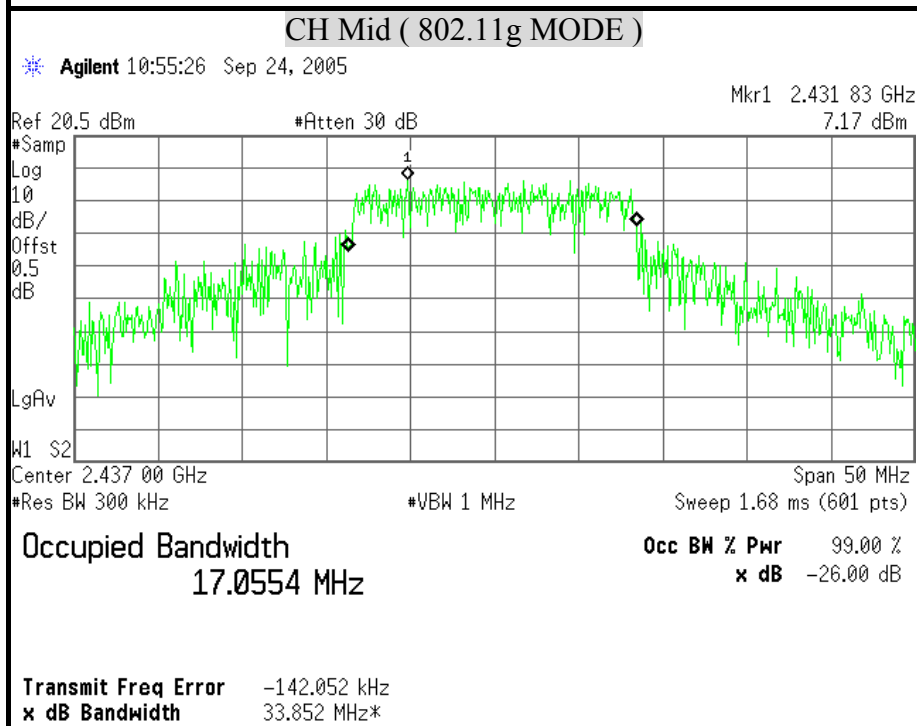
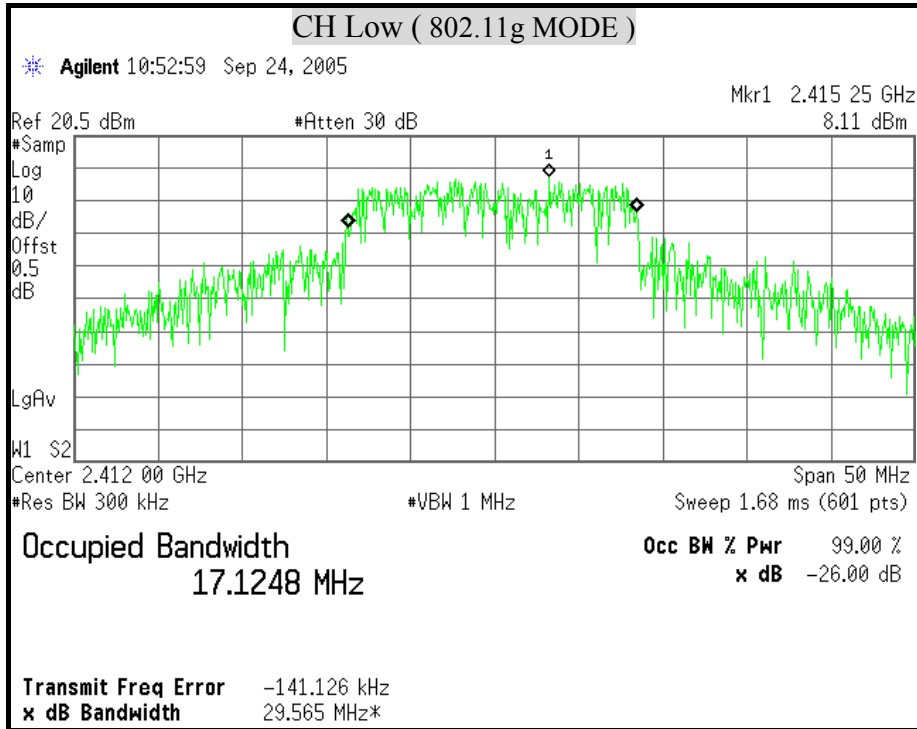

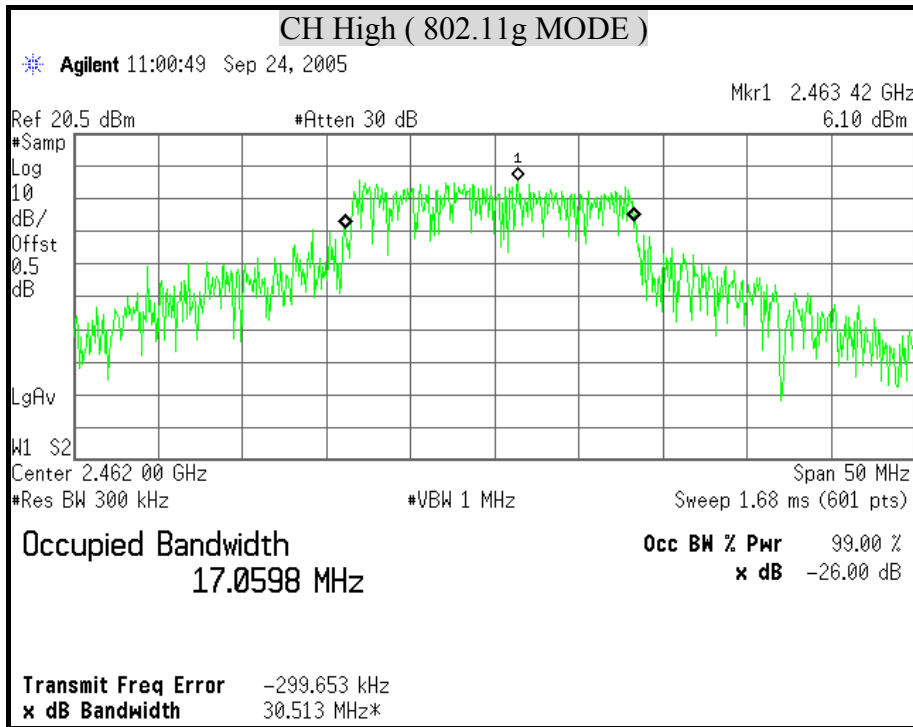



8.3 MAXIMUM PEAK OUTPUT POWER

LIMIT

§ 15.247(b) The maximum peak output power of the intentional radiator shall not exceed the following :

§ 15.247(b) (3) For systems using digital modulation in the 902-928 MHz, 2400-2483.5 MHz, and 5725-5850 MHz bands : 1 watt.

§ 15.247(b) (4) Except as shown in paragraphs (c) of this section , if transmitting antennas of directional gain greater than 6 dBi are used the peak output power from the intentional radiator shall be reduced below the stated values in paragraphs (b)(1) or (b)(2), and (b)(3) of this section , as appropriate, by the amount in dB that the directional gain of the antenna exceeds 6 dBi.

TEST EQUIPMENTS

Description & Manufacturer	Model No.	Serial No.	Date of Calibration
AGILENT SPECTRUM ANALYZER	E4446A	MY433601.32	January 26, 2005

TEST SETUP

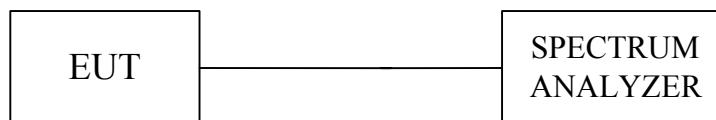

TEST PROCEDURE

- The spectrum shall be set as follows :
 - Span : 1.5 times channel integration bandwidth.
 - RBW : 1MHz
 - VBW : 3MHz
 - Detector : Peak
 - Sweep : Single trace
- Compute the combined power of all signal responses contained in the trace by covering all the data points.
- For 99% occupied BW, place the markers at the frequency at which 0.5% of the power lies to the right of the right marker and 0.5% of the power lies to the left of the left marker.
- The peak output power is the channel power integrated over 99% bandwidth.

**TEST RESULTS**

No non-compliance noted

IEEE 802.11b MODE

Channel	Channel Frequency (MHz)	Peak Power Output (dBm)	Peak Power Limit (dBm)	Pass / Fail
Low	2412	23.06	30	PASS
Middle	2437	22.72	30	PASS
High	2462	22.31	30	PASS

Remark:

1. At final test to get the worst-case emission at 11Mbps.

IEEE 802.11g MODE

Channel	Channel Frequency (MHz)	Peak Power Output (dBm)	Peak Power Limit (dBm)	Pass / Fail
Low	2412	23.06	30	PASS
Middle	2437	22.50	30	PASS
High	2462	22.00	30	PASS

Remark:

1. At final test to get the worst-case emission at 6Mbps.



MAXIMUM PEAK OUTPUT POWER (802.11b MODE)

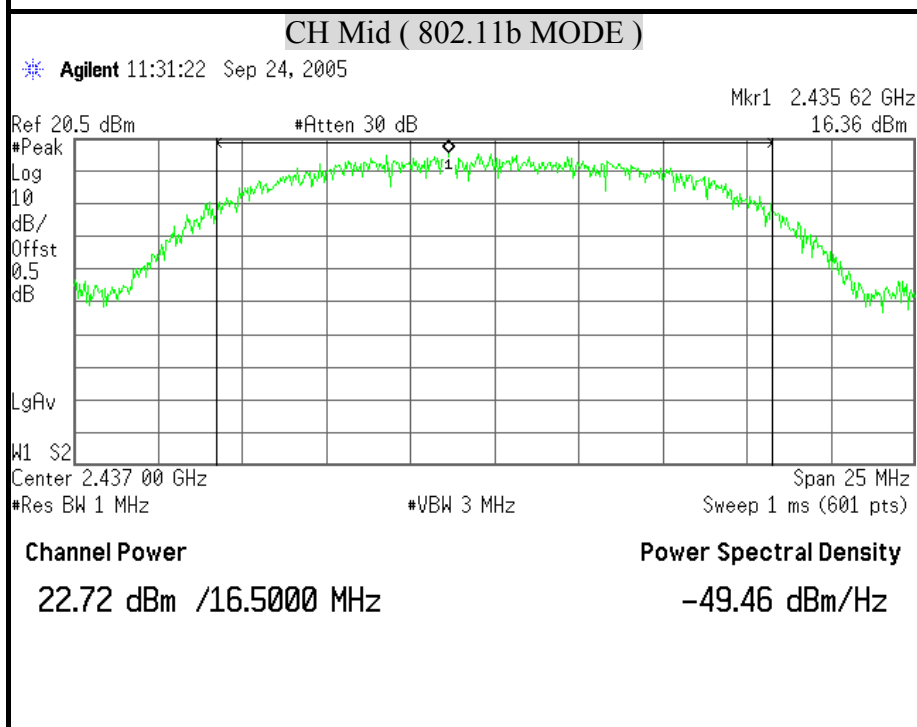
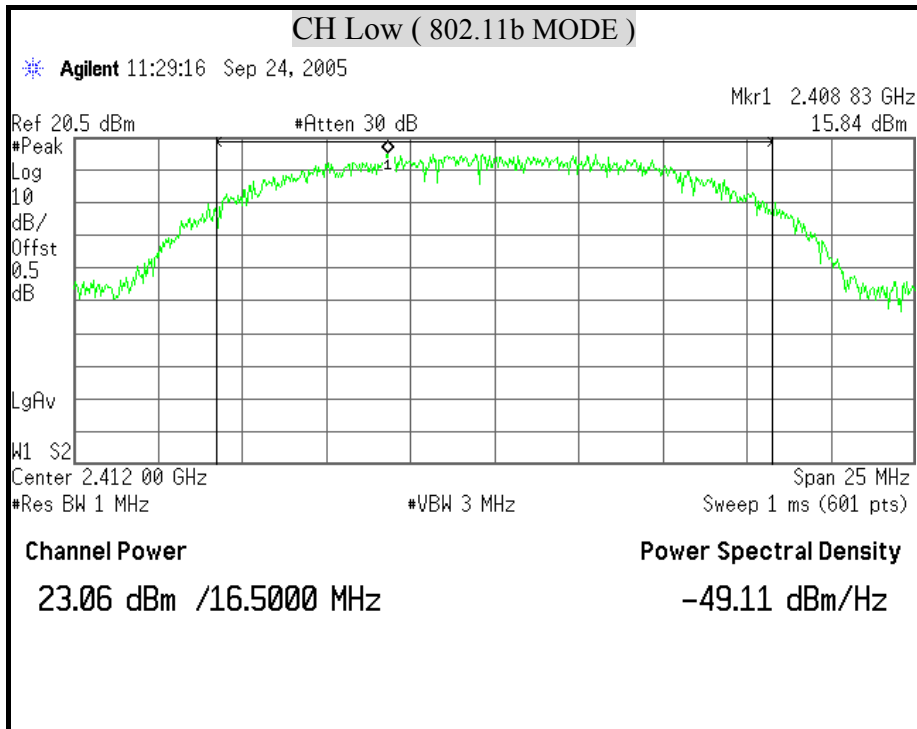

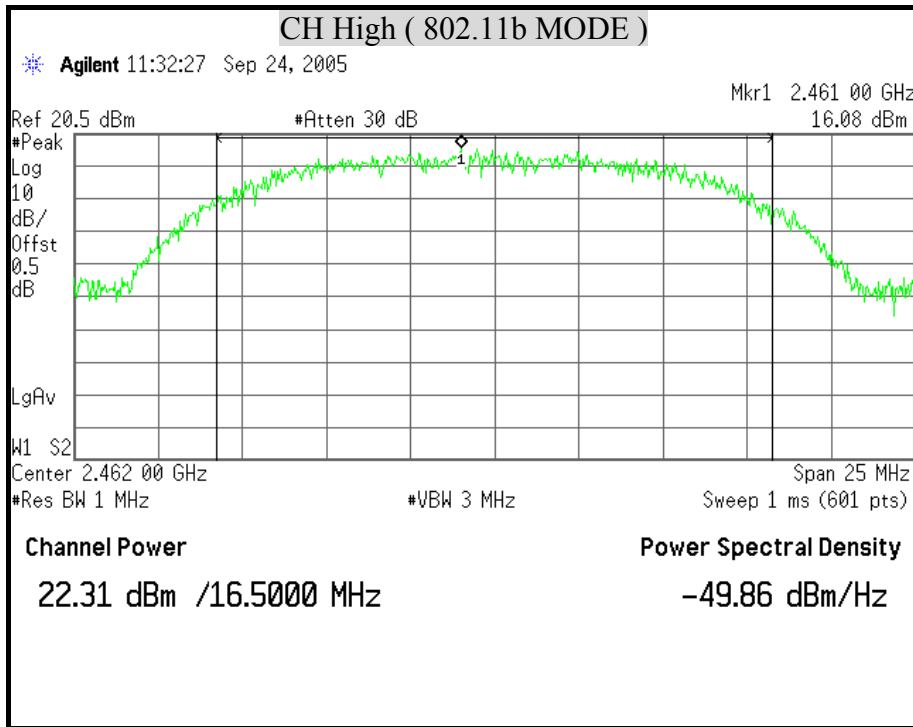



MAXIMUM PEAK OUTPUT POWER (802.11g MODE)

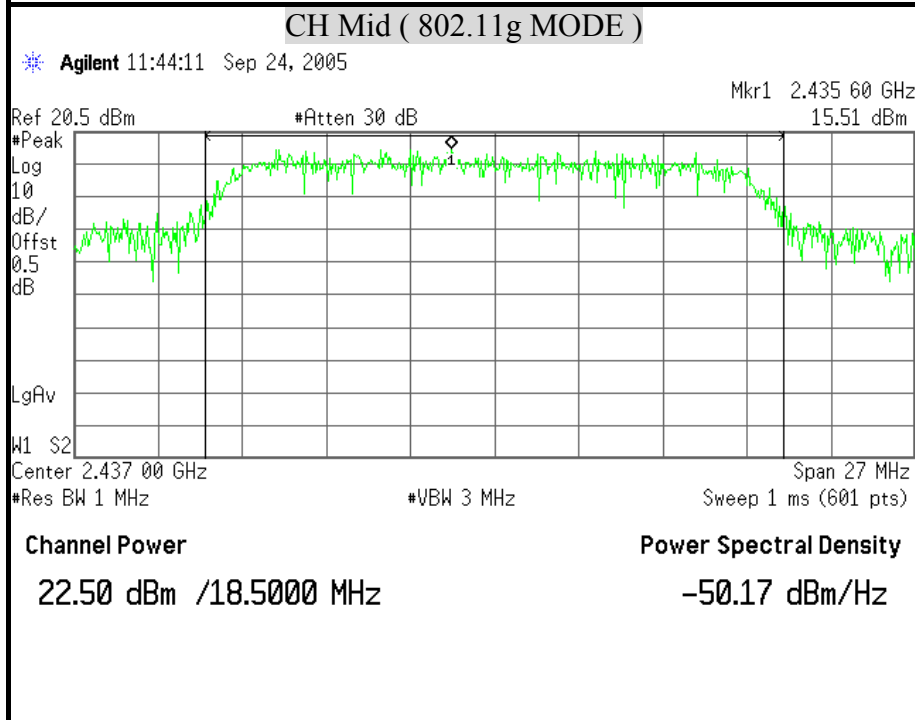
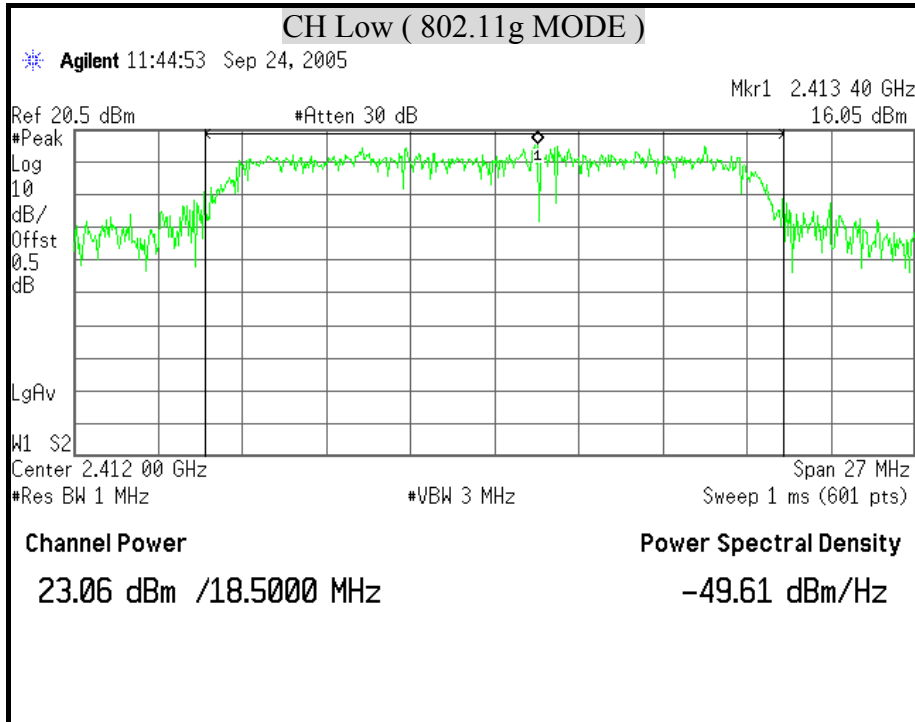

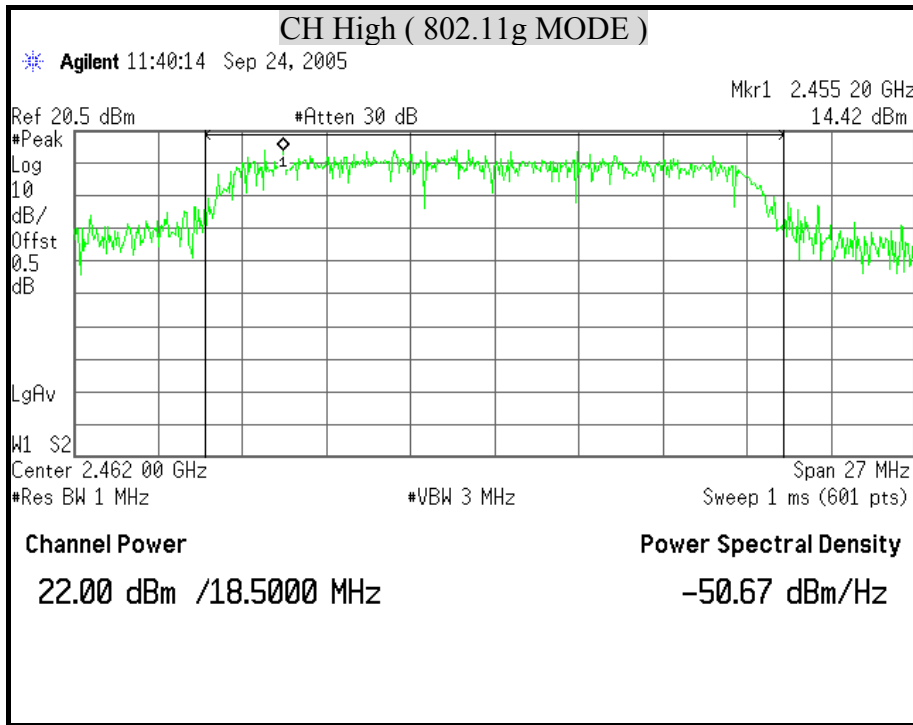



8.4 MAXIMUM PERMISSIBLE EXPOSURE

According to FCC 1.1310 : The criteria listed in the following table shall be used to evaluate the environment impact of human exposure to radio frequency (RF) radiation as specified in 1.1307(b) LIMITS FOR MAXIMUM PERMISSIBLE EXPOSURE (MPE)

Frequency Range (MHz)	Electric Field Strength (V/m)	Magnetic Field Strength (A/m)	Power Density (mW/cm ²)	Average Time
(A) Limits for Occupational / Control Exposures				
300-1,500	--	--	F/300	6
1,500-100,000	--	--	5	6
(B) Limits for General Population / Uncontrol Exposures				
300-1,500	--	--	F/1500	6
1,500-100,000	--	--	1	30

CALCULATIONS

$$\text{Given } E = \frac{\sqrt{30 \times P \times G}}{d} \quad \& \quad S = \frac{E^2}{3770}$$

Where E = Field strength in Volts / meter

P = Power in Watts

G = Numeric antenna gain

d = Distance in meters

S = Power density in milliwatts / square centimeter

Combining equations and re-arranging the terms to express the distance as a function of the remaining variables yields:

$$S = \frac{30 \times P \times G}{3770 d^2}$$

Changing to units of mW and cm, using:

$$P \text{ (mW)} = P \text{ (W)} / 1000 \text{ and}$$

$$d \text{ (cm)} = d \text{ (m)} / 100$$

Yields

$$S = \frac{30 \times (P/1000) \times G}{3770 \times (d/100)^2} = 0.0796 \times \frac{P \times G}{d^2}$$

Where d = Distance in cm

P = Power in mW

G = Numeric antenna gain

S = Power density in mW / cm²

**LIMIT**

Power Density Limit, $S=1.0\text{mW}/\text{cm}^2$

TEST RESULTS

No non-compliance noted

Mode	Minimum separation distance (cm)	Output Power (dBm)	Antenna Gain (dBi)	Power Density Limit (mW/cm^2)	Power Density at 20cm (mW/cm^2)
IEEE 802.11b	20.0	23.06	-1	1.00	0.031969
IEEE 802.11g	20.0	23.06	-1	1.00	0.031969

Remark: For mobile or fixed location transmitters, the maximum power density is $1.0\text{ mW}/\text{cm}^2$ even if the calculation indicates that the power density would be larger.



8.5 AVERAGE POWER

LIMIT

None; for reporting purposes only.

TEST EQUIPMENTS

Description & Manufacturer	Model No.	Serial No.	Date of Calibration
ANRITSU POWER METER	ML2487A MAL2491A	6K00001783 030982	March 02, 2005

TEST SETUP

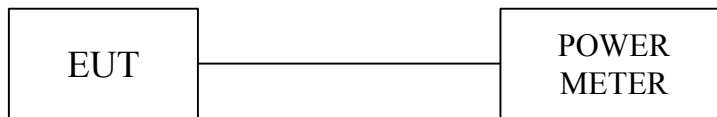

TEST PROCEDURE

The transmitter output is connected to a power meter.

**TEST RESULTS**

No non-compliance noted

IEEE 802.11b MODE

Channel	Channel Frequency (MHz)	Average Power (dBm)	Cable loss (dBm)	Average Power Output (dBm)
Low	2412	18.78	0.5	19.28
Middle	2437	18.54	0.5	19.04
High	2462	18.19	0.5	18.69

Remark:

1. At final test to get the worst-case emission at 11Mbps.
2. The result basic equation calculation as follow : $Average\ Power\ Output = Average\ Power\ Reading + Cable\ loss$

IEEE 802.11g MODE

Channel	Channel Frequency (MHz)	Average Power (dBm)	Cable loss (dBm)	Average Power Output (dBm)
Low	2412	18.03	0.5	18.53
Middle	2437	17.87	0.5	18.37
High	2462	17.10	0.5	17.60

Remark:

1. At final test to get the worst-case emission at 6Mbps.
2. The result basic equation calculation as follow : $Average\ Power\ Output = Average\ Power\ Reading + Cable\ loss$



8.6 POWER SPECTRAL DENSITY

LIMIT

§ 15.247(e) For digitally modulated systems, the power spectral density conducted from the intentional radiator to the antenna shall not greater than 8 dBm in any 3 kHz band during any time interval of continuous transmission.

TEST EQUIPMENTS

Description & Manufacturer	Model No.	Serial No.	Date of Calibration
AGILENT SPECTRUM ANALYZER	E4446A	MY433601.32	January 26, 2005

TEST SETUP

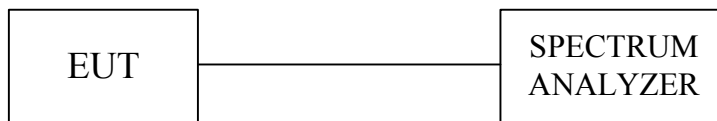

TEST PROCEDURE

The transmitter output was connected to the spectrum analyzer, the bandwidth of the fundamental frequency was measured with the spectrum analyzer using 3KHz RBW and 30KHz VBW, set sweep time=span / 3KHz.

The power spectral density was measured and recorded.

The sweep time is allowed to be longer than span / 3KHz for a full response of the mixer in the spectrum analyzer.

**TEST RESULTS**

No non-compliance noted

IEEE 802.11b MODE

Channel	Channel Frequency (MHz)	Final RF Power Level in 3KHz BW (dBm)	Maximum Limit (dBm)	Pass / Fail
Low	2412	-3.46	8	PASS
Middle	2437	-3.58	8	PASS
High	2462	-4.29	8	PASS

Remark:

1. At final test to get the worst-case emission at 11Mbps.

IEEE 802.11g MODE

Channel	Channel Frequency (MHz)	Final RF Power Level in 3KHz BW (dBm)	Maximum Limit (dBm)	Pass / Fail
Low	2412	-5.12	8	PASS
Middle	2437	-6.20	8	PASS
High	2462	-6.93	8	PASS

Remark:

1. At final test to get the worst-case emission at 6Mbps.



POWER SPECTRAL DENSITY (IEEE 802.11b MODE)

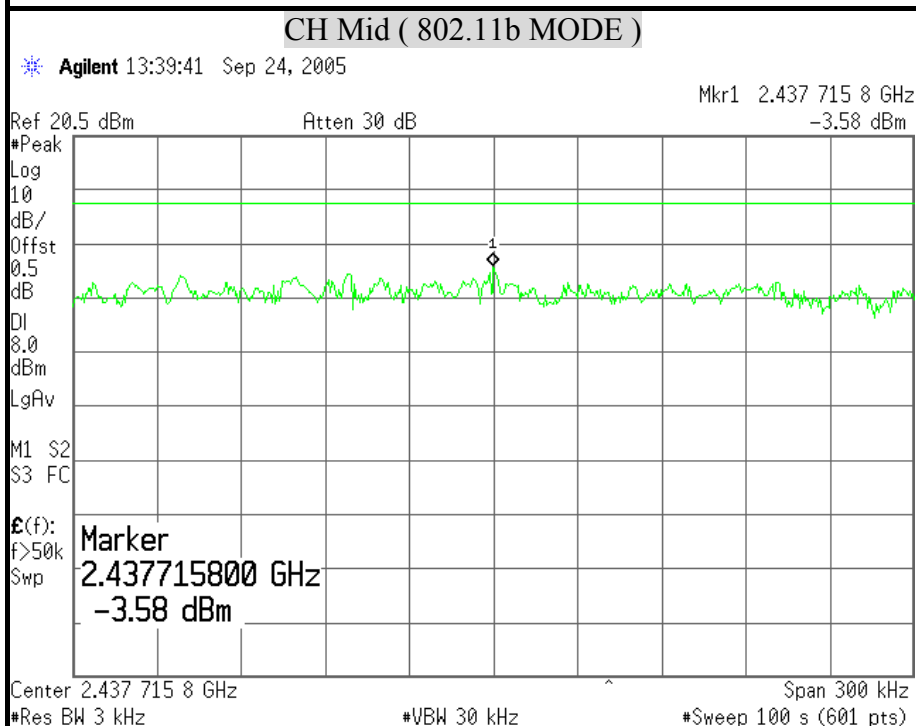
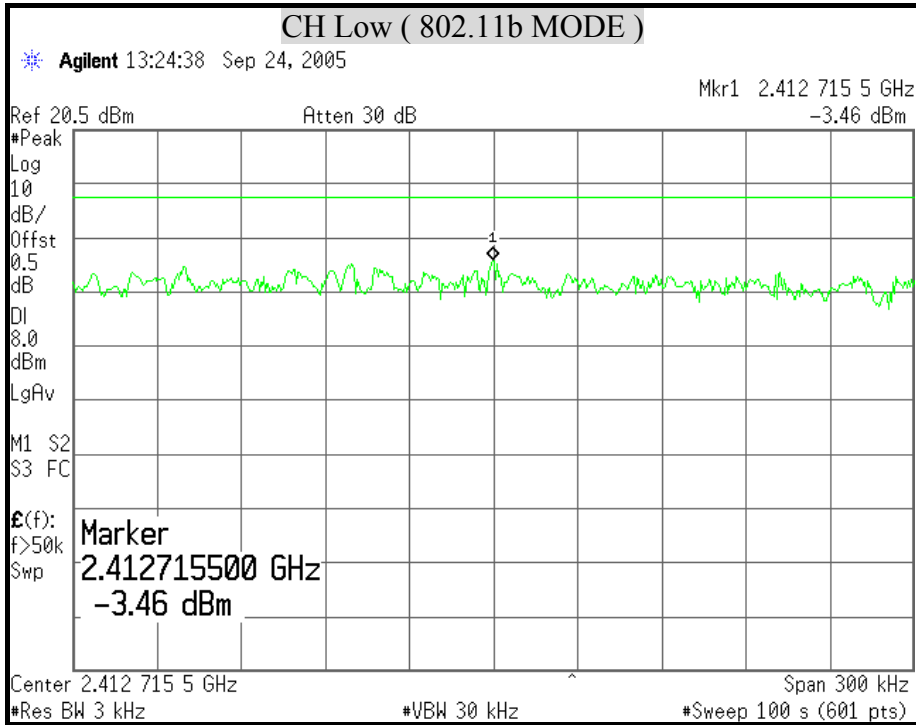

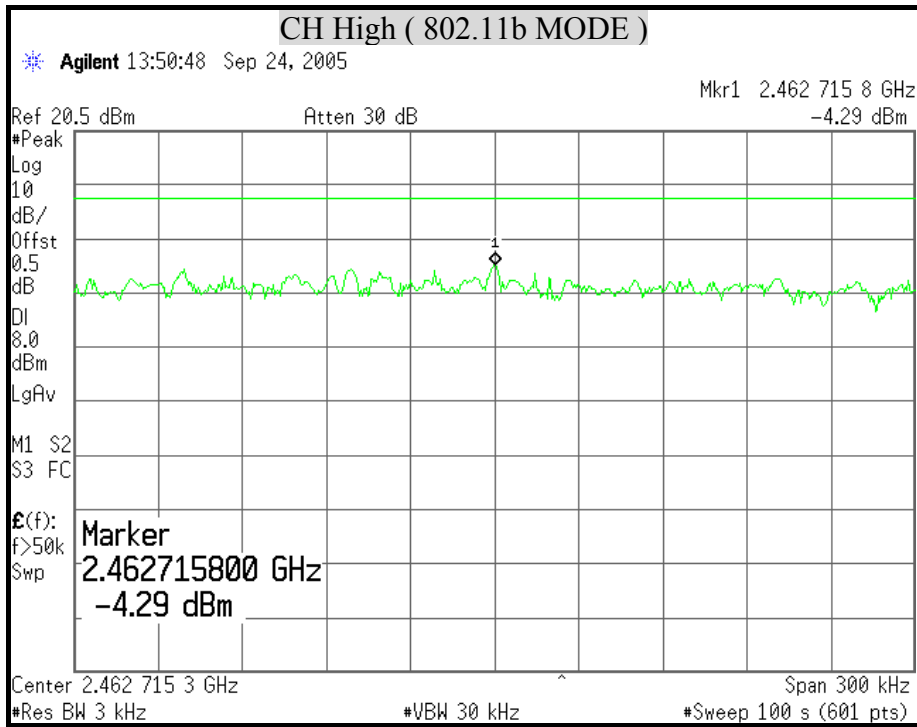



POWER SPECTRAL DENSITY (IEEE 802.11g MODE)

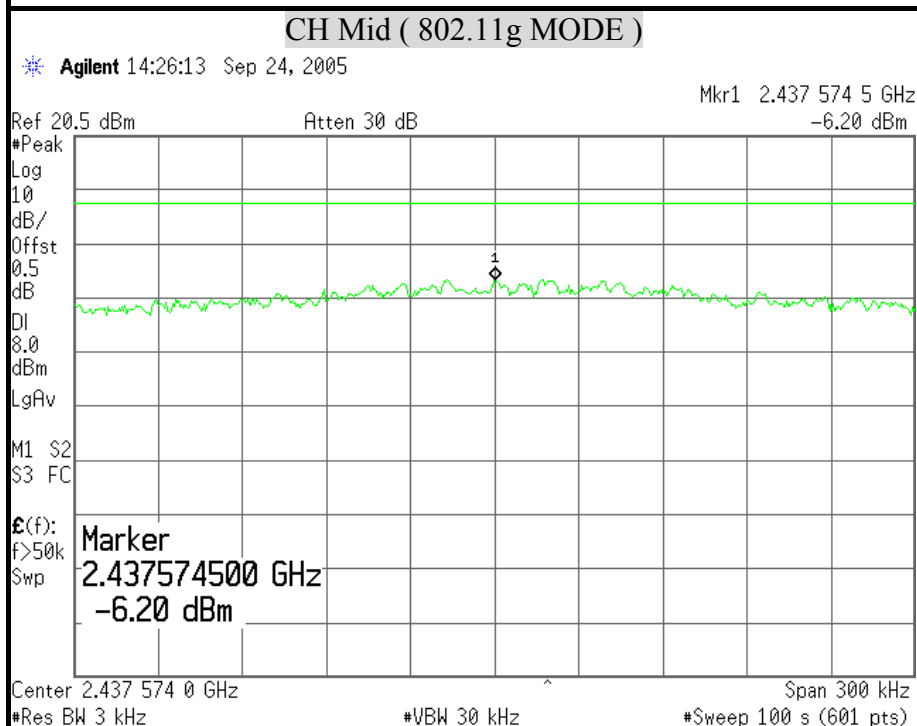
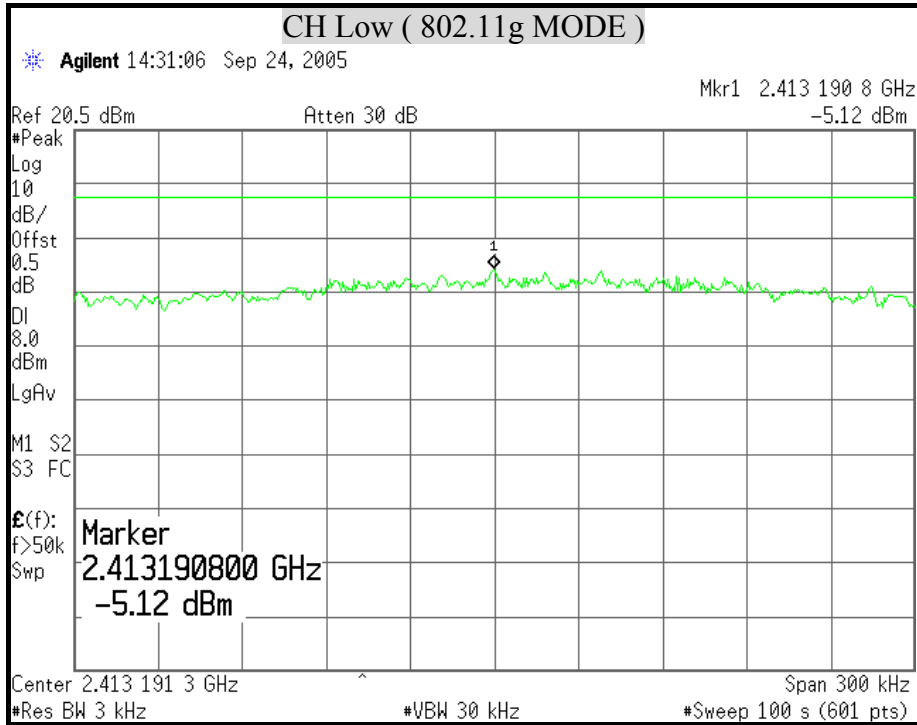

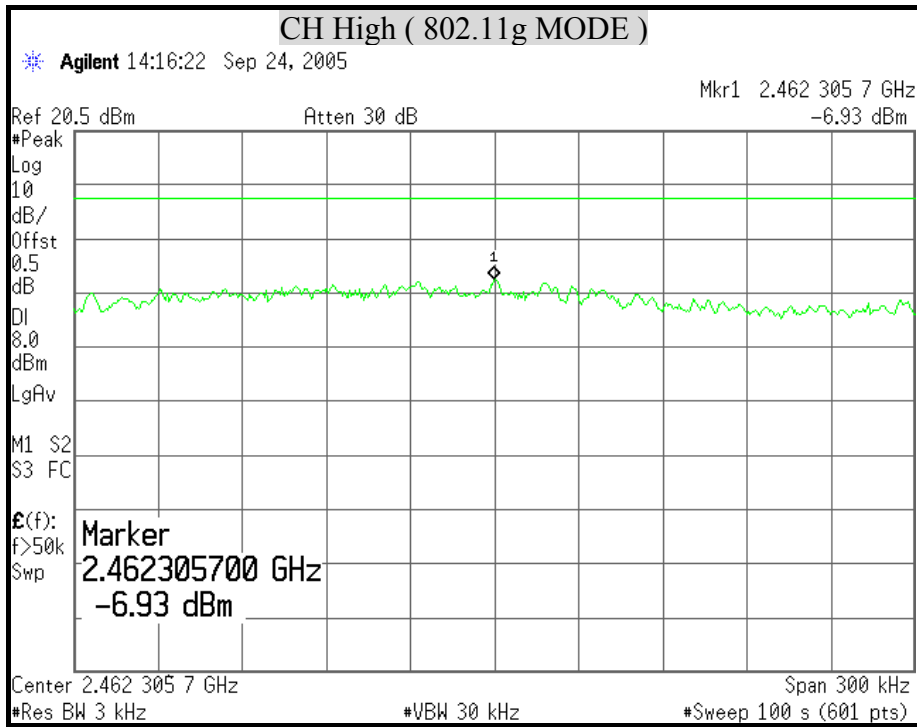



8.7 CONDUCTED SPURIOUS EMISSION

LIMITS

§ 15.247(d) In any 100 kHz bandwidth outside the frequency band in which the spread spectrum intentional radiator is operating, the radio frequency power that is produced by the intentional radiator shall be at least 20 dB below that in the 100 kHz bandwidth within the band that contains the highest level of the desired power, based on either an RF conducted or a radiated measurement. Attenuation below the general limits specified in § 15.209(a) is not required. In addition, radiated emissions which fall in the restricted bands, as defined in § 15.205(a), must also comply with the radiated emission limits specified in § 15.209(a) (see § 15.205(c)).

TEST PROCEDURE

The transmitter output is connected to a spectrum analyzer. The resolution bandwidth is set to 100 kHz. The video bandwidth is set to 300 kHz.

The spectrum from 30 MHz to 26.5 GHz is investigated with the transmitter set to the lowest, middle, and highest channels in the 2.4 GHz band.

TEST RESULTS

No non-compliance noted



OUT-OF-BAND SPURIOUS EMISSIONS-CONDUCTED MEASUREMENT (IEEE 802.11b MODE)

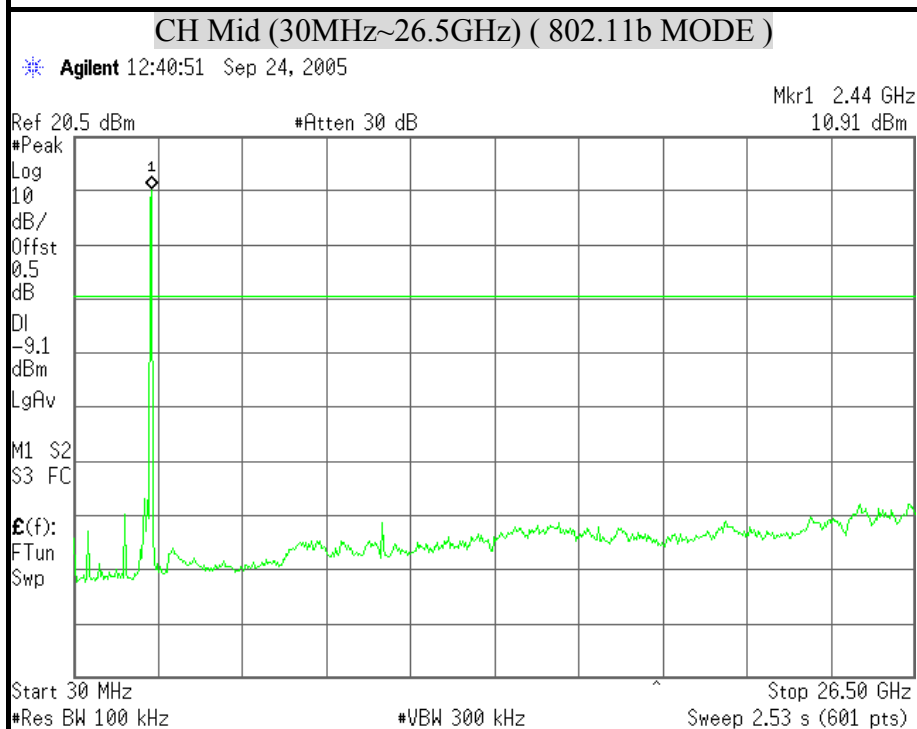
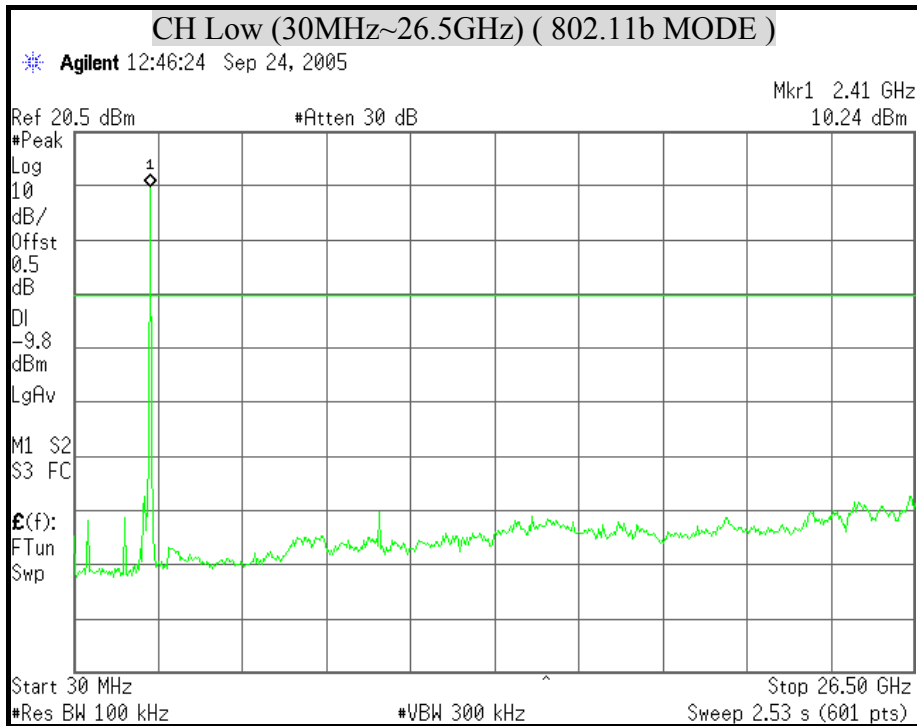

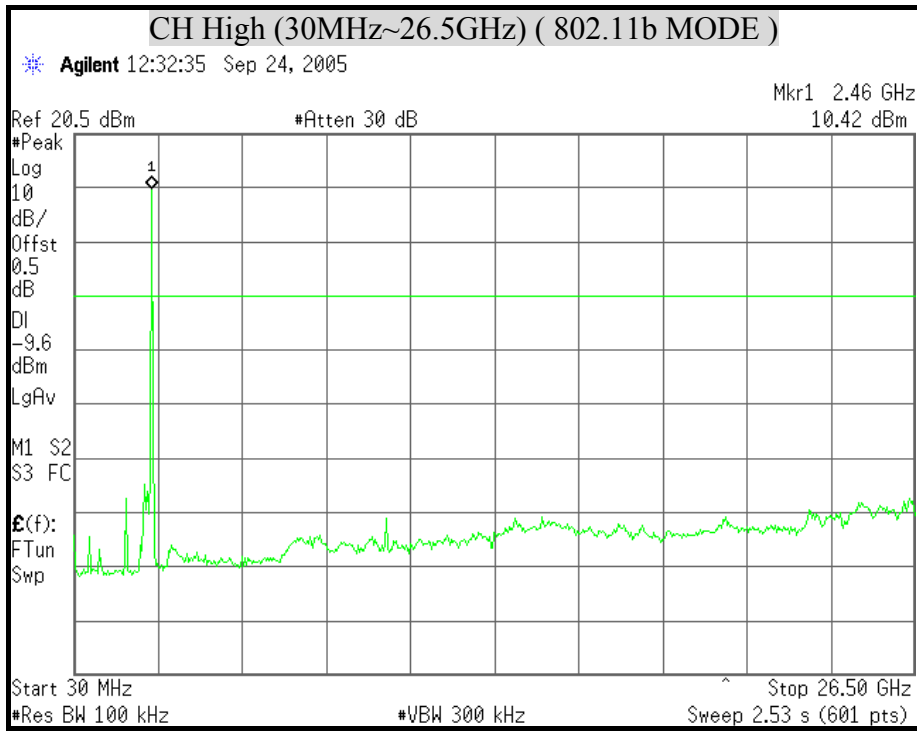



OUT-OF-BAND SPURIOUS EMISSIONS-CONDUCTED MEASUREMENT (IEEE 802.11g MODE)

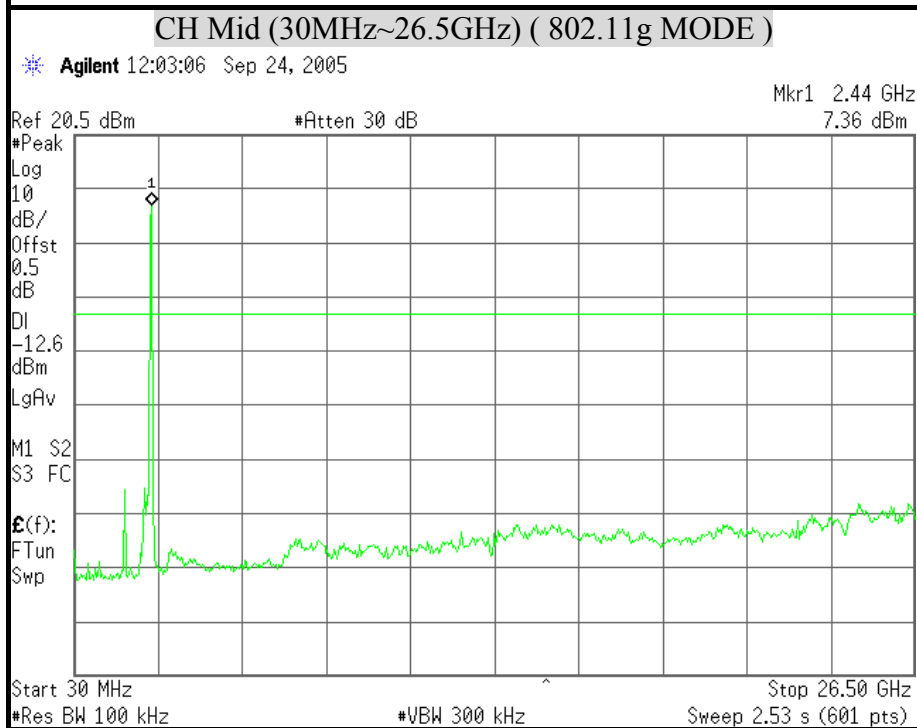
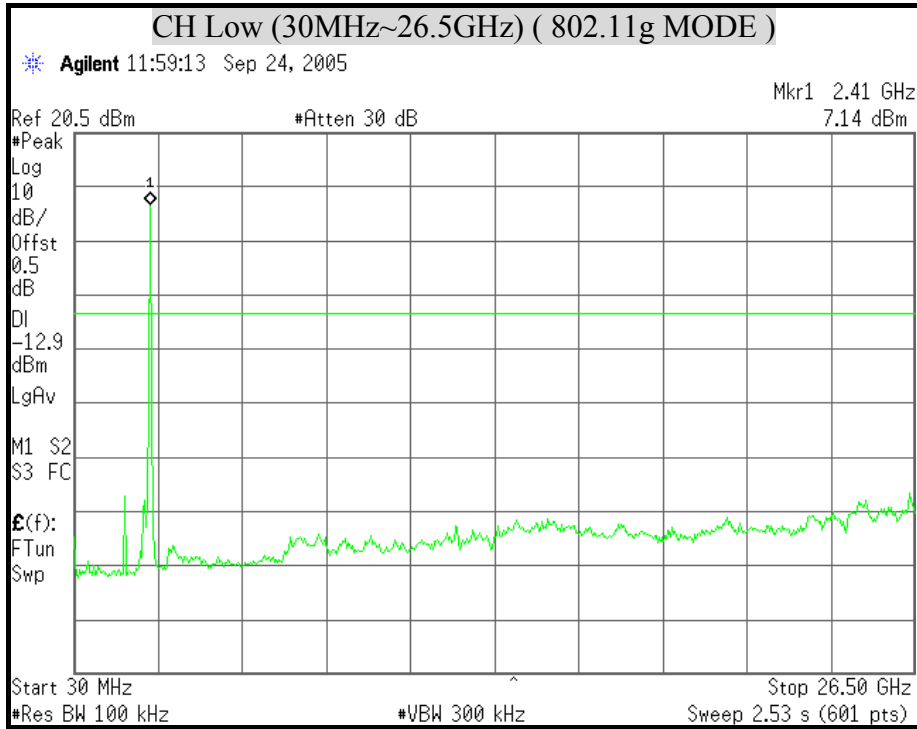

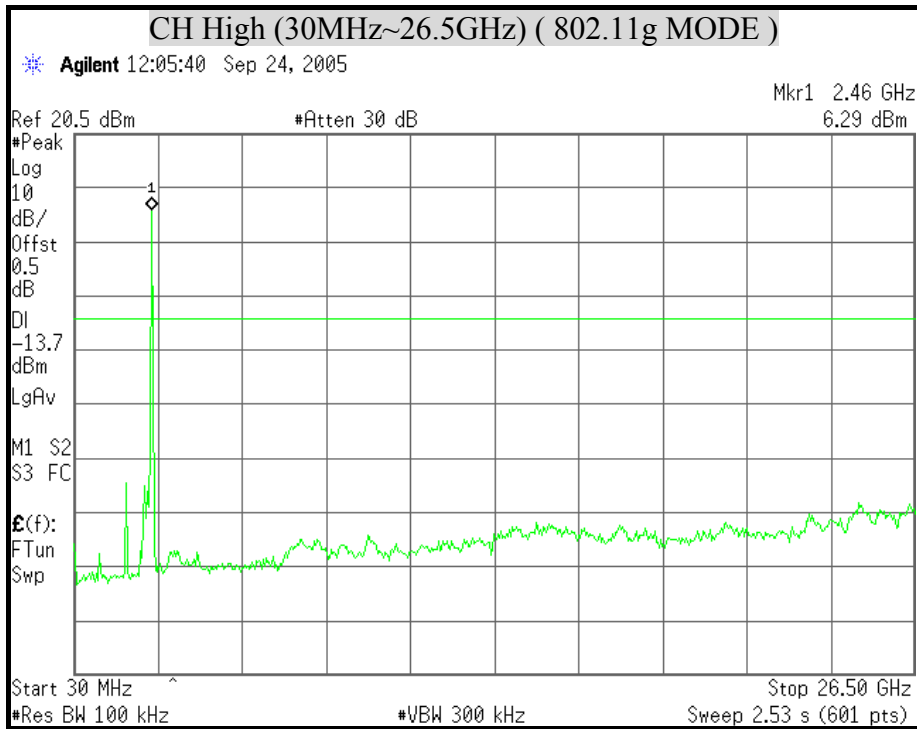



8.8 RADIATED EMISSIONS

8.8.1 TRANSMITTER RADIATED SUPURIOUS EMISSIONS

LIMITS

§ 15.205 (a) Except as shown in paragraph (d) of this section, only spurious emissions are permitted in any of the frequency bands listed below:

MHz	MHz	MHz	GHz
0.090 - 0.110	16.42 - 16.423	399.9 - 410	4.5 - 5.15
¹ 0.495 - 0.505	16.69475 - 16.69525	608 - 614	5.35 - 5.46
2.1735 - 2.1905	16.80425 - 16.80475	960 - 1240	7.25 - 7.75
4.125 - 4.128	25.5 - 25.67	1300 - 1427	8.025 - 8.5
4.17725 - 4.17775	37.5 - 38.25	1435 - 1626.5	9.0 - 9.2
4.20725 - 4.20775	73 - 74.6	1645.5 - 1646.5	9.3 - 9.5
6.215 - 6.218	74.8 - 75.2	1660 - 1710	10.6 - 12.7
6.26775 - 6.26825	108 - 121.94	1718.8 - 1722.2	13.25 - 13.4
6.31175 - 6.31225	123 - 138	2200 - 2300	14.47 - 14.5
8.291 - 8.294	149.9 - 150.05	2310 - 2390	15.35 - 16.2
8.362 - 8.366	156.52475 - 156.52525	2483.5 - 2500	17.7 - 21.4
8.37625 - 8.38675	156.7 - 156.9	2655 - 2900	22.01 - 23.12
8.41425 - 8.41475	162.0125 - 167.17	3260 - 3267	23.6 - 24.0
12.29 - 12.293	167.72 - 173.2	3332 - 3339	31.2 - 31.8
12.51975 - 12.52025	240 - 285	3345.8 - 3338	36.43 - 36.5
12.57675 - 12.57725	322 - 335.4	3600 - 4400	(²)
13.36 - 13.41			

¹ Until February 1, 1999, this restricted band shall be 0.490-0.510 MHz.

² Above 38.6

§ 15.205 (b) Except as provided in paragraphs (d) and (e), the field strength of emissions appearing within these frequency bands shall not exceed the limits shown in Section 15.209. At frequencies equal to or less than 1000 MHz, compliance with the limits in Section 15.209 shall be demonstrated using measurement instrumentation employing a CISPR quasi-peak detector. Above 1000 MHz, compliance with the emission limits in Section 15.209 shall be demonstrated based on the average value of the measured emissions. The provisions in Section 15.35 apply to these measurements.



§ 15.209 (a) Except as provided elsewhere in this Subpart, the emissions from an intentional radiator shall not exceed the field strength levels specified in the following table :

Frequency (MHz)	Field Strength (microvolts/meter)	Measurement Distance (meters)
30 - 88	100 **	3
88 - 216	150 **	3
216 - 960	200 **	3
Above 960	500	3

** Except as provided in paragraph (g), fundamental emissions from intentional radiators operating under this Section shall not be located in the frequency bands 54-72 MHz, 76-88 MHz, 174-216 MHz or 470-806 MHz, However, operation within these frequency bands is permitted under other sections of this Part, e-g, Sections 15.231 and 15.241.

§ 15.209 (b) In the emission table above, the tighter limit applies at the band edges.

TEST EQUIPMENTS

The following test equipments are utilized in making the measurements contained in this report.

Manufacturer or Type	Model No.	Serial No.	Date of Calibration	Calibration Period	Remark
CHASE BI-LOG ANTENNA	CBL6112B	2817	March 22, 2005	1 Year	FINAL
AGILENT SPECTRUM ANALYZER	E4446A	MY433601.32	January 26, 2005	1 Year	FINAL
R/S EMI TEST RECEIVER	ESCS30	835418/008	August 24, 2005	1 Year	FINAL
OPEN SITE	-----	No.2	May 07, 2005	1 Year	FINAL
N TYPE COAXIAL CABLE	CHA9525	4	June 03, 2005	1 Year	FINAL
Horn Antenna	AH-118	10089	August 10, 2005	1 Year	FINAL
HP Pre-amplifier	8449B	3008A01471	November 24, 2004	1 Year	FINAL
HP High pass filter	84300/80038	002	CAL. ON USE	1 Year	FINAL

TEST SETUP

The diagram below shows the test setup that is utilized to make the measurements for emission from 30 to 1GHz.

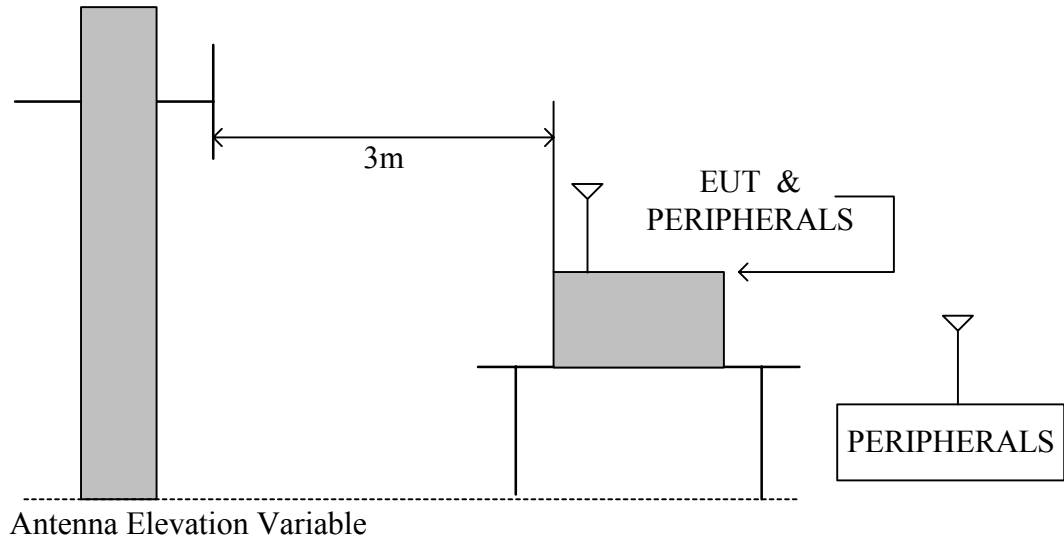

The diagram below shows the test setup that is utilized to make the measurements for emission above 1GHz.

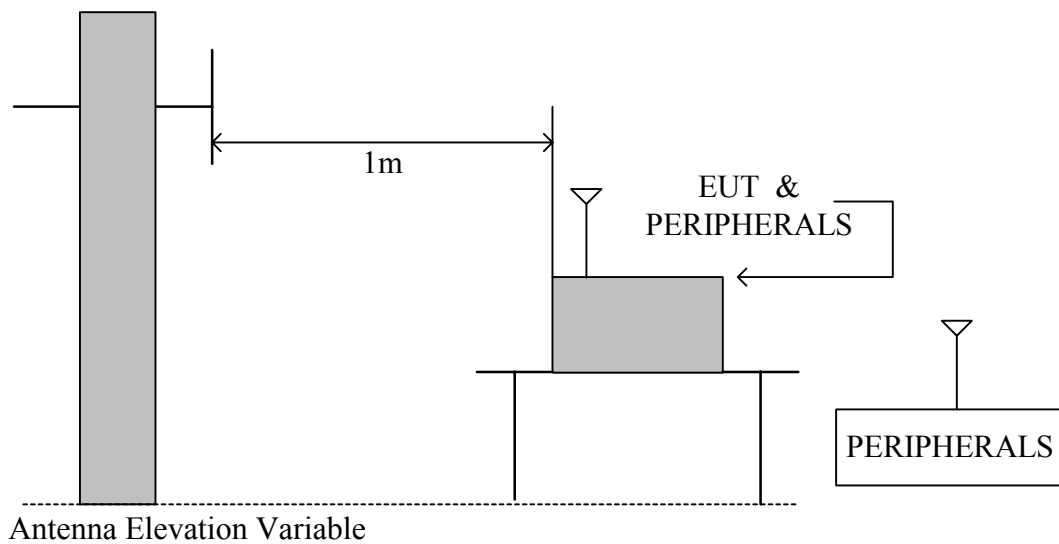



TEST PROCEDURE

- a. The EUT was placed on the top of a rotating table 0.8 meters above the ground at a 10 meter open area test site. The table was rotated 360 degrees to determine the position of the highest radiation.
- b. While measuring the radiated emission below 1GHz, the EUT was set 3 meters away from the interference-receiving antenna, which was mounted on the top of a variable-height antenna tower. While measuring the radiated emission above 1GHz, the EUT was set 1 meters away from the interference-receiving antenna
- c. The antenna is a broadband antenna, and its height is varied from one meter to four meters above the ground to determine the maximum value of the field strength. Both horizontal and vertical polarization of the antenna are set to make the measurement.
- d. For each suspected emission, the EUT was arranged to its worst case and then the antenna was tuned to heights from 1 meter to 4 meters and the table was turned from 0 degrees to 360 degrees to find the maximum reading.
- e. The test-receiver system was set to Peak Detect Function and Specified Bandwidth with Maximum Hold Mode.
- f. If the emission level of the EUT in peak mode was 10 dB lower than the limit specified, then testing could be stopped and the peak values of the EUT would be reported. Otherwise the emissions that did not have 10 dB margin would be re-tested one by one using peak, quasi-peak or average method as specified and then reported in a data sheet.

Note :

1. The resolution bandwidth and video bandwidth of test receiver/spectrum analyzer is 120 KHz for Peak detection (PK) and Quasi-peak detection (QP) at frequency below 1GHz.
2. The resolution bandwidth and video bandwidth of test receiver/spectrum analyzer is 1 MHz for Peak detection and frequency above 1GHz.
3. The resolution bandwidth of test receiver/spectrum analyzer is 1 MHz and the video bandwidth is 10 Hz for Average detection (AV) at frequency above 1GHz.

TEST RESULTS

No non-compliance noted

**8.8.2 WORST-CASE RADIATED EMISSION BELOW 1 GHz**

Product Name	802.11b/g Wireless mini-PCI Module	Test Date	2005/09/23
Model	XG-623	Test By	Alan Fan
Test Mode	Normal operating (worst case)	TEMP&Humidity	29.0°C, 53%

Frequency (MHz)	Antenna Factor (dB/m)	Cable Loss (dB)	Meter Reading at 3m(dBμV)		Limits (dBμV/m)	Emission Level at 3m(dBμV/m)	
			Horizontal	Vertical		Horizontal	Vertical
166.30	10.99	2.72	28.00	22.00	43.50	41.70	35.70
184.33	10.49	2.94	27.70	19.00	43.50	41.13	32.43
200.00	11.20	3.14	28.00	20.00	43.50	42.34	34.34
221.20	12.01	3.51	25.20	20.00	46.00	40.71	35.51
232.45	12.43	3.70	23.50	16.80	46.00	39.64	32.94
265.44	13.44	4.10	26.20	23.40	46.00	43.74	40.94
287.99	13.94	4.23	10.50	11.30	46.00	28.67	29.47
299.99	14.20	4.30	19.20	15.00	46.00	37.70	33.50
335.98	15.21	4.50	4.30	8.00	46.00	24.01	27.71
799.98	21.60	6.80	3.00	2.70	46.00	31.40	31.10

Remark: Emission level (dBμV/m) = Antenna Factor (dB/m) + Cable loss (dB) + Meter Reading (dBμV).

**8.8.3 TRANSMITTER RADIATED EMISSION ABOVE 1 GHz**

Product Name	802.11b/g Wireless mini-PCI Module	Test Date	2005/09/21
Model	XG-623	Test By	Alan Fan
Test Mode	IEEE 802.11b TX (CH Low)	TEMP&Humidity	27°C, 73%

Measurement Distance at 1m Horizontal polarity											
Freq. (MHz)	Reading (dBμV)	AF (dBμV)	Cable (dB)	Pre-amp (dB)	Dist (dB)	Filter (dB)	Level (dBμV/m)	Limit (dBμV/m)	Margin (dB)	Mark (P/Q/A)	Height (Meter)
3353.00	45.76	30.53	4.19	35.55	9.50	0.00	35.43	74.00	-38.57	P	1.00
3353.00	34.36	30.53	4.19	35.55	9.50	0.00	24.03	54.00	-29.97	A	1.00
4823.86	44.25	34.40	5.08	35.16	9.50	2.00	41.08	74.00	-32.92	P	1.00
4823.86	32.88	34.40	5.08	35.16	9.50	2.00	29.71	54.00	-24.29	A	1.00
12064.00	44.50	41.76	9.23	35.74	9.50	0.80	51.06	74.00	-22.94	P	1.00
12064.00	33.47	41.76	9.23	35.74	9.50	0.80	40.03	54.00	-13.97	A	1.00
Measurement Distance at 1m Vertical polarity											
Freq. (MHz)	Reading (dBμV)	AF (dBμV)	Cable (dB)	Pre-amp (dB)	Dist (dB)	Filter (dB)	Level (dBμV/m)	Limit (dBμV/m)	Margin (dB)	Mark (P/Q/A)	Height (Meter)
3353.00	52.28	30.53	4.19	35.55	9.50	0.00	41.95	74.00	-32.05	P	1.00
3353.00	42.26	30.53	4.19	35.55	9.50	0.00	31.93	54.00	-22.07	A	1.00
4823.86	47.36	34.40	5.08	35.16	9.50	2.00	44.19	74.00	-29.81	P	1.00
4823.86	36.55	34.40	5.08	35.16	9.50	2.00	33.38	54.00	-20.62	A	1.00
12064.00	45.55	41.76	9.23	35.74	9.50	0.80	52.11	74.00	-21.89	P	1.00
12064.00	38.01	41.76	9.23	35.74	9.50	0.80	44.57	54.00	-9.43	A	1.00

Remark:

1. AF: Antenna Factor, Cable: Cable Loss, Pre-Amp: Preamplifier gain, Filter: High Pass Filter Insertion Loss (3.5GHz)
2. Spectrum analyzer setting P(Peak): RBW=1MHz, VBW=1MHz, A(Average): RBW=1MHz, VBW=10Hz
3. Dist : correction to extra plate reading to 3m specification distance 1m measurement distance = -9.5dB
4. The result basic equation calculation is as follow:
Level = Reading + AF + Cable – Preamp + Filter – Dist, Margin = Level-Limit
5. The other emission levels were 20dB below the limit
6. The test limit distance is 3M limit.
7. At final test to get the worst-case emission at 11Mbps.



Product Name	802.11b/g Wireless mini-PCI Module	Test Date	2005/09/21
Model	XG-623	Test By	Alan Fan
Test Mode	IEEE 802.11b TX (CH Middle)	TEMP&Humidity	27°C, 73%

Measurement Distance at 1m Horizontal polarity											
Freq. (MHz)	Reading (dBμV)	AF (dBμV)	Cable (dB)	Pre-amp (dB)	Dist (dB)	Filter (dB)	Level (dBμV/m)	Limit (dBμV/m)	Margin (dB)	Mark (P/Q/A)	Height (Meter)
4873.87	48.80	34.57	5.10	35.20	9.50	1.80	45.58	74.00	-28.42	P	1.00
4873.87	40.12	34.57	5.10	35.20	9.50	1.80	36.90	54.00	-17.10	A	1.00
7312.00	49.57	39.59	6.79	35.64	9.50	2.00	52.81	74.00	-21.19	P	1.00
7312.00	42.16	39.59	6.79	35.64	9.50	2.00	45.40	54.00	-8.60	A	1.00
12183.08	48.20	41.88	9.25	35.62	9.50	0.80	55.02	74.00	-18.98	P	1.00
12183.08	41.31	41.88	9.25	35.62	9.50	0.80	48.13	54.00	-5.87	A	1.00
Measurement Distance at 1m Vertical polarity											
Freq. (MHz)	Reading (dBμV)	AF (dBμV)	Cable (dB)	Pre-amp (dB)	Dist (dB)	Filter (dB)	Level (dBμV/m)	Limit (dBμV/m)	Margin (dB)	Mark (P/Q/A)	Height (Meter)
4873.88	50.79	34.57	5.10	35.20	9.50	1.80	47.57	74.00	-26.43	P	1.00
4873.88	40.94	34.57	5.10	35.20	9.50	1.80	37.72	54.00	-16.28	A	1.00
7312.00	49.92	39.59	6.79	35.64	9.50	2.00	53.16	74.00	-20.84	P	1.00
7312.00	43.17	39.59	6.79	35.64	9.50	2.00	46.41	54.00	-7.59	A	1.00
12184.43	48.31	41.88	9.25	35.62	9.50	0.80	55.13	74.00	-18.87	P	1.00
12184.43	41.26	41.88	9.25	35.62	9.50	0.80	48.08	54.00	-5.92	A	1.00

Remark:

1. AF: Antenna Factor, Cable: Cable Loss, Pre-Amp: Preamplifier gain, Filter: High Pass Filter Insertion Loss (3.5GHz)
2. Spectrum analyzer setting P(Peak): RBW=1MHz, VBW=1MHz, A(Average): RBW=1MHz, VBW=10Hz
3. Dist : correction to extra plate reading to 3m specification distance 1m measurement distance = -9.5dB
4. The result basic equation calculation is as follow:

$$\text{Level} = \text{Reading} + \text{AF} + \text{Cable} - \text{Preamp} + \text{Filter} - \text{Dist}, \text{Margin} = \text{Level} - \text{Limit}$$
5. The other emission levels were 20dB below the limit
6. The test limit distance is 3M limit.
7. At final test to get the worst-case emission at 11Mbps.



Product Name	802.11b/g Wireless mini-PCI Module	Test Date	2005/09/21
Model	XG-623	Test By	Alan Fan
Test Mode	IEEE 802.11b TX (CH High)	TEMP&Humidity	27°C, 73%

Measurement Distance at 1m Horizontal polarity											
Freq. (MHz)	Reading (dBμV)	AF (dBμV)	Cable (dB)	Pre-amp (dB)	Dist (dB)	Filter (dB)	Level (dBμV/m)	Limit (dBμV/m)	Margin (dB)	Mark (P/Q/A)	Height (Meter)
4924.10	50.87	34.74	5.12	35.24	9.50	1.60	47.59	74.00	-26.41	P	1.00
4924.10	41.25	34.74	5.12	35.24	9.50	1.60	37.97	54.00	-16.03	A	1.00
7386.63	47.28	39.75	6.84	35.62	9.50	2.00	50.75	74.00	-23.25	P	1.00
7386.63	38.57	39.75	6.84	35.62	9.50	2.00	42.04	54.00	-11.96	A	1.00
12311.17	50.47	42.01	9.28	35.49	9.50	0.80	57.57	74.00	-16.43	P	1.00
12311.17	44.30	42.01	9.28	35.49	9.50	0.80	51.40	54.00	-2.60	A	1.00
Measurement Distance at 1m Vertical polarity											
Freq. (MHz)	Reading (dBμV)	AF (dBμV)	Cable (dB)	Pre-amp (dB)	Dist (dB)	Filter (dB)	Level (dBμV/m)	Limit (dBμV/m)	Margin (dB)	Mark (P/Q/A)	Height (Meter)
4923.93	53.84	34.74	5.12	35.24	9.50	1.60	50.56	74.00	-23.44	P	1.00
4923.93	44.22	34.74	5.12	35.24	9.50	1.60	40.94	54.00	-13.06	A	1.00
7384.50	47.75	39.75	6.84	35.62	9.50	2.00	51.21	74.00	-22.79	P	1.00
7384.50	41.20	39.75	6.84	35.62	9.50	2.00	44.66	54.00	-9.34	A	1.00
12310.00	47.86	42.01	9.28	35.49	9.50	0.80	54.96	74.00	-19.04	P	1.00
12310.00	41.54	42.01	9.28	35.49	9.50	0.80	48.64	54.00	-5.36	A	1.00

Remark:

1. AF: Antenna Factor, Cable: Cable Loss, Pre-Amp: Preamplifier gain, Filter: High Pass Filter Insertion Loss (3.5GHz)
2. Spectrum analyzer setting P(Peak): RBW=1MHz, VBW=1MHz, A(Average): RBW=1MHz, VBW=10Hz
3. Dist : correction to extra plate reading to 3m specification distance 1m measurement distance = -9.5dB
4. The result basic equation calculation is as follow:

$$\text{Level} = \text{Reading} + \text{AF} + \text{Cable} - \text{Preamp} + \text{Filter} - \text{Dist}, \text{Margin} = \text{Level} - \text{Limit}$$
5. The other emission levels were 20dB below the limit
6. The test limit distance is 3M limit.
7. At final test to get the worst-case emission at 11Mbps.



Product Name	802.11b/g Wireless mini-PCI Module	Test Date	2005/09/21
Model	XG-623	Test By	Alan Fan
Test Mode	IEEE 802.11g TX (CH Low)	TEMP&Humidity	27°C, 73%

Measurement Distance at 1m Horizontal polarity											
Freq. (MHz)	Reading (dBμV)	AF (dBμV)	Cable (dB)	Pre-amp (dB)	Dist (dB)	Filter (dB)	Level (dBμV/m)	Limit (dBμV/m)	Margin (dB)	Mark (P/Q/A)	Height (Meter)
3353.00	44.12	30.53	4.19	35.55	9.50	0.00	33.79	74.00	-40.21	P	1.00
3353.00	32.89	30.53	4.19	35.55	9.50	0.00	22.56	54.00	-31.44	A	1.00
4823.86	45.12	34.40	5.08	35.16	9.50	2.00	41.95	74.00	-32.05	P	1.00
4823.86	33.25	34.40	5.08	35.16	9.50	2.00	30.08	54.00	-23.92	A	1.00
12060.00	44.87	41.76	9.23	35.74	9.50	0.80	51.42	74.00	-22.58	P	1.00
12060.00	33.52	41.76	9.23	35.74	9.50	0.80	40.07	54.00	-13.93	A	1.00
Measurement Distance at 1m Vertical polarity											
Freq. (MHz)	Reading (dBμV)	AF (dBμV)	Cable (dB)	Pre-amp (dB)	Dist (dB)	Filter (dB)	Level (dBμV/m)	Limit (dBμV/m)	Margin (dB)	Mark (P/Q/A)	Height (Meter)
3353.00	51.23	30.53	4.19	35.55	9.50	0.00	40.90	74.00	-33.10	P	1.00
3353.00	40.25	30.53	4.19	35.55	9.50	0.00	29.92	54.00	-24.08	A	1.00
4823.86	45.81	34.40	5.08	35.16	9.50	2.00	42.64	74.00	-31.36	P	1.00
4823.86	36.74	34.40	5.08	35.16	9.50	2.00	33.57	54.00	-20.43	A	1.00
12060.00	44.25	41.76	9.23	35.74	9.50	0.80	50.80	74.00	-23.20	P	1.00
12060.00	35.87	41.76	9.23	35.74	9.50	0.80	42.42	54.00	-11.58	A	1.00

Remark:

1. AF: Antenna Factor, Cable: Cable Loss, Pre-Amp: Preamplifier gain, Filter: High Pass Filter Insertion Loss (3.5GHz)
2. Spectrum analyzer setting P(Peak): RBW=1MHz, VBW=1MHz, A(Average): RBW=1MHz, VBW=10Hz
3. Dist : correction to extra plate reading to 3m specification distance 1m measurement distance = -9.5dB
4. The result basic equation calculation is as follow:

$$\text{Level} = \text{Reading} + \text{AF} + \text{Cable} - \text{Preamp} + \text{Filter} - \text{Dist}, \text{Margin} = \text{Level} - \text{Limit}$$
5. The other emission levels were 20dB below the limit
6. The test limit distance is 3M limit.
7. At final test to get the worst-case emission at 6Mbps.



Product Name	802.11b/g Wireless mini-PCI Module	Test Date	2005/09/21
Model	XG-623	Test By	Alan Fan
Test Mode	IEEE 802.11g TX (CH Middle)	TEMP&Humidity	27°C, 73%

Measurement Distance at 1m Horizontal polarity											
Freq. (MHz)	Reading (dBμV)	AF (dBμV)	Cable (dB)	Pre-amp (dB)	Dist (dB)	Filter (dB)	Level (dBμV/m)	Limit (dBμV/m)	Margin (dB)	Mark (P/Q/A)	Height (Meter)
4875.95	46.57	34.58	5.10	35.20	9.50	1.80	43.34	74.00	-30.66	P	1.00
4875.95	37.04	34.58	5.10	35.20	9.50	1.80	33.81	54.00	-20.19	A	1.00
7301.58	51.33	39.56	6.79	35.64	9.50	2.00	54.54	74.00	-19.46	P	1.00
7301.58	41.53	39.56	6.79	35.64	9.50	2.00	44.74	54.00	-9.26	A	1.00
12178.33	46.73	41.88	9.25	35.62	9.50	0.80	53.54	74.00	-20.46	P	1.00
12178.33	37.43	41.88	9.25	35.62	9.50	0.80	44.24	54.00	-9.76	A	1.00
Measurement Distance at 1m Vertical polarity											
Freq. (MHz)	Reading (dBμV)	AF (dBμV)	Cable (dB)	Pre-amp (dB)	Dist (dB)	Filter (dB)	Level (dBμV/m)	Limit (dBμV/m)	Margin (dB)	Mark (P/Q/A)	Height (Meter)
4874.08	50.22	34.57	5.10	35.20	9.50	1.80	47.00	74.00	-27.00	P	1.00
4874.08	41.68	34.57	5.10	35.20	9.50	1.80	38.46	54.00	-15.54	A	1.00
7311.77	50.65	39.59	6.79	35.64	9.50	2.00	53.89	74.00	-20.11	P	1.00
7311.77	41.76	39.59	6.79	35.64	9.50	2.00	45.00	54.00	-9.00	A	1.00
12185.00	51.29	41.89	9.25	35.62	9.50	0.80	58.11	74.00	-15.89	P	1.00
12185.00	40.73	41.89	9.25	35.62	9.50	0.80	47.55	54.00	-6.45	A	1.00

Remark:

1. AF: Antenna Factor, Cable: Cable Loss, Pre-Amp: Preamplifier gain, Filter: High Pass Filter Insertion Loss (3.5GHz)
2. Spectrum analyzer setting P(Peak): RBW=1MHz, VBW=1MHz, A(Average): RBW=1MHz, VBW=10Hz
3. Dist : correction to extra plate reading to 3m specification distance 1m measurement distance = -9.5dB
4. The result basic equation calculation is as follow:

$$\text{Level} = \text{Reading} + \text{AF} + \text{Cable} - \text{Preamp} + \text{Filter} - \text{Dist}, \text{Margin} = \text{Level} - \text{Limit}$$
5. The other emission levels were 20dB below the limit
6. The test limit distance is 3M limit.
7. At final test to get the worst-case emission at 6Mbps.



Product Name	802.11b/g Wireless mini-PCI Module	Test Date	2005/09/21
Model	XG-623	Test By	Alan Fan
Test Mode	IEEE 802.11g TX (CH High)	TEMP&Humidity	27°C, 73%

Measurement Distance at 1m Horizontal polarity											
Freq. (MHz)	Reading (dBμV)	AF (dBμV)	Cable (dB)	Pre-amp (dB)	Dist (dB)	Filter (dB)	Level (dBμV/m)	Limit (dBμV/m)	Margin (dB)	Mark (P/Q/A)	Height (Meter)
4923.08	47.02	34.74	5.12	35.24	9.50	1.61	43.74	74.00	-30.26	P	1.00
4923.08	40.52	34.74	5.12	35.24	9.50	1.61	37.24	54.00	-16.76	A	1.00
7377.83	44.77	39.73	6.84	35.62	9.50	2.00	48.21	74.00	-25.79	P	1.09
7377.83	38.02	39.73	6.84	35.62	9.50	2.00	41.46	54.00	-12.54	A	1.09
12301.67	43.58	42.00	9.27	35.50	9.50	0.80	50.66	74.00	-23.34	P	1.00
12301.67	38.43	42.00	9.27	35.50	9.50	0.80	45.51	54.00	-8.49	A	1.00
Measurement Distance at 1m Vertical polarity											
Freq. (MHz)	Reading (dBμV)	AF (dBμV)	Cable (dB)	Pre-amp (dB)	Dist (dB)	Filter (dB)	Level (dBμV/m)	Limit (dBμV/m)	Margin (dB)	Mark (P/Q/A)	Height (Meter)
4921.25	54.20	34.73	5.11	35.24	9.50	1.62	50.93	74.00	-23.07	P	1.14
4921.25	46.47	34.73	5.11	35.24	9.50	1.62	43.20	54.00	-10.80	A	1.14
7377.85	44.52	39.73	6.84	35.62	9.50	2.00	47.96	74.00	-26.04	P	1.13
7377.85	38.92	39.73	6.84	35.62	9.50	2.00	42.36	54.00	-11.64	A	1.13
12297.70	46.18	42.00	9.27	35.50	9.50	0.80	53.25	74.00	-20.75	P	1.04
12297.70	40.76	42.00	9.27	35.50	9.50	0.80	47.83	54.00	-6.17	A	1.04

Remark:

1. AF: Antenna Factor, Cable: Cable Loss, Pre-Amp: Preamplifier gain, Filter: High Pass Filter Insertion Loss (3.5GHz)
2. Spectrum analyzer setting P(Peak): RBW=1MHz, VBW=1MHz, A(Average): RBW=1MHz, VBW=10Hz
3. Dist : correction to extra plate reading to 3m specification distance 1m measurement distance = -9.5dB
4. The result basic equation calculation is as follow:

$$\text{Level} = \text{Reading} + \text{AF} + \text{Cable} - \text{Preamp} + \text{Filter} - \text{Dist}, \text{Margin} = \text{Level} - \text{Limit}$$
5. The other emission levels were 20dB below the limit
6. The test limit distance is 3M limit.
7. At final test to get the worst-case emission at 6Mbps.



8.8.4 RESTRICTED BAND EDGES

Detector mode : Peak

Polarity : Horizontal

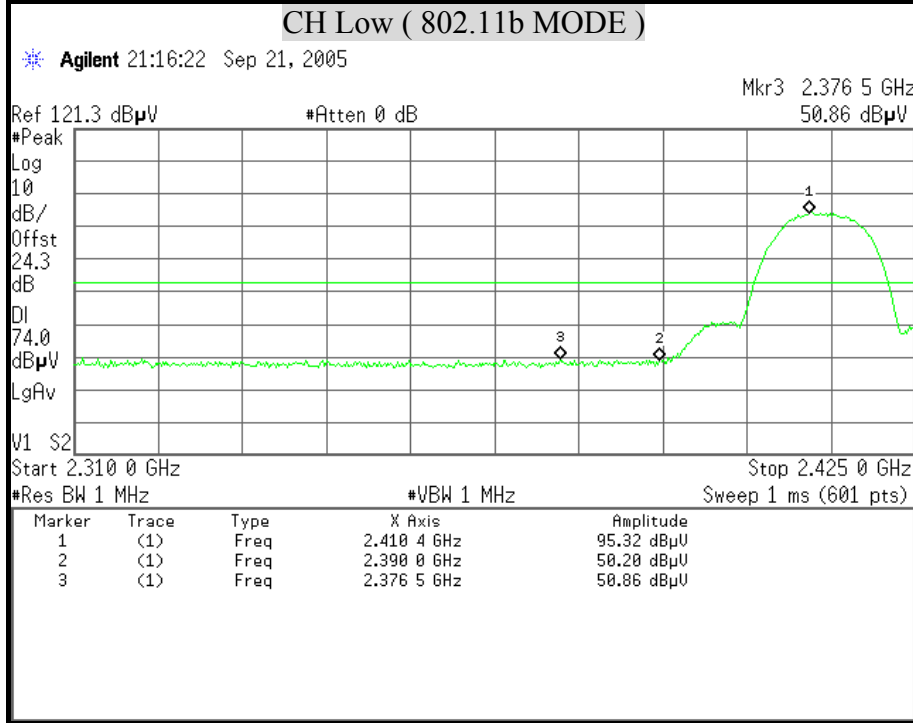

Detector mode : Average

Polarity : Horizontal

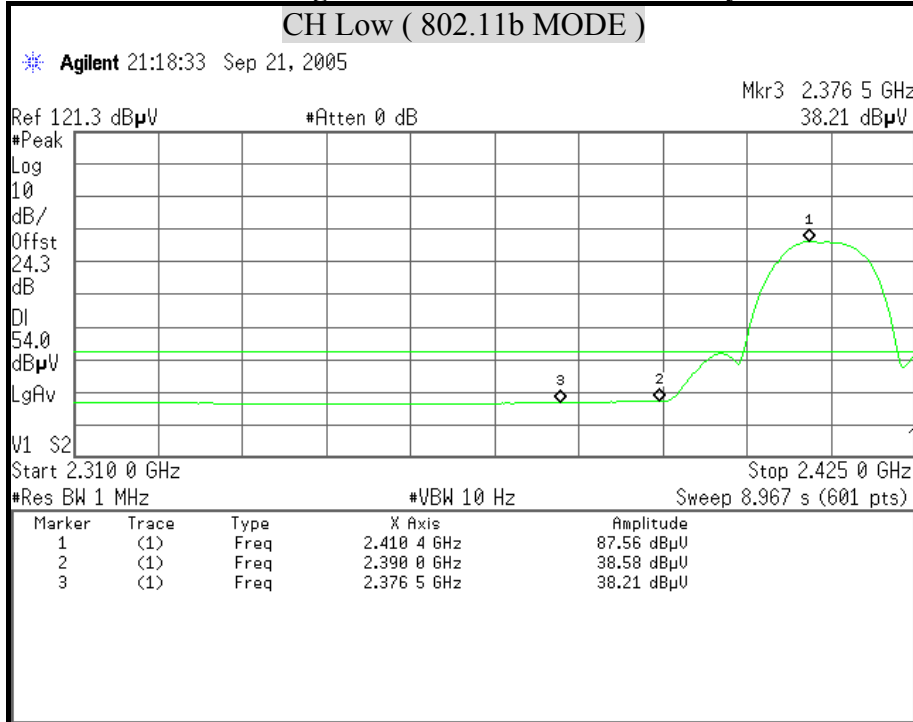



Detector mode : Peak

Polarity : Vertical

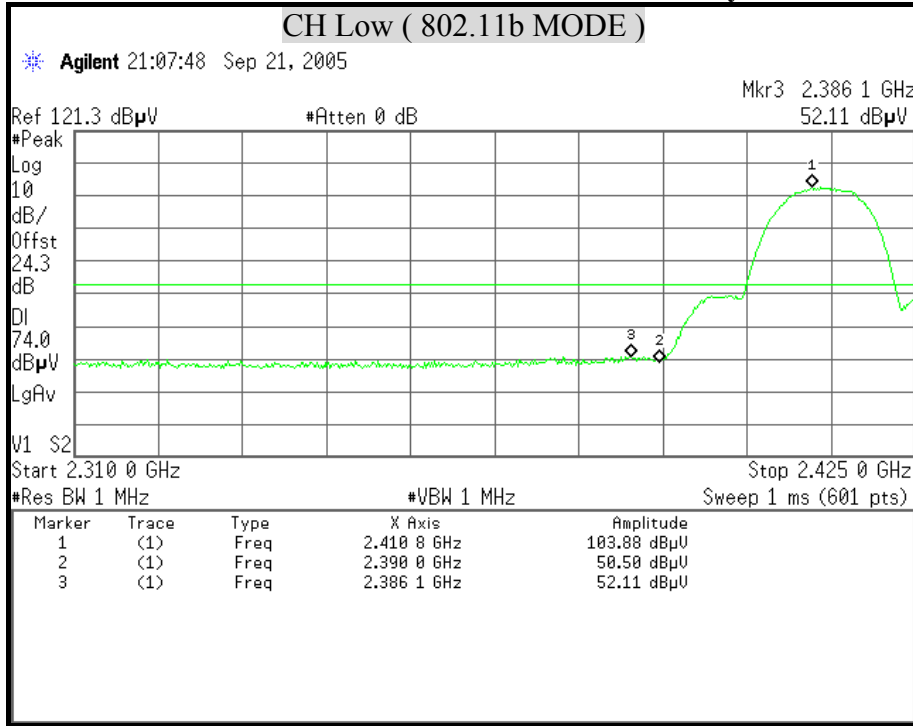

Detector mode : Average

Polarity : Vertical

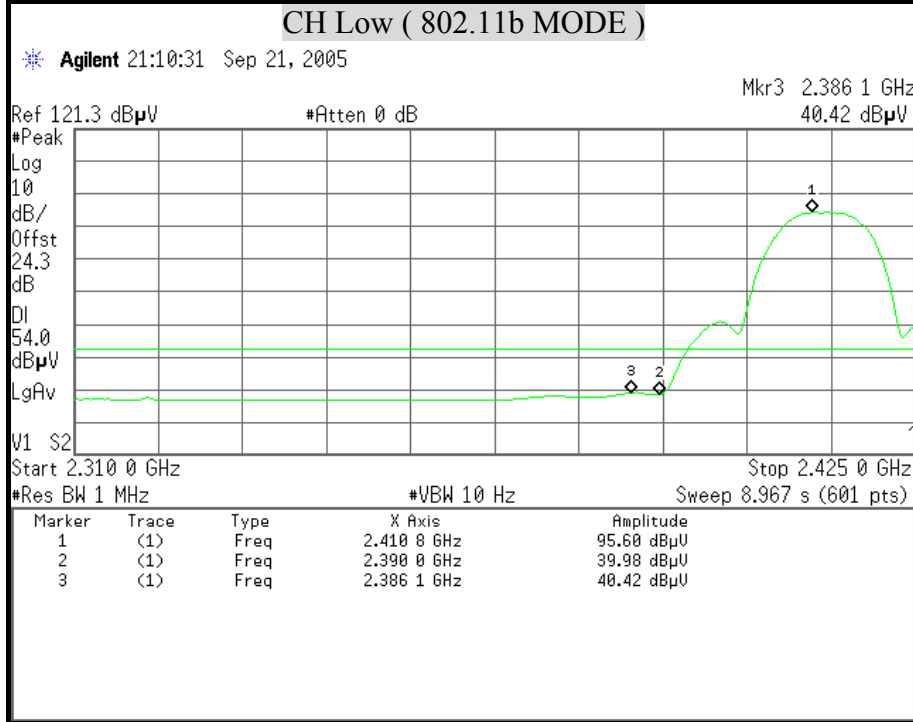



Detector mode : Peak

Polarity : Horizontal

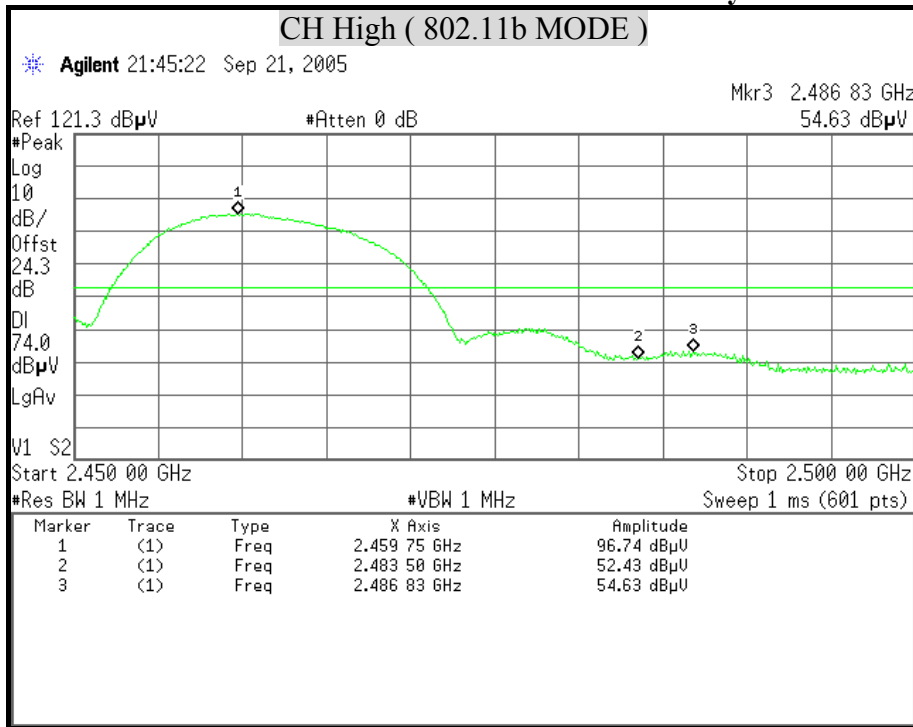

Detector mode : Average

Polarity : Horizontal

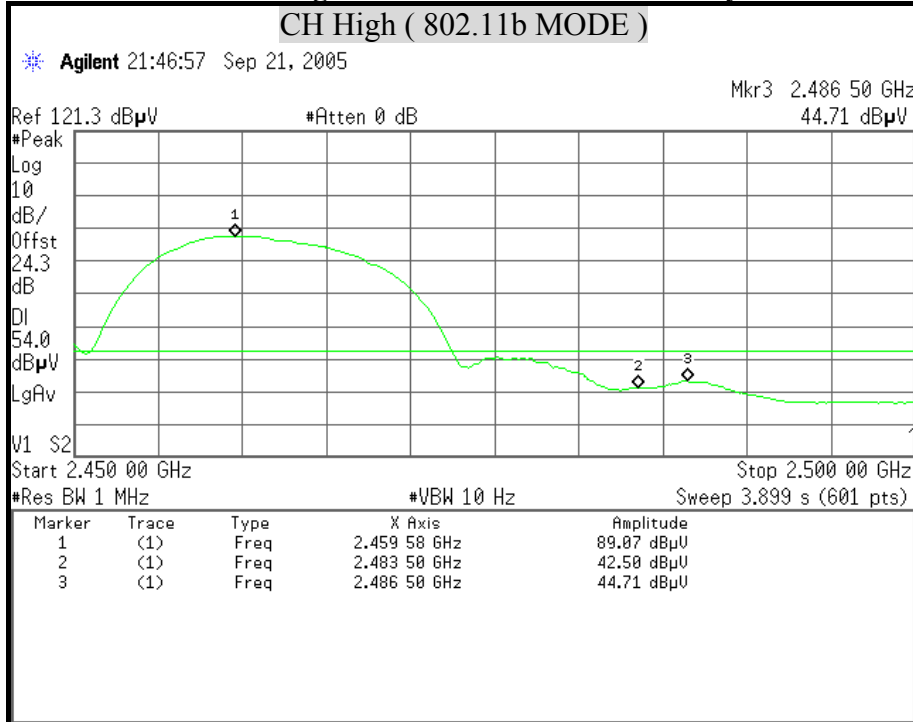



Detector mode : Peak

Polarity : Vertical

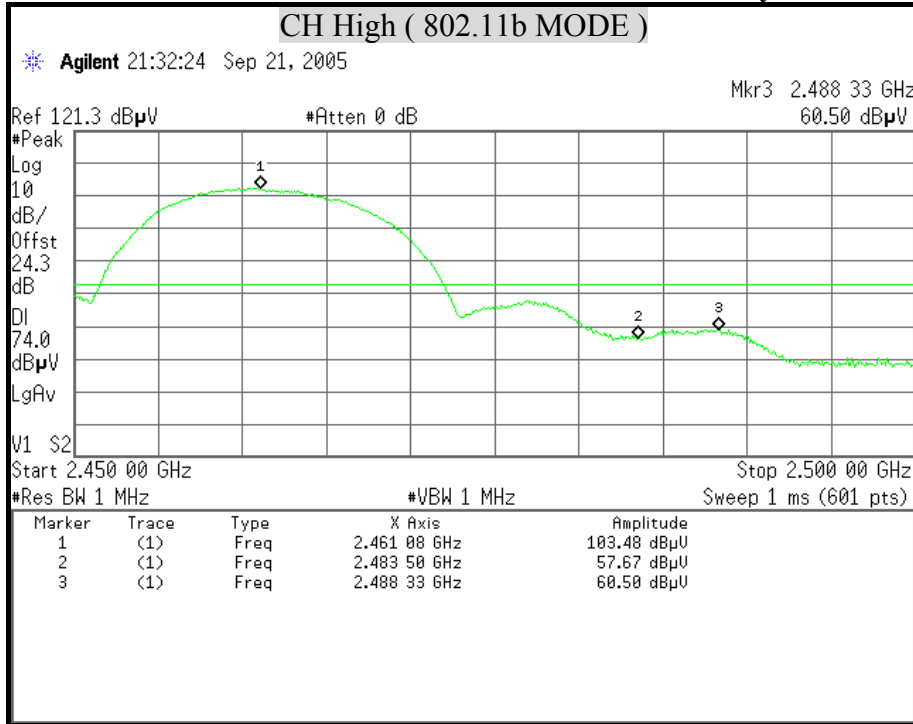

Detector mode : Average

Polarity : Vertical

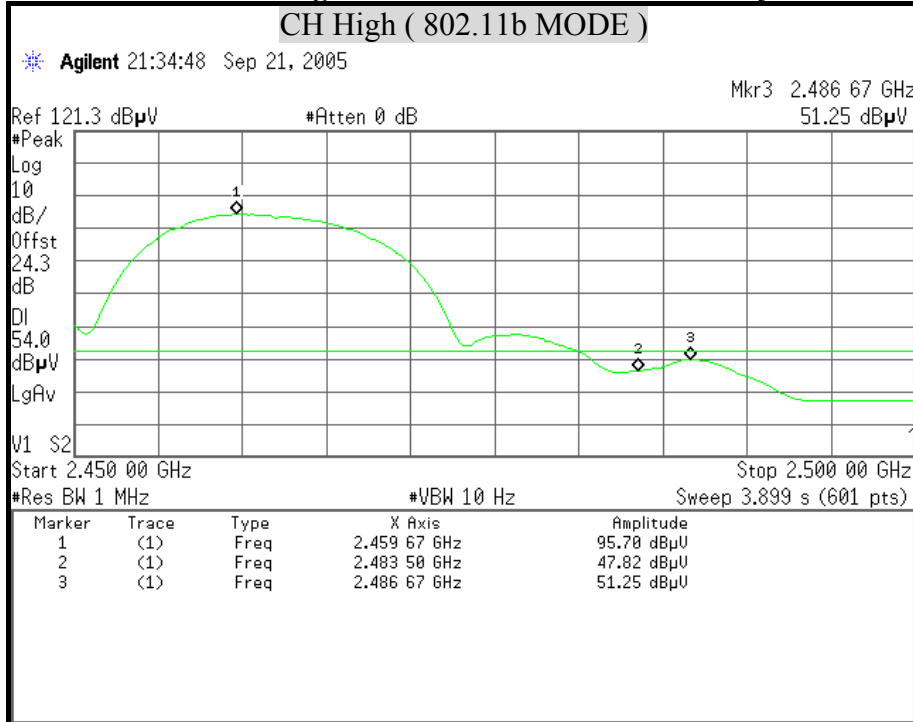



Detector mode : Peak

Polarity : Horizontal

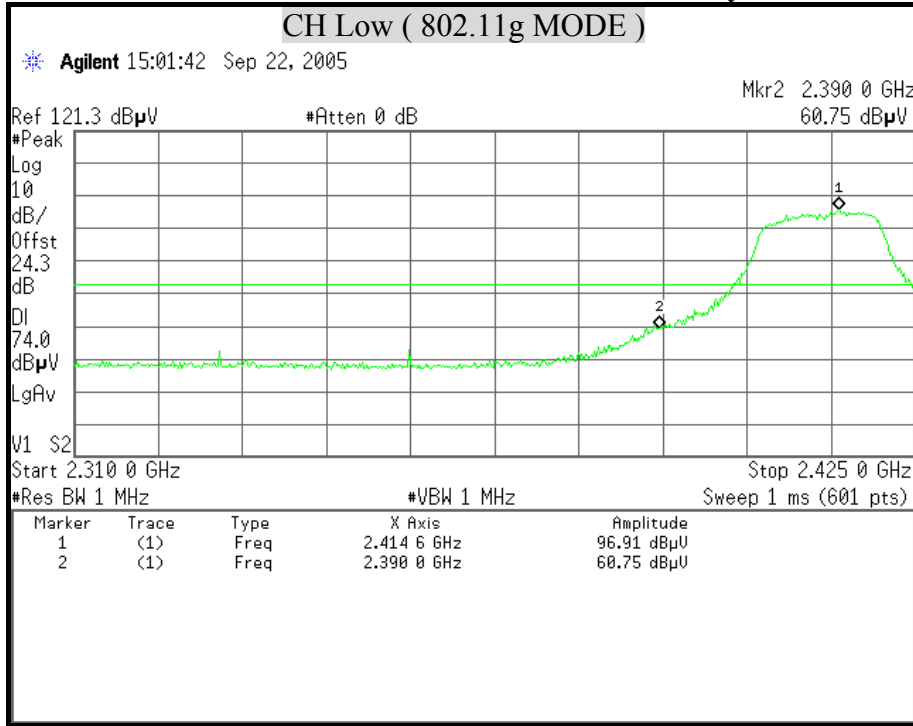

Detector mode : Average

Polarity : Horizontal

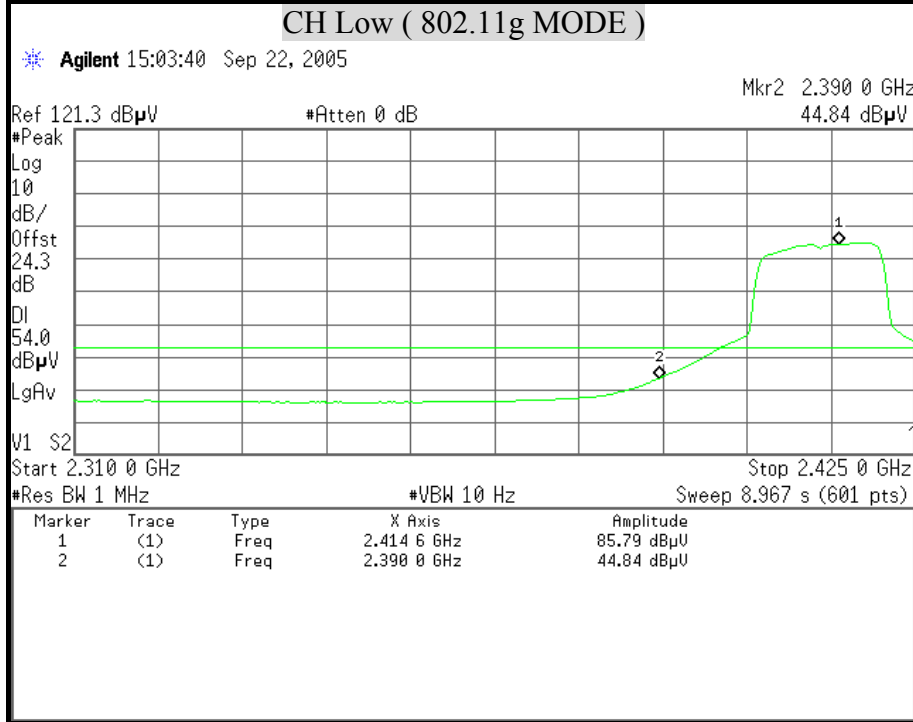



Detector mode : Peak

Polarity : Vertical

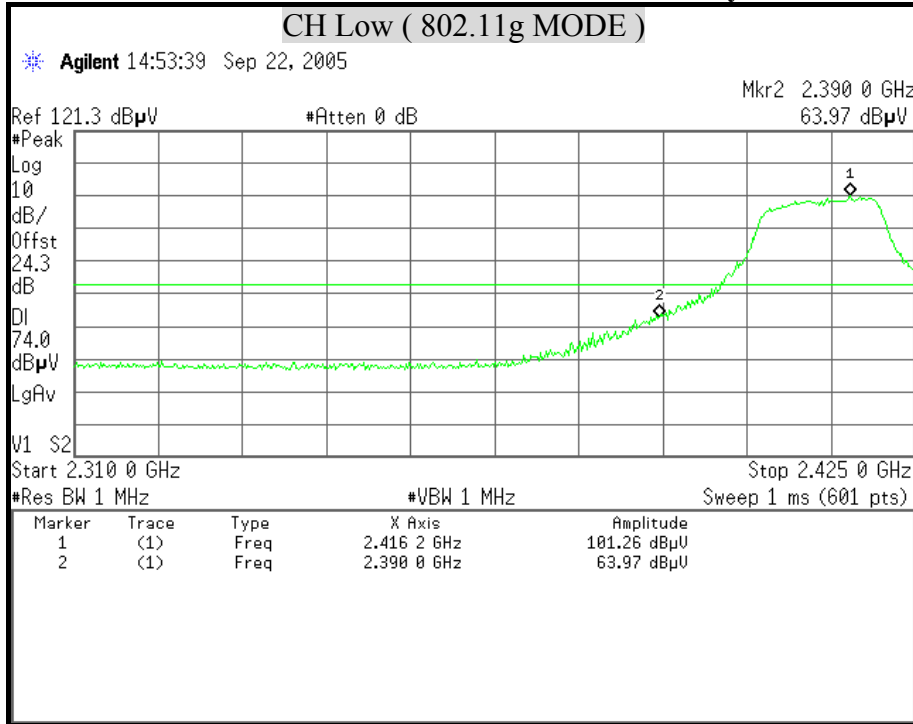

Detector mode : Average

Polarity : Vertical

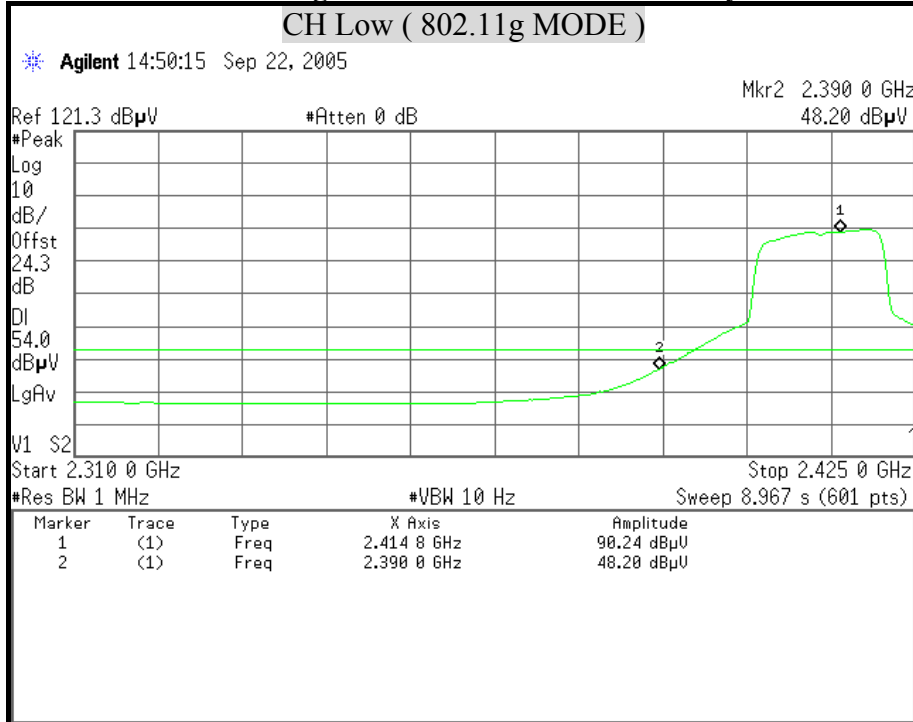



Detector mode : Peak

Polarity : Horizontal

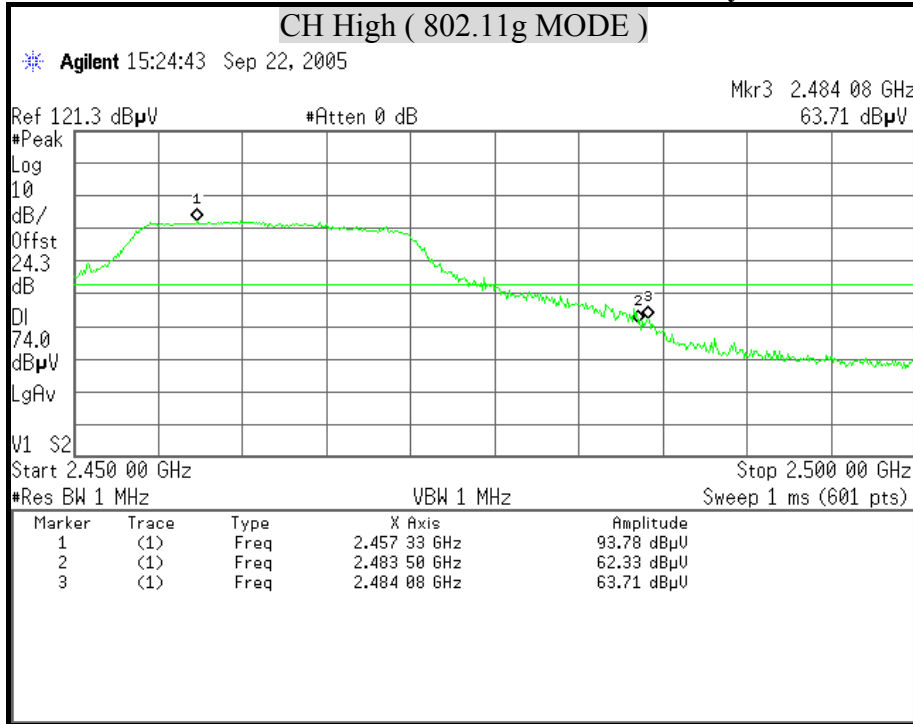

Detector mode : Average

Polarity : Horizontal

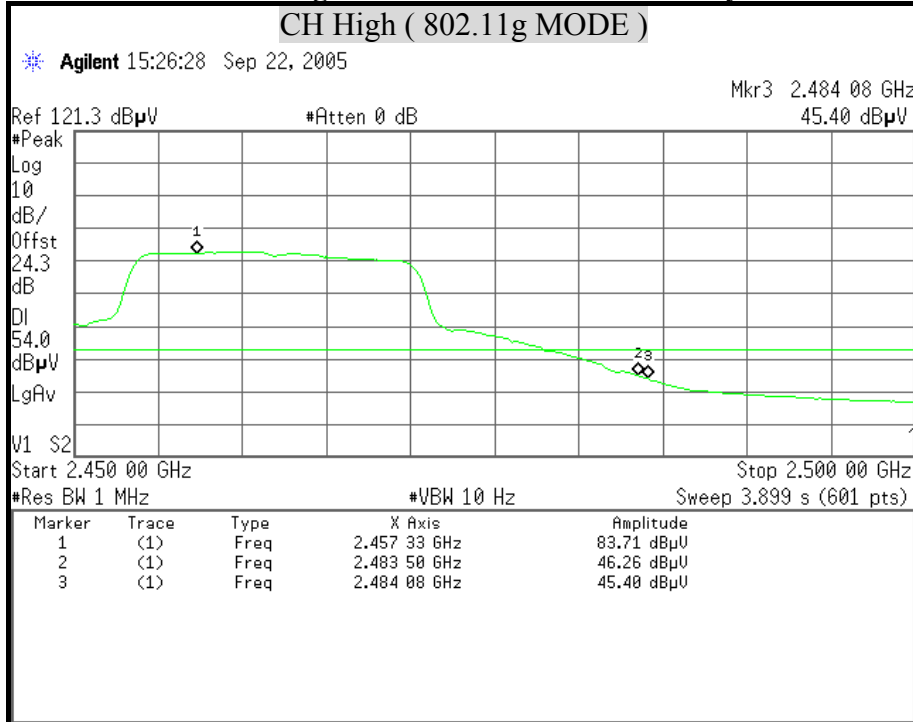



Detector mode : Peak

Polarity : Vertical

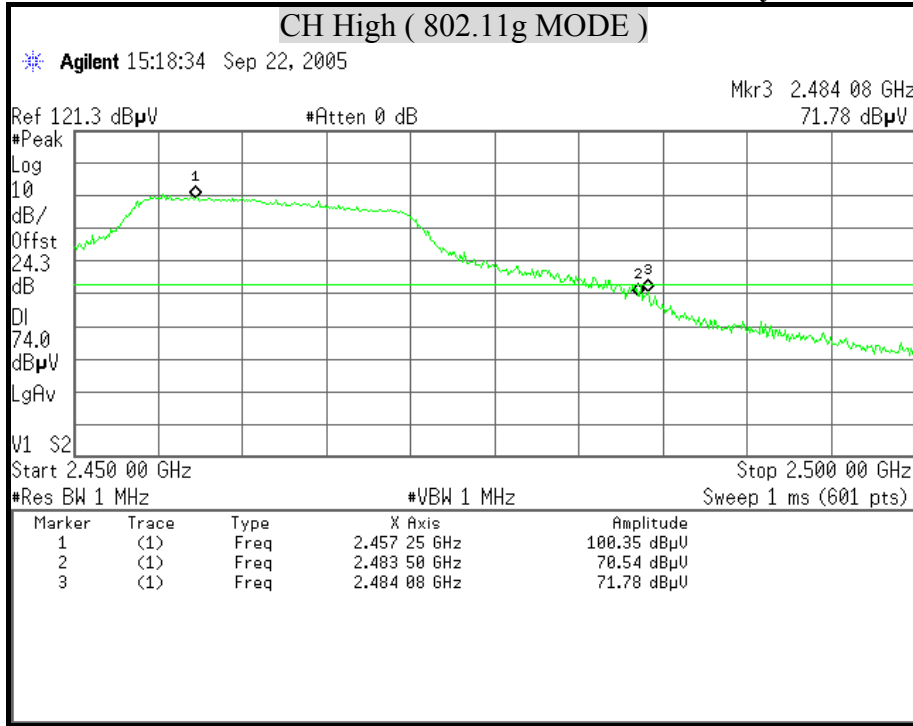

Detector mode : Average

Polarity : Vertical

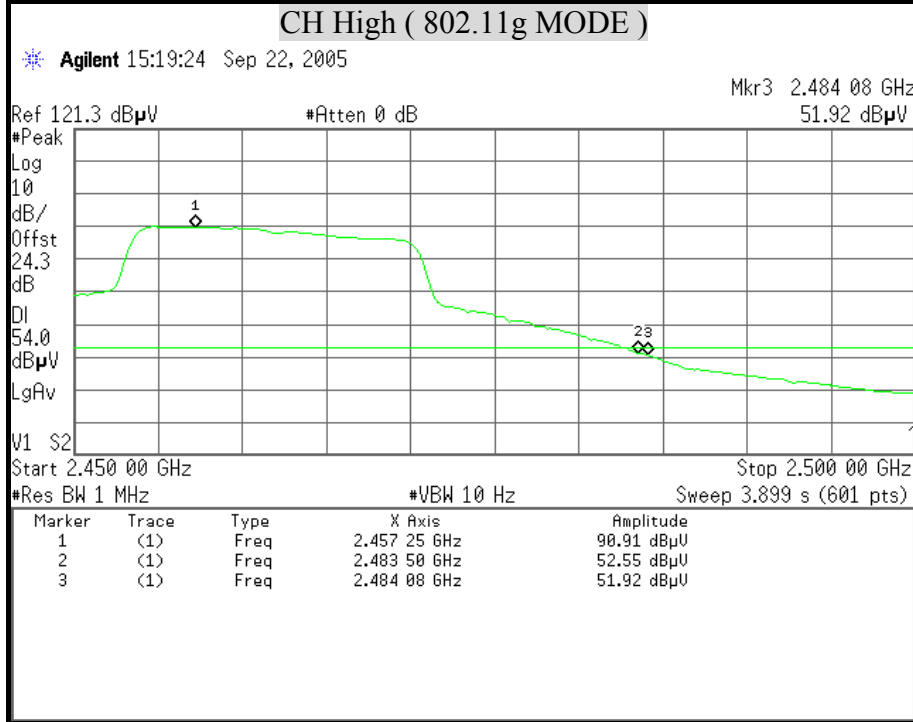



8.9 POWERLINE CONDUCTED EMISSIONS

LIMITS

§ 15.207 (a) Except as shown in paragraph (b) and (c) this section, for an intentional radiator that is designed to be connected to the public utility (AC) power line, the radio frequency voltage that is conducted back onto the AC power line on any frequency or frequencies within the band 150 kHz to 30 MHz shall not exceed the limits in the following table, as measured using a 50 μ H/50 ohms line impedance stabilization network (LISN). Compliance with the provisions of this paragraph shall be based on the measurement of the radio frequency voltage between each power line and ground at the power terminal.

The lower limit applies at the boundary between the frequency ranges.

Frequency of Emission (MHz)	Conducted limit (dB μ v)	
	Quasi-peak	Average
0.15 - 0.5	66 to 56	56 to 46
0.5 - 5	56	46
5 - 30	60	50

TEST EQUIPMENTS

The following test equipments are used during the conducted powerline tests :

Manufacturer or Type	Model No.	Serial No.	Date of Calibration	Calibration Period	Remark
HP SPECTRUM ANALYZER	8594E	3801A05627	April 28, 2005	1 Year	PRETEST
SOLAR ISOLATION TRANSFORMER	7032-1	N/A	N/A	N/A	FINAL
EMCO L.I.S.N.	3850/2	9311-1025 9401-1028	January 10, 2005 For Characteristic impedance January 10, 2005 For Insertion loss	1 Year	FINAL
R & S TEST RECEIVER	ESHS30	838550/003	February 21, 2005	1 Year	FINAL
KEENE SHIELDED ROOM	5983	No.1	N/A	N/A	FINAL
R & S PULSE LIMIT	EHS3Z2	357.8810.52	July 10, 2005	1 Year	FINAL
N TYPE COAXIAL CABLE	-----	-----	July 10, 2005	1 Year	FINAL
50 Ω TERMINATOR	-----	-----	July 10, 2005	1 Year	FINAL



TEST SETUP

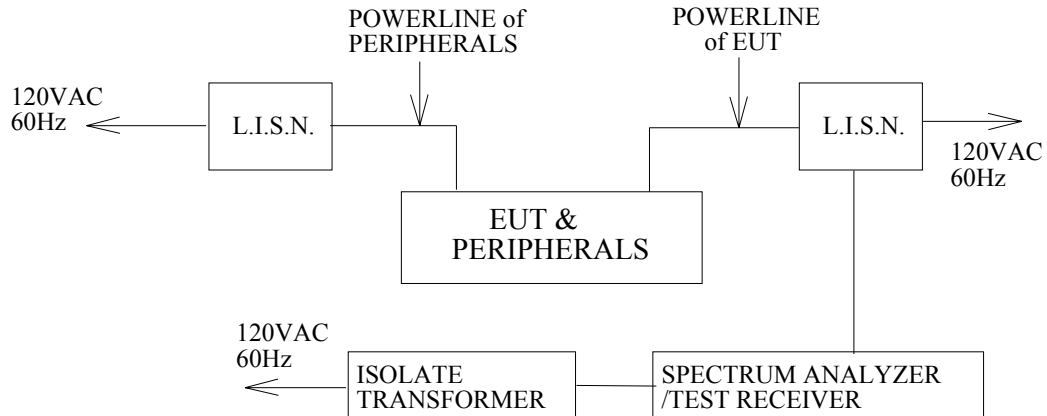

TEST PROCEDURE

The EUT is placed on a non-conducting table 40 cm from the vertical ground plane and 80cm above the horizontal ground plane. The EUT IS CONFIGURED IN ACCORDANCE WITH ANSI C63.4.

The resolution bandwidth is set to 9 kHz for both quasi-peak detection and average detection measurements.

Line conducted data is recorded for both NEUTRAL and LINE.

TEST RESULTS

No non-compliance noted

**CONDUCTED RF VOLTAGE MEASUREMENT**

Product Name	802.11b/g Wireless mini-PCI Module	Test Date	2005/09/21
Model	XG-623	Test By	Alan Fan
Test Mode	Normal operating (worst case)	TEMP&Humidity	30°C, 61%

LINE

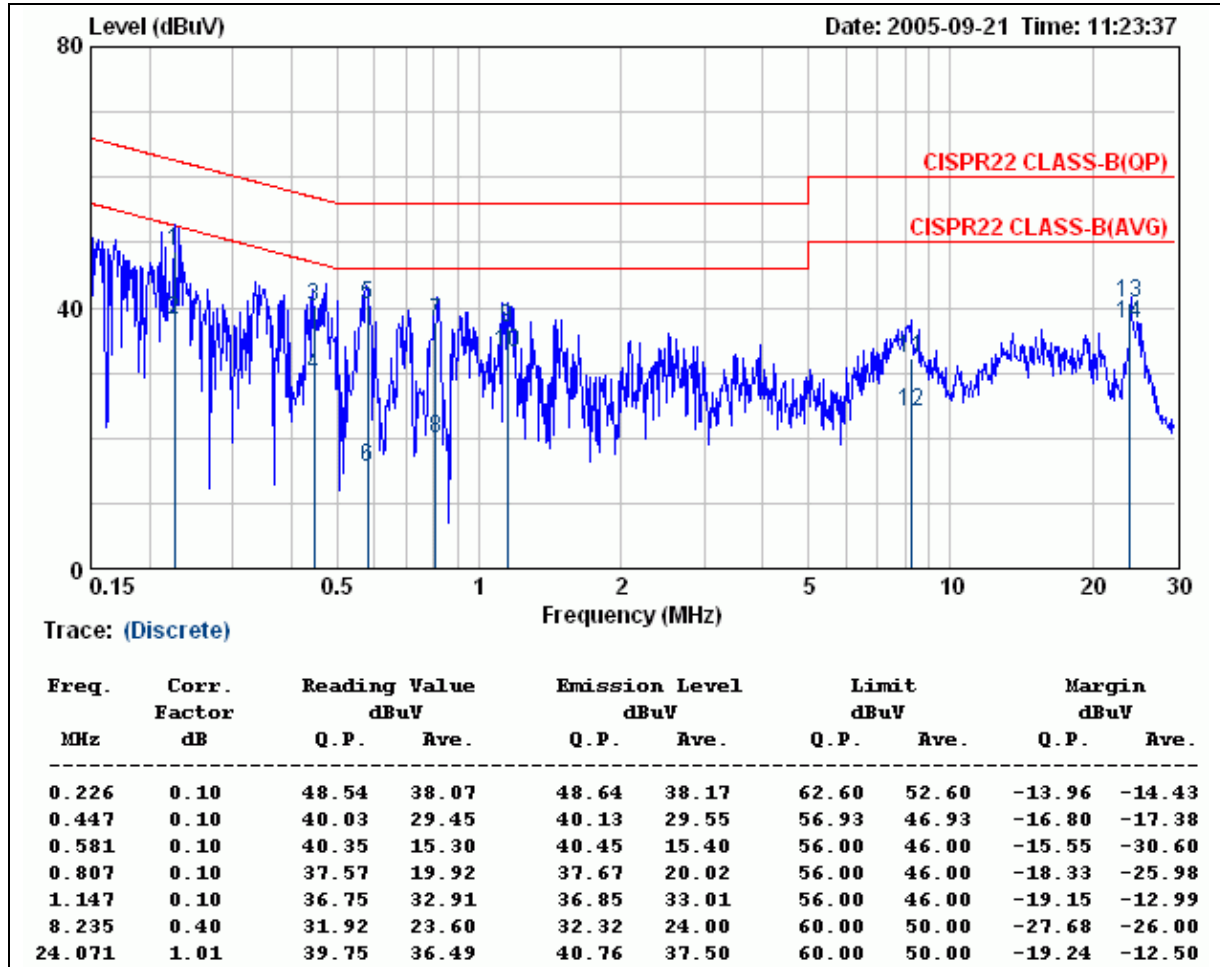
**Remark:**

1. Correction Factor = Insertion loss + cable loss
2. Margin value = Emission level - Limit value



Product Name	802.11b/g Wireless mini-PCI Module	Test Date	2005/09/21
Model	XG-623	Test By	Alan Fan
Test Mode	Normal operating (worst case)	TEMP&Humidity	30°C, 61%

NEUTRAL

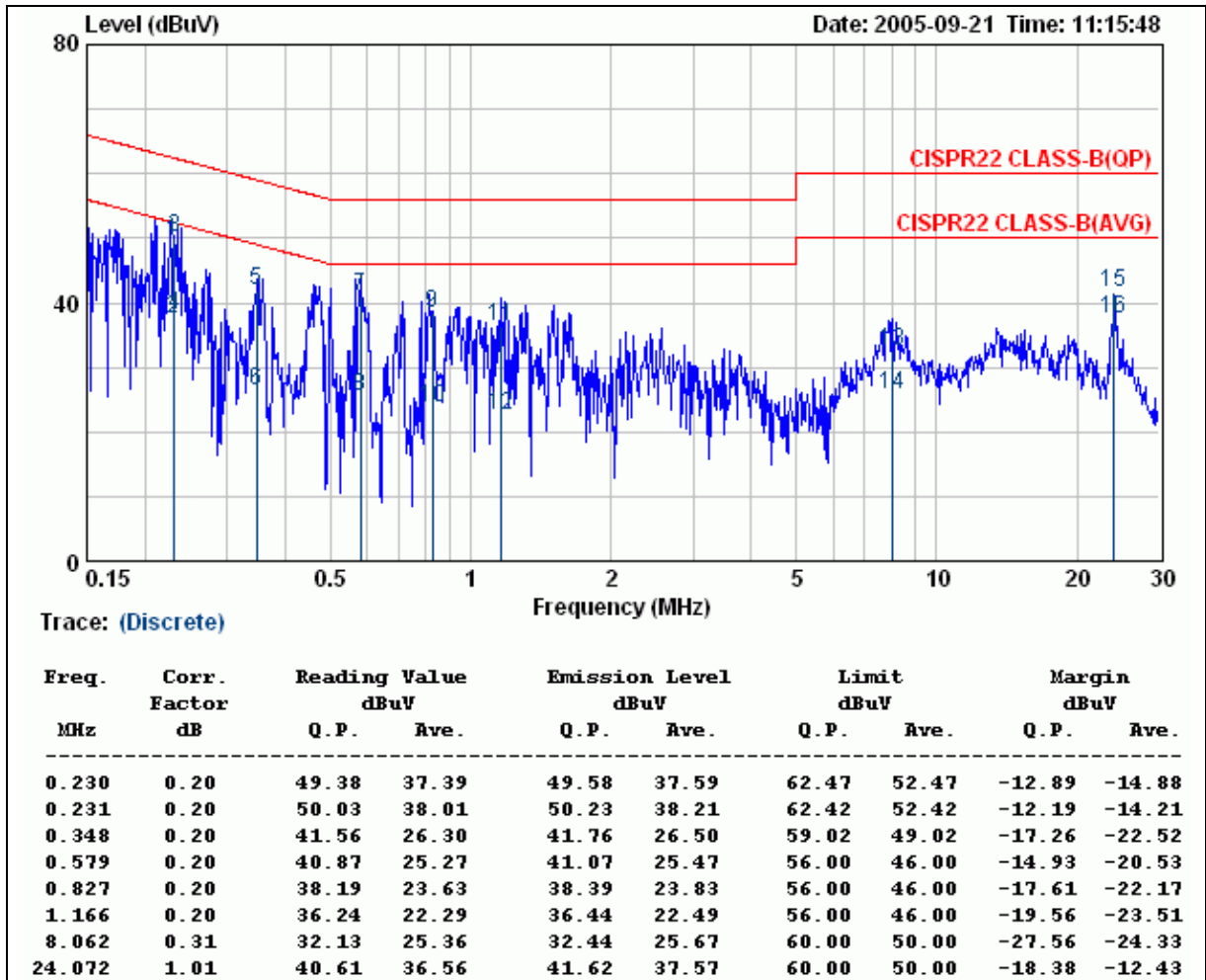

Remark:

1. Correction Factor = Insertion loss + cable loss
2. Margin value = Emission level - Limit value



9. ANTENNA REQUIREMENT

9.1 STANDARD APPLICABLE

For intentional device, according to FCC 47 CFR Section 15.203, an intentional radiator shall be designed to ensure that no antenna other than that furnished by the responsible party shall be used with the device.

And according to FCC 47 CFR Section 15.247 (b), if transmitting antennas of directional gain greater than 6dBi are used, the power shall be reduced by the amount in dB that the directional gain of the antenna exceeds 6dBi.

9.2 ANTENNA CONNECTED CONSTRUCTION

The antenna used for this product is PIFA antenna. The temporary antenna connector is MHF connector and the peak Gain of this antenna is only -1dBi



APPENDIX SETUP PHOTOS

RADIATED RF MEASUREMENT SETUP







POWERLINE CONDUCTED EMISSIONS MEASUREMENT SETUP



RF PORT CONDUCTED MEASURE SETUP

