



## RF TEST REPORT

**Product Name** : 802.11a/b/g Wireless mini PCI Adapter

**Model Number** : AG-622

**Brand Name** : ZCOM

**FCC ID** : M4Y-0AG622

**Applicant** : Z-Com, Inc.

**Address** : 7F-2, No.9, Prosperity Rd. I, Science-Based Industrial,  
Park Hsinchu, 300 Taiwan, R.O.C.

**Received Date** : January 07, 2005

**Tested Date** : January 12 ~ 26, 2005

Issued by

**Compliance Certification Services Inc.**

**Hsinchu Lab.**

Rm. 258, Bldg. 17, NO.195, Sec.4 Chung Hsing Rd.,  
ChuTugn Chen, Hsinchu, Taiwan 310, R.O.C

**TEL: (03) 591-8012**

**FAX: (03) 582-5720**

Notes :

1. This report will be invalid if duplicated or photocopied in part.
2. This report refers only to the specimen(s) submitted to testing, and be invalid as seperately used.
3. This report is invalid without examination stamp and signature of this institute.
4. The tested specimen(s) will be preserved for thirty days from the data issued.
5. The report must not be used to claim product certification, approval, or endorsement by NVLAP, NIST, or any agency of the federal government.





# Test Report Certification

**Product Name** : 802.11a/b/g Wireless mini PCI Adapter

**Model Number** : AG-622

**Brand Name** : ZCOM

**FCC ID** : M4Y-0AG622

**Applicant** : Z-Com, Inc.

## Measurement Standard :

FCC 47 C.F.R. Part 15, Subpart B and Subpart E (2004)  
ANSI C63.4 (2003)

**Tested By** : Alan Fan, **Date** : January 31, 2005  
(Alan Fan)

**Approved By** : C.F. Wu, **Date** : January 31, 2005  
(C.F. Wu, Manager)

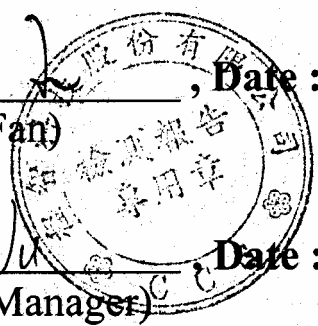

WE HEREBY CERTIFY THAT: The measurements shown in the attachment were made in accordance with the procedures indicated, and the energy emitted by the equipment was found to be within the limits applicable. We assume full responsibility for the accuracy and completeness of these measurements and vouch for the qualifications of all persons taking them.



**TABLE OF CONTENTS**

TITLE	PAGE NO.
<b>1. GENERAL INFORMATION .....</b>	<b>5</b>
1.1 General Statement .....	5
1.2 General Description of EUT & Power .....	5
1.3 Tested Channel.....	6
1.4 Description of Peripherals.....	7
1.5 EUT & Peripherals Setup Diagram.....	7
1.6 EUT Operating Condition .....	8
1.7 Description of Test Site.....	9
1.8 Summary of Test Results .....	10
<b>2. CONDUCTED POWERLINE TEST .....</b>	<b>11</b>
2.1 Test Equipments.....	11
2.2 Test Setup.....	11
2.3 Conducted Power Line Emission Limit .....	12
2.4 Test Procedure.....	12
2.5 Uncertainty of Conducted Emission .....	12
2.6 Conducted RF Voltage Measurement .....	13-16
2.7 Photos of Conduction Test.....	17
<b>3. RADIATED EMISSION TEST .....</b>	<b>18</b>
3.1 Test Equipments.....	18
3.2 Test Setup.....	19
3.3 Radiation Limit .....	20
3.4 Test Procedures .....	21
3.5 Uncertainty of Radiated Emission .....	21
3.6 Radiated RF Noise Measurement.....	22
3.6.1 Spurious Emission Below 1GHz.....	22
3.6.2 Spurious Emission Outside of the 5.15 ~ 5.35GHz Band (TX).....	23-38
3.6.3 Radiated Bandedge Emission of 5.15 ~ 5.35GHz Band .....	39
3.6.4 Photo of Bandedge Measurement .....	40-41
3.6.5 Spurious Emission Outside of the 5.15 ~ 5.35GHz Band (RX) .....	42-57
3.7 Photos of Open Site.....	58-59
<b>4. EMISSION BANDWIDTH MEASUREMENT .....</b>	<b>60</b>
4.1 Test Equipments.....	60
4.2 Test Setup.....	60
4.3 Test Procedure.....	60
4.4 Uncertainty of Conducted Emission .....	60
4.5 Test Results.....	61
4.6 Photo of 26db Bandwidth Measurement.....	62-65



**TABLE OF CONTENTS**

TITLE	PAGE NO.
<b>5. PEAK CONDUCTED TRANSMIT POWER .....</b>	<b>66</b>
5.1 Test Equipments.....	66
5.2 Test Setup.....	66
5.3 Limits of Maximum Peak Output Power .....	67
5.4 Test Procedure.....	67
5.5 Uncertainty of Conducted Emission .....	67
5.6 Test Results .....	68
5.7 Photo of Peak Conducted Transmit Power Measurement.....	69-72
<b>6. PEAK POWER DENSITY MEASUREMENT .....</b>	<b>73</b>
6.1 Test Equipments.....	73
6.2 Test Setup.....	73
6.3 Limits of Power Spectral Density Measurement.....	73
6.4 Test Procedure.....	74
6.5 Uncertainty of Conducted Emission .....	74
6.6 Test Results .....	74
6.7 Photo of Peak Power Density Measurement .....	75-78
<b>7. PEAK POWER EXCURSION MEASUREMENT .....</b>	<b>79</b>
7.1 Test Equipments.....	79
7.2 Test Setup.....	79
7.3 Limits of Peak Power Excursion Measurement .....	79
7.4 Test Procedure.....	79
7.5 Uncertainty of Conducted Emission .....	80
7.6 Test Results .....	80
7.7 Photo of Peak Power Excursion Measurement .....	81-84
<b>8. FREQUENCY STABILITY .....</b>	<b>85</b>
8.1 Standard Applicable.....	85
8.2 Test Setup.....	85
8.3 Limits of Frequency Stability .....	85
8.4 Test Procedure.....	86
8.5 Uncertainty of Conducted Emission .....	86
8.6 Test Results .....	87
<b>9. ANTENNA REQUIREMENT .....</b>	<b>88</b>
9.1 Standard Applicable.....	88
9.2 Antenna Connected Construction .....	88
<b>10. RF EXPOSURE EVALUATION .....</b>	<b>89</b>
10.1 Friis Formula.....	89
10.2 EUT Operating Condition.....	89
10.3 Test Result of RF Exposure Evaluation .....	90
10.3.1 Antenna Gain .....	90
10.3.2 Output Power into Antenna & RF Exposure Evaluation Distance .....	90



## 1. GENERAL INFORMATION

### 1.1 General Statement

MEASUREMENT DEVIATION : Comply with standard in full

TRACEABILITY : This test result is traceable to National or International std.

### 1.2 General Description of EUT & Power

<b>Product Name</b>	802.11a/b/g Wireless mini PCI Adapter
<b>Model Number</b>	AG-622
<b>Operating Frequency</b>	◆ IEEE 802.11a USA(FCC) : 5.15GHz ~ 5.25GHz ; 5.25GHz ~ 5.35GHz
<b>Channel Number</b>	8 channel for Normal 802.11a, 6 channel for Super A
<b>Channel Spacing</b>	20MHz for 802.11a
<b>Modulation</b>	◆ IEEE 802.11a (OFDM) : 48/54 Mbps (QAM-64), 24/36 Mbps (QAM-16), 12/18 Mbps (QPSK), 6/9 Mbps (BPSK)
<b>Advanced Mode</b>	Super A mode
<b>Frequency Selection</b>	BY SOFTWARE
<b>Transmitter Classification</b>	Mobile device
<b>Antenna Type</b>	PIFA Antenna Antenna Gain : 1.24dBi at 5GHz, Antenna Cable : 75cm
<b>Power Source</b>	3.3VDC (From Notebook PC)



### 1.3 Tested Channel

The following channel were evaluated in this test report.

5.15~5.35GHz

For normal 802.11a mode

Channel	Carrier center frequency fc (MHz)
1	5180
2	5200
3	5220
4	5240
5	5260
6	5280
7	5300
8	5320

For Super A mode

Channel	Carrier center frequency fc (MHz)
Low	5200
-----	5220
Middle	5240
	5260
-----	5280
High	5300

### 1.4 Description of Peripherals

No.	Product	Manufacturer	Model No.	Serial No.	Input Power	Output Power
1	Notebook PC	COMPAQ	N800V	5Y33KSQZM0W4 1YR	18.5VDC, 65W, 3.5A	-----
	Adapter	COMPAQ	PPP009L	4809673805	100~240VAC, 50/60, 1.6A	18.5VDC, 65W, 3.5A
2	Printer	HP	C6431D	CN19T6S011	100~240VAC, 50/60Hz, 0.7A	-----
3	Notebook PC	COMPAQ	N800V	5Y31KSQZD1TJ 1YR	18.5VDC, 65W, 3.5A	-----
	Adapter	COMPAQ	PPP009L	4809672405	100~240VAC, 50/60, 1.6A	18.5VDC, 65W, 3.5A

### 1.5 EUT & Peripherals Setup Diagram

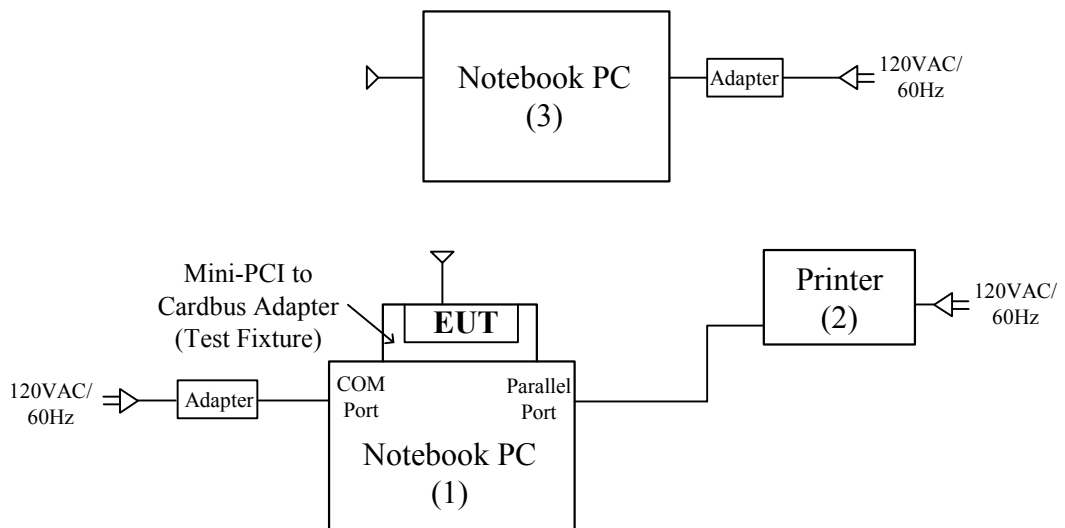

The indicated numbers (1)(2)..., please refer to item 1.3



## 1.6 EUT Operating Condition

1. Set up all computers like the setup diagram.
2. The “**Atheros Radio Test <ART> Revision 4.8 BUILD #16**” software was used for testing.
  - (1) **TX Mode :**
    - ⇒ **Tx Data Rate:6Mbps** (802.11a Mode) **108Mbps** (Super A Turbo Mode)
    - ⇒ **Toggle output mode = TX100**
    - ⇒ **Target Power:** 802.11a Mode Channel 1 (5180MHz) = **13.0**  
802.11a Mode Channel 4 (5240MHz) = **13.0**  
802.11a Mode Channel 5 (5260MHz) = **11.5**  
802.11a Mode Channel 8 (5320MHz) = **14.0**
    - ⇒ **“ b “ => Toggle turbo mode**
    - ⇒ **Target Power:** Super A Turbo Mode Channel Low (5200MHz) = **13.0**  
Super A Turbo Mode Channel Middle (5240MHz) = **13.0**  
Super A Turbo Mode Channel Middle (5260MHz) = **12.0**  
Super A Turbo Mode Channel High (5300MHz) = **14.0**
  - (2) **RX Mode :**
    - ⇒ **Continuous RF <R>eceive mode**
3. Notebook PC (1) ping 192.168.1.10 -t -l 5000 to EUT.
4. Notebook PC (4) ping 192.168.1.20 -t -l 5000 to Notebook PC(1).
5. All of the function are under run.
6. Start test.





## 1.7 Description of Test Site

SITE DESCRIPTION :

FCC Certificate NO. : 90585  
BSMI Certificate NO. : SL2-IN-E-0002  
NVLAP Lab Code : 200118-0  
CNLA Certificate NO. : CNLA-ZL97018E  
VCCI Certificate NO. : R-1189, C-1250  
TÜV Rheinland Certificate NO. : 10008375

NAME OF SITE : Compliance Certification Services Inc. Hsinchu Lab.

SITE LOCATION : Rm.258, Bldg.17, NO.195 , Sec. 4, Chung Hsing Rd.,  
Chu-Tung Chen. Hsin-Chu, Taiwan 310 R.O.C.



## 1.8 Summary of Test Results

The items of compliance are listed below. The complete data can be found in the Tests data Sheets submitted with this report.

General requirements for all bands			
Standard Section	Test Item	Result	Comments
15.407(a)(6)	Peak Excursion Ratio	Complied	< 13dB
15.407(c)	Automatic Discontinuation of Operation in the absence of information to transmit	Complied	Operation is discontinued in the absence of information to transmit, refer to the "Theory of Operations" for a detailed explanation
15.407(g)	Frequency Stability	Complied	Frequency stability is +/- 20ppm
15.207 15.407(b)(6)	Conducted AC power Line	Complied	See test results

Operation in the 5.15-5.25GHz Band			
Standard Section	Test Item	Result	Comments
15.407(e)	Indoor operation only	Complied	<b>Refer to user's manual</b>
15.407(a)(1)	26dB Bandwidth	N/A	See test results
15.407(a)(1)	Output Power	Complied	See test results
15.407(a)(1)	Power Spectral Density	Complied	See test results
15.407(b)(6) 15.209	Spurious Emissions below 1GHz	Complied	See test results
15.407(b)(1)	Spurious Emissions above 1GHz	Complied	See test results

Operation in the 5.25-5.35GHz Band			
Standard Section	Test Item	Result	Comments
15.407(d)	Maximum Antenna Gain/ Antenna Type	Complied	Antenna Gain = <u>1.24dBi at 5GHz</u> The antenna is <u>PIFA Type</u>
15.407(a)(2)	Bandwidth	N/A	See test results
15.407(a)(2)	Output Power	Complied	See test results
15.407(a)(2)	Power Spectral Density	Complied	See test results
15.407(b)(6) 15.209	Spurious Emissions below 1GHz	Complied	See test results
15.407(b)(2)	Spurious Emissions above 1GHz	Complied	See test results



## 2. CONDUCTED POWERLINE TEST

### 2.1 Test Equipments

The following test equipments are used during the conducted powerline tests :

Manufacturer or Type	Model No.	Serial No.	Date of Calibration	Calibration Period	Remark
HP SPECTRUM ANALYZER & DISPLAY	8594E	3801A05627	April 26, 2004	1 Year	PRETEST
SOLAR ISOLATION TRANSFORMER	7032-1	N/A	N/A	N/A	FINAL
EMCO L.I.S.N.	3850/2	9311-1025 9401-1028	January 10, 2005 For Characteristic impedance	1 Year	FINAL
			May 18, 2004 For Insertion loss		
R & S TEST RECEIVER	ESHS30	838550/003	February 11, 2004	1 Year	FINAL
KEENE SHIELDED ROOM	5983	No.1	N/A	N/A	FINAL
R & S PULSE LIMIT	EHS3Z2	357.8810.52	July 10, 2004	1 Year	FINAL
N TYPE COAXIAL CABLE	-----	-----	July 10, 2004	1 Year	FINAL
50Ω TERMINATOR	-----	-----	July 10, 2004	1 Year	FINAL

### 2.2 Test Setup

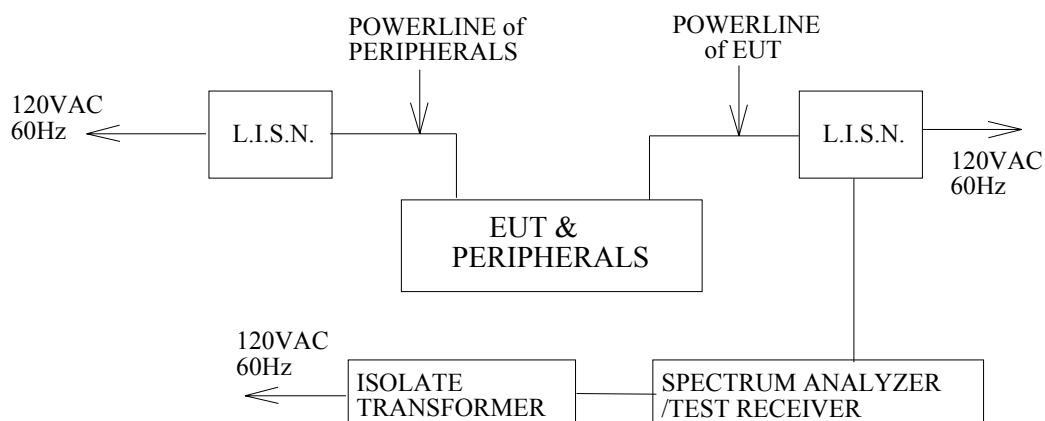



## 2.3 Conducted Power Line Emission Limit

For unintentional device, according to § 15.107(a) Line Conducted Emission Limits is as following :

Frequency (MHz)	Maximum RF Line Voltage (dB $\mu$ v)			
	CLASS A		CLASS B	
	Q.P.	Ave.	Q.P.	Ave.
0.15 - 0.50	79	66	66-56*	56-46*
0.50 - 5.00	73	60	56	46
5.00 - 30.0	73	60	60	50

\* Decreasing linearly with the logarithm of the frequency

For intentional device, according to § 15.207(a) Line Conducted Emission Limit is same as above table.

## 2.4 Test Procedure

The test procedure is performed in a 12ft×12ft×8ft(L×W×H) shielded room.

The EUT along with its peripherals were placed on a 1.0m(W)× 1.5m(L) and 0.8m in height wooden table and the EUT was adjusted to maintain a 0.4 meter space from a vertical reference plane. The EUT was connected to power mains through a line impedance stabilization network (LISN) which provides 50 ohm coupling impedance for measuring instrument and the chasis ground was bounded to the horizontal ground plane of shielded room. All peripherals were connected to the second LISN and the chasis ground also bounded to the horizontal ground plane of shielded room. The excess power cable between the EUT and the LISN was bundled. The power cables of peripherals were unbundled. All connecting cables of EUT and peripherals were moved to find the maximum emission.

## 2.5 Uncertainty of Conducted Emission

The uncertainty of conducted emission is  $\pm 1.36$ dB.



## 2.6 Conducted RF Voltage Measurement

The frequency spectrum from 0.15 MHz to 30 MHz was investigated. All emissions not reported are much lower than the prescribed limits.

Company	Z-Com, Inc.	Test Date	2005/01/18
Product Name	802.11a/b/g Wireless mini PCI Adapter	Test By	Alan Fan
Model Name	AG-622	TEMP&Humidity	25°C, 42%

LINE

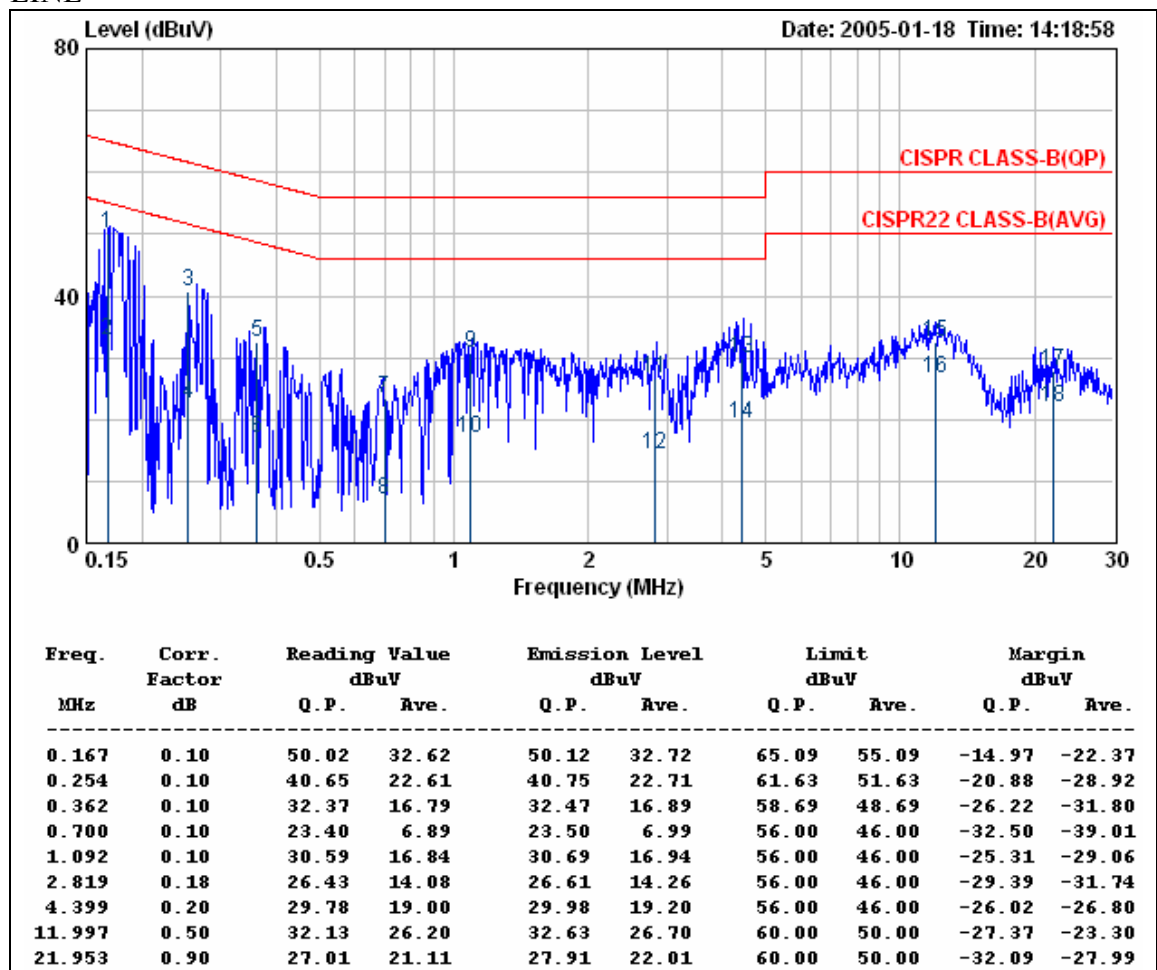

- REMARKS :
1. Correction Factor = Insertion loss + cable loss
  2. Margin value = Emission level – Limit value
  3. The EUT can be operated in transmitting, receiving and standby modes. According to technical experiences, the power line emissions of the EUT in transmitting mode generate highest emission. The EUT was set to transmitting mode at channel low (5180MHz) to get the worst-case data while performing final test.
  4. For Normal 802.11a Mode



The frequency spectrum from 0.15 MHz to 30 MHz was investigated. All emissions not reported are much lower than the prescribed limits.

Company	Z-Com, Inc.	Test Date	2005/01/18
Product Name	802.11a/b/g Wireless mini PCI Adapter	Test By	Alan Fan
Model Name	AG-622	TEMP&Humidity	25°C, 42%

## NEUTRAL

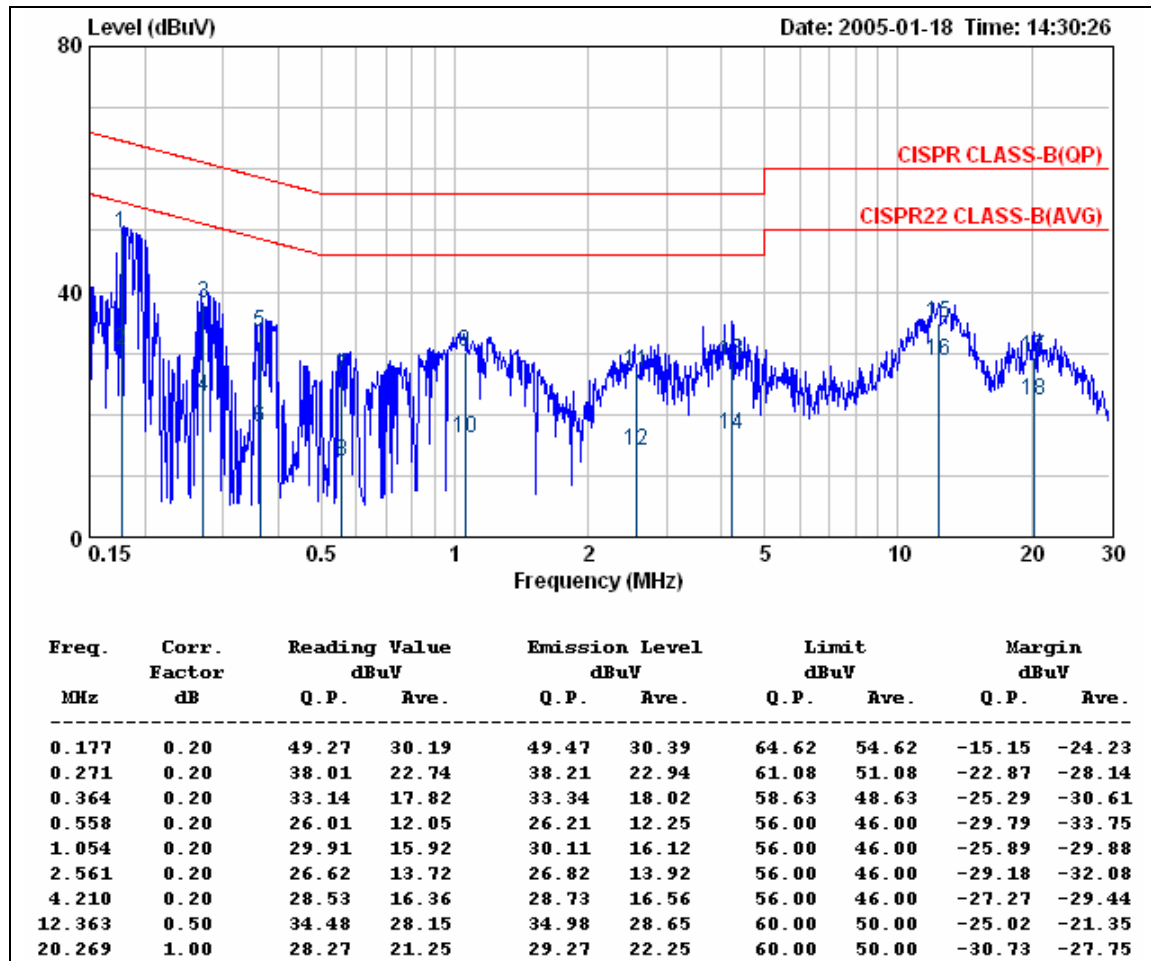

- REMARKS :
1. Correction Factor = Insertion loss + cable loss
  2. Margin value = Emission level – Limit value
  3. The EUT can be operated in transmitting, receiving and standby modes. According to technical experiences, the power line emissions of the EUT in transmitting mode generate highest emission. The EUT was set to transmitting mode at channel low (5180MHz) to get the worst-case data while performing final test.
  4. For Normal 802.11a Mode



The frequency spectrum from 0.15 MHz to 30 MHz was investigated. All emissions not reported are much lower than the prescribed limits.

Company	Z-Com, Inc.	Test Date	2005/01/18
Product Name	802.11a/b/g Wireless mini PCI Adapter	Test By	Alan Fan
Model Name	AG-622	TEMP&Humidity	25°C, 42%

LINE

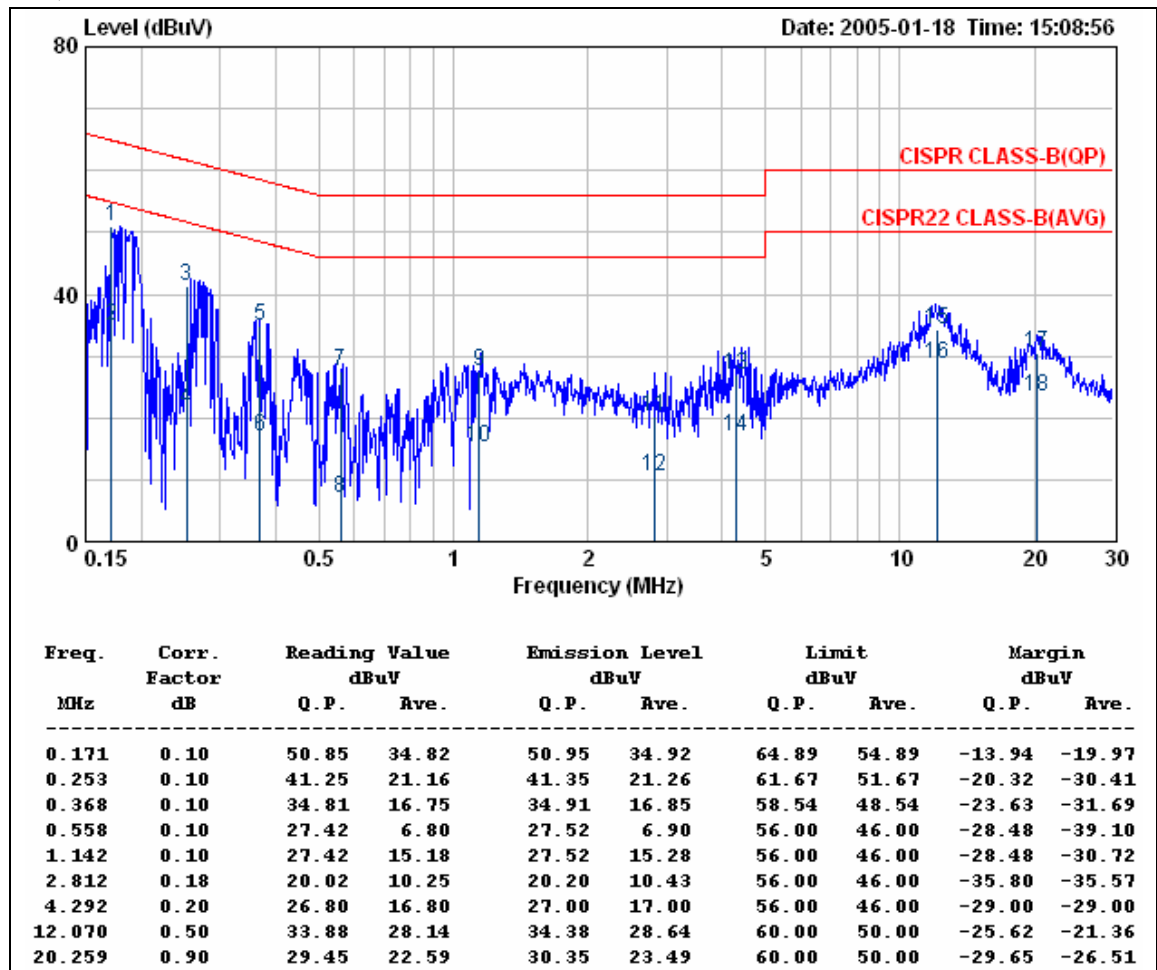

- REMARKS :
1. Correction Factor = Insertion loss + cable loss
  2. Margin value = Emission level – Limit value
  3. The EUT can be operated in transmitting, receiving and standby modes. According to technical experiences, the power line emissions of the EUT in transmitting mode generate highest emission. The EUT was set to transmitting mode at channel low (5200MHz) to get the worst-case data while performing final test.
  4. For Super A Mode



The frequency spectrum from 0.15 MHz to 30 MHz was investigated. All emissions not reported are much lower than the prescribed limits.

Company	Z-Com, Inc.	Test Date	2005/01/18
Product Name	802.11a/b/g Wireless mini PCI Adapter	Test By	Alan Fan
Model Name	AG-622	TEMP&Humidity	25°C, 42%

NEUTRAL

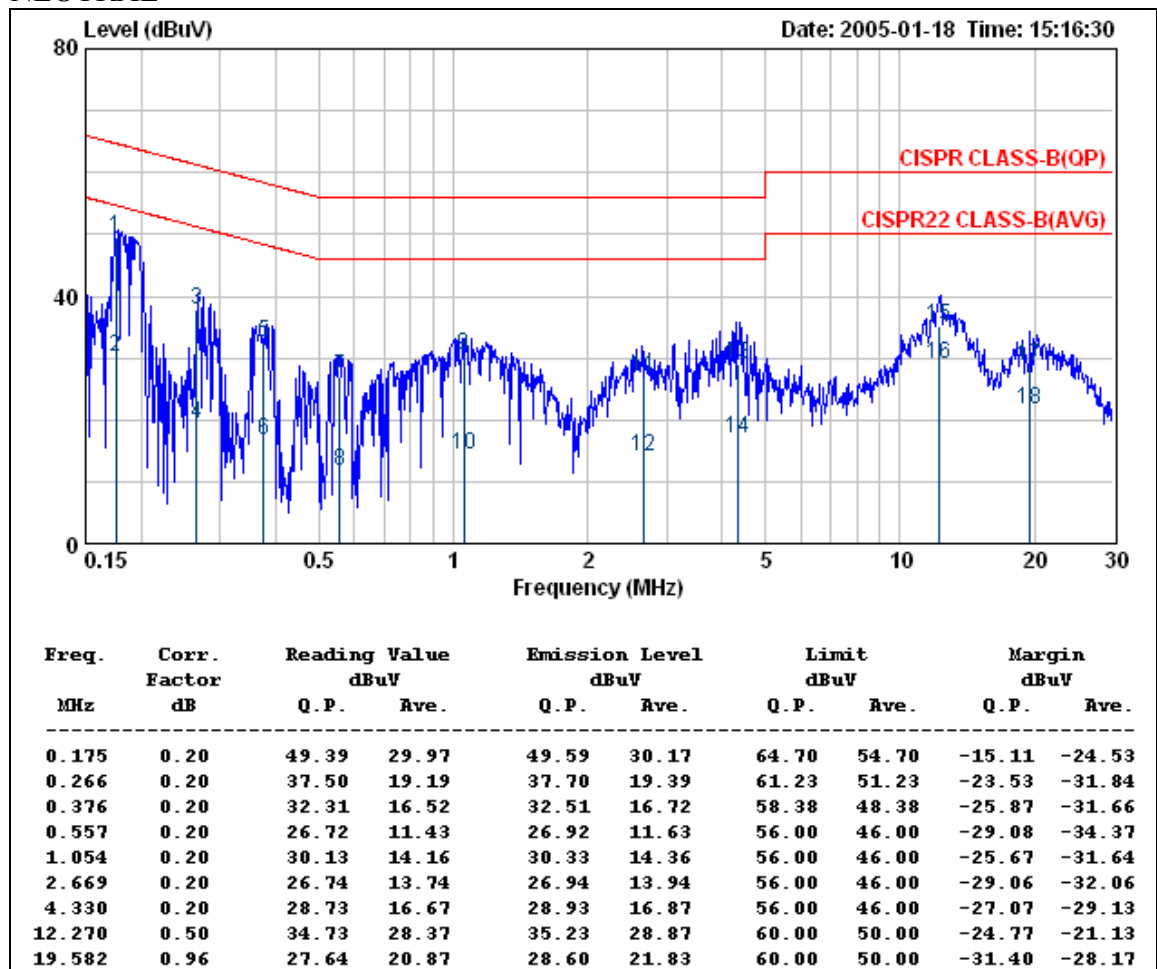

- REMARKS :
1. Correction Factor = Insertion loss + cable loss
  2. Margin value = Emission level – Limit value
  3. The EUT can be operated in transmitting, receiving and standby modes. According to technical experiences, the power line emissions of the EUT in transmitting mode generate highest emission. The EUT was set to transmitting mode at channel low (5200MHz) to get the worst-case data while performing final test.
  4. For Super A Mode



## 2.7 Photos of Conduction Test





### 3. RADIATED EMISSION TEST

#### 3.1 Test Equipments

The following test equipments are utilized in making the measurements contained in this report.

Manufacturer or Type	Model No	Serial No	Date of Calibration	Calibration Period	Remark
CHASE BI-LOG ANTENNA	CBL6112B	2421	June 15, 2004	1 Year	FINAL
R/S SPECTRUM ANALYZER	FSEK30	835253/002	September 06, 2004	1 Year	FINAL
R/S EMI TEST RECEIVER	ESCS30	83548/008	September 05, 204	1 Year	FINAL
OPEN SITE	-----	No.2	May 07, 2004	1 Year	FINAL
N TYPE COAXIAL CABLE	CHA9525	4	June 03, 2004	1 Year	FINAL
Com-power Horn Antenna	AH-118	10089	April 09, 2004	1 Year	FINAL
HP Pre-amplifier	8449B	3008A01471	November 24, 2004	1 Year	FINAL
NardaMicrowave Pre-amplifier	DBS-1840N8 13	016	July 27, 2004	1 Year	FINAL
HP High pass filter	84300/80038	002	CAL. ON USE	1 Year	FINAL
HP High pass filter	84300/80039	003	CAL. ON USE	1 Year	FINAL
Com-Power Horn Antenna	AH-840	3077	February 25, 2004	1 Year	FINAL

### 3.2 Test Setup

The diagram below shows the test setup that is utilized to make the measurements for emission from 30 to 1GHz.

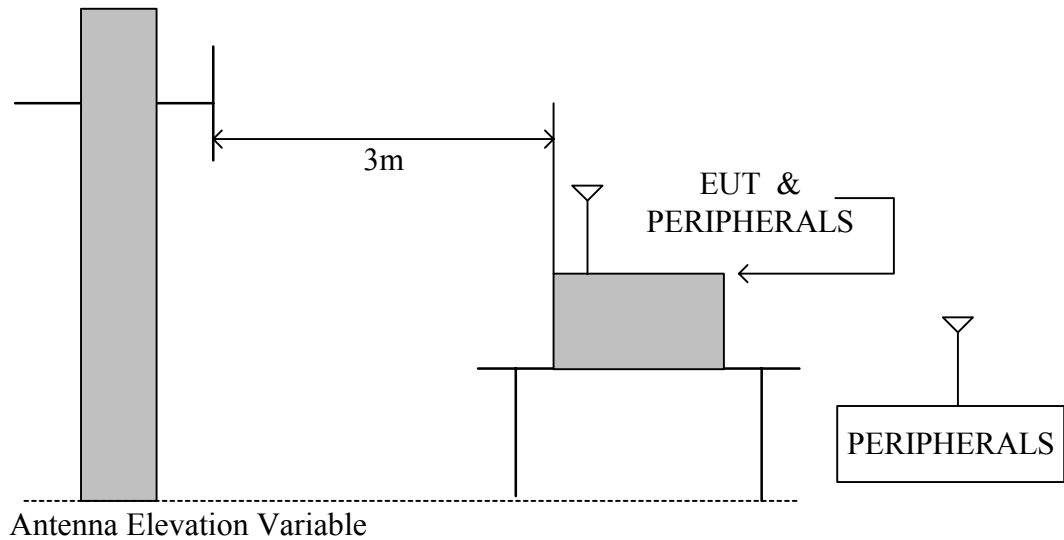

The diagram below shows the test setup that is utilized to make the measurements for emission above 1GHz.

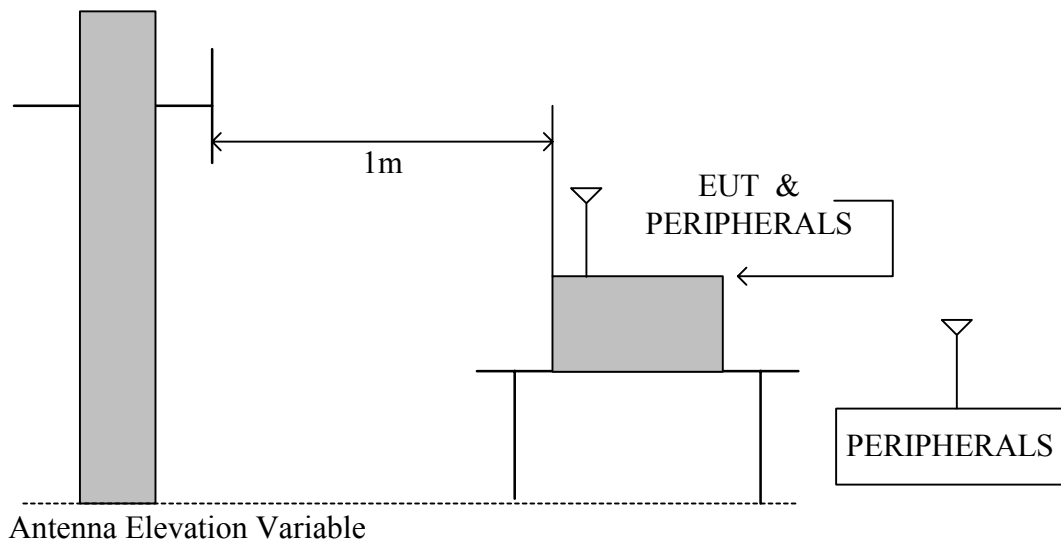



### 3.3 Radiation Limit

According to FCC Section 15.407(b) (6) (7), the unwanted emission below 1 GHz and in restricted bands should comply with the general field strength limits set forth in Section 15.209.

Frequency (MHz)	Distance (Meters)	Radiated (dB $\mu$ V/M)
30-88	3	40.0
88-216	3	43.5
216-960	3	46.0
Above 960	3	54.0

For intentional device, according to § 15.209(a), the general requirement of field strength of radiated emissions from intentional radiators at a distance of 3 meters shall not exceed the above table.

According to FCC Section 15.407(b)(1) (2) (3) (4), the unwanted emission above 1 GHz, outside of the operating frequency band below, should exceed an EIRP of the values listed in table below.

Operating Frequency Band (MHz)	EIRP Limit (dBm/MHz)	Equivalent Field Strength at 3m (dB $\mu$ V/M)
5150-5250	-27	68.3
5250-5350	-27	68.3
5470-5725	-27	68.3
5725-5825	-27*	68.3
	-17**	78.3

The remark "\*" means: outside the frequency range 5715~5835MHz.

The remark "\*\*" means: within the frequency range from the band edge to 10MHz below or above the band edge, 5715~5725MHz and 5825~5835MHz.



### 3.4 Test Procedures

- a. The EUT was placed on the top of a rotating table 0.8 meters above the ground at a 10 meter open area test site. The table was rotated 360 degrees to determine the position of the highest radiation.
- b. During performing radiated emission below 1GHz, the EUT was set 3 meters away from the interference-receiving antenna, which was mounted on the top of a variable-height antenna tower. During performing radiated emission above 1GHz, the EUT was set 1 meters away from the interference-receiving antenna
- c. The antenna is a broadband antenna, and its height is varied from one meter to four meters above the ground to determine the maximum value of the field strength. Both horizontal and vertical polarization of the antenna are set to make the measurement.
- d. For each suspected emission, the EUT was arranged to its worst case and then the antenna was tuned to heights from 1 meter to 4 meters and the table was turned from 0 degrees to 360 degrees to find the maximum reading.
- e. The test-receiver system was set to Peak Detect Function and Specified Bandwidth with Maximum Hold Mode.
- f. If the emission level of the EUT in peak mode was 10 dB lower than the limit specified, then testing could be stopped and the peak values of the EUT would be reported. Otherwise the emissions that did not have 10 dB margin would be re-tested one by one using peak, quasi-peak or average method as specified and then reported in a data sheet.

Note :

1. The resolution bandwidth and video bandwidth of test receiver/spectrum analyzer is 120 KHz for Peak detection (PK) and Quasi-peak detection (QP) at frequency below 1GHz.
2. The resolution bandwidth and video bandwidth of test receiver/spectrum analyzer is 1 MHz for Peak detection and frequency above 1GHz.
3. The resolution bandwidth of test receiver/spectrum analyzer is 1 MHz and the video bandwidth is 10 Hz for Average detection (AV) at frequency above 1GHz.

### 3.5 Uncertainty of Radiated Emission

The uncertainty of radiated emission is  $\pm 2.72$ dB.



### 3.6 Radiated RF Noise Measurement

#### 3.6.1 Spurious Emission Below 1GHz

The frequency spectrum from 30 MHz to 1000 MHz was investigated. All emissions not reported are much lower than the prescribed limits.

All readings are quasi-peak values.

Company	Z-Com, Inc.	Test Date	2005/01/24
Product Name	802.11a/b/g Wireless mini PCI Adapter	Test By	Alan Fan
Model Name	AG-622	TEMP&Humidity	23.7°C, 69%

Frequency (MHz)	Antenna Factor (dB/m)	Cable Loss (dB)	Meter Reading at 3m(dBμV)		Limits (dBμV/m)	Emission Level at 3m(dBμV/m)	
			Horizontal	Vertical		Horizontal	Vertical
30.00	17.01	0.97	*	*	40.00	*	*
122.51	13.14	2.19	12.20	9.20	43.50	27.52	24.52
133.12	12.54	2.32	15.50	12.00	43.50	30.37	26.87
150.00	11.64	2.53	10.00	14.10	43.50	24.17	28.27
200.46	9.83	3.15	18.80	13.50	43.50	31.77	26.47
265.47	12.96	4.10	12.30	10.80	46.00	29.36	27.86
319.99	14.49	4.41	16.00	9.20	46.00	34.90	28.10
375.00	17.19	4.71	15.80	14.50	46.00	37.70	36.40
399.99	18.41	4.85	16.50	10.50	46.00	39.76	33.76
425.72	18.26	4.94	6.50	8.00	46.00	29.70	31.20
472.49	17.99	5.10	2.50	1.50	46.00	25.59	24.59
500.03	17.83	5.19	3.80	1.90	46.00	26.82	24.92
1000.00	27.43	7.66	*	*	54.00	*	*

REMARKS : 1. \* Undetectable

2. Emission level (dBμV/m) = Antenna Factor (dB/m) + Cable loss (dB) + Meter Reading (dBμV).

3. The EUT can be operated in transmitting, receiveing and standby modes. According to technical experiences, the emissions of the EUT in transmitting mode generate highest spurious emission below 1GHz. The EUT was set to transmitting mode at channel 1 (5180MHz) to get the worst-case data while performing finial test below 1GHz.



### 3.6.2 Spurious Emission Outside of the 5.15 ~ 5.35GHz Band (TX)

The frequency spectrum above 1 GHz for Transmitter was investigated. All emissions not reported are much lower than the prescribed limits. Readings are both peak and average values.

Company	Z-Com, Inc.	Test Date	2005/01/20
Product Name	802.11a/b/g Wireless mini PCI Adapter	Test By	Alan Fan
Model Name	AG-622	TEMP&Humidity	17.6°C, 83%

CH1 (5180MHz) TX				Measurement Distance at 1m Horizontal polarity							
Freq. (MHz)	Reading (dBμV)	AF (dBμV)	Cable (dB)	Pre-amp (dB)	Dist (dB)	Filter (dB)	Level (dBμV/m)	Limit (dBμV/m)	Margin (dB)	Mark (P/Q/A)	Height (Meter)
* 3356.37	47.69	31.49	4.19	35.54	9.50	0.00	38.32	74.00	-35.68	P	1.00
* 3356.37	36.70	31.49	4.19	35.54	9.50	0.00	27.33	54.00	-26.67	A	1.00
* 4232.29	51.26	32.46	4.89	34.90	9.50	2.66	46.87	74.00	-27.13	P	1.02
* 4232.29	40.20	32.46	4.89	34.90	9.50	2.66	35.81	54.00	-18.19	A	1.02
* 5149.74	36.35	35.81	5.33	0.00	9.50	0.00	67.99	74.00	-6.01	P	1.07
* 5149.74	20.52	35.81	5.33	0.00	9.50	0.00	52.16	54.00	-1.84	A	1.07
5184.16	75.48	35.86	5.37	0.00	9.50	0.00	107.21	Fundamental Frequency		P	1.00
5184.16	66.84	35.86	5.37	0.00	9.50	0.00	98.57			A	1.00
7005.21	51.46	39.90	6.58	35.70	9.50	2.00	54.74	88.30	-33.56	P	1.05
7005.21	41.49	39.90	6.58	35.70	9.50	2.00	44.77	68.30	-23.53	A	1.05
10357.62	47.99	38.93	8.53	36.21	9.50	0.54	50.28	88.30	-38.02	P	1.00
10357.62	37.04	38.93	8.53	36.21	9.50	0.54	39.33	68.30	-28.97	A	1.00
* 15538.49	44.83	45.16	8.72	35.76	9.50	0.30	53.76	74.00	-20.24	P	1.00
* 15538.49	35.04	45.16	8.72	35.76	9.50	0.30	43.97	54.00	-10.03	A	1.00
* 20736.64	-----	-----	-----	-----	0.00	5.09	-----	-----	-----	-----	1.00
25920.80	-----	-----	-----	-----	0.00	1.58	-----	-----	-----	-----	1.00
31104.96	-----	-----	-----	-----	0.00	0.00	-----	-----	-----	-----	1.00
36289.12	-----	-----	-----	-----	0.00	0.00	-----	-----	-----	-----	1.00
* 41473.28	-----	-----	-----	-----	0.00	0.00	-----	-----	-----	-----	1.00
* 46657.44	-----	-----	-----	-----	0.00	0.00	-----	-----	-----	-----	1.00
* 51841.60	-----	-----	-----	-----	0.00	0.00	-----	-----	-----	-----	1.00

#### Note :

- The measurement was searched to 10<sup>th</sup> harmonic, Remark "-----" means that the emissions level is too low to be measured.
- AF: Antenna Factor, Cable: Cable Loss, Pre-Amp: Preamplifier gain, Filter: High Pass Filter Insertion Loss (8.2GHz)
- Spectrum analyzer setting P(Peak): RBW=1MHz, VBW=1MHz, A(Average): RBW=1MHz, VBW=10Hz
- Remark "\*" means that Restricted band.
- Dist : correction to extra plate reading to 3m specification distance 1m measurement distance = -9.5dB
- The result basic equation calculation is as follow:  
Level=Reading + AF + Cable – Preamp + Filter – Dist, Margin = Level-Limit
- The test limit distance is 3M limit.
- For normal 802.11a mode.
- The test data marked in gray background means the EUT emission data is located in the margin uncertainty range of emission limits.



The frequency spectrum above 1 GHz for Transmitter was investigated. All emissions not reported are much lower than the prescribed limits. Readings are both peak and average values.

Company	Z-Com, Inc.	Test Date	2005/01/20
Product Name	802.11a/b/g Wireless mini PCI Adapter	Test By	Alan Fan
Model Name	AG-622	TEMP&Humidity	17.6°C, 83%

CH1 (5180MHz) TX				Measurement Distance at 1m Vertical polarity								
Freq. (MHz)	Reading (dBμV)	AF (dBμV)	Cable (dB)	Pre-amp (dB)	Dist (dB)	Filter (dB)	Level (dBμV/m)	Limit (dBμV/m)	Margin (dB)	Mark (P/Q/A)	Height (Meter)	
*	3356.50	50.03	31.49	4.19	35.54	9.50	0.00	40.66	74.00	-33.34	P	1.00
*	3356.50	39.74	31.49	4.19	35.54	9.50	0.00	30.37	54.00	-23.63	A	1.00
*	4232.69	45.12	32.46	4.89	34.90	9.50	2.66	40.73	74.00	-33.27	P	1.00
*	4232.69	33.87	32.46	4.89	34.90	9.50	2.66	29.48	54.00	-24.52	A	1.00
*	5149.74	28.07	35.81	5.33	0.00	9.50	0.00	59.71	74.00	-14.29	P	1.04
*	5149.74	15.41	35.81	5.33	0.00	9.50	0.00	47.05	54.00	-6.95	A	1.04
	5182.84	63.53	35.86	5.37	0.00	9.50	0.00	95.26	Fundamental Frequency		P	1.00
	5182.84	55.40	35.86	5.37	0.00	9.50	0.00	87.13			A	1.00
	7005.28	44.25	39.90	6.58	35.70	9.50	0.00	45.53	88.30	-42.77	P	1.00
	7005.28	32.79	39.90	6.58	35.70	9.50	0.00	34.07	68.30	-34.23	A	1.00
	10359.64	49.71	38.93	8.53	36.21	9.50	0.54	52.00	88.30	-36.30	P	1.06
	10359.64	38.82	38.93	8.53	36.21	9.50	0.54	41.11	68.30	-27.19	A	1.06
*	15539.87	45.16	45.16	8.72	35.76	9.50	0.30	54.08	74.00	-19.92	P	1.00
*	15539.87	34.25	45.16	8.72	35.76	9.50	0.30	43.17	54.00	-10.83	A	1.00
*	20731.36	-----	-----	-----	-----	0.00	5.08	-----	-----	-----	-----	1.00
	25914.20	-----	-----	-----	-----	0.00	1.58	-----	-----	-----	-----	1.00
	31097.04	-----	-----	-----	-----	0.00	0.00	-----	-----	-----	-----	1.00
	36279.88	-----	-----	-----	-----	0.00	0.00	-----	-----	-----	-----	1.00
*	41462.72	-----	-----	-----	-----	0.00	0.00	-----	-----	-----	-----	1.00
*	46645.56	-----	-----	-----	-----	0.00	0.00	-----	-----	-----	-----	1.00
*	51828.40	-----	-----	-----	-----	0.00	0.00	-----	-----	-----	-----	1.00

## Note :

- The measurement was searched to 10th harmonic, Remark "-----" means that the emissions level is too low to be measured.
- AF: Antenna Factor, Cable: Cable Loss, Pre-Amp: Preamplifier gain, Filter: High Pass Filter Insertion Loss (8.2GHz)
- Spectrum analyzer setting P(Peak): RBW=1MHz, VBW=1MHz, A(Average): RBW=1MHz, VBW=10Hz
- Remark "\*" means that Restricted band.
- Dist : correction to extra plate reading to 3m specification distance 1m measurement distance = -9.5dB
- The result basic equation calculation is as follow:  
Level = Reading + AF + Cable - Preamp + Filter - Dist, Margin = Level - Limit
- The test limit distance is 3M limit.
- For normal 802.11a mode.





The frequency spectrum above 1 GHz for Transmitter was investigated. All emissions not reported are much lower than the prescribed limits. Readings are both peak and average values.

Company	Z-Com, Inc.	Test Date	2005/01/20
Product Name	802.11a/b/g Wireless mini PCI Adapter	Test By	Alan Fan
Model Name	AG-622	TEMP&Humidity	17.6°C, 83%

CH4 (5240MHz) TX				Measurement Distance at 1m Horizontal polarity							
Freq. (MHz)	Reading (dBμV)	AF (dBμV)	Cable (dB)	Pre-amp (dB)	Dist (dB)	Filter (dB)	Level (dBμV/m)	Limit (dBμV/m)	Margin (dB)	Mark (P/Q/A)	Height (Meter)
3417.32	56.84	31.45	4.25	35.48	9.50	0.00	47.56	88.30	-40.74	P	1.05
3417.32	40.12	31.45	4.25	35.48	9.50	0.00	30.84	68.30	-37.46	A	1.05
* 4293.41	52.20	32.42	4.91	34.90	9.50	0.00	45.14	74.00	-28.86	P	1.36
* 4293.41	39.65	32.42	4.91	34.90	9.50	0.00	32.59	54.00	-21.41	A	1.36
7058.11	55.06	39.88	6.62	35.69	9.50	0.00	56.37	88.30	-31.93	P	1.12
7058.11	39.88	39.88	6.62	35.69	9.50	0.00	41.19	68.30	-27.11	A	1.12
10479.67	49.09	39.08	8.56	35.94	9.50	0.59	51.88	88.30	-36.42	P	1.00
10479.67	38.40	39.08	8.56	35.94	9.50	0.59	41.19	68.30	-27.11	A	1.00
* 15720.00	47.34	44.51	8.84	36.03	9.50	0.30	55.45	74.00	-18.55	P	1.00
* 15720.00	36.82	44.51	8.84	36.03	9.50	0.30	44.93	54.00	-9.07	A	1.00
* 20959.34	-----	-----	-----	-----	0.00	5.82	-----	-----	-----	-----	1.00
26199.18	-----	-----	-----	-----	0.00	1.80	-----	-----	-----	-----	1.00
* 31439.01	-----	-----	-----	-----	0.00	0.00	-----	-----	-----	-----	1.00
36678.85	-----	-----	-----	-----	0.00	0.00	-----	-----	-----	-----	1.00
* 41918.68	-----	-----	-----	-----	0.00	0.00	-----	-----	-----	-----	1.00
* 47158.52	-----	-----	-----	-----	0.00	0.00	-----	-----	-----	-----	1.00
* 52398.35	-----	-----	-----	-----	0.00	0.00	-----	-----	-----	-----	1.00

Note :

- The measurement was searched to 10th harmonic, Remark "-----" means that the emissions level is too low to be measured.
- AF: Antenna Factor, Cable: Cable Loss, Pre-Amp: Preamplifier gain, Filter: High Pass Filter Insertion Loss (8.2GHz)
- Spectrum analyzer setting P(Peak): RBW=1MHz, VBW=1MHz, A(Average): RBW=1MHz, VBW=10Hz
- Remark "\*" means that Restricted band.
- Dist : correction to extra plate reading to 3m specification distance 1m measurement distance = -9.5dB
- The result basic equation calculation is as follow:  
Level = Reading + AF + Cable – Preamp + Filter - Dist, Margin = Level - Limit
- The test limit distance is 3M limit.
- For normal 802.11a mode.



The frequency spectrum above 1 GHz for Transmitter was investigated. All emissions not reported are much lower than the prescribed limits. Readings are both peak and average values.

Company	Z-Com, Inc.	Test Date	2005/01/20
Product Name	802.11a/b/g Wireless mini PCI Adapter	Test By	Alan Fan
Model Name	AG-622	TEMP&Humidity	17.6°C, 83%

CH4 (5240MHz) TX				Measurement Distance at 1m Vertical polarity							
Freq. (MHz)	Reading (dBμV)	AF (dBμV)	Cable (dB)	Pre-amp (dB)	Dist (dB)	Filter (dB)	Level (dBμV/m)	Limit (dBμV/m)	Margin (dB)	Mark (P/Q/A)	Height (Meter)
3417.21	49.85	31.45	4.25	35.48	9.50	0.00	40.57	88.30	-47.73	P	1.03
3417.21	38.46	31.45	4.25	35.48	9.50	0.00	29.18	68.30	-39.12	A	1.03
* 4293.50	43.82	32.42	4.91	34.90	9.50	0.00	36.76	74.00	-37.24	P	1.02
* 4293.50	34.20	32.42	4.91	34.90	9.50	0.00	27.14	54.00	-26.86	A	1.02
7058.23	45.27	39.88	6.62	35.69	9.50	0.00	46.58	88.30	-41.72	P	1.05
7058.23	32.89	39.88	6.62	35.69	9.50	0.00	34.20	68.30	-34.10	A	1.05
10479.37	50.12	39.08	8.56	35.95	9.50	0.59	52.91	88.30	-35.39	P	1.00
10479.37	38.65	39.08	8.56	35.95	9.50	0.59	41.44	68.30	-26.86	A	1.00
* 15718.45	47.66	44.51	8.84	36.03	9.50	0.30	55.78	74.00	-18.22	P	1.00
* 15718.45	36.97	44.51	8.84	36.03	9.50	0.30	45.09	54.00	-8.91	A	1.00
* 20958.74	-----	-----	-----	-----	0.00	5.82	-----	-----	-----	-----	1.00
26198.43	-----	-----	-----	-----	0.00	1.80	-----	-----	-----	-----	1.00
* 31438.11	-----	-----	-----	-----	0.00	0.00	-----	-----	-----	-----	1.00
36677.80	-----	-----	-----	-----	0.00	0.00	-----	-----	-----	-----	1.00
* 41917.48	-----	-----	-----	-----	0.00	0.00	-----	-----	-----	-----	1.00
* 47157.17	-----	-----	-----	-----	0.00	0.00	-----	-----	-----	-----	1.00
* 52396.85	-----	-----	-----	-----	0.00	0.00	-----	-----	-----	-----	1.00

Note :

- The measurement was searched to 10th harmonic, Remark "-----" means that the emissions level is too low to be measured.
- AF: Antenna Factor, Cable: Cable Loss, Pre-Amp: Preamplifier gain, Filter: High Pass Filter Insertion Loss (8.2GHz)
- Spectrum analyzer setting P(Peak): RBW=1MHz, VBW=1MHz, A(Average): RBW=1MHz, VBW=10Hz
- Remark "\*" means that Restricted band.
- Dist : correction to extra plate reading to 3m specification distance 1m measurement distance = -9.5dB
- The result basic equation calculation is as follow:  
Level = Reading + AF + Cable – Preamp + Filter - Dist, Margin = Level - Limit
- The test limit distance is 3M limit.
- For normal 802.11a mode.



The frequency spectrum above 1 GHz for Transmitter was investigated. All emissions not reported are much lower than the prescribed limits. Readings are both peak and average values.

Company	Z-Com, Inc.	Test Date	2005/01/20
Product Name	802.11a/b/g Wireless mini PCI Adapter	Test By	Alan Fan
Model Name	AG-622	TEMP&Humidity	17.6°C, 83%

CH5 (5260MHz) TX				Measurement Distance at 1m Horizontal polarity							
Freq. (MHz)	Reading (dBμV)	AF (dBμV)	Cable (dB)	Pre-amp (dB)	Dist (dB)	Filter (dB)	Level (dBμV/m)	Limit (dBμV/m)	Margin (dB)	Mark (P/Q/A)	Height (Meter)
3435.37	59.09	31.44	4.27	35.46	9.50	0.00	49.83	88.30	-38.47	P	1.06
3435.37	48.25	31.44	4.27	35.46	9.50	0.00	38.99	68.30	-29.31	A	1.06
* 4313.34	49.96	32.41	4.92	34.90	9.50	0.00	42.89	74.00	-31.11	P	1.31
* 4313.34	40.49	32.41	4.92	34.90	9.50	0.00	33.42	54.00	-20.58	A	1.31
7084.31	47.39	39.87	6.64	35.68	9.50	0.00	48.71	88.30	-39.59	P	1.19
7084.31	37.21	39.87	6.64	35.68	9.50	0.00	38.53	68.30	-29.77	A	1.19
10517.92	49.46	39.12	8.58	35.90	9.50	0.63	52.38	88.30	-35.92	P	1.07
10517.92	38.89	39.12	8.58	35.90	9.50	0.63	41.81	68.30	-26.49	A	1.07
* 15777.89	48.80	44.30	8.87	36.12	9.50	0.30	56.66	74.00	-17.34	P	1.04
* 15777.89	37.69	44.30	8.87	36.12	9.50	0.30	45.55	54.00	-8.45	A	1.04
* 21035.84	-----	-----	-----	-----	0.00	5.59	-----	-----	-----	-----	1.00
26294.80	-----	-----	-----	-----	0.00	1.89	-----	-----	-----	-----	1.00
* 31553.76	-----	-----	-----	-----	0.00	0.00	-----	-----	-----	-----	1.00
36812.72	-----	-----	-----	-----	0.00	0.00	-----	-----	-----	-----	1.00
* 42071.68	-----	-----	-----	-----	0.00	0.00	-----	-----	-----	-----	1.00
* 47330.64	-----	-----	-----	-----	0.00	0.00	-----	-----	-----	-----	1.00
* 52589.60	-----	-----	-----	-----	0.00	0.00	-----	-----	-----	-----	1.00

Note :

- The measurement was searched to 10th harmonic, Remark "-----" means that the emissions level is too low to be measured.
- AF: Antenna Factor, Cable: Cable Loss, Pre-Amp: Preamplifier gain, Filter: High Pass Filter Insertion Loss (8.2GHz)
- Spectrum analyzer setting P(Peak): RBW=1MHz, VBW=1MHz, A(Average): RBW=1MHz, VBW=10Hz
- Remark "\*" means that Restricted band.
- Dist : correction to extra plate reading to 3m specification distance 1m measurement distance = -9.5dB
- The result basic equation calculation is as follow:  
Level = Reading + AF + Cable – Preamp + Filter - Dist, Margin = Level - Limit
- The test limit distance is 3M limit.
- For normal 802.11a mode.



The frequency spectrum above 1 GHz for Transmitter was investigated. All emissions not reported are much lower than the prescribed limits. Readings are both peak and average values.

Company	Z-Com, Inc.	Test Date	2005/01/20
Product Name	802.11a/b/g Wireless mini PCI Adapter	Test By	Alan Fan
Model Name	AG-622	TEMP&Humidity	17.6°C, 83%

CH5 (5260MHz) TX				Measurement Distance at 1m Vertical polarity							
Freq. (MHz)	Reading (dBμV)	AF (dBμV)	Cable (dB)	Pre-amp (dB)	Dist (dB)	Filter (dB)	Level (dBμV/m)	Limit (dBμV/m)	Margin (dB)	Mark (P/Q/A)	Height (Meter)
3435.66	50.12	31.44	4.27	35.46	9.50	0.00	40.86	88.30	-47.44	P	1.02
3435.66	39.87	31.44	4.27	35.46	9.50	0.00	30.61	68.30	-37.69	A	1.02
* 4314.01	43.52	32.41	4.92	34.90	9.50	0.00	36.45	74.00	-37.55	P	1.00
* 4314.01	33.17	32.41	4.92	34.90	9.50	0.00	26.10	54.00	-27.90	A	1.00
7085.12	43.12	39.87	6.64	35.68	9.50	0.00	44.44	88.30	-43.86	P	1.01
7085.12	32.54	39.87	6.64	35.68	9.50	0.00	33.86	68.30	-34.44	A	1.01
10518.86	50.22	39.12	8.58	35.90	9.50	0.63	53.14	88.30	-35.16	P	1.02
10518.86	39.15	39.12	8.58	35.90	9.50	0.63	42.07	68.30	-26.23	A	1.02
* 15777.08	47.19	44.30	8.87	36.12	9.50	0.30	55.05	74.00	-18.95	P	1.00
* 15777.08	36.92	44.30	8.87	36.12	9.50	0.30	44.78	54.00	-9.22	A	1.00
* 21037.72	-----	-----	-----	-----	0.00	5.57	-----	-----	-----	-----	1.00
26297.15	-----	-----	-----	-----	0.00	1.90	-----	-----	-----	-----	1.00
* 31556.58	-----	-----	-----	-----	0.00	0.00	-----	-----	-----	-----	1.00
36816.01	-----	-----	-----	-----	0.00	0.00	-----	-----	-----	-----	1.00
* 42075.44	-----	-----	-----	-----	0.00	0.00	-----	-----	-----	-----	1.00
* 47334.87	-----	-----	-----	-----	0.00	0.00	-----	-----	-----	-----	1.00
* 52594.30	-----	-----	-----	-----	0.00	0.00	-----	-----	-----	-----	1.00

Note :

- The measurement was searched to 10th harmonic, Remark "-----" means that the emissions level is too low to be measured.
- AF: Antenna Factor, Cable: Cable Loss, Pre-Amp: Preamplifier gain, Filter: High Pass Filter Insertion Loss (8.2GHz)
- Spectrum analyzer setting P(Peak): RBW=1MHz, VBW=1MHz, A(Average): RBW=1MHz, VBW=10Hz
- Remark "\*" means that Restricted band.
- Dist : correction to extra plate reading to 3m specification distance 1m measurement distance = -9.5dB
- The result basic equation calculation is as follow:  
Level = Reading + AF + Cable – Preamp + Filter - Dist, Margin = Level - Limit
- The test limit distance is 3M limit.
- For normal 802.11a mode.



The frequency spectrum above 1 GHz for Transmitter was investigated. All emissions not reported are much lower than the prescribed limits. Readings are both peak and average values.

Company	Z-Com, Inc.	Test Date	2005/01/20
Product Name	802.11a/b/g Wireless mini PCI Adapter	Test By	Alan Fan
Model Name	AG-622	TEMP&Humidity	17.6°C, 83%

CH8 (5320MHz) TX				Measurement Distance at 1m Horizontal polarity							
Freq. (MHz)	Reading (dBμV)	AF (dBμV)	Cable (dB)	Pre-amp (dB)	Dist (dB)	Filter (dB)	Level (dBμV/m)	Limit (dBμV/m)	Margin (dB)	Mark (P/Q/A)	Height (Meter)
3494.47	56.85	31.40	4.32	35.41	9.50	0.00	47.67	88.30	-40.63	P	1.00
3494.47	45.26	31.40	4.32	35.41	9.50	0.00	36.08	68.30	-32.22	A	1.00
* 4372.87	48.69	32.38	4.94	34.90	9.50	0.00	41.61	74.00	-32.39	P	1.16
* 4372.87	37.68	32.38	4.94	34.90	9.50	0.00	30.60	54.00	-23.40	A	1.16
5321.42	75.34	36.05	5.54	0.00	9.50	0.00	107.43	Fundamental Frequency		P	1.00
5321.42	66.51	36.05	5.54	0.00	9.50	0.00	98.60			A	1.00
* 5350.40	29.28	36.09	5.58	0.00	9.50	0.00	61.45	74.00	-12.55	P	1.07
* 5350.40	17.00	36.09	5.58	0.00	9.50	0.00	49.17	54.00	-4.83	A	1.07
7144.93	49.24	39.84	6.68	35.67	9.50	0.00	50.59	88.30	-37.71	P	1.08
7144.93	39.54	39.84	6.68	35.67	9.50	0.00	40.89	68.30	-27.41	A	1.08
* 10637.97	46.87	39.27	8.61	35.90	9.50	0.79	50.14	74.00	-23.86	P	1.00
* 10637.97	35.12	39.27	8.61	35.90	9.50	0.79	38.39	54.00	-15.61	A	1.00
* 15960.02	49.38	43.64	8.99	36.39	9.50	0.30	56.42	74.00	-17.58	P	1.02
* 15960.02	38.98	43.64	8.99	36.39	9.50	0.30	46.02	54.00	-7.98	A	1.02
* 21285.68	-----	-----	-----	-----	0.00	3.06	-----	-----	-----	-----	1.00
26607.10	-----	-----	-----	-----	0.00	2.14	-----	-----	-----	-----	1.00
31928.52	-----	-----	-----	-----	0.00	0.00	-----	-----	-----	-----	1.00
37249.94	-----	-----	-----	-----	0.00	0.00	-----	-----	-----	-----	1.00
* 42571.36	-----	-----	-----	-----	0.00	0.00	-----	-----	-----	-----	1.00
* 47892.78	-----	-----	-----	-----	0.00	0.00	-----	-----	-----	-----	1.00
* 53214.20	-----	-----	-----	-----	0.00	0.00	-----	-----	-----	-----	1.00

Note :

- The measurement was searched to 10<sup>th</sup> harmonic, Remark "-----" means that the emissions level is too low to be measured.
- AF: Antenna Factor, Cable: Cable Loss, Pre-Amp: Preamplifier gain, Filter: High Pass Filter Insertion Loss (3.5GHz)
- Spectrum analyzer setting P(Peak): RBW=1MHz, VBW=1MHz, A(Average): RBW=1MHz, VBW=10Hz
- Remark "\*" means that Restricted band.
- Dist : correction to extra plate reading to 3m specification distance 1m measurement distance = -9.5dB
- The result basic equation calculation is as follow:  
Level=Reading + AF + Cable – Preamp + Filter – Dist, Margin = Level-Limit
- The test limit distance is 3M limit.
- For normal 802.11a mode.



The frequency spectrum above 1 GHz for Transmitter was investigated. All emissions not reported are much lower than the prescribed limits. Readings are both peak and average values.

Company	Z-Com, Inc.	Test Date	2005/01/20
Product Name	802.11a/b/g Wireless mini PCI Adapter	Test By	Alan Fan
Model Name	AG-622	TEMP&Humidity	17.6°C, 83%

CH8 (5320MHz) TX				Measurement Distance at 1m Vertical polarity							
Freq. (MHz)	Reading (dBμV)	AF (dBμV)	Cable (dB)	Pre-amp (dB)	Dist (dB)	Filter (dB)	Level (dBμV/m)	Limit (dBμV/m)	Margin (dB)	Mark (P/Q/A)	Height (Meter)
3495.12	56.90	31.40	4.33	35.40	9.50	0.00	47.72	88.30	-40.58	P	1.00
3495.12	40.30	31.40	4.33	35.40	9.50	0.00	31.12	68.30	-37.18	A	1.00
* 4372.87	44.32	32.38	4.94	34.90	9.50	0.00	37.24	74.00	-36.76	P	1.00
* 4372.87	33.09	32.38	4.94	34.90	9.50	0.00	26.01	54.00	-27.99	A	1.00
5321.53	64.95	36.05	5.55	0.00	9.50	0.00	97.05	Fundamental Frequency		P	1.00
5321.53	56.18	36.05	5.55	0.00	9.50	0.00	88.28			A	1.00
* 5350.40	27.52	36.09	5.58	0.00	9.50	0.00	59.69	74.00	-14.31	P	1.07
* 5350.40	15.41	36.09	5.58	0.00	9.50	0.00	47.58	54.00	-6.42	A	1.07
7144.96	45.32	39.84	6.68	35.67	9.50	0.00	46.67	88.30	-41.63	P	1.10
7144.96	33.26	39.84	6.68	35.67	9.50	0.00	34.61	68.30	-33.69	A	1.10
* 10636.69	45.69	39.26	8.61	35.90	9.50	0.79	48.96	74.00	-25.04	P	1.08
* 10636.69	35.22	39.26	8.61	35.90	9.50	0.79	38.49	54.00	-15.51	A	1.08
* 15960.45	51.30	43.64	8.99	36.39	9.50	0.30	58.34	74.00	-15.66	P	1.00
* 15960.45	40.25	43.64	8.99	36.39	9.50	0.30	47.29	54.00	-6.71	A	1.00
* 21286.12	-----	-----	-----	-----	0.00	3.06	-----	-----	-----	-----	1.00
26607.65	-----	-----	-----	-----	0.00	2.14	-----	-----	-----	-----	1.00
31929.18	-----	-----	-----	-----	0.00	0.00	-----	-----	-----	-----	1.00
37250.71	-----	-----	-----	-----	0.00	0.00	-----	-----	-----	-----	1.00
* 42572.24	-----	-----	-----	-----	0.00	0.00	-----	-----	-----	-----	1.00
* 47893.77	-----	-----	-----	-----	0.00	0.00	-----	-----	-----	-----	1.00
* 53215.30	-----	-----	-----	-----	0.00	0.00	-----	-----	-----	-----	1.00

Note :

- The measurement was searched to 10th harmonic, Remark "-----" means that the emissions level is too low to be measured.
- AF: Antenna Factor, Cable: Cable Loss, Pre-Amp: Preamplifier gain, Filter: High Pass Filter Insertion Loss (3.5GHz)
- Spectrum analyzer setting P(Peak): RBW=1MHz, VBW=1MHz, A(Average): RBW=1MHz, VBW=10Hz
- Remark "\*" means that Restricted band.
- Dist : correction to extra plate reading to 3m specification distance 1m measurement distance = -9.5dB
- The result basic equation calculation is as follow:  
Level = Reading + AF + Cable – Preamp + Filter - Dist, Margin = Level - Limit
- The test limit distance is 3M limit.
- For normal 802.11a mode.



The frequency spectrum above 1 GHz for Transmitter was investigated. All emissions not reported are much lower than the prescribed limits. Readings are both peak and average values.

Company	Z-Com, Inc.	Test Date	2005/01/13
Product Name	802.11a/b/g Wireless mini PCI Adapter	Test By	Alan Fan
Model Name	AG-622	TEMP&Humidity	18.9°C, 68%

Low (5200MHz) TX				Measurement Distance at 1m Horizontal polarity							
Freq. (MHz)	Reading (dBμV)	AF (dBμV)	Cable (dB)	Pre-amp (dB)	Dist (dB)	Filter (dB)	Level (dBμV/m)	Limit (dBμV/m)	Margin (dB)	Mark (P/Q/A)	Height (Meter)
3371.07	47.43	31.48	4.20	35.53	9.50	0.00	38.08	88.30	-50.22	P	1.04
3371.07	37.90	31.48	4.20	35.53	9.50	0.00	28.55	68.30	-39.75	A	1.04
* 4257.51	45.02	32.45	4.90	34.90	9.50	0.00	37.97	74.00	-36.03	P	1.05
* 4257.51	34.24	32.45	4.90	34.90	9.50	0.00	27.19	54.00	-26.81	A	1.05
* 5149.74	31.01	35.81	5.33	0.00	9.50	0.00	62.65	74.00	-11.35	P	1.19
* 5149.74	18.34	35.81	5.33	0.00	9.50	0.00	49.98	54.00	-4.02	A	1.19
5192.61	69.23	35.87	5.38	0.00	9.50	0.00	100.98	Fundamental Frequency		P	1.00
5192.61	59.59	35.87	5.38	0.00	9.50	0.00	91.34			A	1.00
7014.02	50.50	39.89	6.59	35.70	9.50	0.00	51.79	88.30	-36.51	P	1.08
7014.02	39.37	39.89	6.59	35.70	9.50	0.00	40.66	68.30	-27.64	A	1.08
10398.94	45.01	38.98	8.54	36.12	9.50	0.56	47.47	88.30	-40.83	P	1.00
10398.94	33.48	38.98	8.54	36.12	9.50	0.56	35.94	68.30	-32.36	A	1.00
* 15600.00	43.25	44.94	8.76	35.85	9.50	0.30	51.90	74.00	-22.10	P	1.00
* 15600.00	32.87	44.94	8.76	35.85	9.50	0.30	41.52	54.00	-12.48	A	1.00
* 20770.44	-----	-----	-----	-----	0.00	5.20	-----	-----	-----	-----	1.00
25963.05	-----	-----	-----	-----	0.00	1.59	-----	-----	-----	-----	1.00
31155.66	-----	-----	-----	-----	0.00	0.00	-----	-----	-----	-----	1.00
36348.27	-----	-----	-----	-----	0.00	0.00	-----	-----	-----	-----	1.00
* 41540.88	-----	-----	-----	-----	0.00	0.00	-----	-----	-----	-----	1.00
* 46733.49	-----	-----	-----	-----	0.00	0.00	-----	-----	-----	-----	1.00
* 51926.10	-----	-----	-----	-----	0.00	0.00	-----	-----	-----	-----	1.00

Note :

- The measurement was searched to 10th harmonic, Remark "-----" means that the emissions level is too low to be measured.
- AF: Antenna Factor, Cable: Cable Loss, Pre-Amp: Preamplifier gain, Filter: High Pass Filter Insertion Loss (3.5GHz)
- Spectrum analyzer setting P(Peak): RBW=1MHz, VBW=1MHz, A(Average): RBW=1MHz, VBW=10Hz
- Remark "\*" means that Restricted band.
- Dist : correction to extra plate reading to 3m specification distance 1m measurement distance = -9.5dB
- The result basic equation calculation is as follow:  
Level = Reading + AF + Cable – Preamp + Filter - Dist, Margin = Level - Limit
- The test limit distance is 3M limit.
- For Super A mode.



The frequency spectrum above 1 GHz for Transmitter was investigated. All emissions not reported are much lower than the prescribed limits. Readings are both peak and average values.

Company	Z-Com, Inc.	Test Date	2005/01/13
Product Name	802.11a/b/g Wireless mini PCI Adapter	Test By	Alan Fan
Model Name	AG-622	TEMP&Humidity	18.9°C, 68%

Low (5200MHz) TX				Measurement Distance at 1m Vertical polarity							
Freq. (MHz)	Reading (dBμV)	AF (dBμV)	Cable (dB)	Pre-amp (dB)	Dist (dB)	Filter (dB)	Level (dBμV/m)	Limit (dBμV/m)	Margin (dB)	Mark (P/Q/A)	Height (Meter)
3367.98	45.48	31.48	4.20	35.53	9.50	0.00	36.13	88.30	-52.17	P	1.00
3367.98	34.26	31.48	4.20	35.53	9.50	0.00	24.91	68.30	-43.39	A	1.00
* 4257.51	45.85	32.45	4.90	34.90	9.50	0.00	38.80	74.00	-35.20	P	1.00
* 4257.51	33.27	32.45	4.90	34.90	9.50	0.00	26.22	54.00	-27.78	A	1.00
* 5149.74	29.12	35.81	5.33	0.00	9.50	0.00	60.76	74.00	-13.24	P	1.04
* 5149.74	15.41	35.81	5.33	0.00	9.50	0.00	47.05	54.00	-6.95	A	1.04
5193.28	64.20	35.87	5.38	0.00	9.50	0.00	95.95	Fundamental Frequency		P	1.00
5193.28	54.82	35.87	5.38	0.00	9.50	0.00	86.57			A	1.00
7022.13	44.12	39.89	6.60	35.70	9.50	0.00	45.41	88.30	-42.89	P	1.00
7022.13	33.54	39.89	6.60	35.70	9.50	0.00	34.83	68.30	-33.47	A	1.00
10395.11	44.17	38.97	8.54	36.13	9.50	0.56	46.61	88.30	-41.69	P	1.15
10395.11	33.79	38.97	8.54	36.13	9.50	0.56	36.23	68.30	-32.07	A	1.15
* 15600.00	43.69	44.94	8.76	35.85	9.50	0.30	52.34	74.00	-21.66	P	1.00
* 15600.00	33.85	44.94	8.76	35.85	9.50	0.30	42.50	54.00	-11.50	A	1.00
* 20773.12	-----	-----	-----	-----	0.00	5.21	-----	-----	-----	-----	1.00
25966.40	-----	-----	-----	-----	0.00	1.59	-----	-----	-----	-----	1.00
31159.68	-----	-----	-----	-----	0.00	0.00	-----	-----	-----	-----	1.00
36352.96	-----	-----	-----	-----	0.00	0.00	-----	-----	-----	-----	1.00
* 41546.24	-----	-----	-----	-----	0.00	0.00	-----	-----	-----	-----	1.00
* 46739.52	-----	-----	-----	-----	0.00	0.00	-----	-----	-----	-----	1.00
* 51932.80	-----	-----	-----	-----	0.00	0.00	-----	-----	-----	-----	1.00

- Note :
- The measurement was searched to 10th harmonic, Remark "-----" means that the emissions level is too low to be measured.
  - AF: Antenna Factor, Cable: Cable Loss, Pre-Amp: Preamplifier gain, Filter: High Pass Filter Insertion Loss (3.5GHz)
  - Spectrum analyzer setting P(Peak): RBW=1MHz, VBW=1MHz, A(Average): RBW=1MHz, VBW=10Hz
  - Remark "\*" means that Restricted band.
  - Dist : correction to extra plate reading to 3m specification distance 1m measurement distance = -9.5dB
  - The result basic equation calculation is as follow:  

$$\text{Level} = \text{Reading} + \text{AF} + \text{Cable} - \text{Preamp} + \text{Filter} - \text{Dist}, \text{Margin} = \text{Level} - \text{Limit}$$
  - The test limit distance is 3M limit.
  - For Super A mode.





The frequency spectrum above 1 GHz for Transmitter was investigated. All emissions not reported are much lower than the prescribed limits. Readings are both peak and average values.

Company	Z-Com, Inc.	Test Date	2005/01/13
Product Name	802.11a/b/g Wireless mini PCI Adapter	Test By	Alan Fan
Model Name	AG-622	TEMP&Humidity	18.9°C, 68%

Middle (5240MHz) TX				Measurement Distance at 1m Horizontal polarity							
Freq. (MHz)	Reading (dBμV)	AF (dBμV)	Cable (dB)	Pre-amp (dB)	Dist (dB)	Filter (dB)	Level (dBμV/m)	Limit (dBμV/m)	Margin (dB)	Mark (P/Q/A)	Height (Meter)
3417.09	54.23	31.45	4.25	35.48	9.50	0.00	44.95	88.30	-43.35	P	1.00
3417.09	45.37	31.45	4.25	35.48	9.50	0.00	36.09	68.30	-32.21	A	1.00
* 4298.59	51.44	32.42	4.92	34.90	9.50	0.00	44.38	74.00	-29.62	P	1.28
* 4298.59	41.41	32.42	4.92	34.90	9.50	0.00	34.35	54.00	-19.65	A	1.28
7063.13	57.38	39.87	6.62	35.69	9.50	0.00	58.69	88.30	-29.61	P	1.06
7063.13	43.20	39.87	6.62	35.69	9.50	0.00	44.51	68.30	-23.79	A	1.06
10481.55	47.03	39.08	8.56	35.94	9.50	0.59	49.82	88.30	-38.48	P	1.00
10481.55	36.91	39.08	8.56	35.94	9.50	0.59	39.70	68.30	-28.60	A	1.00
* 15713.20	46.83	44.53	8.83	36.02	9.50	0.30	54.97	74.00	-19.03	P	1.00
* 15713.20	36.26	44.53	8.83	36.02	9.50	0.30	44.40	54.00	-9.60	A	1.00
* 20963.10	-----	-----	-----	-----	0.00	5.83	-----	-----	-----	-----	1.00
26203.88	-----	-----	-----	-----	0.00	1.80	-----	-----	-----	-----	1.00
* 31444.65	-----	-----	-----	-----	0.00	0.00	-----	-----	-----	-----	1.00
36685.43	-----	-----	-----	-----	0.00	0.00	-----	-----	-----	-----	1.00
* 41926.20	-----	-----	-----	-----	0.00	0.00	-----	-----	-----	-----	1.00
* 47166.98	-----	-----	-----	-----	0.00	0.00	-----	-----	-----	-----	1.00
* 52407.75	-----	-----	-----	-----	0.00	0.00	-----	-----	-----	-----	1.00

Note :

- The measurement was searched to 10th harmonic, Remark "-----" means that the emissions level is too low to be measured.
- AF: Antenna Factor, Cable: Cable Loss, Pre-Amp: Preamplifier gain, Filter: High Pass Filter Insertion Loss (3.5GHz)
- Spectrum analyzer setting P(Peak): RBW=1MHz, VBW=1MHz, A(Average): RBW=1MHz, VBW=10Hz
- Remark "\*" means that Restricted band.
- Dist : correction to extra plate reading to 3m specification distance 1m measurement distance = -9.5dB
- The result basic equation calculation is as follow:  
Level = Reading + AF + Cable – Preamp + Filter - Dist, Margin = Level - Limit
- The test limit distance is 3M limit.
- For Super A mode.



The frequency spectrum above 1 GHz for Transmitter was investigated. All emissions not reported are much lower than the prescribed limits. Readings are both peak and average values.

Company	Z-Com, Inc.	Test Date	2005/01/13
Product Name	802.11a/b/g Wireless mini PCI Adapter	Test By	Alan Fan
Model Name	AG-622	TEMP&Humidity	18.9°C, 68%

Middle (5240MHz) TX				Measurement Distance at 1m Vertical polarity							
Freq. (MHz)	Reading (dBμV)	AF (dBμV)	Cable (dB)	Pre-amp (dB)	Dist (dB)	Filter (dB)	Level (dBμV/m)	Limit (dBμV/m)	Margin (dB)	Mark (P/Q/A)	Height (Meter)
3419.20	52.12	31.45	4.25	35.48	9.50	0.00	42.84	88.30	-45.46	P	1.00
3419.20	40.58	31.45	4.25	35.48	9.50	0.00	31.30	68.30	-37.00	A	1.00
* 4298.41	45.88	32.42	4.92	34.90	9.50	0.00	38.82	74.00	-35.18	P	1.00
* 4298.41	34.10	32.42	4.92	34.90	9.50	0.00	27.04	54.00	-26.96	A	1.00
7062.81	49.96	39.87	6.62	35.69	9.50	0.00	51.27	88.30	-37.03	P	1.01
7062.81	41.87	39.87	6.62	35.69	9.50	0.00	43.18	68.30	-25.12	A	1.01
10479.03	48.32	39.07	8.56	35.95	9.50	0.59	51.10	88.30	-37.20	P	1.03
10479.03	36.99	39.07	8.56	35.95	9.50	0.59	39.77	68.30	-28.53	A	1.03
* 15720.10	46.44	44.51	8.84	36.03	9.50	0.30	54.55	74.00	-19.45	P	1.00
* 15720.10	35.28	44.51	8.84	36.03	9.50	0.30	43.39	54.00	-10.61	A	1.00
* 20958.06	-----	-----	-----	-----	0.00	5.81	-----	-----	-----	-----	1.00
26197.58	-----	-----	-----	-----	0.00	1.80	-----	-----	-----	-----	1.00
* 31437.09	-----	-----	-----	-----	0.00	0.00	-----	-----	-----	-----	1.00
36676.61	-----	-----	-----	-----	0.00	0.00	-----	-----	-----	-----	1.00
* 41916.12	-----	-----	-----	-----	0.00	0.00	-----	-----	-----	-----	1.00
* 47155.64	-----	-----	-----	-----	0.00	0.00	-----	-----	-----	-----	1.00
* 52395.15	-----	-----	-----	-----	0.00	0.00	-----	-----	-----	-----	1.00

Note :

- The measurement was searched to 10th harmonic, Remark "-----" means that the emissions level is too low to be measured.
- AF: Antenna Factor, Cable: Cable Loss, Pre-Amp: Preamplifier gain, Filter: High Pass Filter Insertion Loss (3.5GHz)
- Spectrum analyzer setting P(Peak): RBW=1MHz, VBW=1MHz, A(Average): RBW=1MHz, VBW=10Hz
- Remark "\*" means that Restricted band.
- Dist : correction to extra plate reading to 3m specification distance 1m measurement distance = -9.5dB
- The result basic equation calculation is as follow:  
Level = Reading + AF + Cable - Preamp + Filter - Dist, Margin = Level - Limit
- The test limit distance is 3M limit.
- For Super A mode.



The frequency spectrum above 1 GHz for Transmitter was investigated. All emissions not reported are much lower than the prescribed limits. Readings are both peak and average values.

Company	Z-Com, Inc.	Test Date	2005/01/13
Product Name	802.11a/b/g Wireless mini PCI Adapter	Test By	Alan Fan
Model Name	AG-622	TEMP&Humidity	18.9°C, 68%

Middle (5260MHz) TX				Measurement Distance at 1m Horizontal polarity							
Freq. (MHz)	Reading (dBμV)	AF (dBμV)	Cable (dB)	Pre-amp (dB)	Dist (dB)	Filter (dB)	Level (dBμV/m)	Limit (dBμV/m)	Margin (dB)	Mark (P/Q/A)	Height (Meter)
3430.86	54.74	31.44	4.26	35.47	9.50	0.00	45.47	88.30	-42.83	P	1.00
3430.86	45.66	31.44	4.26	35.47	9.50	0.00	36.39	68.30	-31.91	A	1.00
* 4310.12	51.21	32.41	4.92	34.90	9.50	0.00	44.14	74.00	-29.86	P	1.30
* 4310.12	41.13	32.41	4.92	34.90	9.50	0.00	34.06	54.00	-19.94	A	1.30
7081.53	53.66	39.87	6.64	35.68	9.50	0.00	54.98	88.30	-33.32	P	1.00
7081.53	45.22	39.87	6.64	35.68	9.50	0.00	46.54	68.30	-21.76	A	1.00
10521.79	47.42	39.13	8.58	35.90	9.50	0.63	50.35	88.30	-37.95	P	1.00
10521.79	36.48	39.13	8.58	35.90	9.50	0.63	39.41	68.30	-28.89	A	1.00
* 15777.65	47.77	44.30	8.87	36.12	9.50	0.30	55.63	74.00	-18.37	P	1.00
* 15777.65	35.27	44.30	8.87	36.12	9.50	0.30	43.13	54.00	-10.87	A	1.00
* 21043.58	-----	-----	-----	-----	0.00	5.51	-----	-----	-----	-----	1.00
26304.48	-----	-----	-----	-----	0.00	1.90	-----	-----	-----	-----	1.00
* 31565.37	-----	-----	-----	-----	0.00	0.00	-----	-----	-----	-----	1.00
36826.27	-----	-----	-----	-----	0.00	0.00	-----	-----	-----	-----	1.00
* 42087.16	-----	-----	-----	-----	0.00	0.00	-----	-----	-----	-----	1.00
* 47348.06	-----	-----	-----	-----	0.00	0.00	-----	-----	-----	-----	1.00
* 52608.95	-----	-----	-----	-----	0.00	0.00	-----	-----	-----	-----	1.00

Note :

- The measurement was searched to 10<sup>th</sup> harmonic, Remark "-----" means that the emissions level is too low to be measured.
- AF: Antenna Factor, Cable: Cable Loss, Pre-Amp: Preamplifier gain, Filter: High Pass Filter Insertion Loss (3.5GHz)
- Spectrum analyzer setting P(Peak): RBW=1MHz, VBW=1MHz, A(Average): RBW=1MHz, VBW=10Hz
- Remark "\*" means that Restricted band.
- Dist : correction to extra plate reading to 3m specification distance 1m measurement distance = -9.5dB
- The result basic equation calculation is as follow:  
Level=Reading + AF + Cable – Preamp + Filter – Dist, Margin = Level-Limit
- The test limit distance is 3M limit.
- For Super A mode.



The frequency spectrum above 1 GHz for Transmitter was investigated. All emissions not reported are much lower than the prescribed limits. Readings are both peak and average values.

Company	Z-Com, Inc.	Test Date	2005/01/13
Product Name	802.11a/b/g Wireless mini PCI Adapter	Test By	Alan Fan
Model Name	AG-622	TEMP&Humidity	18.9°C, 68%

Middle (5260MHz) TX				Measurement Distance at 1m Vertical polarity							
Freq. (MHz)	Reading (dBμV)	AF (dBμV)	Cable (dB)	Pre-amp (dB)	Dist (dB)	Filter (dB)	Level (dBμV/m)	Limit (dBμV/m)	Margin (dB)	Mark (P/Q/A)	Height (Meter)
3430.82	51.40	31.44	4.26	35.47	9.50	0.00	42.13	88.30	-46.17	P	1.03
3430.82	42.60	31.44	4.26	35.47	9.50	0.00	33.33	68.30	-34.97	A	1.03
* 4310.55	45.12	32.41	4.92	34.90	9.50	0.00	38.05	74.00	-35.95	P	1.00
* 4310.55	34.20	32.41	4.92	34.90	9.50	0.00	27.13	54.00	-26.87	A	1.00
7077.31	50.72	39.87	6.63	35.68	9.50	0.00	52.04	88.30	-36.26	P	1.01
7077.31	42.08	39.87	6.63	35.68	9.50	0.00	43.40	68.30	-24.90	A	1.01
10520.47	46.98	39.12	8.58	35.90	9.50	0.63	49.91	88.30	-38.39	P	1.02
10520.47	35.77	39.12	8.58	35.90	9.50	0.63	38.70	68.30	-29.60	A	1.02
* 15779.49	46.18	44.29	8.87	36.12	9.50	0.30	54.03	74.00	-19.97	P	1.00
* 15779.49	35.99	44.29	8.87	36.12	9.50	0.30	43.84	54.00	-10.16	A	1.00
* 21040.94	-----	-----	-----	-----	0.00	5.54	-----	-----	-----	-----	1.00
26301.18	-----	-----	-----	-----	0.00	1.90	-----	-----	-----	-----	1.00
* 31561.41	-----	-----	-----	-----	0.00	0.00	-----	-----	-----	-----	1.00
36821.65	-----	-----	-----	-----	0.00	0.00	-----	-----	-----	-----	1.00
* 42081.88	-----	-----	-----	-----	0.00	0.00	-----	-----	-----	-----	1.00
* 47342.12	-----	-----	-----	-----	0.00	0.00	-----	-----	-----	-----	1.00
* 52602.35	-----	-----	-----	-----	0.00	0.00	-----	-----	-----	-----	1.00

Note :

- The measurement was searched to 10th harmonic, Remark "-----" means that the emissions level is too low to be measured.
- AF: Antenna Factor, Cable: Cable Loss, Pre-Amp: Preamplifier gain, Filter: High Pass Filter Insertion Loss (3.5GHz)
- Spectrum analyzer setting P(Peak): RBW=1MHz, VBW=1MHz, A(Average): RBW=1MHz, VBW=10Hz
- Remark "\*" means that Restricted band.
- Dist : correction to extra plate reading to 3m specification distance 1m measurement distance = -9.5dB
- The result basic equation calculation is as follow:  
Level = Reading + AF + Cable – Preamp + Filter - Dist, Margin = Level - Limit
- The test limit distance is 3M limit.
- For Super A mode.



The frequency spectrum above 1 GHz for Transmitter was investigated. All emissions not reported are much lower than the prescribed limits. Readings are both peak and average values.

Company	Z-Com, Inc.	Test Date	2005/01/13
Product Name	802.11a/b/g Wireless mini PCI Adapter	Test By	Alan Fan
Model Name	AG-622	TEMP&Humidity	18.9°C, 68%

High (5300MHz) TX				Measurement Distance at 1m Horizontal polarity							
Freq. (MHz)	Reading (dBμV)	AF (dBμV)	Cable (dB)	Pre-amp (dB)	Dist (dB)	Filter (dB)	Level (dBμV/m)	Limit (dBμV/m)	Margin (dB)	Mark (P/Q/A)	Height (Meter)
3466.18	50.28	31.42	4.30	35.43	9.50	0.00	41.06	88.30	-47.24	P	1.06
3466.18	40.35	31.42	4.30	35.43	9.50	0.00	31.13	68.30	-37.17	A	1.06
* 4358.84	47.13	32.38	4.93	34.90	9.50	0.00	40.05	74.00	-33.95	P	1.30
* 4358.84	36.98	32.38	4.93	34.90	9.50	0.00	29.90	54.00	-24.10	A	1.30
5288.57	71.72	36.00	5.50	0.00	9.50	0.00	103.73	Fundamental Frequency		P	1.08
5288.57	62.63	36.00	5.50	0.00	9.50	0.00	94.64			A	1.08
* 5350.40	29.05	36.09	5.58	0.00	9.50	0.00	61.22	74.00	-12.78	P	1.08
* 5350.40	15.41	36.09	5.58	0.00	9.50	0.00	47.58	54.00	-6.42	A	1.08
7114.47	49.18	39.85	6.66	35.68	9.50	0.00	50.51	88.30	-37.79	P	1.08
7114.47	39.05	39.85	6.66	35.68	9.50	0.00	40.38	68.30	-27.92	A	1.08
* 10600.00	43.82	39.22	8.60	35.90	9.50	0.74	46.98	74.00	-27.02	P	1.01
* 10600.00	33.48	39.22	8.60	35.90	9.50	0.74	36.64	54.00	-17.36	A	1.01
* 15900.05	44.58	43.86	8.95	36.30	9.50	0.30	51.89	74.00	-22.11	P	1.00
* 15900.05	35.12	43.86	8.95	36.30	9.50	0.30	42.43	54.00	-11.57	A	1.00
* 21154.28	-----	-----	-----	-----	0.00	4.39	-----	-----	-----	-----	1.00
26442.85	-----	-----	-----	-----	0.00	2.04	-----	-----	-----	-----	1.00
* 31731.42	-----	-----	-----	-----	0.00	0.00	-----	-----	-----	-----	1.00
37019.99	-----	-----	-----	-----	0.00	0.00	-----	-----	-----	-----	1.00
* 42308.56	-----	-----	-----	-----	0.00	0.00	-----	-----	-----	-----	1.00
* 47597.13	-----	-----	-----	-----	0.00	0.00	-----	-----	-----	-----	1.00
* 52885.70	-----	-----	-----	-----	0.00	0.00	-----	-----	-----	-----	1.00

Note :

- The measurement was searched to 10th harmonic, Remark "-----" means that the emissions level is too low to be measured.
- AF: Antenna Factor, Cable: Cable Loss, Pre-Amp: Preamplifier gain, Filter: High Pass Filter Insertion Loss (3.5GHz)
- Spectrum analyzer setting P(Peak): RBW=1MHz, VBW=1MHz, A(Average): RBW=1MHz, VBW=10Hz
- Remark "\*" means that Restricted band.
- Dist : correction to extra plate reading to 3m specification distance 1m measurement distance = -9.5dB
- The result basic equation calculation is as follow:  
Level = Reading + AF + Cable – Preamp + Filter - Dist, Margin = Level - Limit
- The test limit distance is 3M limit.
- For Super A mode.



The frequency spectrum above 1 GHz for Transmitter was investigated. All emissions not reported are much lower than the prescribed limits. Readings are both peak and average values.

Company	Z-Com, Inc.	Test Date	2005/01/13
Product Name	802.11a/b/g Wireless mini PCI Adapter	Test By	Alan Fan
Model Name	AG-622	TEMP&Humidity	18.9°C, 68%

High (5300MHz) TX				Measurement Distance at 1m Vertical polarity							
Freq. (MHz)	Reading (dBμV)	AF (dBμV)	Cable (dB)	Pre-amp (dB)	Dist (dB)	Filter (dB)	Level (dBμV/m)	Limit (dBμV/m)	Margin (dB)	Mark (P/Q/A)	Height (Meter)
3466.18	48.21	31.42	4.30	35.43	9.50	0.00	38.99	88.30	-49.31	P	1.06
3466.18	37.29	31.42	4.30	35.43	9.50	0.00	28.07	68.30	-40.23	A	1.06
* 4358.88	45.57	32.38	4.93	34.90	9.50	0.00	38.49	74.00	-35.51	P	1.02
* 4358.88	33.14	32.38	4.93	34.90	9.50	0.00	26.06	54.00	-27.94	A	1.02
5292.86	66.17	36.01	5.51	0.00	9.50	0.00	98.19	Fundamental Frequency		P	1.08
5292.86	56.55	36.01	5.51	0.00	9.50	0.00	88.57			A	1.08
* 5350.40	28.95	36.09	5.58	0.00	9.50	0.00	61.12	74.00	-12.88	P	1.02
* 5350.40	15.41	36.09	5.58	0.00	9.50	0.00	47.58	54.00	-6.42	A	1.02
7115.02	44.89	39.85	6.66	35.68	9.50	0.00	46.23	88.30	-42.07	P	1.00
7115.02	32.87	39.85	6.66	35.68	9.50	0.00	34.21	68.30	-34.09	A	1.00
* 10600.05	44.63	39.22	8.60	35.90	9.50	0.74	47.79	74.00	-26.21	P	1.04
* 10600.05	34.85	39.22	8.60	35.90	9.50	0.74	38.01	54.00	-15.99	A	1.04
* 15900.12	45.28	43.86	8.95	36.30	9.50	0.30	52.59	74.00	-21.41	P	1.00
* 15900.12	36.27	43.86	8.95	36.30	9.50	0.30	43.58	54.00	-10.42	A	1.00
* 21171.44	-----	-----	-----	-----	0.00	4.22	-----	-----	-----	-----	1.00
26464.30	-----	-----	-----	-----	0.00	2.06	-----	-----	-----	-----	1.00
* 31757.16	-----	-----	-----	-----	0.00	0.00	-----	-----	-----	-----	1.00
37050.02	-----	-----	-----	-----	0.00	0.00	-----	-----	-----	-----	1.00
* 42342.88	-----	-----	-----	-----	0.00	0.00	-----	-----	-----	-----	1.00
* 47635.74	-----	-----	-----	-----	0.00	0.00	-----	-----	-----	-----	1.00
* 52928.60	-----	-----	-----	-----	0.00	0.00	-----	-----	-----	-----	1.00

Note :

- The measurement was searched to 10th harmonic, Remark "-----" means that the emissions level is too low to be measured.
- AF: Antenna Factor, Cable: Cable Loss, Pre-Amp: Preamplifier gain, Filter: High Pass Filter Insertion Loss (3.5GHz)
- Spectrum analyzer setting P(Peak): RBW=1MHz, VBW=1MHz, A(Average): RBW=1MHz, VBW=10Hz
- Remark "\*" means that Restricted band.
- Dist : correction to extra plate reading to 3m specification distance 1m measurement distance = -9.5dB
- The result basic equation calculation is as follow:  
Level = Reading + AF + Cable – Preamp + Filter - Dist, Margin = Level - Limit
- The test limit distance is 3M limit.
- For Super A mode.



### 3.6.3 Radiated Bandedge Emission of 5.15 ~ 5.35GHz Band

The measured radiated band edge emissions are listed below :

<b>Company</b>	Z-Com, Inc.	<b>Test Date</b>	2005/01/13
<b>Product Name</b>	802.11a/b/g Wireless mini PCI Adapter	<b>Test By</b>	Alan Fan
<b>Model Name</b>	AG-622	<b>TEMP &amp; Humidity</b>	21.1°C, 63%

For normal 802.11a mode

Band edge Frequency (MHz)		Measured radiated band edge field strength (dBuV/m)		Radiated band edge field strength limit (dBuV/m)		Test result
		Horizontal	Vertical	Horizontal	Vertical	
5150.00	PK	66.87	60.21	74.00	74.00	PASS
	AV	52.16	47.05	54.00	54.00	
5350.00	PK	61.03	59.06	74.00	74.00	PASS
	AV	49.17	47.58	54.00	54.00	

For Super A mode

Band edge Frequency (MHz)		Measured radiated band edge field strength (dBuV/m)		Radiated band edge field strength limit (dBuV/m)		Test result
		Horizontal	Vertical	Horizontal	Vertical	
5150.00	PK	62.72	61.09	74.00	74.00	PASS
	AV	49.98	47.05	54.00	54.00	
5350.00	PK	61.53	58.77	74.00	74.00	PASS
	AV	47.58	47.58	54.00	54.00	

Note : 1. Radiated band edge field strength is measured with measurement procedure ANSI C63.4-2003.



### 3.6.4 Photo of Bandedge Measurement

**In 5.15 ~ 5.35GHz Band  
For normal 802.11a mode  
Carrier Frequency : 5180MHz**

Marker 2 [T1] RBW 100 kHz RF Att 30 dB  
Ref Lvl 127 dB $\mu$ V 62.14 dB $\mu$ V VBW 100 kHz  
5.15000000 GHz SWT 25 ms Unit dB $\mu$ V

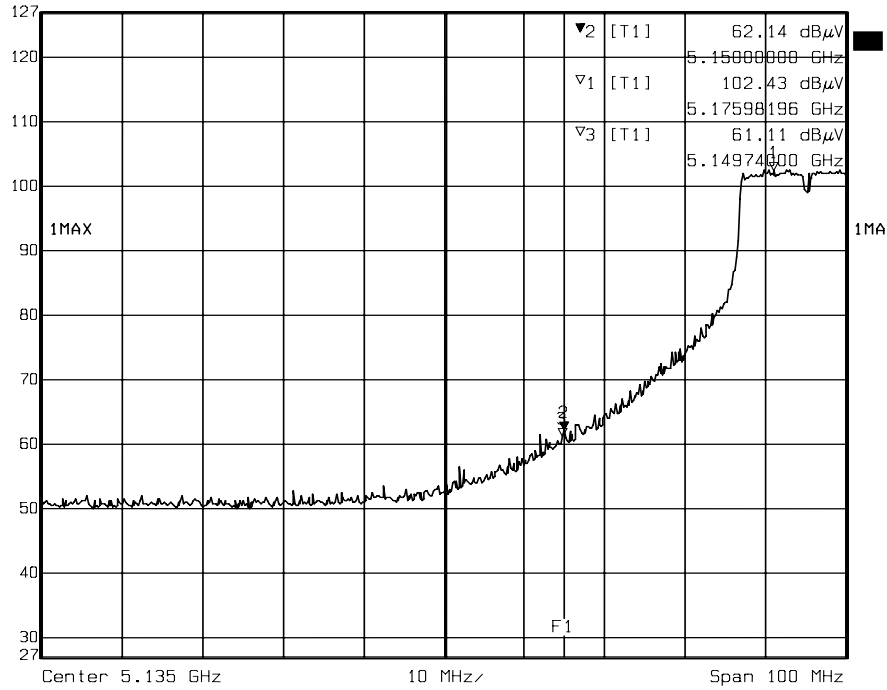

Date: 23.JAN.2005 02:29:59

**Lower Band edge (Peak)**

**Carrier Frequency : 5320MHz**

Marker 2 [T1] RBW 100 kHz RF Att 30 dB  
Ref Lvl 127 dB $\mu$ V 56.57 dB $\mu$ V VBW 100 kHz  
5.35000000 GHz SWT 25 ms Unit dB $\mu$ V

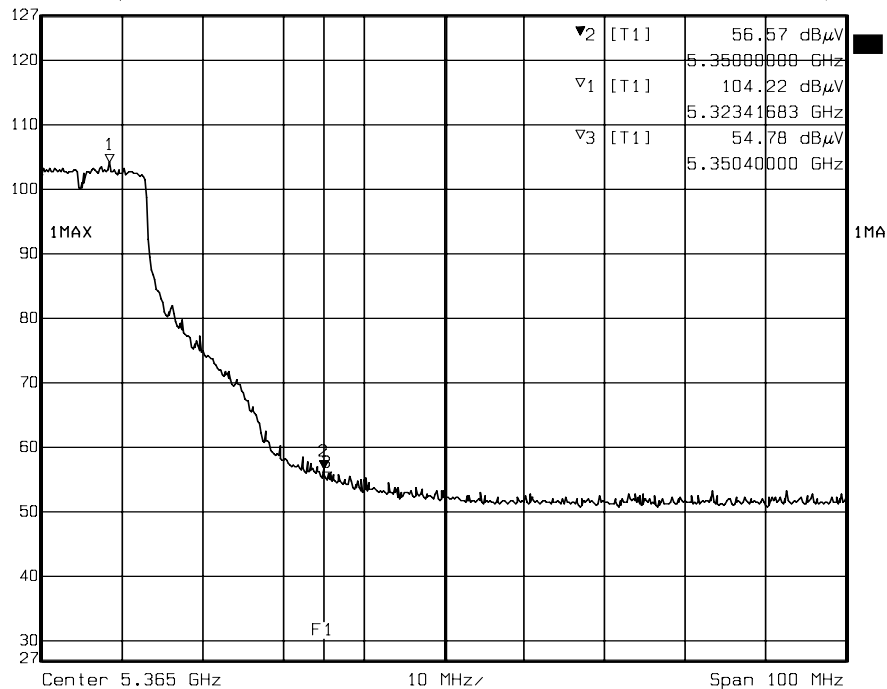

Date: 23.JAN.2005 02:27:49

**Higher Band edge (Peak)**





**For Super A mode**  
**Carrier Frequency : 5200MHz**

	Ref Lvl	Marker 2 [T1]	RBW	100 kHz	RF Att	30 dB
	127 dB $\mu$ V	5.15000000 GHz	VBW	100 kHz		
		5.15000000 GHz	SWT	50 ms	Unit	dB $\mu$ V

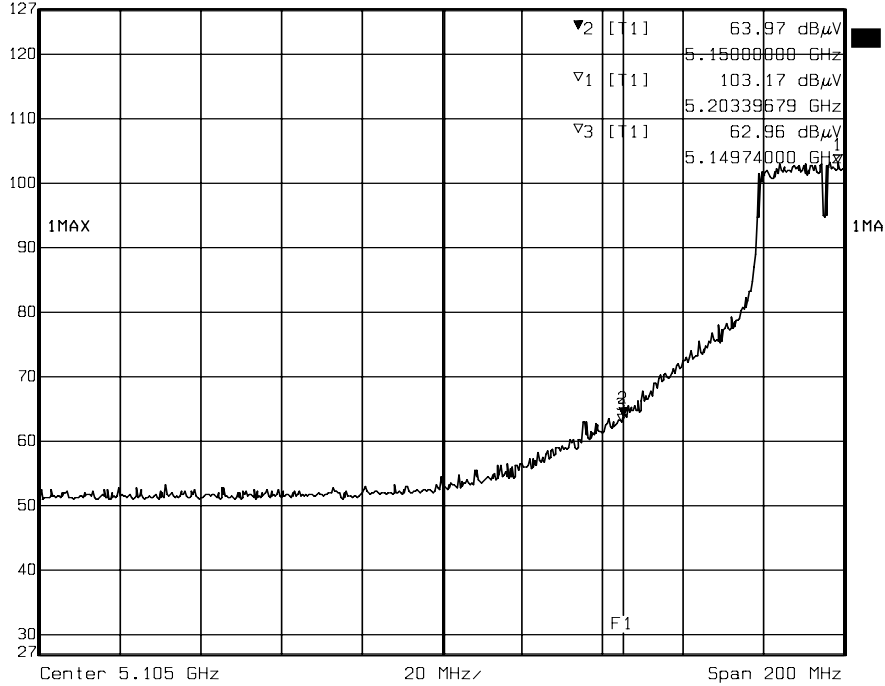

Date: 23.JAN.2005 02:13:31

Lower Band edge (Peak)

**Carrier Frequency : 5300MHz**

	Ref Lvl	Marker 2 [T1]	RBW	100 kHz	RF Att	30 dB
	127 dB $\mu$ V	5.35000000 GHz	VBW	100 kHz		
		5.35000000 GHz	SWT	50 ms	Unit	dB $\mu$ V

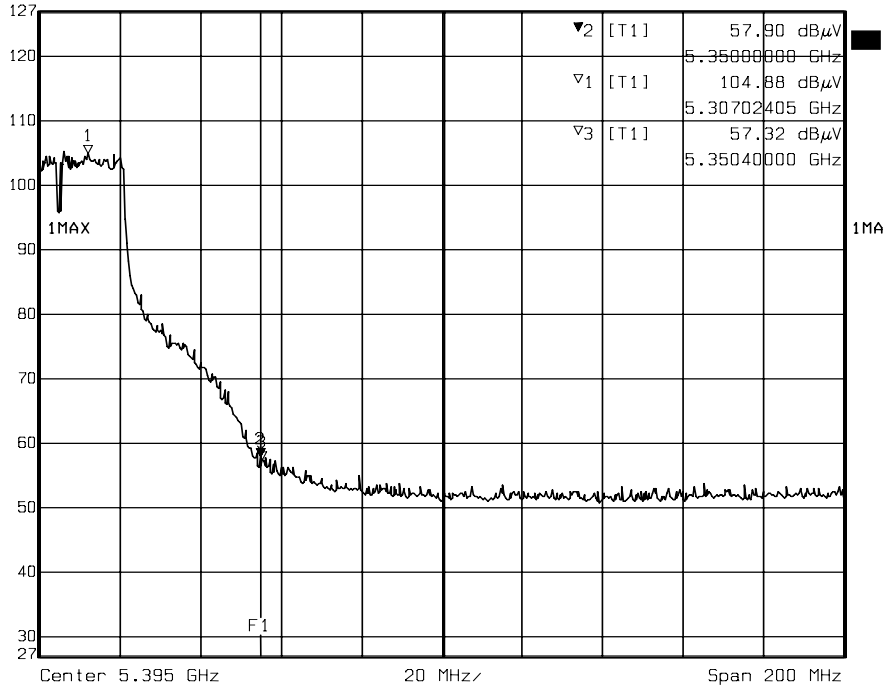

Date: 23.JAN.2005 02:19:32

Higher Band edge (Peak)



### 3.6.5 Spurious Emission Outside of the 5.15 ~ 5.35GHz Band (RX)

The frequency spectrum above 1 GHz for Receiver was investigated. All emissions not reported are much lower than the prescribed limits. Readings are both peak and average values.

Company	Z-Com, Inc.	Test Date	2005/01/12
Product Name	802.11a/b/g Wireless mini PCI Adapter	Test By	Alan Fan
Model Name	AG-622	TEMP&Humidity	16.9°C, 85%

CH1 (5180MHz) RX				Measurement Distance at 1m Horizontal polarity							
Freq. (MHz)	Reading (dBμV)	AF (dBμV)	Cable (dB)	Pre-amp (dB)	Dist (dB)	Filter (dB)	Level (dBμV/m)	Limit (dBμV/m)	Margin (dB)	Mark (P/Q/A)	Height (Meter)
1726.65	43.25	29.96	3.12	35.46	9.50	0.00	31.37	74.00	-42.63	P	1.08
1726.65	33.58	29.96	3.12	35.46	9.50	0.00	21.70	54.00	-32.30	A	1.08
3453.28	47.40	31.43	4.28	35.45	9.50	0.00	38.17	74.00	-35.83	P	1.12
3453.28	36.52	31.43	4.28	35.45	9.50	0.00	27.29	54.00	-26.71	A	1.12
6907.02	45.50	39.57	6.56	35.44	9.50	0.00	46.69	74.00	-27.31	P	1.00
6907.02	35.19	39.57	6.56	35.44	9.50	0.00	36.38	54.00	-17.62	A	1.00

1. AF: Antenna Factor, Cable: Cable Loss, Pre-Amp: Preamplifier gain
2. Spectrum analyzer setting P(Peak): RBW=1MHz, VBW=1MHz, A(Average): RBW=1MHz, VBW=10Hz
3. Dist : correction to extra plate reading to 3m specification distance 1m measurement distance = -9.5dB
4. The result basic equation calculation as follow :  
Level = Reading + AF + Cable - Preamp + Filter - Dist, Margin = Level - Limit
5. The test limit is 3M limit.
6. The frequency was searched to 18GHz.
7. The other emission levels were very low against the limit.
8. For normal 802.11a mode.



The frequency spectrum above 1 GHz for Receiver was investigated. All emissions not reported are much lower than the prescribed limits. Readings are both peak and average values.

Company	Z-Com, Inc.	Test Date	2005/01/12
Product Name	802.11a/b/g Wireless mini PCI Adapter	Test By	Alan Fan
Model Name	AG-622	TEMP&Humidity	16.9°C, 85%

CH1 (5180MHz) RX				Measurement Distance at 1m Vertical polarity							
Freq. (MHz)	Reading (dBμV)	AF (dBμV)	Cable (dB)	Pre-amp (dB)	Dist (dB)	Filter (dB)	Level (dBμV/m)	Limit (dBμV/m)	Margin (dB)	Mark (P/Q/A)	Height (Meter)
1726.68	44.02	29.96	3.12	35.46	9.50	0.00	32.14	74.00	-41.86	P	1.09
1726.68	32.98	29.96	3.12	35.46	9.50	0.00	21.10	54.00	-32.90	A	1.09
3453.70	43.31	31.43	4.28	35.45	9.50	0.00	34.08	74.00	-39.92	P	1.10
3453.70	34.09	31.43	4.28	35.45	9.50	0.00	24.86	54.00	-29.14	A	1.10
6906.66	43.17	39.56	6.56	35.44	9.50	0.00	44.36	74.00	-29.64	P	1.09
6906.66	35.26	39.56	6.56	35.44	9.50	0.00	36.45	54.00	-17.55	A	1.09

1. AF: Antenna Factor, Cable: Cable Loss, Pre-Amp: Preamplifier gain
2. Spectrum analyzer setting P(Peak): RBW=1MHz, VBW=1MHz, A(Average): RBW=1MHz, VBW=10Hz
3. Dist : correction to extra plate reading to 3m specification distance 1m measurement distance = -9.5dB
4. The result basic equation calculation as follow :  
Level = Reading + AF + Cable - Preamp + Filter - Dist, Margin = Level - Limit
5. The test limit is 3M limit.
6. The frequency was searched to 18GHz.
7. The other emission levels were very low against the limit.
8. For normal 802.11a mode.



The frequency spectrum above 1 GHz for Receiver was investigated. All emissions not reported are much lower than the prescribed limits. Readings are both peak and average values.

Company	Z-Com, Inc.	Test Date	2005/01/12
Product Name	802.11a/b/g Wireless mini PCI Adapter	Test By	Alan Fan
Model Name	AG-622	TEMP&Humidity	16.9°C, 85%

CH4 (5240MHz) RX				Measurement Distance at 1m Horizontal polarity							
Freq. (MHz)	Reading (dBμV)	AF (dBμV)	Cable (dB)	Pre-amp (dB)	Dist (dB)	Filter (dB)	Level (dBμV/m)	Limit (dBμV/m)	Margin (dB)	Mark (P/Q/A)	Height (Meter)
1746.68	43.25	30.12	3.14	35.45	9.50	0.00	31.56	74.00	-42.44	P	1.00
1746.68	33.54	30.12	3.14	35.45	9.50	0.00	21.85	54.00	-32.15	A	1.00
3493.35	45.85	31.40	4.32	35.41	9.50	0.00	36.67	74.00	-37.33	P	1.14
3493.35	35.12	31.40	4.32	35.41	9.50	0.00	25.94	54.00	-28.06	A	1.14
7051.97	44.74	39.88	6.62	35.69	9.50	0.00	46.04	74.00	-27.96	P	1.02
7051.97	35.73	39.88	6.62	35.69	9.50	0.00	37.03	54.00	-16.97	A	1.02

1. AF: Antenna Factor, Cable: Cable Loss, Pre-Amp: Preamplifier gain
2. Spectrum analyzer setting P(Peak): RBW=1MHz, VBW=1MHz, A(Average): RBW=1MHz, VBW=10Hz
3. Dist : correction to extra plate reading to 3m specification distance 1m measurement distance = -9.5dB
4. The result basic equation calculation as follow :  
Level = Reading + AF + Cable - Preamp + Filter - Dist, Margin = Level - Limit
5. The test limit is 3M limit.
6. The frequency was searched to 18GHz.
7. The other emission levels were very low against the limit.
8. For normal 802.11a mode.



The frequency spectrum above 1 GHz for Receiver was investigated. All emissions not reported are much lower than the prescribed limits. Readings are both peak and average values.

Company	Z-Com, Inc.	Test Date	2005/01/12
Product Name	802.11a/b/g Wireless mini PCI Adapter	Test By	Alan Fan
Model Name	AG-622	TEMP&Humidity	16.9°C, 85%

CH4 (5240MHz) RX				Measurement Distance at 1m Vertical polarity							
Freq. (MHz)	Reading (dBμV)	AF (dBμV)	Cable (dB)	Pre-amp (dB)	Dist (dB)	Filter (dB)	Level (dBμV/m)	Limit (dBμV/m)	Margin (dB)	Mark (P/Q/A)	Height (Meter)
1746.66	44.12	30.12	3.14	35.45	9.50	0.00	32.43	74.00	-41.57	P	1.06
1746.66	33.20	30.12	3.14	35.45	9.50	0.00	21.51	54.00	-32.49	A	1.06
3493.31	44.85	31.40	4.32	35.41	9.50	0.00	35.67	74.00	-38.33	P	1.12
3493.31	34.23	31.40	4.32	35.41	9.50	0.00	25.05	54.00	-28.95	A	1.12
7052.03	43.74	39.88	6.62	35.69	9.50	0.00	45.04	74.00	-28.96	P	1.08
7052.03	35.20	39.88	6.62	35.69	9.50	0.00	36.50	54.00	-17.50	A	1.08

1. AF: Antenna Factor, Cable: Cable Loss, Pre-Amp: Preamplifier gain
2. Spectrum analyzer setting P(Peak): RBW=1MHz, VBW=1MHz, A(Average): RBW=1MHz, VBW=10Hz
3. Dist : correction to extra plate reading to 3m specification distance 1m measurement distance = -9.5dB
4. The result basic equation calculation as follow :  
Level = Reading + AF + Cable - Preamp + Filter - Dist, Margin = Level - Limit
5. The test limit is 3M limit.
6. The frequency was searched to 18GHz.
7. The other emission levels were very low against the limit.
8. For normal 802.11a mode.



The frequency spectrum above 1 GHz for Receiver was investigated. All emissions not reported are much lower than the prescribed limits. Readings are both peak and average values.

Company	Z-Com, Inc.	Test Date	2005/01/12
Product Name	802.11a/b/g Wireless mini PCI Adapter	Test By	Alan Fan
Model Name	AG-622	TEMP&Humidity	16.9°C, 85%

CH5 (5260MHz) RX				Measurement Distance at 1m Horizontal polarity							
Freq. (MHz)	Reading (dBμV)	AF (dBμV)	Cable (dB)	Pre-amp (dB)	Dist (dB)	Filter (dB)	Level (dBμV/m)	Limit (dBμV/m)	Margin (dB)	Mark (P/Q/A)	Height (Meter)
1753.36	43.02	30.18	3.15	35.45	9.50	0.00	31.40	74.00	-42.60	P	1.05
1753.36	32.97	30.18	3.15	35.45	9.50	0.00	21.35	54.00	-32.65	A	1.05
3506.12	45.32	31.41	4.34	35.39	9.50	0.00	36.18	74.00	-37.82	P	1.11
3506.12	34.88	31.41	4.34	35.39	9.50	0.00	25.74	54.00	-28.26	A	1.11
7013.41	45.32	39.89	6.59	35.70	9.50	0.00	46.61	74.00	-27.39	P	1.03
7013.41	35.41	39.89	6.59	35.70	9.50	0.00	36.70	54.00	-17.30	A	1.03

1. AF: Antenna Factor, Cable: Cable Loss, Pre-Amp: Preamplifier gain
2. Spectrum analyzer setting P(Peak): RBW=1MHz, VBW=1MHz, A(Average): RBW=1MHz, VBW=10Hz
3. Dist : correction to extra plate reading to 3m specification distance 1m measurement distance = -9.5dB
4. The result basic equation calculation as follow :  
Level = Reading + AF + Cable - Preamp + Filter - Dist, Margin = Level - Limit
5. The test limit is 3M limit.
6. The frequency was searched to 18GHz.
7. The other emission levels were very low against the limit.
8. For normal 802.11a mode.



The frequency spectrum above 1 GHz for Receiver was investigated. All emissions not reported are much lower than the prescribed limits. Readings are both peak and average values.

Company	Z-Com, Inc.	Test Date	2005/01/12
Product Name	802.11a/b/g Wireless mini PCI Adapter	Test By	Alan Fan
Model Name	AG-622	TEMP&Humidity	16.9°C, 85%

CH5 (5260MHz) RX				Measurement Distance at 1m Vertical polarity							
Freq. (MHz)	Reading (dBμV)	AF (dBμV)	Cable (dB)	Pre-amp (dB)	Dist (dB)	Filter (dB)	Level (dBμV/m)	Limit (dBμV/m)	Margin (dB)	Mark (P/Q/A)	Height (Meter)
1753.25	43.22	30.18	3.15	35.45	9.50	0.00	31.60	74.00	-42.40	P	1.06
1753.25	32.89	30.18	3.15	35.45	9.50	0.00	21.27	54.00	-32.73	A	1.06
3506.37	43.12	31.42	4.34	35.39	9.50	0.00	33.98	74.00	-40.02	P	1.13
3506.37	34.25	31.42	4.34	35.39	9.50	0.00	25.11	54.00	-28.89	A	1.13
7013.50	43.87	39.89	6.59	35.70	9.50	0.00	45.16	74.00	-28.84	P	1.04
7013.50	33.88	39.89	6.59	35.70	9.50	0.00	35.17	54.00	-18.83	A	1.04

1. AF: Antenna Factor, Cable: Cable Loss, Pre-Amp: Preamplifier gain
2. Spectrum analyzer setting P(Peak): RBW=1MHz, VBW=1MHz, A(Average): RBW=1MHz, VBW=10Hz
3. Dist : correction to extra plate reading to 3m specification distance 1m measurement distance = -9.5dB
4. The result basic equation calculation as follow :  
Level = Reading + AF + Cable - Preamp + Filter - Dist, Margin = Level - Limit
5. The test limit is 3M limit.
6. The frequency was searched to 18GHz.
7. The other emission levels were very low against the limit.
8. For normal 802.11a mode.



The frequency spectrum above 1 GHz for Receiver was investigated. All emissions not reported are much lower than the prescribed limits. Readings are both peak and average values.

Company	Z-Com, Inc.	Test Date	2005/01/12
Product Name	802.11a/b/g Wireless mini PCI Adapter	Test By	Alan Fan
Model Name	AG-622	TEMP&Humidity	16.9 °C, 85%

CH8 (5320MHz) RX				Measurement Distance at 1m Horizontal polarity							
Freq. (MHz)	Reading (dBμV)	AF (dBμV)	Cable (dB)	Pre-amp (dB)	Dist (dB)	Filter (dB)	Level (dBμV/m)	Limit (dBμV/m)	Margin (dB)	Mark (P/Q/A)	Height (Meter)
1773.38	43.15	30.34	3.17	35.44	9.50	0.00	31.72	74.00	-42.28	P	1.02
1773.38	32.97	30.34	3.17	35.44	9.50	0.00	21.54	54.00	-32.46	A	1.02
3506.50	44.25	31.42	4.34	35.39	9.50	0.00	35.11	74.00	-38.89	P	1.16
3506.50	35.02	31.42	4.34	35.39	9.50	0.00	25.88	54.00	-28.12	A	1.16
7013.21	44.00	39.89	6.59	35.70	9.50	0.00	45.29	74.00	-28.71	P	1.00
7013.21	33.24	39.89	6.59	35.70	9.50	0.00	34.53	54.00	-19.47	A	1.00

1. AF: Antenna Factor, Cable: Cable Loss, Pre-Amp: Preamplifier gain
2. Spectrum analyzer setting P(Peak): RBW=1MHz, VBW=1MHz, A(Average): RBW=1MHz, VBW=10Hz
3. Dist : correction to extra plate reading to 3m specification distance 1m measurement distance = -9.5dB
4. The result basic equation calculation as follow :  
Level = Reading + AF + Cable - Preamp + Filter - Dist, Margin = Level - Limit
5. The test limit is 3M limit.
6. The frequency was searched to 18GHz.
7. The other emission levels were very low against the limit.
8. For normal 802.11a mode.





The frequency spectrum above 1 GHz for Receiver was investigated. All emissions not reported are much lower than the prescribed limits. Readings are both peak and average values.

Company	Z-Com, Inc.	Test Date	2005/01/12
Product Name	802.11a/b/g Wireless mini PCI Adapter	Test By	Alan Fan
Model Name	AG-622	TEMP&Humidity	16.9°C, 85%

CH8 (5320MHz) RX				Measurement Distance at 1m Vertical polarity							
Freq. (MHz)	Reading (dBμV)	AF (dBμV)	Cable (dB)	Pre-amp (dB)	Dist (dB)	Filter (dB)	Level (dBμV/m)	Limit (dBμV/m)	Margin (dB)	Mark (P/Q/A)	Height (Meter)
1773.44	44.11	30.34	3.17	35.44	9.50	0.00	32.69	74.00	-41.31	P	1.02
1773.44	33.47	30.34	3.17	35.44	9.50	0.00	22.05	54.00	-31.95	A	1.02
3506.32	45.47	31.42	4.34	35.39	9.50	0.00	36.33	74.00	-37.67	P	1.11
3506.32	35.23	31.42	4.34	35.39	9.50	0.00	26.09	54.00	-27.91	A	1.11
7013.26	43.23	39.89	6.59	35.70	9.50	0.00	44.52	74.00	-29.48	P	1.05
7013.26	33.87	39.89	6.59	35.70	9.50	0.00	35.16	54.00	-18.84	A	1.05

1. AF: Antenna Factor, Cable: Cable Loss, Pre-Amp: Preamplifier gain
2. Spectrum analyzer setting P(Peak): RBW=1MHz, VBW=1MHz, A(Average): RBW=1MHz, VBW=10Hz
3. Dist : correction to extra plate reading to 3m specification distance 1m measurement distance = -9.5dB
4. The result basic equation calculation as follow :  
Level = Reading + AF + Cable - Preamp + Filter - Dist, Margin = Level - Limit
5. The test limit is 3M limit.
6. The frequency was searched to 18GHz.
7. The other emission levels were very low against the limit.
8. For normal 802.11a mode.



The frequency spectrum above 1 GHz for Receiver was investigated. All emissions not reported are much lower than the prescribed limits. Readings are both peak and average values.

Company	Z-Com, Inc.	Test Date	2005/01/17
Product Name	802.11a/b/g Wireless mini PCI Adapter	Test By	Alan Fan
Model Name	AG-622	TEMP&Humidity	13.9°C, 74%

Low (5200MHz) RX				Measurement Distance at 1m Horizontal polarity							
Freq. (MHz)	Reading (dBμV)	AF (dBμV)	Cable (dB)	Pre-amp (dB)	Dist (dB)	Filter (dB)	Level (dBμV/m)	Limit (dBμV/m)	Margin (dB)	Mark (P/Q/A)	Height (Meter)
1733.82	43.25	30.02	3.13	35.46	9.50	0.00	31.44	74.00	-42.56	P	1.00
1733.82	33.21	30.02	3.13	35.46	9.50	0.00	21.40	54.00	-32.60	A	1.00
3467.12	45.20	31.42	4.30	35.43	9.50	0.00	35.98	74.00	-38.02	P	1.05
3467.12	34.84	31.42	4.30	35.43	9.50	0.00	25.62	54.00	-28.38	A	1.05
6933.35	44.20	39.66	6.57	35.51	9.50	0.00	45.41	74.00	-28.59	P	1.00
6933.35	33.27	39.66	6.57	35.51	9.50	0.00	34.48	54.00	-19.52	A	1.00

1. AF: Antenna Factor, Cable: Cable Loss, Pre-Amp: Preamplifier gain
2. Spectrum analyzer setting P(Peak): RBW=1MHz, VBW=1MHz, A(Average): RBW=1MHz, VBW=10Hz
3. Dist : correction to extra plate reading to 3m specification distance 1m measurement distance = -9.5dB
4. The result basic equation calculation as follow :  
Level = Reading + AF + Cable - Preamp + Filter - Dist, Margin = Level - Limit
5. The test limit is 3M limit.
6. The frequency was searched to 30GHz.
7. The other emission levels were very low against the limit.
8. For Super A mode.



The frequency spectrum above 1 GHz for Receiver was investigated. All emissions not reported are much lower than the prescribed limits. Readings are both peak and average values.

Company	Z-Com, Inc.	Test Date	2005/01/17
Product Name	802.11a/b/g Wireless mini PCI Adapter	Test By	Alan Fan
Model Name	AG-622	TEMP&Humidity	13.9°C, 74%

Low (5200MHz) RX				Measurement Distance at 1m Vertical polarity							
Freq. (MHz)	Reading (dBμV)	AF (dBμV)	Cable (dB)	Pre-amp (dB)	Dist (dB)	Filter (dB)	Level (dBμV/m)	Limit (dBμV/m)	Margin (dB)	Mark (P/Q/A)	Height (Meter)
1733.28	46.23	30.01	3.13	35.46	9.50	0.00	34.41	74.00	-39.59	P	1.05
1733.28	35.41	30.01	3.13	35.46	9.50	0.00	23.59	54.00	-30.41	A	1.05
3467.02	44.25	31.42	4.30	35.43	9.50	0.00	35.03	74.00	-38.97	P	1.03
3467.02	34.28	31.42	4.30	35.43	9.50	0.00	25.06	54.00	-28.94	A	1.03
6933.25	45.20	39.66	6.57	35.51	9.50	0.00	46.41	74.00	-27.59	P	1.02
6933.25	34.74	39.66	6.57	35.51	9.50	0.00	35.95	54.00	-18.05	A	1.02

1. AF: Antenna Factor, Cable: Cable Loss, Pre-Amp: Preamplifier gain
2. Spectrum analyzer setting P(Peak): RBW=1MHz, VBW=1MHz, A(Average): RBW=1MHz, VBW=10Hz
3. Dist : correction to extra plate reading to 3m specification distance 1m measurement distance = -9.5dB
4. The result basic equation calculation as follow :  
Level = Reading + AF + Cable - Preamp + Filter - Dist, Margin = Level - Limit
5. The test limit is 3M limit.
6. The frequency was searched to 30GHz.
7. The other emission levels were very low against the limit.
8. For Super A mode.



The frequency spectrum above 1 GHz for Receiver was investigated. All emissions not reported are much lower than the prescribed limits. Readings are both peak and average values.

Company	Z-Com, Inc.	Test Date	2005/01/17
Product Name	802.11a/b/g Wireless mini PCI Adapter	Test By	Alan Fan
Model Name	AG-622	TEMP&Humidity	13.9°C, 74%

Middle (5240MHz) RX				Measurement Distance at 1m Horizontal polarity							
Freq. (MHz)	Reading (dBμV)	AF (dBμV)	Cable (dB)	Pre-amp (dB)	Dist (dB)	Filter (dB)	Level (dBμV/m)	Limit (dBμV/m)	Margin (dB)	Mark (P/Q/A)	Height (Meter)
1747.02	43.58	30.13	3.14	35.45	9.50	0.00	31.90	74.00	-42.10	P	1.00
1747.02	33.04	30.13	3.14	35.45	9.50	0.00	21.36	54.00	-32.64	A	1.00
3493.55	45.25	31.40	4.32	35.41	9.50	0.00	36.07	74.00	-37.93	P	1.03
3493.55	34.20	31.40	4.32	35.41	9.50	0.00	25.02	54.00	-28.98	A	1.03
6987.10	44.58	39.85	6.58	35.66	9.50	0.00	45.85	74.00	-28.15	P	1.00
6987.10	34.63	39.85	6.58	35.66	9.50	0.00	35.90	54.00	-18.10	A	1.00

1. AF: Antenna Factor, Cable: Cable Loss, Pre-Amp: Preamplifier gain
2. Spectrum analyzer setting P(Peak): RBW=1MHz, VBW=1MHz, A(Average): RBW=1MHz, VBW=10Hz
3. Dist : correction to extra plate reading to 3m specification distance 1m measurement distance = -9.5dB
4. The result basic equation calculation as follow :  

$$\text{Level} = \text{Reading} + \text{AF} + \text{Cable} - \text{Preamp} + \text{Filter} - \text{Dist}, \text{Margin} = \text{Level} - \text{Limit}$$
5. The test limit is 3M limit.
6. The frequency was searched to 30GHz.
7. The other emission levels were very low against the limit.
8. For Super A mode.



The frequency spectrum above 1 GHz for Receiver was investigated. All emissions not reported are much lower than the prescribed limits. Readings are both peak and average values.

Company	Z-Com, Inc.	Test Date	2005/01/17
Product Name	802.11a/b/g Wireless mini PCI Adapter	Test By	Alan Fan
Model Name	AG-622	TEMP&Humidity	13.9°C, 74%

Middle (5240MHz) RX				Measurement Distance at 1m Vertical polarity							
Freq. (MHz)	Reading (dBμV)	AF (dBμV)	Cable (dB)	Pre-amp (dB)	Dist (dB)	Filter (dB)	Level (dBμV/m)	Limit (dBμV/m)	Margin (dB)	Mark (P/Q/A)	Height (Meter)
1746.98	44.25	30.13	3.14	35.45	9.50	0.00	32.57	74.00	-41.43	P	1.00
1746.98	33.54	30.13	3.14	35.45	9.50	0.00	21.86	54.00	-32.14	A	1.00
3493.27	43.27	31.40	4.32	35.41	9.50	0.00	34.09	74.00	-39.91	P	1.01
3493.27	33.41	31.40	4.32	35.41	9.50	0.00	24.23	54.00	-29.77	A	1.01
6986.98	44.49	39.85	6.58	35.66	9.50	0.00	45.76	74.00	-28.24	P	1.00
6986.98	33.28	39.85	6.58	35.66	9.50	0.00	34.55	54.00	-19.45	A	1.00

1. AF: Antenna Factor, Cable: Cable Loss, Pre-Amp: Preamplifier gain
2. Spectrum analyzer setting P(Peak): RBW=1MHz, VBW=1MHz, A(Average): RBW=1MHz, VBW=10Hz
3. Dist : correction to extra plate reading to 3m specification distance 1m measurement distance = -9.5dB
4. The result basic equation calculation as follow :  

$$\text{Level} = \text{Reading} + \text{AF} + \text{Cable} - \text{Preamp} + \text{Filter} - \text{Dist}, \text{Margin} = \text{Level} - \text{Limit}$$
5. The test limit is 3M limit.
6. The frequency was searched to 30GHz.
7. The other emission levels were very low against the limit.
8. For Super A mode.



The frequency spectrum above 1 GHz for Receiver was investigated. All emissions not reported are much lower than the prescribed limits. Readings are both peak and average values.

Company	Z-Com, Inc.	Test Date	2005/01/17
Product Name	802.11a/b/g Wireless mini PCI Adapter	Test By	Alan Fan
Model Name	AG-622	TEMP&Humidity	13.9°C, 74%

Middle (5260MHz) RX				Measurement Distance at 1m Horizontal polarity							
Freq. (MHz)	Reading (dBμV)	AF (dBμV)	Cable (dB)	Pre-amp (dB)	Dist (dB)	Filter (dB)	Level (dBμV/m)	Limit (dBμV/m)	Margin (dB)	Mark (P/Q/A)	Height (Meter)
1753.50	45.28	30.18	3.15	35.45	9.50	0.00	33.66	74.00	-40.34	P	1.04
1753.50	34.74	30.18	3.15	35.45	9.50	0.00	23.12	54.00	-30.88	A	1.04
3506.47	44.38	31.42	4.34	35.39	9.50	0.00	35.24	74.00	-38.76	P	1.01
3506.47	33.64	31.42	4.34	35.39	9.50	0.00	24.50	54.00	-29.50	A	1.01
7011.89	44.55	39.90	6.59	35.70	9.50	0.00	45.84	74.00	-28.16	P	1.00
7011.89	33.17	39.90	6.59	35.70	9.50	0.00	34.46	54.00	-19.54	A	1.00

1. AF: Antenna Factor, Cable: Cable Loss, Pre-Amp: Preamplifier gain
2. Spectrum analyzer setting P(Peak): RBW=1MHz, VBW=1MHz, A(Average): RBW=1MHz, VBW=10Hz
3. Dist : correction to extra plate reading to 3m specification distance 1m measurement distance = -9.5dB
4. The result basic equation calculation as follow :  

$$\text{Level} = \text{Reading} + \text{AF} + \text{Cable} - \text{Preamp} + \text{Filter} - \text{Dist}, \text{Margin} = \text{Level} - \text{Limit}$$
5. The test limit is 3M limit.
6. The frequency was searched to 30GHz.
7. The other emission levels were very low against the limit.
8. For Super A mode.



The frequency spectrum above 1 GHz for Receiver was investigated. All emissions not reported are much lower than the prescribed limits. Readings are both peak and average values.

Company	Z-Com, Inc.	Test Date	2005/01/17
Product Name	802.11a/b/g Wireless mini PCI Adapter	Test By	Alan Fan
Model Name	AG-622	TEMP&Humidity	13.9°C, 74%

Middle (5260MHz) RX				Measurement Distance at 1m Vertical polarity							
Freq. (MHz)	Reading (dBμV)	AF (dBμV)	Cable (dB)	Pre-amp (dB)	Dist (dB)	Filter (dB)	Level (dBμV/m)	Limit (dBμV/m)	Margin (dB)	Mark (P/Q/A)	Height (Meter)
1753.50	43.22	30.18	3.15	35.45	9.50	0.00	31.60	74.00	-42.40	P	1.06
1753.50	33.19	30.18	3.15	35.45	9.50	0.00	21.57	54.00	-32.43	A	1.06
3506.47	43.63	31.42	4.34	35.39	9.50	0.00	34.49	74.00	-39.51	P	1.13
3506.47	33.29	31.42	4.34	35.39	9.50	0.00	24.15	54.00	-29.85	A	1.13
7011.89	44.71	39.90	6.59	35.70	9.50	0.00	46.00	74.00	-28.00	P	1.04
7011.89	33.57	39.90	6.59	35.70	9.50	0.00	34.86	54.00	-19.14	A	1.04

1. AF: Antenna Factor, Cable: Cable Loss, Pre-Amp: Preamplifier gain
2. Spectrum analyzer setting P(Peak): RBW=1MHz, VBW=1MHz, A(Average): RBW=1MHz, VBW=10Hz
3. Dist : correction to extra plate reading to 3m specification distance 1m measurement distance = -9.5dB
4. The result basic equation calculation as follow :  

$$\text{Level} = \text{Reading} + \text{AF} + \text{Cable} - \text{Preamp} + \text{Filter} - \text{Dist}, \text{Margin} = \text{Level} - \text{Limit}$$
5. The test limit is 3M limit.
6. The frequency was searched to 30GHz.
7. The other emission levels were very low against the limit.
8. For Super A mode.



The frequency spectrum above 1 GHz for Receiver was investigated. All emissions not reported are much lower than the prescribed limits. Readings are both peak and average values.

Company	Z-Com, Inc.	Test Date	2005/01/17
Product Name	802.11a/b/g Wireless mini PCI Adapter	Test By	Alan Fan
Model Name	AG-622	TEMP&Humidity	13.9°C, 74%

High (5300MHz) RX				Measurement Distance at 1m Horizontal polarity							
Freq. (MHz)	Reading (dBμV)	AF (dBμV)	Cable (dB)	Pre-amp (dB)	Dist (dB)	Filter (dB)	Level (dBμV/m)	Limit (dBμV/m)	Margin (dB)	Mark (P/Q/A)	Height (Meter)
1766.69	44.25	30.29	3.16	35.44	9.50	0.00	32.76	74.00	-41.24	P	1.00
1766.69	33.47	30.29	3.16	35.44	9.50	0.00	21.98	54.00	-32.02	A	1.00
3533.50	45.14	31.48	4.36	35.37	9.50	0.00	36.12	74.00	-37.88	P	1.05
3533.50	33.22	31.48	4.36	35.37	9.50	0.00	24.20	54.00	-29.80	A	1.05
7065.24	44.17	39.87	6.62	35.69	9.50	0.00	45.48	74.00	-28.52	P	1.00
7065.24	32.98	39.87	6.62	35.69	9.50	0.00	34.29	54.00	-19.71	A	1.00

1. AF: Antenna Factor, Cable: Cable Loss, Pre-Amp: Preamplifier gain
2. Spectrum analyzer setting P(Peak): RBW=1MHz, VBW=1MHz, A(Average): RBW=1MHz, VBW=10Hz
3. Dist : correction to extra plate reading to 3m specification distance 1m measurement distance = -9.5dB
4. The result basic equation calculation as follow :  
Level = Reading + AF + Cable - Preamp + Filter - Dist, Margin = Level - Limit
5. The test limit is 3M limit.
6. The frequency was searched to 30GHz.
7. The other emission levels were very low against the limit.
8. For Super A mode.





The frequency spectrum above 1 GHz for Receiver was investigated. All emissions not reported are much lower than the prescribed limits. Readings are both peak and average values.

Company	Z-Com, Inc.	Test Date	2005/01/17
Product Name	802.11a/b/g Wireless mini PCI Adapter	Test By	Alan Fan
Model Name	AG-622	TEMP&Humidity	13.9°C, 74%

High (5300MHz) RX				Measurement Distance at 1m Vertical polarity							
Freq. (MHz)	Reading (dBμV)	AF (dBμV)	Cable (dB)	Pre-amp (dB)	Dist (dB)	Filter (dB)	Level (dBμV/m)	Limit (dBμV/m)	Margin (dB)	Mark (P/Q/A)	Height (Meter)
1766.08	44.12	30.28	3.16	35.44	9.50	0.00	32.62	74.00	-41.38	P	1.01
1766.08	32.89	30.28	3.16	35.44	9.50	0.00	21.39	54.00	-32.61	A	1.01
3533.18	45.25	31.48	4.36	35.37	9.50	0.00	36.23	74.00	-37.77	P	1.01
3533.18	33.24	31.48	4.36	35.37	9.50	0.00	24.22	54.00	-29.78	A	1.01
7066.01	44.62	39.87	6.62	35.69	9.50	0.00	45.93	74.00	-28.07	P	1.02
7066.01	34.20	39.87	6.62	35.69	9.50	0.00	35.51	54.00	-18.49	A	1.02

1. AF: Antenna Factor, Cable: Cable Loss, Pre-Amp: Preamplifier gain
2. Spectrum analyzer setting P(Peak): RBW=1MHz, VBW=1MHz, A(Average): RBW=1MHz, VBW=10Hz
3. Dist : correction to extra plate reading to 3m specification distance 1m measurement distance = -9.5dB
4. The result basic equation calculation as follow :  

$$\text{Level} = \text{Reading} + \text{AF} + \text{Cable} - \text{Preamp} + \text{Filter} - \text{Dist}, \text{Margin} = \text{Level} - \text{Limit}$$
5. The test limit is 3M limit.
6. The frequency was searched to 30GHz.
7. The other emission levels were very low against the limit.
8. For normal 802.11a mode.

### 3.7 Photos of Open Site

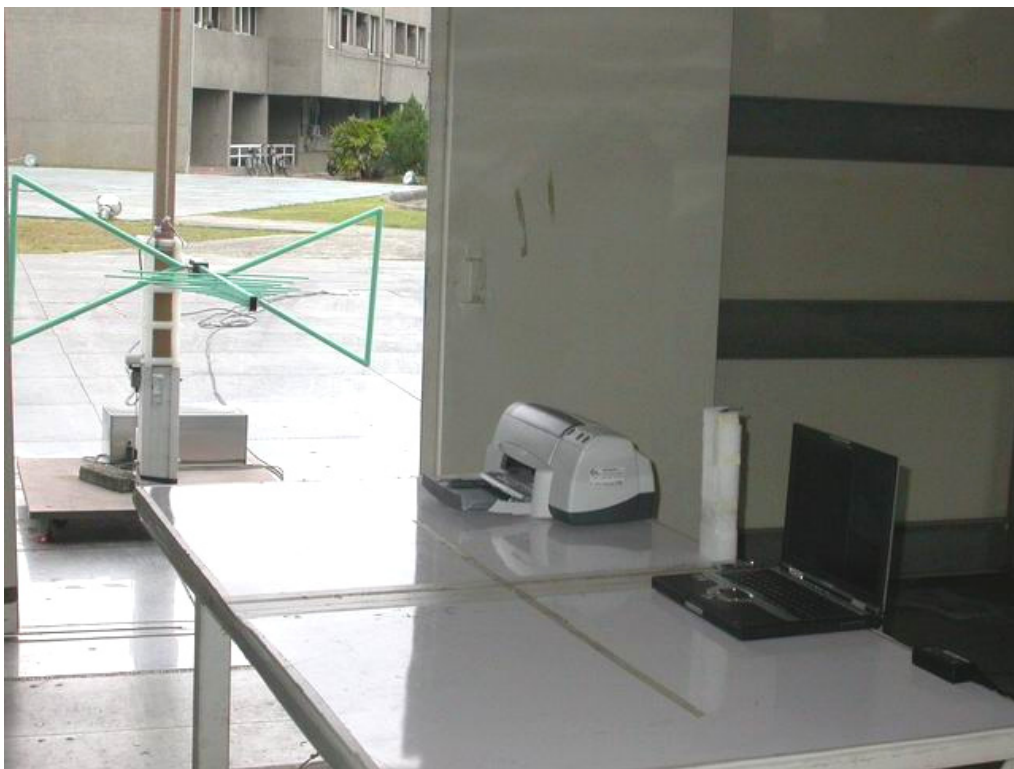
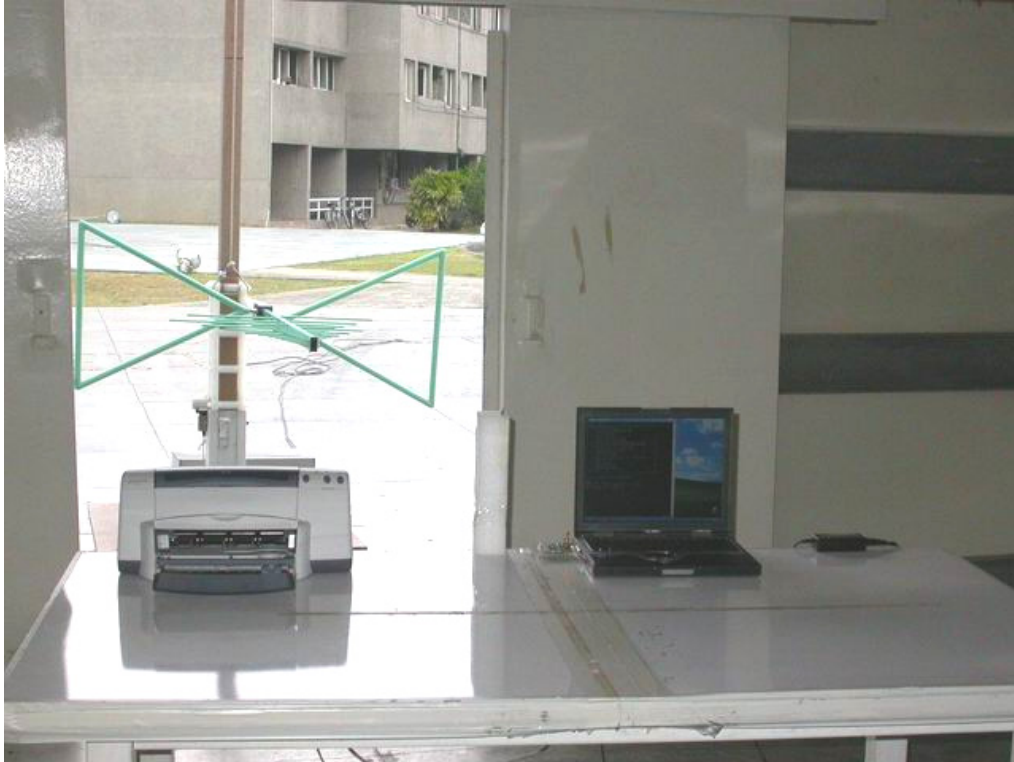





## 4. EMISSION BANDWIDTH MEASUREMENT

### 4.1 Test Equipments

Description & Manufacturer	Model No.	Serial No.	Date Of Calibration	Calibration Period
ROHDE & SCHWARZ SPECTRUM ANALYZER	FSEK30	835253/002	September 06, 2004	1 Year

Note :

1. The measurement uncertainty is less than +/- 2.6dB, which is calculated as per the NAMAS document NIS81.
2. The calibration interval of the above test instruments is 12 months and the calibrations are traceable to NML/ROC and NIST/USA.

### 4.2 Test Setup

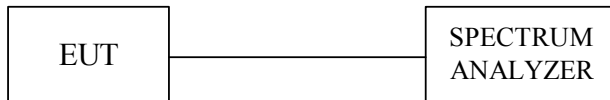

### 4.3 Test Procedure

- A. The transmitter output was connected to the spectrum analyzer.
- B. The bandwidth of the fundamental frequency was measured by spectrum analyzer with 300KHz RBW and 1MHz VBW.
- C. The 26dB bandwidth is defined as the total spectrum the power of which is higher than peak power minus 26dB.
- D. The measured Emission Bandwidth, B, is the 26dB bandwidth.

### 4.4 Uncertainty of Conducted Emission

The uncertainty of conducted emission is  $\pm 200$ KHz.



## 4.5 Test Results

<b>Company</b>	Z-Com, Inc.	<b>Test Date</b>	2005/01/23
<b>Product Name</b>	802.11a/b/g Wireless mini PCI Adapter	<b>Test By</b>	Alan Fan
<b>Model Name</b>	AG-622	<b>TEMP &amp; Humidity</b>	13.9°C, 74%

In 5.15 ~ 5.35 GHz Band  
For normal 802.11a mode

Channel	Channel Frequency (MHz)	26dB Bandwidth (MHz)	Pass / Fail
1	5180	29.36	N/A
4	5240	25.45	N/A
5	5260	25.55	N/A
8	5320	25.75	N/A

For Super A mode

Channel	Channel Frequency (MHz)	26dB Bandwidth (MHz)	Pass / Fail
Low	5200	49.70	N/A
Middle	5240	49.50	N/A
	5260	49.10	N/A
High	5300	47.90	N/A



### 4.6 Photo of 26db Bandwidth Measurement

#### In 5.15 ~ 5.35 GHz Band For normal 802.11a mode

**PK** Delta 1 [T1] RBW 300 kHz RF Att 30 dB  
Ref Lvl -0.33 dB VBW 1 MHz  
127 dB $\mu$ V 29.35871743 MHz SWT 5 ms Unit dB $\mu$ V

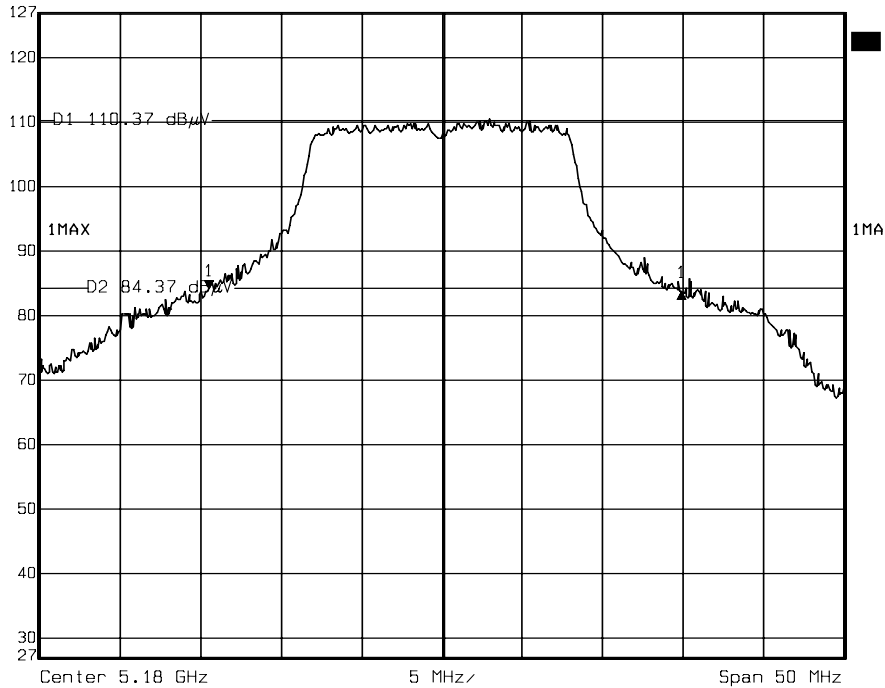

Date: 22.JAN.2005 23:08:47

Channel 1

**PK** Delta 1 [T1] RBW 300 kHz RF Att 30 dB  
Ref Lvl -0.75 dB VBW 1 MHz  
127 dB $\mu$ V 25.45090180 MHz SWT 5 ms Unit dB $\mu$ V

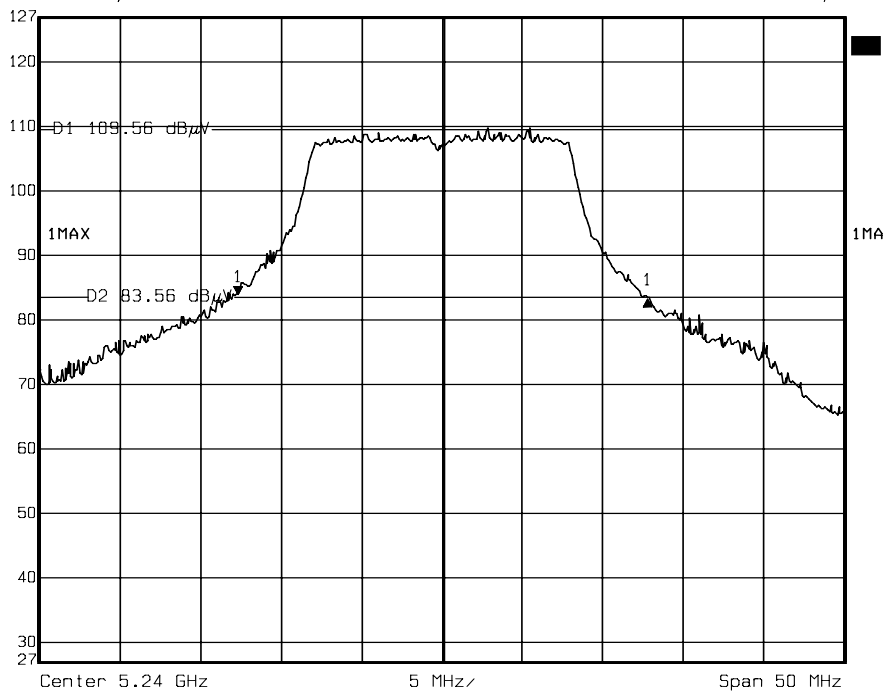

Date: 23.JAN.2005 00:40:59

Channel 4

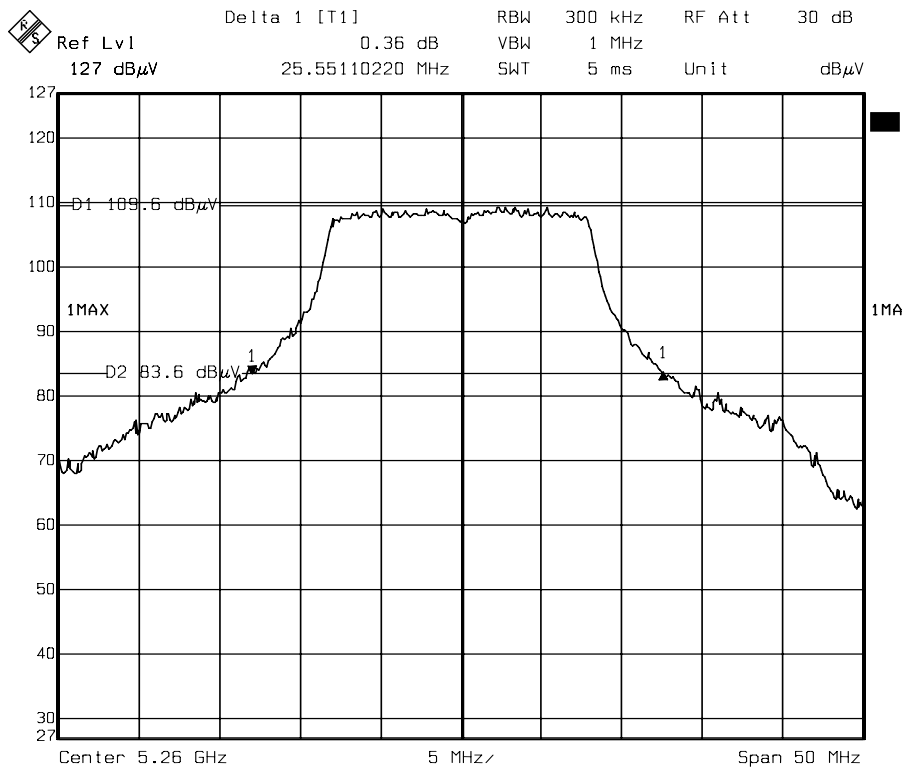

Date: 21.FEB.2005 15:29:05

### Channel 5

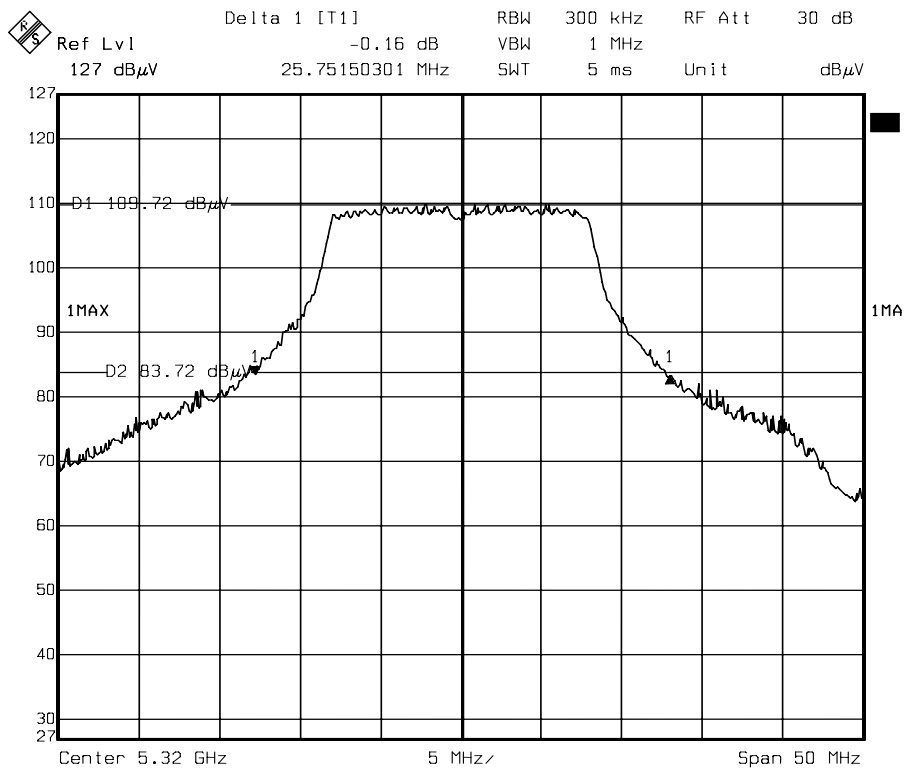

Date: 22.JAN.2005 23:10:39

### Channel 8



**For Super A mode**

	Delta 1 [T1]	RBW	300 kHz	RF Att	30 dB
Ref Lvl	-0.64 dB	VBW	1 MHz		
127 dB $\mu$ V	49.69939880 MHz	SWT	5 ms	Unit	dB $\mu$ V

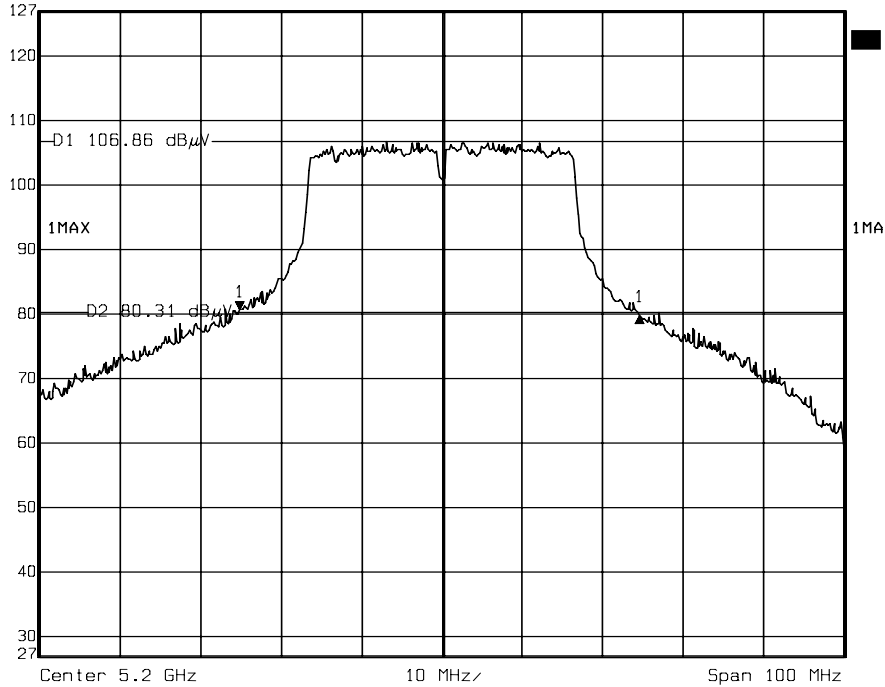

Date: 23.JAN.2005 00:47:05

Channel Low (5200MHz)

	Delta 1 [T1]	RBW	300 kHz	RF Att	30 dB
Ref Lvl	-0.58 dB	VBW	1 MHz		
127 dB $\mu$ V	49.49899800 MHz	SWT	5 ms	Unit	dB $\mu$ V

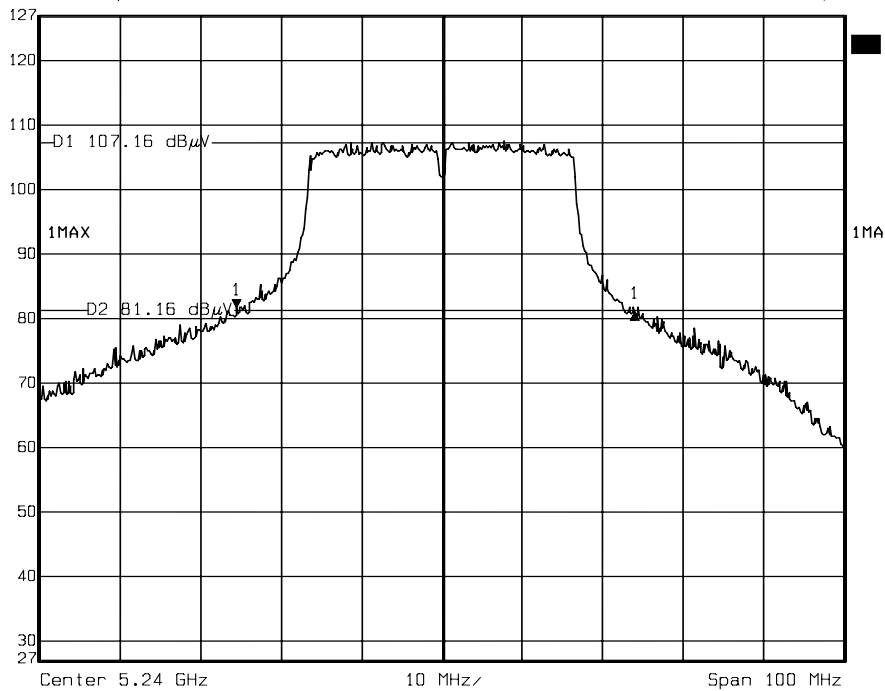

Date: 23.JAN.2005 00:48:34

Channel Middle (5240MHz)



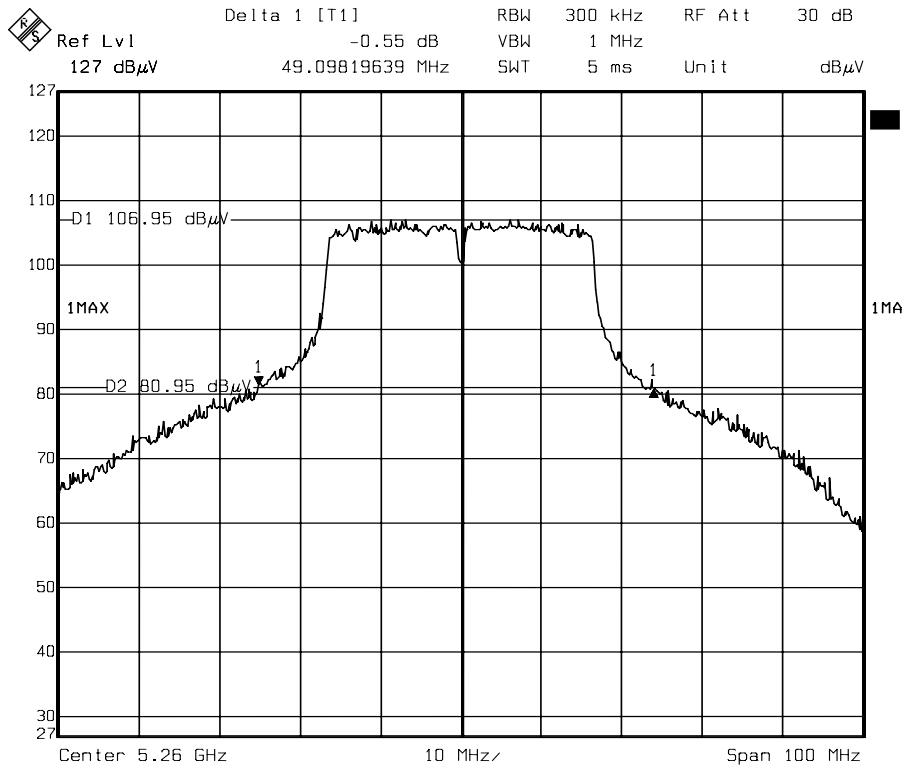

Date: 21.FEB.2005 17:08:03

Channel Middle (5260MHz)

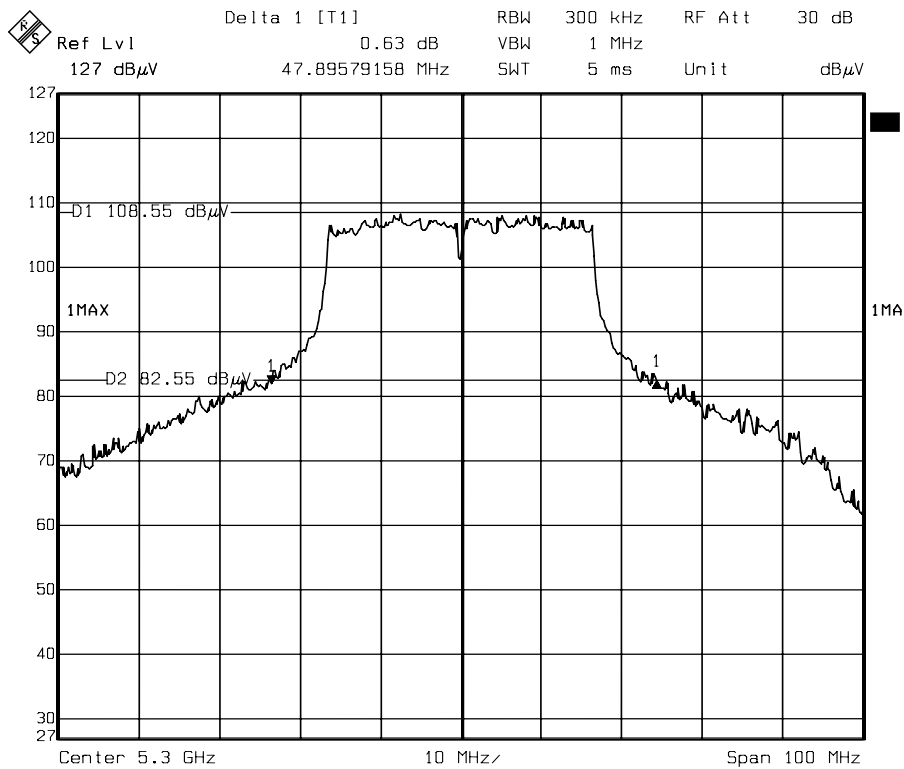

Date: 22.JAN.2005 22:57:18

Channel High (5300MHz)



## 5. PEAK CONDUCTED TRANSMIT POWER

### 5.1 Test Equipments

Description & Manufacturer	Model No.	Serial No.	Date Of Calibration	Calibration Period
ROHDE & SCHWARZ SPECTRUM ANALYZER	FSEK30	835253/002	September 06, 2004	1 Year

Note :

1. The measurement uncertainty is less than +/- 2.6dB, which is calculated as per the NAMAS document NIS81.
2. The calibration interval of the above test instruments is 12 months and the calibrations are traceable to NML/ROC and NIST/USA.

### 5.2 Test Setup

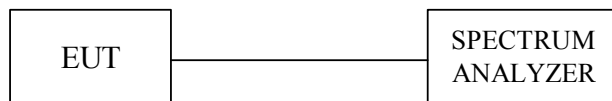



### 5.3 Limits of Maximum Peak Output Power

Channel Frequency Band	FCC Output Power Limit (dBm)
5.15 ~ 5.25GHz Band	17 or $4+10\log B$
5.25 ~ 5.35GHz Band	24 or $11+10\log B$
5.47 ~ 5.725GHz Band	24 or $11+10\log B$
5.725 ~ 5.825GHz Band	30 or $17+10\log B$

For 5.15 ~ 5.25GHz band, If transmitting antennas of directional gain greater than 6 dBi are used, both the peak transmit power and the peak power spectral density shall be reduced by the amount in dB that the directional gain of the antenna exceeds 6 dBi. For 5.25 ~ 5.35GHz and 5.47 ~ 5.725GHz, if transmitting antennas of directional gain greater than 6 dBi are used, both the peak transmit power and the peak power spectral density shall be reduced by the amount in dB that the directional gain of the antenna exceeds 6 dBi.

For 5.725 ~ 5.825GHz band, if transmitting antennas of directional gain greater than 6 dBi are used, both the peak transmit power and the peak power spectral density shall be reduced by the amount in dB that the directional gain of the antenna exceeds 6 dBi. However, fixed point-to-point U-NII devices operating in this band may employ transmitting antennas with directional gain up to 23 dBi without any corresponding reduction in the transmitter peak output power or peak power spectral density. For fixed, point-to-point U-NII transmitters that employ a directional antenna gain greater than 23 dBi, a 1 dB reduction in peak transmitter power and peak power spectral density for each 1 dB of antenna gain in excess of 23 dBi would be required.

### 5.4 Test Procedure

1. Set span to encompass the entire emission bandwidth (EBW) of the signal.  
Set RBW = 1 MHz.  
Set VBW=3 MHz.
2. Use peak detector mode if bin width (i.e., span/number of points in spectrum display) < 0.5 RBW. Otherwise use peak detector mode.
3. Transmitter must operate at full control power for entire sweep of every sweep.
4. If the device transmits continuously, with no off intervals or reduced power intervals, the trigger may be set to "free run".
5. Trace average 100 traces in power averaging mode.
6. Compute power by integrating the spectrum across the 26 dB EBW of the signal

### 5.5 Uncertainty of Conducted Emission

The uncertainty of conducted emission is  $\pm 1.82\text{dB}$ .



## 5.6 Test Results

<b>Company</b>	Z-Com, Inc.	<b>Test Date</b>	2005/01/23
<b>Product Name</b>	802.11a/b/g Wireless mini PCI Adapter	<b>Test By</b>	Alan Fan
<b>Model Name</b>	AG-622	<b>TEMP &amp; Humidity</b>	21.1°C, 63%

In 5.15 ~ 5.35 GHz Band

For normal 802.11a mode

Cable loss = 0.5dB

Channel	Channel Frequency (MHz)	26dB Bandwidth (MHz)	Output Power (dBm)	FCC Output Power Limit (dBm)	Pass / Fail
1	5180	29.36	15.69	17	PASS
4	5240	25.45	16.11	17	PASS
5	5260	25.55	16.17	24	PASS
8	5320	25.75	17.18	24	PASS

For Super A mode

Cable loss = 0.5dB

Channel	Channel Frequency (MHz)	26dB Bandwidth (MHz)	Output Power (dBm)	FCC Output Power Limit (dBm)	Pass / Fail
Low	5200	49.70	16.29	17	PASS
Middle	5240	49.50	16.63	17	PASS
	5260	49.10	16.00	24	PASS
High	5300	47.90	18.17	24	PASS



### 5.7 Photo of Peak Conducted Transmit Power Measurement

#### In 5.15 ~ 5.35 GHz Band For normal 802.11a mode

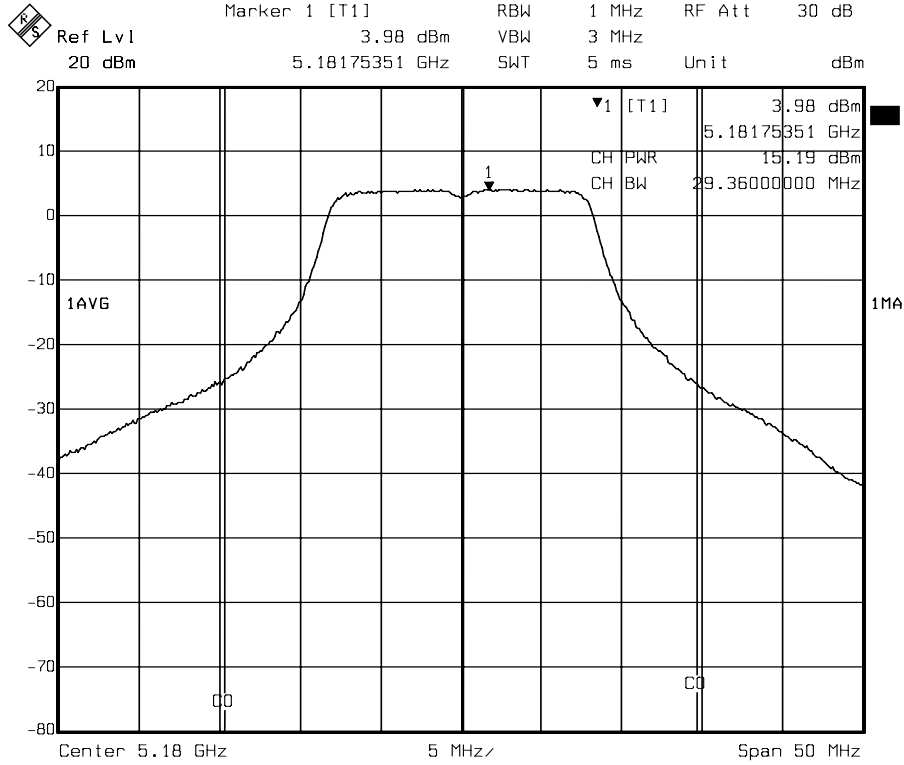

Channel 1

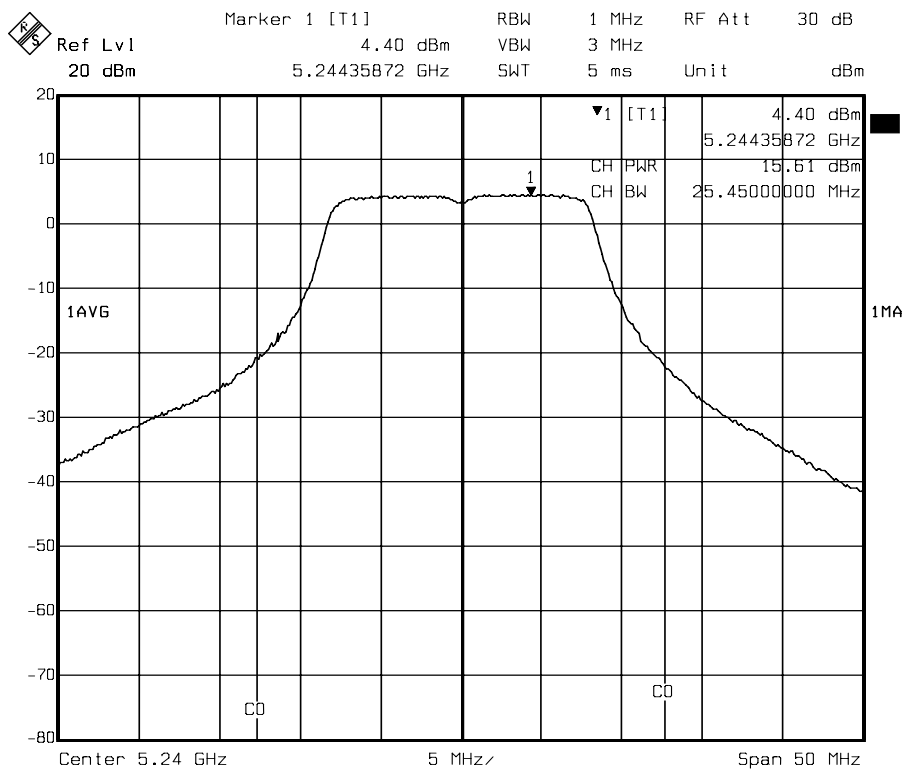

Channel 4

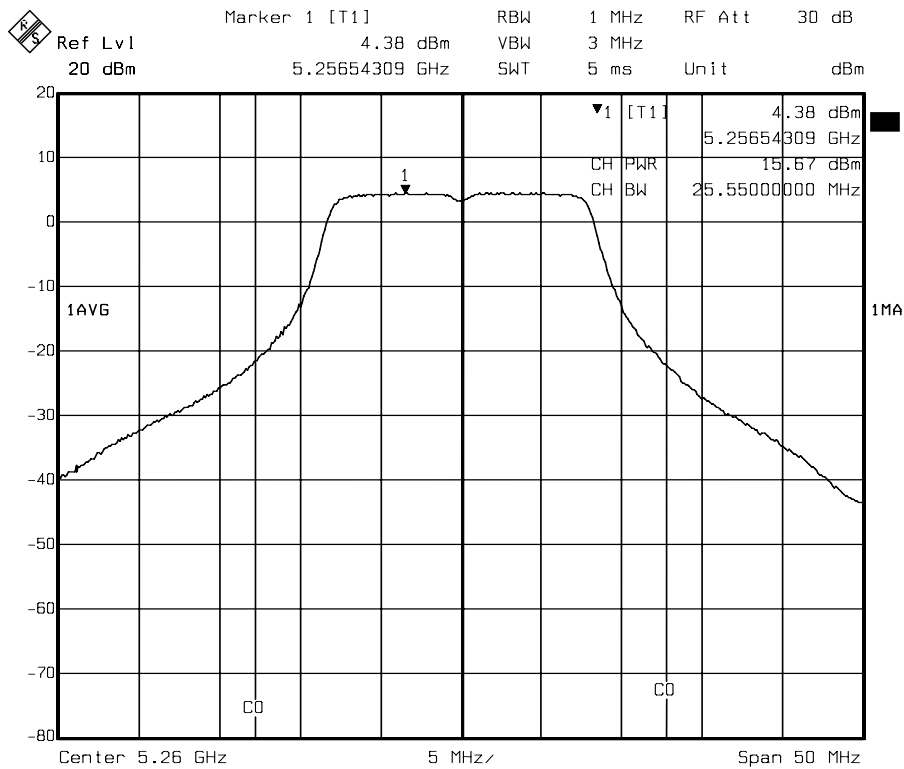

Date: 21.FEB.2005 15:40:42

### Channel 5

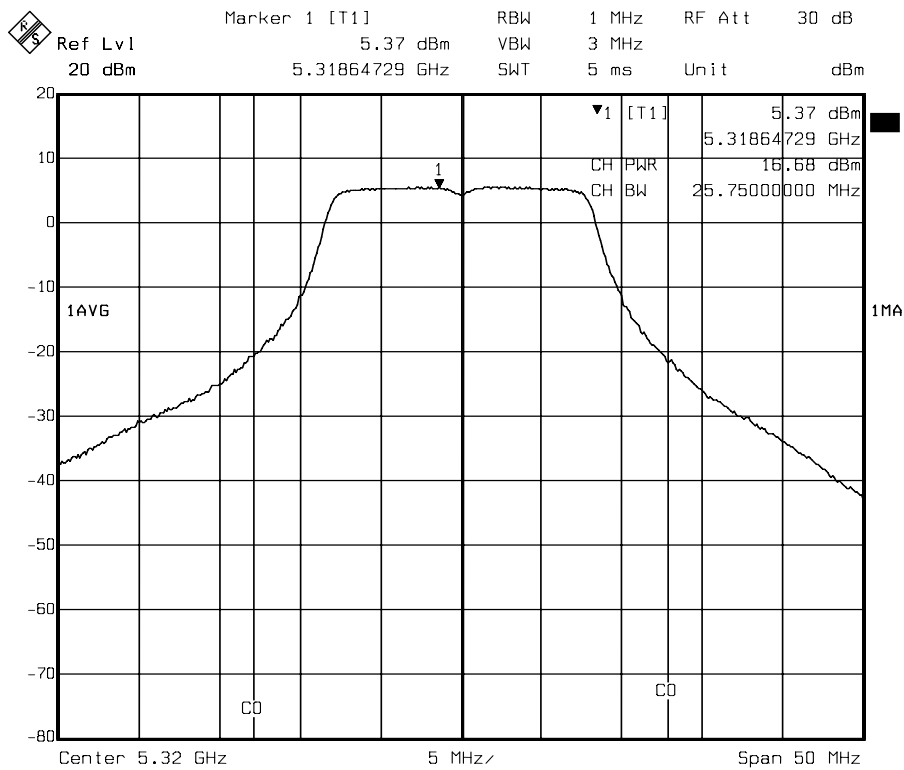

Date: 23.JAN.2005 01:17:03

### Channel 8



### For Super A mode

Marker 1 [T1] RBW 1 MHz RF Att 30 dB  
Ref Lvl 1.73 dBm VBW 3 MHz  
20 dBm 5.20350701 GHz SWT 5 ms Unit dBm

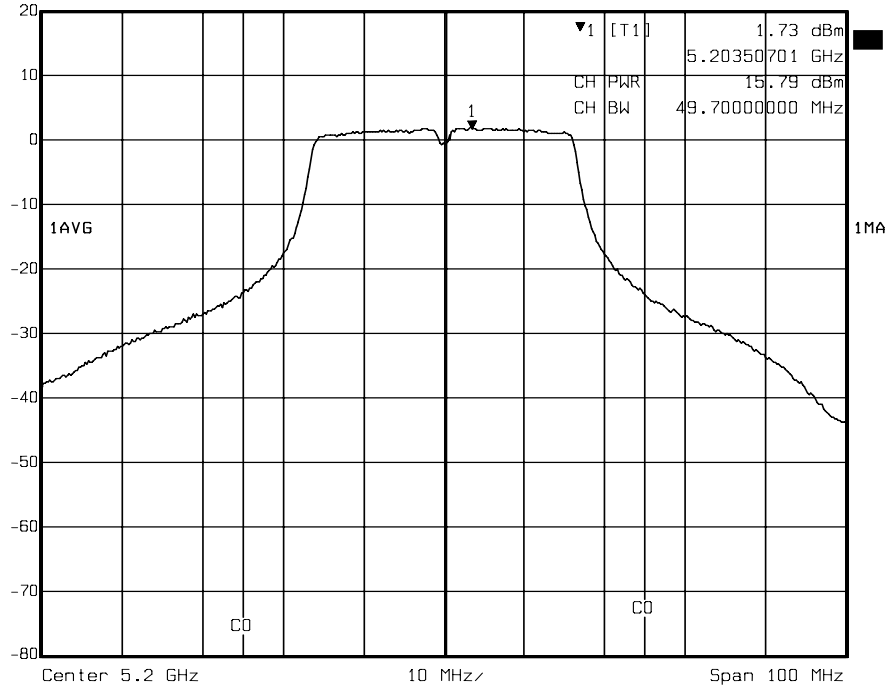

Date: 23.JAN.2005 00:56:18

### Channel Low (5200MHz)

Marker 1 [T1] RBW 1 MHz RF Att 30 dB  
Ref Lvl 2.03 dBm VBW 3 MHz  
20 dBm 5.24250501 GHz SWT 5 ms Unit dBm

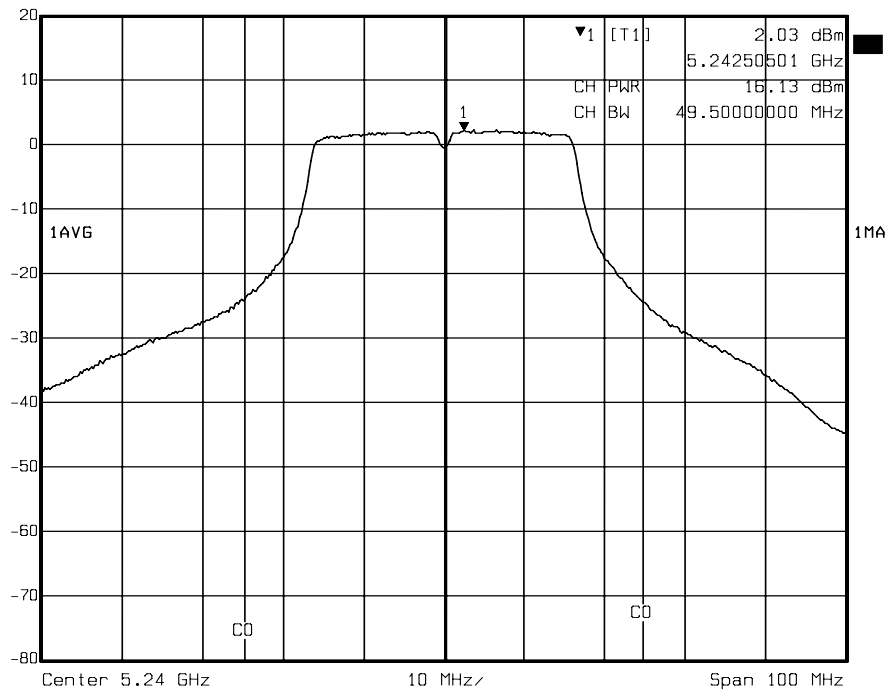

Date: 23.JAN.2005 00:54:42

### Channel Middle (5240MHz)

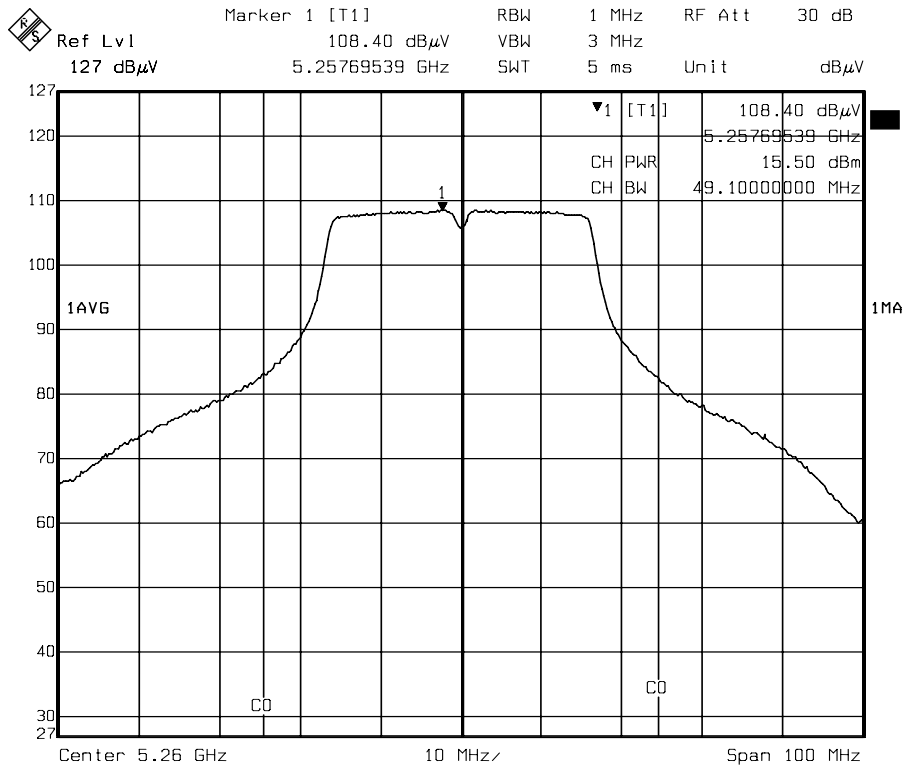

Date: 21.FEB.2005 17:10:21

Channel Middle (5260MHz)

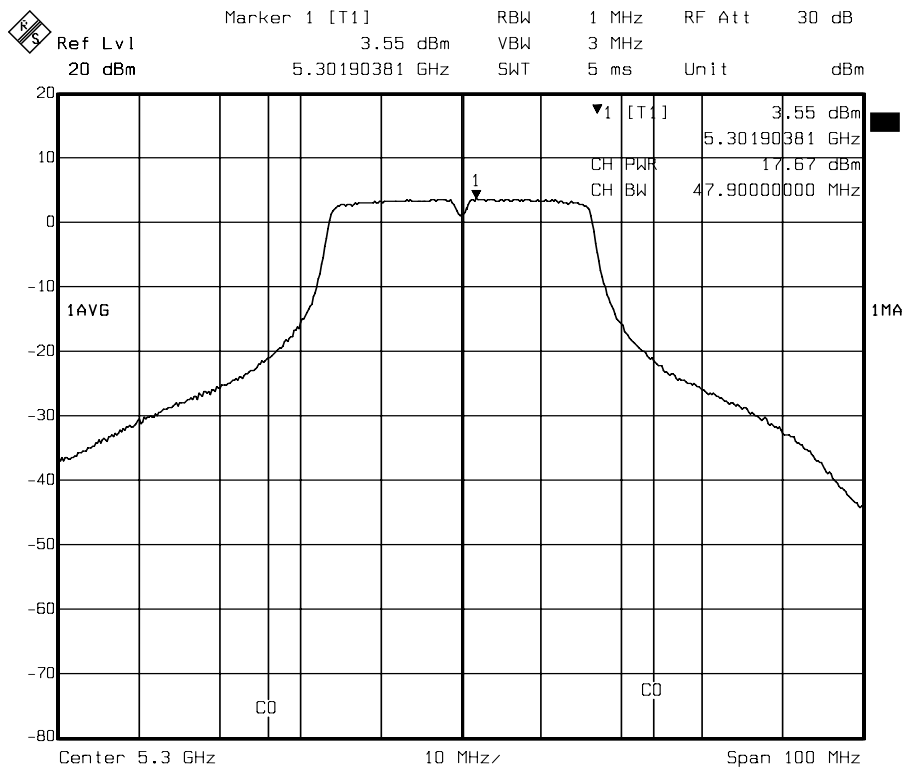

Date: 23.JAN.2005 00:58:05

Channel High (5300MHz)





## 6. PEAK POWER DENSITY MEASUREMENT

### 6.1 Test Equipments

Description & Manufacturer	Model No.	Serial No.	Date Of Calibration	Calibration Period
ROHDE & SCHWARZ SPECTRUM ANALYZER	FSEK30	835253/002	September 06, 2004	1 Year

Note :

1. The measurement uncertainty is less than +/- 2.6dB, which is calculated as per the NAMAS document NIS81.
2. The calibration interval of the above test instruments is 12 months and the calibrations are traceable to NML/ROC and NIST/USA.

### 6.2 Test Setup

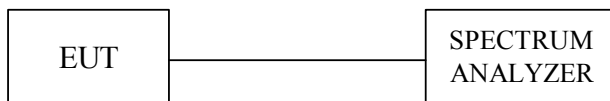

### 6.3 Limits of Power Spectral Density Measurement

Channel Frequency Band	FCC Peak Power Spectrum density Limit (dBm)
5.15 ~ 5.25GHz Band	4 dBm/MHz
5.25 ~ 5.35GHz Band	11dBm/MHz
5.47 ~ 5.725GHz Band	11 dBm/MHz
5.725 ~ 5.825GHz Band	17 dBm/MHz



## 6.4 Test Procedure

The transmitter output was connected to the spectrum analyzer through an attenuator, the bandwidth of the fundamental frequency was measured with the spectrum analyzer using 1MHz RBW and 3MHz VBW. The power spectral density was measured and recorded.

## 6.5 Uncertainty of Conducted Emission

The uncertainty of conducted emission is  $\pm 1.82$ dB.

## 6.6 Test Results

<b>Company</b>	Z-Com, Inc.	<b>Test Date</b>	2005/01/22
<b>Product Name</b>	802.11a/b/g Wireless mini PCI Adapter	<b>Test By</b>	Alan Fan
<b>Model Name</b>	AG-622	<b>TEMP &amp; Humidity</b>	21.1°C, 63%

In 5.15 ~ 5.35 GHz Band  
For normal 802.11a mode

Cable loss = 0.5dB

Channel	Channel Frequency (MHz)	26dB Bandwidth (MHz)	Peak Power Spectrum density (dBm)	FCC Peak Power Spectrum density Limit (dBm)	Pass / Fail
1	5180	29.36	-1.43	4 dBm/MHz	PASS
4	5240	25.45	2.67	4 dBm/MHz	PASS
5	5260	25.55	2.89	11 dBm/MHz	PASS
8	5320	25.75	-0.75	11 dBm/MHz	PASS

For Super A mode

Cable loss = 0.5dB

Channel	Channel Frequency (MHz)	26dB Bandwidth (MHz)	Peak Power Spectrum density (dBm)	FCC Peak Power Spectrum density Limit (dBm)	Pass / Fail
Low	5200	49.70	-2.52	4 dBm/MHz	PASS
Middle	5240	49.50	1.56	4 dBm/MHz	PASS
	5260	49.10	0.90	11 dBm/MHz	PASS
High	5300	47.90	-2.61	11 dBm/MHz	PASS

Note : Peak Power spectrum density test result = peak power spectrum density reading + cable loss.



### 6.7 Photo of Peak Power Density Measurement

#### In 5.15 ~ 5.35GHz Band For normal 802.11a mode

	Marker 1 [T1]	RBW	1 MHz	RF Att	30 dB
	Ref Lvl	-1.93 dBm	VBW	3 MHz	
	20 dBm	5.17784569 GHz	SWT	5 ms	Unit dBm

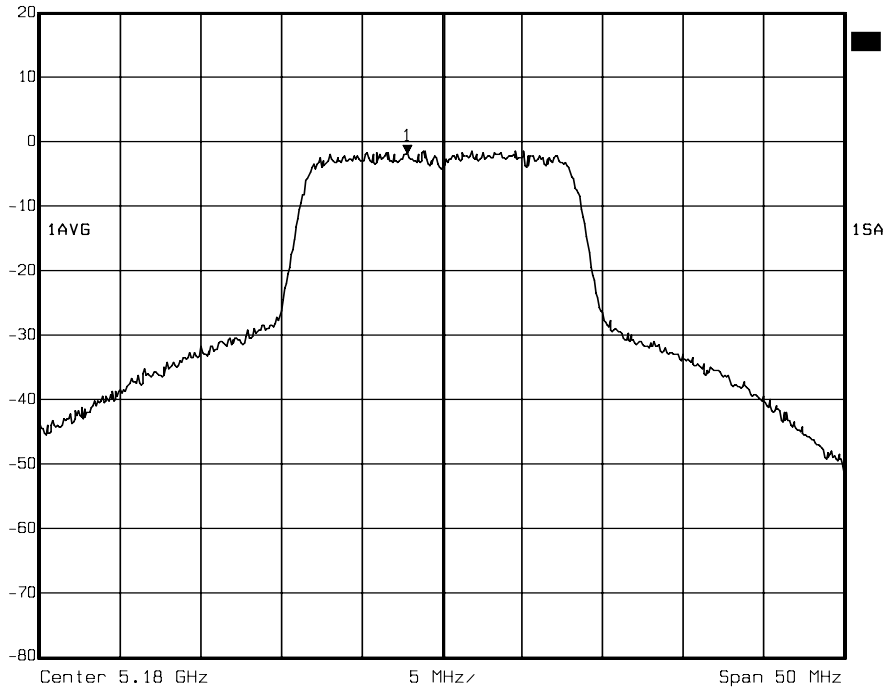

Date: 22.JAN.2005 22:25:35

Channel 1

	Marker 1 [T1]	RBW	1 MHz	RF Att	30 dB
	Ref Lvl	2.17 dBm	VBW	3 MHz	
	20 dBm	5.24145291 GHz	SWT	5 ms	Unit dBm

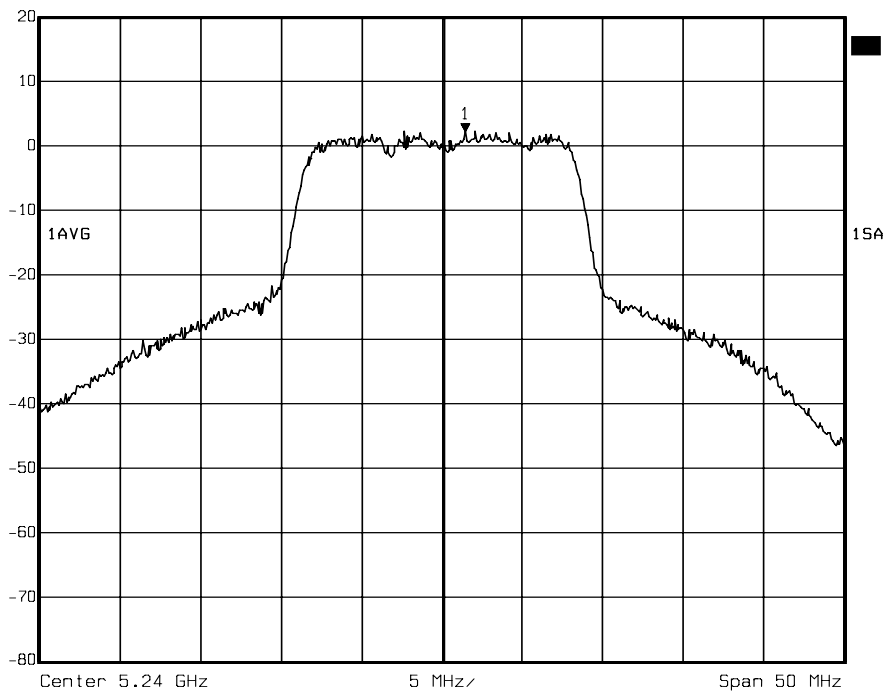

Date: 22.JAN.2005 22:36:02

Channel 4

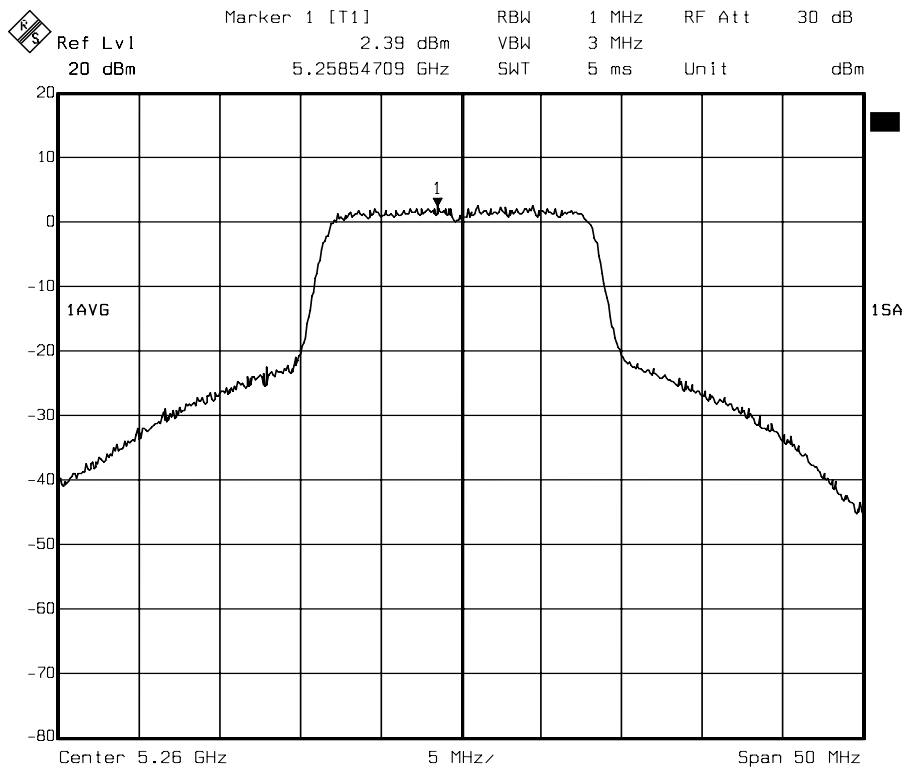

Date: 22.JAN.2005 22:28:18

Channel 5

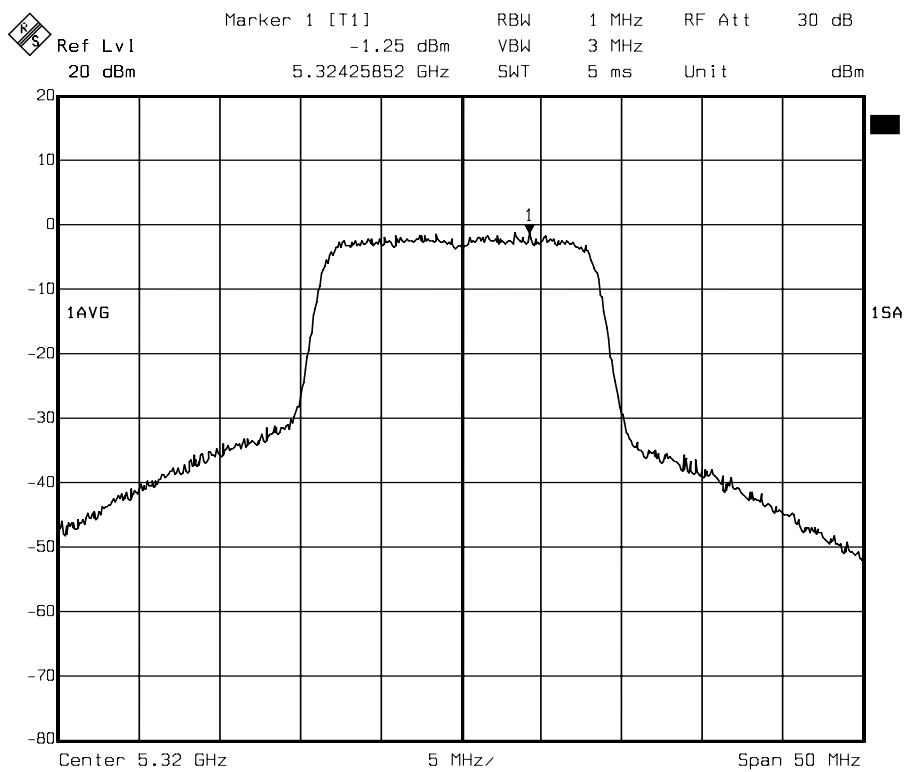

Date: 22.JAN.2005 22:26:36

Channel 8



**For Super A mode**

F S	Marker 1 [T1]	RBW	1 MHz	RF Att	30 dB
	Ref Lvl	-3.02 dBm	VBW	3 MHz	
	20 dBm	5.19609218 GHz	SWT	5 ms	Unit dBm

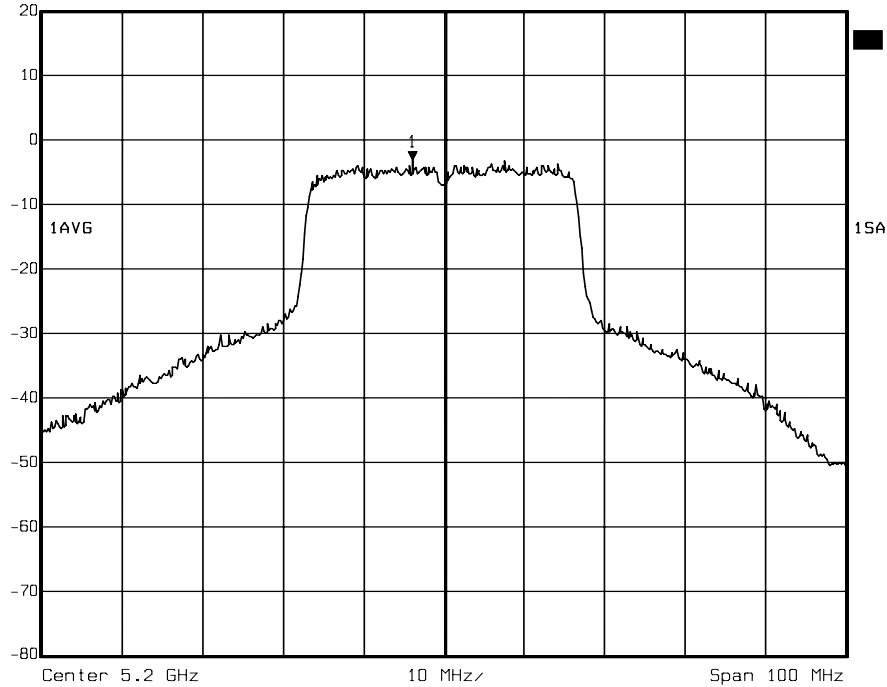

Date: 22.JAN.2005 22:44:42

**Channel Low (5200MHz)**

F S	Marker 1 [T1]	RBW	1 MHz	RF Att	30 dB
	Ref Lvl	1.06 dBm	VBW	3 MHz	
	20 dBm	5.24290581 GHz	SWT	5 ms	Unit dBm

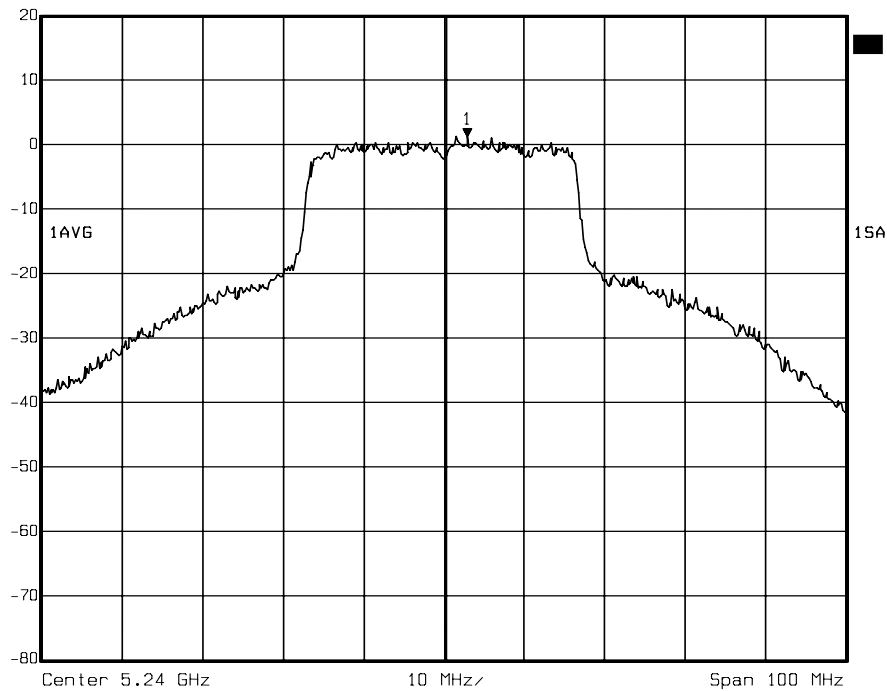

Date: 22.JAN.2005 22:41:31

**Channel Middle (5240MHz)**

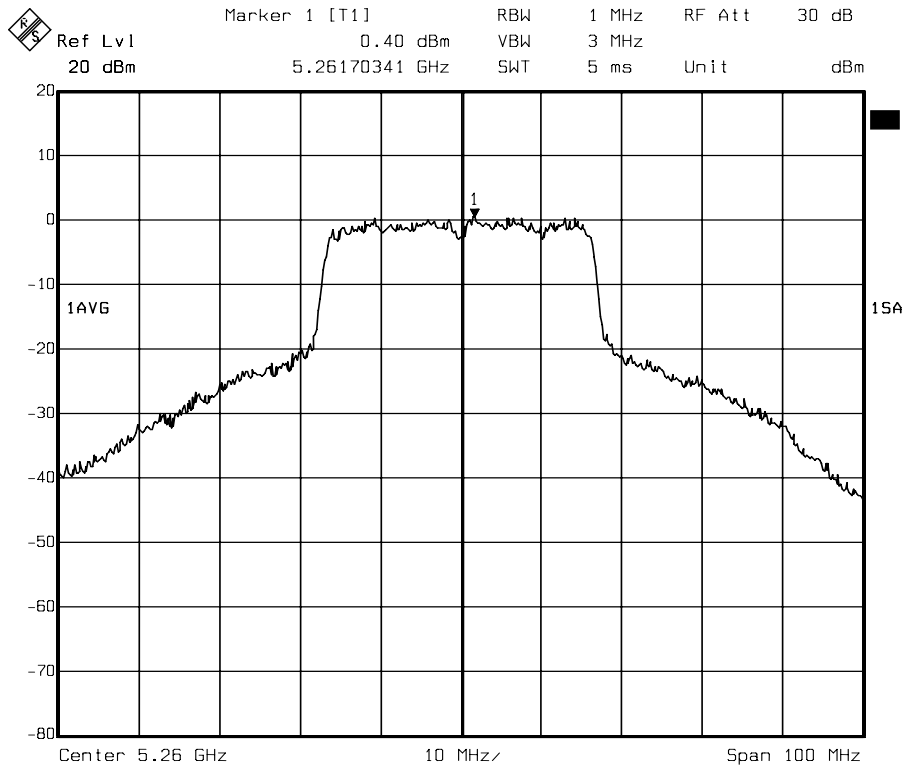

Date: 22.JAN.2005 22:43:13

Channel Middle (5260MHz)

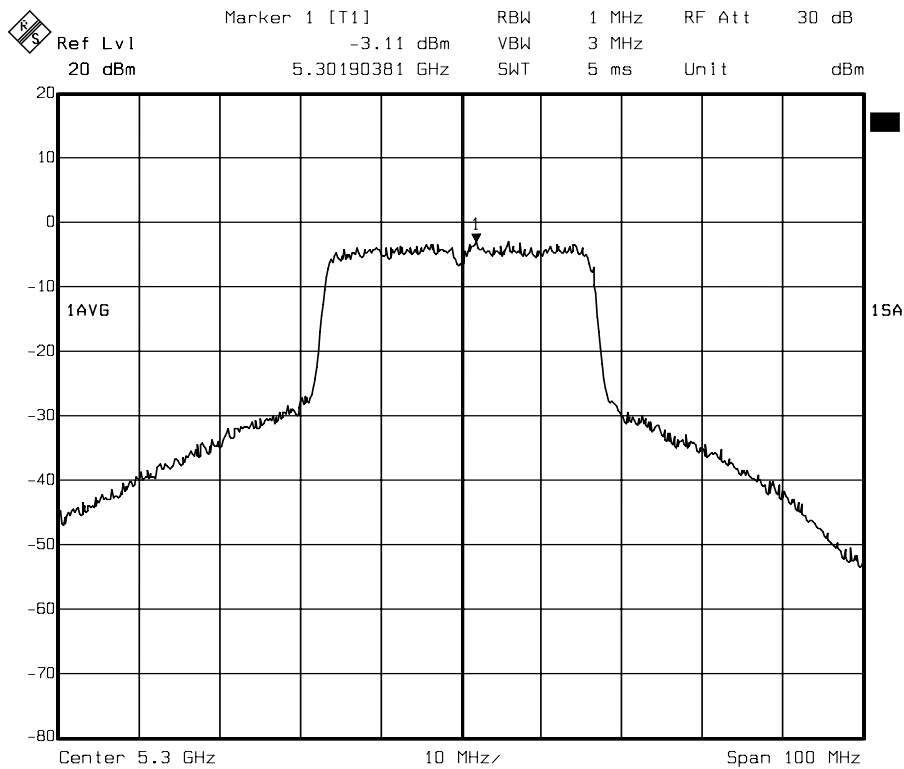

Date: 22.JAN.2005 22:44:08

Channel High (5300MHz)



## 7. PEAK POWER EXCURSION MEASUREMENT

### 7.1 Test Equipments

Description & Manufacturer	Model No.	Serial No.	Date Of Calibration	Calibration Period
ROHDE & SCHWARZ SPECTRUM ANALYZER	FSEK30	835253/002	September 06, 2004	1 Year

Note :

1. The measurement uncertainty is less than +/- 2.6dB, which is calculated as per the NAMAS document NIS81.
2. The calibration interval of the above test instruments is 12 months and the calibrations are traceable to NML/ROC and NIST/USA.

### 7.2 Test Setup

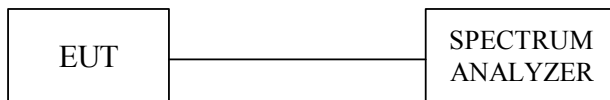

### 7.3 Limits of Peak Power Excursion Measurement

The largest distance between the two traces described in test procedure must be fewer than 13dB. For all frequencies across the emission bandwidth.

Channel Frequency Band	Peak Power Excursion Ratio (dBm)
5.15 ~ 5.25GHz Band	13 dB
5.25 ~ 5.35GHz Band	13dB
5.47 ~ 5.725GHz Band	13 dB
5.725 ~ 5.825GHz Band	13 dB

### 7.4 Test Procedure

- Set the spectrum to view the entire emission bandwidth.
- Measure trace 1:  
Set RBW=1MHz, VBW ≥ 3MHz with peak detector and Max-hold setting.
- Measure trace2:  
Set RBW=1MHz, VBW=3MHz, with peak detector and trace average 100 traces in power averaging mode.
- Plot the result of the two traces and mark the largest distance between the two trace.



## 7.5 Uncertainty of Conducted Emission

The uncertainty of conducted emission is  $\pm 1.82\text{dB}$ .

## 7.6 Test Results

<b>Company</b>	Z-Com, Inc.	<b>Test Date</b>	2005/01/23
<b>Product Name</b>	802.11a/b/g Wireless mini PCI Adapter	<b>Test By</b>	Alan Fan
<b>Model Name</b>	AG-622	<b>TEMP &amp; Humidity</b>	21.1°C, 63%

In 5.15 ~ 5.35GHz Band  
For normal 802.11a mode

Channel	Channel Frequency (MHz)	Largest distance between trace 1 and trace 2 (dB)	FCC Peak Excursion Limit (dBm)	Pass / Fail
1	5180	3.74	< 13	PASS
4	5240	3.70	< 13	PASS
5	5260	3.72	< 13	PASS
8	5320	3.67	< 13	PASS

For Super A mode

Channel	Channel Frequency (MHz)	Largest distance between trace 1 and trace 2 (dB)	FCC Peak Excursion Limit (dBm)	Pass / Fail
Low	5200	4.78	< 13	PASS
Middle	5240	5.08	< 13	PASS
	5260	5.16	< 13	PASS
High	5300	5.22	< 13	PASS





### 7.7 Photo of Peak Power Excursion Measurement

**In 5.15 ~ 5.35 GHz Band  
For normal 802.11a mode**

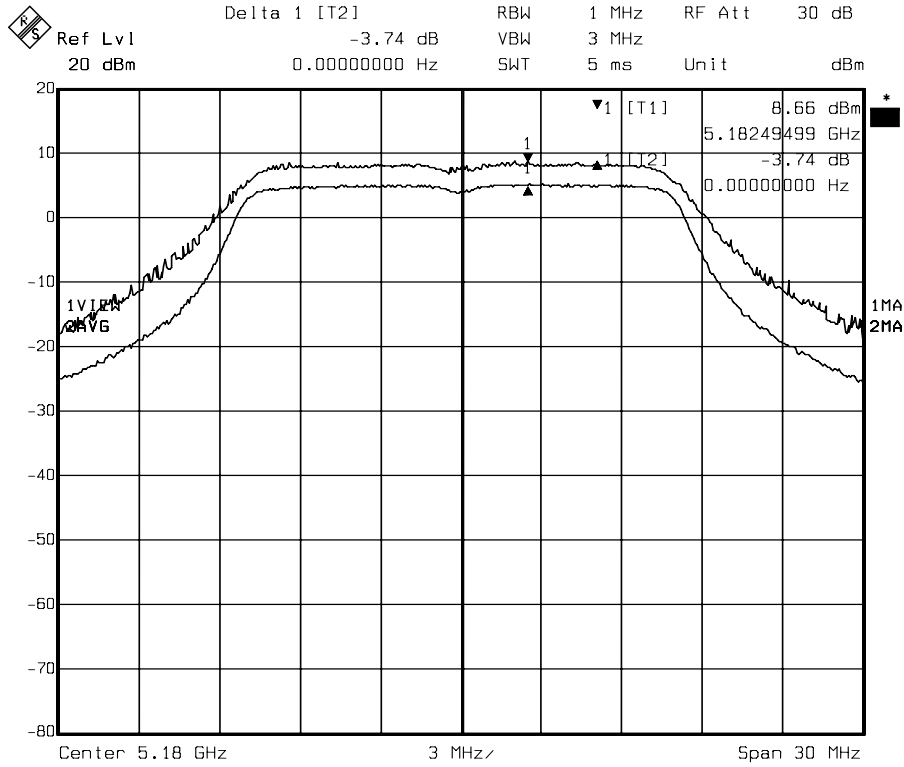

Date: 21.FEB.2005 16:40:58

Channel 1

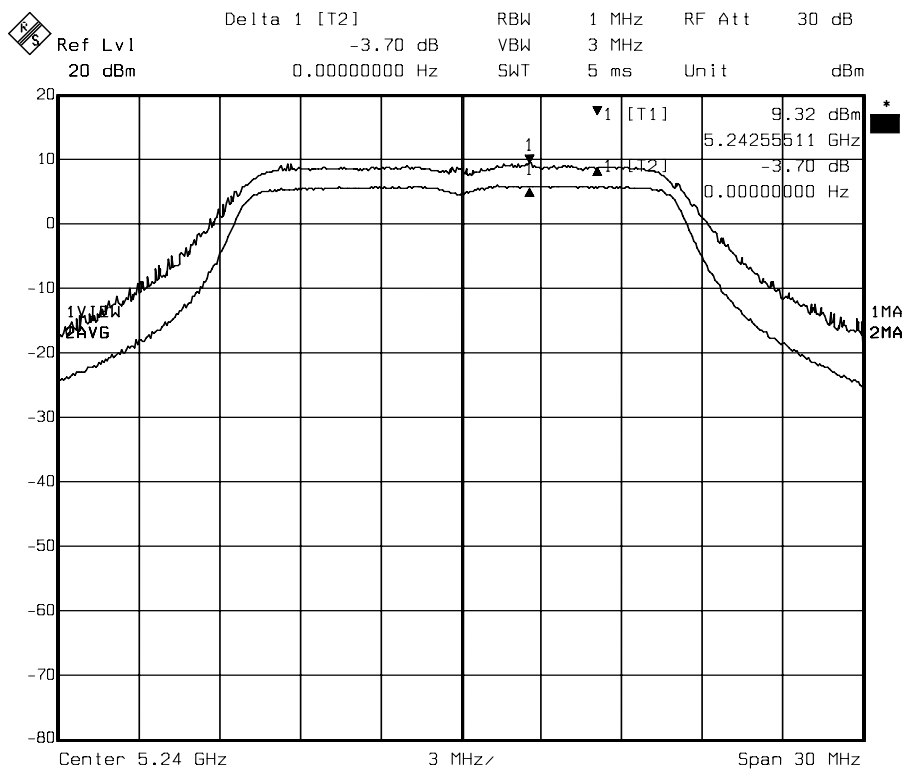

Date: 21.FEB.2005 16:35:50

Channel 4

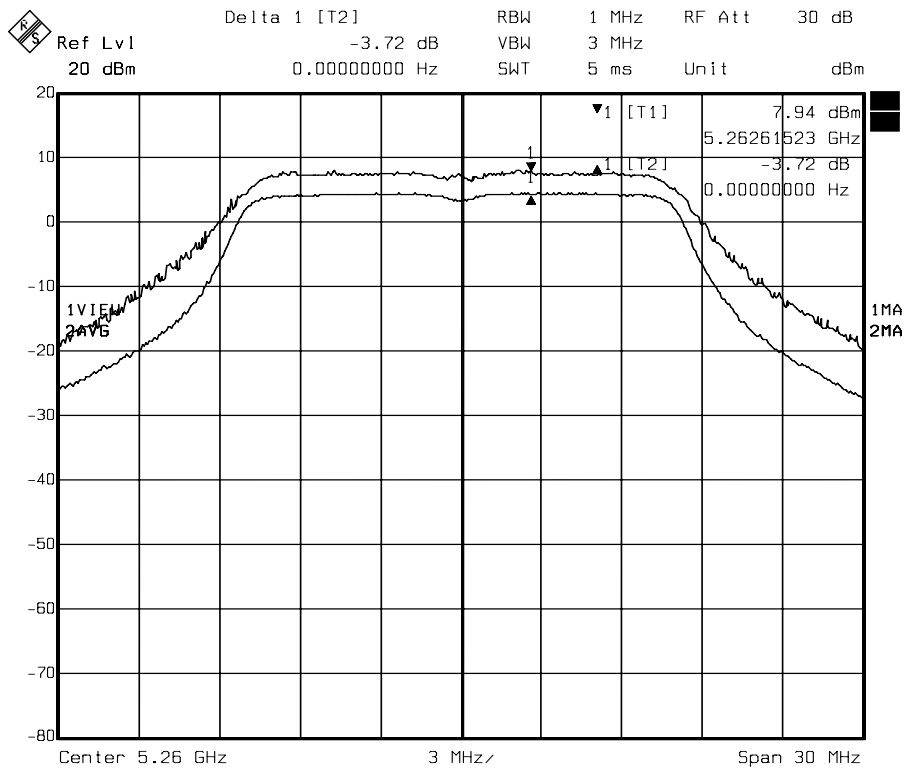

Date: 21.FEB.2005 16:05:51

### Channel 5

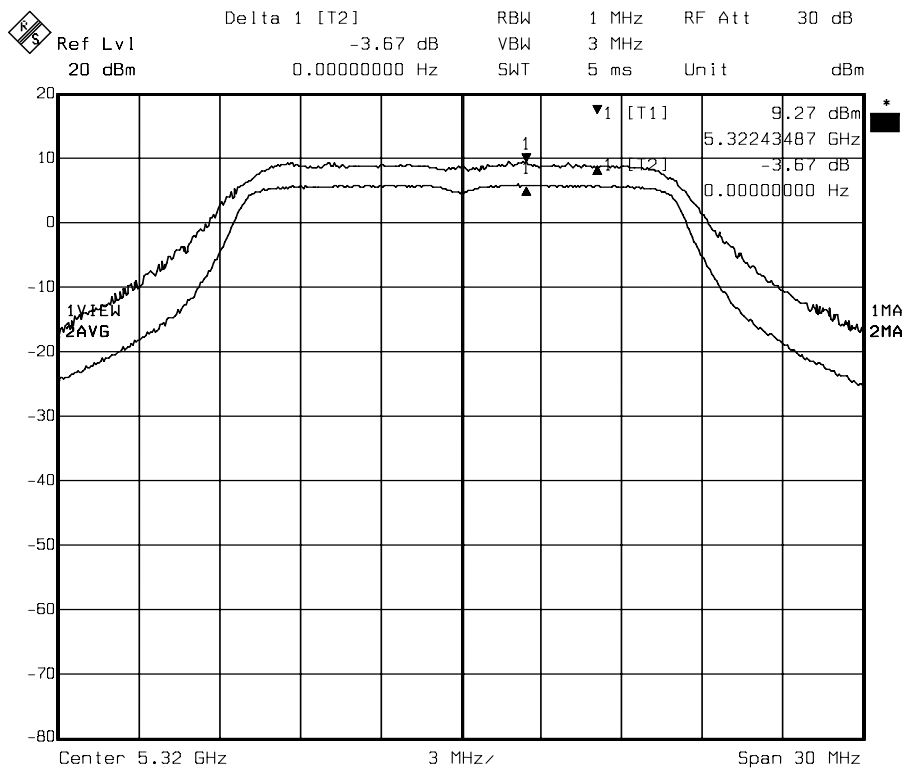

Date: 21.FEB.2005 16:28:31

### Channel 8



**For Super A mode**

Delta 1 [T2] RBW 1 MHz RF Att 30 dB  
Ref Lvl -4.78 dB VBW 3 MHz  
20 dBm 0.00000000 Hz SWT 5 ms Unit dBm

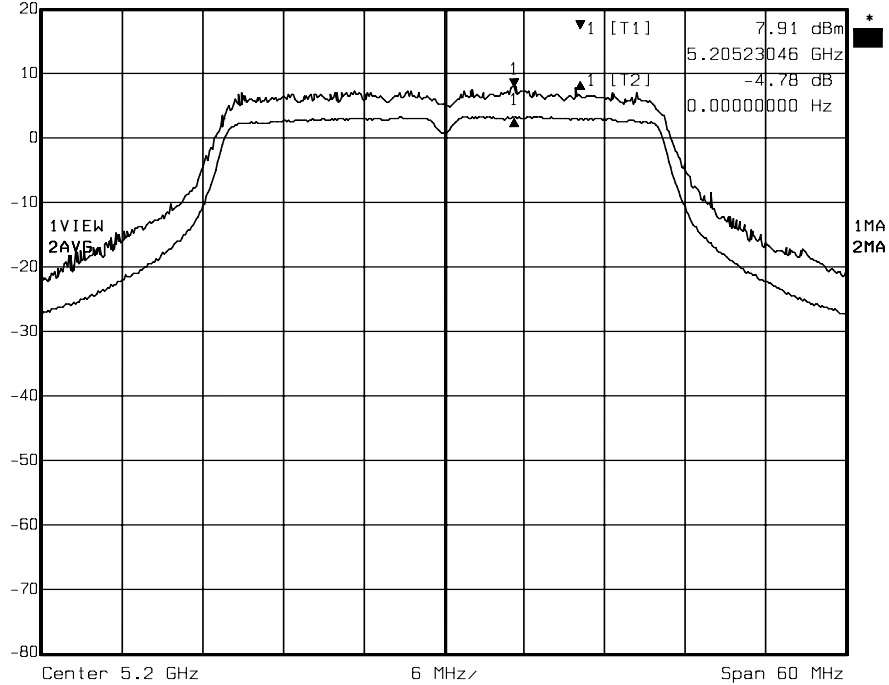

Date: 21.FEB.2005 17:28:07

**Channel Low (5200MHz)**

Delta 1 [T2] RBW 1 MHz RF Att 30 dB  
Ref Lvl -5.08 dB VBW 3 MHz  
20 dBm 0.00000000 Hz SWT 5 ms Unit dBm

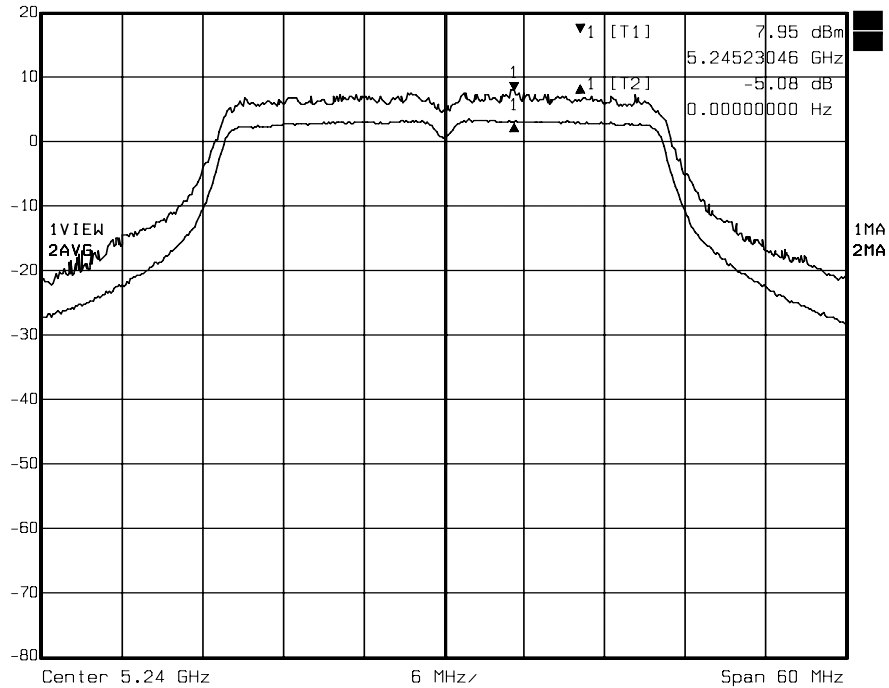

Date: 21.FEB.2005 17:31:14

**Channel Middle (5240MHz)**

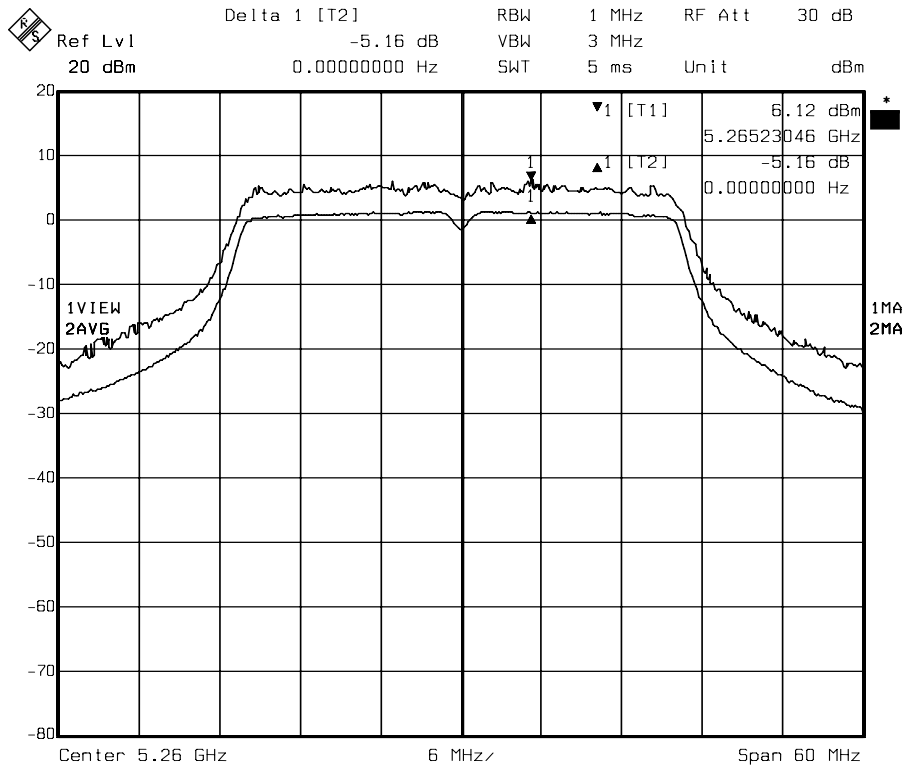

Date: 21.FEB.2005 17:15:23

Channel Middle (5260MHz)

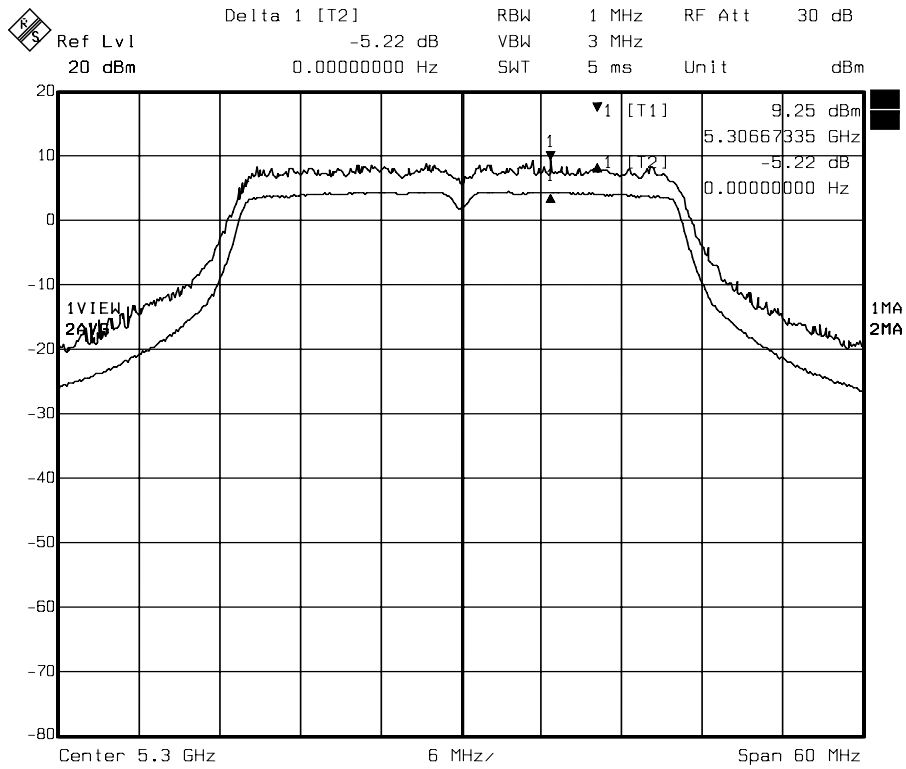

Date: 21.FEB.2005 17:22:06

Channel High (5300MHz)

## 8. FREQUENCY STABILITY

### 8.1 Standard Applicable

Description & Manufacturer	Model No.	Serial No.	Date Of Calibration	Calibration Period
HP SPECTRUM ANALYZER	8595E	3829U01362	July 30, 2004	1 Year

Note :

1. The measurement uncertainty is less than +/- 2.6dB, which is calculated as per the NAMAS document NIS81.
2. The calibration interval of the above test instruments is 12 months and the calibrations are traceable to NML/ROC and NIST/USA.

### 8.2 Test Setup

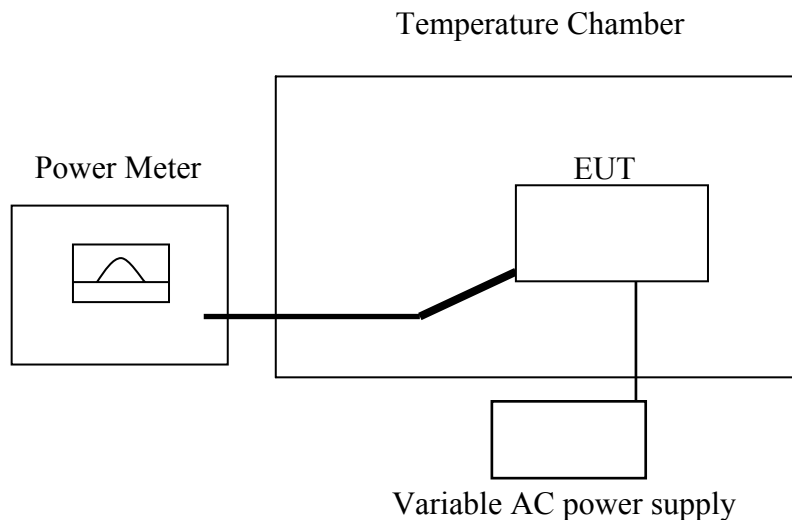

### 8.3 Limits of Frequency Stability

The frequency tolerance of the carrier signal shall be maintained within +/- 20ppm of the operating frequency over a temperature variation of 0 to 50 °C at normal supply voltage, and for a variation in the primary supply voltage from 85% to 115% of the rated supply voltage at a temperature of 25 °C at normal.



## **8.4 Test Procedure**

1. The EUT was placed inside a temperature test chamber and powered by AC voltage supply.
2. Turn the EUT on and connect the RF output port to a spectrum analyzer.
3. Set the temperature in chamber to the declared highest temperature.
4. Wait approximately 30 min to make sure the temperature of the chamber is stabilized.
5. Measure and record the center frequency of carrier at 85% to 115% nominal supplied voltage.
6. Repeat step 4 and 5 with the temperature of chamber is set to the normal temperature, 25°C.
7. Repeat step 4 and 5 with the temperature of chamber is set to the lowest temperature.

## **8.5 Uncertainty of Conducted Emission**

The uncertainty of conducted emission is  $\pm 1.82\text{dB}$ .



## 8.6 Test Results

TEST CONDITIONS		Operating Frequency (MHz) 5180MHz			
		Measured Frequency (MHz)	Frequency Difference (KHz)	Limit (KHz)	Test Result
<b>T<sub>min</sub> ( 0°C)</b>	<b>V<sub>min</sub>(102V)</b>	5179.950	-50.000	±103.6	PASS
	<b>V<sub>nom</sub>(120V)</b>	5179.940	-60.000	±103.6	PASS
	<b>V<sub>max</sub>(138V)</b>	5179.950	-50.000	±103.6	PASS
<b>T<sub>nom</sub> ( 25°C)</b>	<b>V<sub>min</sub>(102V)</b>	5179.920	-80.000	±103.6	PASS
	<b>V<sub>nom</sub>(120V)</b>	5179.960	-40.000	±103.6	PASS
	<b>V<sub>max</sub>(138V)</b>	5179.940	-60.000	±103.6	PASS
<b>T<sub>max</sub> ( 55°C)</b>	<b>V<sub>min</sub>(102V)</b>	5179.940	-60.000	±103.6	PASS
	<b>V<sub>nom</sub>(120V)</b>	5179.930	-70.000	±103.6	PASS
	<b>V<sub>max</sub>(138V)</b>	5179.960	-40.000	±103.6	PASS

TEST CONDITIONS		Operating Frequency (MHz) 5320MHz			
		Measured Frequency (MHz)	Frequency Difference (KHz)	Limit (KHz)	Test Result
<b>T<sub>min</sub> ( 0°C)</b>	<b>V<sub>min</sub>(102V)</b>	5319.950	-50.000	±106.4	PASS
	<b>V<sub>nom</sub>(120V)</b>	5319.930	-70.000	±106.4	PASS
	<b>V<sub>max</sub>(138V)</b>	5319.970	-30.000	±106.4	PASS
<b>T<sub>nom</sub> ( 25°C)</b>	<b>V<sub>min</sub>(102V)</b>	5319.910	-90.000	±106.4	PASS
	<b>V<sub>nom</sub>(120V)</b>	5319.930	-70.000	±106.4	PASS
	<b>V<sub>max</sub>(138V)</b>	5319.900	-100.000	±106.4	PASS
<b>T<sub>max</sub> ( 55°C)</b>	<b>V<sub>min</sub>(102V)</b>	5319.960	-40.000	±106.4	PASS
	<b>V<sub>nom</sub>(120V)</b>	5319.950	-50.000	±106.4	PASS
	<b>V<sub>max</sub>(138V)</b>	5319.940	-60.000	±106.4	PASS

Note :

(1) Limit at 5180MHz is  $5180\text{MHz} \times 20\text{ppm} = 103.6\text{kHz}$ .

(2) Limit at 5320MHz is  $5320\text{MHz} \times 20\text{ppm} = 106.4\text{kHz}$ .



## 9. ANTENNA REQUIREMENT

### 9.1 Standard Applicable

For intentional device, according to FCC 47 CFR Section 15.203, an intentional radiator shall be designed to ensure that no antenna other than that furnished by the responsible party shall be used with the device.

And according to FCC 47 CFR Section 15.407 (d), Any U-NII device that operates in the 5.15 ~ 5.25GHz band shall use a transmitting antenna that is an integral part of the device. If transmitting antennas of directional gain greater than 6 dBi are used, both the peak transmit power and the peak power spectral density shall be reduced by the amount in dB that the directional gain of the antenna exceeds 6 dBi.

For 5.25 ~ 5.35GHz and 5.47 ~ 5.725GHz, if transmitting antennas of directional gain greater than 6 dBi are used, both the peak transmit power and the peak power spectral density shall be reduced by the amount in dB that the directional gain of the antenna exceeds 6 dBi.

For 5.725 ~ 5.825GHz band, if transmitting antennas of directional gain greater than 6 dBi are used, both the peak transmit power and the peak power spectral density shall be reduced by the amount in dB that the directional gain of the antenna exceeds 6 dBi. However, fixed point-to-point U-NII devices operating in this band may employ transmitting antennas with directional gain up to 23 dBi without any corresponding reduction in the transmitter peak output power or peak power spectral density. For fixed, point-to-point U-NII transmitters that employ a directional antenna gain greater than 23 dBi, a 1 dB reduction in peak transmitter power and peak power spectral density for each 1 dB of antenna gain in excess of 23 dBi would be required.

### 9.2 Antenna Connected Construction

The antenna used for this product is PIFA antenna . The temporary antenna connector is MHF connector and the peak Gain of this antenna is only 1.24dBi at 5GHz, 1.37dBi at 2.4GHz.





## 10. RF EXPOSURE EVALUATION

According to FCC 1.1310 : The criteria listed in the following table shall be used to evaluate the environment impact of human exposure to radio frequency (RF) radiation as specified in 1.1307(b)  
LIMITS FOR MAXIMUM PERMISSIBLE EXPOSURE (MPE)

Frequency Range (MHz)	Electric Field Strength (V/m)	Magnetic Field Strength (A/m)	Power Density (mW/cm <sup>2</sup> )	Average Time
(A) Limits for Occupational / Control Exposures				
300-1,500	--	--	F/300	6
1,500-100,000	--	--	5	6
(B) Limits for General Population / Uncontrol Exposures				
300-1,500	--	--	F/1500	6
1,500-100,000	--	--	1	30

### 10.1 Friis Formula

Friis transmission formula :  $P_d = (P_{out} * G) / (4 * \pi * r^2)$

Where

$P_d$  = power density in mW/cm<sup>2</sup>

$P_{out}$  = output power to antenna in mW

G = gain of antenna in linear scale

$P_i = 3.1416$

r = distance between observation point and center of the radiator in cm

$P_d$  is the limit of MPE, 1 mW/cm<sup>2</sup>. If we know the maximum gain of the antenna and the total power input to the antenna, through the calculation, we will know the distance "r" where the MPE limit is reached.

### 10.2 EUT Operating Condition

A software provided by client enabled the EUT to transmit and receive data at lowest, middle and highest channel individually.



### 10.3 Test Result of RF Exposure Evaluation

Test Item : RF Exposure Evaluation Data

Test Mode : Normal Operation

#### 10.3.1 Antenna Gain

Antenna Gain (5GHz) : The maximum Gain measured in fully anechoic chamber is 1.24dBi linear scale.

#### 10.3.2 Output Power into Antenna & RF Exposure Evaluation Distance

Channel	Channel Frequency (MHz)	Output Power to Antenna (dBm)	Antenna Gain	Power Density at 20cm (mW/cm <sup>2</sup> )	LIMITS (mW/cm <sup>2</sup> )
1	5180	15.69	1.24	0.009811	1
4	5240	16.11	1.24	0.010808	1
5	5260	16.17	1.24	0.010958	1
8	5320	17.18	1.24	0.015949	1

Note : 1. For normal 802.11a Mode

2. The power density Pd (4th column) at a distance of 20cm calculated from the Friis transmission formula is far below the limit of 1 mW/cm<sup>2</sup>. The EUT is classified as mobile product. So, RF exposure limit warning or SAR test are not required.

Channel	Channel Frequency (MHz)	Output Power to Antenna (dBm)	Antenna Gain	Power Density at 20cm (mW/cm <sup>2</sup> )	LIMITS (mW/cm <sup>2</sup> )
Low	5200	16.29	1.24	0.011265	1
Middle	5240	16.63	1.24	0.012182	1
	5260	16.00	1.24	0.010537	1
High	5300	18.17	1.24	0.017367	1

Note : 1. For Super A Mode

2. The power density Pd (4th column) at a distance of 20cm calculated from the Friis transmission formula is far below the limit of 1 mW/cm<sup>2</sup>. The EUT is classified as mobile product. So, RF exposure limit warning or SAR test are not required.