

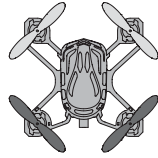

Manufacturer:  
Shenzhen Hubsan Technology Co., Ltd.

protoX™



ESTE4606

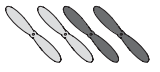
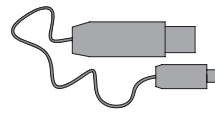
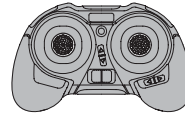

- Do not turn on Proto X unless controller has been turned on first.
- Keep hands, hair and loose clothing away from spinning blades.
- Turn off controller and Proto X when not in use.
- Parental guidance is recommended.
- Do not submerge into water. This could damage electronic assemblies.
- Follow operating instructions exactly.
- Not intended for children under 8 years old.
- Replace any damaged or broken parts before attempting to fly.
- Do not drop the Proto X by suddenly reducing the throttle. This could lead to severe damage.
- The Proto X's range will also be affected if the battery is not fully charged.
- Do not touch the motors after flying. They can become hot.

**FCC STATEMENT AND INDUSTRY CANADA NOTICE:**

1. This device complies with Part 15 of the FCC Rules and Industry Canada licence-exempt RSS standard(s). Operation is subject to the following two conditions:  
(1) this device may not cause harmful interference, and  
(2) this device must accept any interference received, including interference that may cause undesired operation.  
Le présent appareil est conforme aux CNR d'Industrie Canada applicables aux appareils radio exempts de licence. L'exploitation est autorisée aux deux conditions suivantes : (1) l'appareil ne doit pas produire de brouillage, et (2) l'utilisateur de l'appareil doit accepter tout brouillage radioélectrique subi, même si le brouillage est susceptible d'en compromettre le fonctionnement.

2. Changes or modifications not expressly approved by the party responsible for compliance could void the user's authority to operate the equipment.

**Remark:** This device is in accordance with the digital device grade B limitation and the 15th regulation of FCC. This limitation requires reasonable anti-interference protection around the residence. The device can transmit radio wave during use and can interrupt the mobile communication without proper installment. Interruption will occur for special device. If the device do interrupt the radio or television, please turn the device off then turn it on to adjust. Below are some resolution for your reference:

- Move the receiving antenna
- Enlarge the distance between the device and receiver
- Try to not connect the device and the receiver on the same circuit
- Ask for professional help from experts

3. This digital apparatus does not exceed the Class B limits for radio noise emissions from digital apparatus set out in the Radio Interference Regulations of Industry Canada.

**CAUTION:** Changes or modifications to this product not expressly approved by the party responsible for compliance may void the user's authority to operate the equipment.

 Do not touch the spinning blades or fly over another person's head. Adult supervision is required.

**Battery Requirements for Controller:**

Requires: 2 x 1.5V AAA size batteries (not included)

**Requirements for USB Charge Cord:**

USB Output Jack (not included)

**Battery Cautions:**

- Parental guidance is recommended when installing batteries.
- Do not power controller by mixing different types of batteries, or old and new batteries.
- Use only batteries of the same or equivalent type as those recommended.

**The Proto X is equipped with a rechargeable 3.7V LiPo battery. Please pay attention to the following cautions for safe use:**

- Do not dispose of battery into fire or heat.
- Do not use or leave battery near a heat source, such as fire or a heater.
- Do not strike battery or throw it against a hard surface.
- Do not pierce battery.
- Do not disassemble or alter battery.
- Turn off power switch after use.
- Recycle used batteries.



**90 DAY LIMITED WARRANTY**

**PLEASE DO NOT RETURN YOUR PRODUCT TO THE STORE** – Estes will repair or replace factory defects for 90 days from the date of purchase. This warranty specifically does not cover crash damage, misuse or abuse. To make a warranty claim, please contact our product support team at 1-217-398-8970 or e-mail us at [productsupport@hobbico.com](mailto:productsupport@hobbico.com)

If requested by Product Support, please send defective product to: Hobby Services, 3002 N Apollo Dr., Suite #1, Champaign, IL 61822

This warranty applies only if the product is operated in compliance with the instructions and warnings provided with each model. Estes assumes no liability except for the exclusive remedy or repair of parts as specified above. Estes shall not be liable for consequential or incidental damages. Some states do not allow the exclusion of consequential or incidental damages so the above exclusion may not apply to you. This warranty gives you specific legal rights and you may also have other rights which vary from state to state.

**GET READY TO FLY**

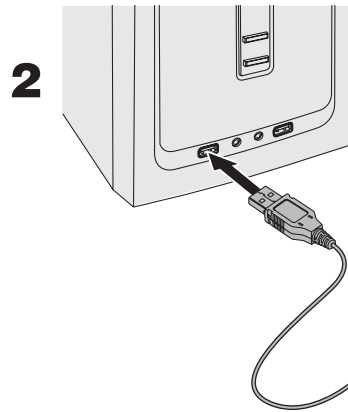
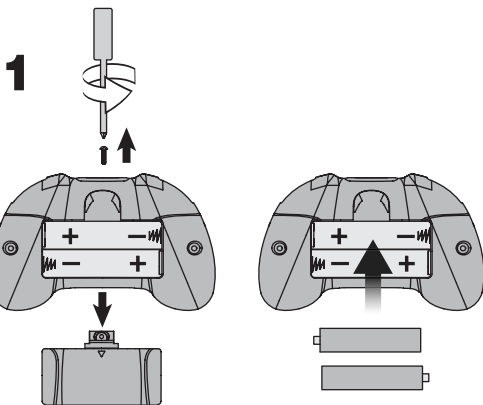

The battery connector will only fit in one way. Do not force the connectors together.

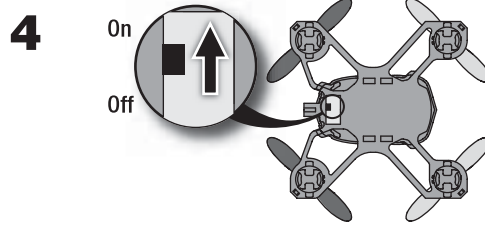
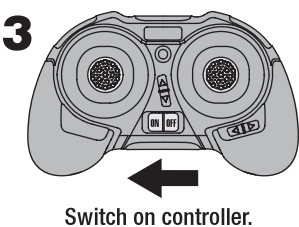

**5** Set the Proto X on a level surface until the blue LEDs change from blinking to solid.

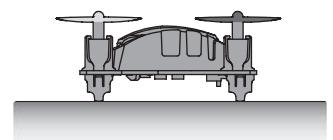

## HOW TO FLY

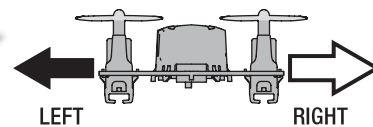
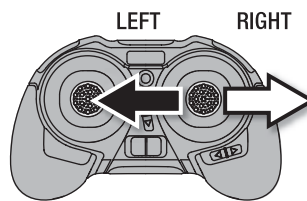
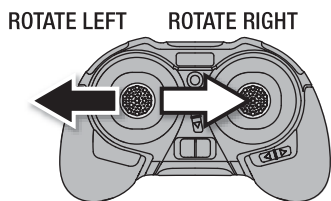
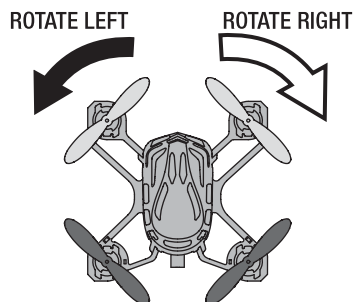
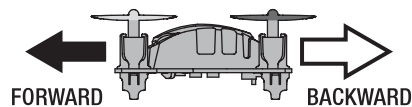
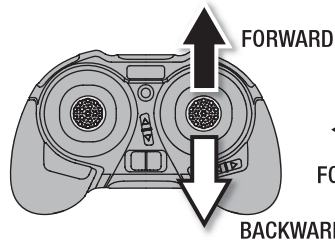
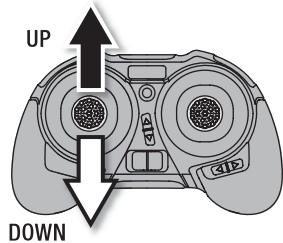
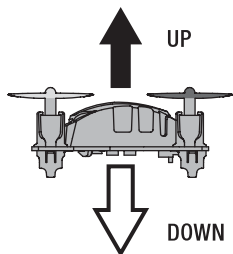

## CORRECTING DRIFT

It is normal for the Proto X to drift slightly. However if it drifts in any direction consistently press the trim button opposite the movement as many times as needed to eliminate the drift.

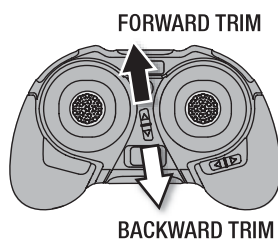
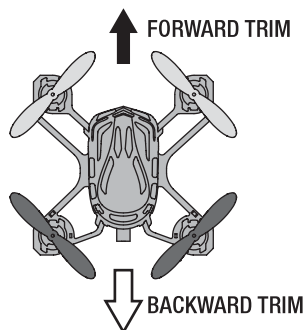
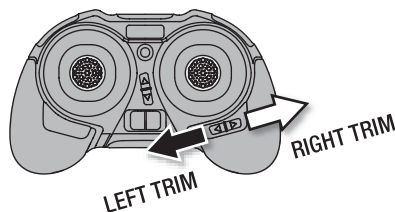
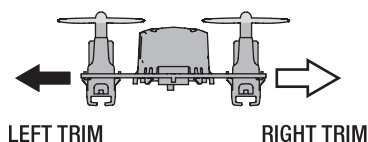

## REPLACEMENT BLADES

FRONT  
Gray Blades, Blue LEDs

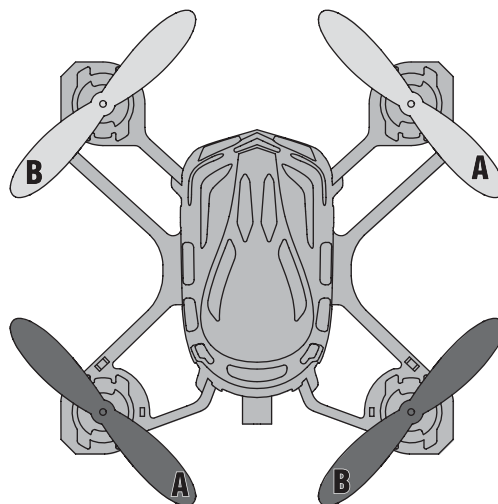

REAR  
Black Blades, Red LEDs

## LANDING SAFELY

When the battery voltage begins to run low, the LEDs will begin to flash. It is time to land before the built in low voltage cut off reduces power to the motors.

## TROUBLESHOOTING

**PROBLEM:** Controller cannot be linked to the ProtoX.

**SOLUTION:** Throttle position needs to be at zero.

**PROBLEM:** Controller LED flashing after binding.

**SOLUTION:** Replace batteries.

**PROBLEM:** Proto X shaking.

**SOLUTION:** Check if the canopy, chassis and rotors are damaged.

**PROBLEM:** Will not take off.

**SOLUTION:** Check that the rotor blades are properly installed.

## LINK THE TRANSMITTER

Hold the throttle stick at full down and turn on the controller. Wait until the red LED turns green.

