

FCC TEST REPORT

FOR

Estes-Cox Corporation d/b/a Estes Industries and Cox

Proto X /Syncro

Model No.: ESTE4606

Additional Model No.: ESTES 4609

Prepared for : Estes-Cox Corporation d/b/a Estes Industries and Cox
Address : 1295 H Street, Penrose, Colorado 81240 United States

Prepared by : Shenzhen LCS Compliance Testing Laboratory Ltd
Address : 1/F., Xingyuan Industrial Park, Tongda Road, Bao'an Avenue,
Bao'an District, Shenzhen, Guangdong, China

Date of receipt of test sample : September 16, 2013
Number of tested samples : 1
Serial number : Prototype
Date of Test : September 16, 2013 - December 12, 2013
Date of Report : December 12, 2013

FCC TEST REPORT
FCC CFR 47 PART 15 C(15.249): 2012

Report Reference No. : **LCS131212380TF**

Date of Issue : December 12, 2013

Testing Laboratory Name..... : **Shenzhen LCS Compliance Testing Laboratory Ltd.**

Address..... : 1/F., Xingyuan Industrial Park, Tongda Road, Bao'an Avenue,
 Bao'an District, Shenzhen, Guangdong, China

Testing Location/ Procedure..... : Full application of Harmonised standards
 Partial application of Harmonised standards
 Other standard testing method

Applicant's Name : **Estes-Cox Corporation d/b/a Estes Industries and Cox**

Address..... : 1295 H Street, Penrose, Colorado 81240 United States

Test Specification

Standard..... : FCC CFR 47 PART 15 C(15.249): 2012 / RSS-210 Issue 8 /
 RSS-Gen Issue 3

Test Report Form No...... : LCSEMC-1.0

TRF Originator..... : Shenzhen LCS Compliance Testing Laboratory Ltd.

Master TRF : Dated 2011-03

Shenzhen LCS Compliance Testing Laboratory Ltd. All rights reserved.

This publication may be reproduced in whole or in part for non-commercial purposes as long as the Shenzhen LCS Compliance Testing Laboratory Ltd. is acknowledged as copyright owner and source of the material. Shenzhen LCS Compliance Testing Laboratory Ltd. takes no responsibility for and will not assume liability for damages resulting from the reader's interpretation of the reproduced material due to its placement and context.

Test Item Description..... : **Proto X /Syncro**

Trade Mark : N/A

Model/ Type reference..... : ESTE4606, ESTES 4609

Ratings..... : DC 3.0V by 2*AAA batteries

Result : **Positive**

Compiled by:

Leo Lee

Supervised by:

Fox Zhang

Approved by:

Gavin Liang

Leo Lee/ File administrators

Fox Zhang/ Technique principal

Gavin Liang/ Manager

FCC -- TEST REPORT

Test Report No. : LCS131212380TF	<u>December 12, 2013</u> Date of issue
---	---

Type / Model..... : ESTE4606, ESTES 4609 EUT..... : Proto X /Syncro
Applicant..... : Estes-Cox Corporation d/b/a Estes Industries and Cox Address..... : 1295 H Street, Penrose, Colorado 81240 United States Telephone..... : / Fax..... : /
Manufacturer..... : Shenzhen Hubsan Technology Co., Ltd. Address..... : Rm407, Municipal Service Building, Hong Li Road west, Futian District, Shenzhen, China Telephone..... : / Fax..... : /
Factory..... : Shenzhen Hubsan Technology Co., Ltd. Address..... : Rm407, Municipal Service Building, Hong Li Road west, Futian District, Shenzhen, China Telephone..... : / Fax..... : /

Test Result	Positive
--------------------	-----------------

The test report merely corresponds to the test sample.
 It is not permitted to copy extracts of these test result without the written permission of the test laboratory.

TABLE OF CONTENTS

1. GENERAL INFORMATION	5
1.1. Description of Device (EUT)	5
1.2. Host System Configuration List and Details	5
1.3. External I/O	5
1.4. Description of Test Facility	6
1.5. Statement of the measurement uncertainty	6
1.6. Measurement Uncertainty	6
1.7. Description Of Test Modes	7
2. TEST METHODOLOGY	8
2.1. EUT Configuration	8
2.2. EUT Exercise	8
2.3. General Test Procedures	8
3. CONNECTION DIAGRAM OF TEST SYSTEM.....	9
3.1. Justification	9
3.2. EUT Exercise Software	9
3.3. Special Accessories	9
3.4. Block Diagram/Schematics	9
3.5. Equipment Modifications	9
3.6. Test Setup	9
4. SUMMARY OF TEST RESULTS	10
5. ANTENNA REQUIREMENT	11
5.1. Standard Applicable	11
5.2. Antenna Connected Construction	11
6. RADIATED EMISSION MEASUREMENT	12
6.1. Standard Applicable	12
6.2. Measuring Instruments and Setting	12
6.3. Test Procedure	13
6.4. Test Equipment List and Details	14
6.5. Block Diagram of Test Setup	14
6.6. Test Results	15
7. BAND EDGES MEASUREMENT.....	23
7.1. Standard Applicable	23
7.2. Test Equipment List and Details	23
7.3. Block Diagram of Test Setup	23
7.4. Test Procedure	23
7.5. Test Results	24
8. 20 DB BANDWIDTH MEASUREMENT	26
8.1. Standard Applicable	26
8.2. Test Equipment List and Details	26
8.3. Block Diagram of Test Setup	26
8.4. Test Procedure	26
8.5. Test Results	27
9. MANUFACTURER/ APPROVAL HOLDER DECLARATION	29

1. GENERAL INFORMATION

1.1. Description of Device (EUT)

EUT : Proto X /Syncro

Model Number : ESTE4606,ESTES 4609

Power Supply : DC 3.0V by 2*AAA batteries

Frequency Range : 2410.00-2465.00MHz, (Channel Number: 12, Channel
Frequency=2410+5*(K-1), K=1, 2, 312)

Modulation Technology : GFSK

Channel Number : 12

Channel Spacing : 5MHz

Antenna Type and Gain : PCB Antenna, 1.8dBi(Max.)

1.2. Host System Configuration List and Details

Manufacturer	Description	Model	Serial Number	Certificate
--	--	--	--	--

1.3. External I/O

I/O Port Description	Quantity	Cable
--	--	--

1.4. Description of Test Facility

Site Description

EMC Lab. : Accredited by CNAS, June 04, 2010
 The Certificate Registration Number. is L4595.
 Accredited by FCC, July 14, 2011
 The Certificate Registration Number. is 899208.
 Accredited by Industry Canada, May. 02, 2011
 The Certificate Registration Number. is 9642A-1

1.5. Statement of the measurement uncertainty

The data and results referenced in this document are true and accurate. The reader is cautioned that there may be errors within the calibration limits of the equipment and facilities. The measurement uncertainty was calculated for all measurements listed in this test report acc. To CISPR 16 – 4 “Specification for radio disturbance and immunity measuring apparatus and methods – Part 4: Uncertainty in EMC Measurements” and is documented in the LCS quality system acc. To DIN EN ISO/IEC 17025. Furthermore, component and process variability of devices similar to that tested may result in additional deviation. The manufacturer has the sole responsibility of continued compliance of the device.

1.6. Measurement Uncertainty

Test Item	Frequency Range	Uncertainty	Note
Radiation Uncertainty	9KHz~30MHz	$\pm 3.10\text{dB}$	(1)
	30MHz~200MHz	$\pm 2.96\text{dB}$	(1)
	200MHz~1000MHz	$\pm 3.10\text{dB}$	(1)
	1GHz~26.5GHz	$\pm 4.00\text{dB}$	(1)
Conduction Uncertainty	150kHz~30MHz	$\pm 1.63\text{dB}$	(1)
Power disturbance	30MHz~300MHz	$\pm 1.60\text{dB}$	(1)

(1). This uncertainty represents an expanded uncertainty expressed at approximately the 95% confidence level using a coverage factor of $k=2$.

1.7. Description Of Test Modes

The EUT operates in the unlicensed ISM band at 2.4GHz. The following operating modes were applied for the related test items. And the new battery is used during the measurement.

The EUT received DC 3.0V power from 2*AAA batteries which are new and full power.

All test modes were tested, only the result of the worst case was recorded in the report.

The EUT is considered a portable unit; it was pre-tested on the positioned of each 3 axis. The worst case was found positioned on X-plane. Therefore only the test data of this X-plane was used for radiated emission measurement test.

Mode of Operations	Transmitting Frequency (MHz)
GFSK	2410
	2435
	2465
For Conducted Emission	
Test Mode	N/A
For Radiated Emission	
Test Mode	TX Mode

Note: The EUT is designed to use DC 3.0V 2*AAA batteries for power supply, so the conducted emission testing is not applicable.

2. TEST METHODOLOGY

All measurements contained in this report were conducted with ANSI C63.4-2003, American National Standard for Methods of Measurement of Radio-Noise Emissions from Low-Voltage Electrical and Electronic Equipment in the range of 9 kHz to 40 GHz.

The radiated testing was performed at an antenna-to-EUT distance of 3 meters. All radiated and conducted emissions measurement was performed at Shenzhen LCS Compliance Testing Laboratory Ltd..

2.1. EUT Configuration

The EUT configuration for testing is installed on RF field strength measurement to meet the Commissions requirement and operating in a manner that intends to maximize its emission characteristics in a continuous normal application.

2.2. EUT Exercise

The EUT was operated in the engineering mode to fix the TX frequency that was for the purpose of the measurements.

According to its specifications, the EUT must comply with the requirements of the Section 15.203, 15.205, 15.207, 15.209 and 15.249 under the FCC Rules Part 15 Subpart C and RSS-210.

2.3. General Test Procedures

2.3.1 Conducted Emissions(N/A)

The EUT is placed on the turntable, which is 0.8 m above ground plane. According to the requirements in Section 13.1.4.1 of ANSI C63.4 Conducted emissions from the EUT measured in the frequency range between 0.15 MHz and 30MHz using Quasi-peak and average detector modes.

2.3.2 Radiated Emissions

The EUT is placed on a turn table, which is 0.8 m above ground plane. The turntable shall rotate 360 degrees to determine the position of maximum emission level. EUT is set 3m away from the receiving antenna, which varied from 1m to 4m to find out the highest emission. And also, each emission was to be maximized by changing the polarization of receiving antenna both horizontal and vertical. In order to find out the maximum emissions, exploratory radiated emission measurements were made according to the requirements in Section 13.1.4.1 of ANSI C63.4

3. CONNECTION DIAGRAM OF TEST SYSTEM

3.1. Justification

The system was configured for testing in a continuous transmit condition.

3.2. EUT Exercise Software

N/A

3.3. Special Accessories

N/A

3.4. Block Diagram/Schematics

Please refer to the related document

3.5. Equipment Modifications

Shenzhen LCS Compliance Testing Laboratory Ltd. has not done any modification on the EUT.

3.6. Test Setup

Please refer to the test setup photo.

4. SUMMARY OF TEST RESULTS

FCC Rules	IC Rules	Description Of Test	Result
§15.203	RSS-Gen	Antenna Requirement	Compliant
§15.207(a)	RSS-Gen	Conduction Emissions	N/A
§15.205(a), §15.209(a), §15.249(a), §15.249(c)	RSS-210 (A2.9&A8.4)	Radiated Emissions Measurement	Compliant
§15.249	RSS-210(A8.5)	Band Edges Measurement	Compliant
§15.249, §15.215	RSS-210	20 dB Bandwidth	Compliant

5. ANTENNA REQUIREMENT

5.1. Standard Applicable

According to §15.203 & RSS-Gen, Antenna requirement.

An intentional radiator shall be designed to ensure that no antenna other than that furnished by the responsible party shall be used with the device. The use of a permanently attached antenna or of an antenna that uses a unique coupling to the intentional radiator shall be considered sufficient to comply with the provisions of this Section. The manufacturer may design the unit so that a broken antenna can be re-placed by the user, but the use of a standard antenna jack or electrical connector is prohibited. This requirement does not apply to carrier current devices or to devices operated under the provisions of Sections 15.211, 15.213, 15.217, 15.219, or 15.221. Further, this requirement does not apply to intentional radiators that must be professionally installed, such as perimeter protection systems and some field disturbance sensors, or to other intentional radiators which, in accordance with Section 15.31(d), must be measured at the installation site. However, the installer shall be responsible for ensuring that the proper antenna is employed so that the limits in this Part are not exceeded.

5.2. Antenna Connected Construction

The directional gains of antenna used for transmitting is 1.8dBi(Max.), and EUT is equipped with an onboard PCB antenna and no consideration of replacement. Please see EUT photo for details.

Result: Compliance.

6. RADIATED EMISSION MEASUREMENT

6.1. Standard Applicable

1. Emissions radiated outside of the specified frequency bands, except for harmonics, shall be attenuated by at least 50 dB below the level of the fundamental or to the general radiated emission limits in §15.209, whichever is the lesser attenuation.
2. 20dBc in any 100 kHz bandwidth outside the operating frequency band. In case the emission fall within the restricted band specified on 15.205(a), then the 15.209(a) and 15.249 limit in the table below has to be followed.

Fundamental Frequency	Field Strength of fundamental (millivolts/meter)	Field Strength of harmonics (microvolts/meter)
902-928MHz	50	500
2400-2483.5MHz	50	500
5725-5875MHz	50	500
24.0-24.25GHz	250	2500

Frequencies (MHz)	Field Strength (microvolts/meter)	Measurement Distance (meters)
0.009~0.490	2400/F(KHz)	300
0.490~1.705	24000/F(KHz)	30
1.705~30.0	30	30
30~88	100	3
88~216	150	3
216~960	200	3
Above 960	500	3

6.2. Measuring Instruments and Setting

Please refer to section 5 of equipments list in this report. The following table is the setting of spectrum analyzer and receiver.

Spectrum Parameter	Setting
Attenuation	Auto
Start ~ Stop Frequency	9kHz~150kHz / RB 200Hz for QP
Start ~ Stop Frequency	150kHz~30MHz / RB 9kHz for QP
Start ~ Stop Frequency	30MHz~1000MHz / RB 120kHz for QP

Spectrum Parameter	Setting
Attenuation	Auto
Start Frequency	1000 MHz
Stop Frequency	10th carrier harmonic
RB / VB (Emission in restricted band)	1MHz / 1MHz for Peak, 1 MHz / 10Hz for Average
RB / VB (Emission in non-restricted band)	1000KHz / 1000KHz for peak

6.3. Test Procedure

1. Configure the EUT according to ANSI C63.4. The EUT was placed on the top of the turntable 0.8 meter above ground. The phase center of the receiving antenna mounted on the top of a height-variable antenna tower was placed 3 meters far away from the turntable.
2. Power on the EUT and all the supporting units. The turntable was rotated by 360 degrees to determine the position of the highest radiation.
3. The height of the broadband receiving antenna was varied between one meter and four meters above ground to find the maximum emissions field strength of both horizontal and vertical polarization.
4. For each suspected emissions, the antenna tower was scan (from 1 m to 4 m) and then the turntable was rotated (from 0 degree to 360 degrees) to find the maximum reading.
5. Set the test-receiver system to Peak or CISPR quasi-peak Detect Function with specified bandwidth under Maximum Hold Mode.
6. For emissions above 1GHz, use 1MHz VBW and RBW for peak reading. Then 1MHz RBW and 10Hz VBW for average reading in spectrum analyzer.
7. When the radiated emissions limits are expressed in terms of the average value of the emissions, and pulsed operation is employed, the measurement field strength shall be determined by averaging over one complete pulse train, including blanking intervals, as long as the pulse train does not exceed 0.1 seconds. As an alternative (provided the transmitter operates for longer than 0.1 seconds) or in cases where the pulse train exceeds 0.1 seconds, the measured field strength shall be determined from the average absolute voltage during a 0.1 second interval during which the field strength is at its maximum value.
8. If the emissions level of the EUT in peak mode was 3 dB lower than the average limit specified, then testing will be stopped and peak values of EUT will be reported, otherwise, the emissions which do not have 3 dB margin will be repeated one by one using the quasi-peak method for below 1GHz.
9. For testing above 1GHz, the emissions level of the EUT in peak mode was lower than average limit (that means the emissions level in peak mode also complies with the limit in average mode), then testing will be stopped and peak values of EUT will be reported, otherwise, the emissions will be measured in average mode again and reported.

6.4. Test Equipment List and Details

Equipment	Manufacturer	Model No.	Serial No.	Last Cal.	Next Cal.
Spectrum Analyzer	Agilent	E4407B	MY41440754	2013-07-16	2014-07-15
Test Receiver	Rohde & Schwarz	ESCI	101142	2013-06-18	2014-06-17
Loop antenna	EMCO	6502	0042963	2013-06-18	2014-06-17
Log per Antenna	Schwarzbeck	VULB9163	9163-470	2013-06-10	2014-06-09
Horn-antenna	ETS.LINDGREN	3115	00034771	2013-06-10	2014-06-09
Horn Antenna	SCHWARZBECK	BBHA9170	BBHA9170154	2013-06-10	2014-06-09

6.5. Block Diagram of Test Setup

For radiated emissions below 30MHz

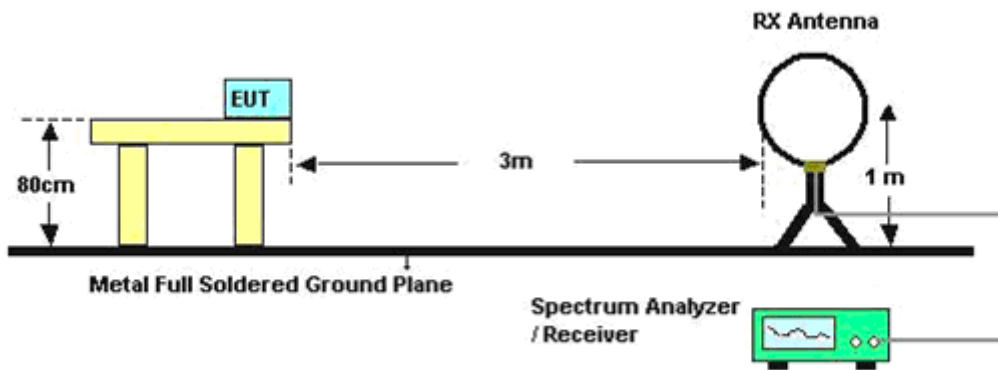

For radiated emissions above 30MHz

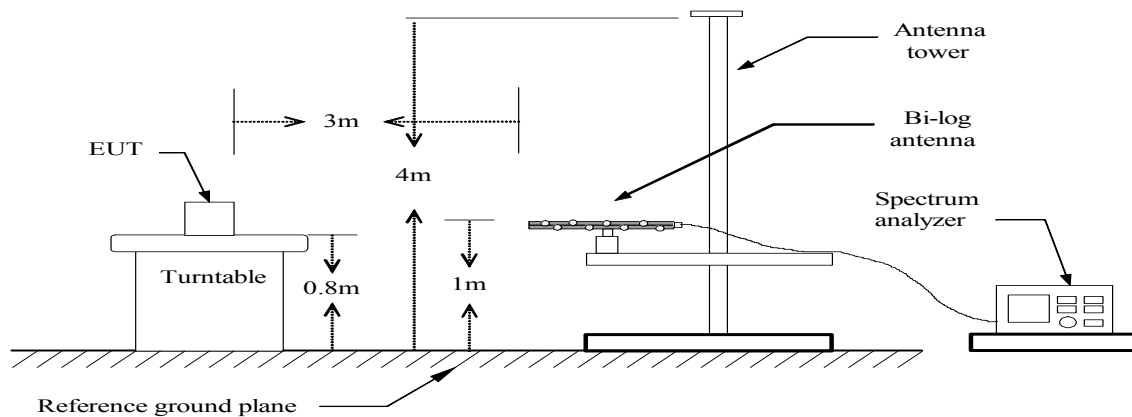

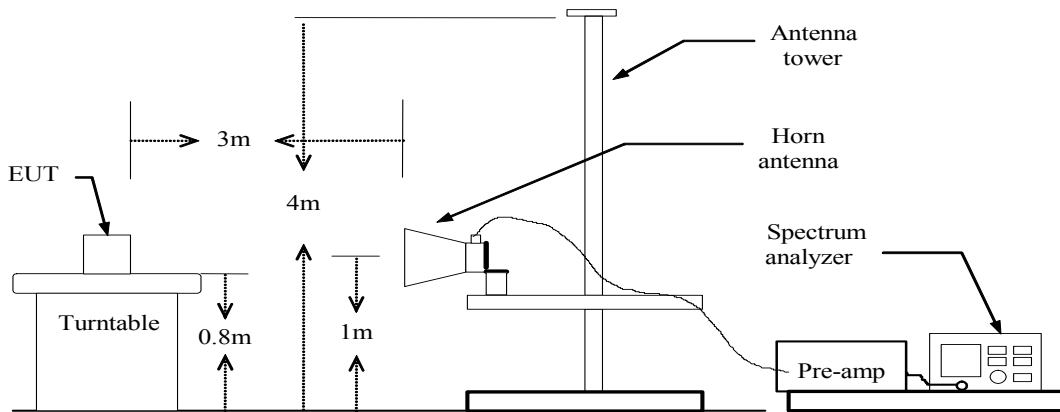

Above 10 GHz shall be extrapolated to the specified distance using an extrapolation factor of 20 dB/decade form 3m to 1.5m.

Distance extrapolation factor = $20 \log (\text{specific distanc [3m]} / \text{test distance [1.5m]})$ (dB);

Limit line = specific limits (dBuV) + distance extrapolation factor [6 dB].

6.6. Test Results

Results of Radiated Emissions (9kHz~30MHz)

Frequency (MHz)	Level (dBuV)	Over Limit (dB)	Over Limit (dBuV)	Remark
				See Note

Note:

The amplitude of spurious emissions which are attenuated by more than 20 dB below the permissible value has no need to be reported.

Distance extrapolation factor = $40 \log (\text{specific distance} / \text{test distance})$ (dB);

Limit line = specific limits (dBuV) + distance extrapolation factor.

Results of Radiated Emissions (30MHz~1000MHz)

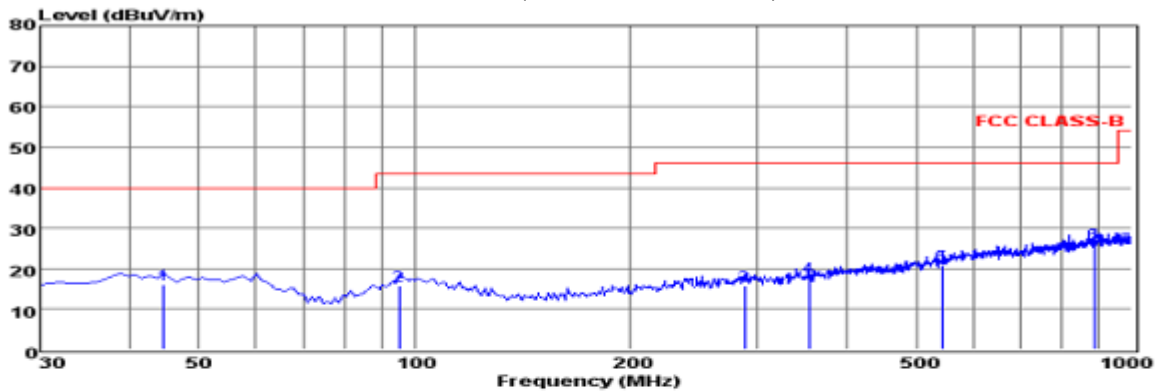

Env./Ins: 24°C/56%
 EUT: Proto X
 M/N: ESTE4606
 Power Rating: DC 3V
 Test Mode: Tx-2410
 Operator: ANDY
 Memo:
 pol: VERTICAL

	Freq MHz	Reading dBuV	CabLos dB	Antfac dB/m	Measured dBuV/m	Linit dBuV/m	Over dB	Remark
1	44.55	2.22	0.41	13.55	16.18	40.00	-23.82	QP
2	94.99	2.40	0.58	12.84	15.82	43.50	-27.68	QP
3	288.02	1.97	1.05	12.83	15.85	46.00	-30.15	QP
4	354.95	2.32	1.15	14.35	17.82	46.00	-28.18	QP
5	544.10	2.12	1.44	17.40	20.96	46.00	-25.04	QP
6	887.48	3.42	1.92	20.96	26.30	46.00	-19.70	QP

Note: 1. All readings are Quasi-peak values.
 2. Measured= Reading + Antenna Factor + Cable Loss
 3. The emission that are 20db below the official limit are not reported

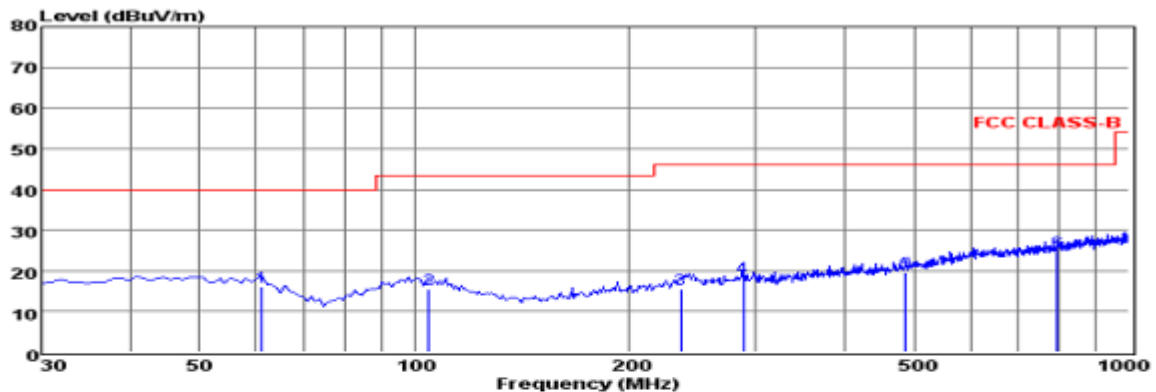

Env./Ins: 24°C/56%
 EUT: Proto X
 M/N: ESTE4606
 Power Rating: DC 3V
 Test Mode: Tx-2410
 Operator: ANDY
 Memo:
 pol: HORIZONTAL

	Freq MHz	Reading dBuV	CabLos dB	Antfac dB/m	Measured dBuV/m	Linit dBuV/m	Over dB	Remark
1	61.04	3.29	0.49	12.28	16.06	40.00	-23.94	QP
2	104.69	2.25	0.61	12.73	15.59	43.50	-27.91	QP
3	235.64	2.69	0.87	11.90	15.46	46.00	-30.54	QP
4	288.02	4.56	1.05	12.83	18.44	46.00	-27.56	QP
5	486.87	2.05	1.37	16.25	19.67	46.00	-26.33	QP
6	793.39	2.93	1.73	19.98	24.64	46.00	-21.36	QP

Note: 1. All readings are Quasi-peak values.
 2. Measured= Reading + Antenna Factor + Cable Loss
 3. The emission that are 20db below the official limit are not reported

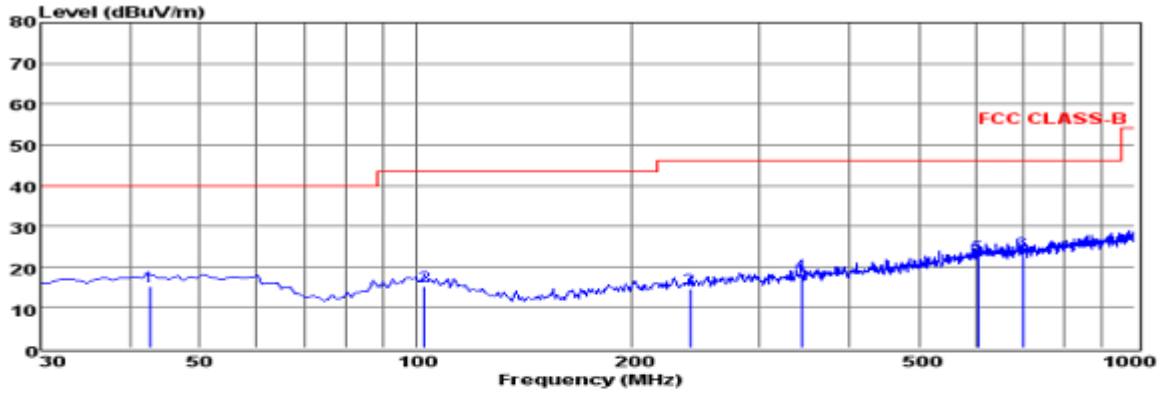

Env./Ins: 24°C/56%
 EUT: Proto X
 M/N: ESTE4606
 Power Rating: DC 3V
 Test Mode: Tx-2435
 Operator: ANDY
 Memo:
 pol: VERTICAL

	Freq	Reading	CabLos	Antfac	Measured	Limit	Over	Remark
	MHz	dBuV	dB	dB/m	dBuV/m	dBuV/m	dB	
1	42.61	1.03	0.50	13.56	15.09	40.00	-24.91	QP
2	102.75	1.59	0.60	12.91	15.10	43.50	-28.40	QP
3	240.49	1.33	1.01	12.09	14.43	46.00	-31.57	QP
4	343.31	3.00	1.12	14.17	18.29	46.00	-27.71	QP
5	604.24	2.64	1.55	18.47	22.66	46.00	-23.34	QP
6	699.30	3.17	1.59	18.81	23.57	46.00	-22.43	QP

Note: 1. All readings are Quasi-peak values.
 2. Measured= Reading + Antenna Factor + Cable Loss
 3. The emission that are 20db below the official limit are not reported

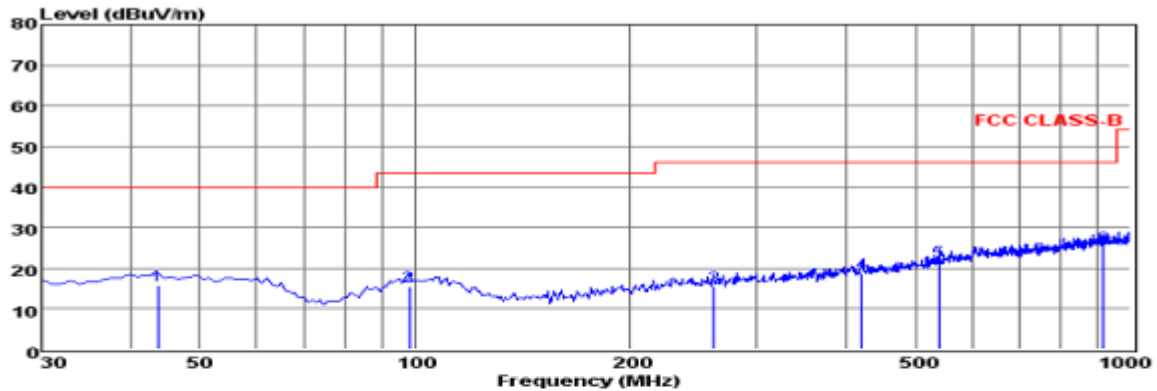

Env./Ins: 24°C/56%
 EUT: Proto X
 M/N: ESTE4606
 Power Rating: DC 3V
 Test Mode: Tx-2435
 Operator: ANDY
 Memo:
 pol: HORIZONTAL

	Freq	Reading	CabLos	Antfac	Measured	Limit	Over	Remark
	MHz	dBuV	dB	dB/m	dBuV/m	dBuV/m	dB	
1	43.58	1.75	0.41	13.56	15.72	40.00	-24.28	QP
2	97.90	1.97	0.61	13.03	15.61	43.50	-27.89	QP
3	261.83	2.47	0.96	12.11	15.54	46.00	-30.46	QP
4	420.91	1.89	1.33	15.47	18.69	46.00	-27.31	QP
5	539.25	3.00	1.45	17.31	21.76	46.00	-24.24	QP
6	917.55	2.28	1.85	21.20	25.33	46.00	-20.67	QP

Note: 1. All readings are Quasi-peak values.
 2. Measured= Reading + Antenna Factor + Cable Loss
 3. The emission that are 20db below the official limit are not reported

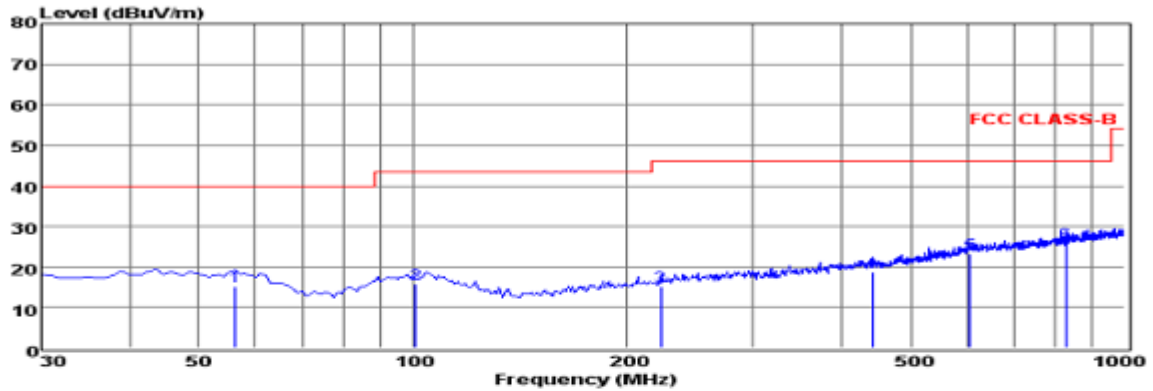

Env./Ins: 24°C/56%
 EUT: Proto X
 M/N: ESTE4606
 Power Rating: DC 3V
 Test Mode: Tx-2465
 Operator: ANDY
 Memo:
 pol: VERTICAL

	Freq	Reading	CabLos	Antfac	Measured	Limit	Over	Remark
	MHz	dBuV	dB	dB/m	dBuV/m	dBuV/m	dB	
1	56.19	1.83	0.47	12.94	15.24	40.00	-24.76	QP
2	100.81	2.06	0.60	13.09	15.75	43.50	-27.75	QP
3	223.03	2.96	0.95	11.33	15.24	46.00	-30.76	QP
4	441.28	1.96	1.27	15.56	18.79	46.00	-27.21	QP
5	606.18	3.09	1.57	18.47	23.13	46.00	-22.87	QP
6	827.34	3.83	1.80	20.34	25.97	46.00	-20.03	QP

Note: 1. All readings are Quasi-peak values.
 2. Measured= Reading + Antenna Factor + Cable Loss
 3. The emission that are 20db below the official limit are not reported

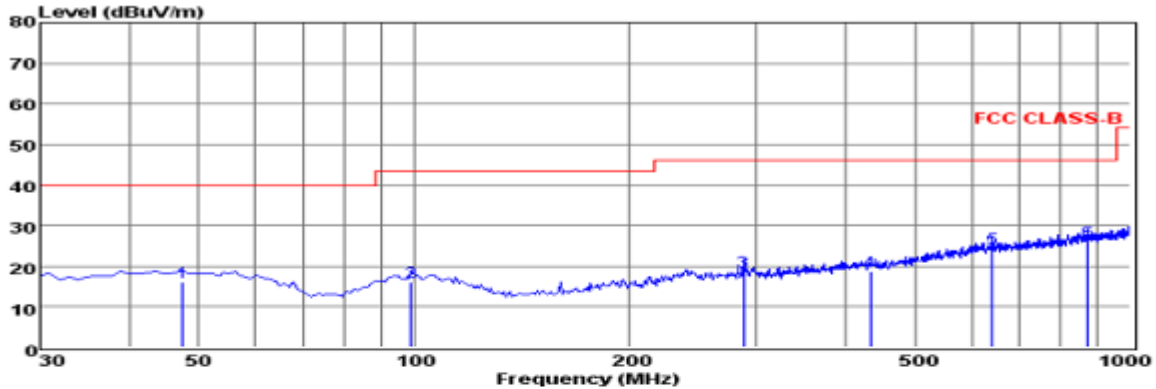

Env./Ins: 24°C/56%
 EUT: Proto X
 M/N: ESTE4606
 Power Rating: DC 3V
 Test Mode: Tx-2465
 Operator: ANDY
 Memo:
 pol: HORIZONTAL

	Freq	Reading	CabLos	Antfac	Measured	Limit	Over	Remark
	MHz	dBuV	dB	dB/m	dBuV/m	dBuV/m	dB	
1	47.46	2.22	0.35	13.40	15.97	40.00	-24.03	QP
2	98.87	2.29	0.61	13.09	15.99	43.50	-27.51	QP
3	288.02	4.85	1.05	12.83	18.73	46.00	-27.27	QP
4	433.52	2.12	1.18	15.53	18.83	46.00	-27.17	QP
5	642.07	4.20	1.55	18.60	24.35	46.00	-21.65	QP
6	872.93	3.62	1.84	20.81	26.27	46.00	-19.73	QP

Note: 1. All readings are Quasi-peak values.
 2. Measured= Reading + Antenna Factor + Cable Loss
 3. The emission that are 20db below the official limit are not reported

Results for Radiated Emissions (Above 1GHz)

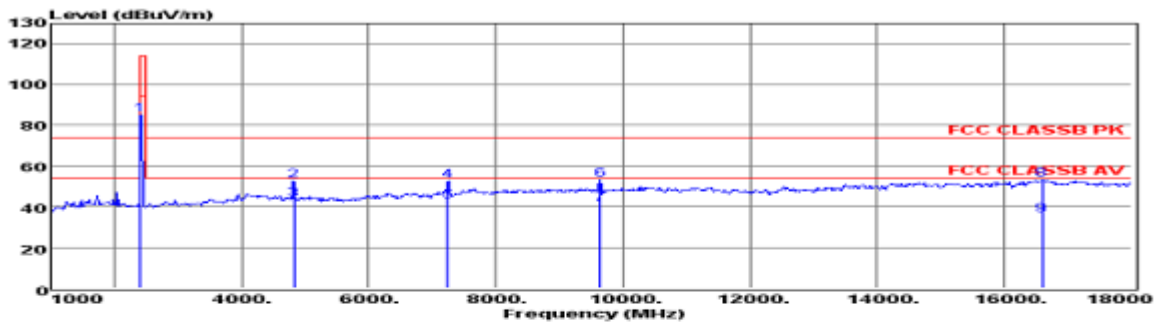

Env. /Ins: 24°C/56%
 EUT: Proto X
 M/N: ESTE4606
 Power Rating: DC 3V
 Test Mode: TX-2410
 Operator: ANDY
 Memo:
 pol: VERTICAL

	Freq	Reading	CabLos	AntFac	PreFac	Measured	Limit	Over	Remark
	MHz	dBuV	dB	dB/m	dB	dBuV/m	dBuV/m	dB	
1	2410.00	89.38	5.07	27.87	37.10	85.22	114.00	-28.78	Peak
2	4820.00	47.97	7.69	33.35	36.43	52.58	74.00	-21.42	Peak
3	4823.00	38.89	7.69	33.36	36.43	43.51	54.00	-10.49	Average
4	7240.00	41.51	9.33	36.89	35.22	52.51	74.00	-21.49	Peak
5	7241.00	31.53	9.33	36.89	35.21	42.54	54.00	-11.46	Average
6	9640.00	40.21	9.99	38.03	35.28	52.95	74.00	-21.05	Peak
7	9641.00	28.31	9.99	38.03	35.28	41.05	54.00	-12.95	Average
8	16589.00	38.13	10.88	39.25	34.95	53.31	74.00	-20.69	Peak
9	16589.60	20.56	10.88	39.25	34.95	35.74	54.00	-18.26	Average

Note: 1. All readings are Quasi-peak values.
 2. Measured = Reading + Antenna Factor + Cable Loss - Amp Factor.
 3. The emission levels that are 20dB below the official limit are not reported.

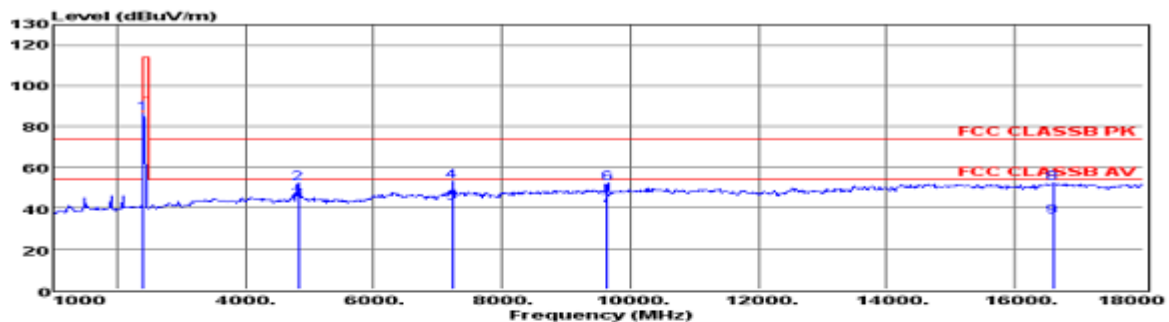

Env. /Ins: 24°C/56%
 EUT: Proto X
 M/N: ESTE4606
 Power Rating: DC 3V
 Test Mode: TX-2410
 Operator: ANDY
 Memo:
 pol: HORIZONTAL

	Freq	Reading	CabLos	AntFac	PreFac	Measured	Limit	Over	Remark
	MHz	dBuV	dB	dB/m	dB	dBuV/m	dBuV/m	dB	
1	2410.00	90.45	5.07	27.87	37.10	86.29	114.00	-27.71	Peak
2	4820.00	47.64	7.69	33.35	36.43	52.25	74.00	-21.75	Peak
3	4821.00	39.34	7.69	33.35	36.43	43.95	54.00	-10.05	Average
4	7230.00	41.98	9.33	36.88	35.23	52.96	74.00	-21.04	Peak
5	7233.00	31.51	9.33	36.89	35.23	42.50	54.00	-11.50	Average
6	9640.00	39.42	9.99	38.03	35.28	52.16	74.00	-21.84	Peak
7	9642.00	28.57	9.99	38.03	35.28	41.31	54.00	-12.69	Average
8	16589.00	37.13	10.88	39.25	34.95	52.31	74.00	-21.69	Peak
9	16590.00	20.47	10.88	39.25	34.95	35.65	54.00	-18.35	Average

Note: 1. All readings are Quasi-peak values.
 2. Measured = Reading + Antenna Factor + Cable Loss - Amp Factor.
 3. The emission levels that are 20dB below the official limit are not reported.

Field Strength Of Fundamental

Frequency (MHz)	Pol.	Measure Result (PK, dBuV/m)	Measure Result (AVG, dBuV/m)	Peak Limit (dBuV/m)	AVG Limit (dBuV/m)	Result
2410	H	86.29	81.61	114	94	Pass
2410	V	85.22	80.43	114	94	Pass

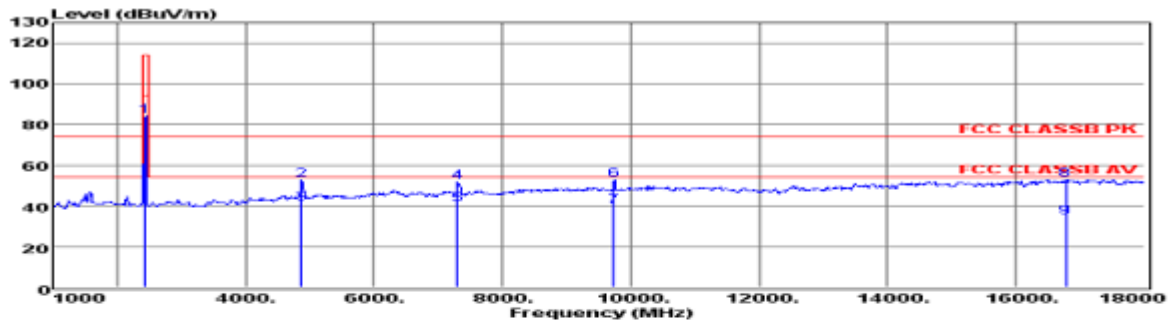

Env. /Ins: 24°C / 56%
 EUT: Proto X
 M/N: ESTE4606
 Power Rating: DC 3V
 Test Mode: TX-2435
 Operator: ANDY
 Memo:
 pol: VERTICAL

	Freq	Reading	Cables	AntFac	PreFac	Measured	Limit	Over	Remark
	MHz	dBuV	dB	dB/m	dB	dBuV/m	dBuV/m	dB	
1	2435.00	88.16	5.11	27.80	37.10	83.97	114.00	-30.03	Peak
2	4870.00	48.13	7.72	33.47	36.42	52.90	74.00	-21.10	Peak
3	4872.00	36.41	7.72	33.48	36.42	41.19	54.00	-12.81	Average
4	7305.00	40.58	9.36	36.92	35.11	51.75	74.00	-22.25	Peak
5	7306.00	29.46	9.36	36.92	35.11	40.63	54.00	-13.37	Average
6	9740.00	39.89	10.02	38.08	35.18	52.81	74.00	-21.19	Peak
7	9741.00	26.53	10.02	38.08	35.18	39.45	54.00	-14.55	Average
8	16776.00	37.21	10.93	39.64	34.93	52.85	74.00	-21.15	Peak
9	16777.00	18.53	10.93	39.64	34.93	34.17	54.00	-19.83	Average

Note: 1. All readings are Quasi-peak values.
 2. Measured = Reading + Antenna Factor + Cable Loss - Amp Factor.
 3. The emission levels that are 20dB below the official limit are not reported.

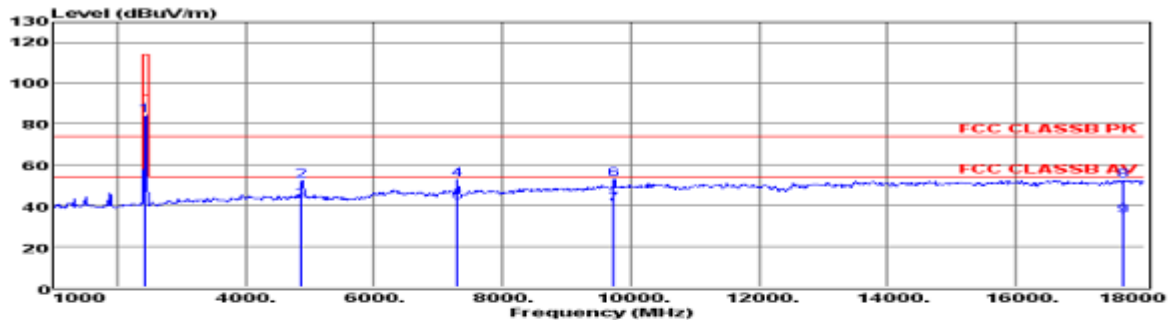

Env. /Ins: 24°C / 56%
 EUT: Proto X
 M/N: ESTE4606
 Power Rating: DC 3V
 Test Mode: TX-2435
 Operator: ANDY
 Memo:
 pol: HORIZONTAL

	Freq	Reading	Cables	AntFac	PreFac	Measured	Limit	Over	Remark
	MHz	dBuV	dB	dB/m	dB	dBuV/m	dBuV/m	dB	
1	2435.00	88.31	5.11	27.80	37.10	84.12	114.00	-29.88	Peak
2	4870.00	47.45	7.72	33.47	36.42	52.22	74.00	-21.78	Peak
3	4871.00	37.58	7.72	33.48	36.42	42.36	54.00	-11.64	Average
4	7305.00	41.61	9.36	36.92	35.11	52.78	74.00	-21.22	Peak
5	7307.00	30.50	9.36	36.92	35.10	41.68	54.00	-12.32	Average
6	9740.00	39.85	10.02	38.08	35.18	52.77	74.00	-21.23	Peak
7	9741.00	27.59	10.02	38.08	35.18	40.51	54.00	-13.49	Average
8	17677.00	35.65	11.20	41.52	36.00	52.37	74.00	-21.63	Peak
9	17678.00	17.87	11.20	41.53	36.00	34.60	54.00	-19.40	Average

Note: 1. All readings are Quasi-peak values.
 2. Measured = Reading + Antenna Factor + Cable Loss - Amp Factor.
 3. The emission levels that are 20dB below the official limit are not reported.

Field Strength Of Fundamental

Frequency (MHz)	Pol.	Measure Result (PK, dBuV/m)	Measure Result (AVG, dBuV/m)	Peak Limit (dBuV/m)	AVG Limit (dBuV/m)	Result
2435	H	84.12	79.86	114	94	Pass
2435	V	83.97	79.19	114	94	Pass

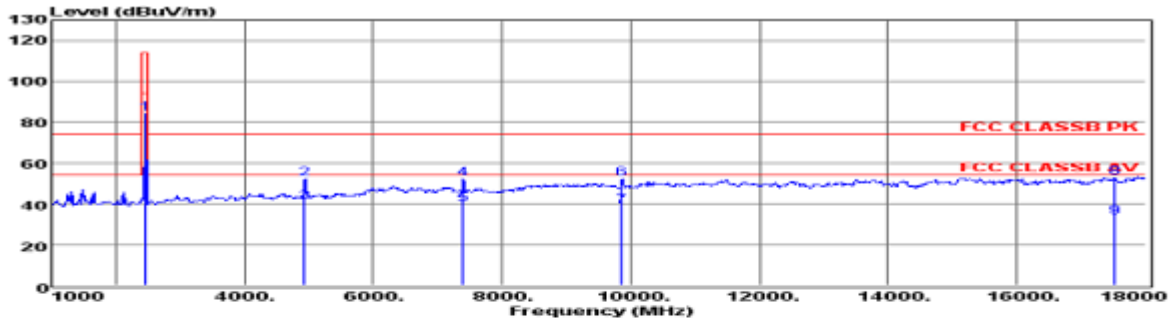

Env. /Ins: 24°C/56%
 EUT: Proto X
 M/N: ESTE4606
 Power Rating: DC 3V
 Test Mode: TX-2465
 Operator: ANDY
 Memo:
 pol: VERTICAL

	Freq	Reading	CabLos	AntFac	PreFac	Measured	Limit	Over	Remark
	MHz	dBuV	dB	dB/m	dB	dBuV/m	dBuV/m	dB	
1	2460.00	88.14	5.14	27.72	37.10	83.90	114.00	-30.10	Peak
2	4930.00	47.22	7.76	33.62	36.41	52.19	74.00	-21.81	Peak
3	4932.00	35.46	7.76	33.63	36.41	40.44	54.00	-13.56	Average
4	7395.00	40.97	9.39	36.96	35.01	52.31	74.00	-21.69	Peak
5	7397.00	28.31	9.39	36.96	35.01	39.65	54.00	-14.35	Average
6	9860.00	38.95	10.06	38.13	35.06	52.08	74.00	-21.92	Peak
7	9861.00	25.39	10.06	38.13	35.06	38.52	54.00	-15.48	Average
8	17524.00	35.94	11.16	41.20	35.81	52.49	74.00	-21.51	Peak
9	17525.00	16.65	11.16	41.21	35.81	33.21	54.00	-20.79	Average

Note: 1. All readings are Quasi-peak values.
 2. Measured = Reading + Antenna Factor + Cable Loss - Amp Factor.
 3. The emission levels that are 20dB below the official limit are not reported.

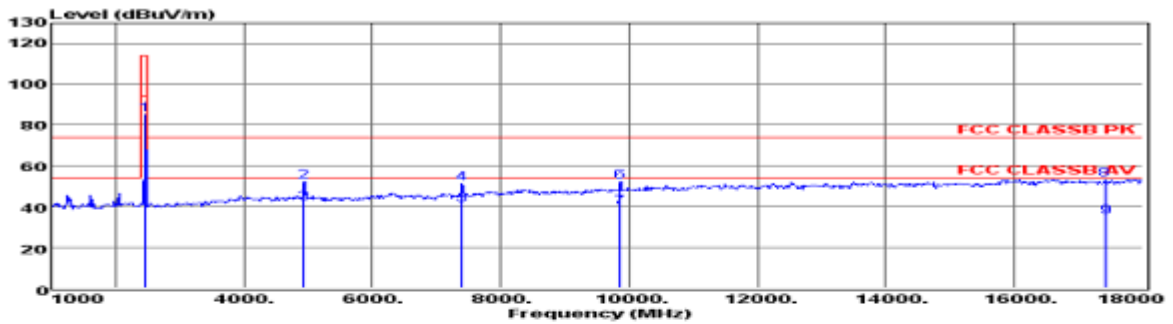

Env. /Ins: 24°C/56%
 EUT: Proto X
 M/N: ESTE4606
 Power Rating: DC 3V
 Test Mode: TX-2465
 Operator: ANDY
 Memo:
 pol: HORIZONTAL

	Freq	Reading	CabLos	AntFac	PreFac	Measured	Limit	Over	Remark
	MHz	dBuV	dB	dB/m	dB	dBuV/m	dBuV/m	dB	
1	2462.00	89.17	5.15	27.71	37.10	84.93	114.00	-29.07	Peak
2	4930.00	47.26	7.76	33.62	36.41	52.23	74.00	-21.77	Peak
3	4932.00	36.37	7.76	33.63	36.41	41.35	54.00	-12.65	Average
4	7395.00	39.91	9.39	36.96	35.01	51.25	74.00	-22.75	Peak
5	7397.00	29.36	9.39	36.96	35.01	40.70	54.00	-13.30	Average
6	9860.00	38.88	10.06	38.13	35.06	52.01	74.00	-21.99	Peak
7	9861.00	26.42	10.06	38.13	35.06	39.55	54.00	-14.45	Average
8	17422.00	36.63	11.13	40.99	35.68	53.07	74.00	-20.93	Peak
9	17423.00	18.25	11.13	40.99	35.68	34.69	54.00	-19.31	Average

Note: 1. All readings are Quasi-peak values.
 2. Measured = Reading + Antenna Factor + Cable Loss - Amp Factor.
 3. The emission levels that are 20dB below the official limit are not reported.

Field Strength Of Fundamental						
Frequency (MHz)	Pol.	Measure Result (PK, dBuV/m)	Measure Result (AVG, dBuV/m)	Peak Limit (dBuV/m)	AVG Limit (dBuV/m)	Result
2465	H	84.93	79.05	114	94	Pass
2465	V	83.90	78.43	114	94	Pass

Notes:

1. *Measuring frequencies from 9k~10th harmonic (ex. 26GHz), No emission found between lowest internal used/generated frequency to 30MHz.*
2. *Radiated emissions measured in frequency range from 9k~10th harmonic (ex. 26GHz) were made with an instrument using Peak detector mode.*
3. *No emission was be recorded above 18GHz means the reading of emissions are attenuated more than 20dB below the permissible limits or the field strength is too small to be measured.*

7. BAND EDGES MEASUREMENT

7.1. Standard Applicable

Emissions radiated outside of the specified frequency bands, except for harmonics, shall be attenuated by at least 50 dB below the level of the fundamental or to the general radiated emission limits in Section 15.209, whichever is the lesser attenuation.

7.2. Test Equipment List and Details

Equipment	Manufacturer	Model No.	Serial No.	Last Cal.	Next Cal.
Spectrum Analyzer	Agilent	E4407B	MY41440754	2013-07-16	2014-07-15
Test Receiver	Rohde & Schwarz	ESCI	101142	2013-06-18	2014-06-17
Test Receiver	Rohde & Schwarz	ESPI	101840	2013-06-18	2014-06-17
Loop antenna	EMCO	6502	0042963	2013-06-18	2014-06-17
Log per Antenna	Schwarzbeck	VULB9163	9163-470	2013-06-10	2014-06-09
Horn-antenna	ETS.LINDGREN	3115	00034771	2013-06-10	2014-06-09
Horn Antenna	SCHWARZBECK	BBHA9170	BBHA917015 4	2013-06-10	2014-06-09

7

3. Block Diagram of Test Setup

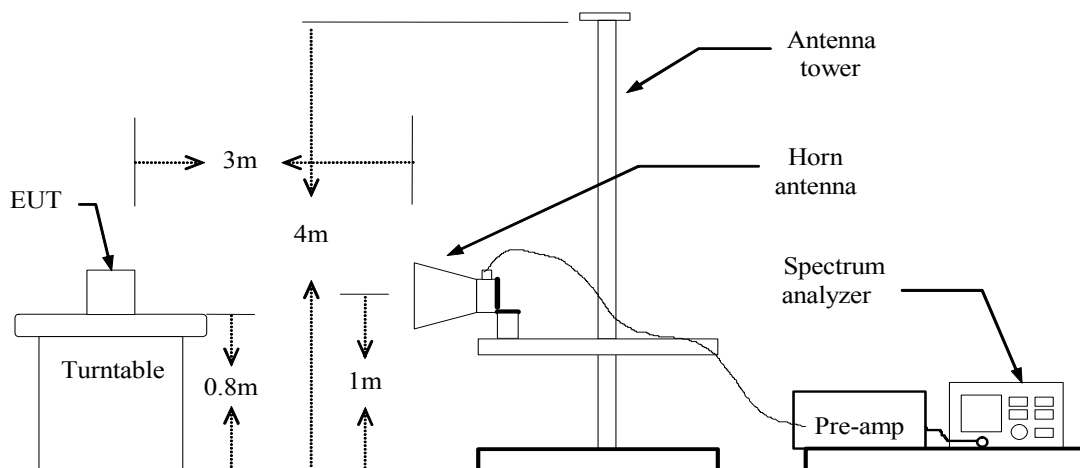

7.4. Test Procedure

The EUT is placed on a turntable, which is 0.8m above the ground plane. The turntable shall be rotated for 360 degrees to determine the position of maximum emission level. EUT is set 3m away from the receiving antenna, which is varied from 1m to 4m to find out the highest emission. Set the spectrum analyzer in the following setting in order to capture the lower and upper band-edges of the emission:

Peak: RBW=VBW=1MHz / Sweep=AUTO

Repeat the procedures until the peak versus polarization are measured.

7.5. Test Results

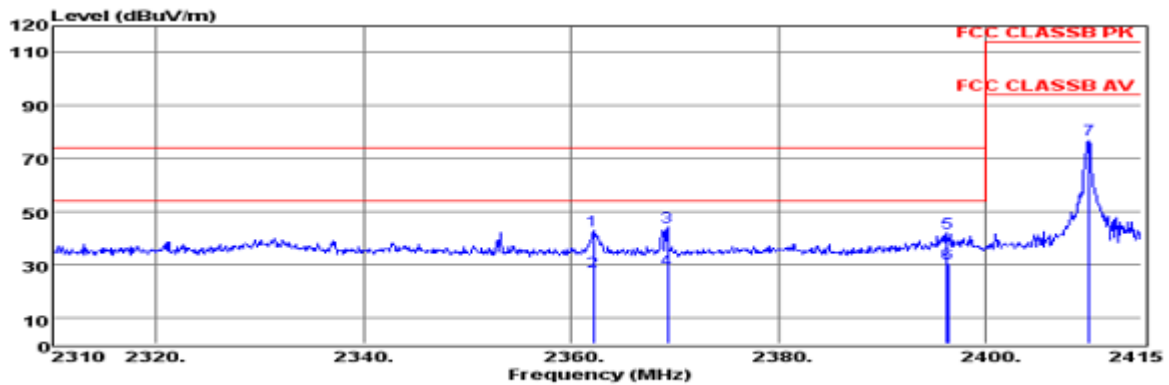

Env. /Ins: 24°C /56%
 EUT: Proto X
 M/N: ESTE4606
 Power Rating: DC 3V
 Test Mode: Tx-2410
 Operator: ANDY
 Memo:
 pol: VERTICAL

	Freq	Reading	CabLos	AntFac	PreFac	Measured	Limit	Over	Remark
	MHz	dBuV	dB	dB/m	dB	dBuV/m	dBuV/m	dB	
1	2362.19	46.95	5.01	28.01	37.09	42.88	74.00	-31.12	Peak
2	2362.19	31.35	5.01	28.01	37.09	27.28	54.00	-26.72	Average
3	2369.33	48.04	5.02	27.99	37.09	43.96	74.00	-30.04	Peak
4	2369.33	32.23	5.02	27.99	37.09	28.15	54.00	-25.85	Average
5	2396.31	46.02	5.05	27.91	37.10	41.88	74.00	-32.12	Peak
6	2396.32	34.40	5.05	27.91	37.10	30.26	54.00	-23.74	Average
7	2410.00	81.38	5.07	27.87	37.10	77.22	114.00	-36.78	Peak

Note: 1. All readings are Quasi-peak values.
 2. Measured = Reading + Antenna Factor + Cable Loss - Amp Factor.
 3. The emission levels that are 20dB below the official limit are not reported.

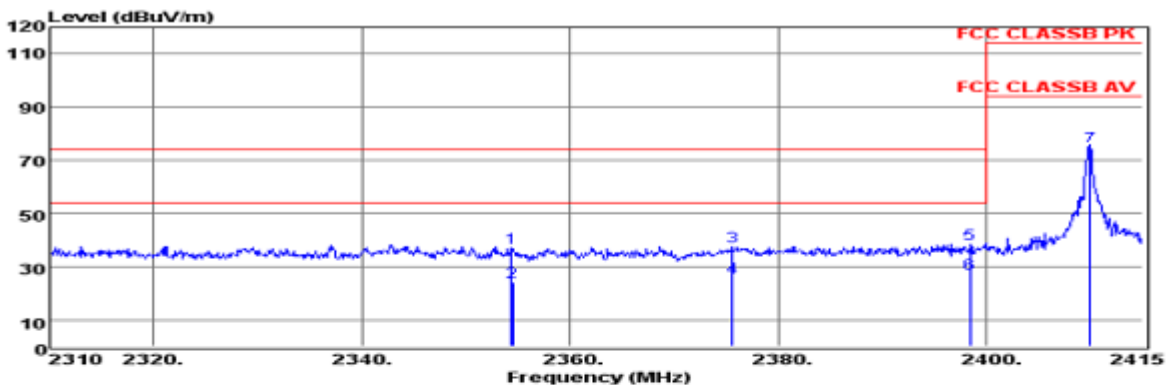

Env. /Ins: 24°C /56%
 EUT: Proto X
 M/N: ESTE4606
 Power Rating: DC 3V
 Test Mode: Tx-2410
 Operator: ANDY
 Memo:
 pol: HORIZONTAL

	Freq	Reading	CabLos	AntFac	PreFac	Measured	Limit	Over	Remark
	MHz	dBuV	dB	dB/m	dB	dBuV/m	dBuV/m	dB	
1	2354.42	41.04	5.00	28.04	37.09	36.99	74.00	-37.01	Peak
2	2354.42	28.33	5.00	28.04	37.09	24.28	54.00	-29.72	Average
3	2375.63	41.68	5.03	27.97	37.09	37.59	74.00	-36.41	Peak
4	2375.63	29.84	5.03	27.97	37.09	25.75	54.00	-28.25	Average
5	2398.41	42.71	5.06	27.90	37.10	38.57	74.00	-35.43	Peak
6	2398.42	31.36	5.06	27.90	37.10	27.22	54.00	-26.78	Average
7	2410.00	79.18	5.07	27.87	37.10	75.02	114.00	-38.98	Peak

Note: 1. All readings are Quasi-peak values.
 2. Measured = Reading + Antenna Factor + Cable Loss - Amp Factor.
 3. The emission levels that are 20dB below the official limit are not reported.

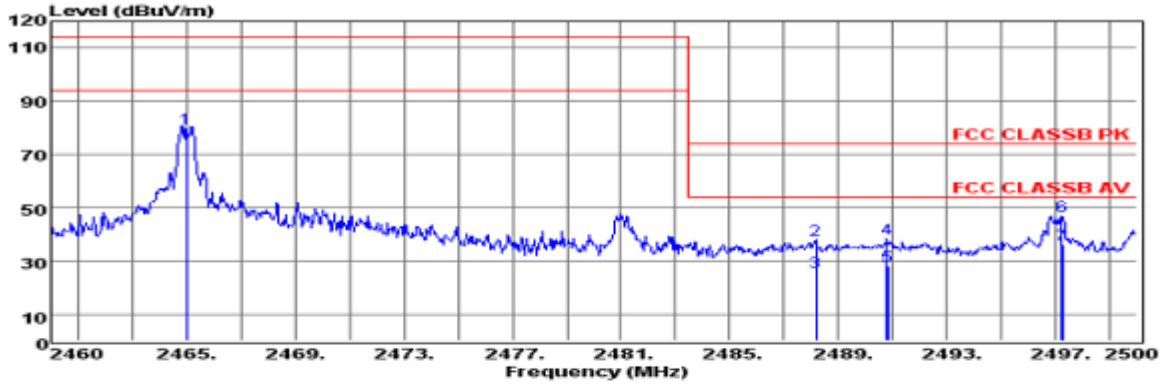

Env. /Ins: 24°C / 56%
 EUT: Proto X
 M/N: ESTE4606
 Power Rating: DC 3V
 Test Mode: Tx-2465
 Operator: ANDY
 Memo:
 pol: VERTICAL

	Freq	Reading	CabLos	AntFac	PreFac	Measured	Limit	Over	Remark
	MHz	dBuV	dB	dB/m	dB	dBuV/m	dBuV/m	dB	
1	2465.00	84.03	5.15	27.70	37.10	79.78	114.00	-34.22	Peak
2	2488.16	42.27	5.18	27.64	37.10	37.99	74.00	-36.01	Peak
3	2488.17	30.34	5.18	27.64	37.10	26.06	54.00	-27.94	Average
4	2490.80	42.63	5.19	27.63	37.10	38.35	74.00	-35.65	Peak
5	2490.83	32.37	5.19	27.63	37.10	28.09	54.00	-25.91	Average
6	2497.24	51.28	5.20	27.61	37.10	46.99	74.00	-27.01	Peak
7	2497.26	40.46	5.20	27.61	37.10	36.17	54.00	-17.83	Average

Note: 1. All readings are Quasi-peak values.
 2. Measured = Reading + Antenna Factor + Cable Loss - Amp Factor.
 3. The emission levels that are 20dB below the official limit are not reported.

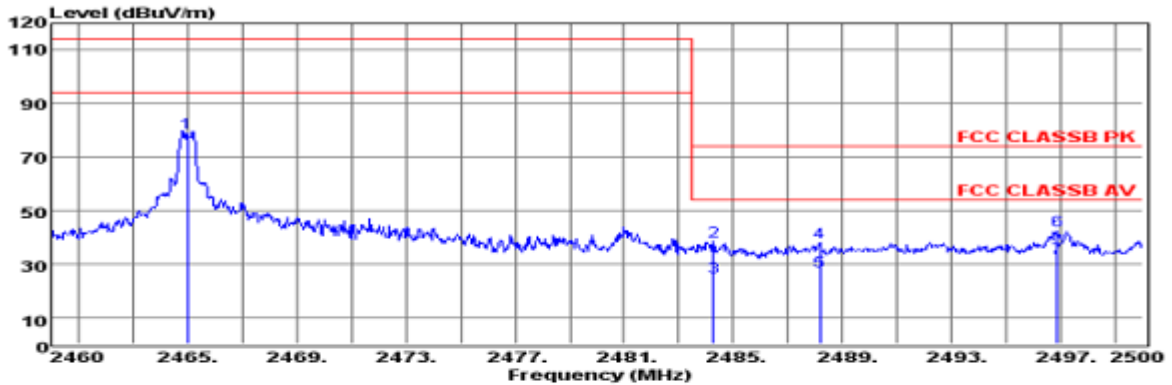

Env. /Ins: 24°C / 56%
 EUT: Proto X
 M/N: ESTE4606
 Power Rating: DC 3V
 Test Mode: Tx-2465
 Operator: ANDY
 Memo:
 pol: HORIZONTAL

	Freq	Reading	CabLos	AntFac	PreFac	Measured	Limit	Over	Remark
	MHz	dBuV	dB	dB/m	dB	dBuV/m	dBuV/m	dB	
1	2465.00	83.03	5.15	27.70	37.10	78.78	114.00	-35.22	Peak
2	2484.28	42.80	5.18	27.65	37.10	38.53	74.00	-35.47	Peak
3	2484.29	29.42	5.18	27.65	37.10	25.15	54.00	-28.85	Average
4	2488.16	42.27	5.18	27.64	37.10	37.99	74.00	-36.01	Peak
5	2488.17	31.34	5.18	27.64	37.10	27.06	54.00	-26.94	Average
6	2496.88	46.84	5.20	27.61	37.10	42.55	74.00	-31.45	Peak
7	2496.89	36.42	5.20	27.61	37.10	32.13	54.00	-21.87	Average

Note: 1. All readings are Quasi-peak values.
 2. Measured = Reading + Antenna Factor + Cable Loss - Amp Factor.
 3. The emission levels that are 20dB below the official limit are not reported.

8. 20 DB BANDWIDTH MEASUREMENT

8.1. Standard Applicable

According to §15.215 & RSS-210.

8.2. Test Equipment List and Details

Equipment	Manufacturer	Model No.	Serial No.	Last Cal.	Next Cal.
Spectrum Analyzer	Agilent	E4407B	MY41440754	2013-07-16	2014-07-15
DC Filter	MPE	23872C	N/A	2013-06-10	2014-06-09

8.3. Block Diagram of Test Setup

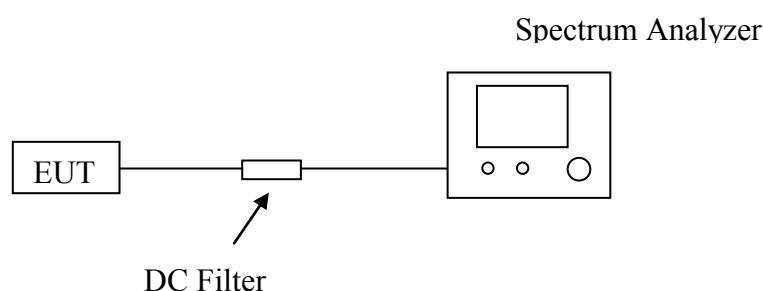

8.4. Test Procedure

Use the following spectrum analyzer settings:

Span = approximately 2 to 3 times the 20 dB bandwidth, centered on a hopping channel

RBW \geq 1% of the 20 dB bandwidth

VBW \geq RBW

Sweep = auto

Detector function = peak

Trace = max hold

The EUT should be transmitting at its maximum data rate. Allow the trace to stabilize. Use the marker-to-peak function to set the marker to the peak of the emission. Use the marker-delta function to measure 20 dB down one side of the emission. Reset the marker-delta function, and move the marker to the other side of the emission, until it is (as close as possible to) even with the reference marker level. The marker-delta reading at this point is the 20 dB bandwidth of the emission. If this value varies with different modes of operation (e.g., data rate, modulation format, etc.), repeat this test for each variation. The limit is specified in one of the subparagraphs of this Section. Submit this plot(s).

8.5. Test Results

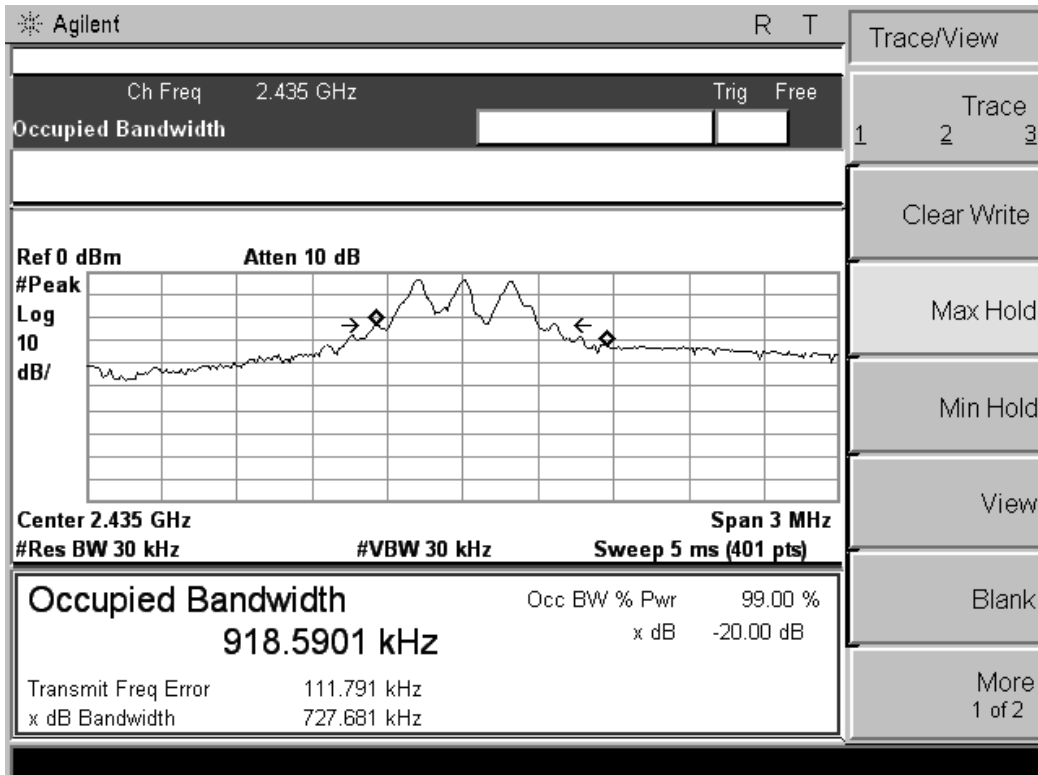
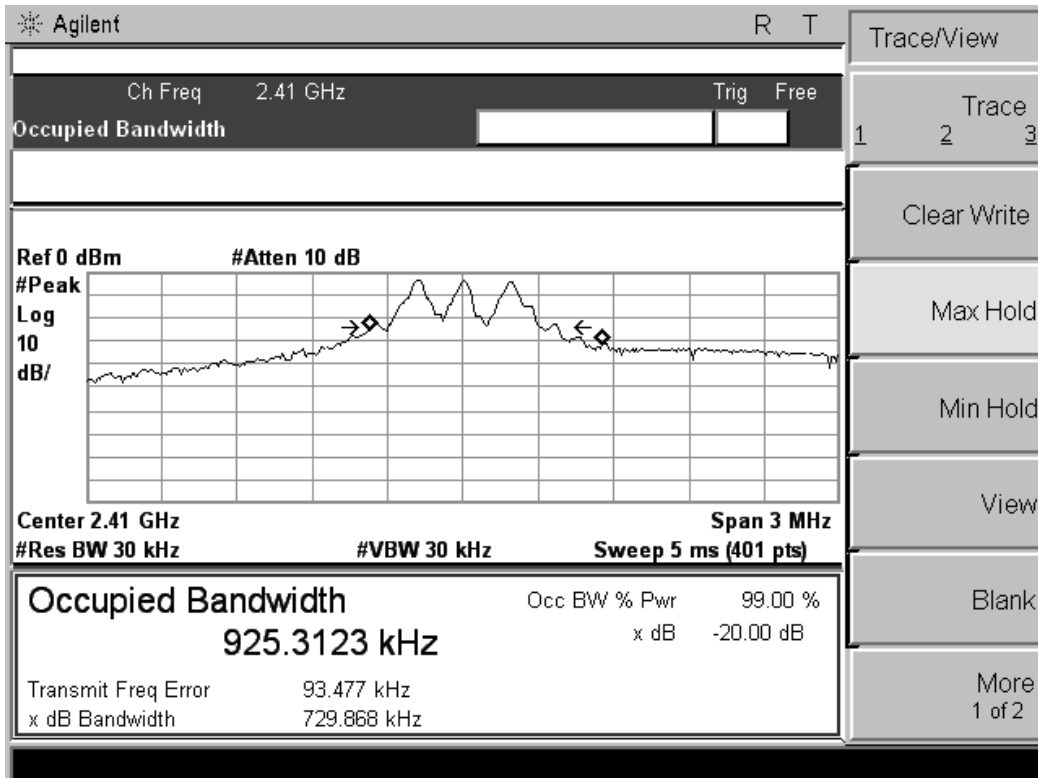

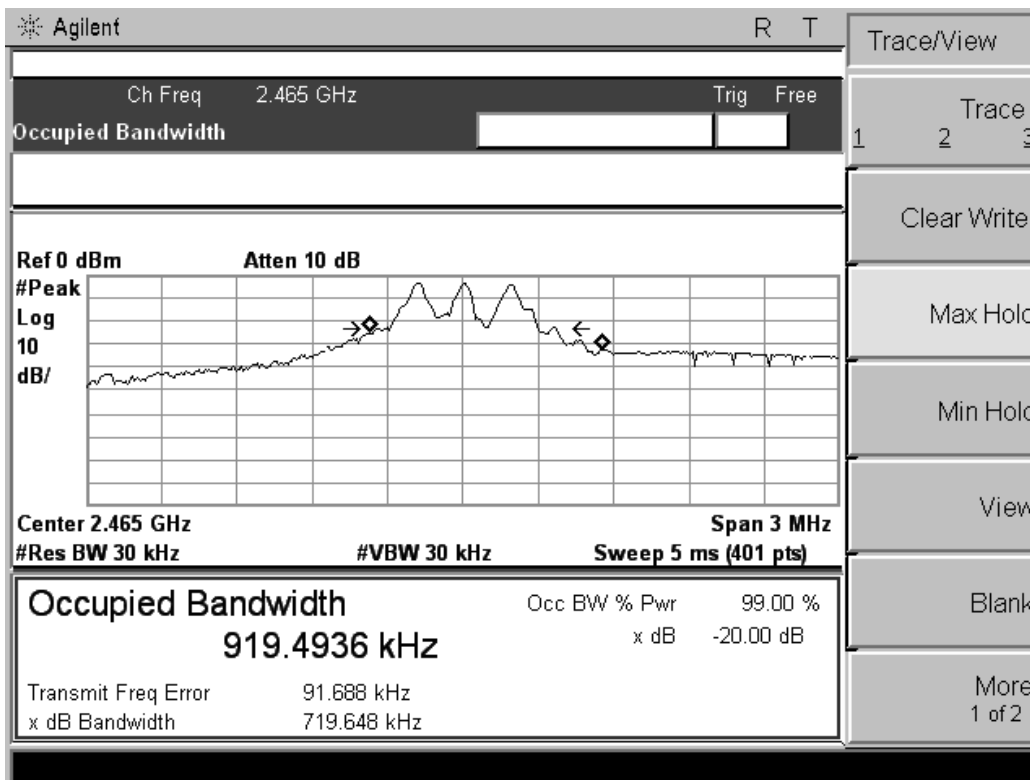

9. MANUFACTURER/ APPROVAL HOLDER DECLARATION

The following identical model(s):

ESTES 4609	--	--
------------	----	----

Belong to the tested device:

Product description : Proto X /Syncro

Model name : ESTE4606

Remark: PCB board, structure and internal of these model(s) are the same, So no additional models were tested.

-----THE END OF REPORT-----