

EMC Test Report

regarding

USA: CFR Title 47, Part 15.209 (Emissions)
Canada: ISED RSS-210v10/GENv5 (Emissions)

for

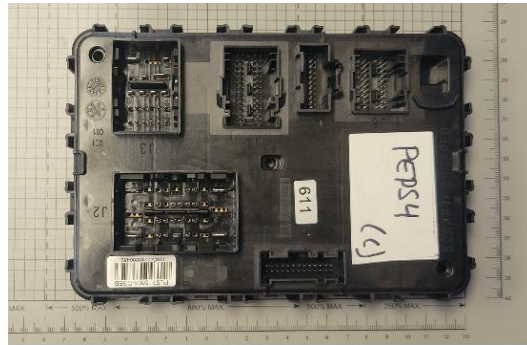

PEPS3, PEPS4

Category: LF Transmitter

Judgments:

15.209/RSS-210v10 Compliant Transmitter

Testing Completed: May 12, 2022



Prepared for:

Continental Automotive

4685 Investment Drive, Troy Michigan 48098 USA

Phone: +1 (248) 764 6758, Fax: +1 (248) 764-7281

Contact: Mark Kenney, Mark.Kenney@continental.com

Data Recorded by: John Nantz
John Nantz

Prepared by: Dr. Joseph Brunett
Dr. Joseph Brunett, EMC-002790-NE

Reviewed by: Dr. Joseph Brunett
Dr. Joseph Brunett, EMC-002790-NE

Date of Issue: May 13, 2022

Revision History

Rev. No.	Date	Details	Revised By
r0	May 13, 2022	Initial Release.	J. Brunett
r1	May 19, 2022	Include dBuA/m units.	J. Brunett

Contents

Revision History	2
Table of Contents	2
1 Test Report Scope and Limitations	4
1.1 Laboratory Authorization	4
1.2 Report Retention	4
1.3 Subcontracted Testing	4
1.4 Test Data	4
1.5 Limitation of Results	4
1.6 Copyright	4
1.7 Endorsements	4
1.8 Test Location	5
1.9 Traceability and Equipment Used	5
2 Test Specifications and Procedures	6
2.1 Test Specification and General Procedures	6
3 Configuration and Identification of the Equipment Under Test	7
3.1 Description and Declarations	7
3.1.1 EUT Configuration	8
3.1.2 Modes of Operation	8
3.1.3 Variants	8
3.1.4 Test Samples	8
3.1.5 Functional Exerciser	9
3.1.6 Modifications Made	9
3.1.7 Production Intent	9
3.1.8 Declared Exemptions and Additional Product Notes	9
4 Emissions	10
4.1 General Test Procedures	10
4.1.1 Radiated Test Setup and Procedures	10
4.1.2 Conducted Emissions Test Setup and Procedures	12
4.1.3 Power Supply Variation	12
4.2 Intentional Emissions	13
4.2.1 Fundamental Emission Pulsed Operation	13
4.2.2 Fundamental Emission Bandwidth	15
4.2.3 Fundamental Emission	16
4.3 Unintentional Emissions	17
4.3.1 Transmit Chain Spurious Emissions	17
5 Measurement Uncertainty and Accreditation Documents	18

List of Tables

1	Test Site List.	5
2	Equipment List.	5
3	EUT Declarations.	7
4	Pulsed Emission Characteristics (Duty Cycle).	13
5	Intentional Emission Bandwidth.	15
6	Fundamental Radiated Emissions.	16
7	Transmit Chain Spurious Emissions.	17
8	Measurement Uncertainty.	18

List of Figures

1	Photos of EUT.	7
2	EUT Test Configuration Diagram.	8
3	Radiated Emissions Diagram of the EUT.	10
4	Radiated Emissions Test Setup Photograph(s).	11
5	Pulsed Emission Characteristics (Duty Cycle).	14
6	Intentional Emission Bandwidth.	15
7	Accreditation Documents	18

1 Test Report Scope and Limitations

1.1 Laboratory Authorization

Test Facility description and attenuation characteristics are on file with the FCC Laboratory, Columbia, Maryland (FCC Reg. No: US5348 and US5356) and with ISED Canada, Ottawa, ON (File Ref. No: 3161A and 24249). Amber Helm Development L.C. holds accreditation under NVLAP Lab Code 200129-0.

1.2 Report Retention

For equipment verified to comply with the regulations herein, the manufacturer is obliged to retain this report with the product records for the life of the product, and no less than ten years. A copy of this Report will remain on file with this laboratory until June 2032.

1.3 Subcontracted Testing

This report does not contain data produced under subcontract.

1.4 Test Data

This test report contains data included within the laboratory's scope of accreditation. Any data in this report that is not covered under the laboratory's scope is clearly identified.

1.5 Limitation of Results

The test results contained in this report relate only to the item(s) tested. Any electrical or mechanical modification made to the test item subsequent to the test date shall invalidate the data presented in this report. Any electrical or mechanical modification made to the test item subsequent to this test date shall require reevaluation.

1.6 Copyright

This report shall not be reproduced, except in full, without the written approval of Amber Helm Development L.C.

1.7 Endorsements

This report shall not be used to claim product endorsement by any accrediting, regulatory, or governmental agency.

1.8 Test Location

The EUT was fully tested by **Amber Helm Development L.C.**, headquartered at 92723 Michigan Hwy-152, Sister Lakes, Michigan 49047 USA. Table 1 lists all sites employed herein. Specific test sites utilized are also listed in the test results sections of this report where needed.

Table 1: Test Site List.

Description	Location	Quality Num.
OATS (3 meter)	3615 E Grand River Rd., Williamston, Michigan 48895	OATSC

1.9 Traceability and Equipment Used

Pertinent test equipment used for measurements at this facility is listed in Table 2. The quality system employed at Amber Helm Development L.C. has been established to ensure all equipment has a clearly identifiable classification, calibration expiry date, and that all calibrations are traceable to the SI through NIST, other recognized national laboratories, accepted fundamental or natural physical constants, ratio type of calibration, or by comparison to consensus standards.

Table 2: Equipment List.

Description	Manufacturer/Model	SN	Quality Num.	Cal/Ver By / Date Due
Spectrum Analyzer	R & S / FPC1500	101692	RSFPC15001	RS / Oct-2022
Spectrum Analyzer	R & S / FSV30	101660	RSFSV30001	RS / Apr-2023
Biconical	EMCO / 93110B	9802-3039	BICEMCO01	Keysight / Aug-2023
Log Periodic Antenna	EMCO / 3146	9305-3614	LOGEMCO01	Keysight / Aug-2023
BNC-BNC Coax	WRTL / RG58/U	001	CAB001-BLACK	AHD / Sept-2022
Shielded Loop Antenna	EMCO / 6502	9502-2926	EMCOLOOP1	Keysight / Aug-2022

2 Test Specifications and Procedures

2.1 Test Specification and General Procedures

The goal of Continental Automotive is to demonstrate that the Equipment Under Test (EUT) complies with the Rules and/or Directives below. Detailed in this report are the results of testing the Continental Automotive PEPS3, PEPS4 for compliance to:

Country/Region	Rules or Directive	Referenced Section(s)
United States	Code of Federal Regulations	CFR Title 47, Part 15.209
Canada	ISED Canada	ISED RSS-210v10/GENv5

It has been determined that the equipment under test is subject to the rules and directives above at the date of this testing. In conjunction with these rules and directives, the following specifications and procedures are followed herein to demonstrate compliance (in whole or in part) with these regulations.

ANSI C63.4:2014	"Methods of Measurement of Radio-Noise Emissions from Low-Voltage Electrical and Electronic Equipment in the Range of 9 kHz to 40 GHz"
ANSI C63.10:2013	"American National Standard of Procedures for Compliance Testing of Unlicensed Wireless Devices"
TP0102RA	"AHD Internal Document TP0102 - Radiated Emissions Test Procedure"
ISED Canada	"The Measurement of Occupied Bandwidth"

3 Configuration and Identification of the Equipment Under Test

3.1 Description and Declarations

The equipment under test is a Body Control Module containing an LF transmitter for automotive use. The EUT is approximately 13 x 20 x 3 cm in dimension, and is depicted in Figure 1. It is powered by 13.4 VDC automotive power system. In use, this device is permanently installed in a motor vehicle. Table 3 outlines provider declared EUT specifications.

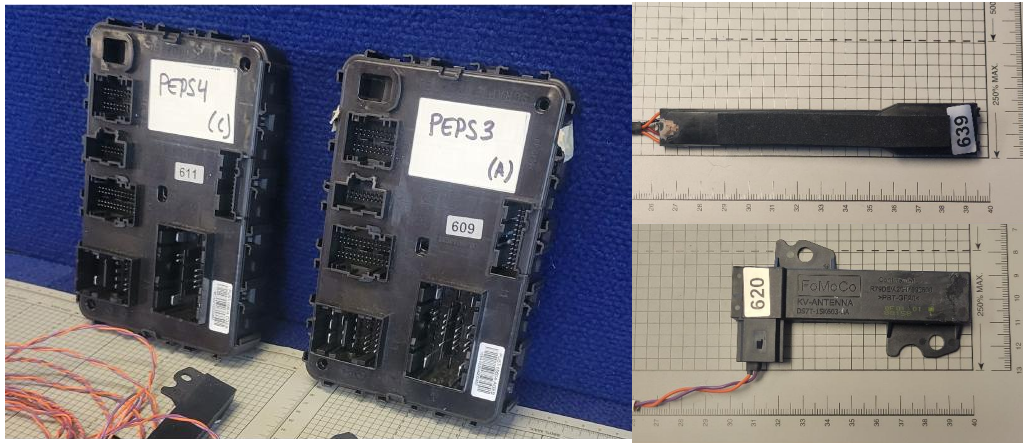

Figure 1: Photos of EUT.

Table 3: EUT Declarations.

General Declarations

Equipment Type:	LF Transmitter
Country of Origin:	Not Declared
Nominal Supply:	13.4 VDC
Oper. Temp Range:	Not Declared
Frequency Range:	125 kHz
Antenna Dimension:	Not Declared
Antenna Type:	Ferrite Coil
Antenna Gain:	Not Declared
Number of Channels:	1
Channel Spacing:	Not Applicable
Alignment Range:	Not Declared
Type of Modulation:	ASK

United States

FCC ID Number:	M3NA2C780107
Classification:	DSC

Canada

IC Number:	7812A-A2C780107
Classification:	Remote Control Device

3.1.1 EUT Configuration

The EUT is configured for testing as depicted in Figure 2.

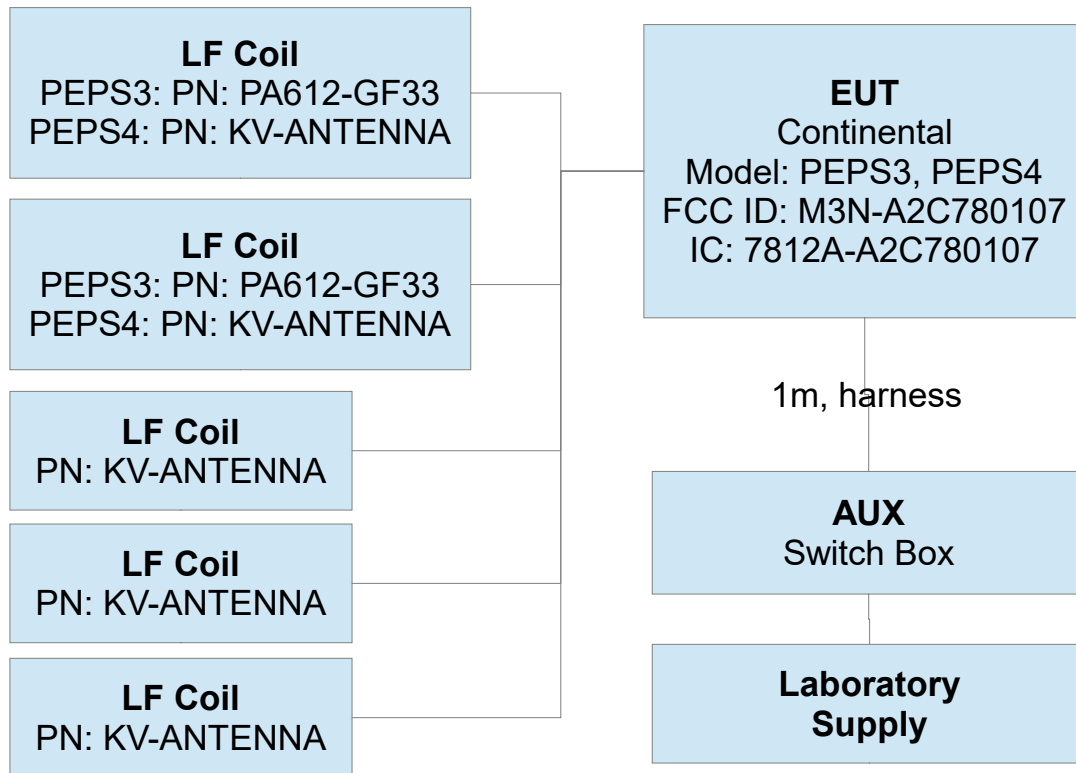

Figure 2: EUT Test Configuration Diagram.

3.1.2 Modes of Operation

This device is capable of two principle modes of operation, PEPS mode and POLLING mode. PEPS (Passive Entry, Passive Start) mode is manually activated mode that results in a finite set of sequential transmissions from all 5 antennas populated. POLLING mode is automatically initiated by the vehicle (clutch) and results in periodic transmissions on two of the 5 antennas only. Both modes are the same for both variants and no two antennas are ever actuated at the same time.

3.1.3 Variants

There are two principle variants of the EUT, PEPS3 and PEPS4. The PEPS3 variant employs two (2) door-handle mounted antenna coils (PN: PA612-GF33) and three (3) vehicle chassis mounted antenna coils (PN: KV-ANTENNA). The PEPS4 variant employs only five (5) of the same vehicle chassis mounted antenna coils (PN: KV-ANTENNA). The tuning employed for the door-handle coils is different than that of the chassis mounted coils, which is the only RF difference between the PEPS3 and PEPS4 variants. Minor differences in digital component populations also exist. The PEPS3 variant was fully tested and emissions from the PEPS4 variant was confirmed to be the same as those measured from the PEPS3.

3.1.4 Test Samples

Four samples in total were provided. Two set for stepped CW transmission on each antenna coil and POLLING modes (SN: 608, 612) , and two samples for PEPS manually activated transmissions (SN: 609, 611).

3.1.5 Functional Exerciser

Normal operating EUT functionality was verified by observation of transmitted signal.

3.1.6 Modifications Made

There were no modifications made to the EUT by this laboratory.

3.1.7 Production Intent

The EUT appears to be a production ready sample.

3.1.8 Declared Exemptions and Additional Product Notes

The EUT is permanently installed in a transportation vehicle. As such, digital emissions are exempt from US and Canadian digital emissions regulations (per FCC 15.103(a) and IC correspondence on ICES-003).

4 Emissions

4.1 General Test Procedures

4.1.1 Radiated Test Setup and Procedures

Radiated electromagnetic emissions from the EUT are first pre-scanned in our screen room. Spectrum and modulation characteristics of all emissions are recorded. Instrumentation, including spectrum analyzers and other test equipment as detailed in Section 1.8 are employed. After pre-scan, emission measurements are made on the test site of record. If the EUT connects to auxiliary equipment and is table or floor standing, the configurations prescribed in relevant test standards are followed. Alternatively, a layout closest to normal use (as declared by the provider) is employed if the resulting emissions appear to be worst-case in such a configuration. See Figure 3. All intentionally radiating elements that are not fixed-mounted in use are placed on the test table lying flat, on their side, and on their end (3-axes) and the resulting worst case emissions are recorded. If the EUT is fixed-mounted in use, measurements are made with the device oriented in the manner consistent with installation and then emissions are recorded. If the EUT exhibits spurious emissions due to internal receiver circuitry, such emissions are measured with an appropriate carrier signal applied.

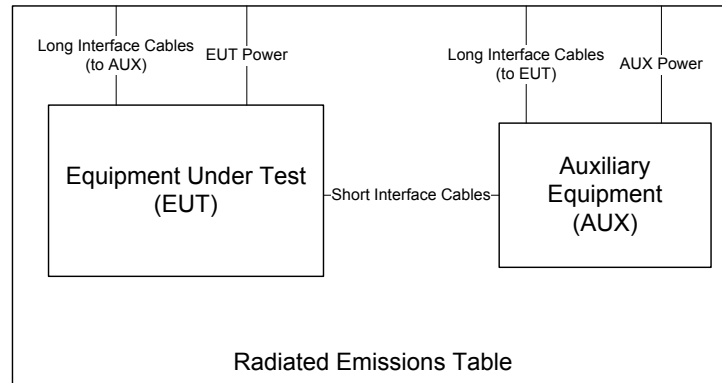

Figure 3: Radiated Emissions Diagram of the EUT.

For devices with intentional emissions below 30 MHz, a shielded loop antenna and/or E-field and H-Field broadband probes are used depending on the regulation. Shielded loops are placed at a 1 meter receive height at the desired measurement distance. For exposure in this band, 10cm diameter single-axis broadband probes meeting the requirements of ISED SPR-002 section 5.2 are employed. Measurements are repeated and summed over three axes, and the entire frequency range is measured with and without the EUT transmitting.

Emissions between 30 MHz and 1 GHz are measured using calibrated broadband antennas. For both horizontal and vertical polarizations, the test antenna is raised and lowered from 1 to 4 m in height until a maximum emission level is detected. The EUT is then rotated through 360° in azimuth until the highest emission is detected. The test antenna is then raised and lowered one last time from 1 to 4 m and the worst case value is recorded. Emissions above 1 GHz are characterized using standard gain or broadband ridge-horn antennas on our OATS with a 4×5 m rectangle of ECCOSORB absorber covering the OATS ground screen and a 1.5m table height. Care is taken to ensure that test receiver resolution and video bandwidths meet the regulatory requirements, and that the emission bandwidth of the EUT is not reduced. Photographs of the test setup employed are depicted in Figure 4.

Where regulations allow for direct measurement of field strength, power values (dBm) measured on the test receiver / analyzer are converted to $\text{dB}\mu\text{V}/\text{m}$ at the regulatory distance, using

$$E_{dist} = 107 + P_R + K_A - K_G + K_E - C_F$$

where P_R is the power recorded on spectrum analyzer, in dBm, K_A is the test antenna factor in dB/m, K_G is the combined pre-amplifier gain and cable loss in dB, K_E is duty correction factor (when applicable) in dB, and C_F is a distance conversion (employed only if limits are specified at alternate distance) in dB. This field strength value is then compared with the regulatory limit. If effective isotropic radiated power (EIRP) is computed, it is computed as

$$EIRP(\text{dBm}) = E_{3m}(\text{dB}\mu\text{V}/\text{m}) - 95.2.$$

When presenting data at each frequency, the highest measured emission under all possible EUT orientations (3-axes) is reported.

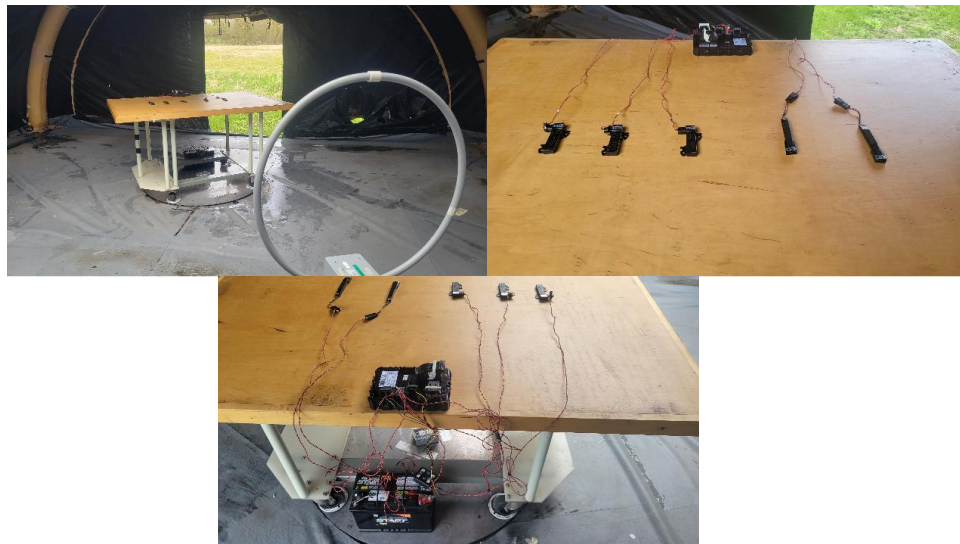

Figure 4: Radiated Emissions Test Setup Photograph(s).

4.1.2 Conducted Emissions Test Setup and Procedures

4.1.3 Power Supply Variation

Tests at extreme supply voltages are made if required by the procedures specified in the test standard, and results of this testing are detailed in this report.

4.2 Intentional Emissions

4.2.1 Fundamental Emission Pulsed Operation

The details and results of testing the EUT for pulsed operation are summarized in Table 4.

Table 4: Pulsed Emission Characteristics (Duty Cycle).

Frequency Range
9 kHz ≤ f ≤ 150 kHz

Det
Pk/QPk

IF Bandwidth
30 kHz

Video Bandwidth
100 kHz

Test Date: 12-May-22
Test Engineer: Joseph Brunett

EUT Mode: See Below

Meas. Distance: 10cm

EUT Tested: Conti PEPS3, PEPS4

#	EUT Mode	Overall Transmission			Internal Frame Characteristics			Computed Duty Cycle*	
		Min. Repetition Rate (sec)	Max. No. of Frames	Total Transmission Length (sec)	Max. Frame Length (ms)	Min. Frame Period (s)	Frame Encoding	(%)	Duty (dB)
1	PEPS	single	5	0.00574	1.1	N/A	When manually activated for passive entry passive start, the EUT transmits 5 CW frames, one at each of the 5 antennas.	100.000	*
2	POLLING	0.70	2	0.025	11.2	N/A	When polling, the EUT transmits two 11.2 ms ASK modulated frames every 700 ms.	11.240	*

* No Duty Cycle is employed when demonstrating compliance.

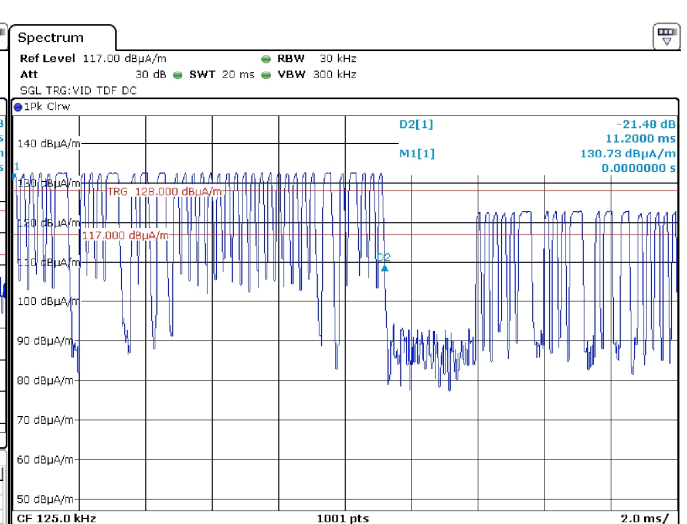
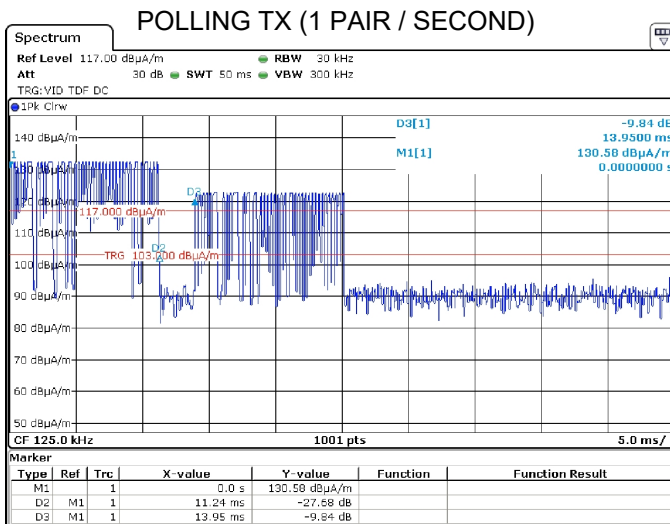
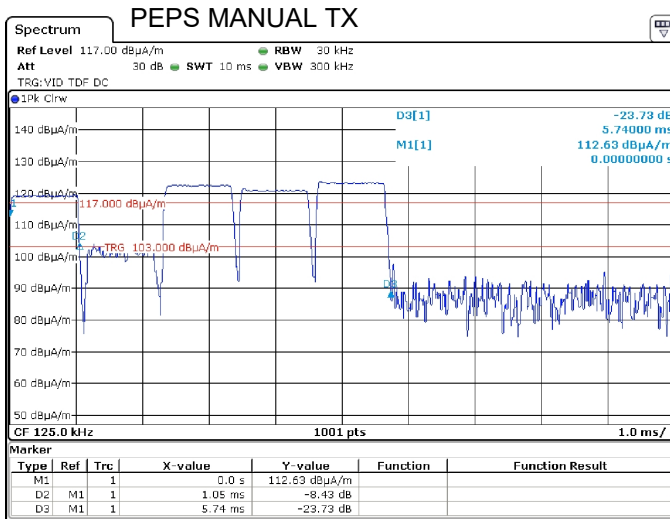

Figure 5: Pulsed Emission Characteristics (Duty Cycle).

4.2.2 Fundamental Emission Bandwidth

Emission bandwidth (EBW) of the EUT is measured with the device placed in the test mode(s) with the shortest available frame length and minimum frame spacing. Radiated emissions are recorded following the test procedures listed in Section 2.1. The 20 dB EBW is measured as the max-held peak-detected signal when the IF bandwidth is greater than or equal to 1% of the receiver span. For complex modulations other than ASK and FSK, the 99% emission bandwidth per IC test procedures has a different result, and is also separately reported. The results of EBW testing are summarized in Table 5. Plots showing measurements employed to obtain the emission bandwidth reported are provided in Figure 6.

Table 5: Intentional Emission Bandwidth.

Frequency Range 9 kHz ≤ f ≤ 150 kHz 150 kHz ≤ f ≤ 30 MHz	Det Pk Pk	IF Bandwidth > 1% Span > 1% Span	Video Bandwidth ≥ 3 * IFBW ≥ 3 * IFBW	Test Date: 13-May-22 Test Engineer: Joseph Brunett EUT Mode: See Below Meas. Distance: 0.6 m EUT Tested: Conti PEPS3, PEPS4
---	------------------------	---	--	--

#	Mode	Frequency (MHz)	Temp (C)	Supply (VDC)	20 dB EBW (kHz)	99% EBW (kHz)	110 kHz Restricted Band* (dBc)
1	PEPS	0.125	21	13.4	4.396	8551	41.3
2	POLLING	0.125	21	13.4	18.2	24.1	<20 dB

* Note: The EUT emissions in the 90-110 kHz restricted band are within 20 dB of the fundamental. However, the FCC permits emissions in that band so long as they are beyond the first null of the modulated spectrum, as those are not considered part of the fundamental intentional emission.

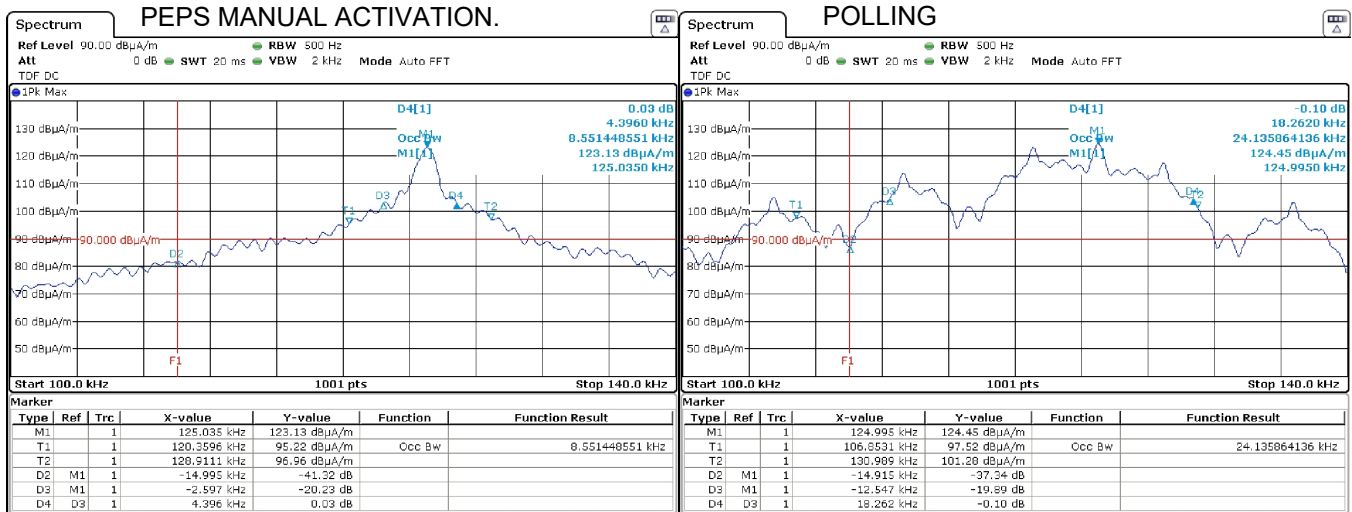

Figure 6: Intentional Emission Bandwidth.

4.2.3 Fundamental Emission

Following the test procedures listed in Section 2.1, field emissions measurements are made on the EUT for both Horizontal and Vertically polarized coupling fields. The EUT’s loop antenna(s) are measured along all three axes, including when the EUT loop axes are aligned in the same axis as the test loop and aligned coplanar (in the same plane) with the test loop antenna. Table 6 details the results of these measurements.

Table 6: Fundamental Radiated Emissions.

Frequency Range	Det	IF Bandwidth	Video Bandwidth	Test Date:	6-May-22
9 kHz ≤ f ≤ 150 kHz	Pk/QPk	200 Hz	300 Hz	Test Engineer:	J. Nantz
150 kHz ≤ f ≤ 30 MHz	Pk/QPk	9 kHz	30 kHz	EUT Mode:	CW, Polling Conf.
25 MHz ≤ f ≤ 1 000 MHz	Pk/QPk	120 kHz	300 kHz	Meas. Distance:	3 meters
f > 1 000 MHz	Pk	1 MHz	3MHz	EUT Tested:	Conti PEPS3, PEPS4
f > 1 000 MHz	Avg	1 MHz	3MHz		

Fundamental Emissions Measurements																			
#	Mode	EUT Orientation	Freq. kHz	Ant. Used QN	Ant.** Height m	Table Azim deg	Ka dB/m	Kg dB	CF*** 3m / 300m dB	E-field @ 3m			E-field @ 300m			H-field @ 300m (ISED)			Pass By***
										Pk dBuV/m	Qpk		Pk dBuV/m	Qpk	Limit Qpk	Pk dBuA/m	Qpk	Limit Qpk	
1	Pulsed, KV-ANTENNA	Flat	125.0	EMCOLOOP1	1.0	0	10.1	0.0	96.0	105.7		9.7		25.7	-41.8		-25.9	16.0	
2		Side	125.0	EMCOLOOP1	1.0	0	10.1	0.0	96.0	101.5		5.5		25.7	-46.0		-25.9	20.2	
3		End	125.0	EMCOLOOP1	1.0	0	10.1	0.0	96.0	97.8		1.8		25.7	-49.7		-25.9	23.9	
4	Pulsed, PA612-GF33 Antenna	Flat	125.0	EMCOLOOP1	1.0	0	10.1	0.0	96.0	95.9		-0.1		25.7	-51.6		-25.9	25.8	
5		Side	125.0	EMCOLOOP1	1.0	0	10.1	0.0	96.0	91.8		-4.2		25.7	-55.7		-25.9	29.9	
6		End	125.0	EMCOLOOP1	1.0	0	10.1	0.0	96.0	88.4		-7.6		25.7	-59.1		-25.9	33.3	

#	Mode	Test Antenna Polarization	Freq. kHz	DC Supply Voltage	E-field dBuV/m
4	Pulsed, KV-ANTENNA	Flat	125.0	15.2	105.1
5			125.0	13.4	105.7
6			125.0	11.5	105.6

Measured OATS Field Decay Rate Applied for CF				
Freq. kHz	Dist from EUT m	E (Pk) dBuV/m	Formula Fit E (Pk) vs Distance	
125.0	.5	139.8	-20.845 ln(x) + 129.55	
125.0	1.0	130.0	Base10 Rate of Decay*** (dB/dec)	
125.0	1.5	120.9		
125.0	3.0	105.7		
125.0	5.0	96.7		

*** A Ln (x) = 2.303*A Log(x).

* EUT is tested in CW. No averaging applies and Quasi-Peak data was not needed to demonstrate compliance.
 ** Emissions were evaluated at 1m test antenna height.
 *** EUT field decay rate is ot measured over a range of distances to determine CF between measurement and limit distance.

4.3 Unintentional Emissions

4.3.1 Transmit Chain Spurious Emissions

The results for the measurement of transmit chain spurious emissions at the nominal voltage and temperature are provided in Table 7. Following the test procedures listed in Section 2.1, field emissions measurements are made on the EUT for both Horizontal and Vertically polarized coupling fields. The EUT’s loop antenna(s) are measured when the EUT loop axes placed in all three axes, including when they are aligned along the same axis as the test loop antenna and are aligned coplanar with the test loop antenna. For all arrangements, test loop is rotated for maximum field. The results for the measurement of transmit chain spurious emissions at the nominal voltage and temperature are provided in Table 7. Measurements are performed to 10 times the highest fundamental operating frequency.

Table 7: Transmit Chain Spurious Emissions.

Frequency Range	Det	IF Bandwidth	Video Bandwidth	Test Date:	6-May-22
9 kHz ≤ f ≤ 150 kHz	Pk/QPk	200 Hz	300 Hz	Test Engineer:	J. Nantz
150 kHz ≤ f ≤ 30 MHz	Pk/QPk	9 kHz	30 kHz	EUT Mode:	CW, Polling Conf.
25 MHz ≤ f ≤ 1 000 MHz	Pk/QPk	120 kHz	300 kHz	Meas. Distance:	3 meters
f > 1 000 MHz	Pk/Avg	1 MHz	3MHz	EUT Tested:	Conti PEPS3, PEPS4

Transmit Chain Spurious Emissions																			
#	Mode	EUT Orientation	Freq. kHz	Ant. Used	Ant.** Height m	Table Azim deg	Ka dB/m	Kg dB	CF*** (3 to 30/300m) dB	E-field @ 3m dBuV/m		E-field @ 30/300m dBuV/m			H-field @ 30/300m (ISED) dBuV/m			Pass By	Comments
										Pk	Qpk	Pk	Qpk	Limit Qpk	Pk	Qpk	Limit Qpk		
1	Pulsed, KV-ANTENNA	Max All, Worst	250.0	EMCOLOOP1	1.0	330	10.0	0.0	80.0	79.0	-1.0	19.6	-52.5	-31.9	20.6				
2		Max All, Worst	375.0	EMCOLOOP1	1.0	330	10.0	0.0	80.0	72.9	-7.1	16.1	-58.6	-35.4	23.2				
3		Max All, Worst	500.0	EMCOLOOP1	1.0	330	10.2	0.0	40.0	69.7	29.7	33.6	-21.8	-17.9	3.9				
4		Max All, Worst	625.0	EMCOLOOP1	1.0	330	10.2	0.0	40.0	64.2	24.2	31.7	-27.3	-19.8	7.5				
5		Max All, Worst	750.0	EMCOLOOP1	1.0	330	10.1	0.0	40.0	56.8	16.8	30.1	-34.7	-21.4	13.3				
6		Max All, Worst	875.0	EMCOLOOP1	1.0	330	10.3	0.0	40.0	48.1	8.1	28.8	-43.4	-22.8	20.7	noise			
7		Max All, Worst	1000.0	EMCOLOOP1	1.0	330	11.5	0.0	40.0	49.1	9.1	27.6	-42.4	-23.9	18.5	background			
8		Max All, Worst	1125.0	EMCOLOOP1	1.0	330	11.3	0.0	40.0	52.5	12.5	26.6	-39.0	-24.9	14.1	background			
9		Max All, Worst	1250.0	EMCOLOOP1	1.0	330	12.3	0.0	40.0	52.3	12.3	25.7	-39.2	-25.9	13.4	background			
10																			
11	Pulsed, PA612-GF33 Antenna	Max All, Worst	250.0	EMCOLOOP1	1.0	240	10.0	0.0	80.0	84.0	4.0	19.6	-47.5	-31.9	15.6				
12		Max All, Worst	375.0	EMCOLOOP1	1.0	240	10.0	0.0	80.0	75.0	-5.0	16.1	-56.5	-35.4	21.1				
13		Max All, Worst	500.0	EMCOLOOP1	1.0	240	10.2	0.0	40.0	69.9	29.9	33.6	-21.6	-17.9	3.7				
14		Max All, Worst	625.0	EMCOLOOP1	1.0	240	10.2	0.0	40.0	59.9	19.9	31.7	-31.6	-19.8	11.8				
15		Max All, Worst	750.0	EMCOLOOP1	1.0	240	10.1	0.0	40.0	49.7	9.7	30.1	-41.8	-21.4	20.4	noise			
16		Max All, Worst	875.0	EMCOLOOP1	1.0	240	10.3	0.0	40.0	57.5	17.5	28.8	-34.0	-22.8	11.3	background			
17		Max All, Worst	1000.0	EMCOLOOP1	1.0	240	11.5	0.0	40.0	56.2	16.2	27.6	-35.3	-23.9	11.4	background			
18		Max All, Worst	1125.0	EMCOLOOP1	1.0	240	11.3	0.0	40.0	59.2	19.2	26.6	-32.3	-24.9	7.4	background			
19		Max All, Worst	1250.0	EMCOLOOP1	1.0	240	12.3	0.0	40.0	57.2	17.2	25.7	-34.3	-25.9	8.5	background			

* EUT was tested in periodic CW mode. No averaging applied and Quasi-Peak data was not needed to demonstrate compliance.
 ** Emissions were evaluated at 1m test antenna height from 9 kHz to 30 MHz. No significant spurious were observed past the 10th harmonic.
 *** FCC E-field 40 dB/dec decay assumed. EUT field decay rate was not measured over a range of distances to determine CF between measurement and limit distance.

Measured OATS Field Decay Rate to Confirm Field Conversion below 490 KHz											
Freq. kHz	Dist. m	Pr (Pk) dBm	Formula Fit Pr (Pk) vs Distance	Freq. kHz	Dist. m	Pr (Pk) dBm	Formula Fit Pr (Pk) vs Distance	Freq. kHz	Dist. m	Pr (Pk) dBm	Formula Fit Pr (Pk) vs Distance
250.0	.5	-54	20.1981mcs - 67.7	375.0	.5	-58.1	22.7661mcs - 52.96	625.0	.5	-62.1	23.0111mcs - 67.37
250.0	1.0	-67	Base 10 Rate of Decay***	375.0	1.0	-69.0	Base 10 Rate of Decay***	625.0	1.0	-66.0	Base 10 Rate of Decay***
250.0	2.0	-82	(dB/dec)	375.0	2.0	-89.0	(dB/dec)	625.0	2.0	-84.0	(dB/dec)
250.0	4.0	-none	-46.5	375.0	4.0	-88.0	-52.4	625.0	4.0	-none	-53.0

*** A Ln (x) = 2.303 * A Log(x).

5 Measurement Uncertainty and Accreditation Documents

The maximum values of measurement uncertainty for the laboratory test equipment and facilities associated with each test are given in the table below. This uncertainty is computed for a 95.45% confidence level based on a coverage factor of $k = 2$.

Table 8: Measurement Uncertainty.

Measured Parameter	Measurement Uncertainty [†]
Radio Frequency	$\pm(f_{Mkr}/10^7 + RBW/10 + (SPN/(PTS - 1))/2 + 1 \text{ Hz})$
Conducted Emm. Amplitude	$\pm 1.9 \text{ dB}$
Radiated Emm. Amplitude ($f < 30 \text{ MHz}$)	$\pm 3.1 \text{ dB}$
Radiated Emm. Amplitude (30 – 200 MHz)	$\pm 4.0 \text{ dB}$
Radiated Emm. Amplitude (200 – 1000 MHz)	$\pm 5.2 \text{ dB}$
Radiated Emm. Amplitude ($f > 1000 \text{ MHz}$)	$\pm 3.7 \text{ dB}$

[†]Ref: CISPR 16-4-2:2011+A1:2014

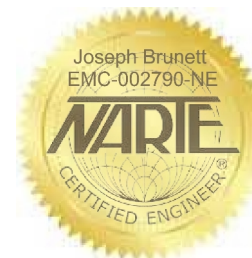

Figure 7: Accreditation Documents