



The University of Michigan Radiation Laboratory
3228 EECS Building
Ann Arbor, Michigan 48109-2122 USA
Tel: (734) 483-4211
Fax: (734) 647-2106
e-mail: liepa@umich.edu

Testing of
Electromagnetic Emissions
per

USA: CFR Title 47, Part 15.249
Canada: IC RSS-210/GENe

are herein reported for

Continental Automotive Systems US Inc.
A2C931426

Test Report No.: 417124-151130-01
Copyright © 2015

Applicant/Provider:
Continental Automotive Systems US Inc.
2400 Executive Hills Drive, Auburn Hills Michigan 48326-2980 USA
Phone: +1 (248) 764-6522, Fax: +1 (248) 764-7281
Contact Person: David Reimus; David.James.Reimus@continental-corporation.com

Measured by: [Signature] Report Approved by: [Signature]
Dr. Valdis V. Liepa Dr. Valdis V. Liepa
Report by: [Signature] Report Date of Issue: November 30, 2015
Dr. Valdis V. Liepa

Results of testing completed on (or before) October 28, 2015 are as follows.

Emissions: The transmitter intentional emissions COMPLY with the regulatory limit(s) by no less than 1.4 dB. Transmit chain spurious or harmonic emissions COMPLY by no less than 6.1 dB. Radiated spurious emissions associated with the receive chain of this device COMPLY the regulatory limit(s) by no less than 7.8 dB. Unintentional spurious emissions from digital circuitry COMPLY with radiated emission limit(s) by at least 20 dB.

Contents

1	Test Specifications, General Procedures, and Location	4
1.1	Test Specification and General Procedures	4
1.2	Test Location and Equipment Used	5
2	Configuration and Identification of the Equipment Under Test	6
2.1	Description and Declarations	6
2.1.1	EUT Configuration	7
2.1.2	Modes of Operation	7
2.1.3	Variants	7
2.1.4	Test Samples	7
2.1.5	Functional Exerciser	7
2.1.6	Modifications Made	7
2.1.7	Production Intent	7
2.1.8	Declared Exemptions and Additional Product Notes	7
3	Emissions	8
3.1	General Test Procedures	8
3.1.1	Radiated Test Setup and Procedures	8
3.1.2	Conducted Emissions Test Setup and Procedures	10
3.1.3	Power Supply Variation	10
3.2	Intentional Emissions	11
3.2.1	Fundamental Emission Pulsed Operation	11
3.2.2	Fundamental Emission Bandwidth	13
3.2.3	Fundamental Emission Field Strength	14
3.3	Unintentional Emissions	15
3.3.1	Transmit Chain Spurious Emissions	15
3.3.2	Radiated Receiver Spurious	16
3.3.3	Radiated Digital Spurious	17

List of Tables

1	The University of Michigan Radiation Laboratory Equipment List	5
2	EUT Declarations.	6
3	Fundamental Emission Pulsed Operation.	11
4	Fundamental Emission Bandwidth.	13
5	Fundamental Emission Field Strength.	14
6	Transmit Chain Spurious Emissions.	15
7	Receiver Chain Spurious Emissions \geq 30 MHz.	16

List of Figures

1	Photos of EUT.	6
2	EUT Test Configuration Diagram.	7
3	Radiated Emissions Diagram of the EUT.	8
4	Radiated Emissions Test Setup Photograph(s).	9
5	Fundamental Emission Pulsed Operation.	12
6	Fundamental Emission Bandwidth.	13

1 Test Specifications, General Procedures, and Location

1.1 Test Specification and General Procedures

The ultimate goal of Continental Automotive Systems US Inc. is to demonstrate that the Equipment Under Test (EUT) complies with the Rules and/or Directives below. Detailed in this report are the results of testing the Continental Automotive Systems US Inc. A2C931426 for compliance to:

Country/Region	Rules or Directive	Referenced Section(s)
United States	Code of Federal Regulations	CFR Title 47, Part 15.249
Canada	Industry Canada	IC RSS-210/GENe

Continental Automotive Systems US Inc. has determined that the equipment under test is subject to the rules and directives above at the date of this testing. In conjunction with these rules and directives, the following specifications and procedures are followed herein to demonstrate compliance (in whole or in part) with these regulations.

ANSI C63.4:2009 (USA)	"Methods of Measurement of Radio-Noise Emissions from Low-Voltage Electrical and Electronic Equipment in the Range of 9 kHz to 40 GHz"
ANSI C63.10:2013 (USA)	"American National Standard of Procedures for Compliance Testing of Unlicensed Wireless Devices"
ANSI C63.4:2014 (CAN)	"Methods of Measurement of Radio-Noise Emissions from Low-Voltage Electrical and Electronic Equipment in the Range of 9 kHz to 40 GHz"
Industry Canada	"The Measurement of Occupied Bandwidth"
ICES-003; Issue 5 (2012)	"Information Technology Equipment (ITE) Limits and methods of measurement"

1.2 Test Location and Equipment Used

Test Location The EUT was fully tested by **The University of Michigan Radiation Laboratory**, 3228 EECS Building, Ann Arbor, Michigan 48109-2122 USA. The Test Facility description and attenuation characteristics are on file with the FCC Laboratory, Columbia, Maryland (FCC Reg. No: 91050) and with Industry Canada, Ottawa, ON (File Ref. No: IC 2057A-1).

Test Equipment Pertinent test equipment used for measurements at this facility is listed in Table 1. The quality system employed at The University of Michigan Radiation Laboratory has been established to ensure all equipment has a clearly identifiable classification, calibration expiry date, and that all calibrations are traceable to the SI through NIST, other recognized national laboratories, accepted fundamental or natural physical constants, ratio type of calibration, or by comparison to consensus standards.

Table 1: The University of Michigan Radiation Laboratory Equipment List

Description	Manufacturer/Model	SN	Quality Num.	Last Cal By / Date Due
Spectrum Analyzer	Hewlett Packard / 8593E	3412A01131	HP8593E1	Agilent / Jul-2016
Dipole Set (20-1000 MHz)	UM / RLDP	RLDP-1,- 2,-3	UMDIP1	UM / Jul-2016
Ridge-Horn Antenna	Univ. of Michigan / VVL	5	UMRH1	UM / Jul-2016

2 Configuration and Identification of the Equipment Under Test

2.1 Description and Declarations

The equipment under test is an automotive Remote Keyless Entry and Remote Start transceiver. The EUT is approximately 4 x 2.5 x 1 cm (approx.) in dimension, and is depicted in Figure 1. It is powered by a 3 VDC Lithium cell battery. In use, this device is hand held. Table 2 outlines provider declared EUT specifications.



Figure 1: Photos of EUT.

Table 2: EUT Declarations.

General Declarations			
Equipment Type:	RKE Transceiver	Country of Origin:	Mexico
Nominal Supply:	3 VDC	Oper. Temp Range:	Not Declared
Frequency Range:	902.375, 903.425 MHz	Antenna Dimension:	Not Declared
Antenna Type:	integral	Antenna Gain:	Not Declared
Number of Channels:	2	Channel Spacing:	1.050 MHz
Alignment Range:	Not Declared	Type of Modulation:	FSK
United States			
FCC ID Number:	M3N-A2C931426	Classification:	DXT
Canada			
IC Number:	7812A-A2C931426	Classification:	Remote Control Device, Vehicular Device

2.1.1 EUT Configuration

The EUT is configured for testing as depicted in Figure 2.

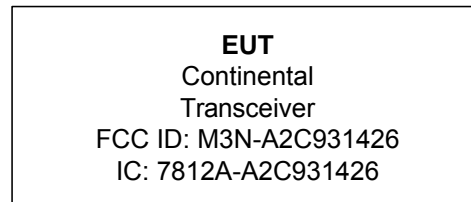

Figure 2: EUT Test Configuration Diagram.

2.1.2 Modes of Operation

There are three modes of operation. When manually activated by button press the EUT transmits a set of FSK frames in Remote Keyless Entry (RKE) mode. When manually activated by external LF interrogation (e.g. a button or door handle is raised in the vehicle) the EUT transmits one 16ms FSK frame for a Passive Entry (PE) mode or a double-length FSK frame for a Passive Start (PS) mode. All modes are tested herein.

2.1.3 Variants

There is only a single variant of the EUT, as tested.

2.1.4 Test Samples

Five samples in total were provided. Two samples programmed for CW transmission (low and high channels), one normal operating sample capable of manually activated and LF interrogated transmissions, and two samples to be dismantled for testing and photographs.

2.1.5 Functional Exerciser

Normal operating EUT functionality was verified by observation of transmitted signal.

2.1.6 Modifications Made

There were no modifications made to the EUT by this laboratory.

2.1.7 Production Intent

The EUT appears to be a production ready sample.

2.1.8 Declared Exemptions and Additional Product Notes

None.

3 Emissions

3.1 General Test Procedures

3.1.1 Radiated Test Setup and Procedures

Radiated electromagnetic emissions from the EUT are first pre-scanned in our shielded anechoic chamber. Spectrum and modulation characteristics of all emissions are recorded. Instrumentation, including spectrum analyzers and other test equipment as detailed in Section 1.2 are employed. After indoor pre-scans, emission measurements are made on our outdoor 3-meter Open Area Test Site (OATS). If the EUT connects to auxiliary equipment and is table or floor standing, the configurations prescribed in relevant test standards are followed. Alternatively, a layout closest to normal use (as declared by the provider) is employed if the resulting emissions appear to be worst-case in such a configuration. See Figure 3. All intentionally radiating elements that are not fixed-mounted in use are placed on the test table lying flat, on their side, and on their end (3-axes) and the resulting worst case emissions are recorded. If the EUT is fixed-mounted in use, measurements are made with the device oriented in the manner consistent with installation and then emissions are recorded.

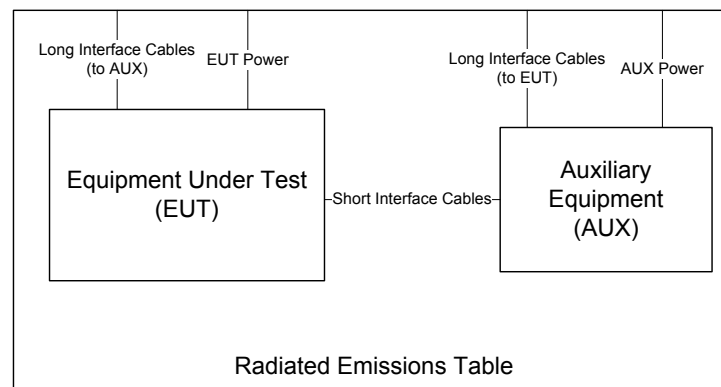

Figure 3: Radiated Emissions Diagram of the EUT.

If the EUT exhibits spurious emissions due to internal receiver circuitry, such emissions are measured with an appropriate carrier signal applied. For devices with intentional emissions below 30 MHz, a shielded loop antenna is used. It is placed at a 1 meter receive height. Emissions between 30 MHz and 1 GHz are measured using tuned dipoles and/or calibrated broadband antennas. For both horizontal and vertical polarizations, the test antenna is raised and lowered from 1 to 4 m in height until a maximum emission level is detected. The EUT is then rotated through 360° in azimuth until the highest emission is detected. The test antenna is then raised and lowered one last time from 1 to 4 m and the worst case value is recorded. Emissions above 1 GHz are characterized using standard gain horn antennas or calibrated broadband ridge-horn antennas on our OATS with a 2.4m x 2.4m square of AN-79 or H-4 absorber placed over the ground screen between the EUT and the test antenna. Care is taken to ensure that test receiver resolution and video bandwidths meet the regulatory requirements, and that the emission bandwidth of the EUT is not reduced. Photographs of the test setup employed are depicted in Figure 4.

Where regulations allow for direct measurement of field strength, power values (dBm) measured on the test receiver / analyzer are converted to dBμV/m at the regulatory distance, using

$$E_{dist} = 107 + P_R + K_A - K_G + K_E - C_F$$

where P_R is the power recorded on spectrum analyzer, in dBm, K_A is the test antenna factor in dB/m, K_G is the combined pre-amplifier gain and cable loss in dB, K_E is duty correction factor (when applicable) in dB, and C_F is a distance conversion (employed only if limits are specified at alternate distance) in dB. This field strength value is then compared with the regulatory limit. If effective isotropic radiated power (EIRP) is computed, it is computed as

$$EIRP(dBm) = E_{3m}(dB\mu V/m) - 95.2.$$

When presenting data at each frequency, the highest measured emission under all possible EUT orientations (3-axes) is reported.

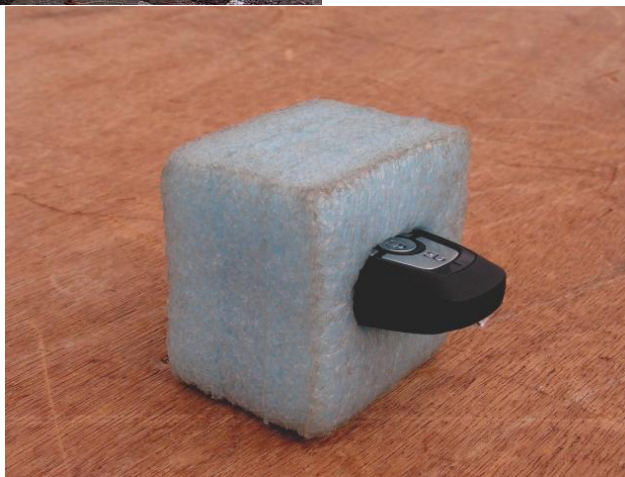

Figure 4: Radiated Emissions Test Setup Photograph(s).

3.1.2 Conducted Emissions Test Setup and Procedures

Battery Power Conducted Spurious The EUT is not subject to measurement of power line conducted emissions as it is powered solely by its internal battery.

3.1.3 Power Supply Variation

Tests at extreme supply voltages are made if required by the the procedures specified in the test standard, and results of this testing are detailed in this report.

In the case the EUT is designed for operation from a battery power source, the extreme test voltages are evaluated over the range specified in the test standard; no less than $\pm 10\%$ of the nominal battery voltage declared by the manufacturer. For all battery operated equipment, worst case intentional and spurious emissions are re-checked employing a new (fully charged) battery.

3.2 Intentional Emissions

3.2.1 Fundamental Emission Pulsed Operation

Test Setup & Procedure The test equipment and facilities were setup in accordance with the standards and procedures listed in Section 1.1. Environmental conditions were set at the appropriate temperature and thermal balance was checked with a thermocouple based probe. Duty cycle is reported for all relevant modes of operation. The test equipment employed includes HP8593E1, HPE4402B, UMDIP1.

Measurement Results The details and results of testing the EUT are summarized in Table 3. Plots showing the measurements made to obtain these values are provided in Figure 5.

Table 3: Fundamental Emission Pulsed Operation.

The EUT is capable of three encodings. The RKE mode (activated by button press on the EUT) consists of repeated FSK frames, which alternate channels after each pair of frames (i.e. CH1 x 2 frames, CH 2 x 2 frames, etc....). Each frame is 52.5 ms long in the worst case, with a frame period of 100.5ms. The PE mode (activated by LF interrogation from the vehicle caused by lifting of door handle on automobile) consists of one 16.75 ms FSK frame. The PS modes (activated by LF interrogation from vehicle when fob is inside the vehicle and start button is pressed) consists of only a single FSK frame 36.0 ms in duration. Worst case duty is exhibited in RKE mode as computed below and is applied only to emissions above 1 GHz. No duty is applied to fundamental emission.

Duty Cycle Computation		Continental RKE; FCC/IC
1	RKE $KE_{ASK} = 52.5 \text{ ms} / 100 \text{ ms} = 0.525$ or -5.6 dB	
2	PE $KE_{FSK} = 16.75 \text{ ms} / 100 \text{ ms} = 0.168$ or -15.5 dB	
3	PS $KE_{FSK} = 36.0 \text{ ms} / 100 \text{ ms} = 0.360$ or -8.9 dB	

Meas. U of Mich.; 10/28/2015

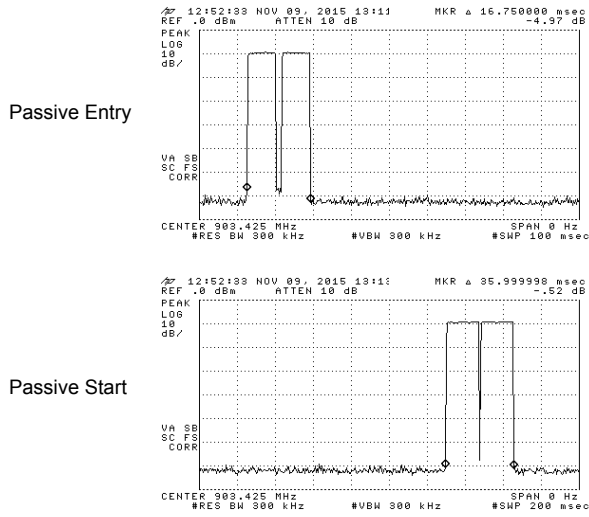

RKE (MANUAL BUTTON PRESS)

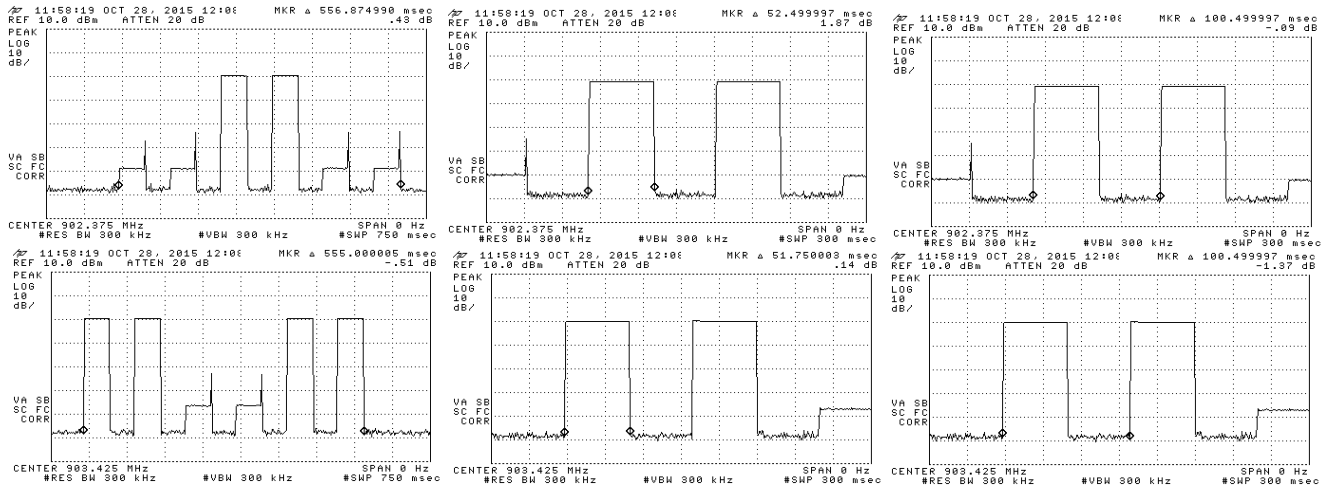

Figure 5: Fundamental Emission Pulsed Operation.

3.2.2 Fundamental Emission Bandwidth

Test Setup & Procedure The test equipment and facilities were setup in accordance with the standards and procedures listed in Section 1.1. Environmental conditions were set at the appropriate temperature and thermal balance was checked with a thermocouple based probe. Emission bandwidth (EBW) of the EUT is measured with the device placed in the test mode(s) with the shortest available frame length and minimum frame spacing. The 20 dB EBW is measured as the max-held peak-detected signal when the IF bandwidth is greater than or equal to 1% of the receiver span. For complex modulations other than ASK and FSK, the 99% emission bandwidth per IC test procedures has a different result, and is also reported. The test equipment employed includes HP8593E1, UMDIP1.

Measurement Results The details and results of testing the EUT are summarized in Table 4. Plots showing the measurements made to obtain these values are provided in Figure 6.

Table 4: Fundamental Emission Bandwidth.

The emission bandwidth of the signal is shown in the following Figure.

Measured Emission Bandwidth				Continental RKE; FCC/IC			
#	Modulation	Frequency / Channel (MHz)	EBW meas. (kHz)				
1	FSK	902.375	65.0				
2	FSK	903.425	63.0				

Meas. U of Mich.; 10/28/2015

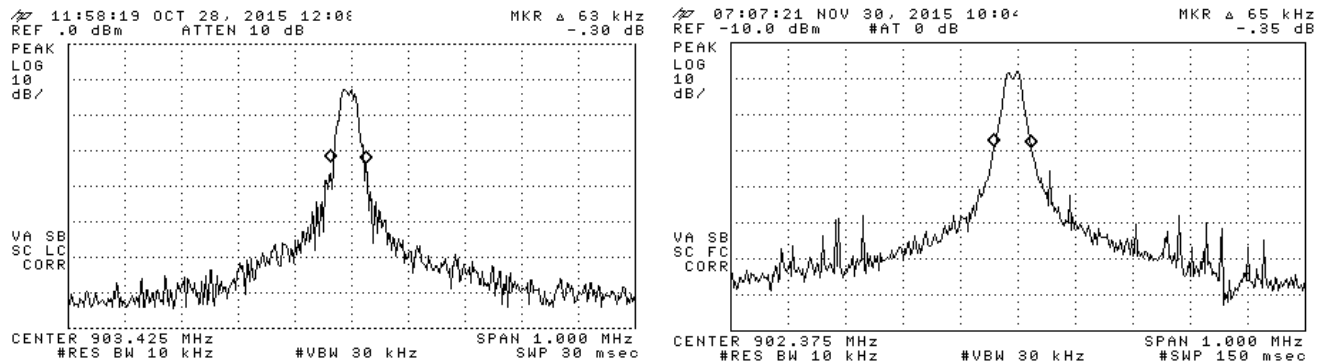

Figure 6: Fundamental Emission Bandwidth.

3.2.3 Fundamental Emission Field Strength

Test Setup & Procedure The test equipment and facilities were setup in accordance with the standards and procedures listed in Section 1.1. Environmental conditions were set at the appropriate temperature and thermal balance was checked with a thermocouple based probe. Fundamental emissions are measured at the regulatory distance on our OATS. The test equipment employed includes HP8593E1, UMDIP1.

Measurement Results The details and results of testing the EUT are summarized in Table 5.

Table 5: Fundamental Emission Field Strength.

Frequency Range	Det	IF Bandwidth	Video Bandwidth
25 MHz f 1 000 MHz	Pk/QPk	120 kHz	300 kHz
f > 1 000 MHz	Pk	1 MHz	3 MHz
f > 1 000 MHz	Avg	1 MHz	10kHz

Fundamental Radiated Emission											Continental RKE; FCC/IC	
#	Freq. MHz	Ant. Used	Ant. Pol.	Pr dBm	Det. Used	Ka dB/m	Kg dB	E3 (Pk) dBµV/m	E3lim dBµV/m	Pass dB	Comments	
1	Channel 2											
2	902.375	Dip	H	-14.3	Pk	28.3	28.7	92.3	94.0	1.7	flat	w/key
3	902.375	Dip	V	-19.1	Pk	28.3	28.7	87.5	94.0	6.5	end	w/key
5	902.375	Dip	H	-21.9	Pk	28.3	28.7	84.7	94.0	9.3	flat	w/o key
6	902.375	Dip	V	-26.7	Pk	28.3	28.7	79.9	94.0	14.1	end	w/o key
7	Channel 1											
8	903.425	Dip	H	-14.0	Pk	28.3	28.7	92.6	94.0	1.4	flat	w/key
9	903.425	Dip	V	-16.8	Pk	28.3	28.7	89.8	94.0	4.2	end	w/key
10	903.425	Dip	H	-21.6	Pk	28.3	28.7	85.0	94.0	9.0	flat	w/o key
11	903.425	Dip	V	-24.4	Pk	28.3	28.7	82.2	94.0	11.8	end	w/o key
12												
13												
14												

Meas. U of Mich.; 10/28/2015

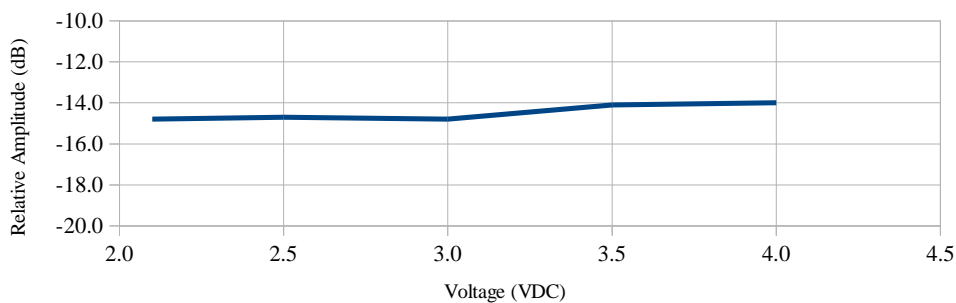

3.3 Unintentional Emissions

3.3.1 Transmit Chain Spurious Emissions

Test Setup & Procedure The test equipment and facilities were setup in accordance with the standards and procedures listed in Section 1.1. Environmental conditions were set at the appropriate temperature and thermal balance was checked with a thermocouple based probe. Spurious radiated emissions measurements are performed to 10 times the highest fundamental operating frequency. The test equipment employed includes HP8593E1, UMDIP1, UMRH1.

Measurement Results The details and results of testing the EUT are summarized in Table 6.

Table 6: Transmit Chain Spurious Emissions.

Tx Spurious Emissions											Continental RKE; FCC/IC	
#	Freq. MHz	Ant. Used	Ant. Pol.	Pr dBm	Det. Used	Ka dB/m	Kg dB	E3* dBµV/m	E3lim dBµV/m	Pass dB	Comments	
1	Band Edges (Max Held – All Channels)											
2	902.0	Dip	H	-70.9	Pk	28.3	28.8	35.7	46.0	10.3	max all	
3	928.0	Dip	H	-84.1	Pk	28.6	28.5	23.0	46.0	23.0	max all	
4												
5	Channel 2											
6	1804.8	RHorn	H	-47.5	Pk	22.1	28.1	47.9	54.0	6.1	side PV-9F-022	
7	2707.1	RHorn	H	-64.1	Pk	24.7	25.3	36.7	54.0	17.3	flat	
8	3609.5	RHorn	H	-60.7	Pk	27.3	23.1	44.9	54.0	9.1	max all	
9	4511.9	CHorn	H	-54.1	Pk	24.5	33.0	38.9	54.0	15.1	max all	
10	5414.3	CHorn	H	-46.2	Pk	24.7	38.0	41.9	54.0	12.1	max all	
11	6316.6	XnHorn	H	-44.0	Pk	24.4	38.0	43.8	54.0	10.2	max all	
12	7219.0	XnHorn	H	-44.9	Pk	25.1	36.8	44.8	54.0	9.2	max all	
13	8121.4	XHorn	H	-46.9	Pk	27.0	36.8	44.7	54.0	9.3	max all	
14	9023.8	XHorn	H	-56.4	Pk	27.5	36.8	35.7	54.0	18.3	max all	
15	Channel 1											
16	1806.9	RHorn	H	-47.5	Pk	22.1	28.1	47.9	54.0	6.1	side PV-9F-022	
17	2710.3	RHorn	H	-60.5	Pk	24.7	25.3	40.3	54.0	13.7	end	
18	3613.7	RHorn	H	-58.4	Pk	27.4	23.1	47.2	54.0	6.8	side	
19	4517.1	CHorn	H	-52.7	Pk	24.5	33.0	40.2	54.0	13.8	max all	
20	5420.6	CHorn	H	-46.2	Pk	24.7	38.0	41.9	54.0	12.1	max all	
21	6324.0	XnHorn	H	-45.5	Pk	24.4	38.0	42.3	54.0	11.7	max all	
22	7227.4	XnHorn	H	-43.4	Pk	25.1	36.8	46.3	54.0	7.7	max all	
23	8130.8	XHorn	H	-46.3	Pk	27.0	36.8	45.3	54.0	8.7	max all	
24	9034.3	XHorn	H	-54.5	Pk	27.5	36.8	37.6	54.0	16.4	max all	
25												
26					* Includes	5.6	dB Duty Cycle above 1000 MHz					
27												

Meas. U of Mich.; 10/28/2015

3.3.2 Radiated Receiver Spurious

The results for the measurement of radiated receiver spurious emissions (emissions from the receiver chain, e.g. LO or VCO) at the nominal voltage and temperature are reported in Table 7. Receive chain emissions are measured to 5 times the highest receive chain frequency employed or 4 GHz, whichever is higher. If no emissions are detected, only those noise floor emissions at the LO/VCO frequency are reported.

Table 7: Receiver Chain Spurious Emissions \geq 30 MHz.

Frequency Range	Det	IF Bandwidth	Video Bandwidth
25 MHz f 1 000 MHz	Pk/QPk	120 kHz	300 kHz
f > 1 000 MHz	Pk	1 MHz	3 MHz
f > 1 000 MHz	Avg	1 MHz	10kHz

F

Rx Spurious Emissions											Continental RKE; FCC/IC
#	Freq. MHz	Ant. Used	Ant. Pol.	Pr dBm	Det. Used	Ka dB/m	Kg dB	E3* dB μ V/m	E3lim dB μ V/m	Pass dB	Comments
1	902.7	Dip	H	-83.7	QP	28.3	28.7	22.9	46.0	23.1	Rx, LO, noise
2	903.8	Dip	V	-84.7	QP	28.3	28.7	21.9	46.0	24.1	Rx, LO, noise
3	1805.6	RHorn	H	-77.8	Ave	22.1	28.1	23.2	54.0	30.8	2x LO, both Rx, noise
4	2708.4	RHorn	H	-77.7	Ave	24.7	25.3	28.7	54.0	25.3	3x LO, both Rx, noise
5	3611.2	RHorn	H	-74.5	Ave	27.4	23.1	36.7	54.0	17.3	4x LO, both Rx, noise
6	4514.0	RHorn	H	-74.8	Ave	30.0	16.0	46.2	54.0	7.8	5x LO, both Rx, noise
7											
8											
9											
10											
11											
12											

Meas. U of Mich.; 10/28/2015

3.3.3 Radiated Digital Spurious

The results for the measurement of digital spurious emissions are not reported herein as all digital emissions were greater than 20 dB below the regulatory limit. Radiation from digital components was measured to 4 GHz, or to five times the maximum digital component operating frequency, whichever is greater.