



The University of Michigan Radiation Laboratory
3228 EECS Building
Ann Arbor, Michigan 48109-2122 USA
Tel: (734) 483-4211
Fax: (734) 647-2106
e-mail: liepa@umich.edu

Testing of
Electromagnetic Emissions
per

USA: CFR Title 47, Part 15.231
Canada: IC RSS-210/GENe

are herein reported for

Continental Automotive Systems US Inc.
M3N-95894600

Test Report No.: 417124-150317-01
Copyright © 2015

Applicant/Provider:
Continental Automotive Systems US Inc.
2400 Executive Hills Drive, Auburn Hills Michigan 48326-2980 USA
Phone: +1 (248) 764-6522, Fax: +1 (248) 764-7281
Contact Person: David Reimus; David.James.Reimus@continental-corporation.com

Measured by: [Signature] Report Approved by: [Signature]
Dr. Valdis V. Liepa Dr. Valdis V. Liepa
Report by: [Signature] Report Date of Issue: March 17, 2015
Dr. Valdis V. Liepa

Results of testing completed on (or before) March 9, 2015 are as follows.

Emissions: The transmitter intentional emissions COMPLY with the regulatory limit(s) by no less than 2.6 dB.
Transmit chain spurious harmonic emissions COMPLY by no less than 16.5 dB.

Contents

1	Test Specifications, General Procedures, and Location	4
1.1	Test Specification and General Procedures	4
1.2	Test Location and Equipment Used	5
2	Configuration and Identification of the Equipment Under Test	6
2.1	Description and Declarations	6
2.1.1	EUT Configuration	6
2.1.2	Modes of Operation	6
2.1.3	Variants	7
2.1.4	Test Samples	7
2.1.5	Functional Exerciser	7
2.1.6	Modifications Made	7
2.1.7	Production Intent	7
2.1.8	Declared Exemptions and Additional Product Notes	7
3	Emissions	8
3.1	General Test Procedures	8
3.1.1	Radiated Test Setup and Procedures	8
3.1.2	Conducted Emissions Test Setup and Procedures	10
3.1.3	Power Supply Variation	10
3.2	Intentional Emissions	11
3.2.1	Fundamental Emission Pulsed Operation	11
3.2.2	Fundamental Emission Bandwidth	15
3.2.3	Fundamental Emission Field Strength	16
3.3	Unintentional Emissions	17
3.3.1	Transmit Chain Spurious Emissions	17

List of Tables

1	The University of Michigan Radiation Laboratory Equipment List	5
2	EUT Declarations.	6
3	Fundamental Emission Pulsed Operation.	11
4	Fundamental Emission Bandwidth.	15
5	Fundamental Emission Field Strength.	16
6	Transmit Chain Spurious Emissions.	17

List of Figures

1	Photos of EUT.	6
2	EUT Test Configuration Diagram.	7
3	Radiated Emissions Diagram of the EUT.	8
4	Radiated Emissions Test Setup Photograph(s).	9
5	Fundamental Emission Pulsed Operation.	12
5	Fundamental Emission Pulsed Operation.	13
5	Fundamental Emission Pulsed Operation.	14
6	Fundamental Emission Bandwidth.	15

1 Test Specifications, General Procedures, and Location

1.1 Test Specification and General Procedures

The ultimate goal of Continental Automotive Systems US Inc. is to demonstrate that the Equipment Under Test (EUT) complies with the Rules and/or Directives below. Detailed in this report are the results of testing the Continental Automotive Systems US Inc. M3N-95894600 for compliance to:

Country/Region	Rules or Directive	Referenced Section(s)
United States	Code of Federal Regulations	CFR Title 47, Part 15.231
Canada	Industry Canada	IC RSS-210/GENe

Continental Automotive Systems US Inc. has determined that the equipment under test is subject to the rules and directives above at the date of this testing. In conjunction with these rules and directives, the following specifications and procedures are followed herein to demonstrate compliance (in whole or in part) with these regulations.

ANSI C63.4:2009	"Methods of Measurement of Radio-Noise Emissions from Low-Voltage Electrical and Electronic Equipment in the Range of 9 kHz to 40 GHz"
Industry Canada	"The Measurement of Occupied Bandwidth"

1.2 Test Location and Equipment Used

Test Location The EUT was fully tested by **The University of Michigan Radiation Laboratory**, 3228 EECS Building, Ann Arbor, Michigan 48109-2122 USA. The Test Facility description and attenuation characteristics are on file with the FCC Laboratory, Columbia, Maryland (FCC Reg. No: 91050) and with Industry Canada, Ottawa, ON (File Ref. No: IC 2057A-1).

Test Equipment Pertinent test equipment used for measurements at this facility is listed in Table 1. The quality system employed at The University of Michigan Radiation Laboratory has been established to ensure all equipment has a clearly identifiable classification, calibration expiry date, and that all calibrations are traceable to the SI through NIST, other recognized national laboratories, accepted fundamental or natural physical constants, ratio type of calibration, or by comparison to consensus standards.

Table 1: The University of Michigan Radiation Laboratory Equipment List

Description	Manufacturer/Model	SN	Quality Num.	Last Cal By / Date Due
Spectrum Analyzer	Rhode-Schwarz / FSU8	106492	RSFSU8001	RS / Dec-2015
Spectrum Analyzer	Hewlett Packard / 8593E	3412A01131	HP8593E1	Agilent / Jul-2015
Spectrum Analyzer	Tektronix / RSA3308B	B020233	TKRSA3308B1	Tek / Sep-2014
Dipole Set (20-1000 MHz)	UM / RLDP	RLDP-1,- 2,-3	UMDIP1	UM / Jul-2015
Ridge-Horn Antenna	Univ. of Michigan / VVL	5	UMRH1	UM / Jul-2015

2 Configuration and Identification of the Equipment Under Test

2.1 Description and Declarations

The equipment under test is an automotive Tire Pressure Measurement (TPM) transmitter. The EUT is approximately 2.5 x 5 x 1 cm (approx.) in dimension, and is depicted in Figure 1. It is powered by a 3 VDC Lithium cell battery. In use, this device is permanently affixed inside the tire of a motor vehicle. Table 2 outlines provider declared EUT specifications.



Figure 1: Photos of EUT.

Table 2: EUT Declarations.

General Declarations			
Equipment Type:	TPM Transmitter	Country of Origin:	USA
Nominal Supply:	3 VDC	Oper. Temp Range:	Not Declared
Frequency Range:	315 MHz	Antenna Dimension:	Not Declared
Antenna Type:	metal loop	Antenna Gain:	-27 dBi (approx)
Number of Channels:	1	Channel Spacing:	Not Applicable
Alignment Range:	Not Declared	Type of Modulation:	ASK and FSK
United States			
FCC ID Number:	M3N-95894600	Classification:	DSC
Canada			
IC Number:	7812A-95894600	Classification:	Remote Control Device, Vehicular Device

2.1.1 EUT Configuration

The EUT is configured for testing as depicted in Figure 2.

2.1.2 Modes of Operation

The DUT periodically transmits tire pressure data when in motion (DRIVE mode) or when a slow decrease in pressure is detected (DN mode). The device is also capable of being automatically actuated (via LF interrogation) during servicing (LEARN mode) or by LF coils within the vehicle while driving (LF DRIVE mode). Finally, the DUT can be manually actuated when the end user adds air to the tire (DP mode). Over all five (5) modes employed, the DUT transmits nine (9) unique ASK and FSK frames (protocols), each employing different data rates.

In the periodic DRIVE mode, frames are repeated and spread over 3 transmissions (bursts). In the periodic DN mode, the DUT transmits the same frames mixed into 4 repeated bursts.

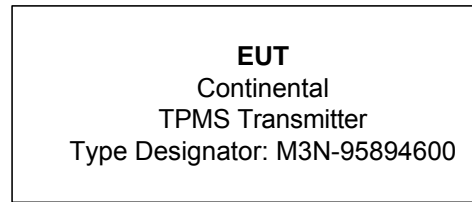

Figure 2: EUT Test Configuration Diagram.

In manually actuated LEARN mode the DUT responds to encoded LF interrogation with a single transmission (burst) containing 97 frames in less than 5 seconds. In LF DRIVE mode there is only a single burst which contains 8 frames in response to an encoded LF interrogation. In manually activated DP mode, the DUT transmits the same frames mixed over 5 transmissions and repeated until the pressure in the tire stops rising (manual stimulus is removed).

To demonstrate compliance, the maximum on-time encoding in any given 100 ms window was identified and used to compute worst-case duty cycle. Emission bandwidth is measured by max-holding the spectrum over all transmitted encodings. Per FCC correspondence, service modes fall under FCC part 15.231(a)(5). Plots included in the duty cycle section of this report demonstrate compliance with both 15.231(a)(2) and (5). A detailed list of all operating modes is included in the Description of Operation exhibit, a portion of which is held confidential due to its proprietary nature.

2.1.3 Variants

There is only a single variant of the EUT.

2.1.4 Test Samples

Three samples in total were provided. One sample programmed for CW transmission and one normal operating sample capable of manually activated transmissions via LF interrogation, and one sample un-potted for testing and photographs.

2.1.5 Functional Exerciser

Normal operating EUT functionality was verified by observation of transmitted signal.

2.1.6 Modifications Made

There were no modifications made to the EUT by this laboratory.

2.1.7 Production Intent

The EUT appears to be a production ready sample.

2.1.8 Declared Exemptions and Additional Product Notes

The EUT is permanently installed in a transportation vehicle. As such, digital emissions are exempt from US and Canadian digital emissions regulations (per FCC 15.103(a) and IC correspondence on ICES-003).

The EUT also employs some modes of operation that alert the vehicle user of sudden changes in tire pressure. Such alert modes fall under FCC 15.231(a)(4), and may operate during the pendency of the alarm condition. A detailed list of all operating modes is included in the Description of Operation exhibit included in this application.

3 Emissions

3.1 General Test Procedures

3.1.1 Radiated Test Setup and Procedures

Radiated electromagnetic emissions from the EUT are first pre-scanned in our shielded anechoic chamber. Spectrum and modulation characteristics of all emissions are recorded. Instrumentation, including spectrum analyzers and other test equipment as detailed in Section 1.2 are employed. After indoor pre-scans, emission measurements are made on our outdoor 3-meter Open Area Test Site (OATS). If the EUT connects to auxiliary equipment and is table or floor standing, the configurations prescribed in relevant test standards are followed. Alternatively, a layout closest to normal use (as declared by the provider) is employed if the resulting emissions appear to be worst-case in such a configuration. See Figure 3. All intentionally radiating elements that are not fixed-mounted in use are placed on the test table lying flat, on their side, and on their end (3-axes) and the resulting worst case emissions are recorded. If the EUT is fixed-mounted in use, measurements are made with the device oriented in the manner consistent with installation and then emissions are recorded.

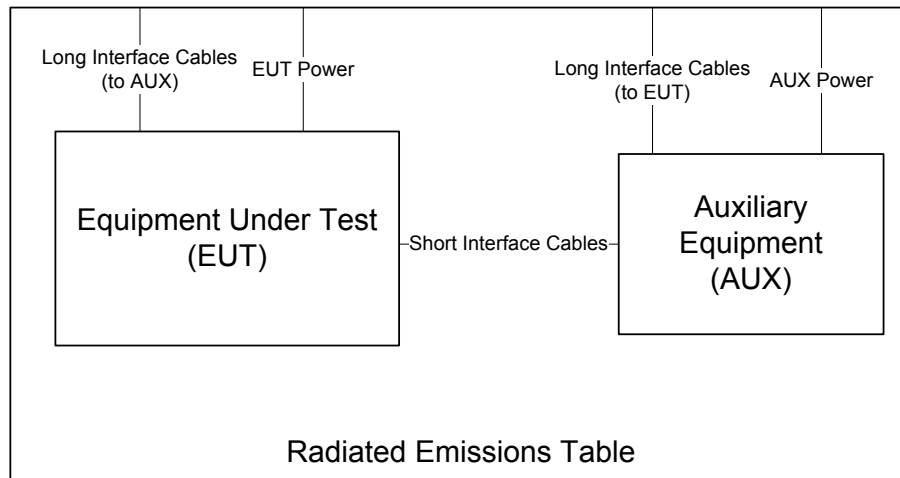

Figure 3: Radiated Emissions Diagram of the EUT.

If the EUT exhibits spurious emissions due to internal receiver circuitry, such emissions are measured with an appropriate carrier signal applied. For devices with intentional emissions below 30 MHz, a shielded loop antenna is used. It is placed at a 1 meter receive height. Emissions between 30 MHz and 1 GHz are measured using tuned dipoles and/or calibrated broadband antennas. For both horizontal and vertical polarizations, the test antenna is raised and lowered from 1 to 4 m in height until a maximum emission level is detected. The EUT is then rotated through 360° in azimuth until the highest emission is detected. The test antenna is then raised and lowered one last time from 1 to 4 m and the worst case value is recorded. Emissions above 1 GHz are characterized using standard gain horn antennas or calibrated broadband ridge-horn antennas on our OATS with a 2.4m x 2.4m square of AN-79 or H-4 absorber placed over the ground screen between the EUT and the test antenna. Care is taken to ensure that test receiver resolution and video bandwidths meet the regulatory requirements, and that the emission bandwidth of the EUT is not reduced. Photographs of the test setup employed are depicted in Figure 4.

Where regulations allow for direct measurement of field strength, power values (dBm) measured on the test receiver / analyzer are converted to dBμV/m at the regulatory distance, using

$$E_{dist} = 107 + P_R + K_A - K_G + K_E - C_F$$

where P_R is the power recorded on spectrum analyzer, in dBm, K_A is the test antenna factor in dB/m, K_G is the combined pre-amplifier gain and cable loss in dB, K_E is duty correction factor (when applicable) in dB, and C_F is a distance conversion (employed only if limits are specified at alternate distance) in dB. This field strength value is then compared with the regulatory limit. If effective isotropic radiated power (EIRP) is computed, it is computed as

$$EIRP(dBm) = E_{3m}(dB\mu V/m) - 95.2.$$

When presenting data at each frequency, the highest measured emission under all possible EUT orientations (3-axes) is reported.



Figure 4: Radiated Emissions Test Setup Photograph(s).

3.1.2 Conducted Emissions Test Setup and Procedures

Battery Power Conducted Spurious The EUT is not subject to measurement of power line conducted emissions as it is powered solely by its internal battery.

3.1.3 Power Supply Variation

Tests at extreme supply voltages are made if required by the the procedures specified in the test standard, and results of this testing are detailed in this report.

In the case the EUT is designed for operation from a battery power source, the extreme test voltages are evaluated over the range specified in the test standard; no less than $\pm 10\%$ of the nominal battery voltage declared by the manufacturer. For all battery operated equipment, worst case intentional and spurious emissions are re-checked employing a new (fully charged) battery.

3.2 Intentional Emissions

3.2.1 Fundamental Emission Pulsed Operation

Test Setup & Procedure The test equipment and facilities were setup in accordance with the standards and procedures listed in Section 1.1. Environmental conditions were set at the appropriate temperature and thermal balance was checked with a thermocouple based probe. Duty cycle is reported for all relevant modes of operation. The test equipment employed includes HP8593E1, UMDIP1.

Measurement Results The details and results of testing the EUT are summarized in Table 3. Plots showing the measurements made to obtain these values are provided in Figure 5.

Table 3: Fundamental Emission Pulsed Operation.

Over all five (5) operating modes, the DUT can, in the worst case, transmit one 10.1 ms long Protocol 3 FSK frame followed by two 8.33 ms long Protocol 1 FSK frames within a 100 ms window, as measured. All other combinations of protocols employed in each transmission result in a lower duty cycle as detailed in the manufacturer provided description of modes of operation for the device. The resulting duty cycle is computed in the table below. In the Figure that follows, (a) demonstrates compliance with PERIODIC transmission regulations, (b) depicts the worst case Duty Cycle transmissions, and (c) demonstrates compliance with MANUALLY ACTIVATED (LF actuated) transmission regulations for DP mode and LEARN modes (respectively).

Duty Cycle Computation		CONTI; FCC/IC					
1	KE = (10.1 ms + 2 x 8.2 ms) / 100 ms = 0.265 or -11.5 dB						
2							

Meas. U of Mich.; 2/17/2015

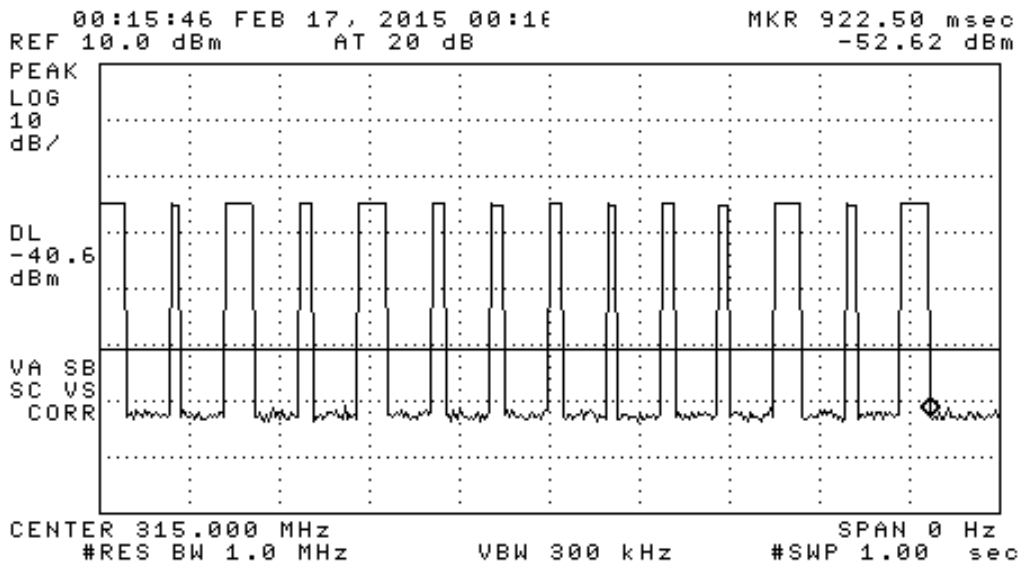
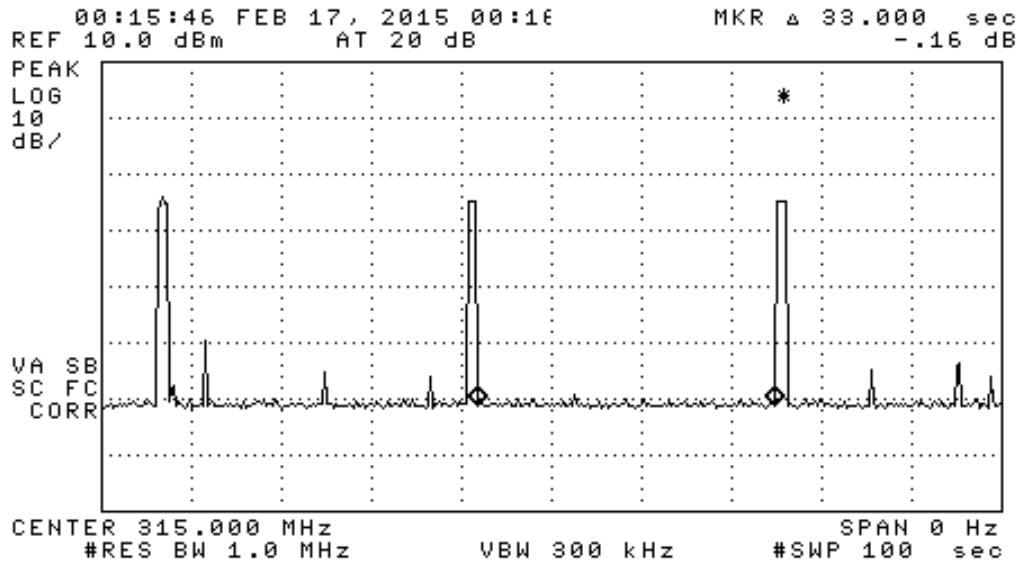
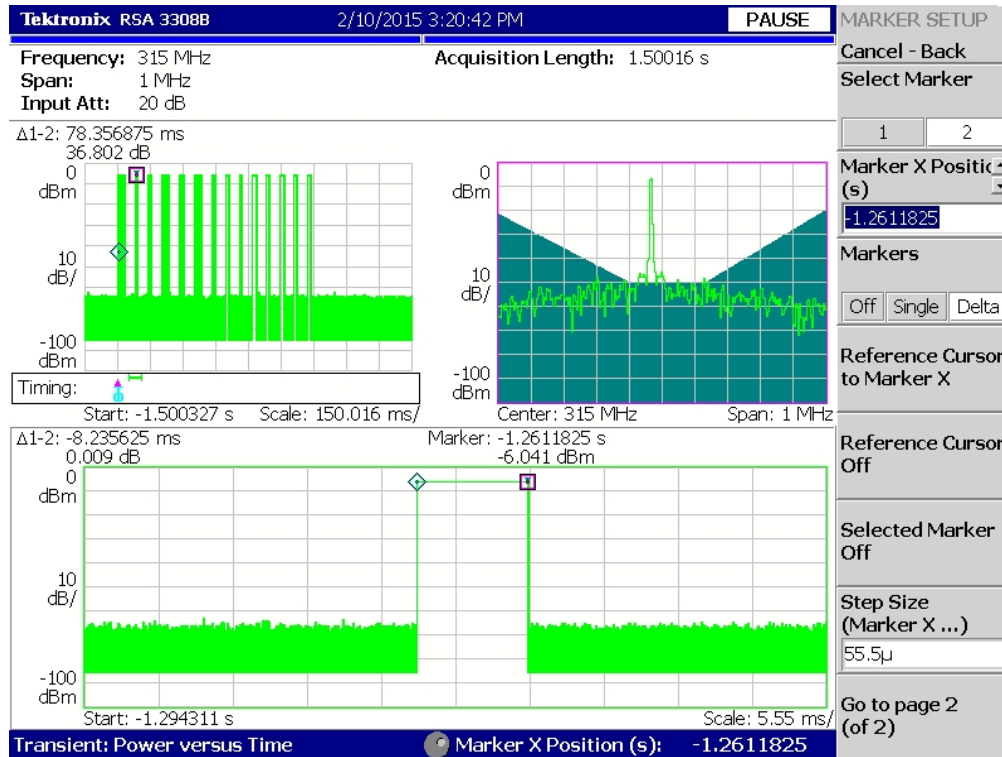
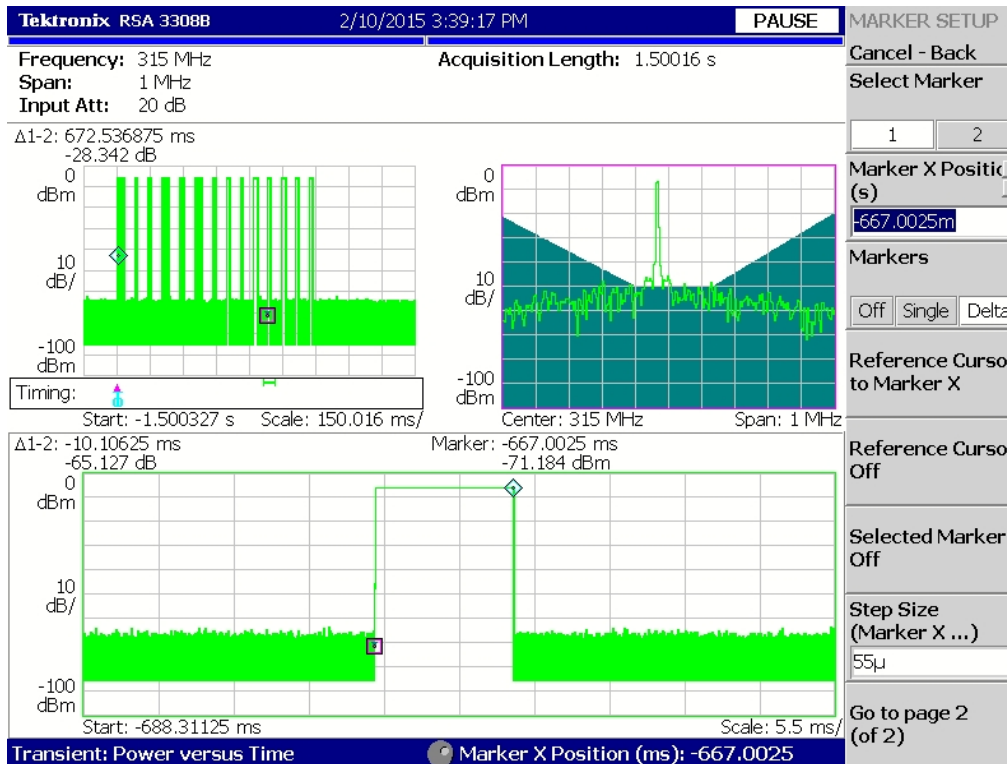

Figure 5(a): Fundamental Emission Pulsed Operation.



PROTOCOL 1 (FSK)



PROTOCOL 3 (FSK)

Figure 5(b): Fundamental Emission Pulsed Operation.

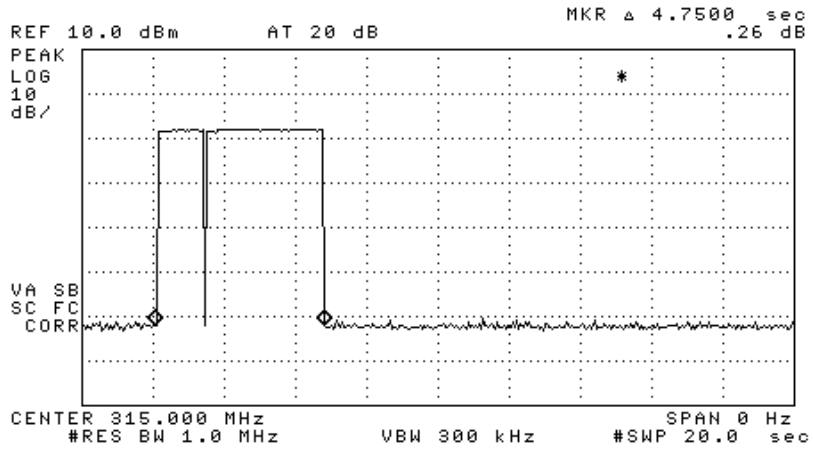
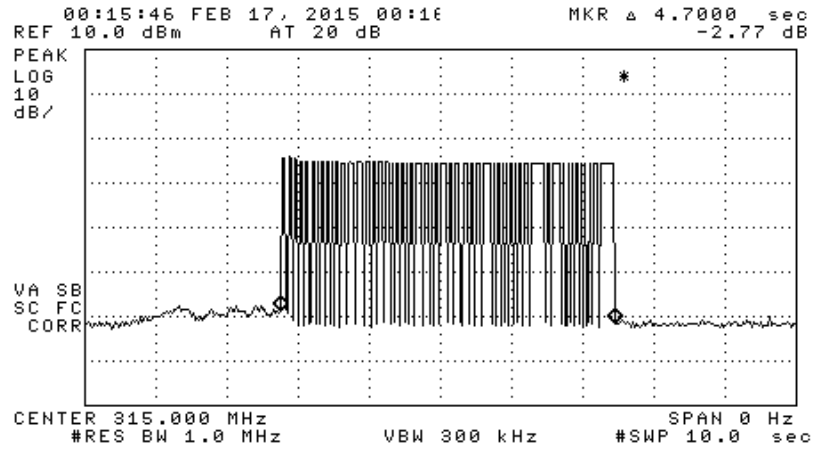

Figure 5(c): Fundamental Emission Pulsed Operation.

3.2.2 Fundamental Emission Bandwidth

Test Setup & Procedure The test equipment and facilities were setup in accordance with the standards and procedures listed in Section 1.1. Environmental conditions were set at the appropriate temperature and thermal balance was checked with a thermocouple based probe. Emission bandwidth (EBW) of the EUT is measured with the device placed in the test mode(s) with the shortest available frame length and minimum frame spacing. The 20 dB EBW is measured as the max-held peak-detected signal when the IF bandwidth is greater than or equal to 1% of the receiver span. For complex modulations other than ASK and FSK, the 99% emission bandwidth per IC test procedures has a different result, and is also reported. The test equipment employed includes RSFSU8001, UMDIP1.

Measurement Results The details and results of testing the EUT are summarized in Table 4. Plots showing the measurements made to obtain these values are provided in Figure 6.

Table 4: Fundamental Emission Bandwidth.

The emission bandwidth of the signal is shown in the following Figure. The allowed 99% bandwidth is 0.25% of 315 MHz, or 787.25 kHz.

Measured Emission Bandwidth					CONTI; FCC/IC		
#	EBW meas. (kHz)						
1	115.9						

Meas. U of Mich.; 2/17/2015



Figure 6: Fundamental Emission Bandwidth.

3.2.3 Fundamental Emission Field Strength

Test Setup & Procedure The test equipment and facilities were setup in accordance with the standards and procedures listed in Section 1.1. Environmental conditions were set at the appropriate temperature and thermal balance was checked with a thermocouple based probe. Fundamental emissions are measured at the regulatory distance on our OATS. The test equipment employed includes HP8593E1, UMDIP1.

Measurement Results The details and results of testing the EUT are summarized in Table 5.

Table 5: Fundamental Emission Field Strength.

Frequency Range	Det	IF Bandwidth	Video Bandwidth
25 MHz ≤ f ≤ 1 000 MHz	Pk/QPk	120 kHz	300 kHz
f > 1 000 MHz	Pk	1 MHz	3 MHz
f > 1 000 MHz	Avg	1 MHz	10kHz

Fundamental Radiated Emission											CONTI; FCC/IC
#	Freq. MHz	Ant. Used	Ant. Pol.	Pr dBm	Det. Used	Ka dB/m	Kg dB	E3* dBμV/m	E3lim dBμV/m	Pass dB	Comments
1	315.0	Dip	H	-26.3	Pk	18.6	22.7	65.1	67.7	2.6	side
2	315.0	Dip	V	-29.0	Pk	18.6	22.7	62.4	67.7	5.3	end
3											
4											
5											
6											
7											
8	* Includes 11.5 dB Duty Cycle										
9											

Meas. U of Mich.; 2/17/2015

Fundamental Emission vs. Supply Voltage

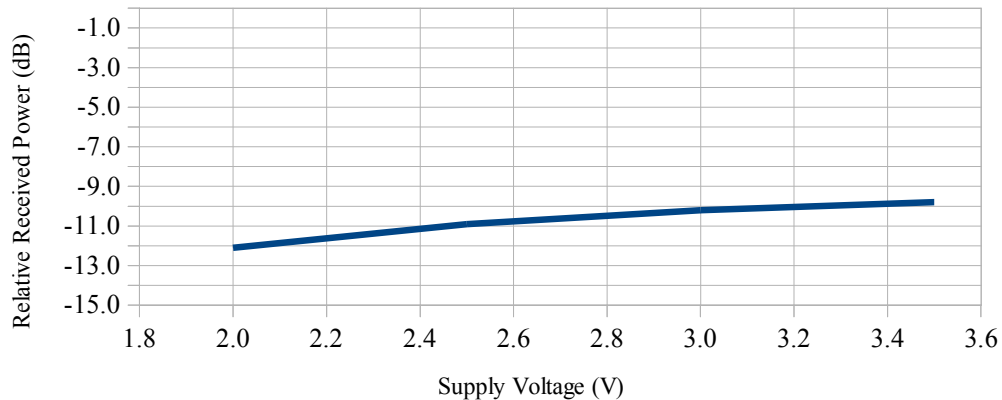

3.3 Unintentional Emissions

3.3.1 Transmit Chain Spurious Emissions

Test Setup & Procedure The test equipment and facilities were setup in accordance with the standards and procedures listed in Section 1.1. Environmental conditions were set at the appropriate temperature and thermal balance was checked with a thermocouple based probe. Spurious radiated emissions measurements are performed to 10 times the highest fundamental operating frequency. The test equipment employed includes HP8593E1, UMDIP1, UMRH1.

Measurement Results The details and results of testing the EUT are summarized in Table 6.

Table 6: Transmit Chain Spurious Emissions.

Frequency Range	Det	IF Bandwidth	Video Bandwidth
25 MHz \leq f \leq 1 000 MHz	Pk/QPk	120 kHz	300 kHz
f > 1 000 MHz	Pk	1 MHz	3 MHz
f > 1 000 MHz	Avg	1 MHz	10kHz

Spurious Radiated Emissions											CONTI; FCC/IC
#	Freq. MHz	Ant. Used	Ant. Pol.	Pr dBm	Det. Used	Ka dB/m	Kg dB	E3* dB μ V/m	E3lim dB μ V/m	Pass dB	Comments
1	630.0	Dip	H	-88.2	Pk	24.4	19.6	12.1	47.7	35.6	side
2	630.0	Dip	V	-87.7	Pk	24.4	19.6	12.6	47.7	35.1	flat
3	945.0	Dip	H	-75.5	Pk	28.8	17.6	31.2	47.7	16.5	side
4	945.0	Dip	V	-75.6	Pk	28.8	17.6	31.1	47.7	16.6	flat
5	1260.0	Horn	H	-62.5	Pk	20.6	28.1	25.5	54.0	28.5	end
6	1575.0	Horn	H	-61.2	Pk	21.5	28.1	27.7	54.0	26.3	flat
7	1890.0	Horn	H	-60.0	Pk	22.2	28.1	29.6	54.0	24.4	flat
8	2205.0	Horn	H	-59.9	Pk	23.0	26.5	32.1	54.0	21.9	end
9	2520.0	Horn	H	-64.9	Pk	23.9	26.0	28.5	54.0	25.5	side
10	2835.0	Horn	H	-64.2	Pk	24.8	24.7	31.4	54.0	22.6	side
11	3150.0	Horn	H	-71.7	Pk	25.8	23.6	26.0	54.0	28.0	flat
12											
13											
14	* Includes 11.5 dB Duty Cycle.										
15											

Meas. U of Mich.; 2/17/2015