



Registration No. DAT-P-207/05

FCC ID: LYHRAP-V1

EMI -- TEST REPORT

Test Report No. : T31960-00-10AA	February 27, 2008
	Date of issue

Type / Model Name : SCALANCE W788 / RAP Family

Product Description : Wireless-LAN-Accesspoint

Applicant : Siemens AG

Address : Östliche Rheinbrückenstr. 50
D-76187 Karlsruhe

Manufacturer : Siemens AG

Address : Östliche Rheinbrückenstr. 50
D-76187 Karlsruhe

Licence holder : Siemens AG

Address : Östliche Rheinbrückenstr. 50
D-76187 Karlsruhe

Test Result according to the standards listed in clause 1 test standards:	Positive
--	-----------------



The test report merely corresponds to the test sample. It is not permitted to copy extracts of these test results without the written permission of the test laboratory.

Contents

1	<u>TEST STANDARDS</u>	3
2	<u>SUMMARY</u>	4
3	<u>EQUIPMENT UNDER TEST</u>	7
3.1	PHOTO DOCUMENTATION OF THE EUT – DETAILED PHOTOS SEE ATTACHMENT A AND B	7
3.2	POWER SUPPLY SYSTEM UTILISED	7
3.3	TEST SETUP	7
3.4	SHORT DESCRIPTION OF THE EQUIPMENT UNDER TEST (EUT)	8
4	<u>TEST ENVIRONMENT</u>	9
4.1	ADDRESS OF THE TEST LABORATORY	9
4.2	ENVIRONMENTAL CONDITIONS	9
4.3	STATEMENT OF THE MEASUREMENT UNCERTAINTY	9
4.4	MEASUREMENT PROTOCOL FOR FCC, VCCI AND AUSTEL	10
5	<u>TEST CONDITIONS AND RESULTS</u>	11
5.1	CONDUCTED EMISSIONS	11
5.2	26 dB EMISSION BANDWIDTH	15
5.3	MAXIMUM CONDUCTED OUTPUT POWER	19
5.4	UNDISERABLE EMISSIONS	21
5.5	PEAK POWER SPECTRAL DENSITY	32
5.6	PEAK EXCURSION	35
5.7	MAXIMUM PERMISSIBLE EXPOSURE (MPE)	39
5.8	ANTENNA APPLICATION	42
5.9	RECEIVER SPURIOUS EMISSIONS	43
6	<u>USED TEST EQUIPMENT AND ACCESSORIES</u>	47

1 TEST STANDARDS

The tests were performed according to following standards:

FCC Rules and Regulations Part 15 Subpart C - Intentional Radiators (May, 2007)

Part 15, Subpart C, Section 15.35(c)	Correction for Pulse Operation (Duty Cycle)
Part 15, Subpart C, Section 15.203	Antenna requirement
Part 15, Subpart C, Section 15.204	External radio frequency power amplifiers and antenna modifications
Part 15, Subpart C, Section 15.207(a)	AC Line conducted emissions
Part 15, Subpart C, Section 15.209(a)	Radiated emissions, general requirements
Part 15, Subpart C, Section 15.407	Operation within the bands 5.15-5.25 GHz, 5.25-5.35 GHz, 5.47-5.725 GHz and 5.725-5.825 GHz

FCC Rules and Regulations Part 15 Subpart B - Unintentional Radiators (May, 2007)

Part 15, Subpart B, Section 15.107(a)	AC Line conducted emissions
Part 15, Subpart B, Section 15.109(a)	Radiated emissions, general requirements

FCC Rules and Regulations Part 1 Subpart I - Procedures Implementing the National Environmental Policy Act of 1969

Part 1, Subpart I, Section 1.1310	Radiofrequency radiation exposure limits.
-----------------------------------	---

OET Bulletin 65, 65A, 65B, 65C Edition 97-01, August 1997 – Evaluating Compliance with FCC Guidelines for Human Exposure to Radio Frequency Electromagnetic Fields.

2 SUMMARY

GENERAL REMARKS:

The EuT consists of maximal 2 identical WLAN miniPCI modules.

There are existing different variants with following applications:

Variant	Certification-Name	WLAN Modules	Ethernet	Antennas
V01	RAP-W1-RJ-E1	1	RJ45	2 x R-SMA
V02	RAP-W2-RJ-E2	2	RJ45	4 x R-SMA

Available Features:

The WLAN miniPCI modules are compatible with 802.11a, 802.11b, 802.11g and 802.11h technology. They are able to operate in the 2.4 GHz and 5 GHz frequency band.

- 802.11a Mode 5.15 GHz – 5.25 GHz amnd 5.725 GHz – 5.850 GHz
- 802.11b/g Mode 2400 MHz – 2483.5 MHz
- 802.11h Mode 5.15 GHz – 5.35 GHz and 5.47 GHz – 5.725 GHz

The modules use DSSS or OFDM modulation and are cabable to provide following data rates:

- 802.11b Mode 11, 5.5, 2, 1 Mbps, auto-fallback
- 802.11g Mode 54, 48, 36, 24, 18, 12, 9, 6 Mbps, auto-fallback
- 802.11g turbo Mode 108, 96, 72, 54, 48, 36, 24, 18, 12 Mbps, auto-fallback
- 802.11a/h 54, 48, 36, 24, 18, 12, 9, 6 Mbps, auto-fallback
- 802.11a/h turbo Mode 108, 96, 72, 54, 48, 36, 24, 18, 12 Mbps, auto-fallback

There are different external antennas provided, which are listed in following table:

Number	Characteristics	Certification name	Plug	Frequency (GHz)	Gain (dBi)
1	Omni	ANT795-6MN	N	2.4 / 5	6 / 8
2	Omni	ANT792-6MN	N	2.4	6
3	Omni	ANT793-6MN	N	5	6
4	Patch	ANT795-6DN	N	2.4 / 5	9 / 9
5	Directed	ANT792-8DN	N	2.4	14
6	Directed	ANT793-8DN	N	5	18
7	Helix	ANT792-4DN	N	2.4-2.485	4
8	λ 5/8	ANT793-4MN	N	5.15-5.875	6
9	R-Coax	IWLAN Rcoax PE 1/2" 2.4 GHz	N	2.4-2.485	0
10	R-Coax	IWLAN Rcoax PE 1/2" 5 GHz	N	5.15-5.875	0
11	Omni	ANT795-4MR	R-SMA	2.4 / 5	3 / 5

Note: The US version will be firmware limited to operate only in the 5150-5250 MHz band.

The tests have been carried out in the frequency band: 5.15-5.25 GHz.

Pre-scan has been performed to determine the worst-case mode from all possible combinations between available modulations, data rates and antenna ports. The maximum output power depends on used data rate.

As worst case the following data rates are used:

- **802.11a: 6 Mbits**

The EuT has been adjusted to transmit data during the tests with a duty cycle (X) of about X=1.

4 channels are provided to this EuT in 802.11a mode:

Channel	Frequency
36	5180
40	5200
44	5220
48	5240

Following channels were selected for the final test as listed below:

Technology	Available Channel	Tested Channel	Modulation	Modulation Type	Data Rate [Mbps]
802.11a	36 to 48	36 and 48	OFDM	BPSK	6

FINAL ASSESSMENT:

The equipment under test **fulfills** the EMI requirements cited in clause 1 test standards.

Date of receipt of test sample : acc. to storage records

Testing commenced on : November 12, 2007

Testing concluded on : February 26, 2008

Checked by:

Tested by:

Klaus Gegenfurtner
Dipl.-Ing.(FH)
Manager: Radio Group

Anton Altmann
Dipl.-Ing.(FH)

3 EQUIPMENT UNDER TEST

3.1 Photo documentation of the EuT – Detailed photos see Attachment A and B

3.2 Power supply system utilised

Power supply voltage : 24 V DC

3.3 Test setup

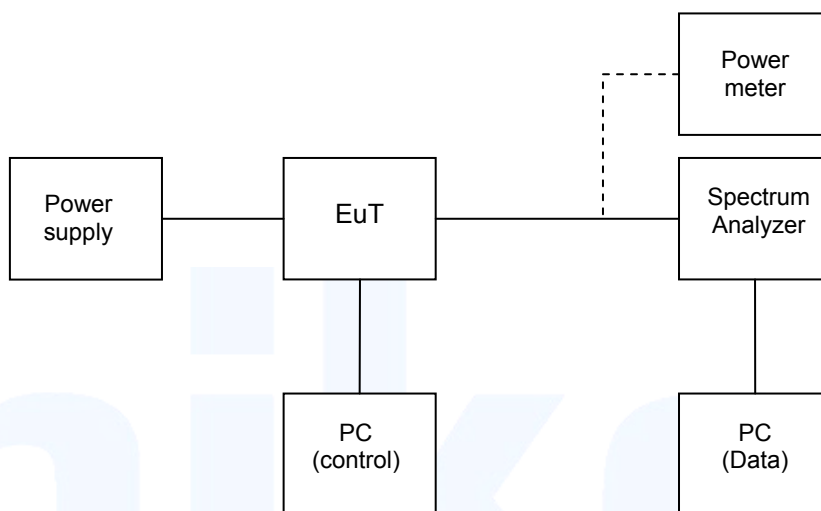

3.4 Short description of the Equipment under Test (EuT)

The EuT is an Industrial Outdoor Access Point (iOAP) with integrated WLAN-Mini PCI moduls operating in the 2.4 GHz and 5 GHz bands.

Number of tested samples: 1
Serial number: Prototype

EuT operation mode:

The equipment under test was operated during the measurement under the following conditions:

- Continuous transmit mode of 1 module

- Continuous receive mode of 1 module

EuT configuration:

(The CDF filled by the applicant can be viewed at the test laboratory.)

The following peripheral devices and interface cables were connected during the measurements:

- | | |
|-------------------------------|---------------|
| - DC Power supply 24 to 48VDC | Model : 6000A |
| - _____ | Model : _____ |
| - _____ | Model : _____ |
| - _____ | Model : _____ |
| - _____ | Model : _____ |
| - _____ | Model : _____ |

4 TEST ENVIRONMENT

4.1 Address of the test laboratory

mikes-testingpartners gmbh
Ohmstrasse 2-4
94342 Strasskirchen
Germany

4.2 Environmental conditions

During the measurement the environmental conditions were within the listed ranges:

Temperature: 15-35 ° C

Humidity: 30-60 %

Atmospheric pressure: 86-106 kPa

4.3 Statement of the measurement uncertainty

The data and results referenced in this document are true and accurate. The reader is cautioned that there may be errors within the calibration limits of the equipment and facilities. The measurement uncertainty was calculated for all measurements listed in this test report acc. to CISPR 16-4-2 /11.2003 „Uncertainties, statistics and limit modelling – Uncertainty in EMC measurements“ and is documented in the quality system acc. to DIN EN ISO/IEC 17025. Furthermore, component and process variability of devices similar to that tested may result in additional deviation. The manufacturer has the sole responsibility of continued compliance of the device.

4.4 Measurement Protocol for FCC, VCCI and AUSTEL

4.4.1 GENERAL INFORMATION

4.4.1.1 Test Methodology

Conducted and radiated disturbance testing is performed according to the procedures in International Special Committee on Radio Interference (CISPR) Publication 22, European Standard EN 55022 as shown under section 1 of this report.

In compliance with 47 CFR Part 15 Subpart A Section 15.38 testing for FCC compliance may be done following the ANSI C63.4-2003 procedures and using the CISPR 22 Limits.

4.4.1.2 Measurement Error

The data and results referenced in this document are true and accurate. The reader is cautioned that there is some measurement variability due to the tolerances of the test equipment that can contribute to a nominal product measurement uncertainty. The measurement uncertainty was calculated for all measurements listed in this test report according to NIS 81/5.1994 "The treatment of uncertainty in EMC measurements" and is documented in the mikes-testingpartners gmbh quality system according to DIN EN ISO/IEC 17025. Furthermore, component differences and manufacturing process variability of production units similar to that tested may result in additional product uncertainty. If necessary, refer to the test lab for the actual measurement uncertainty for specific tests. The manufacturer has the sole responsibility of continued compliance of the device.

4.4.1.3 Justification

The Equipment Under Test (EUT) is configured in a typical user arrangement in accordance with the manufacturer's instructions. A cable is connected to each available port and either terminated with a peripheral using the appropriate impedance characteristic or left unterminated. Where appropriate, cables are manually manipulated with respect to each other thus obtaining maximum disturbances from the unit.

4.4.2 DETAILS OF TEST PROCEDURES

4.4.2.1 General Standard Information

The test methods used comply with CISPR Publication 22, EN 55022 - "Information technology equipment - Radio disturbance characteristics - Limits and methods of measurement" and with ANSI C63.4-2003 - "Methods of Measurement of Radio-Noise Emissions from Low-Voltage Electrical and Electronic Equipment in the Range of 9 kHz to 40 GHz."

5 TEST CONDITIONS AND RESULTS

5.1 Conducted emissions

For test instruments and accessories used see section 6 Part A 4.

5.1.1 Description of the test location

Test location: Shielded Room S2

5.1.2 Photo documentation of the test set-up

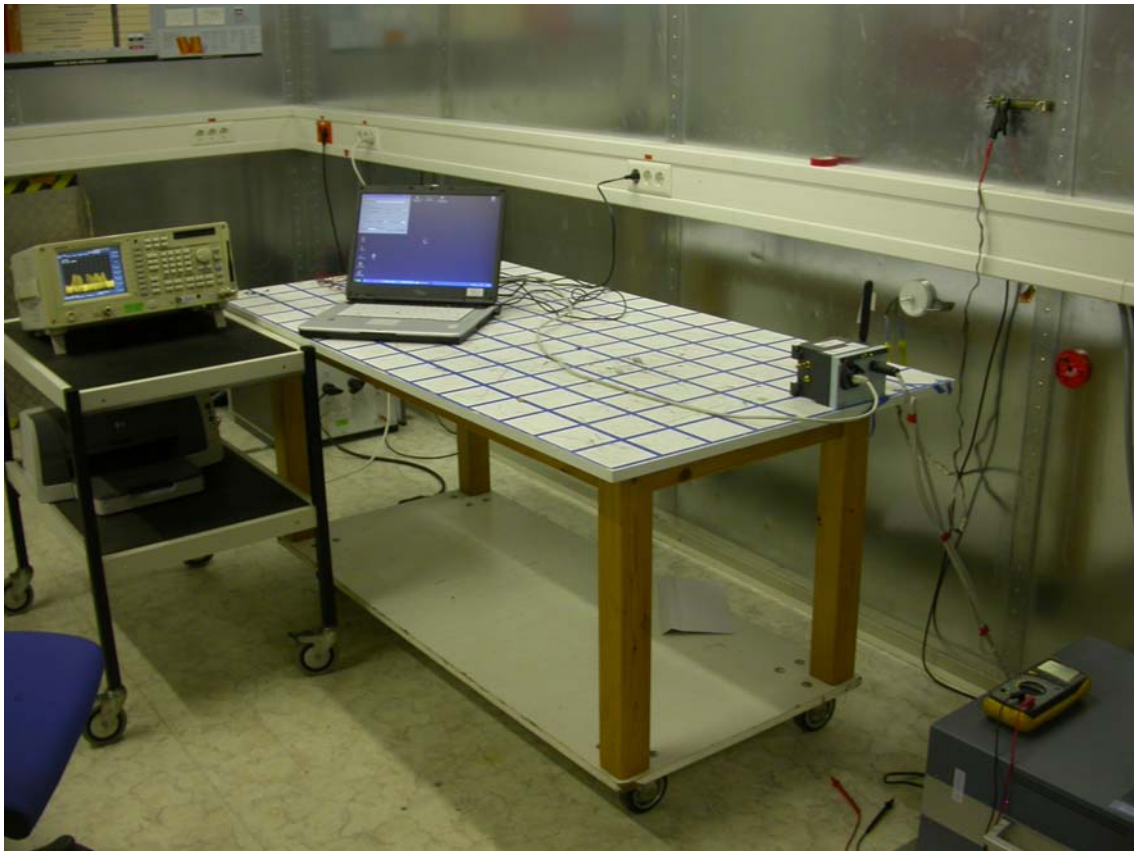

5.1.3 Applicable standard

According to FCC Part 15 Subpart 15.207 (a): Except as shown in paragraphs (b) and (c) of this section, for an intentional radiator that is designed to be connected to the public utility (AC) power line, the radio frequency voltage that is conducted back onto the AC power line on any frequency or frequencies within the band 150 kHz to 30 MHz shall not exceed the limits in the following table.

The measurements are performed using a receiver, which has CISPR characteristic bandwidth and quasi-peak detection and a Line Impedance Stabilization Network (LISN) with 50Ω/50 μH (CISPR 16) characteristics. Table top equipment is placed on a non-conducting table 80 centimeters above the floor and is positioned 40 centimeters from the vertical ground plane (wall) of the screen room. If the minimum limit margin appears to be less than 20 dB with a peak mode measurement, the emissions are remeasured using a tuned receiver with quasi-peak and average detection and recorded on the data sheets.

Frequency of Emission (MHz)	Conducted Limit (dBμV)	
	Quasi-peak	Average
0.15-0.5	66 to 56 *	56 to 46 *
0.5-5	56	46
5-30	60	50

* Decreases with the logarithm of the frequency

5.1.4 Description of Measurement

The final level, expressed in dBμV, is arrived at by taking the reading directly from the EMI receiver. This level is compared directly to the FCC Limit or to the CISPR limit.

To convert between dBμV and μV, the following conversions apply:

$$\text{dB}\mu\text{V} = 20(\log \mu\text{V})$$

$$\mu\text{V} = \text{Inverse log}(\text{dB}\mu\text{V}/20)$$

The requirements are **FULFILLED**.

Remarks: As worst case the EuT was equipped with 2 WLAN modules.

For detailed results please refer to the following plots.

FCC ID: LYHRAP-V1

Conducted emissions at negative power line

- LmtAVVoltage
- LmtQPVoltage
- Peak_21
- AVG_21
- ◇ QP_21
- × AV_21

Equipment - RAP
Serial No. -
Op Mode 1 -
Operator - HS

Peak Measurement
See Table for QP and AV values
Neg OM1

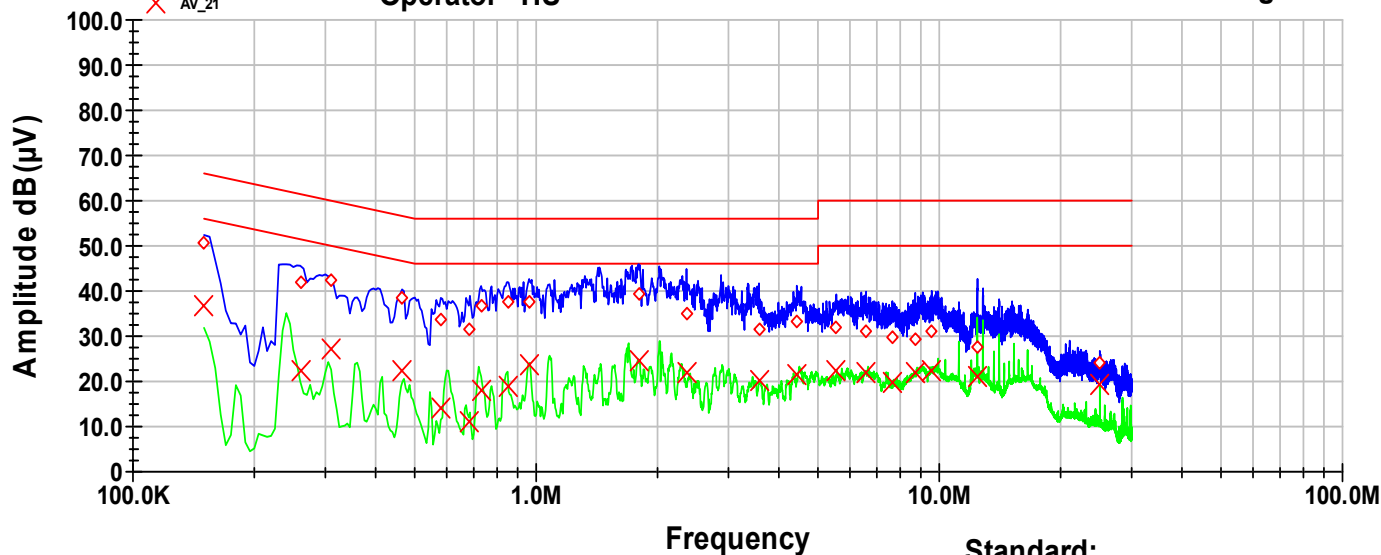

Standard:
File Number: T31960

Frequency MHz	QP Level dB(µV)	QP Margin dB	QP Limit dB	AV Level dB(µV)	AV Margin dB	AV Limit dB
0.15	50.8	-15.2	66.0	36.7	-19.3	56.0
0.26	41.9	-19.5	61.4	22.2	-29.2	51.4
0.31	42.5	-17.5	60.0	27.0	-23.0	50.0
0.465	38.5	-18.1	56.6	22.3	-24.3	46.6
0.58	33.7	-22.3	56.0	14.0	-32.0	46.0
0.685	31.3	-24.7	56.0	11.1	-34.9	46.0
0.73	36.6	-19.4	56.0	17.8	-28.2	46.0
0.85	37.5	-18.5	56.0	18.8	-27.2	46.0
0.96	37.7	-18.3	56.0	23.5	-22.5	46.0
1.795	39.2	-16.8	56.0	24.4	-21.6	46.0
2.36	35.2	-20.8	56.0	21.8	-24.2	46.0
3.57	31.4	-24.6	56.0	20.1	-25.9	46.0
4.43	33.3	-22.7	56.0	21.6	-24.4	46.0
5.55	31.9	-28.1	60.0	22.2	-27.8	50.0
6.575	30.9	-29.1	60.0	22.0	-28.0	50.0
7.64	29.6	-30.4	60.0	19.7	-30.3	50.0
8.71	29.2	-30.8	60.0	21.9	-28.1	50.0
9.575	31.0	-29.0	60.0	22.5	-27.5	50.0
12.41	27.4	-32.6	60.0	20.9	-29.1	50.0
25	24.1	-35.9	60.0	19.3	-30.7	50.0

FCC ID: LYHRAP-V1

Conducted emissions at positive power line

— LmtAVVoltage
— LmtQPVoltage
— Peak_11
— AVG_11
◇ QP_11
× AV_11

Equipment - RAP
Serial No. -
Op Mode 1 -
Operator - HS

Peak Measurement
See Table for QP and AV values
Plus OM1

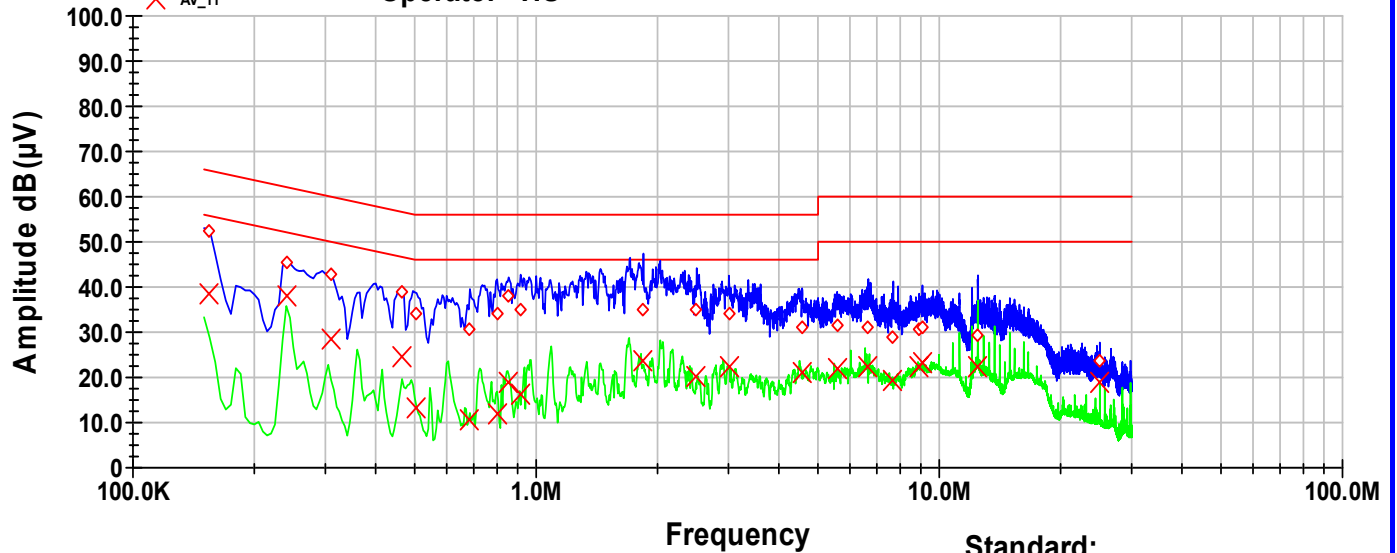

Standard:
File Number: T31960

Frequency MHz	QP Level dB(µV)	QP Margin dB	QP Limit dB	AV Level dB(µV)	AV Margin dB	AV Limit dB
0.155	52.5	-13.2	65.7	38.5	-17.3	55.7
0.24	45.5	-16.6	62.1	38.2	-13.9	52.1
0.31	42.7	-17.3	60.0	28.5	-21.5	50.0
0.465	38.7	-17.9	56.6	24.6	-22.0	46.6
0.505	34.0	-22.0	56.0	13.3	-32.7	46.0
0.685	30.5	-25.5	56.0	10.6	-35.4	46.0
0.8	34.0	-22.0	56.0	12.1	-33.9	46.0
0.855	38.3	-17.8	56.0	18.9	-27.1	46.0
0.915	35.1	-20.9	56.0	16.3	-29.7	46.0
1.845	35.1	-20.9	56.0	23.7	-22.3	46.0
2.5	35.0	-21.0	56.0	20.0	-26.0	46.0
3.005	33.9	-22.1	56.0	22.5	-23.5	46.0
4.565	31.1	-24.9	56.0	20.9	-25.1	46.0
5.58	31.6	-28.4	60.0	22.0	-28.0	50.0
6.665	31.0	-29.0	60.0	22.4	-27.6	50.0
7.685	28.9	-31.1	60.0	19.2	-30.8	50.0
8.905	30.6	-29.4	60.0	22.3	-27.8	50.0
9.075	31.0	-29.0	60.0	23.0	-27.0	50.0
12.46	29.3	-30.7	60.0	22.6	-27.4	50.0
25	23.7	-36.3	60.0	19.0	-31.0	50.0

5.2 26 dB Emission Bandwidth

For test instruments and accessories used see section 6 Part MB.

5.2.1 Description of the test location

Test location: AREA4

5.2.2 Photo documentation of the test set-up



5.2.3 Applicable standard

According to FCC Part 15 Subpart 15.401 (i): The emission bandwidth shall be determined by measuring the width of the signal between two points, one below the carrier center frequency and one above the carrier center frequency, that are 26 dB down relative to the maximum of the modulated carrier.

5.2.4 Description of Measurement

The bandwidth was measured at an amplitude level reduced from the reference level by a specified ratio of -26 dB. The reference level is the level of the highest amplitude signal observed from the transmitter fundamental frequency. The measurement has been carried out using a spectrum analyzer with the following settings:

RBW=300 kHz

VBW=1 MHz

PEAK Detector

The table below shows the settings according to ANSI C63.4-2003.

Fundamental frequency	Minimum resolution bandwidth
9 kHz to 30 MHz	1kHz
30 to 1000 MHz	10 kHz
1000 MHz to 40 GHz	100 kHz

5.2.5 Test result

Channel number	Fundamental Frequency [MHz]	26 dB BANDWIDTH (MHz)
36	5180	37.3
48	5240	31.3

Remarks: For detailed test result please refer to following test protocols.

5.2.6 Test protocol

26dB Bandwidth Measurement plots

Channel 36 (5180 MHz)



DELTA MARKER 1
37.3 MHz
Ref 20 dBm Att 50 dB

*RBW 300 kHz Delta 1 [T1]
*VBW 1 MHz 0.17 dB
SWT 20 ms 37.30000000 MHz

1 PK
VIEW

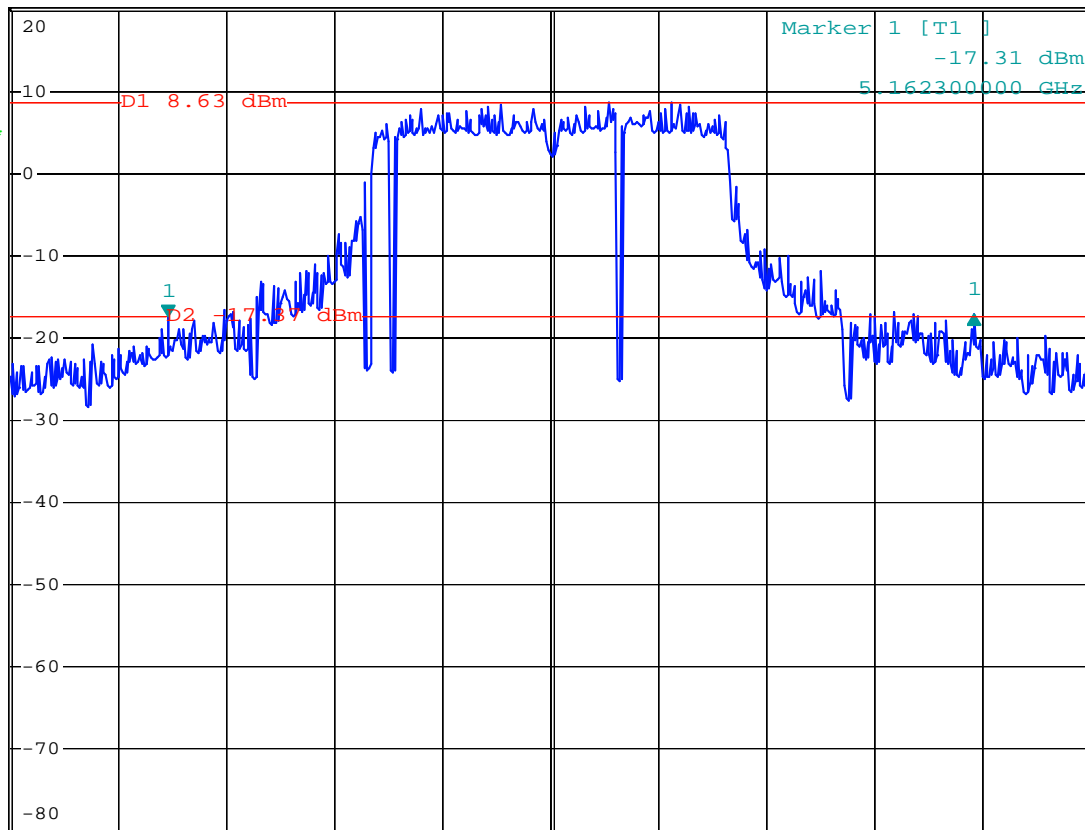

Center 5.18 GHz 5 MHz/ Span 50 MHz

Comment :

Date: 14.DEC.2007 11:22:45

FCC ID: LYHRAP-V1

Channel 48 (5240 MHz)



CENTER FREQUENCY
5.24 GHz
Ref 20 dBm Att 50 dB

*RBW 300 kHz Delta 1 [T1]
VBW 1 MHz -0.98 dB
SWT 20 ms 31.30000000 MHz

1 PK*
VIEW

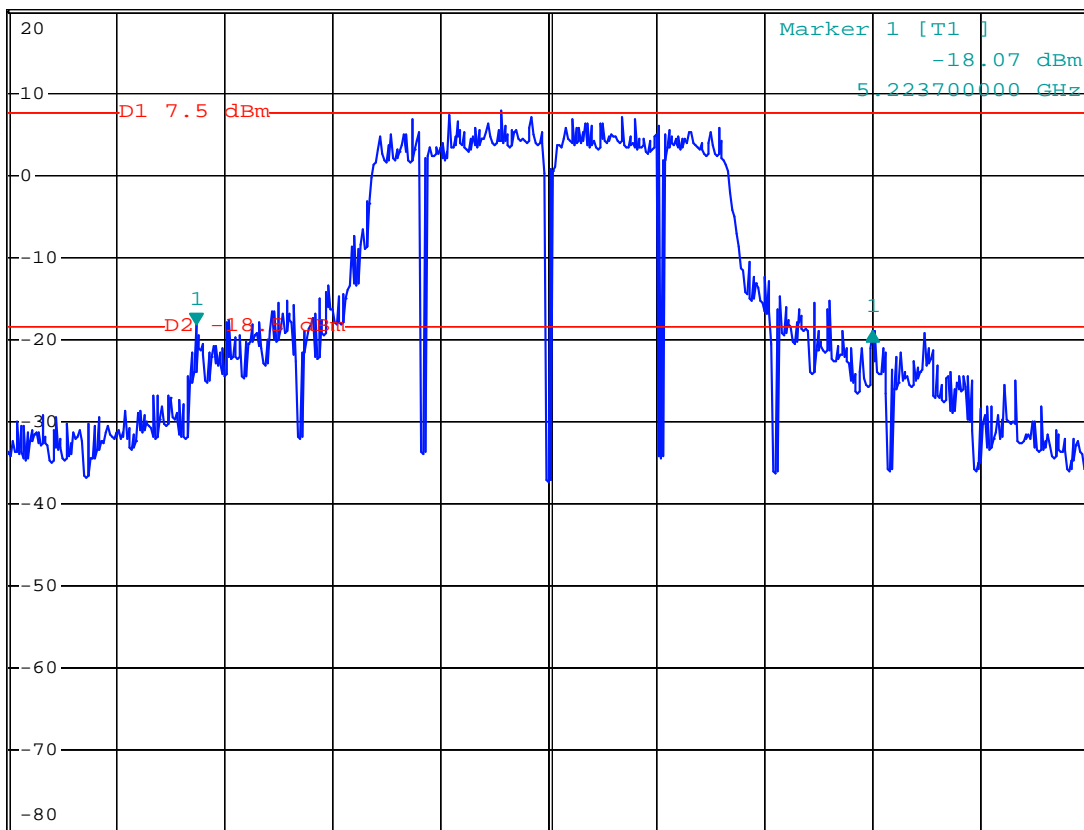

Center 5.24 GHz 5 MHz/ Span 50 MHz

Date: 25.FEB.2008 09:35:17

5.3 Maximum Conducted Output Power

For test instruments and accessories used see section 6 Part CPC 3.

5.3.1 Description of the test location

Test location: AREA4

5.3.2 Photo documentation of the test set-up



5.3.3 Applicable standard

According to FCC Part 15 Subpart 15.401 (n): The total transmits power delivered to all antennas and antenna elements averaged across all symbols in the signaling alphabet when the transmitter is operating at its maximum power control level. Power must be summed across all antennas and antenna elements. The average must not include any time intervals during which the transmitter is off or is transmitting at a reduced power level.

The applicable power limits are defined in Part 15.407 (a).

If transmitting antennas of directional gain are greater than 6 dBi are used, the maximum conducted output power shall be reduced by the amount in dB that the directional gain of the antenna exceeds 6 dBi.

5.3.4 Description of Measurement

The transmitter output was connected to the spectrum analyzer through an attenuator. The center frequency of the spectrum analyzer is set to the fundamental frequency using 1 MHz RBW and 300 kHz VBW. The span of the spectrum analyzer should be larger than the Emission Band Width (EBW). To get the total power of the occupied band width the function "Channel Power Measurement" of the analyzer has been used. The channel band width has been set to EBW. With Peak detector and Power Mode Max Hold the result is the summed maximum output power of the EBW.

5.3.5 Test result

Technology 802.11a

Ch	Frequency [MHz]	Power settings [Δ dB]	Measured Power [dBm]	Correction [dB]	Antenna gain [dBi]	EIRP Power [dBm]	EIRP Power Limit [dBm]	Delta [dB]
36	5180	0	4.9	12.0	3.5	20.4	23.0	-2.6
		-3	4.9	12.0	6.0	22.9	23.0	-0.1
		-6	1.8	12.0	9.0	22.8	23.0	-0.2
48	5240	0	4.5	12.0	3.5	20.0	23.0	-3.0
		-3	4.5	12.0	6.0	22.5	23.0	-0.5
		-6	1.3	12.0	9.0	22.3	23.0	-0.7

Remarks: Where Correction means fixed attenuation of 10 dB and cable loss of 2.0 dB.

The calculated EIRP power includes the gain of the applicable antennas. The necessary reduction of the output power depends on the used type of antenna. The amount of the reduced output power is implemented in the firmware of the EuT and will be automatically adjusted on the selected antenna.

Peak Power Limit according to FCC Subpart 15.407(a)

Frequency [GHz]	Conducted Power Limit		EIRP Limit
	[dBm]	[mW]	[dBm]
5.15-5.25	17	50	23

The requirements are **FULFILLED**.

Remarks: This test has been performed conducted at antenna jack on WLAN module.

5.4 Undesirable emissions

For test instruments and accessories used see section 6 Part SER 2 and SER 3.

5.4.1 Description of the test location

Test location: OATS1
Anechoic Chamber A2

Test distance: 3 metres

5.4.2 Photo documentation of the test set-up

Anechoic chamber



FCC ID: LYHRAP-V1

Open area test site



mikes

5.4.3 Applicable standard

According to FCC Part 15 Subpart 15.407 (b):

- (1) For transmitters operating in the 5.15-5.25 GHz band: all emissions outside of the 5.15-5.35 GHz band shall not exceed an EIRP of -27 dBm/MHz.

In addition, radiated emissions which fall in the restricted bands, as defined in §15.205(a), must also comply with the radiated emission limit specified in §15.209(a) (see §15.205(c)).

5.4.4 Description of Measurement

Radiated spurious emissions from the EuT are measured in the frequency range of 30 MHz to 1000 MHz using a tuned receiver and appropriate broadband linearly polarized antennas. The measurements are made with 120 kHz/6 dB bandwidth and quasi-peak detection. The EuT is placed on a 1.0 X 1.5 meter non-conducting table 80 centimetres above the ground plane. The set up of the Equipment under test will be in accordance to ANSI C63.4-2003.

The antenna was positioned 3 meters horizontally from the EuT. To locate maximum emissions from the test sample the antenna is varied in height from 1 to 4 meters, measurement scans are made with both horizontal and vertical antenna polarization's and the EuT are rotated 360 degrees.

The final level, expressed in dB μ V/m, is arrived by taking the reading from the EMI receiver (Level dB μ V) and adding the correction factors and cable loss factor (Factor dB) to it. This is done automatically in the EMI receiver, where the correction factors are stored.

The radiated emissions from the EuT are measured in the frequency range of 1 GHz to maximum frequency as specified in section 15.33, using a Spectrum Analyzer and appropriate linearly polarized antennas. The EuT is placed on a 1.0 X 1.5 meter non-conducting table 80 centimetres above the ground plane. The set up of the EuT will be in accordance to ANSI C63.4-2003. The antenna was positioned 3 m horizontally from the EuT.

Measurement are made in both the horizontal and vertical planes of polarization in a fully anechoic room using a spectrum analyzer with the detector function set to peak, RBW 1 MHz and VBW set to 3 MHz for any spurious emission or modulation product that falls in **Restricted bands** as defined in Section 15.205.

All tests are performed at a test-distance of 3 meters. During the tests the EUT measurement scans are made with both horizontal and vertical antenna polarization's and the EuT are rotated 360 degrees.

According to Part 15.407 (b) (5): The emission measurements have been performed using a minimum RBW of 1 MHz. At some measurements it was necessary to use a RBW of 100 kHz near the band edge. The results than have been calculated to show the total power over 1 MHz.

Average values were measured with spectrum analyzer by taking the following Settings

RBW: 1 MHz

VBW: 10 Hz

Sweep: Auto

5.4.5 Test result

Worst case condition:

All radiated measurements are performed with Antenna ANT795-6DN with power setting of -6.

5.4.5.1 Radiated emissions and Harmonics in restricted bands

Frequency band: 5.15 GHz to 5.25 GHz

Channel 36 (5180 MHz)

Frequency [MHz]	Detector	Analyzer reading		Correction [dB]	Result		Limit [dB μ V/m]	Delta [dB]
		hor [dB μ V/m]	vert [dB μ V/m]		hor [dB μ V/m]	vert [dB μ V/m]		
4800	Pk	<40	55.4	-0.3	---	55.1	74	-18.9
	AV	---	47.8	-0.3	---	47.5	54	-6.5
5121	Pk	<40	56.8	0.5	---	57.3	74	-16.7
	AV	---	49.3	0.5	---	49.8	54	-4.2
5150	Pk	<40	66.5	0.5	---	67.0	74	-7.0
	AV	---	47.6	0.5	---	48.1	54	-5.9
15540	Pk	<40	<40	5.9	---	<40	74	---
	AV	---	---	5.9	---	---	54	---

Channel 48 (5240 MHz)

Frequency [MHz]	Detector	Analyzer reading		Correction [dB]	Result		Limit [dB μ V/m]	Delta [dB]
		hor [dB μ V/m]	vert [dB μ V/m]		hor [dB μ V/m]	vert [dB μ V/m]		
15720	Pk	<40	<40	8.2	---	---	74	---
	AV	---	---	8.2	---	---	54	---

5.4.5.2 Radiated emissions outside of frequency bands

Frequency band from 5.15 GHz to 5.25 GHz

Carrier frequency at channel 36 (5180 MHz)

Three plots have been taken to show the restricted band emission levels and the out-of-band radiated spurious emission levels at and near the lower authorized bandedge.

Radiated spurious emissions from 30 MHz to 1000 MHz

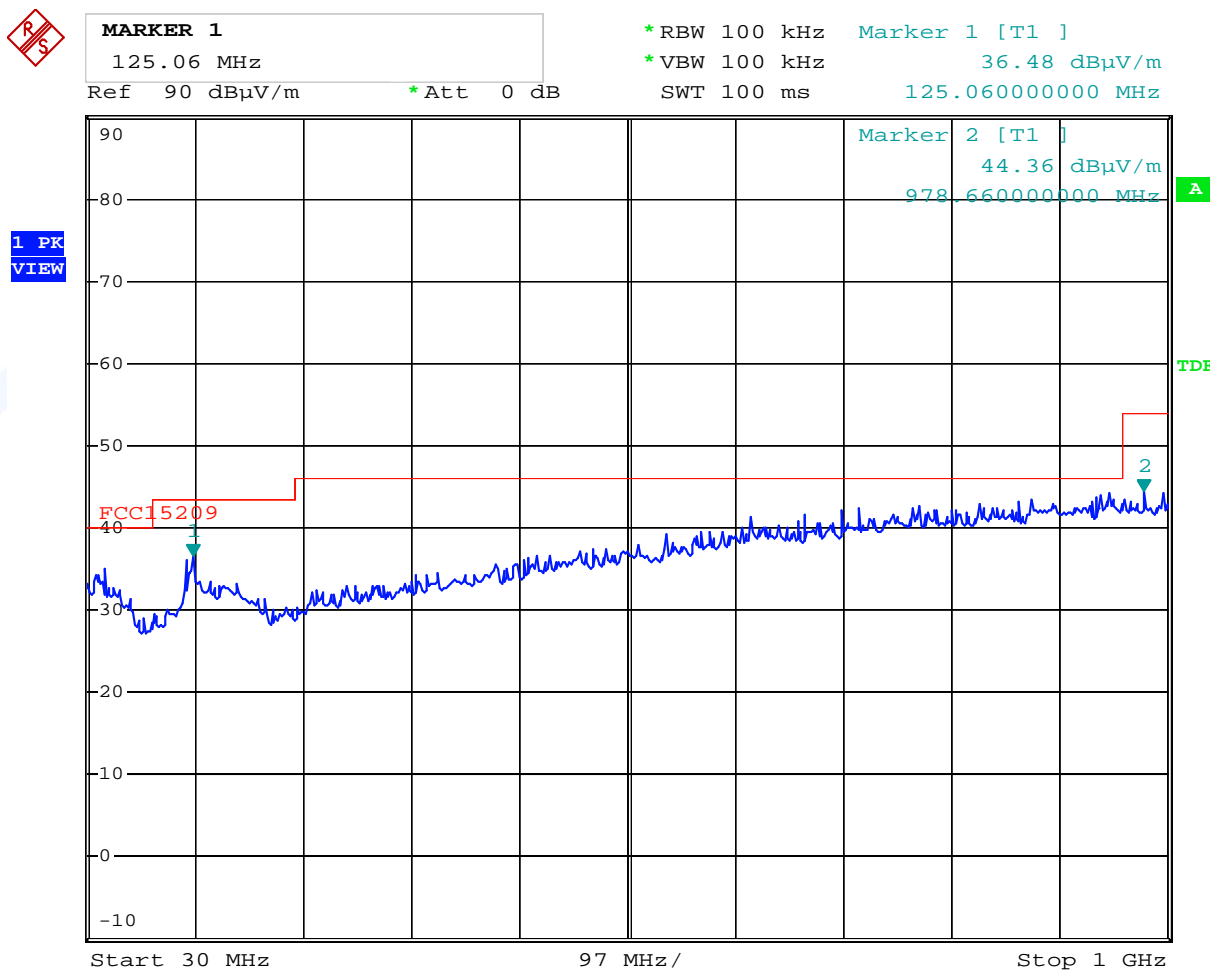

Date: 29.JAN.2008 15:23:58

Notes: All peak emissions were below the limits of part 15.209.

FCC ID: LYHRAP-V1

Radiated spurious emissions from 1 GHz to 5.15 GHz



*RBW 1 MHz

*VBW 1 MHz

SWT 85 ms

Ref -10 dBm

*Att 10 dB

1 PK
VIEW

D1 -27 dBm

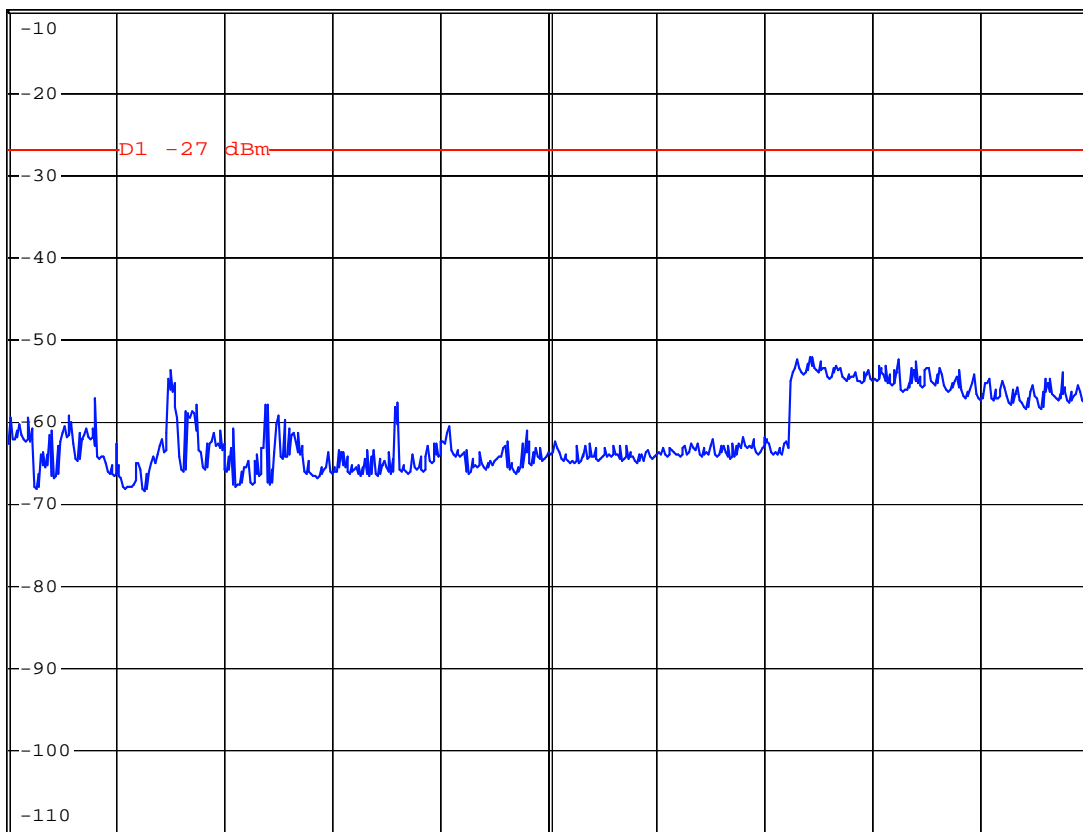

Start 1 GHz

415 MHz/

Stop 5.15 GHz

Comment :

Date: 14.FEB.2008 09:16:27

FCC ID: LYHRAP-V1

Peak and AV plot in restricted band from 4500 to 5150 MHz



MARKER 1
4.8003 GHz
Ref 97 dB μ V/m *Att 20 dB

*RBW 1 MHz Marker 1 [T1]
*VBW 1 MHz 55.13 dB μ V/m
SWT 20 ms 4.800300000 GHz

1 PK
VIEW

2 PK
VIEW

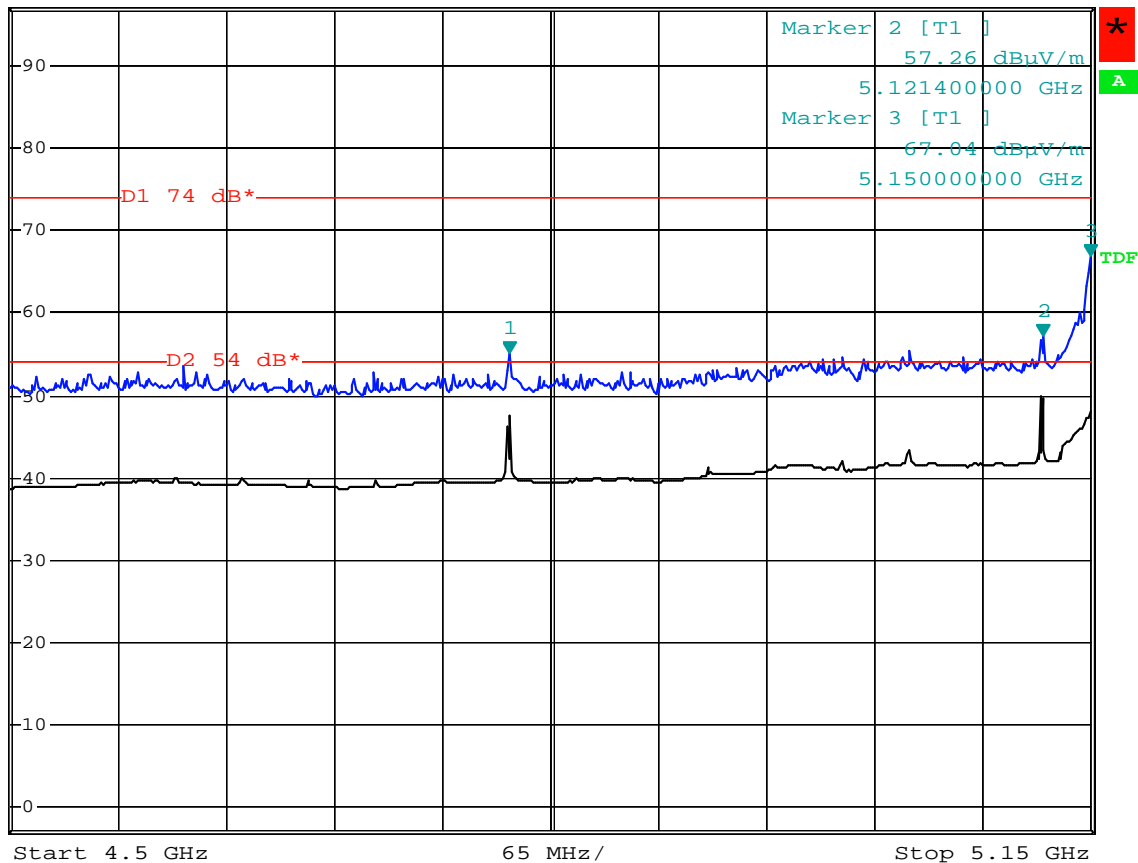

Comment :

Date: 14.FEB.2008 09:42:51

Carrier frequency at channel 48 (5240 MHz)

Three plots have been taken to show the restricted band emission levels and the out-of-band radiated spurious emission levels at and near the upper authorized bandedge.

Peak and AV plot in restricted band from 5350 to 5460 MHz



SELECT TRACE
1
Ref 97 dBµV/m *Att 10 dB

*RBW 1 MHz
*VBW 1 MHz
SWT 20 ms

1 PK
VIEW

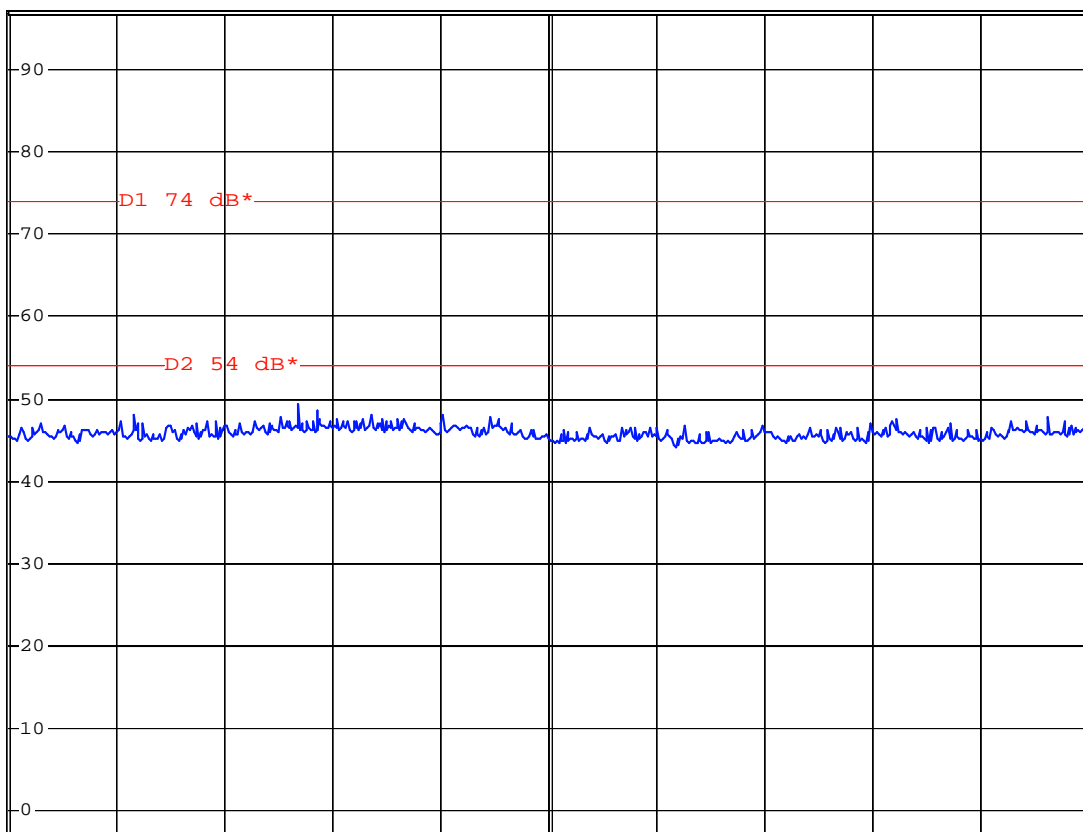

Start 5.35 GHz 11 MHz/ Stop 5.46 GHz

Comment:

Date: 14.FEB.2008 09:53:18

FCC ID: LYHRAP-V1

Radiated spurious emissions from 5.35 GHz to 12 GHz



*RBW 1 MHz
*VBW 1 MHz
SWT 135 ms

Ref -10 dBm

*Att 10 dB

1 PK
VIEW

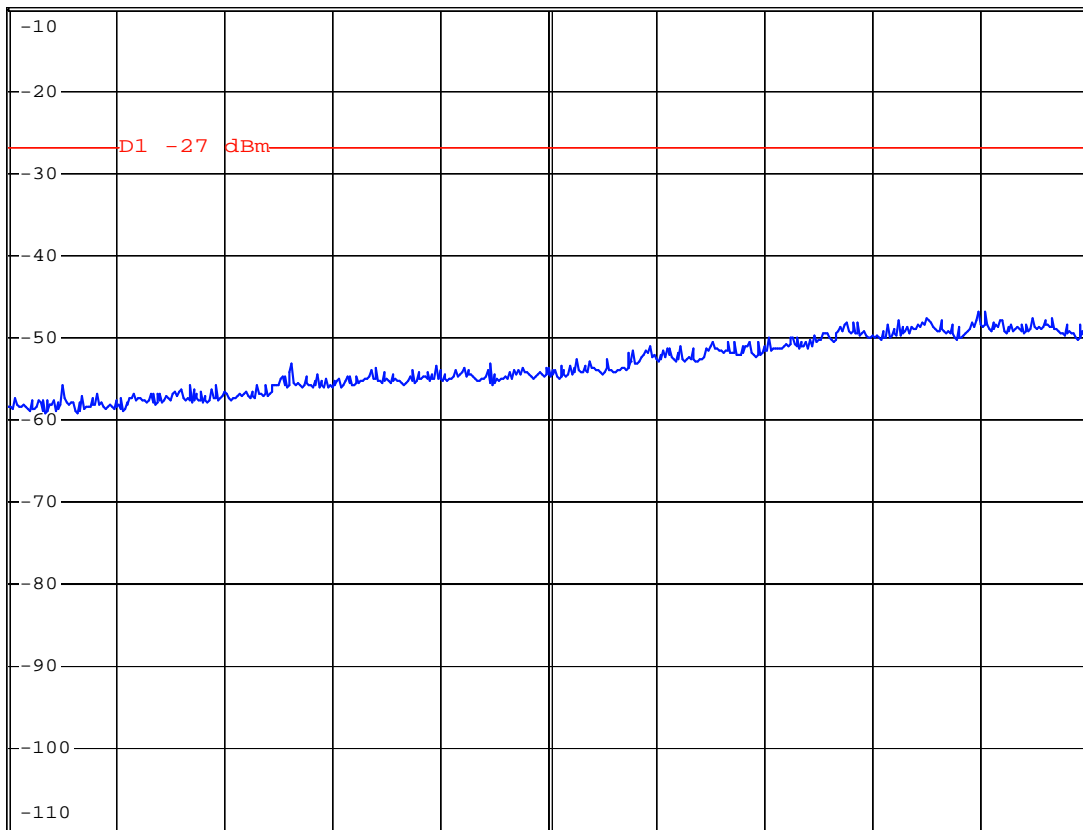

Start 5.35 GHz

665 MHz/

Stop 12 GHz

Comment :

Date: 14.FEB.2008 09:06:59

Radiated spurious emissions from 12 GHz to 18 GHz



DISPLAY LINE 1
54 dB μ V/m
Ref 80 dB μ V/m *Att 0 dB

*RBW 100 kHz
*VBW 1 MHz
SWT 600 ms

1 PK
VIEW

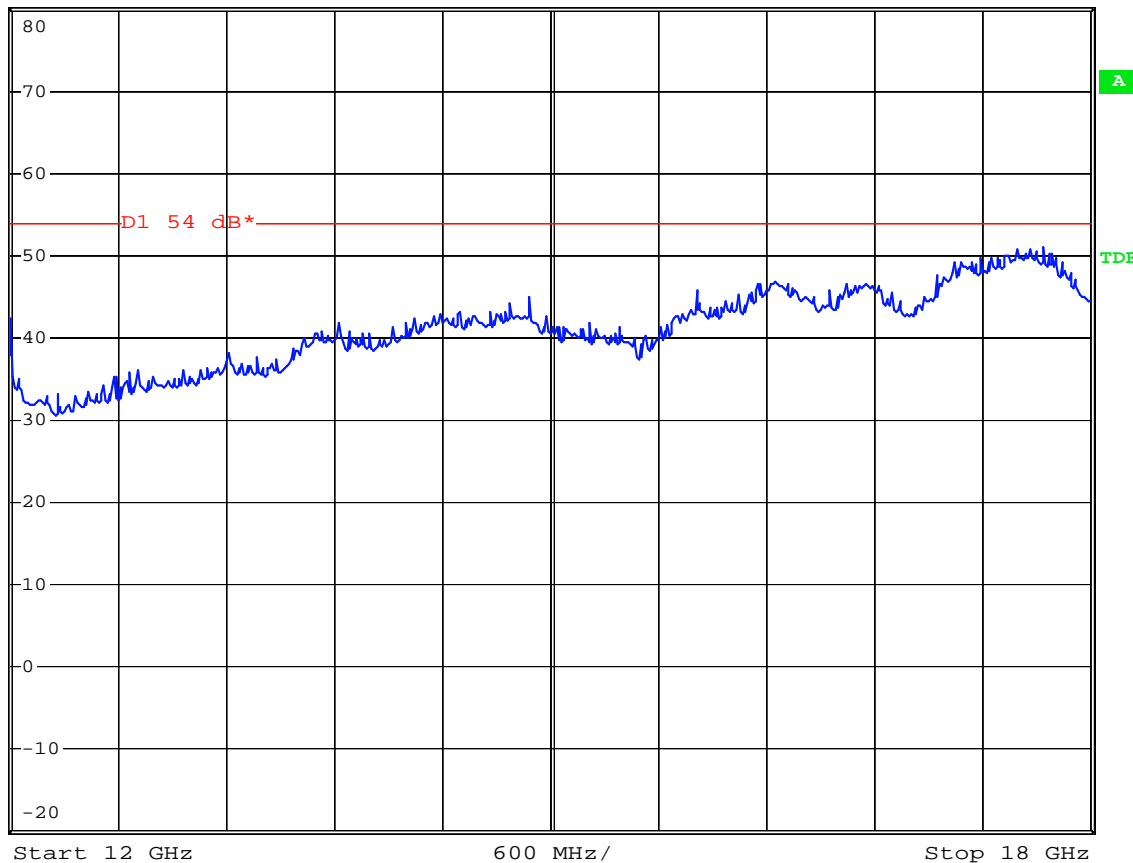

Date: 22.JAN.2008 21:40:10

Notes: All peak emissions were below the limits of part 15.209.

FCC ID: LYHRAP-V1

Radiated limits according to FCC Part 15 Subpart 15.209(a) for spurious emissions which fall in restricted bands:

Frequency (MHz)	Field strength of spurious emissions		Measurement distance (meters)
	($\mu\text{V/m}$)	dB ($\mu\text{V/m}$)	
0,009-0,490	2400/F(kHz)		300
0,490-1,705	24000/F(kHz)		30
1,705-30	30	29,5	30
30-88	100	40	3
88-216	150	43.5	3
216-960	200	46	3
Above 960	500	54	3

Restricted bands of operation:

The field strength of emissions appearing within these frequency bands shall not exceed the limits shown in §15.209

MHz	MHz	GHz
25.5 – 25.67	960 – 1240	4.5 – 5.15
37.5 – 38.25	1300 – 1427	5.35 – 5.46
73 – 74.6	1435 – 1626.5	7.25 – 7.75
74.8 – 75.2	1645.5 – 1646.5	8.025 – 8.5
108 – 121.94	1660 – 1710	9.0 – 9.2
123 – 138	1718.8 – 1722.2	9.3 – 9.5
149.9 – 150.05	2200 – 2300	10.6 – 12.7
156.52475 – 156.52525	2310 – 2390	13.25 – 13.4
156.7 – 156.9	2483.5 – 2500	14.47 – 14.5
162.0125 – 167.17	2655 – 2900	15.35 – 16.2
167.72 – 173.2	3260 – 3267	17.7 – 21.4
240 – 285	3332 – 3339	22.01 – 23.12
322 – 335.4	3345.8 – 3358	23.6 – 24.0
399.9 – 410	3600 – 4400	31.2 – 31.8
608 – 614		36.43 – 36.5

The requirements are **FULFILLED**.

Remarks: The measurement was performed up to the 10th harmonic.

5.5 Peak Power Spectral Density

For test instruments and accessories used see section 6 Part CPC 3.

5.5.1 Description of the test location

Test location: Area 4

5.5.2 Photo documentation of the test set-up



5.5.3 Applicable standard

According to FCC Part 15 Subpart 15.407 (a): For the band 5.15-5.25 GHz the peak power spectral density conducted from the intentional radiator to the antenna shall not be greater than 4 dBm in any 1-MHz band during any time interval of continuous transmission.

5.5.4 Description of Measurement

The EuT was connected to the spectrum analyzer with a suitable attenuator. The peak power spectral density was measured using the analyzer function of measuring the band power/Hz and the same settings like the power measuring. The result is calculated by addition of 60 dB (10 log 1 MHz/Hz) to the readings.

Settings on the spectrum analyzer:

RBW: 1 MHz
 VBW: 3 MHz
 Sweep: auto
 Detector function: AV

5.5.5 Test result

Channel	Fundamental Frequency [MHz]	Reading [dBm/Hz]	Correction to 1 MHz [dB]	PPSD Result [dBm]	Limit [dBm]
36	5180	-56.4	60	3.6	4
48	5240	-57.4	60	2.6	4

The requirements are **FULFILLED**.

Remarks: For detailed test results please refer to following test protocols.

Peak Power spectral density plots

Channel 36 (5180 MHz)



* RBW 1 MHz
* VBW 3 MHz
* SWT 5 s

Ref 20 dBm

Att 40 dB

1 AV*
CLRWR

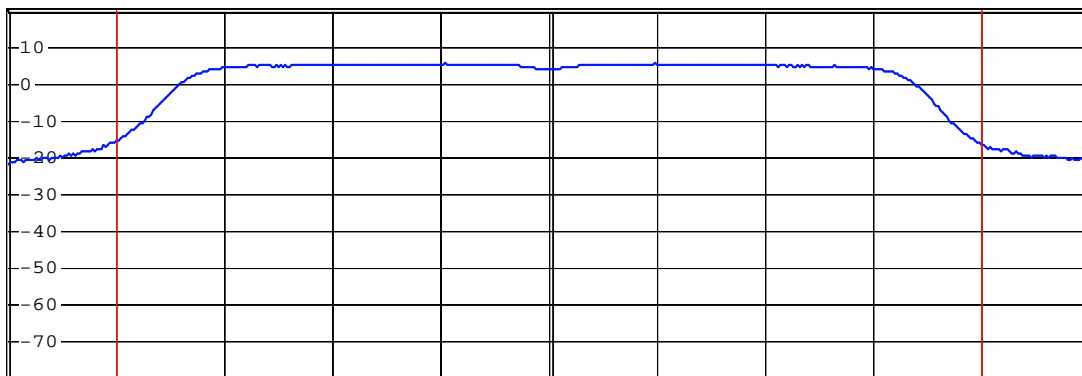

PWR
MAXH

Center 5.18 GHz

2.5 MHz/

Span 25 MHz

Tx Channel

Bandwidth

20 MHz

Power -56.44 dBm/Hz

Channel 48 (5240 MHz)



RBW 1 MHz
* VBW 3 MHz
* SWT 5 s

Marker 1 [T1]

4.20 dBm

5.242280000 GHz

Ref 20 dBm

Att 40 dB

1 AV*
CLRWR

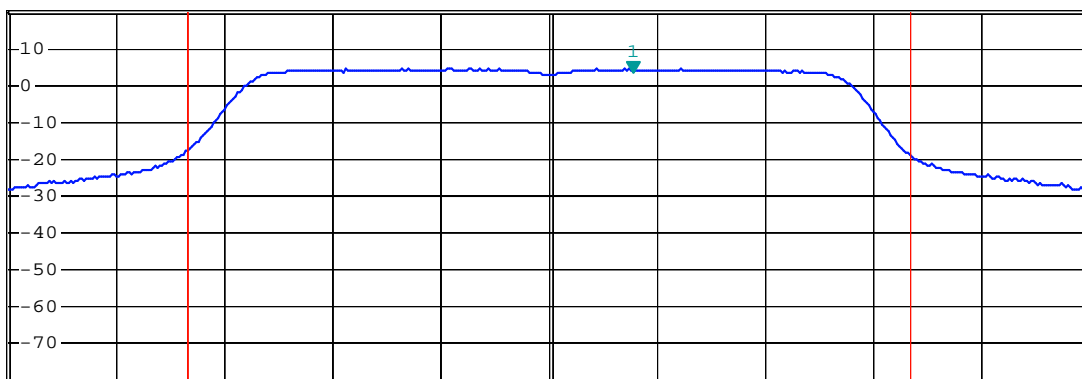

PWR
MAXH

Center 5.24 GHz

3 MHz/

Span 30 MHz

Tx Channel

Bandwidth

20 MHz

Power -57.42 dBm/Hz

5.6 Peak Excursion

For test instruments and accessories used see section 6 Part **MB**.

5.6.1 Description of the test location

Test location: AREA4

5.6.2 Photo documentation of the test set-up



5.6.3 Applicable standard

According to FCC Part 15 Subpart 15.407 (a) (6): The ratio of the peak excursion of the modulation envelope (measured using a peak hold function) to the maximum conducted output power (measured as specified above) shall not exceed 13 dB across any 1 MHz bandwidth or the emission bandwidth whichever is less.

5.6.4 Description of Measurement

The transmitter output was connected to the spectrum analyzer. Using Peak detector and MAX HOLD-function for Trace 1 with 1 MHz RBW and 3 MHz VBW and Trace 2 with 1 MHz RBW and 300 kHz VBW both traces were recorded. The largest difference between Trace 1 and Trace 2 in any 1 MHz band was noted as maximum Peak Excursion value.

5.6.5 Test result

Channel	Frequency [MHz]	Peak Power Excursion [dBm]	Peak to Average Excursion Limit [dBm]	Delta [dB]
36	5180	8.0	13	-5.0
48	5240	9.3	13	-3.7

The requirements are **FULFILLED**.

Remarks: For detailed test results please refer to following test protocols.

FCC ID: LYHRAP-V1

Peak Excursion Plots

Channel 36 (5180 MHz)



SELECT TRACE
1

*RBW 1 MHz Delta 1 [T2]
*VBW 3 MHz -8.03 dB
SWT 20 ms 0.00000000 Hz

Ref 20 dBm Att 50 dB

1 PK VIEW
2 PK VIEW

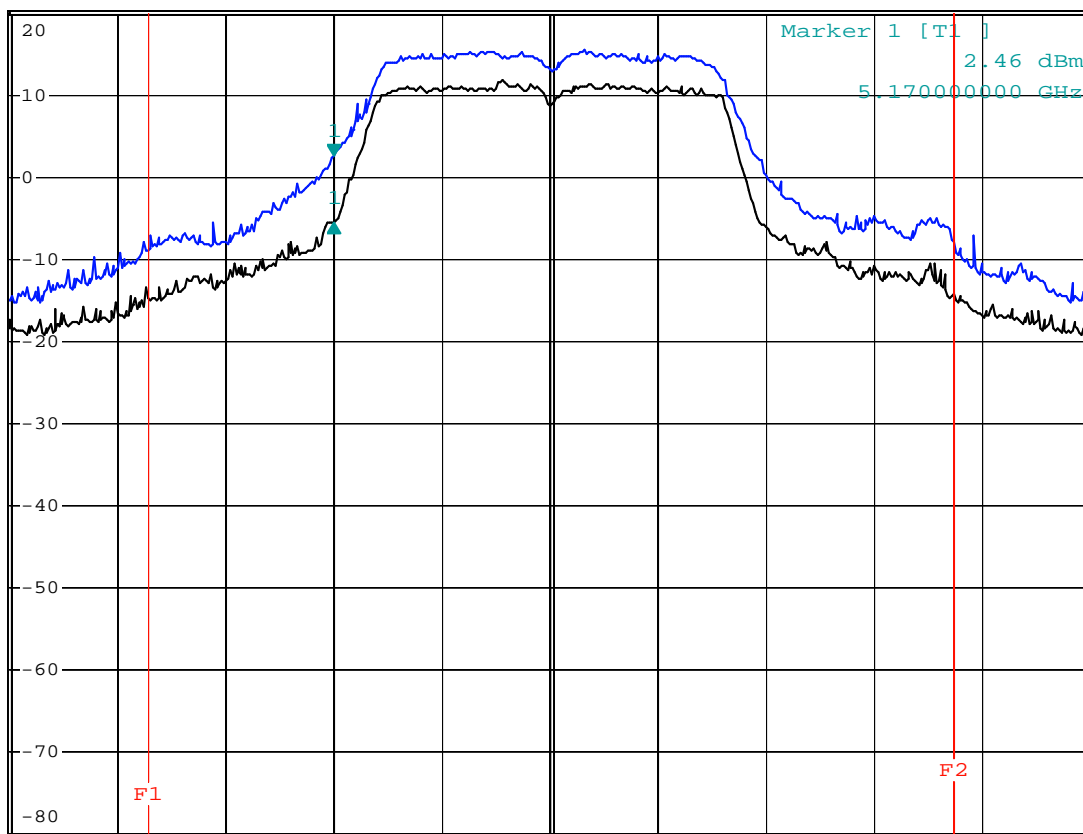

Center 5.18 GHz 5 MHz/ Span 50 MHz

Comment: EBW=37.3 MHz (F2-F1)
Date: 14.DEC.2007 13:33:49

FCC ID: LYHRAP-V1

Channel 48 (5240 MHz)



*RBW 1 MHz Delta 1 [T2]
*VBW 300 kHz -9.32 dB
SWT 20 ms 0.00000000 Hz

Ref 20 dBm

Att 50 dB

SWT 20 ms

0.00000000 Hz

1 PK
VIEW

2 PK
VIEW

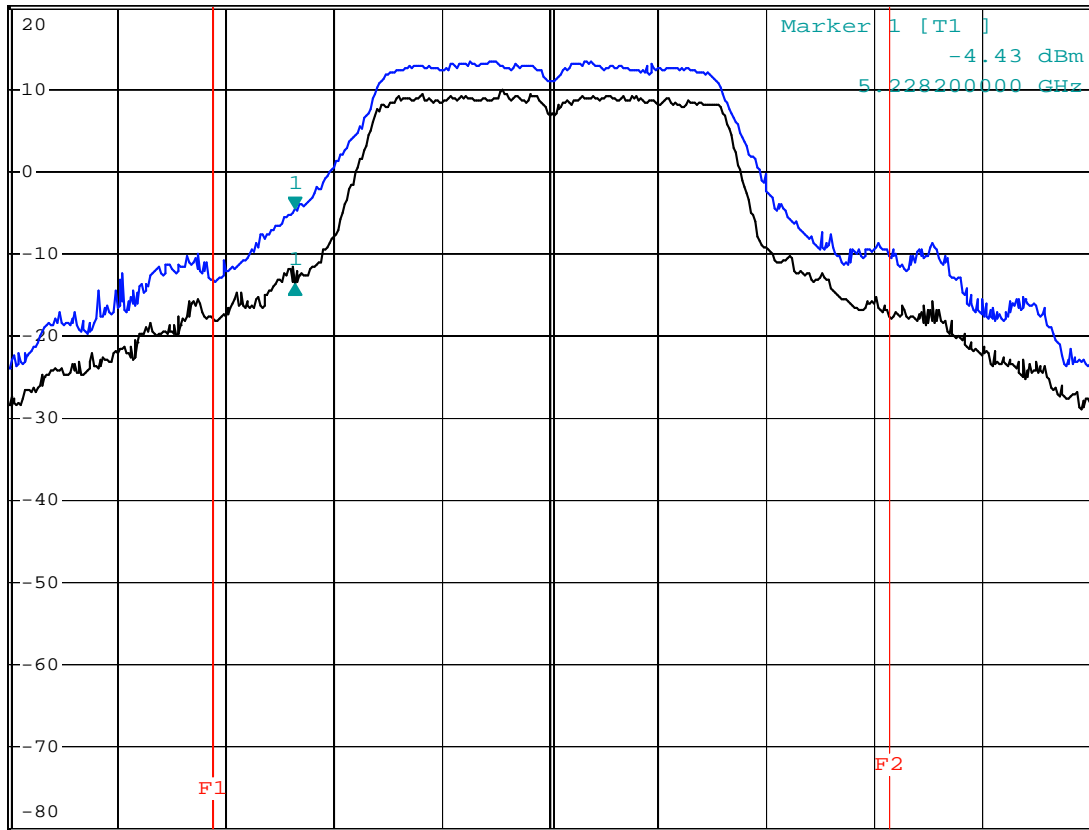

Center 5.24 GHz

5 MHz/

Span 50 MHz

Comment: EBW=31.3 MHz, (F2-F1)

Date: 25.FEB.2008 10:00:36

5.7 Maximum Permissible Exposure (MPE)

For test instruments and accessories used see section 6 Part **CPC 3**.

5.7.1 Description of the test location

Test location: OATS1

5.7.2 Photo documentation of the test set-up



5.7.3 Applicable standard

According to FCC Part 15 Subpart 15.407 (f): U-NII devices are subject to the radio frequency radiation exposure requirements specified in §§ 1.1307 (b), 2.1091 and 2.1093 of this chapter, as appropriate.

The test methods used comply with ANSI/IEEE C95.1-1992, "IEEE Standard for Safety Levels with respect to Human Exposure to Radio Frequency Electromagnetic Fields, 3 kHz to 300 GHz".

This test report shows the compliance with the limits for Maximum Permissible Exposure (MPE) specified in FCC 1.1310 and the criteria to evaluate the environmental impact of human exposure to radio-frequency (RF) radiation as specified in FCC 1.1307(b).

5.7.4 Description of Measurement

The maximum total power input to the antenna has been measured conducted as described in clause 5.3 of this document. Through the Friis transmission formula, which is a far field assumption and the known maximum gain of the antenna, the maximum MPE at a defined distance away from the product, can be calculated.

Friis transmission formula:
$$P_d = \frac{P_{out} * G}{4 * \pi * r^2}$$

where

P_d = power density in mW/cm²

P_{out} = output power to antenna in mW

G = gain of antenna (linear scale)

r = distance between antenna and observation point [cm]

5.7.5 Compliance regarding co-location and co-transmission

There is no co-location issue with 2 and 3 transmitters operating simultaneously. The reason for this is, that one module with the test software transmits with the highest possible duty cycle. If more than one module is active, the duty cycle for each module will be reduced. It is not possible (controlled by host computer) that the modules transmit at the same time slot.

5.7.6 Test result

Worst case: Antenna ANT795-6DN with an antenna gain of 9 dBi
Power setting: -6

Channel No.	Frequency (MHz)	Max Power Output to Antenna		Antenna gain (dBi)	Power Density (mW/cm ²)	Limit of Power Density (mW/cm ²)
		(dBm)	(mW)			
36	5180	14.0	25.12	9	0.040	1.0
48	5240	13.3	19.95	9	0.032	1.0

Limits for Maximum Permissible Exposure (MPE)

Frequency Range (MHz)	Electric Field Strength (V/m)	Magnetic Field Strength (A/m)	Power Density (mW/cm ²)	Averaging Time (minutes)
(A) Limits for Occupational / Controlled Exposure				
0.3 – 3.0	614	1.63	100	6
3.0 – 30	1842/f	4.89/f	900/f ²	6
30 - 300	61.4	0.163	1.0	6
300-1500	---	---	f/300	6
1500-100000	---	---	5.0	6
(B) Limits for General Population / Uncontrolled Exposure				
0.3 – 3.0	614	1.63	100	30
3.0 – 30	824/f	2.19/f	180/f ²	30
30 - 300	27.5	0.073	0.2	30
300-1500	---	---	f/1500	30
1500-100000	---	---	1.0	30

f = Frequency in MHz

The requirements are **FULFILLED**.

Remarks: _____

5.8 Antenna application

5.8.1 Applicable standard

According to FCC Part 15 Subpart 15.203: An intentional radiator shall be designed to ensure that no antenna other than that furnished by the responsible party shall be used with the device. The use of a permanently attached antenna or of an antenna that uses a unique coupling to the intentional radiator shall be considered sufficient to comply with the provisions of this section.

All supplied antennas meet the requirements of part 15.203 and 15.204.

The antennas can be connected only by a cable equipped with a reverse SMA plug supplied by the manufacturer.

5.8.2 Antenna requirements

FCC part 15C section 15.407 (a) requirements:

The conducted output power limit specified in paragraph (a) of 15.407 is based on the use of antennas with directional gains that do not exceed 6 dBi. If transmitting antennas of directional gain greater than 6 dBi are used, the conducted output power from intentional radiator shall be reduced below the stated values in paragraph (a)(1), (a)(2) and (a)(3) of this section, as appropriate, by the amount in dB that the directional gain of the antenna exceeds 6dBi.

The necessary reduction of the output power depends on the used type of antenna. The amount of the reduced output power is implemented in the firmware of the EuT and will be automatically adjusted on the selected antenna.

5.9 Receiver Spurious Emissions

For test instruments and accessories used see section 6 Part **SER 2** and **SER 3**.

5.9.1 Description of the test location

Test location: OATS1
Anechoic Chamber A2

Test distance: 3 metres

5.9.2 Photo documentation of the test set-up

Anechoic chamber



FCC ID: LYHRAP-V1

Open area test site



mikes

5.9.3 Applicable standard

According to FCC Part 15 Subpart 15.109: Field strength of radiated emissions from unintentional radiators at 3 m.

5.9.4 Description of Measurement

Radiated spurious emissions from the EuT are measured in the frequency range of 30 MHz to 1000 MHz using a tuned receiver and appropriate broadband linearly polarized antennas. The measurements are made with 120 kHz/6 dB bandwidth and quasi-peak detection. The EuT is placed on a 1.0 X 1.5 meter non-conducting table 80 centimetres above the ground plane. The set up of the Equipment under test will be in accordance to ANSI C63.4-2003.

The antenna was positioned 3 meters horizontally from the EuT. To locate maximum emissions from the test sample the antenna is varied in height from 1 to 4 meters, measurement scans are made with both horizontal and vertical antenna polarization`s and the EuT are rotated 360 degrees.

The final level, expressed in dB μ V/m, is arrived by taking the reading from the EMI receiver (Level dB μ V) and adding the correction factors and cable loss factor (Factor dB) to it. This is done automatically in the EMI receiver, where the correction factors are stored.

The radiated emissions from the EuT are measured in the frequency range of 1 GHz to maximum frequency as specified in section 15.33, using a Spectrum Analyzer and appropriate linearly polarized antennas. The EuT is placed on a 1.0 X 1.5 meter non-conducting table 80 centimetres above the ground plane. The set up of the EuT will be in accordance to ANSI C63.4-2003. The antenna was positioned 3 m horizontally from the EuT.

Measurement are made in both the horizontal and vertical planes of polarization in a fully anechoic room using a spectrum analyzer with the detector function set to peak, RBW 1 MHz and VBW set to 3 MHz for any spurious emission or modulation product that falls in Restricted bands as defined in Section 15.205.

All tests are performed at a test-distance of 3 meters. During the tests the EUT measurement scans are made with both horizontal and vertical antenna polarization`s and the EuT are rotated 360 degrees.

Average values were measured with spectrum analyzer by taking the following Settings

RBW: 1 MHz

VBW: 10 Hz

Sweep: Auto

5.9.5 Test result

Frequency [MHz]	Detector	Analyzer reading		Correction [dB]	Result		Limit [dBµV/m]	Delta [dB]
		hor [dBµV/m]	vert [dBµV/m]		hor [dBµV/m]	vert [dBµV/m]		
30-1000	Pk	<40	<40		---	---	---	---
	AV	---	---		---	---	---	---
1000-18000	Pk	<40	<40		---	---	74	---
	AV	---	---		---	---	54	---

Limit according to FCC Subpart 15.109(a)

Frequency of emission [MHz]	Field strength Limits [µV/m]	Field strength Limits [dBµV/m]
0,009-0,490	2400/F(kHz)	
0,490-1,705	24000/F(kHz)	
1,705-30	30	
30-88	100	40
88-216	150	44
216-960	200	46
Above 960	500	54

The requirements are **FULFILLED**.

Remarks: The measurement was performed up to the 5th harmonic.

6 USED TEST EQUIPMENT AND ACCESSORIES

All test instruments used, in addition to the test accessories, are calibrated and verified regularly.

Test ID	Model / Type	Kind of Equipment	Manufacturer	Equipment No.
A 4	ESHS 30	EMI Test Receiver	Rohde & Schwarz München	02-02/03-05-002
	R 3162	Spectrum Analyzer	Advantest	02-02/11-05-003
	NNLK 8129	LISN	Schwarzbeck Mess-Elektron	02-02/20-05-001
	ESH 2 - Z 5	LISN	Rohde & Schwarz München	02-02/20-05-004
	N-4000-BNC	RF Cable	mikes-testingpartners gmbh	02-02/50-05-138
	N-1500-N	RF Cable	mikes-testingpartners gmbh	02-02/50-05-140
	ESH 3 - Z 2	Pulse Limiter	Rohde & Schwarz München	02-02/50-05-155
	PE1540	Power Supply	Phillips Fluke GmbH	02-02/50-07-031
CPC 3	FSP 30	Spectrum Analyzer	Rohde & Schwarz München	02-02/11-05-001
	THS730A	Handheld Scope	Tektronix GmbH	02-02/13-05-001
	PE1540	Power Supply	Phillips Fluke GmbH	02-02/50-07-031
MB	FSP 30	Spectrum Analyzer	Rohde & Schwarz München	02-02/11-05-001
	THS730A	Handheld Scope	Tektronix GmbH	02-02/13-05-001
	PE1540	Power Supply	Phillips Fluke GmbH	02-02/50-07-031
SEC 1-3	FSP 30	Spectrum Analyzer	Rohde & Schwarz München	02-02/11-05-001
	THS730A	Handheld Scope	Tektronix GmbH	02-02/13-05-001
	PE1540	Power Supply	Phillips Fluke GmbH	02-02/50-07-031
SER 2	ESVS 30	EMI Test Receiver	Rohde & Schwarz München	02-02/03-05-006
	VULB 9168	Trilog-Broadband Anten	Schwarzbeck Mess-Elektron	02-02/24-05-005
	S10162-B	RF Cable 33m	Huber + Suhner	02-02/50-05-031
	KK-EF393-21N-16	RF Cable 20m	Huber + Suhner	02-02/50-05-033
	NW-2000-NB	RF Cable	Huber + Suhner	02-02/50-05-113
	PE1540	Power Supply	Phillips Fluke GmbH	02-02/50-07-031
SER 3	FSP 30	Spectrum Analyzer	Rohde & Schwarz München	02-02/11-05-001
	AFS4-01000400-10-10P-4	RF Amplifier 1-4 GHz	PARZICH GMBH	02-02/17-05-003
	AMF-4F-04001200-15-10P	RF Amplifier 4-12 GHz	PARZICH GMBH	02-02/17-05-004
	AFS5-12001800-18-10P-6	RF Amplifier 12-18 GHz	PARZICH GMBH	02-02/17-06-002
	3117	Horn Antenna 1-18 GHz	EMCO Elektronik GmbH	02-02/24-05-009
	Sucoflex N-1600-SMA	RF Cable	novotronik Signalverarbeit	02-02/50-05-073
	Sucoflex N-2000-SMA	RF Cable	novotronik Signalverarbeit	02-02/50-05-075
	PE1540	Power Supply	Phillips Fluke GmbH	02-02/50-07-031

FCC ID: LYHRAP-V1

Equipment No.	Next Calib.	Last Calib.	Next Verif.	Last Verif.
A 4				
02-02/03-05-002	04/20/2008	04/20/2007		
02-02/11-05-003	09/17/2009	09/17/2007	09/17/2008	09/17/2007
02-02/20-05-001	05/13/2008	11/13/2007		
02-02/20-05-004	03/11/2008	04/11/2005	05/13/2008	11/13/2007
02-02/50-05-138				
02-02/50-05-140				
02-02/50-05-155	03/25/2008	09/25/2007		
02-02/50-07-031				
CPC 3				
02-02/11-05-001	12/06/2008	12/06/2006		
02-02/13-05-001	09/03/2008	09/03/2007		
02-02/50-07-031				
MB				
02-02/11-05-001	12/06/2008	12/06/2006		
02-02/13-05-001	09/03/2008	09/03/2007		
02-02/50-07-031				
SEC 1-3				
02-02/11-05-001	12/06/2008	12/06/2006		
02-02/13-05-001	09/03/2008	09/03/2007		
02-02/50-07-031				
SER 2				
02-02/03-05-006	07/24/2008	07/24/2007		
02-02/24-05-005	04/15/2008	04/15/2005	09/21/2008	09/21/2007
02-02/50-05-031				
02-02/50-05-033				
02-02/50-05-113				
02-02/50-07-031				
SER 3				
02-02/11-05-001	12/06/2008	12/06/2006		
02-02/17-05-003				
02-02/17-05-004				
02-02/17-06-002				
02-02/24-05-009	01/16/2009	01/16/2008		
02-02/50-05-073				
02-02/50-05-075				
02-02/50-07-031				