

Radio Technology = WLAN a, Operating Frequency = mid, Measurement range = 1GHz - 26GHz, Subband = U-NII-1 (S03\_AC02)

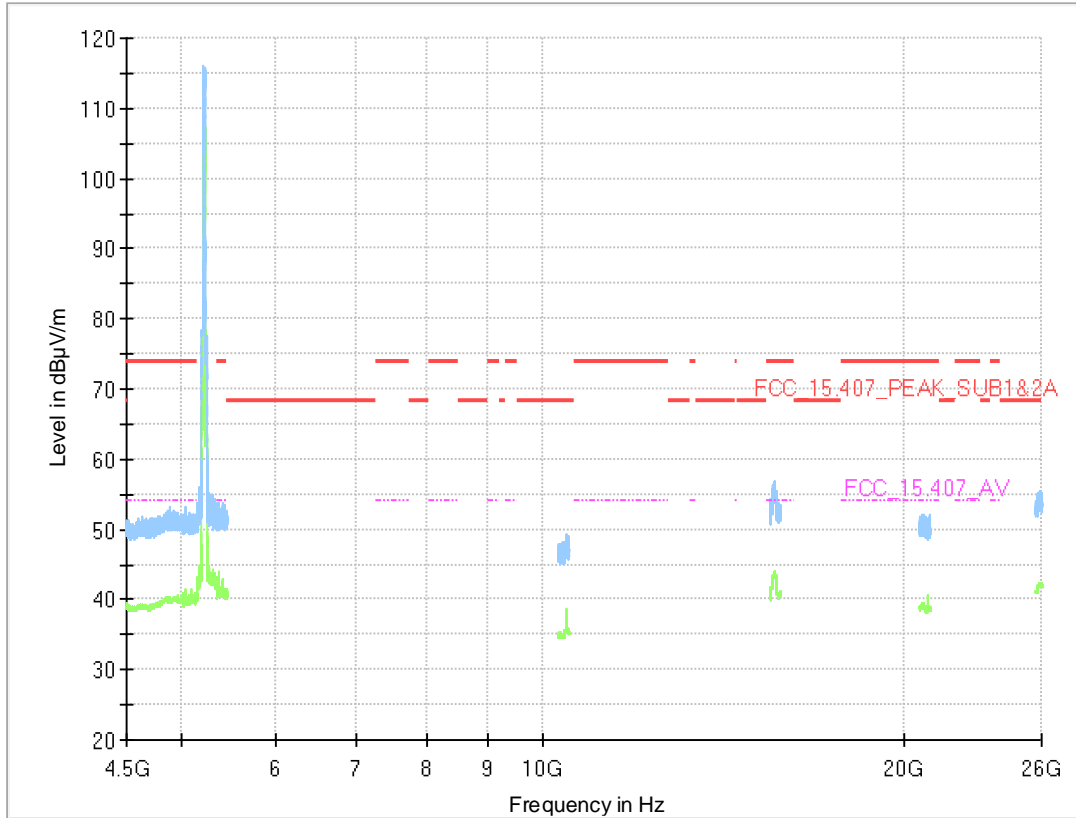

**Final Result**

Frequency (MHz)	MaxPeak (dBµV/m)	CAverage (dBµV/m)	Limit (dBµV/m)	Margin (dB)	Meas. Time (ms)	Bandwidth (kHz)	Height (cm)	Pol	Azimuth (deg)	Elevation (deg)	Corr. (dB/m)
---	---	---	---	---	---	---	---		---	---	---

Radio Technology = WLAN a, Operating Frequency = high, Measurement range = 1GHz - 26GHz, Subband = U-NII-1 (S03\_AC02)

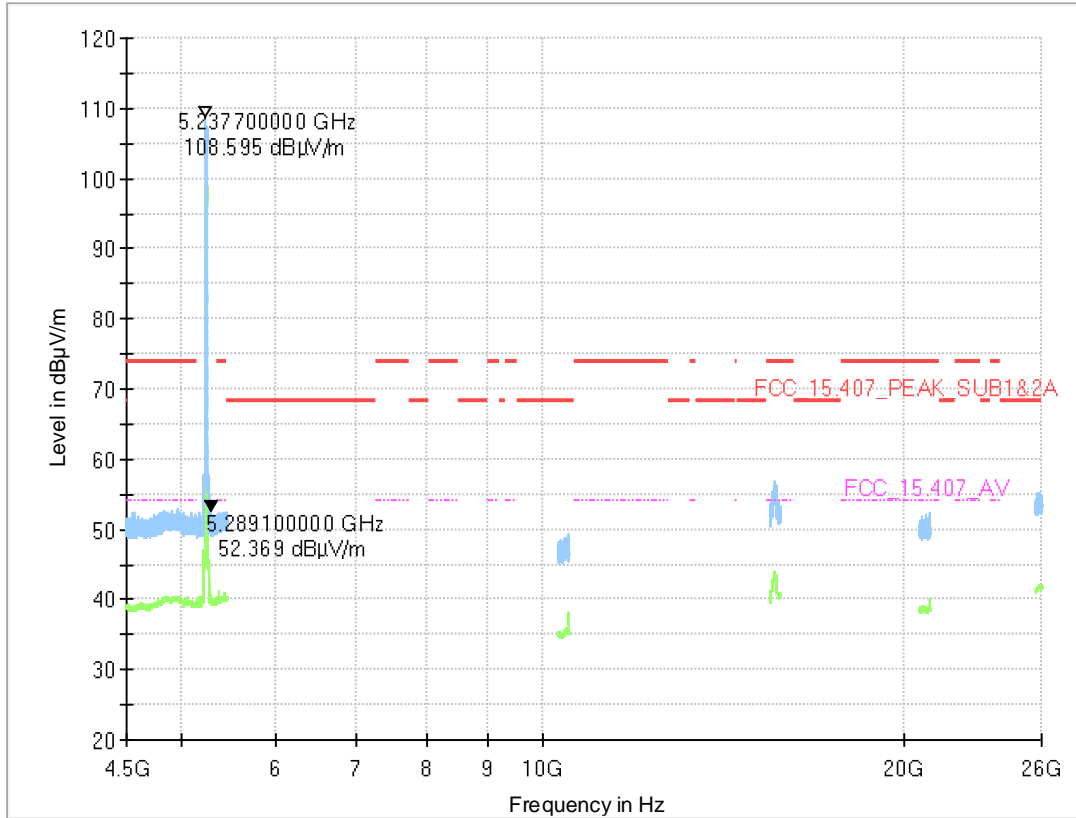

**Final\_Result**

Frequency (MHz)	MaxPeak (dBµV/m)	CAverage (dBµV/m)	Limit (dBµV/m)	Margin (dB)	Meas. Time (ms)	Bandwidth (kHz)	Height (cm)	Pol	Azimuth (deg)	Elevation (deg)	Corr. (dB/m)
---	---	---	---	---	---	---	---		---	---	---

Radio Technology = WLAN a, Operating Frequency = low, Measurement range = 1GHz - 26GHz, Subband = U-NII-3 (S03\_AC02)

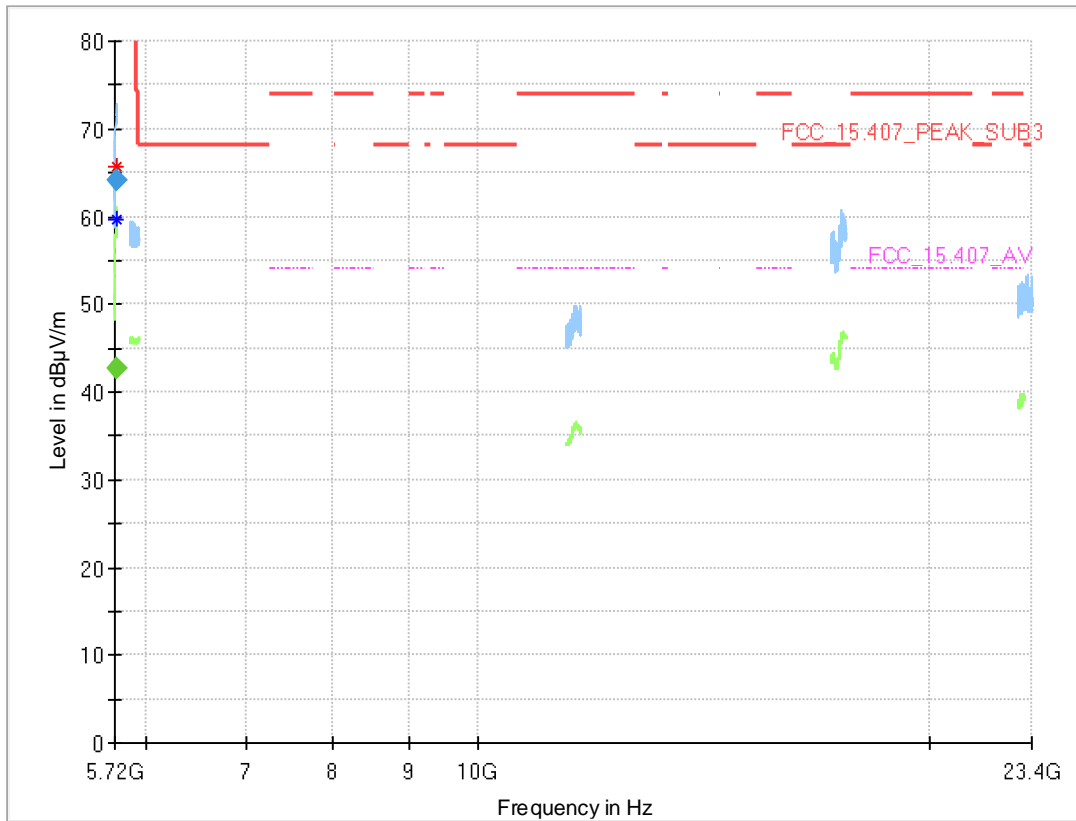

### Final Result

Frequency (MHz)	MaxPeak (dBµV/m)	CAverage (dBµV/m)	Limit (dBµV/m)	Margin (dB)	Meas. Time (ms)	Bandwidth (kHz)	Height (cm)	Pol	Azimuth (deg)	Elevation (deg)	Corr. (dB/m)
5724.400	---	42.7	---	---	1000.0	1000.000	150.0	H	49.0	93.0	14.2
5724.400	64.1	---	120.8	56.75	1000.0	1000.000	150.0	H	49.0	93.0	14.2

Radio Technology = WLAN a, Operating Frequency = mid, Measurement range = 1GHz - 26GHz, Subband = U-NII-3 (S03\_AC02)

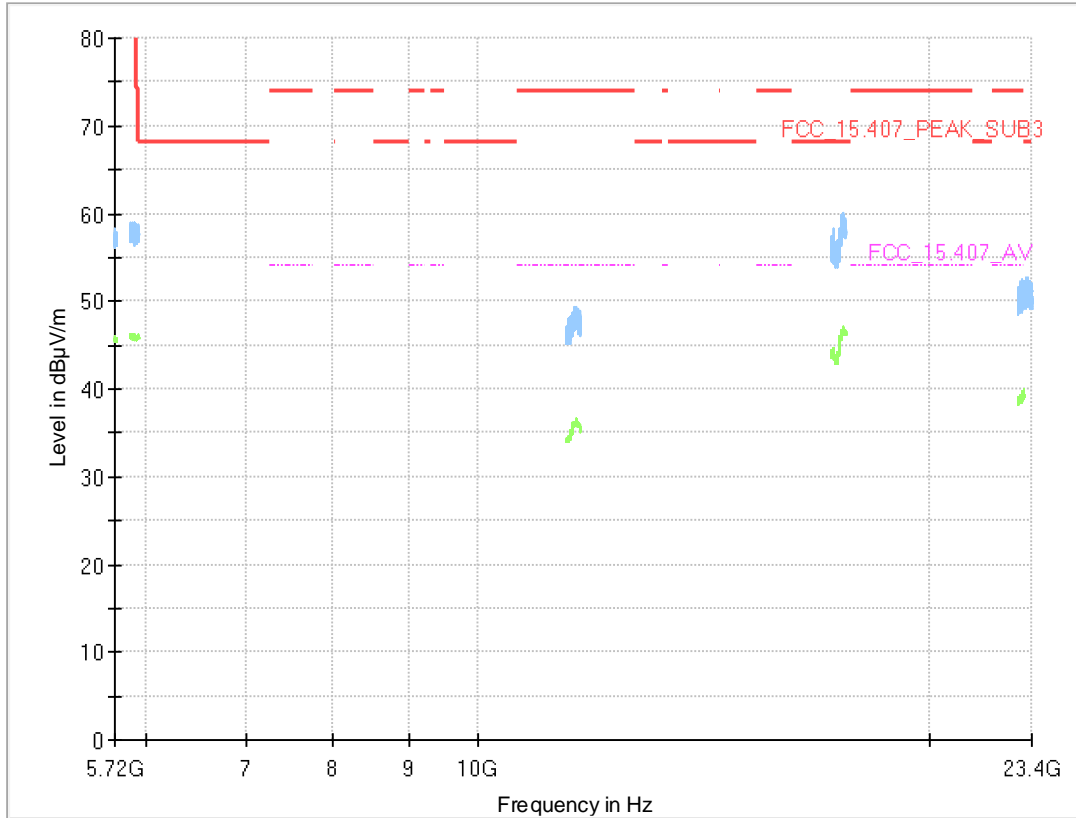

**Final\_Result**

Frequency (MHz)	MaxPeak (dBµV/m)	CAverage (dBµV/m)	Limit (dBµV/m)	Margin (dB)	Meas. Time (ms)	Bandwidth (kHz)	Height (cm)	Pol	Azimuth (deg)	Elevation (deg)	Corr. (dB/m)
---	---	---	---	---	---	---	---		---	---	---

Radio Technology = WLAN a, Operating Frequency = high, Measurement range = 1GHz - 26GHz, Subband = U-NII-3 (S03\_AC02)

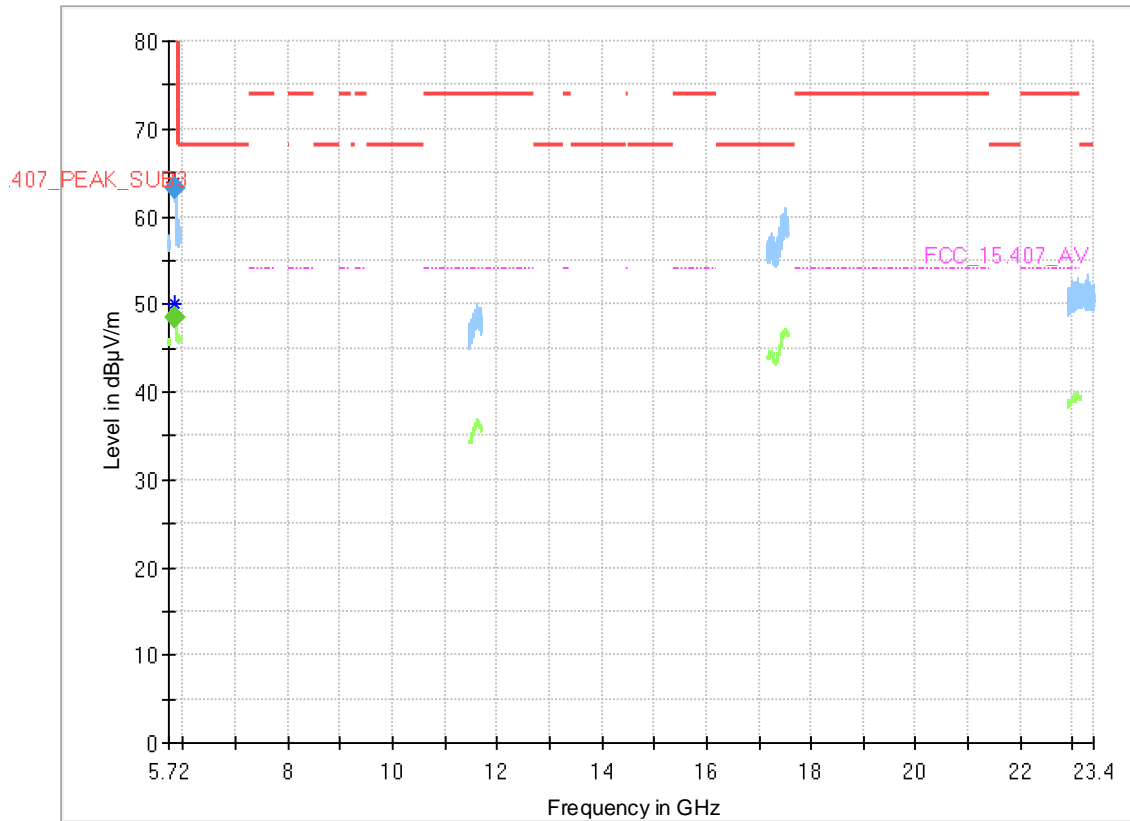

### Final Result

Frequency (MHz)	MaxPeak (dBµV/m)	CAverage (dBµV/m)	Limit (dBµV/m)	Margin (dB)	Meas. Time (ms)	Bandwidth (kHz)	Height (cm)	Pol	Azimuth (deg)	Elevation (deg)	Corr. (dB/m)
5850.720	63.2	---	120.5	57.36	1000.0	1000.000	150.0	H	44.0	105.0	14.9
5850.720	---	48.4	---	---	1000.0	1000.000	150.0	H	44.0	105.0	14.9

Radio Technology = WLAN ax 40 MHz MIMO, Operating Frequency = high, Measurement range = 1GHz - 26GHz, Subband = U-NII-3 (S05\_AD02)

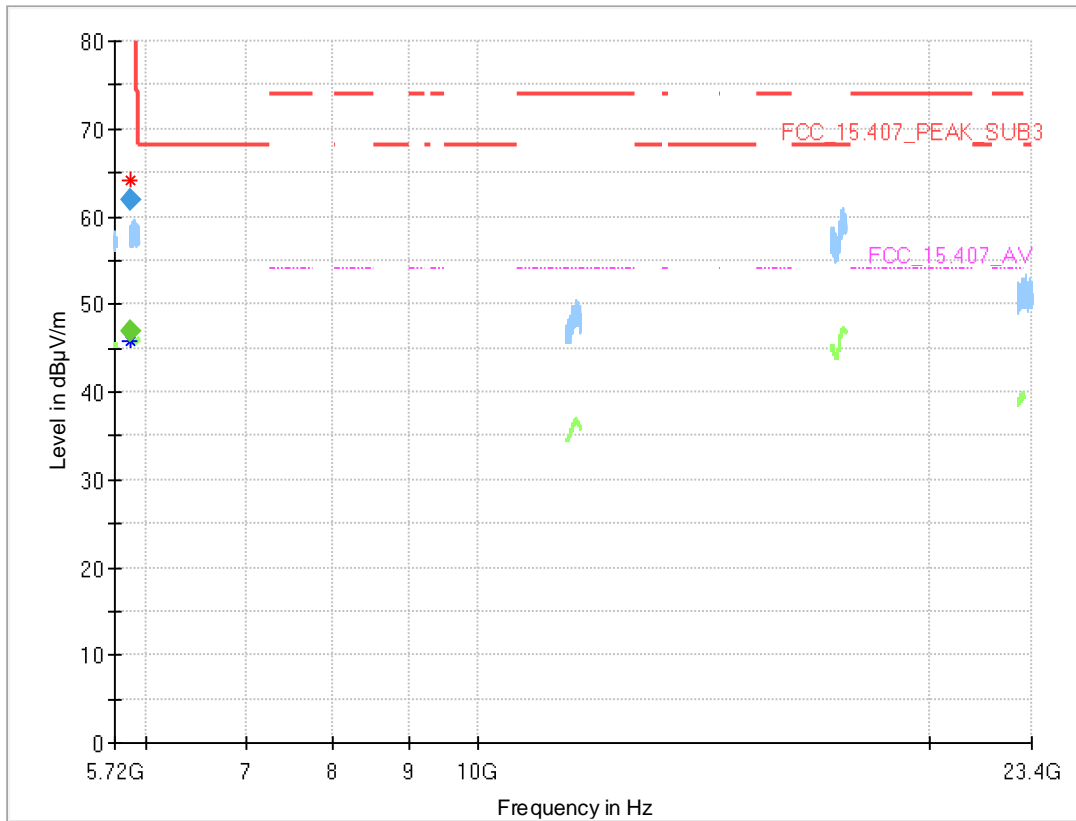

### Final Result

Frequency (MHz)	MaxPeak (dBµV/m)	CAverage (dBµV/m)	Limit (dBµV/m)	Margin (dB)	Meas. Time (ms)	Bandwidth (kHz)	Height (cm)	Pol	Azimuth (deg)	Elevation (deg)	Corr. (dB/m)
5850.640	---	47.0	---	---	1000.0	1000.000	150.0	V	1.0	96.0	14.9
5850.640	61.9	---	120.7	58.89	1000.0	1000.000	150.0	V	1.0	96.0	14.9

Radio Technology = WLAN ac 40 MHz, Operating Frequency = high, Measurement range = 1GHz - 26GHz, Subband = U-NII-3 (S05\_AD02)

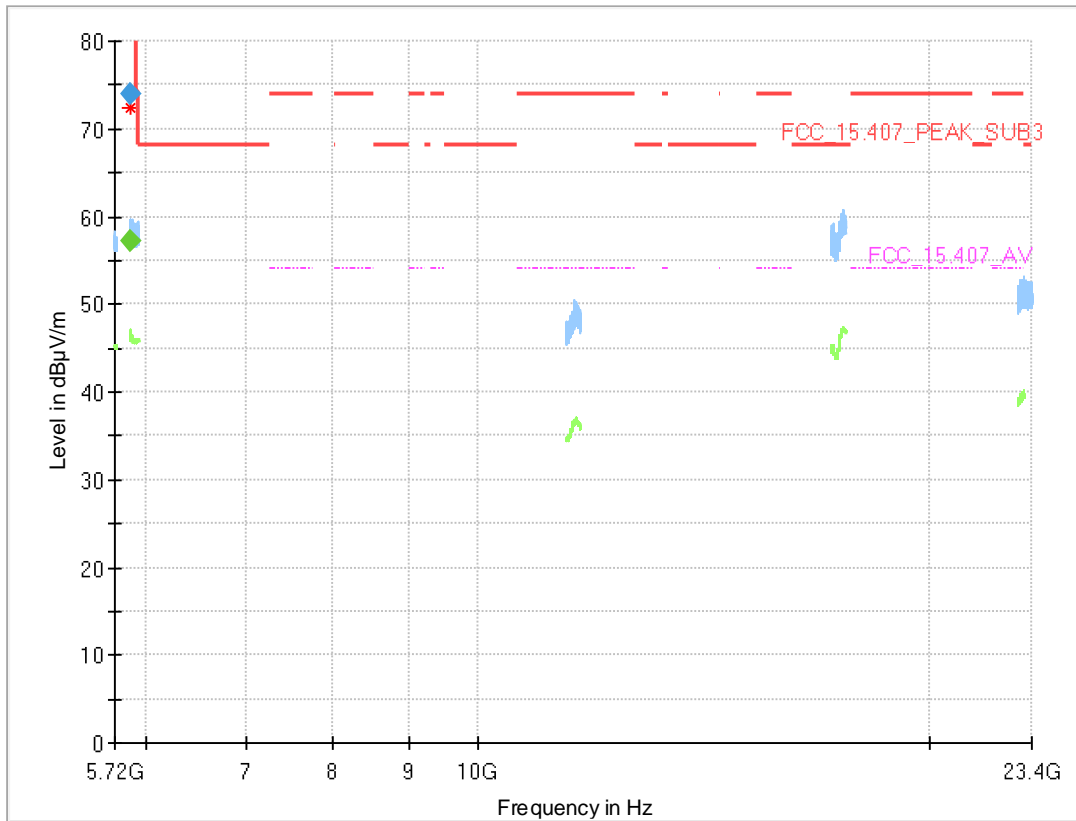

### Final Result

Frequency (MHz)	MaxPeak (dBµV/m)	CAverage (dBµV/m)	Limit (dBµV/m)	Margin (dB)	Meas. Time (ms)	Bandwidth (kHz)	Height (cm)	Pol	Azimuth (deg)	Elevation (deg)	Corr. (dB/m)
5851.440	---	57.1	---	---	1000.0	1000.000	150.0	V	-2.0	98.0	14.9
5851.440	74.0	---	118.9	44.96	1000.0	1000.000	150.0	V	-2.0	98.0	14.9

Radio Technology = WLAN n 20 MHz, Operating Frequency = high, Measurement range = 1GHz - 26GHz, Subband = U-NII-3 (S05\_AD02)

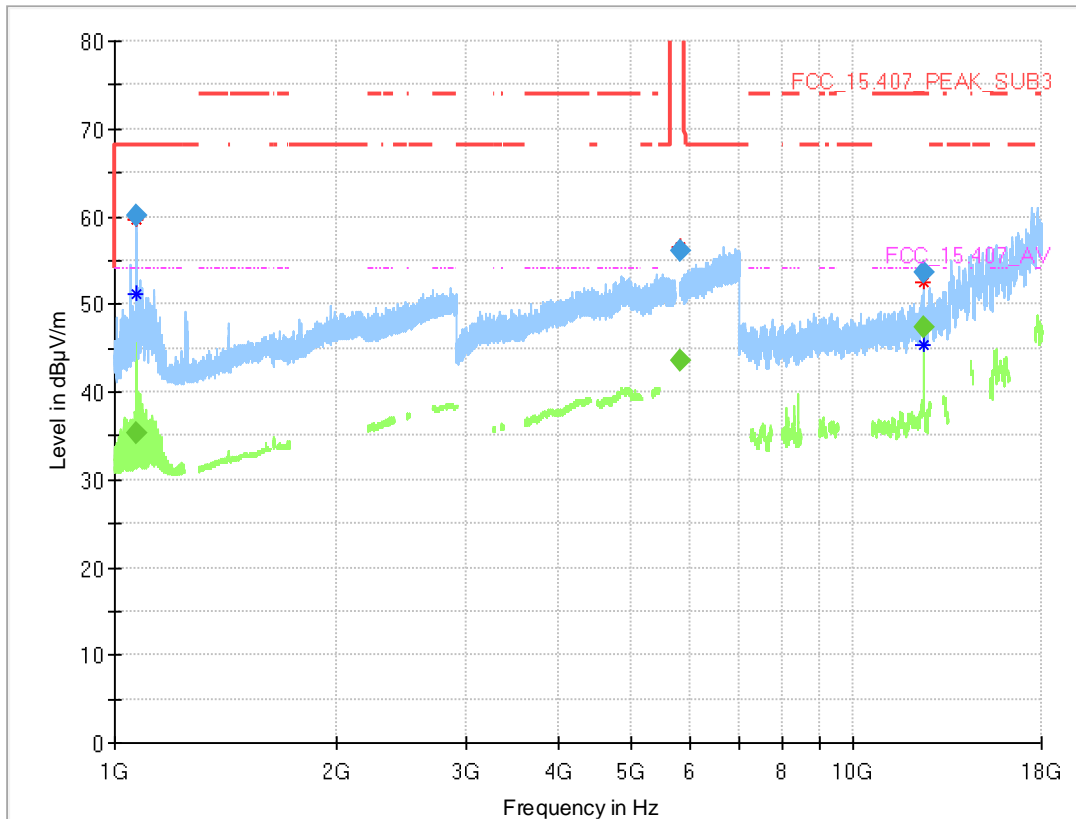

### Final Result

Frequency (MHz)	MaxPeak (dBµV/m)	CAverage (dBµV/m)	Limit (dBµV/m)	Margin (dB)	Meas. Time (ms)	Bandwidth (kHz)	Height (cm)	Pol	Azimuth (deg)	Elevation (deg)	Corr. (dB/m)
1071.160	---	35.4	54.00	18.60	1000.0	1000.000	150.0	H	-79.0	-15.0	-1.4
1071.160	60.1	---	68.20	8.05	1000.0	1000.000	150.0	H	-79.0	-15.0	-1.4
5850.800	---	43.6	---	---	1000.0	1000.000	150.0	V	40.0	15.0	14.9
5850.800	56.1	---	120.3	64.31	1000.0	1000.000	150.0	V	40.0	15.0	14.9
12500.605	---	47.3	54.00	6.72	1000.0	1000.000	150.0	H	-140.0	88.0	-6.7
12500.605	53.5	---	74.00	20.47	1000.0	1000.000	150.0	H	-140.0	88.0	-6.7



Radio Technology = WLAN n 20 MHz, Operating Frequency = high, Measurement range = 1GHz - 26GHz, Subband = U-NII-1 (S05\_AD02)

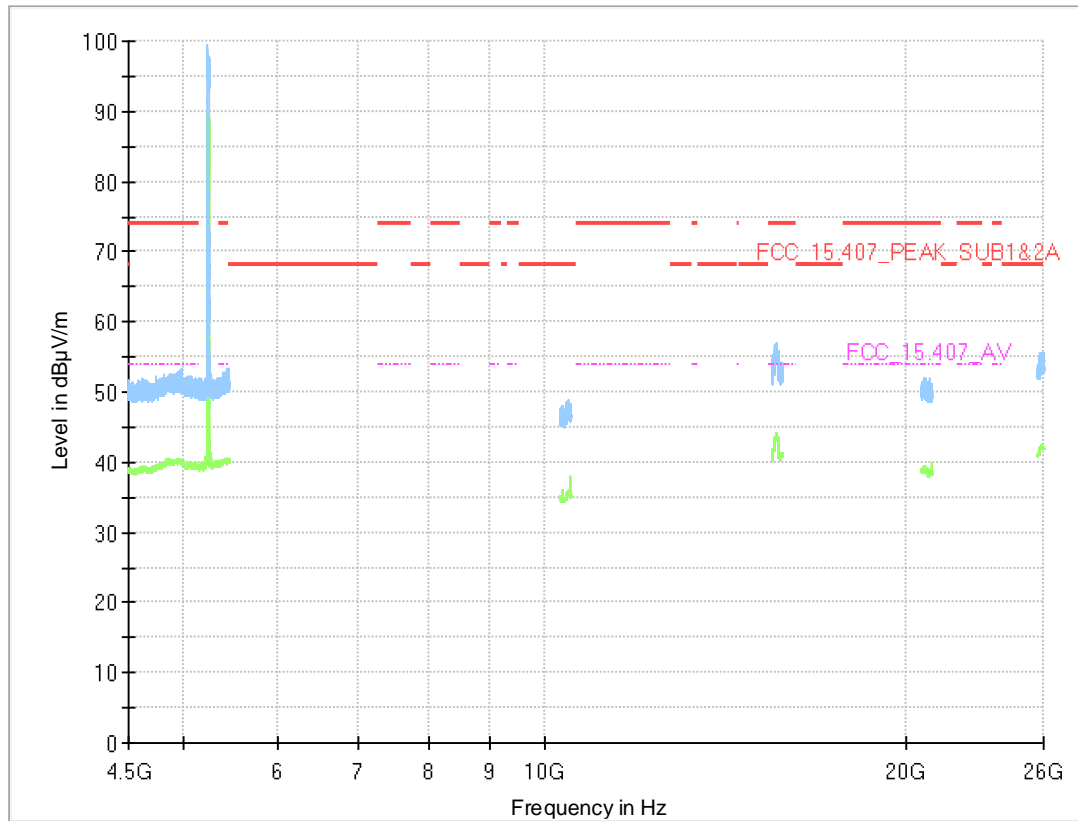

**Final Result**

Frequency (MHz)	MaxPeak (dBµV/m)	CAverage (dBµV/m)	Limit (dBµV/m)	Margin (dB)	Meas. Time (ms)	Bandwidth (kHz)	Height (cm)	Pol	Azimuth (deg)	Elevation (deg)	Corr. (dB/m)
---	---	---	---	---	---	---	---		---	---	---

Radio Technology = WLAN n 40 MHz MIMO, Operating Frequency = high, Measurement range = 1GHz - 26GHz, Subband = U-NII-3 (S05\_AD02)

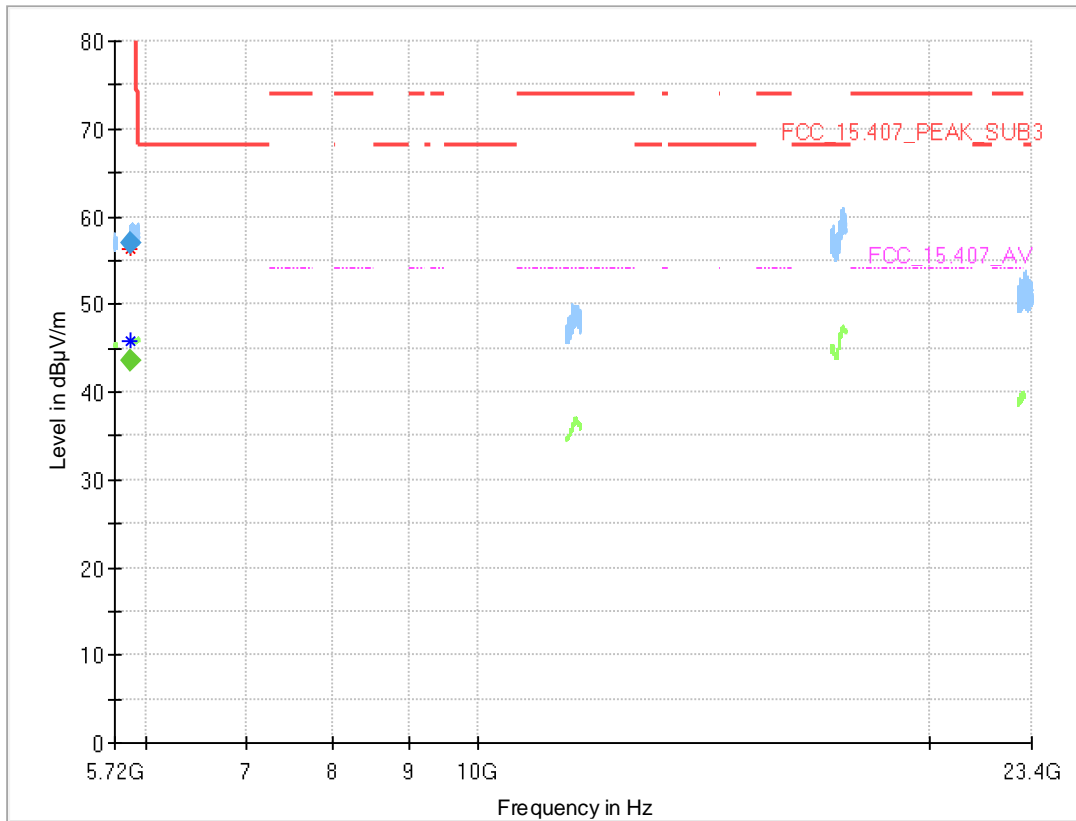

### Final Result

Frequency (MHz)	MaxPeak (dBµV/m)	CAverage (dBµV/m)	Limit (dBµV/m)	Margin (dB)	Meas. Time (ms)	Bandwidth (kHz)	Height (cm)	Pol	Azimuth (deg)	Elevation (deg)	Corr. (dB/m)
5850.720	---	43.6	---	---	1000.0	1000.000	150.0	H	126.0	92.0	14.9
5850.720	57.0	---	120.5	63.55	1000.0	1000.000	150.0	H	126.0	92.0	14.9

Radio Technology = WLAN a MIMO, Operating Frequency = low, Measurement range = 1GHz - 26GHz, Subband = U-NII-1 (S05\_AD02)

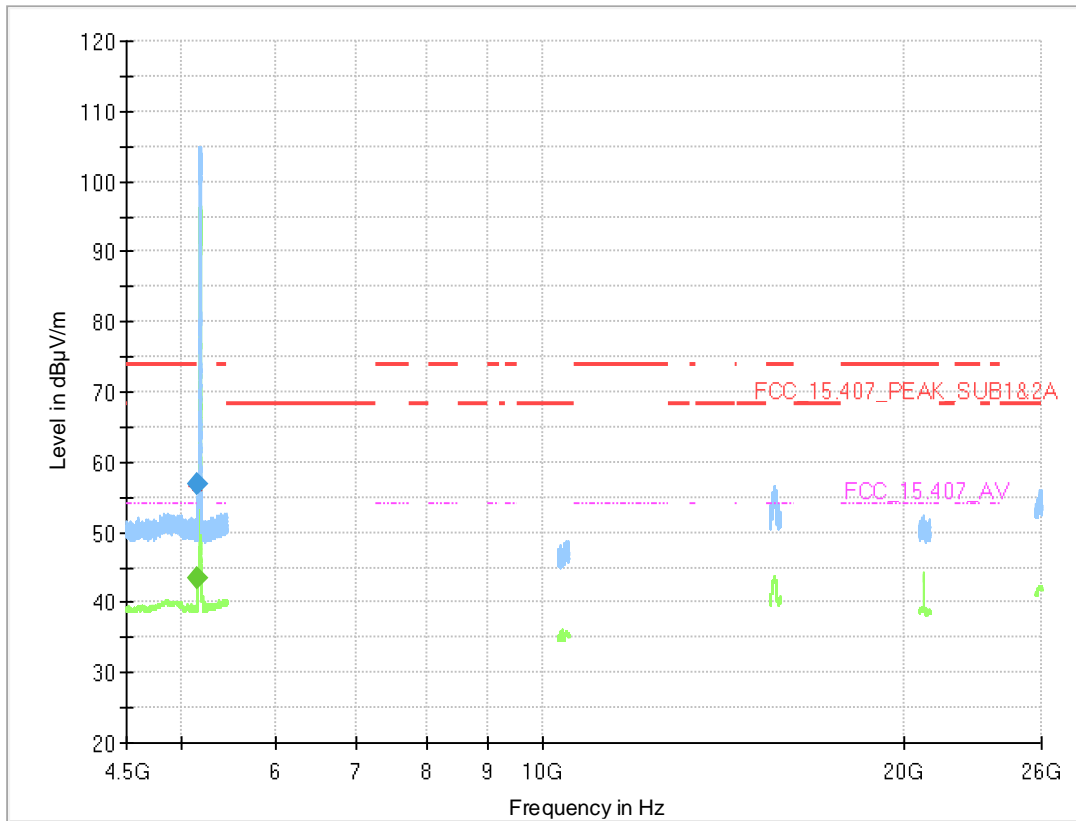

**Final Result**

Frequency (MHz)	MaxPeak (dBµV/m)	CAverage (dBµV/m)	Limit (dBµV/m)	Margin (dB)	Meas. Time (ms)	Bandwidth (kHz)	Height (cm)	Pol	Azimuth (deg)	Elevation (deg)	Corr. (dB/m)
5150.000	---	43.6	54.00	10.43	1000.0	1000.000	150.0	V	4.0	92.0	13.5
5150.000	57.0	---	74.00	17.03	1000.0	1000.000	150.0	V	4.0	92.0	13.5

Radio Technology = WLAN a MIMO, Operating Frequency = mid, Measurement range = 1GHz - 26GHz, Subband = U-NII-1 (S05\_AD02)

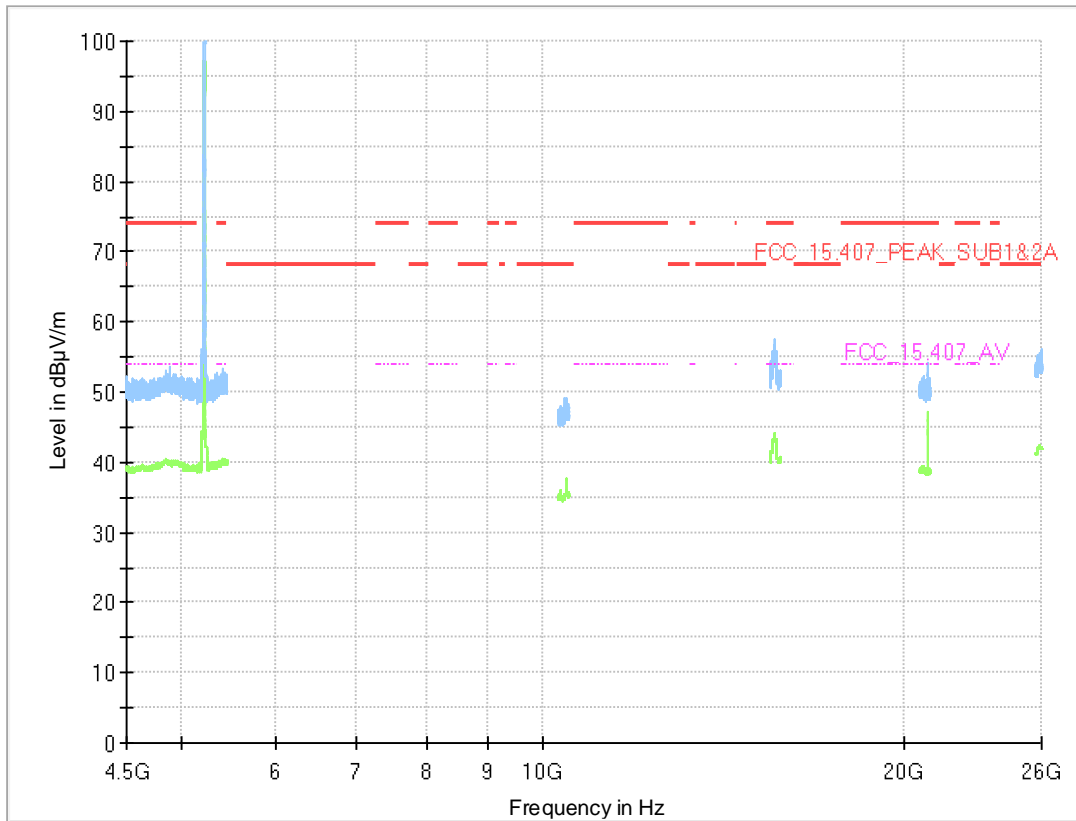

**Final Result**

Frequency (MHz)	MaxPeak (dBµV/m)	CAverage (dBµV/m)	Limit (dBµV/m)	Margin (dB)	Meas. Time (ms)	Bandwidth (kHz)	Height (cm)	Pol	Azimuth (deg)	Elevation (deg)	Corr. (dB/m)
---	---	---	---	---	---	---	---		---	---	---

Radio Technology = WLAN a MIMO, Operating Frequency = high, Measurement range = 1GHz  
 - 26GHz, Subband = U-NII-1  
 (S05\_AD02)

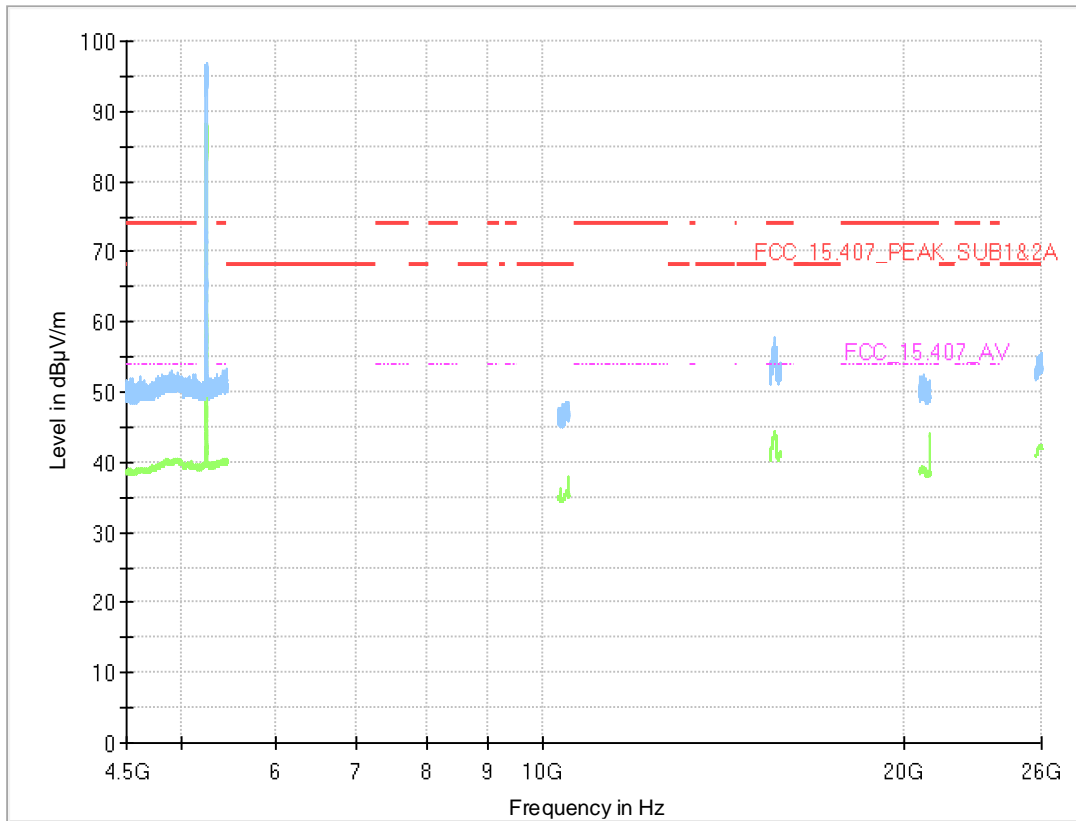

**Final Result**

Frequency (MHz)	MaxPeak (dBµV/m)	CAverage (dBµV/m)	Limit (dBµV/m)	Margin (dB)	Meas. Time (ms)	Bandwidth (kHz)	Height (cm)	Pol	Azimuth (deg)	Elevation (deg)	Corr. (dB/m)
---	---	---	---	---	---	---	---		---	---	---

Radio Technology = WLAN a MIMO, Operating Frequency = low, Measurement range = 1GHz - 26GHz, Subband = U-NII-3 (S05\_AD02)

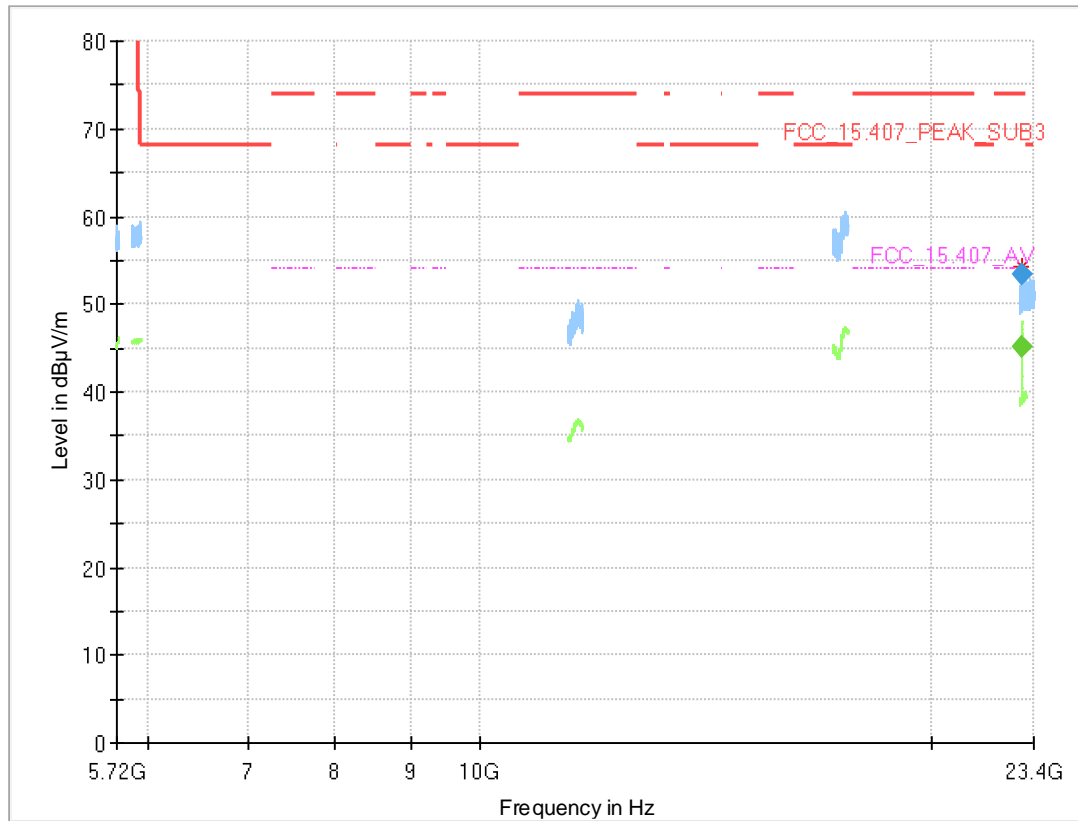

### Final Result

Frequency (MHz)	MaxPeak (dBµV/m)	CAverage (dBµV/m)	Limit (dBµV/m)	Margin (dB)	Meas. Time (ms)	Bandwidth (kHz)	Height (cm)	Pol	Azimuth (deg)	Elevation (deg)	Corr. (dB/m)
22980.135	---	45.0	54.00	8.96	1000.0	1000.000	150.0	V	-169.0	-2.0	19.7
22980.135	53.4	---	74.00	20.59	1000.0	1000.000	150.0	V	-169.0	-2.0	19.7

Radio Technology = WLAN a MIMO, Operating Frequency = mid, Measurement range = 1GHz - 26GHz, Subband = U-NII-3 (S05\_AD02)

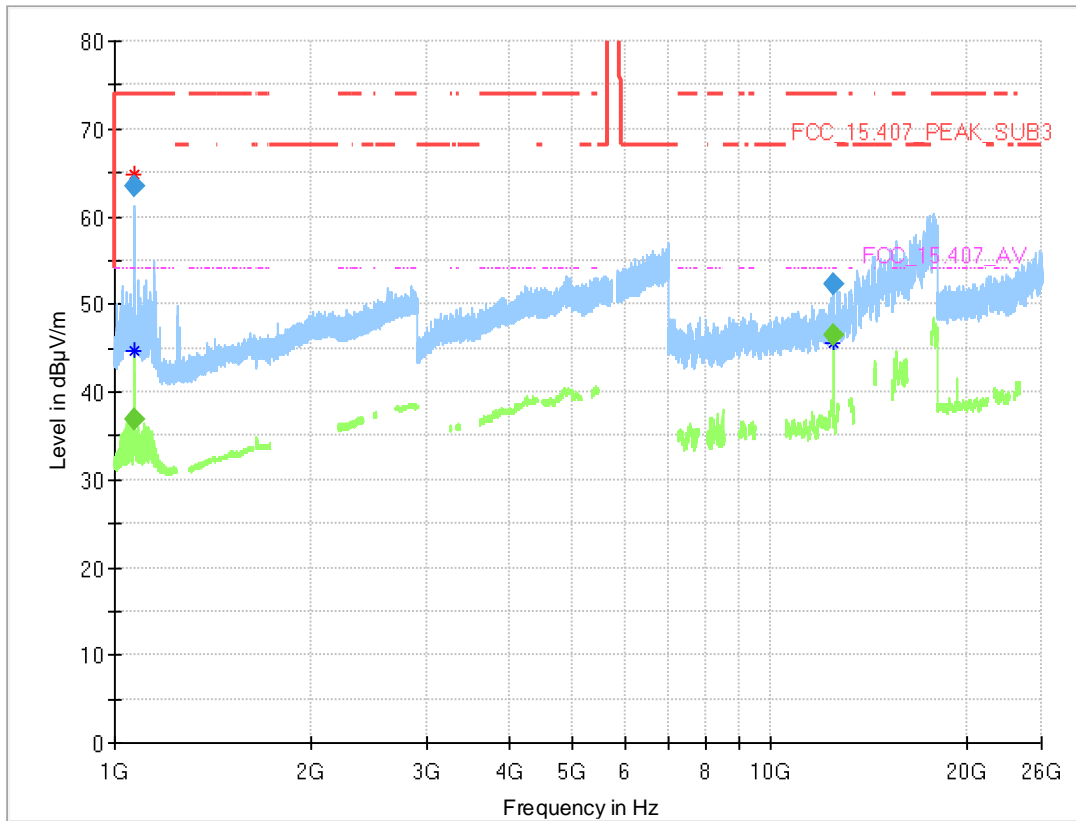

### Final Result

Frequency (MHz)	MaxPeak (dBµV/m)	CAverage (dBµV/m)	Limit (dBµV/m)	Margin (dB)	Meas. Time (ms)	Bandwidth (kHz)	Height (cm)	Pol	Azimuth (deg)	Elevation (deg)	Corr. (dB/m)
1071.040	---	37.0	54.00	17.02	1000.0	1000.000	150.0	V	6.0	-12.0	-1.4
1071.040	63.5	---	74.00	10.50	1000.0	1000.000	150.0	V	6.0	-12.0	-1.4
12500.500	---	46.6	54.00	7.43	1000.0	1000.000	150.0	H	-140.0	88.0	-6.7
12500.500	52.3	---	74.00	21.72	1000.0	1000.000	150.0	H	-140.0	88.0	-6.7

Radio Technology = WLAN a MIMO, Operating Frequency = high, Measurement range = 1GHz - 26GHz, Subband = U-NII-3 (S05\_AD02)

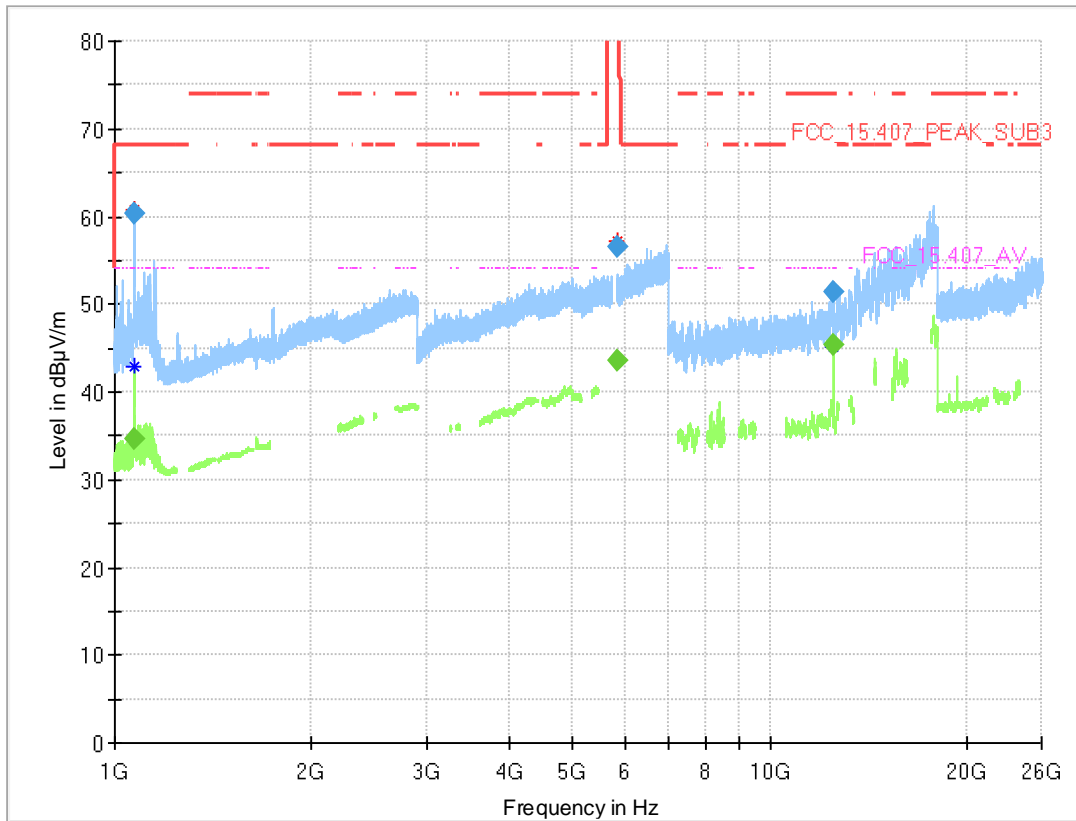

### Final Result

Frequency (MHz)	MaxPeak (dBµV/m)	CAverage (dBµV/m)	Limit (dBµV/m)	Margin (dB)	Meas. Time (ms)	Bandwidth (kHz)	Height (cm)	Pol	Azimuth (deg)	Elevation (deg)	Corr. (dB/m)
1071.160	60.4	---	68.20	7.77	1000.0	1000.000	150.0	V	-183.0	105.0	-1.4
1071.160	---	34.6	54.00	19.44	1000.0	1000.000	150.0	V	-183.0	105.0	-1.4
5851.800	---	43.6	---	---	1000.0	1000.000	150.0	H	51.0	78.0	14.9
5851.800	56.5	---	118.1	61.55	1000.0	1000.000	150.0	H	51.0	78.0	14.9
12500.605	51.5	---	74.00	22.52	1000.0	1000.000	150.0	H	-140.0	90.0	-6.7
12500.605	---	45.4	54.00	8.58	1000.0	1000.000	150.0	H	-140.0	90.0	-6.7



Radio Technology = WLAN n 20 MHz, Operating Frequency = low, Measurement range = 1GHz - 26GHz, Subband = U-NII-1 (S05\_AD02)

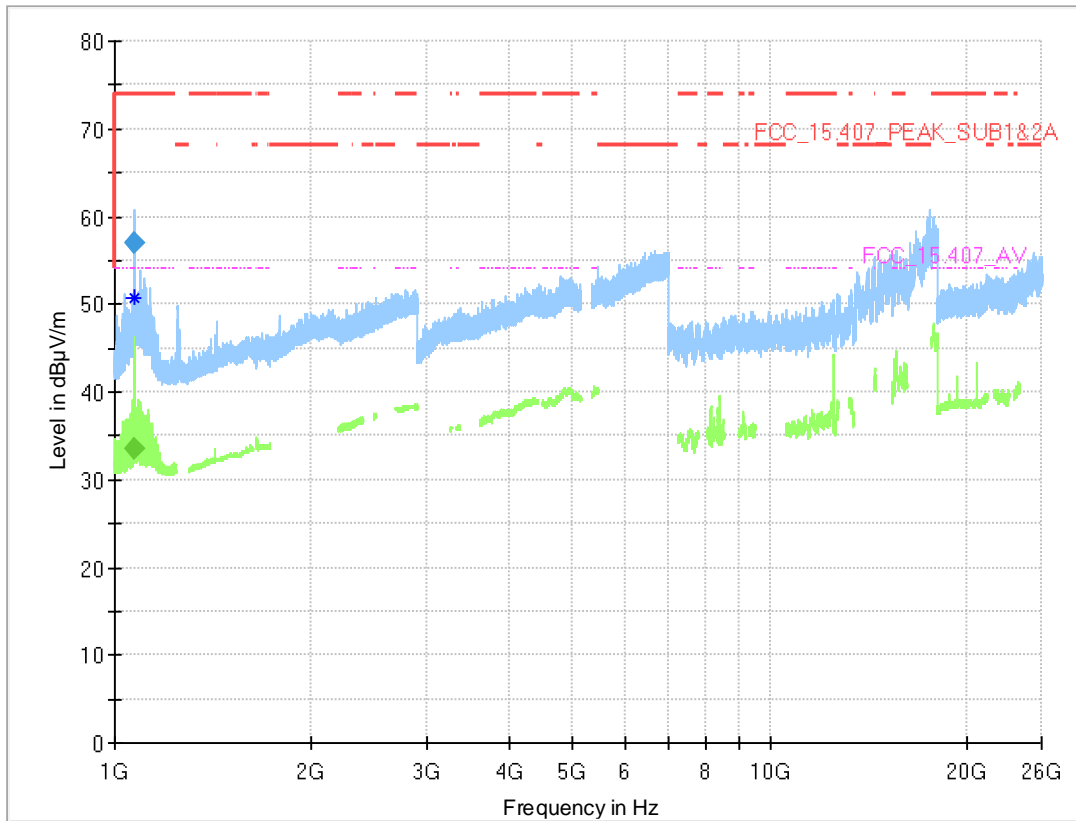

### Final Result

Frequency (MHz)	MaxPeak (dBµV/m)	CAverage (dBµV/m)	Limit (dBµV/m)	Margin (dB)	Meas. Time (ms)	Bandwidth (kHz)	Height (cm)	Pol	Azimuth (deg)	Elevation (deg)	Corr. (dB/m)
1070.920	---	33.4	54.00	20.56	1000.0	1000.000	150.0	H	-91.0	-15.0	-1.4
1070.920	57.0	---	74.00	17.01	1000.0	1000.000	150.0	H	-91.0	-15.0	-1.4

Radio Technology = WLAN n 20 MHz, Operating Frequency = mid, Measurement range = 1GHz - 26GHz, Subband = U-NII-1 (S05\_AD02)

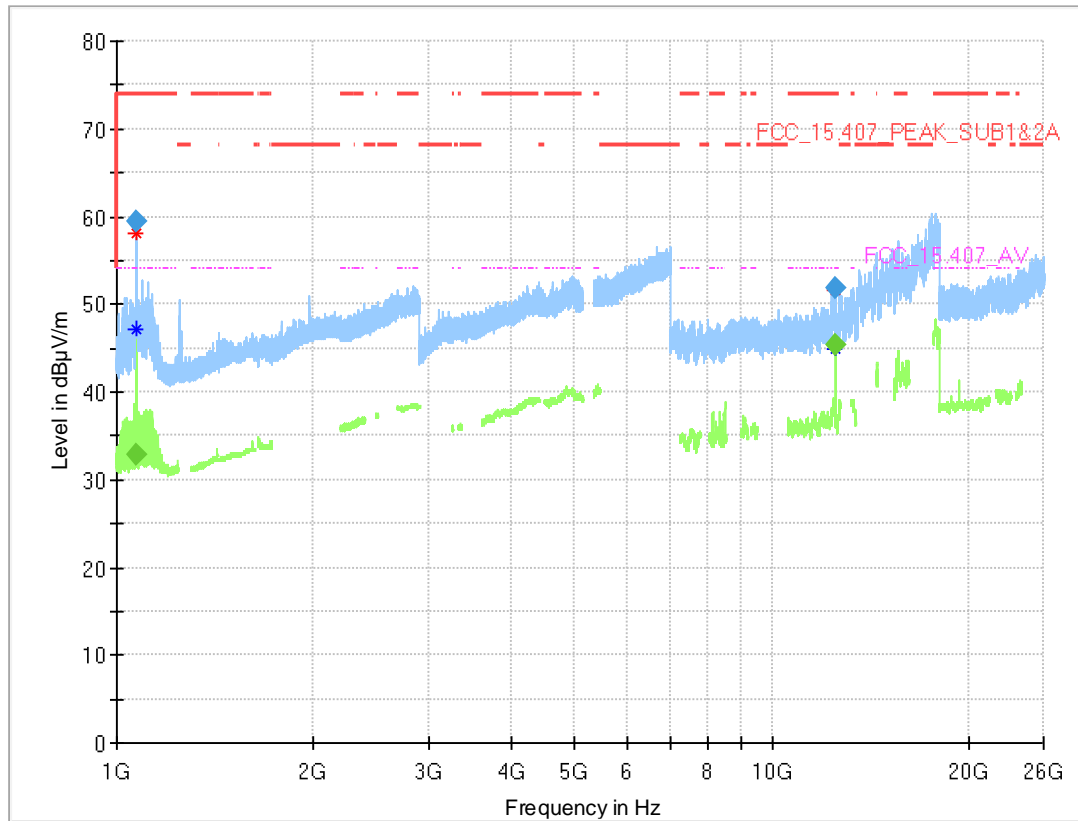

### Final Result

Frequency (MHz)	MaxPeak (dBµV/m)	CAverage (dBµV/m)	Limit (dBµV/m)	Margin (dB)	Meas. Time (ms)	Bandwidth (kHz)	Height (cm)	Pol	Azimuth (deg)	Elevation (deg)	Corr. (dB/m)
1071.520	---	32.8	54.00	21.23	1000.0	1000.000	150.0	H	48.0	-15.0	-1.4
1071.520	59.5	---	74.00	14.53	1000.0	1000.000	150.0	H	48.0	-15.0	-1.4
12500.605	---	45.3	54.00	8.66	1000.0	1000.000	150.0	H	-44.0	101.0	-6.7
12500.605	51.9	---	74.00	22.07	1000.0	1000.000	150.0	H	-44.0	101.0	-6.7

Radio Technology = WLAN n 20 MHz, Operating Frequency = low, Measurement range = 1GHz - 26GHz, Subband = U-NII-3 (S05\_AD02)

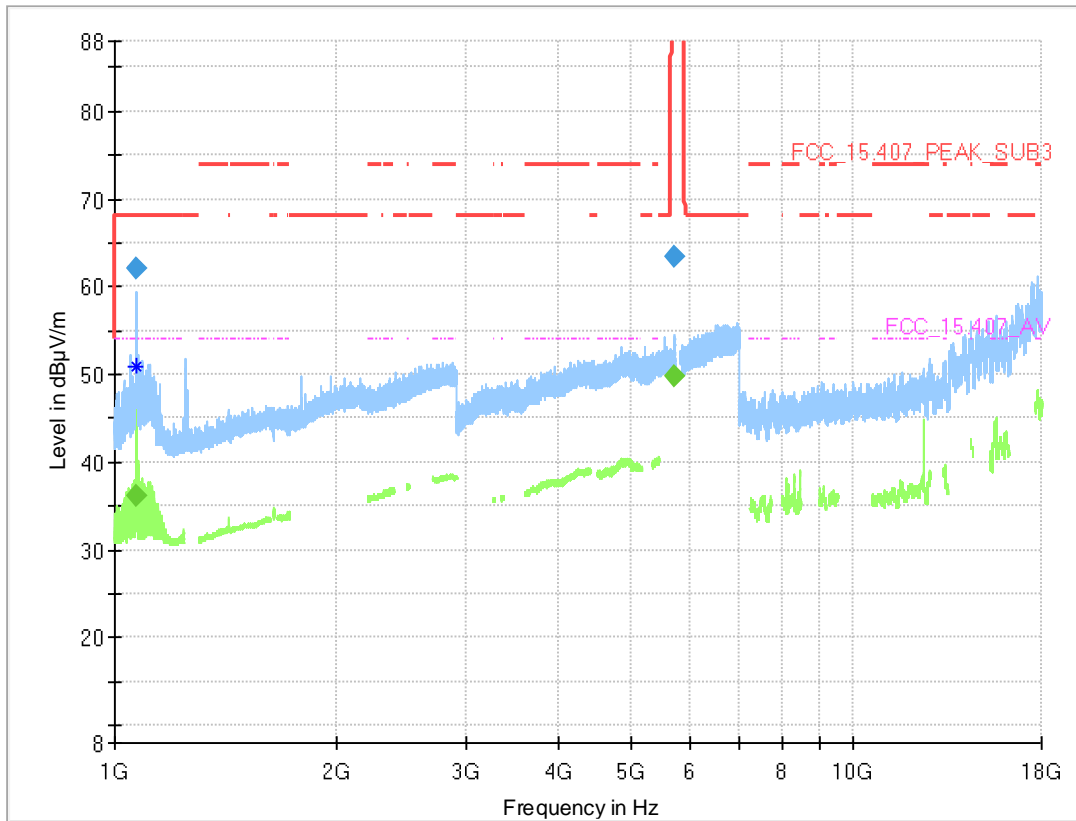

### Final Result

Frequency (MHz)	MaxPeak (dBµV/m)	CAverage (dBµV/m)	Limit (dBµV/m)	Margin (dB)	Meas. Time (ms)	Bandwidth (kHz)	Height (cm)	Pol	Azimuth (deg)	Elevation (deg)	Corr. (dB/m)
1071.280	---	36.2	54.00	17.83	1000.0	1000.000	150.0	V	53.0	12.0	-1.4
1071.280	62.1	---	68.20	6.11	1000.0	1000.000	150.0	V	53.0	12.0	-1.4
5724.600	---	49.7	---	---	1000.0	1000.000	150.0	V	-5.0	92.0	14.2
5724.600	63.5	---	121.2	57.77	1000.0	1000.000	150.0	V	-5.0	92.0	14.2

Radio Technology = WLAN n 40 MHz MIMO, Operating Frequency = low, Measurement range = 1GHz - 26GHz, Subband = U-NII-1 (S05\_AD02)

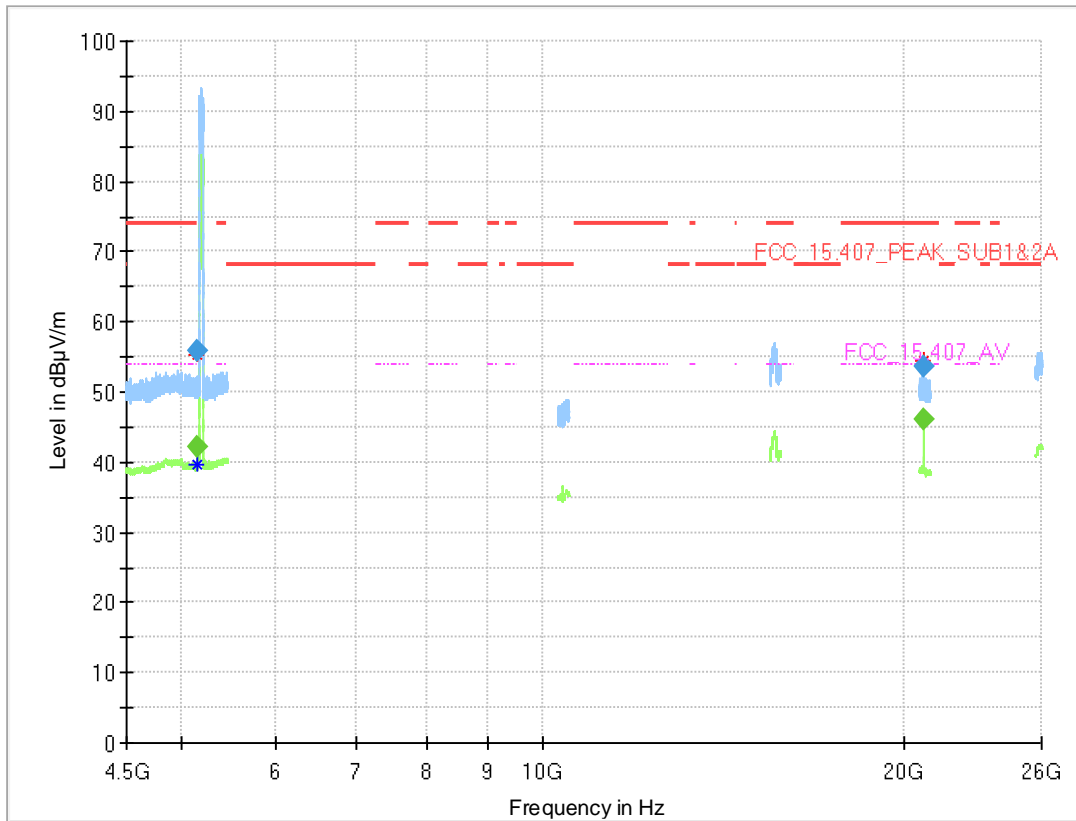

### Final Result

Frequency (MHz)	MaxPeak (dBµV/m)	CAverage (dBµV/m)	Limit (dBµV/m)	Margin (dB)	Meas. Time (ms)	Bandwidth (kHz)	Height (cm)	Pol	Azimuth (deg)	Elevation (deg)	Corr. (dB/m)
5150.000	---	42.3	54.00	11.74	1000.0	1000.000	150.0	H	-132.0	-9.0	13.5
5150.000	55.8	---	74.00	18.22	1000.0	1000.000	150.0	H	-132.0	-9.0	13.5
20759.800	---	46.0	54.00	8.04	1000.0	1000.000	150.0	V	-178.0	-3.0	18.3
20759.800	53.6	---	74.00	20.44	1000.0	1000.000	150.0	V	-178.0	-3.0	18.3

Radio Technology = WLAN n 40 MHz MIMO, Operating Frequency = high, Measurement range = 1GHz - 26GHz, Subband = U-NII-1 (S05\_AD02)

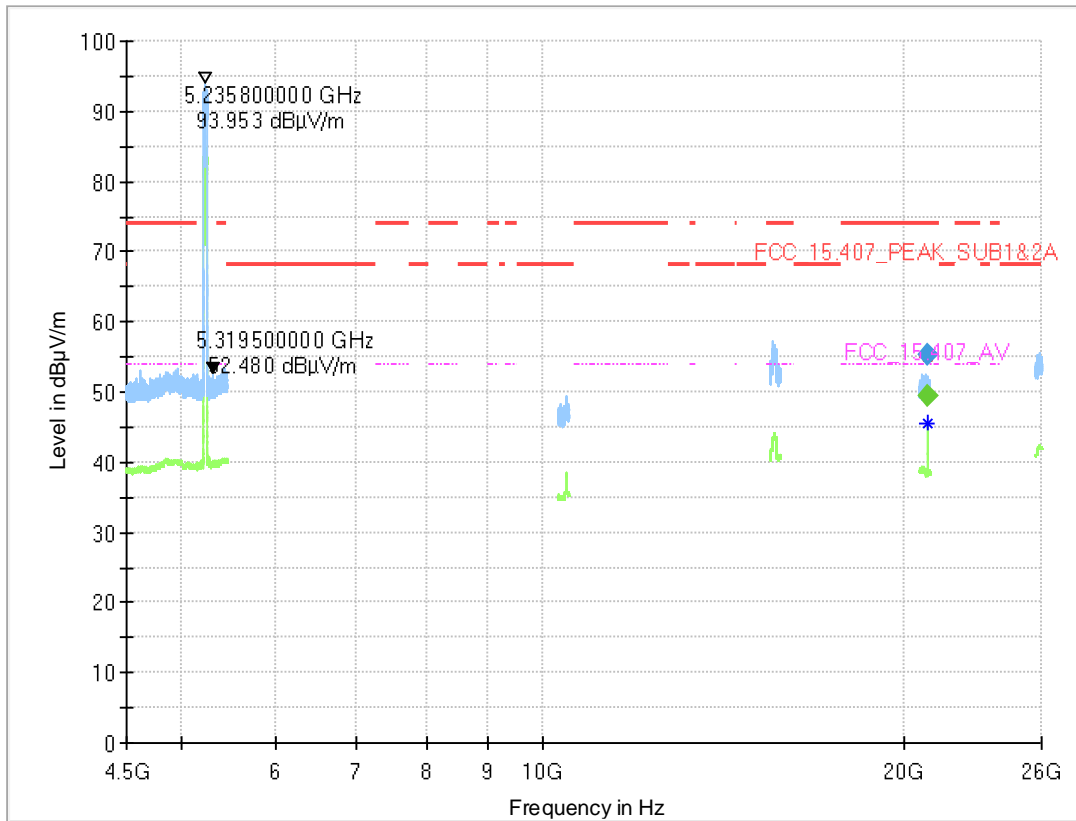

**Final Result**

Frequency (MHz)	MaxPeak (dBµV/m)	CAverage (dBµV/m)	Limit (dBµV/m)	Margin (dB)	Meas. Time (ms)	Bandwidth (kHz)	Height (cm)	Pol	Azimuth (deg)	Elevation (deg)	Corr. (dB/m)
20920.000	---	49.4	54.00	4.63	1000.0	1000.000	150.0	V	-176.0	-2.0	18.3
20920.000	55.3	---	74.00	18.65	1000.0	1000.000	150.0	V	-176.0	-2.0	18.3

Radio Technology = WLAN n 40 MHz MIMO, Operating Frequency = low, Measurement range = 1GHz - 26GHz, Subband = U-NII-3 (S05\_AD02)

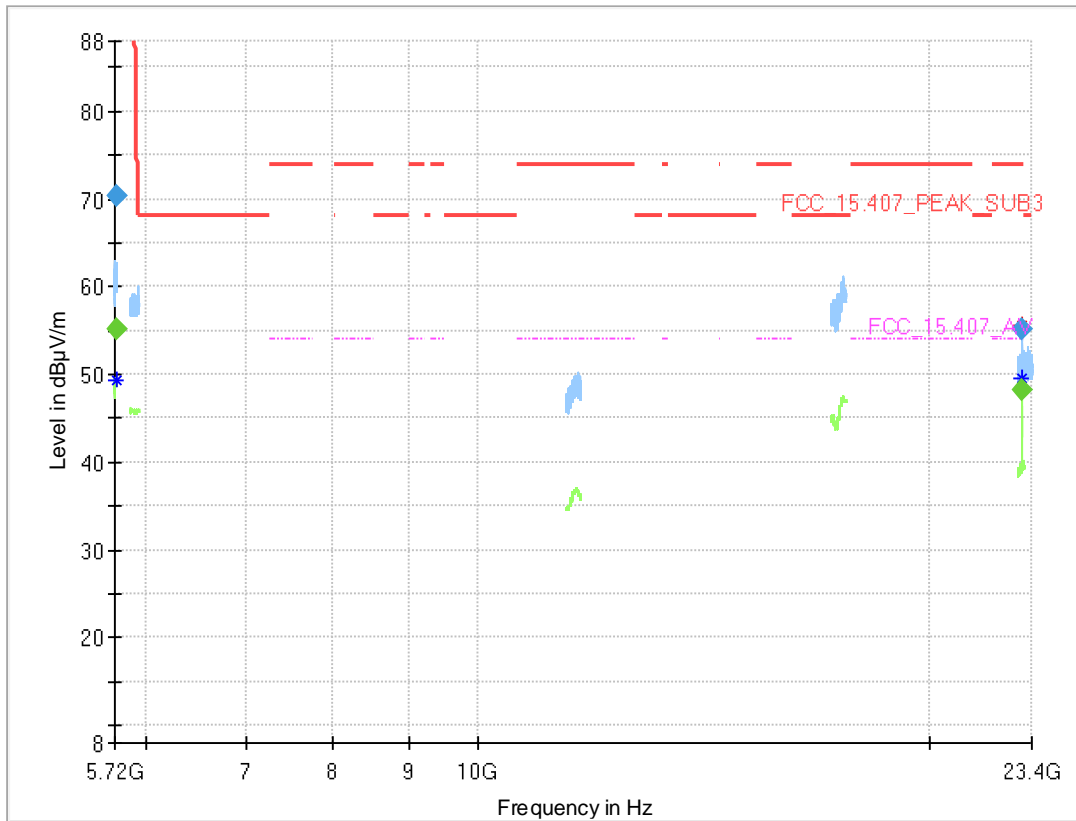

### Final Result

Frequency (MHz)	MaxPeak (dBµV/m)	CAverage (dBµV/m)	Limit (dBµV/m)	Margin (dB)	Meas. Time (ms)	Bandwidth (kHz)	Height (cm)	Pol	Azimuth (deg)	Elevation (deg)	Corr. (dB/m)
5724.800	---	55.1	---	---	1000.0	1000.000	150.0	H	0.0	97.0	14.2
5724.800	70.3	---	121.7	51.40	1000.0	1000.000	150.0	H	0.0	97.0	14.2
23019.955	---	48.3	54.00	5.69	1000.0	1000.000	150.0	V	-183.0	-2.0	19.5
23019.955	55.2	---	74.00	18.84	1000.0	1000.000	150.0	V	-183.0	-2.0	19.5

Radio Technology = WLAN ac 40 MHz, Operating Frequency = low, Measurement range = 1GHz - 26GHz, Subband = U-NII-1 (S05\_AD02)

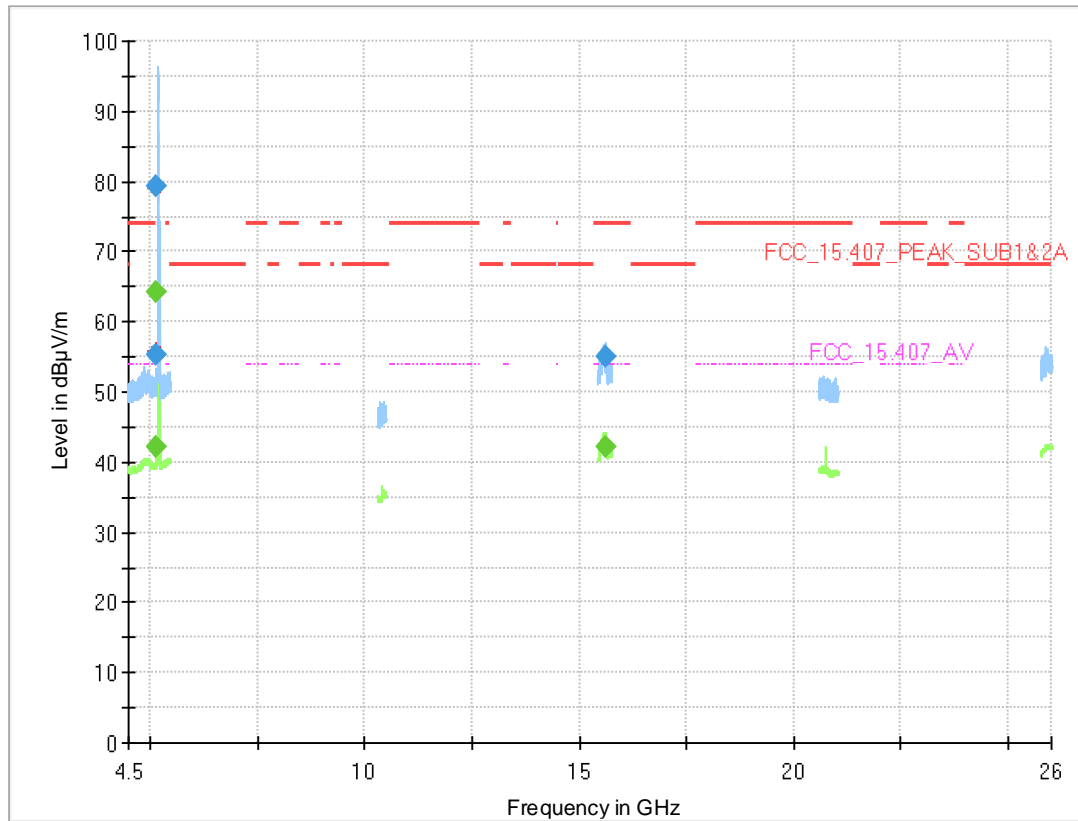

### Final\_Result

Frequency (MHz)	MaxPeak (dBµV/m)	CAverage (dBµV/m)	Limit (dBµV/m)	Margin (dB)	Meas. Time (ms)	Bandwidth (kHz)	Height (cm)	Pol	Azimuth (deg)	Elevation (deg)	Corr. (dB/m)
5149.838	---	64.3	54.00	-10.29	1000.0	1000.000	150.0	V	0.0	98.0	13.5
5149.838	79.3	---	74.00	-5.34	1000.0	1000.000	150.0	V	0.0	98.0	13.5
5150.000	55.3	---	74.00	18.71	1000.0	1000.000	150.0	V	-184.0	-6.0	13.5
5150.000	---	42.3	54.00	11.70	1000.0	1000.000	150.0	V	-184.0	-6.0	13.5
15597.808	54.9	---	74.00	19.09	1000.0	1000.000	150.0	V	11.0	6.0	-1.0
15597.808	---	42.3	54.00	11.75	1000.0	1000.000	150.0	V	11.0	6.0	-1.0

Radio Technology = WLAN ac 40 MHz, Operating Frequency = high, Measurement range = 1GHz - 26GHz, Subband = U-NII-1 (S05\_AD02)

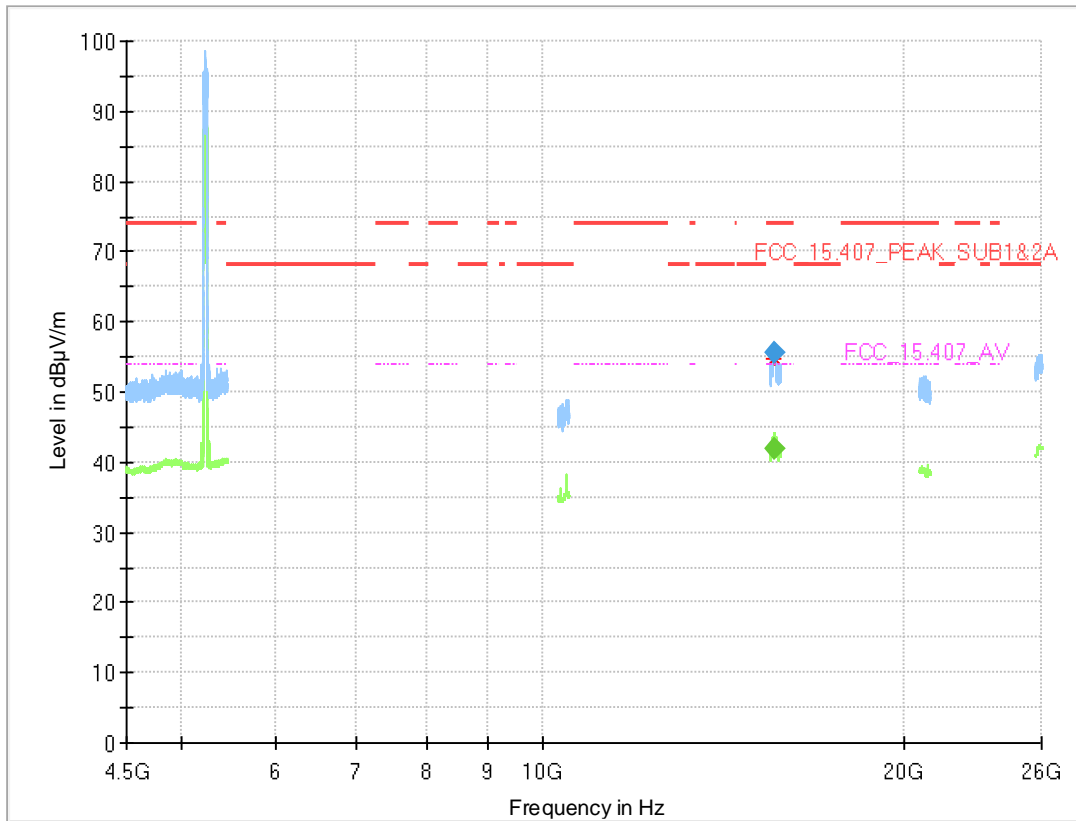

### Final Result

Frequency (MHz)	MaxPeak (dBµV/m)	CAverage (dBµV/m)	Limit (dBµV/m)	Margin (dB)	Meas. Time (ms)	Bandwidth (kHz)	Height (cm)	Pol	Azimuth (deg)	Elevation (deg)	Corr. (dB/m)
15576.346	---	42.0	54.00	12.03	1000.0	1000.000	150.0	V	-141.0	105.0	-1.3
15576.346	55.5	---	74.00	18.53	1000.0	1000.000	150.0	V	-141.0	105.0	-1.3



Radio Technology = WLAN ac 40 MHz, Operating Frequency = low, Measurement range = 1GHz - 26GHz, Subband = U-NII-3 (S05\_AD02)

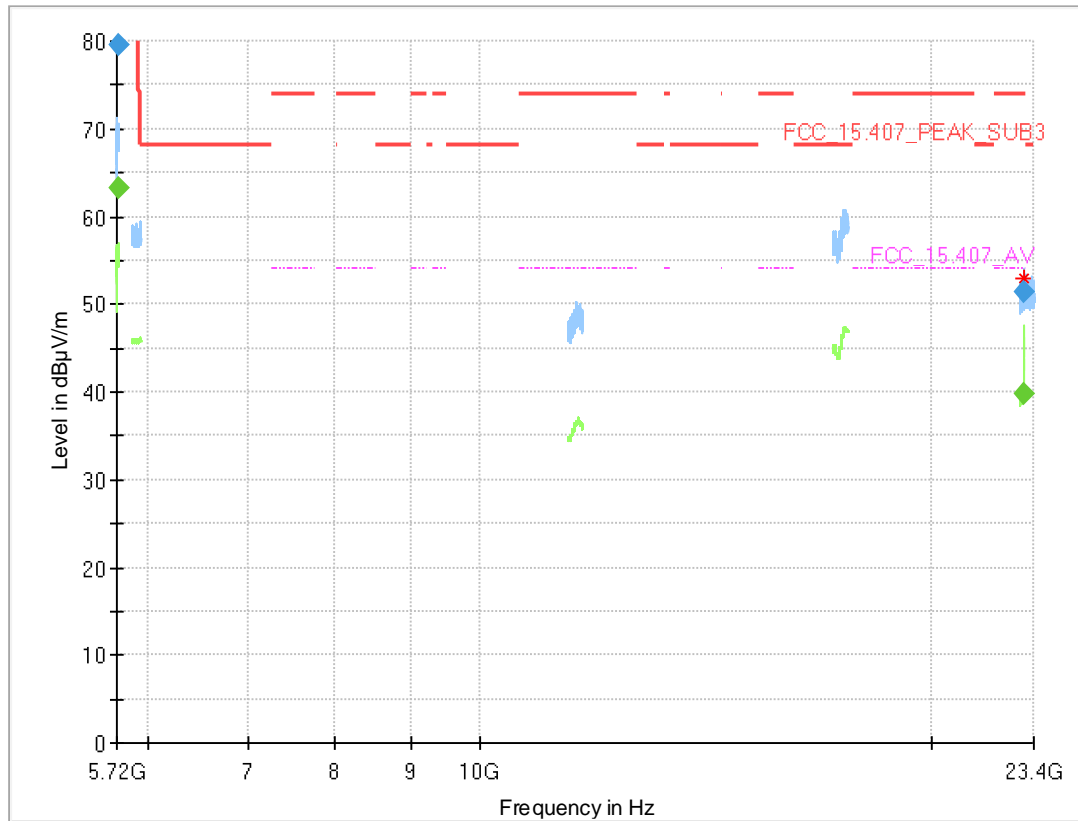

### Final Result

Frequency (MHz)	MaxPeak (dBµV/m)	CAverage (dBµV/m)	Limit (dBµV/m)	Margin (dB)	Meas. Time (ms)	Bandwidth (kHz)	Height (cm)	Pol	Azimuth (deg)	Elevation (deg)	Corr. (dB/m)
5725.000	---	63.3	---	---	1000.0	1000.000	150.0	V	-1.0	92.0	14.2
5725.000	79.6	---	122.2	42.65	1000.0	1000.000	150.0	V	-1.0	92.0	14.2
23019.570	---	39.7	54.00	14.28	1000.0	1000.000	150.0	V	-186.0	-3.0	19.5
23019.570	51.5	---	74.00	22.54	1000.0	1000.000	150.0	V	-186.0	-3.0	19.5

Radio Technology = WLAN ax 40 MHz MIMO, Operating Frequency = low, Measurement range = 1GHz - 26GHz, Subband = U-NII-1 (S05\_AD02)

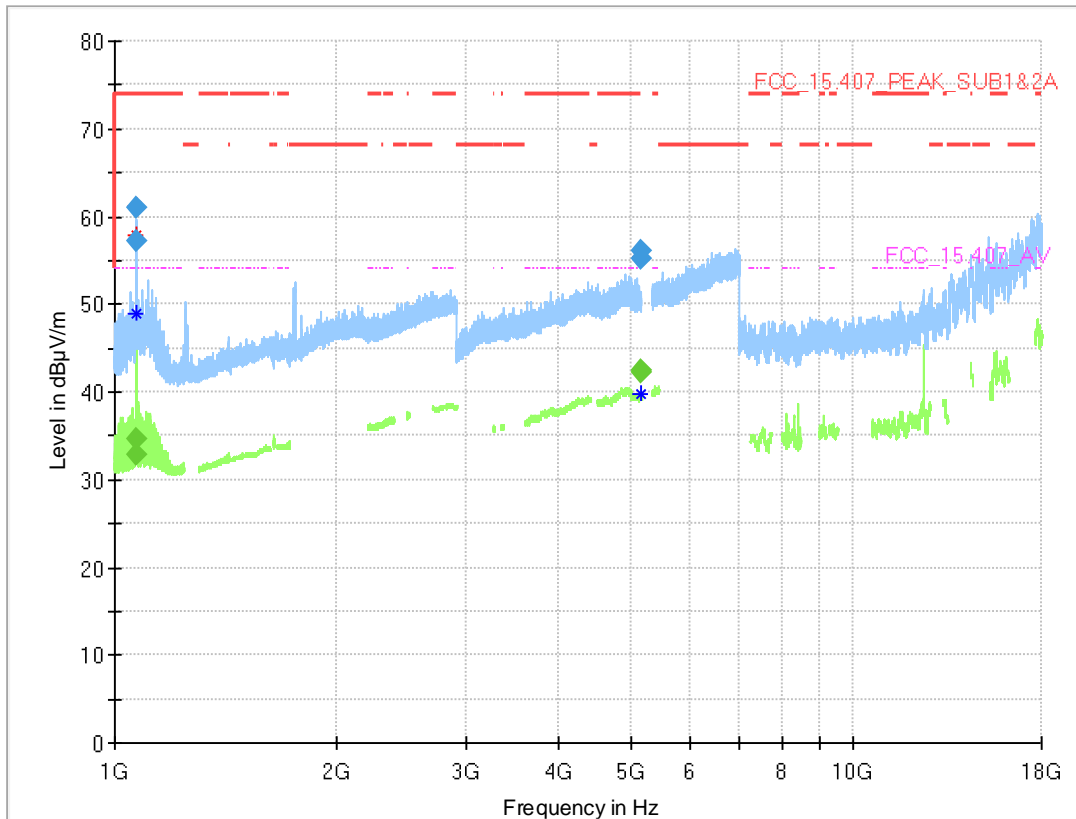

### Final Result

Frequency (MHz)	MaxPeak (dBµV/m)	CAverage (dBµV/m)	Limit (dBµV/m)	Margin (dB)	Meas. Time (ms)	Bandwidth (kHz)	Height (cm)	Pol	Azimuth (deg)	Elevation (deg)	Corr. (dB/m)
1070.800	---	33.0	54.00	21.05	1000.0	1000.000	150.0	H	-90.0	-15.0	-1.4
1070.800	57.3	---	74.00	16.72	1000.0	1000.000	150.0	H	-90.0	-15.0	-1.4
1071.280	---	34.7	54.00	19.34	1000.0	1000.000	150.0	V	7.0	0.0	-1.4
1071.280	61.0	---	74.00	13.02	1000.0	1000.000	150.0	V	7.0	0.0	-1.4
5146.588	---	42.5	54.00	11.52	1000.0	1000.000	150.0	V	7.0	105.0	13.6
5146.588	55.2	---	74.00	18.81	1000.0	1000.000	150.0	V	7.0	105.0	13.6
5149.350	---	42.3	54.00	11.72	1000.0	1000.000	150.0	V	85.0	14.0	13.5
5149.350	56.2	---	74.00	17.83	1000.0	1000.000	150.0	V	85.0	14.0	13.5

Radio Technology = WLAN ax 40 MHz MIMO, Operating Frequency = high, Measurement range = 1GHz - 26GHz, Subband = U-NII-1 (S05\_AD02)

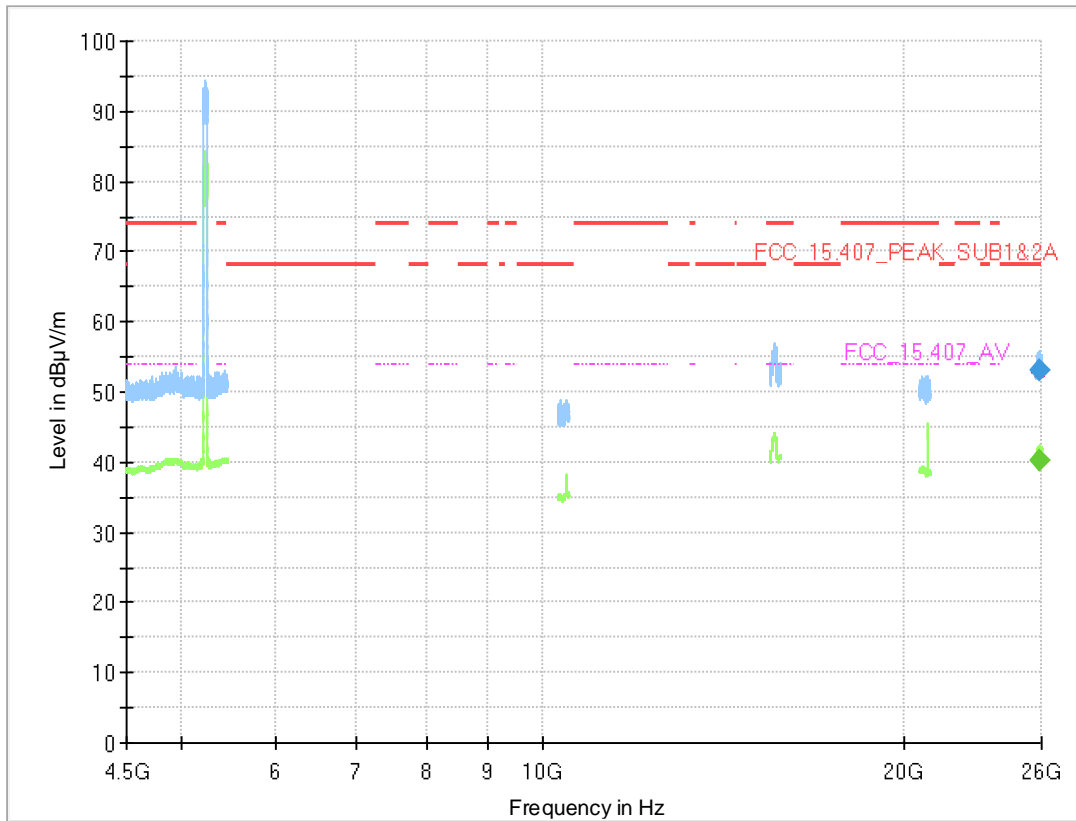

### Final Result

Frequency (MHz)	MaxPeak (dBµV/m)	CAverage (dBµV/m)	Limit (dBµV/m)	Margin (dB)	Meas. Time (ms)	Bandwidth (kHz)	Height (cm)	Pol	Azimuth (deg)	Elevation (deg)	Corr. (dB/m)
25927.875	---	40.3	---	---	1000.0	1000.000	150.0	V	54.0	15.0	20.9
25927.875	53.1	---	68.20	15.05	1000.0	1000.000	150.0	V	54.0	15.0	20.9

Radio Technology = WLAN ax 40 MHz MIMO, Operating Frequency = low, Measurement range = 1GHz - 26GHz, Subband = U-NII-3 (S05\_AD02)

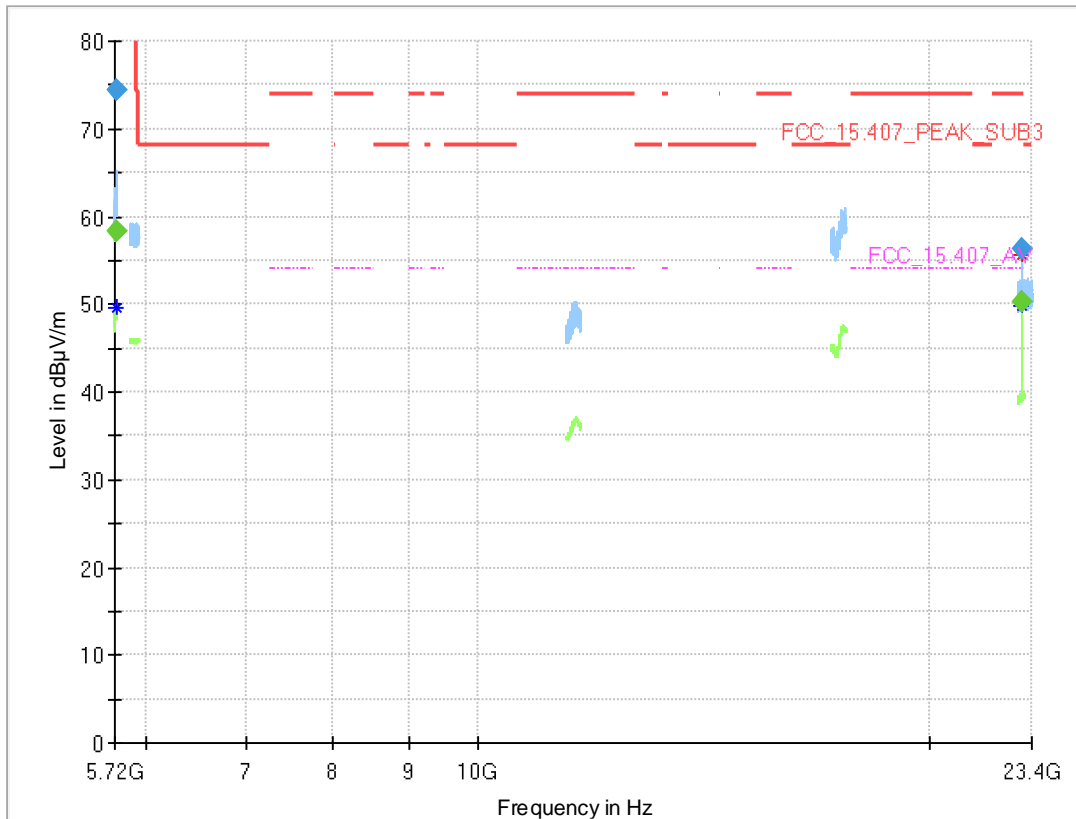

### Final Result

Frequency (MHz)	MaxPeak (dBµV/m)	CAverage (dBµV/m)	Limit (dBµV/m)	Margin (dB)	Meas. Time (ms)	Bandwidth (kHz)	Height (cm)	Pol	Azimuth (deg)	Elevation (deg)	Corr. (dB/m)
5723.900	---	58.2	---	---	1000.0	1000.000	150.0	H	-2.0	98.0	14.2
5723.900	74.5	---	119.6	45.22	1000.0	1000.000	150.0	H	-2.0	98.0	14.2
23020.010	---	50.3	54.00	3.65	1000.0	1000.000	150.0	V	-184.0	-1.0	19.5
23020.010	56.3	---	74.00	17.67	1000.0	1000.000	150.0	V	-184.0	-1.0	19.5

### 5.7.5 TEST EQUIPMENT USED

- Radiated Emissions SAC H-Field
- Radiated Emissions FAR 5 GHz FCC
- Radiated Emissions SAC up to 1 GHz

## 5.8 BAND EDGE

Standard **FCC Part 15 Subpart E**

**The test was performed according to:**

ANSI C63.10, chapter 6.6.5

### 5.8.1 TEST DESCRIPTION

The test set-up was made in accordance to the general provisions of ANSI C63.10 in a typical installation configuration. The measurements were performed according the following sub-chapter of ANSI C63.10:

- Chapter 6.10.5

The Equipment Under Test (EUT) was set up on a non-conductive support (tilt device) at 1.5 m height in the fully-anechoic chamber.

All steps were performed with one height (1.5 m) of the receiving antenna only (procedure according ANSI C63.10, chapter 6.6.5).

### 3. Measurement above 1 GHz

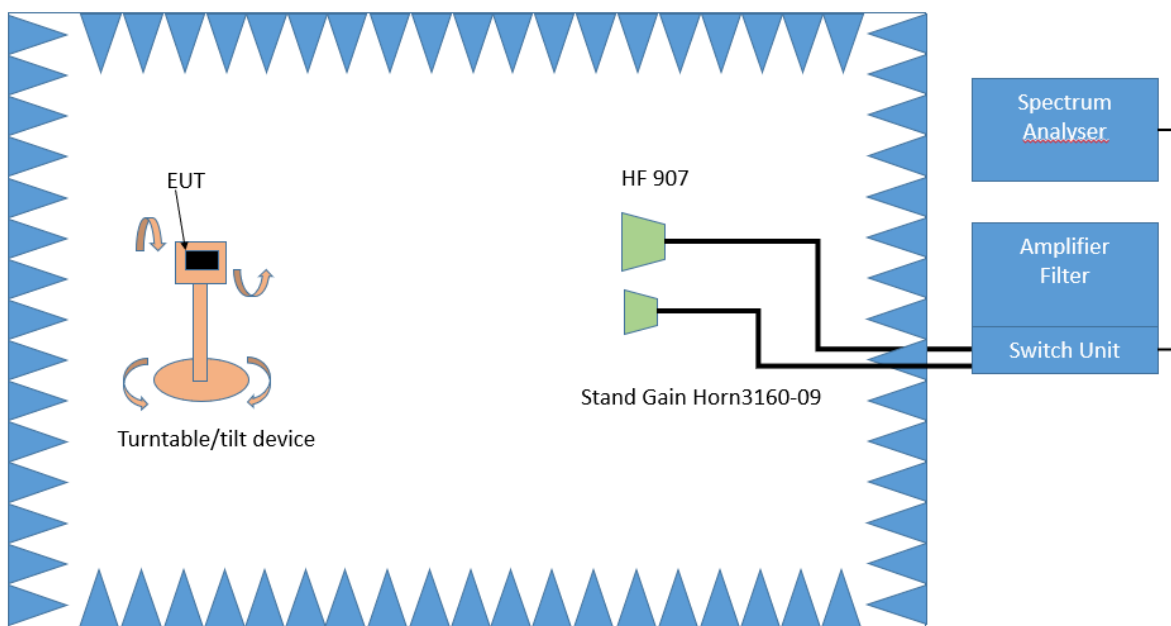

Test Setup; Spurious Emission Radiated (FAC), 1 GHz-26.5 GHz

#### Step 1:

The EUT is turned during the preliminary measurement across the elevation axis, with a step size of 90 °.

The turn table step size (azimuth angle) for the preliminary measurement is 45 °.

Spectrum analyser settings:

- Detector: Peak, Average
- RBW = 1 MHz
- VBW = 3 MHz

#### Step 2:

The turn table azimuth will slowly vary by  $\pm 22.5^\circ$ .

The elevation angle will slowly vary by  $\pm 45^\circ$

Spectrum analyser settings:

- Detector: Peak

### Step 3:

Spectrum analyser settings for step 3:

- Detector: Peak / CISPR Average
- Measured frequencies: in step 1 determined frequencies
- RBW = 1 MHz
- VBW = 3 MHz
- Measuring time: 1 s

## 5.8.2 TEST REQUIREMENTS / LIMITS

### A) FCC

FCC Part 15 Subpart E, §15.407 (b)(1)

For transmitters operating in the 5150–5250 MHz band:

Limit: –27 dBm/MHz EIRP outside of the band 5150–5350 MHz.

FCC Part 15 Subpart E, §15.407 (b)(2)

For transmitters operating in the 5250–5350 MHz band:

Limit: –27 dBm/MHz EIRP outside of the band 5150–5350 MHz.

FCC Part 15 Subpart E, §15.407 (b)(3)

For transmitters operating in the 5470–5725 MHz band:

Limit: –27 dBm/MHz EIRP outside of the band 5470–5725 MHz.

FCC Part 15 Subpart E, §15.407 (b)(4)

For transmitters operating in the 5725–5850 MHz band:

Limit: –27 dBm/MHz at 75 MHz or more above or below the band edge  
increasing linearly to 10 dBm/MHz at 25 MHz above or below the band edge  
increasing linearly to 15.6 dBm/MHz at 5 MHz above or below the band edge  
increasing linearly to 27 dBm/MHz at the band edge.

FCC Part 15 Subpart E, §15.407 (b) (5)

For transmitters operating within the 5.925–7.125 GHz band:

Limit: –27 dBm/MHz EIRP outside of the band 5.925–7.125 GHz.

FCC Part 15 Subpart E, §15.407 (b) (6)

For transmitters operating within the 5.925–7.125 GHz bands:

Power spectral density must be suppressed by 20 dB at 1 MHz outside of channel edge, by 28 dB at one channel bandwidth from the channel center, and by 40 dB at one- and one-half times the channel bandwidth away from channel center. At frequencies between one megahertz outside an unlicensed device's channel edge and one channel bandwidth from the center of the channel, the limits must be linearly interpolated between 20 dB and 28 dB suppression, and at frequencies between one and one- and one-half times an unlicensed device's channel bandwidth, the limits must be linearly interpolated between 28 dB and 40 dB suppression. Emissions removed from the channel center by more than one- and one-half times the channel bandwidth must be suppressed by at least 40 dB.

### B) IC

Different frequency bands and limits apply, as compared to the FCC requirements.

RSS-247, 6.2.1.2, Emissions outside the band 5150-5250 MHz, indoor operation only:  
 Limit: -27 dBm/MHz EIRP outside of the band 5150-5250 MHz.

RSS-247, 6.2.2.2, Emissions outside the band 5250-5350 MHz:  
 Limit: -27 dBm/MHz EIRP outside of the band 5250-5350 MHz.

RSS-247, 6.2.3.2, Emissions outside the bands 5470-5600 MHz and 5650-5725 MHz:  
 Limit: -27 dBm/MHz EIRP outside of the band 5470-5725 MHz.  
 However, devices with bandwidth overlapping the band edge of 5725 MHz can meet the emission limit of -27 dBm/MHz e.i.r.p.at 5850 MHz instead of 5725 MHz.  
 Note: No operation is permitted for the frequency range 5600-5650 MHz.

RSS-247, 6.2.4.2, Emissions outside the band 5725-5850 MHz:

- 27 dBm/MHz at frequencies from the band edges decreasing linearly to 15.6 Bm/MHz at 5 MHz above or below the band edges;
- 15.6 dBm/MHz at 5 MHz above or below the band edges decreasing linearly to 10 dBm/MHz at 25 MHz above or below the band edges;
- 10 dBm/MHz at 25 MHz above or below the band edges decreasing linearly to -27 dBm/MHz at 75 MHz above or below the band edges; and
- 27 dBm/MHz at frequencies more than 75 MHz above or below the band edges.

### C) FCC & IC

For band edges connected to a restricted band, the limits are specified in Section 15.209(a)

FCC Part 15, Subpart C, §15.209, Radiated Emission Limits

Frequency in MHz	Limit ( $\mu\text{V}/\text{m}$ )	Measurement distance (m)	Limits (dB $\mu\text{V}/\text{m}$ )
0.009 - 0.49	2400/F(kHz)@300m	3	(48.5 - 13.8)@300m
0.49 - 1.705	24000/F(kHz)@30m	3	(33.8 - 23.0)@30m
1.705 - 30	30@30m	3	29.5@30m

The measured values are corrected with an inverse linear distance extrapolation factor (40 dB/decade) according FCC 15.31 (2).

Frequency in MHz	Limit ( $\mu\text{V}/\text{m}$ )	Measurement distance (m)	Limits (dB $\mu\text{V}/\text{m}$ )
30 - 88	100@3m	3	40.0@3m
88 - 216	150@3m	3	43.5@3m
216 - 960	200@3m	3	46.0@3m
960 - 26000	500@3m	3	54.0@3m
26000 - 40000	500@3m	1	54.0@3m

The measured values above 26 GHz are corrected with an inverse linear distance extrapolation factor (20 dB/decade).

§15.35(b) ..., there is also a limit on the radio frequency emissions, as measured using instrumentation with a peak detector function, corresponding to 20 dB above the maximum permitted average limit....

Used conversion factor: Limit (dB $\mu\text{V}/\text{m}$ ) = 20 log (Limit ( $\mu\text{V}/\text{m}$ )/1 $\mu\text{V}/\text{m}$ )

### 5.8.3 TEST PROTOCOL

Ambient temperature: 22–26 °C  
 Air Pressure: 991–1023 hPa  
 Humidity: 37–57 %

#### With <8 dBi antenna FCC power setting (worst case):

WLAN a-Mode; 20 MHz; 6 Mbit/s; Diversity  
 Applied duty cycle correction (AV): 0.5 dB

U-NII-Subband	Ch. No.	Ch. Center Freq. [MHz]	Band Edge Freq. [MHz]	Spurious Level [dBμV/m]	Detector	RBW [kHz]	Limit [dBμV/m]	Margin [dB]	Limit Type	FCC /IC?
1	36	5180	5150.0	55.2	PEAK	1000	74.0	18.8	BE-RB	FCC&IC
	36	5180	5150.0	43.0	AV	1000	54.0	11.0	BE-RB	FCC&IC
3	149	5745	5725.0	87.0	PEAK	1000	121.7	34.7	BE-UE	FCC&IC
	165	5825	5850.0	61.9	PEAK	1000	121.7	59.8	BE-UE	FCC&IC

WLAN ac-Mode; 20 MHz; MCS 0; SISO  
 Applied duty cycle correction (AV): 0.7 dB

U-NII-Subband	Ch. No.	Ch. Center Freq. [MHz]	Band Edge Freq. [MHz]	Spurious Level [dBμV/m]	Detector	RBW [kHz]	Limit [dBμV/m]	Margin [dB]	Limit Type	FCC /IC?
1	36	5180	5150.0	56.1	PEAK	1000	74.0	17.9	BE-RB	FCC&IC
	36	5180	5150.0	43.7	AV	1000	54.0	10.3	BE-RB	FCC&IC
3	149	5745	5725.0	71.4	PEAK	1000	121.7	50.3	BE-UE	FCC&IC
	165	5825	5850.0	61.7	PEAK	1000	121.5	59.8	BE-UE	FCC&IC

WLAN ac-Mode; 40 MHz; MCS 0; SISO  
 Applied duty cycle correction (AV): 0.8 dB

U-NII-Subband	Ch. No.	Ch. Center Freq. [MHz]	Band Edge Freq. [MHz]	Spurious Level [dBμV/m]	Detector	RBW [kHz]	Limit [dBμV/m]	Margin [dB]	Limit Type	FCC /IC?
1	38	5190	5150.0	58.7	PEAK	1000	74.0	15.3	BE-RB	FCC&IC
	38	5190	5150.0	45.9	AV	1000	54.0	8.1	BE-RB	FCC&IC
3	151	5755	5725.0	83.7	PEAK	1000	121.2	37.5	BE-UE	FCC&IC
	159	5795	5850.0	67.1	PEAK	1000	116.3	49.2	BE-UE	FCC&IC

WLAN n-Mode; 20 MHz; MCS 8; MIMO  
 Applied duty cycle correction (AV): 0.5 dB

U-NII-Subband	Ch. No.	Ch. Center Freq. [MHz]	Band Edge Freq. [MHz]	Spurious Level [dBμV/m]	Detector	RBW [kHz]	Limit [dBμV/m]	Margin [dB]	Limit Type	FCC /IC?
1	36	5180	5150.0	55.9	PEAK	1000	74.0	18.1	BE-RB	FCC&IC
	36	5180	5150.0	43.1	AV	1000	54.0	10.9	BE-RB	FCC&IC
3	149	5745	5725.0	72.4	PEAK	1000	122.2	49.8	BE-UE	FCC&IC
	165	5825	5850.0	60.2	PEAK	1000	119.9	59.7	BE-UE	FCC&IC

WLAN n-Mode; 40 MHz; MCS 8; MIMO  
 Applied duty cycle correction (AV): 0.5 dB

U-NII-Subband	Ch. No.	Ch. Center Freq. [MHz]	Band Edge Freq. [MHz]	Spurious Level [dBμV/m]	Detector	RBW [kHz]	Limit [dBμV/m]	Margin [dB]	Limit Type	FCC /IC?
1	38	5190	5150.0	66.1	PEAK	1000	74.0	7.9	BE-RB	FCC&IC
	38	5190	5150.0	50.7	AV	1000	54.0	3.3	BE-RB	FCC&IC
3	151	5755	5725.0	84.2	PEAK	1000	118.3	34.1	BE-UE	FCC&IC
	159	5795	5850.0	66.9	PEAK	1000	121.5	54.6	BE-UE	FCC&IC



WLAN ac-Mode; 80 MHz; MCS 0; MIMO  
Applied duty cycle correction (AV): 0.6 dB

U-NII-Subband	Ch. No.	Ch. Center Freq. [MHz]	Band Edge Freq. [MHz]	Spurious Level [dBµV/m]	Detector	RBW [kHz]	Limit [dBµV/m]	Margin [dB]	Limit Type	FCC /IC?
1	42	5210	5150.0	64.8	PEAK	1000	74.0	9.2	BE-RB	FCC&IC
	42	5210	5150.0	49.9	AV	1000	54.0	4.1	BE-RB	FCC&IC
3	155	5775	5725.0	82.0	PEAK	1000	122.2	40.2	BE-UE	FCC&IC
	155	5775	5850.0	76.5	PEAK	1000	121.5	45.0	BE-UE	FCC&IC

WLAN ax-Mode; 20 MHz; MCS 0; SISO  
Applied duty cycle correction (AV): 1.3 dB

U-NII-Subband	Ch. No.	Ch. Center Freq. [MHz]	Band Edge Freq. [MHz]	Spurious Level [dBµV/m]	Detector	RBW [kHz]	Limit [dBµV/m]	Margin [dB]	Limit Type	FCC /IC?
1	36	5180	5150.0	56.1	PEAK	1000	74.0	17.9	BE-RB	FCC&IC
	36	5180	5150.0	44.1	AV	1000	54.0	9.9	BE-RB	FCC&IC
3	149	5745	5725.0	74.9	PEAK	1000	121.7	46.8	BE-UE	FCC&IC
	165	5825	5850.0	63.3	PEAK	1000	121.5	58.2	BE-UE	FCC&IC

WLAN ax-Mode; 40 MHz; MCS 0; SISO  
Applied duty cycle correction (AV): 1.2 dB

U-NII-Subband	Ch. No.	Ch. Center Freq. [MHz]	Band Edge Freq. [MHz]	Spurious Level [dBµV/m]	Detector	RBW [kHz]	Limit [dBµV/m]	Margin [dB]	Limit Type	FCC /IC?
1	38	5190	5150.0	61.9	PEAK	1000	74.0	12.1	BE-RB	FCC&IC
	38	5190	5150.0	48.6	AV	1000	54.0	5.4	BE-RB	FCC&IC
3	151	5755	5725.0	81.4	PEAK	1000	118.1	36.7	BE-UE	FCC&IC
	159	5795	5850.0	57.2	PEAK	1000	114.7	57.5	BE-UE	FCC&IC

WLAN ax-Mode; 80 MHz; MCS 0; MIMO  
Applied duty cycle correction (AV): 0.6 dB

U-NII-Subband	Ch. No.	Ch. Center Freq. [MHz]	Band Edge Freq. [MHz]	Spurious Level [dBµV/m]	Detector	RBW [kHz]	Limit [dBµV/m]	Margin [dB]	Limit Type	FCC /IC?
1	42	5210	5150.0	60.0	PEAK	1000	74.0	14.0	BE-RB	FCC&IC
	42	5210	5150.0	46.1	AV	1000	54.0	7.9	BE-RB	FCC&IC
3	155	5775	5725.0	83.0	PEAK	1000	119.0	36.0	BE-UE	FCC&IC
	155	5775	5850.0	76.7	PEAK	1000	121.2	44.5	BE-UE	FCC&IC

**With <9 dBi antenna FCC power setting (worst case):**

WLAN a-Mode; 20 MHz; 6 Mbit/s

Applied duty cycle correction (AV): 0.7 dB

U-NII-Subband	Ch. No.	Ch. Center Freq. [MHz]	Band Edge Freq. [MHz]	Spurious Level [dBµV/m]	Detector	RBW [kHz]	Limit [dBµV/m]	Margin [dB]	Limit Type	FCC /IC?
1	36	5180	5150.0	59.9	PEAK	1000	74.0	14.1	BE-RB	FCC&IC
	36	5180	5150.0	43.0	AV	1000	54.0	11.0	BE-RB	FCC&IC
3	149	5745	5725.0	64.1	PEAK	1000	120.8	56.7	BE-UE	FCC&IC
	165	5825	5850.0	63.2	PEAK	1000	120.6	57.4	BE-UE	FCC&IC

WLAN n-Mode; 20 MHz; MCS 0; SISO

Applied duty cycle correction (AV): 0.7 dB

U-NII-Subband	Ch. No.	Ch. Center Freq. [MHz]	Band Edge Freq. [MHz]	Spurious Level [dBµV/m]	Detector	RBW [kHz]	Limit [dBµV/m]	Margin [dB]	Limit Type	FCC /IC?
1	36	5180	5150.0	58.8	PEAK	1000	74.0	15.2	BE-RB	FCC&IC
	36	5180	5150.0	46.0	AV	1000	54.0	8.0	BE-RB	FCC&IC
3	149	5745	5725.0	73.6	PEAK	1000	121.7	48.1	BE-UE	FCC&IC

WLAN n-Mode; 40 MHz; MCS 0; SISO

Applied duty cycle correction (AV): 0.5 dB

U-NII-Subband	Ch. No.	Ch. Center Freq. [MHz]	Band Edge Freq. [MHz]	Spurious Level [dBµV/m]	Detector	RBW [kHz]	Limit [dBµV/m]	Margin [dB]	Limit Type	FCC /IC?
1	38	5190	5150.0	66.9	PEAK	1000	74.0	7.1	BE-RB	FCC&IC
	38	5190	5150.0	52.3	AV	1000	54.0	1.7	BE-RB	FCC&IC
3	151	5755	5725.0	85.9	PEAK	1000	120.6	34.7	BE-UE	FCC&IC

WLAN ac-Mode; 20 MHz; MCS 0; SISO

Applied duty cycle correction (AV): 0.7 dB

U-NII-Subband	Ch. No.	Ch. Center Freq. [MHz]	Band Edge Freq. [MHz]	Spurious Level [dBµV/m]	Detector	RBW [kHz]	Limit [dBµV/m]	Margin [dB]	Limit Type	FCC /IC?
1	36	5180	5150.0	59.3	PEAK	1000	74.0	14.7	BE-RB	FCC&IC
	36	5180	5150.0	47.1	AV	1000	54.0	6.9	BE-RB	FCC&IC
3	149	5745	5725.0	73.6	PEAK	1000	122.2	48.6	BE-UE	FCC&IC

WLAN ac-Mode; 40 MHz; MCS 0; SISO

Applied duty cycle correction (AV): 0.8 dB

U-NII-Subband	Ch. No.	Ch. Center Freq. [MHz]	Band Edge Freq. [MHz]	Spurious Level [dBµV/m]	Detector	RBW [kHz]	Limit [dBµV/m]	Margin [dB]	Limit Type	FCC /IC?
1	38	5190	5150.0	66.9	PEAK	1000	74.0	7.1	BE-RB	FCC&IC
	38	5190	5150.0	53.9	AV	1000	54.0	0.1	BE-RB	FCC&IC
3	151	5755	5725.0	87.4	PEAK	1000	119.5	32.1	BE-UE	FCC&IC

WLAN ac-Mode; 80 MHz; MCS 0; SISO

Applied duty cycle correction (AV): 0.5 dB

U-NII-Subband	Ch. No.	Ch. Center Freq. [MHz]	Band Edge Freq. [MHz]	Spurious Level [dBµV/m]	Detector	RBW [kHz]	Limit [dBµV/m]	Margin [dB]	Limit Type	FCC /IC?
1	42	5210	5150.0	63.4	PEAK	1000	74.0	10.6	BE-RB	FCC&IC
	42	5210	5150.0	50.2	AV	1000	54.0	3.8	BE-RB	FCC&IC

WLAN n-Mode; 20 MHz; MCS 8; MIMO  
Applied duty cycle correction (AV): 0.5 dB

U-NII-Subband	Ch. No.	Ch. Center Freq. [MHz]	Band Edge Freq. [MHz]	Spurious Level [dBµV/m]	Detector	RBW [kHz]	Limit [dBµV/m]	Margin [dB]	Limit Type	FCC /IC?
1	36	5180	5150.0	57.8	PEAK	1000	74.0	16.2	BE-RB	FCC&IC
	36	5180	5150.0	44.4	AV	1000	54.0	9.6	BE-RB	FCC&IC
3	149	5745	5725.0	76.0	PEAK	1000	122.2	46.2	BE-UE	FCC&IC

WLAN n-Mode; 40 MHz; MCS 8; MIMO  
Applied duty cycle correction (AV): 0.5 dB

U-NII-Subband	Ch. No.	Ch. Center Freq. [MHz]	Band Edge Freq. [MHz]	Spurious Level [dBµV/m]	Detector	RBW [kHz]	Limit [dBµV/m]	Margin [dB]	Limit Type	FCC /IC?
1	38	5190	5150.0	64.6	PEAK	1000	74.0	9.4	BE-RB	FCC&IC
	38	5190	5150.0	51.9	AV	1000	54.0	2.1	BE-RB	FCC&IC
3	151	5755	5725.0	84.3	PEAK	1000	117.6	33.3	BE-UE	FCC&IC

WLAN ac-Mode; 20 MHz; MCS 0; MIMO  
Applied duty cycle correction (AV): 0.7 dB

U-NII-Subband	Ch. No.	Ch. Center Freq. [MHz]	Band Edge Freq. [MHz]	Spurious Level [dBµV/m]	Detector	RBW [kHz]	Limit [dBµV/m]	Margin [dB]	Limit Type	FCC /IC?
1	36	5180	5150.0	59.9	PEAK	1000	74.0	14.1	BE-RB	FCC&IC
	36	5180	5150.0	48.4	AV	1000	54.0	5.6	BE-RB	FCC&IC
3	149	5745	5725.0	73.0	PEAK	1000	120.4	47.4	BE-UE	FCC&IC

WLAN ac-Mode; 40 MHz; MCS 0; MIMO  
Applied duty cycle correction (AV): 0.5 dB

U-NII-Subband	Ch. No.	Ch. Center Freq. [MHz]	Band Edge Freq. [MHz]	Spurious Level [dBµV/m]	Detector	RBW [kHz]	Limit [dBµV/m]	Margin [dB]	Limit Type	FCC /IC?
1	38	5190	5150.0	64.7	PEAK	1000	74.0	9.3	BE-RB	FCC&IC
	38	5190	5150.0	51.9	AV	1000	54.0	2.1	BE-RB	FCC&IC
3	151	5755	5725.0	84.6	PEAK	1000	119.0	34.4	BE-UE	FCC&IC

WLAN ac-Mode; 80 MHz; MCS 0; MIMO  
Applied duty cycle correction (AV): 0.6 dB

U-NII-Subband	Ch. No.	Ch. Center Freq. [MHz]	Band Edge Freq. [MHz]	Spurious Level [dBµV/m]	Detector	RBW [kHz]	Limit [dBµV/m]	Margin [dB]	Limit Type	FCC /IC?
1	42	5210	5150.0	65.3	PEAK	1000	74.0	8.7	BE-RB	FCC&IC
	42	5210	5150.0	52.7	AV	1000	54.0	1.3	BE-RB	FCC&IC
3	155	5775	5725.0	73.9	PEAK	1000	120.6	46.7	BE-UE	FCC&IC

WLAN ax-Mode; 20 MHz; MCS 0; SISO  
Applied duty cycle correction (AV): 1.3 dB

U-NII-Subband	Ch. No.	Ch. Center Freq. [MHz]	Band Edge Freq. [MHz]	Spurious Level [dBµV/m]	Detector	RBW [kHz]	Limit [dBµV/m]	Margin [dB]	Limit Type	FCC /IC?
1	36	5180	5150.0	58.6	PEAK	1000	74.0	15.4	BE-RB	FCC&IC
	36	5180	5150.0	46.3	AV	1000	54.0	7.7	BE-RB	FCC&IC
3	149	5745	5725.0	76.9	PEAK	1000	120.6	43.7	BE-UE	FCC&IC

WLAN ax-Mode; 40 MHz; MCS 0; SISO  
 Applied duty cycle correction (AV): 1.2 dB

U-NII-Subband	Ch. No.	Ch. Center Freq. [MHz]	Band Edge Freq. [MHz]	Spurious Level [dB $\mu$ V/m]	Detector	RBW [kHz]	Limit [dB $\mu$ V/m]	Margin [dB]	Limit Type	FCC /IC?
1	38	5190	5150.0	67.9	PEAK	1000	74.0	6.1	BE-RB	FCC&IC
	38	5190	5150.0	53.8	AV	1000	54.0	0.2	BE-RB	FCC&IC

WLAN ax-Mode; 80 MHz; MCS 0; SISO  
 Applied duty cycle correction (AV): 1.3 dB

U-NII-Subband	Ch. No.	Ch. Center Freq. [MHz]	Band Edge Freq. [MHz]	Spurious Level [dB $\mu$ V/m]	Detector	RBW [kHz]	Limit [dB $\mu$ V/m]	Margin [dB]	Limit Type	FCC /IC?
1	42	5210	5150.0	64.9	PEAK	1000	74.0	9.1	BE-RB	FCC&IC
	42	5210	5150.0	51.1	AV	1000	54.0	2.9	BE-RB	FCC&IC

WLAN ax-Mode; 20 MHz; MCS 0; MIMO  
 Applied duty cycle correction (AV): 0.6 dB

U-NII-Subband	Ch. No.	Ch. Center Freq. [MHz]	Band Edge Freq. [MHz]	Spurious Level [dB $\mu$ V/m]	Detector	RBW [kHz]	Limit [dB $\mu$ V/m]	Margin [dB]	Limit Type	FCC /IC?
1	36	5180	5150.0	57.7	PEAK	1000	74.0	16.3	BE-RB	FCC&IC
	36	5180	5150.0	44.9	AV	1000	54.0	9.1	BE-RB	FCC&IC
3	149	5745	5725.0	73.2	PEAK	1000	122.2	49.0	BE-UE	FCC&IC

WLAN ax-Mode; 40 MHz; MCS 0; MIMO  
 Applied duty cycle correction (AV): 0.6 dB

U-NII-Subband	Ch. No.	Ch. Center Freq. [MHz]	Band Edge Freq. [MHz]	Spurious Level [dB $\mu$ V/m]	Detector	RBW [kHz]	Limit [dB $\mu$ V/m]	Margin [dB]	Limit Type	FCC /IC?
1	38	5190	5150.0	65.2	PEAK	1000	74.0	8.8	BE-RB	FCC&IC
	38	5190	5150.0	52.0	AV	1000	54.0	2.0	BE-RB	FCC&IC

WLAN ax-Mode; 80 MHz; MCS 0; MIMO  
 Applied duty cycle correction (AV): 0.6 dB

U-NII-Subband	Ch. No.	Ch. Center Freq. [MHz]	Band Edge Freq. [MHz]	Spurious Level [dB $\mu$ V/m]	Detector	RBW [kHz]	Limit [dB $\mu$ V/m]	Margin [dB]	Limit Type	FCC /IC?
1	42	5210	5150.0	66.2	PEAK	1000	74.0	7.8	BE-RB	FCC&IC
	42	5210	5150.0	52.6	AV	1000	54.0	1.4	BE-RB	FCC&IC
3	155	5775	5725.0	75.2	PEAK	1000	121.7	46.5	BE-UE	FCC&IC

### With 14.2 dBi antenna FCC power setting (worst case):

WLAN a-Mode; 20 MHz; 6 Mbit/s; Diversity  
 Applied duty cycle correction (AV): 0.5 dB

U-NII-Subband	Ch. No.	Ch. Center Freq. [MHz]	Band Edge Freq. [MHz]	Spurious Level [dB $\mu$ V/m]	Detector	RBW [kHz]	Limit [dB $\mu$ V/m]	Margin [dB]	Limit Type	FCC /IC?
1	36	5180	5150.0	57.0	PEAK	1000	74.0	17.0	BE-RB	FCC&IC
	36	5180	5150.0	44.1	AV	1000	54.0	9.9	BE-RB	FCC&IC
3	149	5745	5725.0	55.8	PEAK	1000	117.8	62.0	BE-UE	FCC&IC
	165	5825	5850.0	56.5	PEAK	1000	118.1	61.6	BE-UE	FCC&IC

WLAN n-Mode; 20 MHz; MCS 0; SISO  
Applied duty cycle correction (AV): 0.7 dB

U-NII-Subband	Ch. No.	Ch. Center Freq. [MHz]	Band Edge Freq. [MHz]	Spurious Level [dBµV/m]	Detector	RBW [kHz]	Limit [dBµV/m]	Margin [dB]	Limit Type	FCC /IC?
1	36	5180	5150.0	55.8	PEAK	1000	74.0	18.2	BE-RB	FCC&IC
	36	5180	5150.0	43.1	AV	1000	54.0	10.9	BE-RB	FCC&IC
3	149	5745	5725.0	63.5	PEAK	1000	121.2	57.7	BE-UE	FCC&IC
	165	5825	5850.0	56.1	PEAK	1000	120.3	64.2	BE-UE	FCC&IC

WLAN ac-Mode; 40 MHz; MCS 0; SISO  
Applied duty cycle correction (AV): 0.8 dB

U-NII-Subband	Ch. No.	Ch. Center Freq. [MHz]	Band Edge Freq. [MHz]	Spurious Level [dBµV/m]	Detector	RBW [kHz]	Limit [dBµV/m]	Margin [dB]	Limit Type	FCC /IC?
1	38	5190	5150.0	55.3	PEAK	1000	74.0	18.7	BE-RB	FCC&IC
	38	5190	5150.0	43.1	AV	1000	54.0	10.9	BE-RB	FCC&IC
3	151	5755	5725.0	79.6	PEAK	1000	122.2	42.6	BE-UE	FCC&IC
	159	5795	5850.0	74.0	PEAK	1000	118.9	44.9	BE-UE	FCC&IC

WLAN n-Mode; 40 MHz; MCS 8; MIMO  
Applied duty cycle correction (AV): 0.5 dB

U-NII-Subband	Ch. No.	Ch. Center Freq. [MHz]	Band Edge Freq. [MHz]	Spurious Level [dBµV/m]	Detector	RBW [kHz]	Limit [dBµV/m]	Margin [dB]	Limit Type	FCC /IC?
1	38	5190	5150.0	55.8	PEAK	1000	74.0	18.2	BE-RB	FCC&IC
	38	5190	5150.0	42.8	AV	1000	54.0	11.2	BE-RB	FCC&IC
3	151	5755	5725.0	70.3	PEAK	1000	121.7	51.4	BE-UE	FCC&IC
	159	5795	5850.0	57.0	PEAK	1000	120.5	63.5	BE-UE	FCC&IC

WLAN ac-Mode; 20 MHz; MCS 0; MIMO  
Applied duty cycle correction (AV): 0.7 dB

U-NII-Subband	Ch. No.	Ch. Center Freq. [MHz]	Band Edge Freq. [MHz]	Spurious Level [dBµV/m]	Detector	RBW [kHz]	Limit [dBµV/m]	Margin [dB]	Limit Type	FCC /IC?
1	36	5180	5150.0	55.7	PEAK	1000	74.0	18.3	BE-RB	FCC&IC
	36	5180	5150.0	43.0	AV	1000	54.0	11.0	BE-RB	FCC&IC
3	149	5745	5725.0	64.6	PEAK	1000	121.0	56.4	BE-UE	FCC&IC
	165	5825	5850.0	56.4	PEAK	1000	120.1	63.7	BE-UE	FCC&IC

WLAN ac-Mode; 80 MHz; MCS 0; MIMO  
Applied duty cycle correction (AV): 0.6 dB

U-NII-Subband	Ch. No.	Ch. Center Freq. [MHz]	Band Edge Freq. [MHz]	Spurious Level [dBµV/m]	Detector	RBW [kHz]	Limit [dBµV/m]	Margin [dB]	Limit Type	FCC /IC?
1	42	5210	5150.0	63.2	PEAK	1000	74.0	10.8	BE-RB	FCC&IC
	42	5210	5150.0	49.0	AV	1000	54.0	5.0	BE-RB	FCC&IC
3	155	5775	5725.0	87.1	PEAK	1000	113.3	26.2	BE-UE	FCC&IC

WLAN ax-Mode; 20 MHz; MCS 0; SISO  
 Applied duty cycle correction (AV): 1.3 dB

U-NII-Subband	Ch. No.	Ch. Center Freq. [MHz]	Band Edge Freq. [MHz]	Spurious Level [dB $\mu$ V/m]	Detector	RBW [kHz]	Limit [dB $\mu$ V/m]	Margin [dB]	Limit Type	FCC /IC?
1	36	5180	5150.0	55.6	PEAK	1000	74.0	18.4	BE-RB	FCC&IC
	36	5180	5150.0	43.8	AV	1000	54.0	10.2	BE-RB	FCC&IC
3	149	5745	5725.0	85.6	PEAK	1000	121.5	35.9	BE-UE	FCC&IC
	165	5825	5850.0	58.5	PEAK	1000	120.6	62.1	BE-UE	FCC&IC

WLAN ax-Mode; 40 MHz; MCS 0; MIMO  
 Applied duty cycle correction (AV): 0.6 dB

U-NII-Subband	Ch. No.	Ch. Center Freq. [MHz]	Band Edge Freq. [MHz]	Spurious Level [dB $\mu$ V/m]	Detector	RBW [kHz]	Limit [dB $\mu$ V/m]	Margin [dB]	Limit Type	FCC /IC?
1	38	5190	5150.0	56.2	PEAK	1000	74.0	17.8	BE-RB	FCC&IC
	38	5190	5150.0	43.1	AV	1000	54.0	10.9	BE-RB	FCC&IC
3	151	5755	5725.0	74.5	PEAK	1000	119.6	45.1	BE-UE	FCC&IC
	159	5795	5850.0	61.9	PEAK	1000	120.7	58.8	BE-UE	FCC&IC

WLAN ax-Mode; 80 MHz; MCS 0; MIMO  
 Applied duty cycle correction (AV): 0.6 dB

U-NII-Subband	Ch. No.	Ch. Center Freq. [MHz]	Band Edge Freq. [MHz]	Spurious Level [dB $\mu$ V/m]	Detector	RBW [kHz]	Limit [dB $\mu$ V/m]	Margin [dB]	Limit Type	FCC /IC?
1	42	5210	5150.0	67.1	PEAK	1000	74.0	6.9	BE-RB	FCC&IC
	42	5210	5150.0	53.2	AV	1000	54.0	0.8	BE-RB	FCC&IC
3	155	5775	5725.0	85.7	PEAK	1000	113.3	27.6	BE-UE	FCC&IC

Remark: Please see next sub-clause for the measurement plot.

Testing for antenna 8DK (16/15.4 dBi gain) was partially performed at higher power setting (U-NII band 1: SISO 20 MHz +2 dB, MIMO +1 dB, SISO + MIMO 40 MHz +2 dB, U-NII band 3: MIMO +1 dB). Since this worse case, the tests were not repeated at final defined power setting.

### 5.8.4 MEASUREMENT PLOT (EXAMPLE PLOT, SHOWING WORST CASE, IF APPLICABLE)

Radio Technology = WLAN a MIMO, Operating Frequency = low, Subband = U-NII-1 (S02\_AC01)

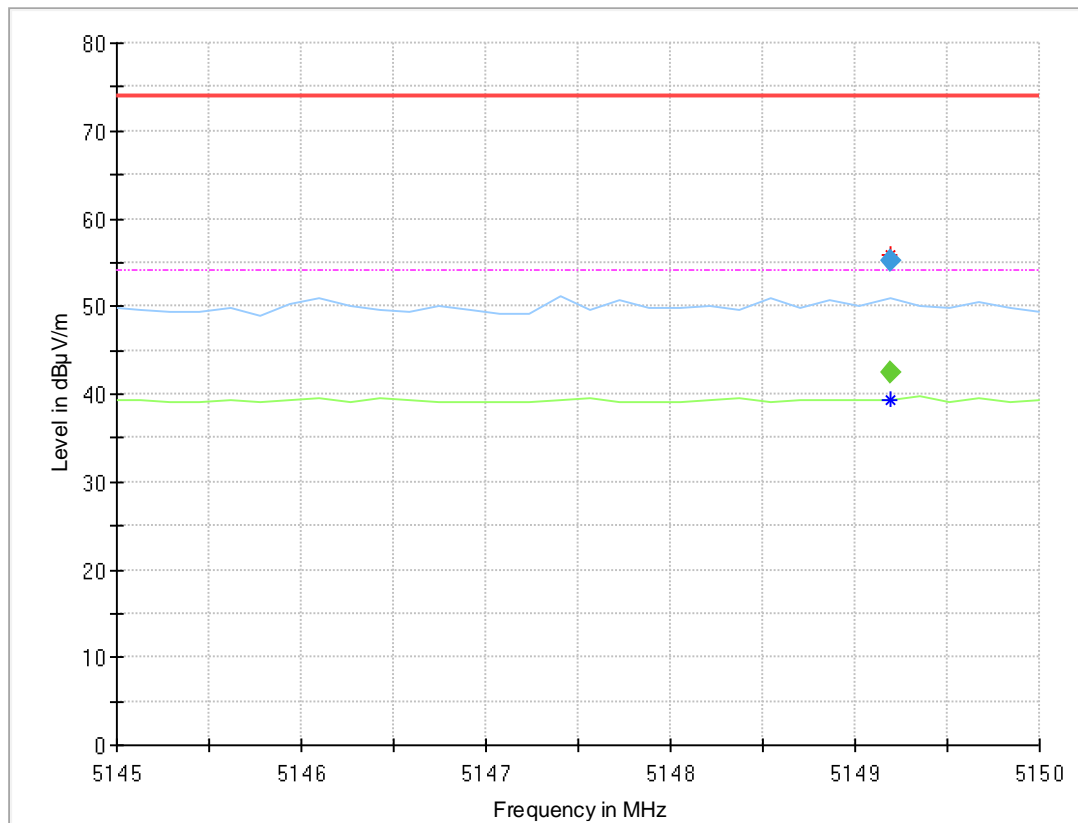

### Final Result

Frequency (MHz)	MaxPeak (dBµV/m)	CAverage (dBµV/m)	Limit (dBµV/m)	Margin (dB)	Meas. Time (ms)	Bandwidth (kHz)	Height (cm)	Pol	Azimuth (deg)	Elevation (deg)	Corr. (dB/m)
5149.188	---	42.5	54.00	11.48	1000.0	1000.000	150.0	V	146.0	-10.0	13.5
5149.188	55.2	---	74.00	18.80	1000.0	1000.000	150.0	V	146.0	-10.0	13.5

Radio Technology = WLAN a MIMO, Operating Frequency = low, Subband = U-NII-3 (S02\_AC02)

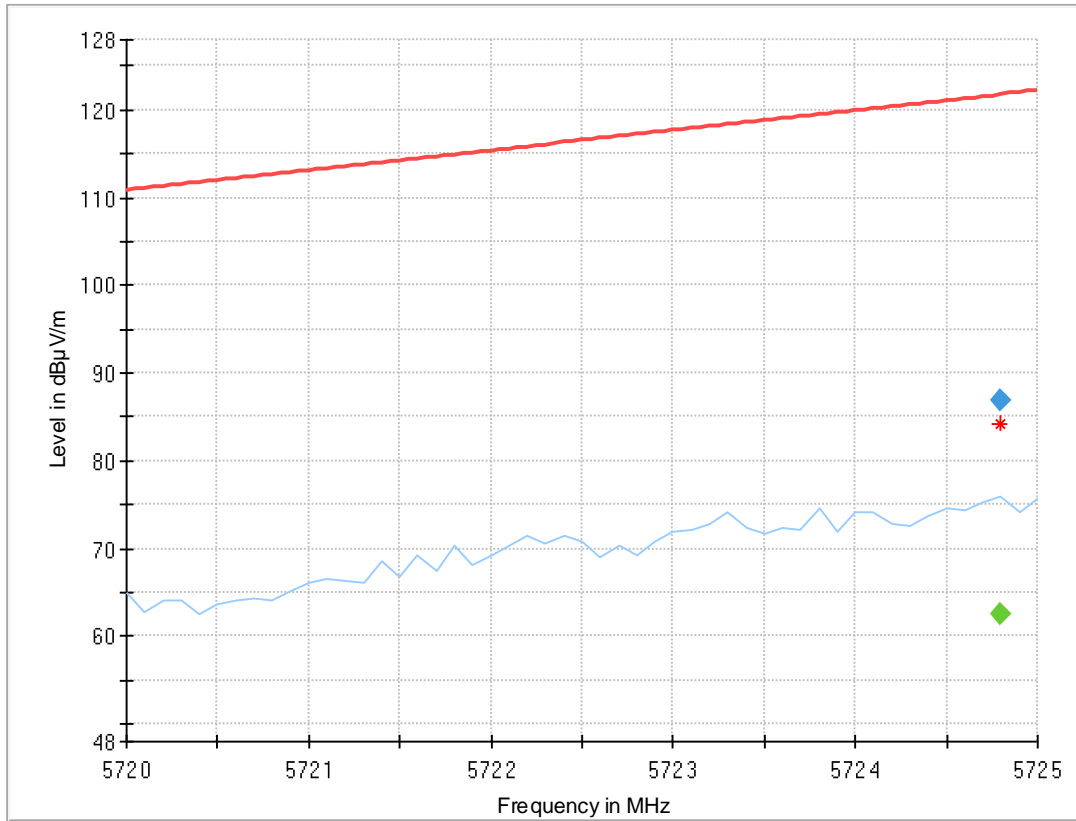

### Final Result

Frequency (MHz)	MaxPeak (dBµV/m)	CAverage (dBµV/m)	Limit (dBµV/m)	Margin (dB)	Meas. Time (ms)	Bandwidth (kHz)	Height (cm)	Pol	Azimuth (deg)	Elevation (deg)	Corr. (dB/m)
5724.800	---	62.5	---	---	1000.0	1000.000	150.0	V	125.0	-12.0	14.2
5724.800	87.0	---	121.7	34.78	1000.0	1000.000	150.0	V	125.0	-12.0	14.2



Radio Technology = WLAN a MIMO, Operating Frequency = high, Subband = U-NII-3 (S02\_AC02)

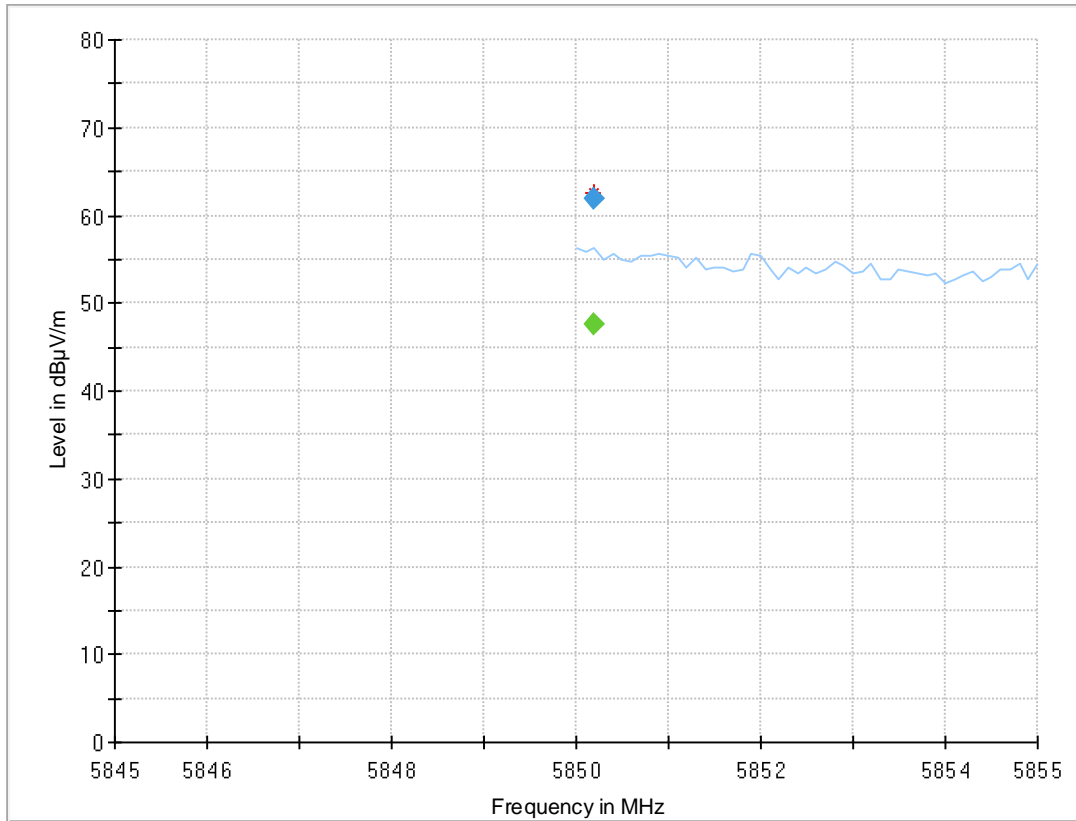

### Final Result

Frequency (MHz)	MaxPeak (dBµV/m)	CAverage (dBµV/m)	Limit (dBµV/m)	Margin (dB)	Meas. Time (ms)	Bandwidth (kHz)	Height (cm)	Pol	Azimuth (deg)	Elevation (deg)	Corr. (dB/m)
5850.200	---	47.7	---	---	1000.0	1000.000	150.0	V	-176.0	1.0	14.9
5850.200	61.9	---	121.7	59.87	1000.0	1000.000	150.0	V	-176.0	1.0	14.9

Radio Technology = WLAN ac 20 MHz, Operating Frequency = low, Subband = U-NII-1 (S02\_AC02)

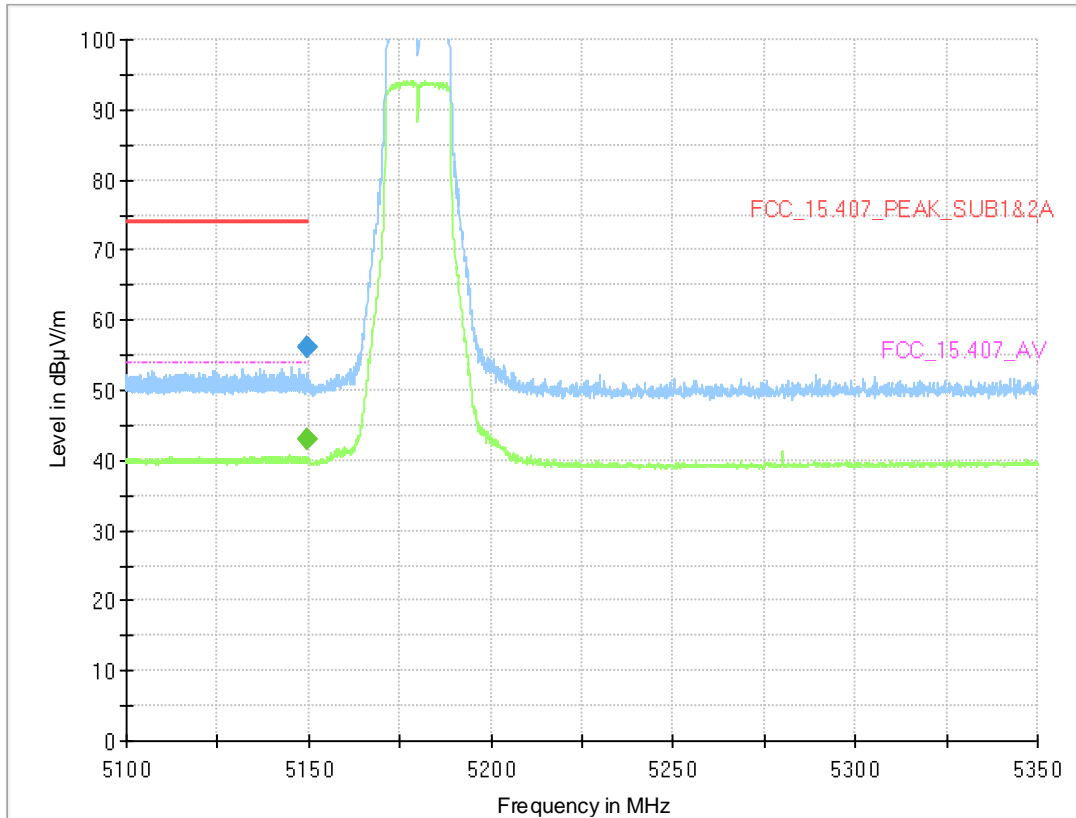

**Final Result**

Frequency (MHz)	MaxPeak (dBµV/m)	CAverage (dBµV/m)	Limit (dBµV/m)	Margin (dB)	Meas. Time (ms)	Bandwidth (kHz)	Height (cm)	Pol	Azimuth (deg)	Elevation (deg)	Corr. (dB/m)
5149.838	---	43.0	54.00	10.96	1000.0	1000.000	150.0	V	141.0	6.0	13.5
5149.838	56.1	---	74.00	17.88	1000.0	1000.000	150.0	V	141.0	6.0	13.5

Radio Technology = WLAN ac 20 MHz, Operating Frequency = low, Subband = U-NII-3 (S02\_AC02)

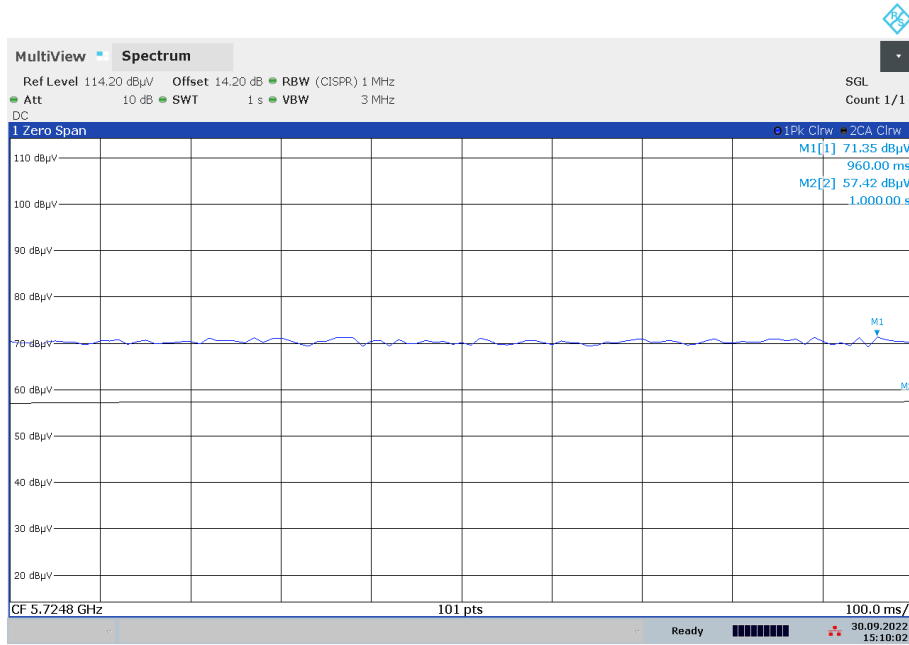

15:10:03 30.09.2022

Radio Technology = WLAN ac 20 MHz, Operating Frequency = high, Subband = U-NII-3 (S02\_AC02)

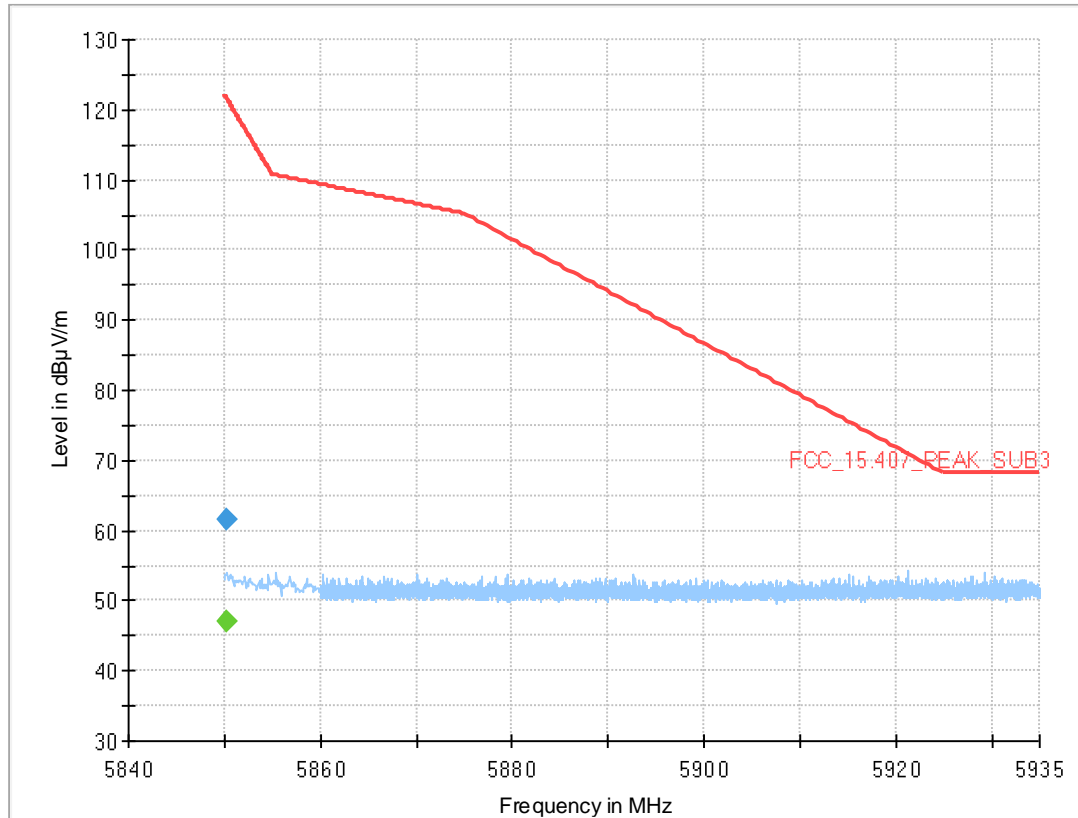

### Final Result

Frequency (MHz)	MaxPeak (dBµV/m)	CAverage (dBµV/m)	Limit (dBµV/m)	Margin (dB)	Meas. Time (ms)	Bandwidth (kHz)	Height (cm)	Pol	Azimuth (deg)	Elevation (deg)	Corr. (dB/m)
5850.300	---	47.0	---	---	1000.0	1000.000	150.0	V	-51.0	10.0	14.9
5850.300	61.7	---	121.5	59.83	1000.0	1000.000	150.0	V	-51.0	10.0	14.9

Radio Technology = WLAN ac 40 MHz, Operating Frequency = low, Subband = U-NII-1 (S02\_AC02)



13:14:41 26.09.2022

Radio Technology = WLAN ac 40 MHz, Operating Frequency = low, Subband = U-NII-3 (S02\_AC02)

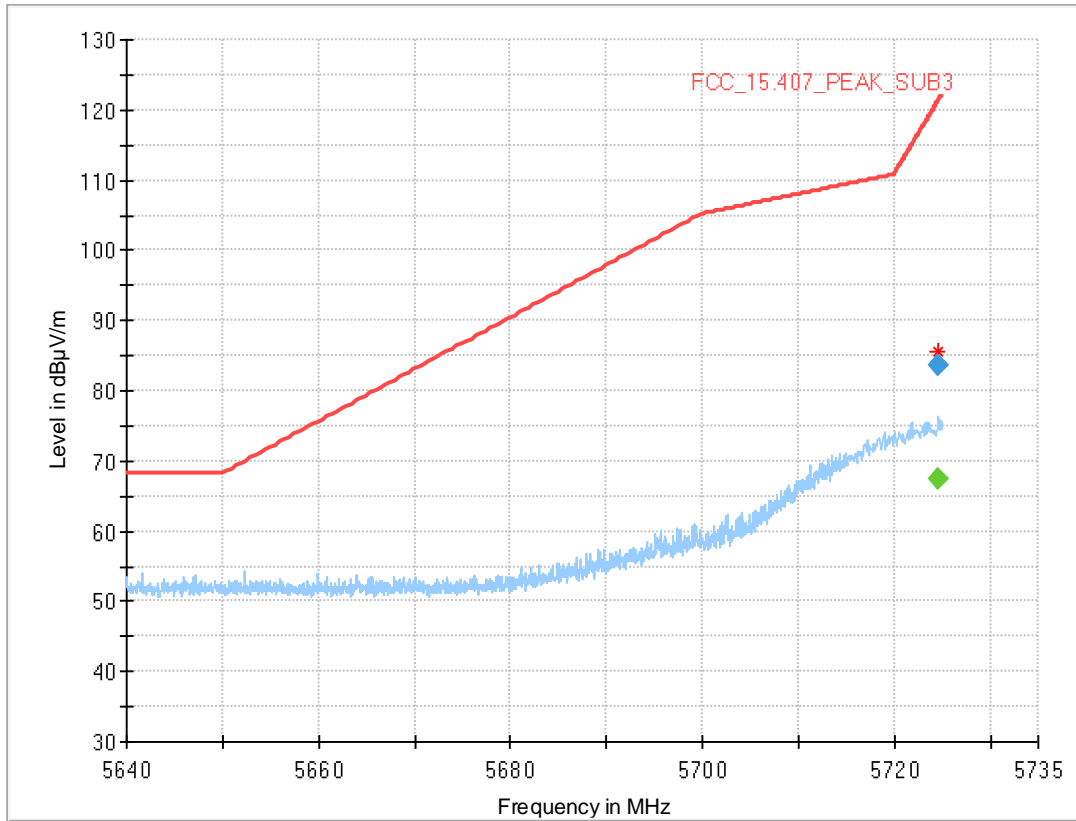

**Final Result**

Frequency (MHz)	MaxPeak (dBµV/m)	CAverage (dBµV/m)	Limit (dBµV/m)	Margin (dB)	Meas. Time (ms)	Bandwidth (kHz)	Height (cm)	Pol	Azimuth (deg)	Elevation (deg)	Corr. (dB/m)
5724.600	---	67.5	---	---	1000.0	1000.000	150.0	H	56.0	90.0	14.2
5724.600	83.7	---	121.2	37.56	1000.0	1000.000	150.0	H	56.0	90.0	14.2

Radio Technology = WLAN ac 40 MHz, Operating Frequency = high, Subband = U-NII-3 (S02\_AC02)

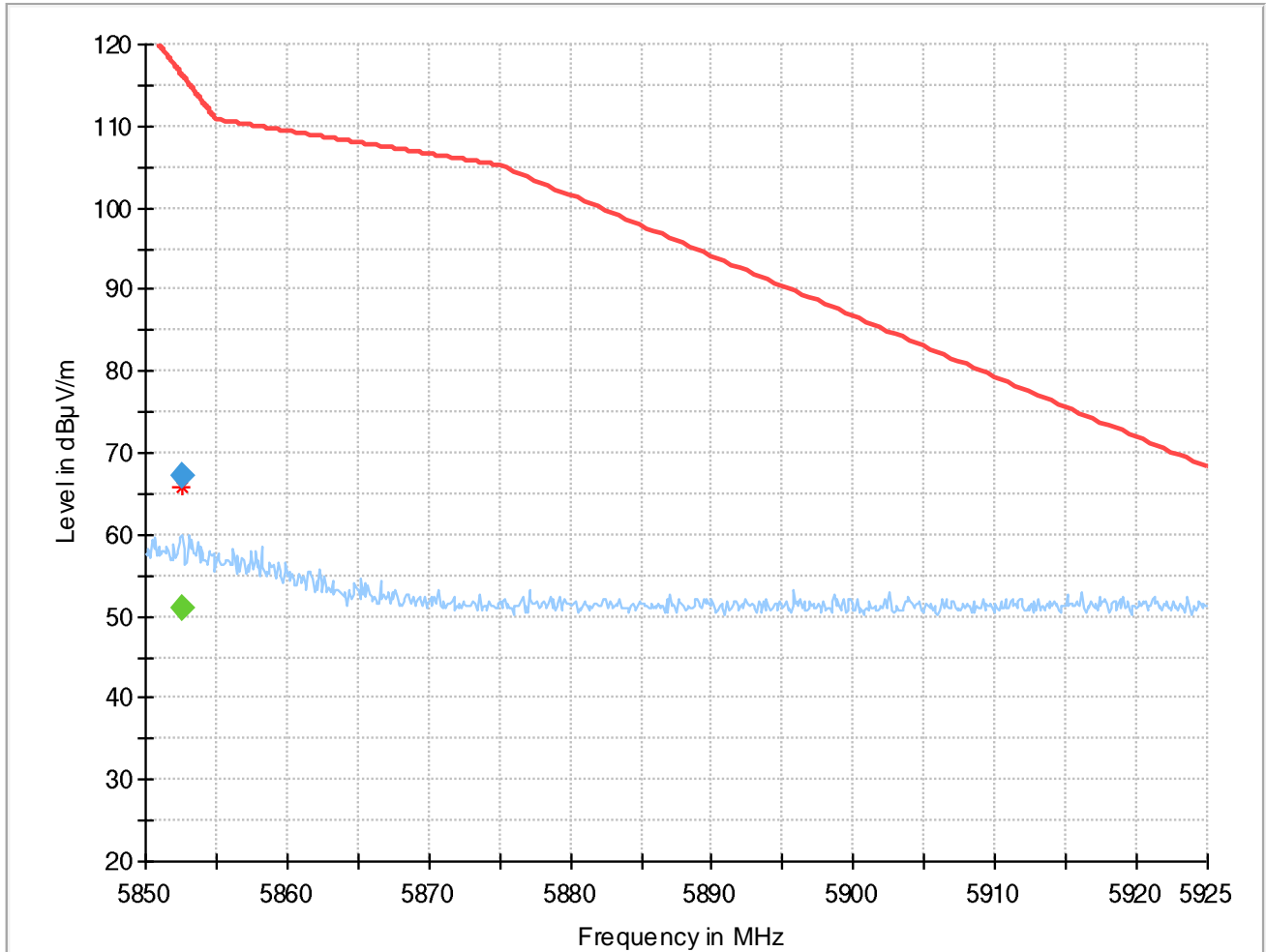

### Final Result

Frequency (MHz)	Max Peak (dBµV /m)	CAverage (dBµV /m)	Limit (dBµV /m)	Margin (dB)	Meas. Time (ms)	Bandwidth h (kHz)	Height (cm)	Pol	Azimuth (deg)	Elevation (deg)	Corr. (dB/m)
5852.600	67.1	---	116.27	49.19	1000.0	1000.000	150.0	H	-41.0	81.0	14.9
5852.600	---	51.0	---	---	1000.0	1000.000	150.0	H	-41.0	81.0	14.9
5929.540	57.5	---	68.20	10.69	1000.0	1000.000	150.0	V	-126.0	84.0	15.0
5929.540	---	43.5	---	---	1000.0	1000.000	150.0	V	-126.0	84.0	15.0

Radio Technology = WLAN n 20 MHz MIMO, Operating Frequency = low, Subband = U-NII-1 (S02\_AC02)

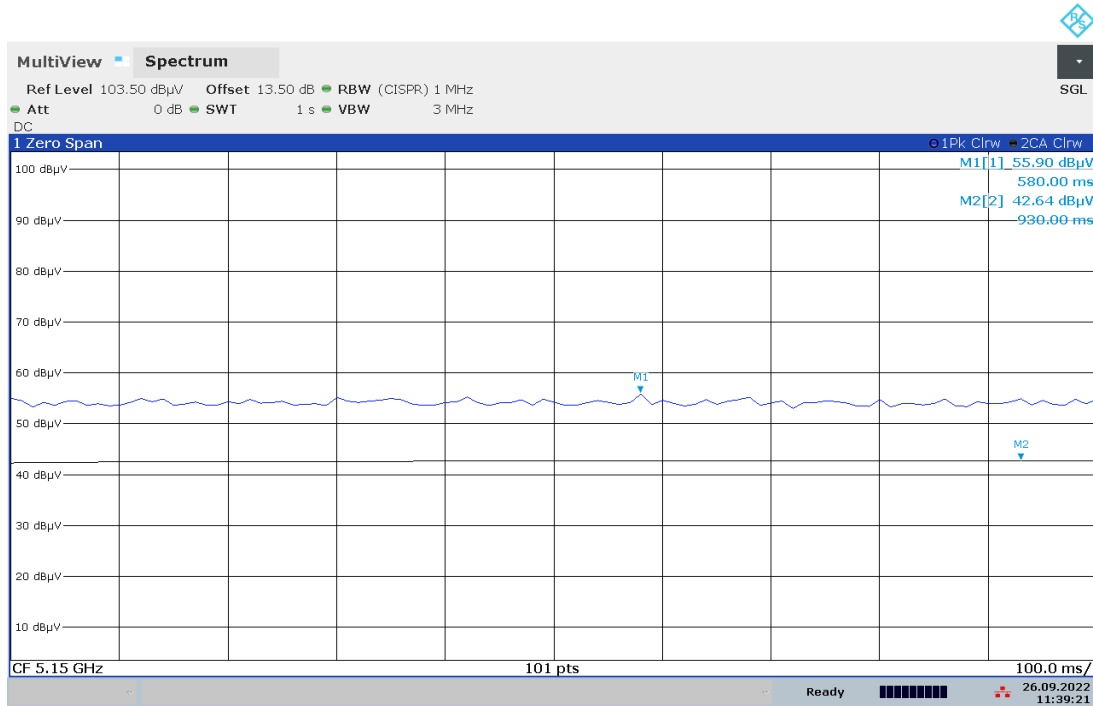

11:39:22 26.09.2022



Radio Technology = WLAN n 20 MHz MIMO, Operating Frequency = low, Subband = U-NII-3 (S02\_AC02)

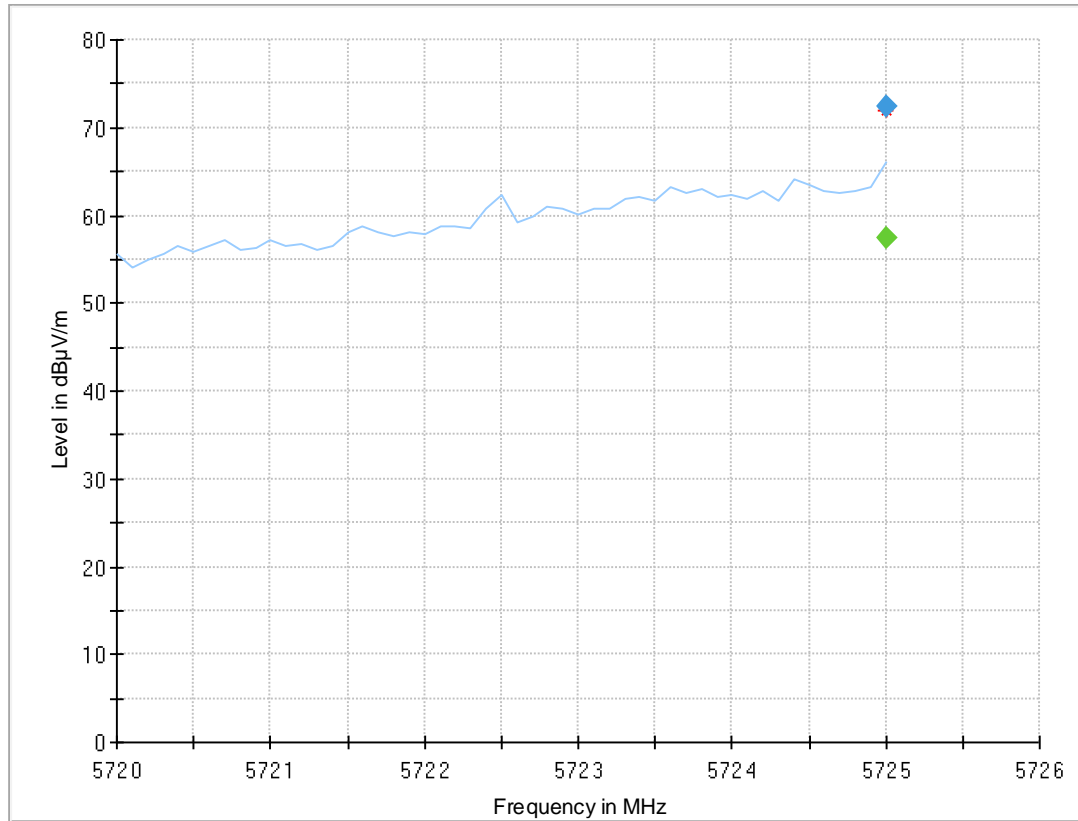

### Final Result

Frequency (MHz)	MaxPeak (dBµV/m)	CAverage (dBµV/m)	Limit (dBµV/m)	Margin (dB)	Meas. Time (ms)	Bandwidth (kHz)	Height (cm)	Pol	Azimuth (deg)	Elevation (deg)	Corr. (dB/m)
5725.000	---	57.3	---	---	1000.0	1000.000	150.0	V	-191.0	-15.0	14.2
5725.000	72.4	---	122.2	49.82	1000.0	1000.000	150.0	V	-191.0	-15.0	14.2

Radio Technology = WLAN n 20 MHz MIMO, Operating Frequency = high, Subband = U-NII-3 (S02\_AC02)

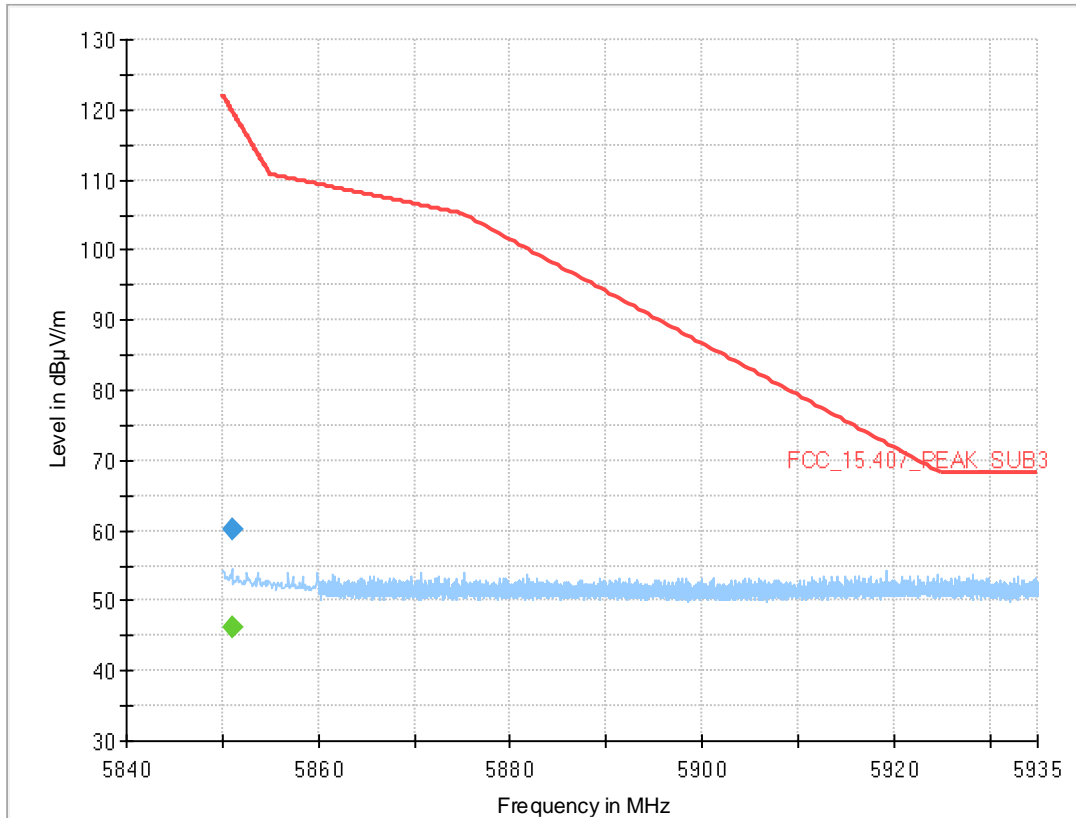

**Final Result**

Frequency (MHz)	MaxPeak (dBµV/m)	CAverage (dBµV/m)	Limit (dBµV/m)	Margin (dB)	Meas. Time (ms)	Bandwidth (kHz)	Height (cm)	Pol	Azimuth (deg)	Elevation (deg)	Corr. (dB/m)
5851.000	---	46.1	---	---	1000.0	1000.000	150.0	V	135.0	-12.0	14.9
5851.000	60.2	---	119.9	59.74	1000.0	1000.000	150.0	V	135.0	-12.0	14.9

Radio Technology = WLAN n 40 MHz MIMO, Operating Frequency = low, Subband = U-NII-1 (S02\_AC02)

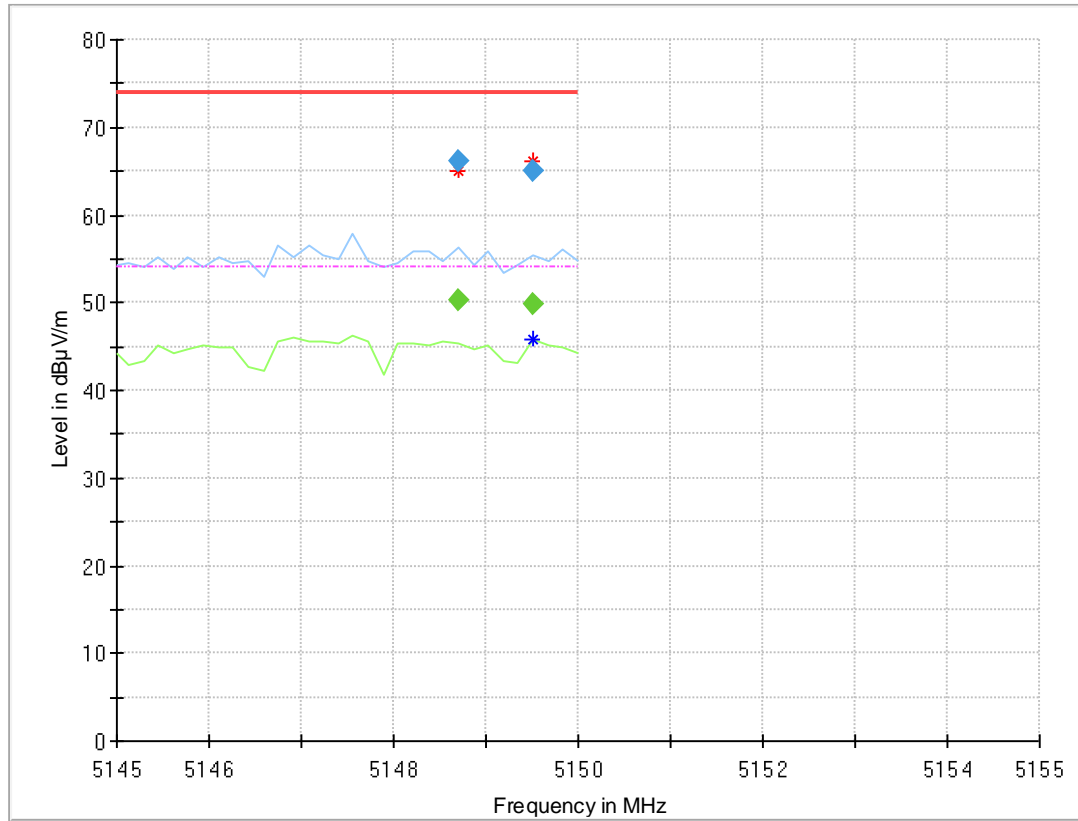

### Final Result

Frequency (MHz)	MaxPeak (dBµV/m)	CAverage (dBµV/m)	Limit (dBµV/m)	Margin (dB)	Meas. Time (ms)	Bandwidth (kHz)	Height (cm)	Pol	Azimuth (deg)	Elevation (deg)	Corr. (dB/m)
5148.700	---	50.2	54.00	3.82	1000.0	1000.000	150.0	H	-2.0	91.0	13.5
5148.700	66.1	---	74.00	7.87	1000.0	1000.000	150.0	H	-2.0	91.0	13.5
5149.513	---	49.9	54.00	4.07	1000.0	1000.000	150.0	H	-1.0	91.0	13.5
5149.513	65.1	---	74.00	8.90	1000.0	1000.000	150.0	H	-1.0	91.0	13.5

Radio Technology = WLAN n 40 MHz MIMO, Operating Frequency = low, Subband = U-NII-3 (S02\_AC02)

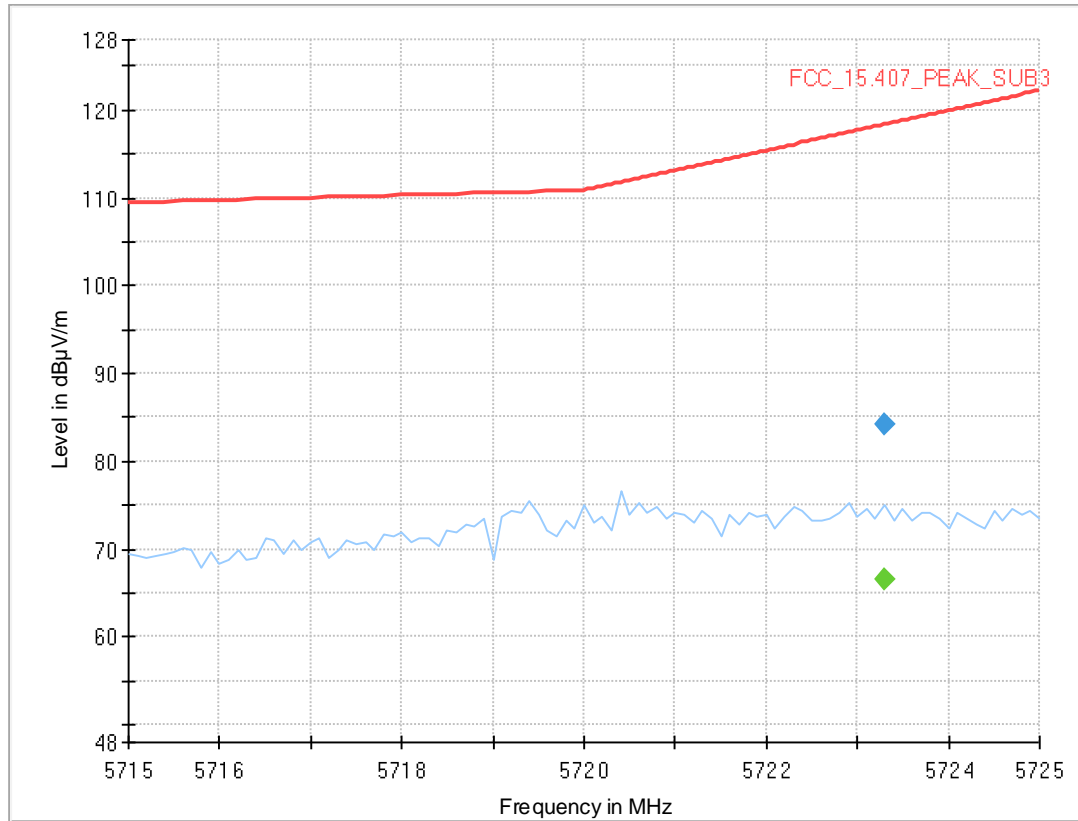

### Final Result

Frequency (MHz)	MaxPeak (dBµV/m)	CAverage (dBµV/m)	Limit (dBµV/m)	Margin (dB)	Meas. Time (ms)	Bandwidth (kHz)	Height (cm)	Pol	Azimuth (deg)	Elevation (deg)	Corr. (dB/m)
5723.300	---	66.7	---	---	1000.0	1000.000	150.0	H	-53.0	75.0	14.2
5723.300	84.2	---	118.3	34.17	1000.0	1000.000	150.0	H	-53.0	75.0	14.2

Radio Technology = WLAN n 40 MHz MIMO, Operating Frequency = high, Subband = U-NII-3 (S02\_AC02)

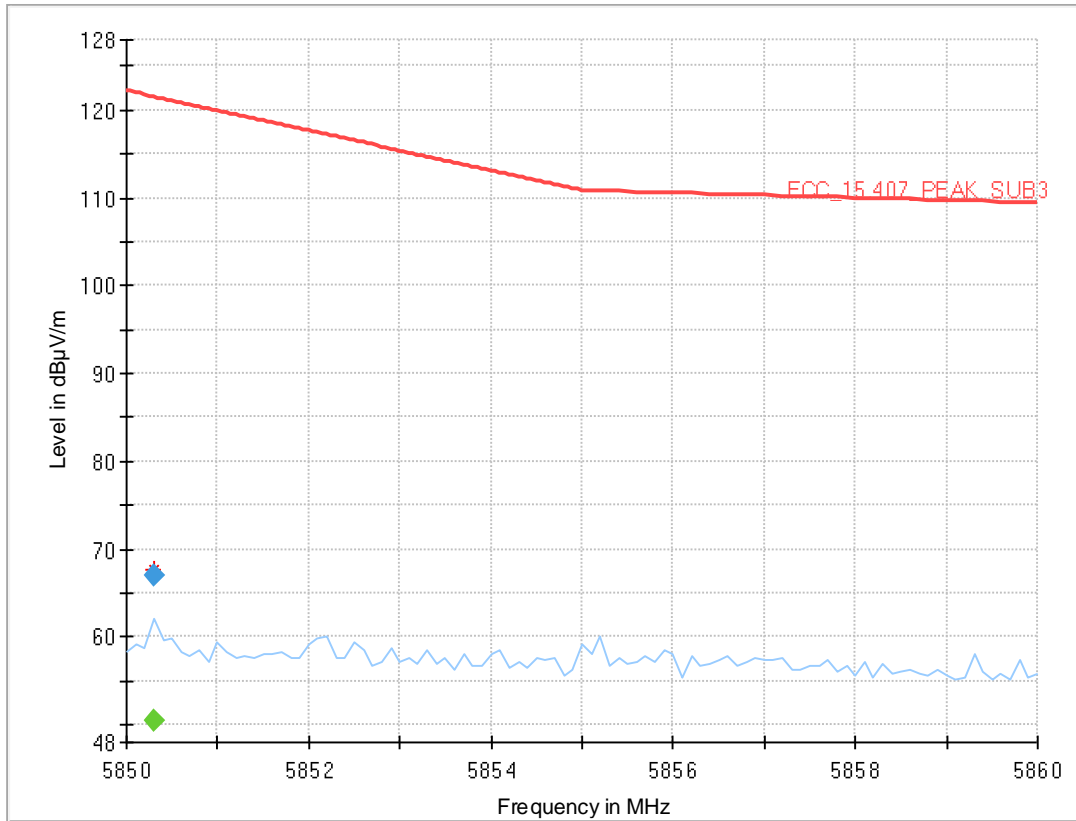

### Final Result

Frequency (MHz)	MaxPeak (dBµV/m)	CAverage (dBµV/m)	Limit (dBµV/m)	Margin (dB)	Meas. Time (ms)	Bandwidth (kHz)	Height (cm)	Pol	Azimuth (deg)	Elevation (deg)	Corr. (dB/m)
5850.300	---	50.6	---	---	1000.0	1000.000	150.0	H	-4.0	89.0	14.9
5850.300	66.9	---	121.5	54.59	1000.0	1000.000	150.0	H	-4.0	89.0	14.9

Radio Technology = WLAN ac 80 MHz MIMO, Operating Frequency = mid, Subband = U-NII-1 (S02\_AC02)

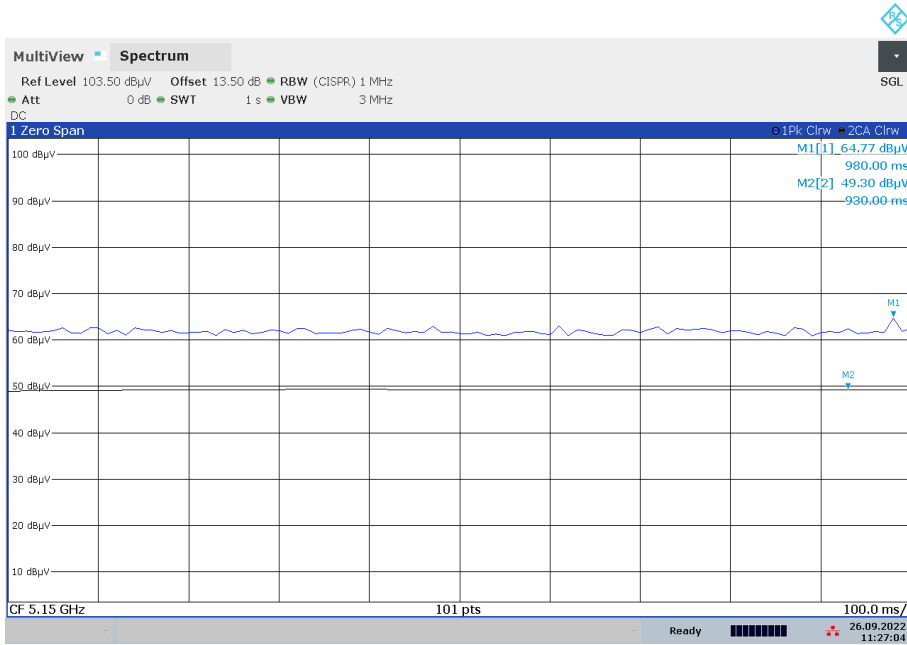

11:27:05 26.09.2022

Radio Technology = WLAN ac 80 MHz MIMO, Operating Frequency = mid, Subband = U-NII-3 (S02\_AC02)

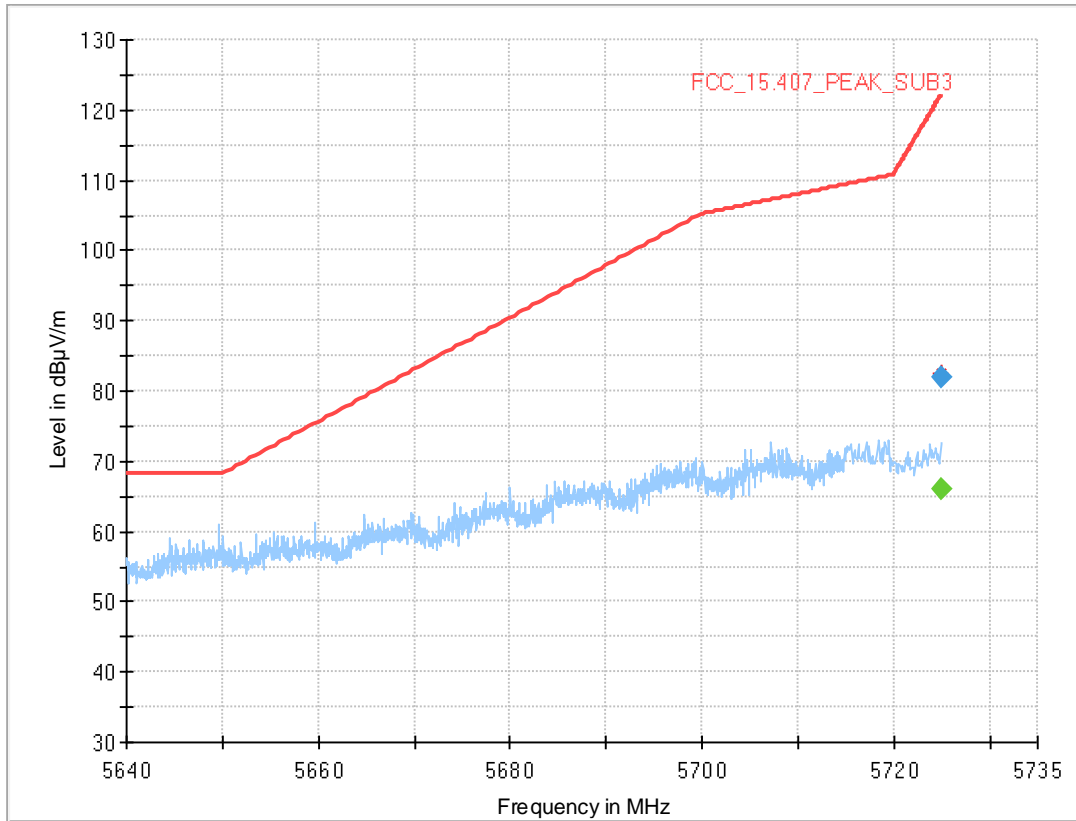

### Final Result

Frequency (MHz)	MaxPeak (dBµV/m)	CAverage (dBµV/m)	Limit (dBµV/m)	Margin (dB)	Meas. Time (ms)	Bandwidth (kHz)	Height (cm)	Pol	Azimuth (deg)	Elevation (deg)	Corr. (dB/m)
5725.000	---	66.1	---	---	1000.0	1000.000	150.0	H	-54.0	90.0	14.2
5725.000	82.0	---	122.2	40.25	1000.0	1000.000	150.0	H	-54.0	90.0	14.2

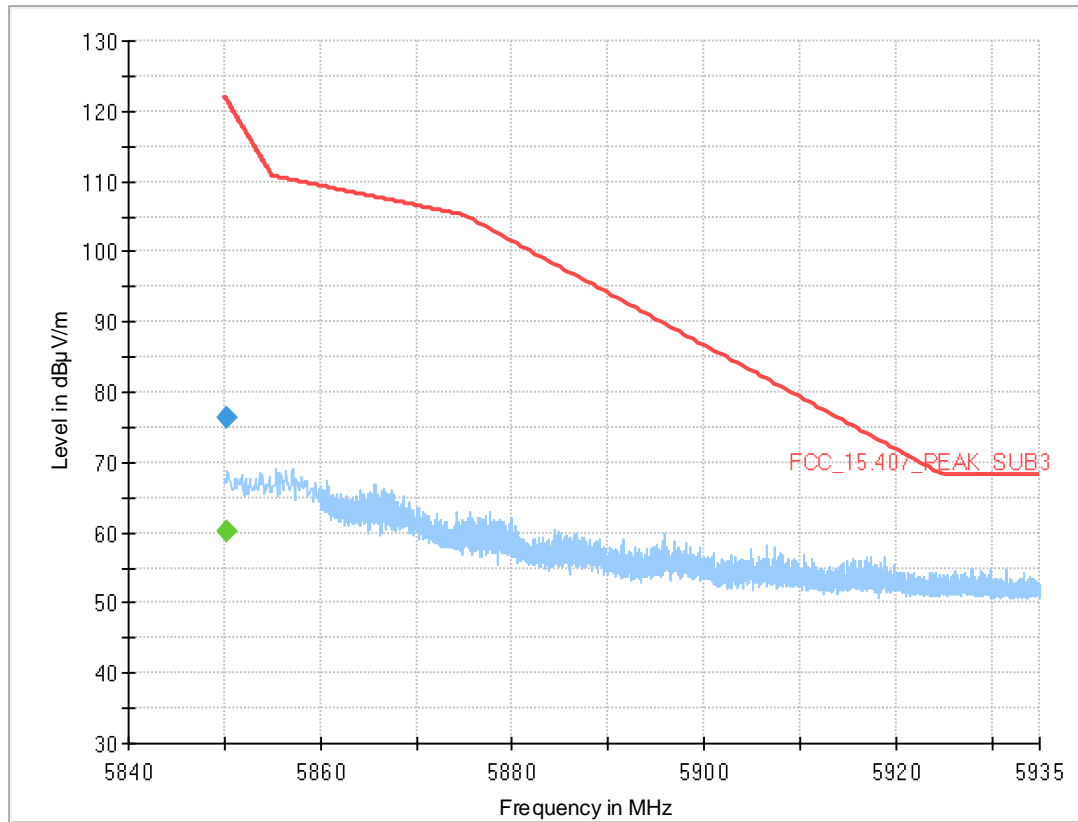

### Final Result

Frequency (MHz)	MaxPeak (dBµV/m)	CAverage (dBµV/m)	Limit (dBµV/m)	Margin (dB)	Meas. Time (ms)	Bandwidth (kHz)	Height (cm)	Pol	Azimuth (deg)	Elevation (deg)	Corr. (dB/m)
5850.300	---	60.3	---	---	1000.0	1000.000	150.0	V	-39.0	8.0	14.9
5850.300	76.5	---	121.5	45.01	1000.0	1000.000	150.0	V	-39.0	8.0	14.9



Radio Technology = WLAN ax 20 MHz, Operating Frequency = low, Subband = U-NII-1 (S02\_AC02)

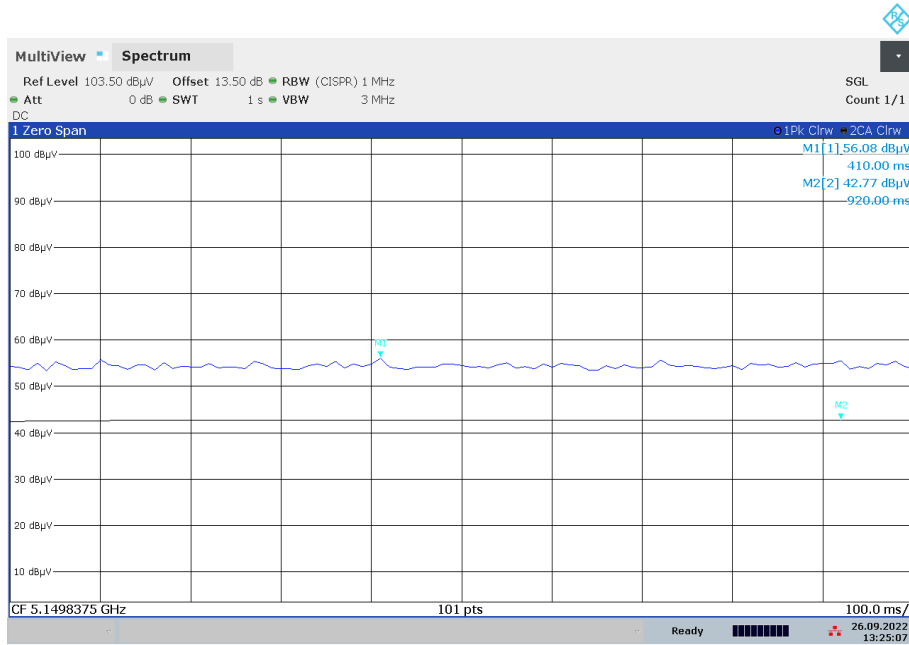

13:25:08 26.09.2022

Radio Technology = WLAN ax 20 MHz, Operating Frequency = low, Subband = U-NII-3 (S02\_AC02)

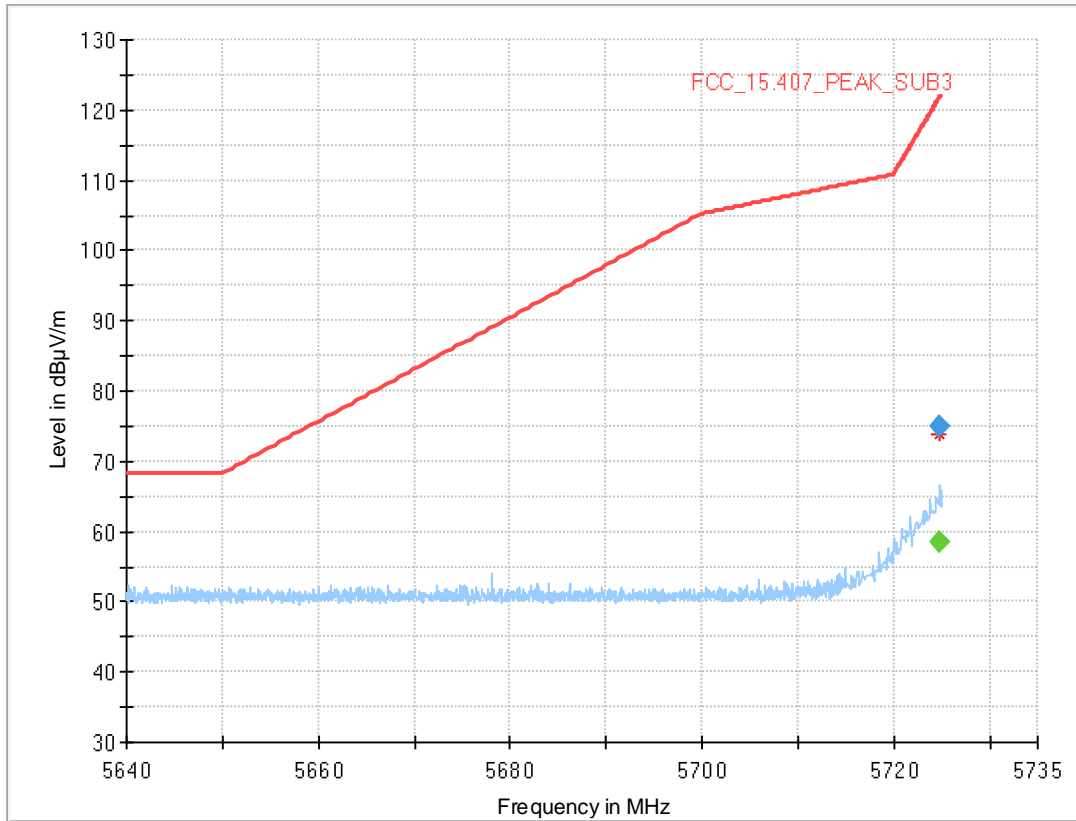

### Final Result

Frequency (MHz)	MaxPeak (dBµV/m)	CAverage (dBµV/m)	Limit (dBµV/m)	Margin (dB)	Meas. Time (ms)	Bandwidth (kHz)	Height (cm)	Pol	Azimuth (deg)	Elevation (deg)	Corr. (dB/m)
5724.800	---	58.5	---	---	1000.0	1000.000	150.0	H	-56.0	90.0	14.2
5724.800	74.9	---	121.7	46.81	1000.0	1000.000	150.0	H	-56.0	90.0	14.2

Radio Technology = WLAN ax 20 MHz, Operating Frequency = high, Subband = U-NII-3 (S02\_AC02)

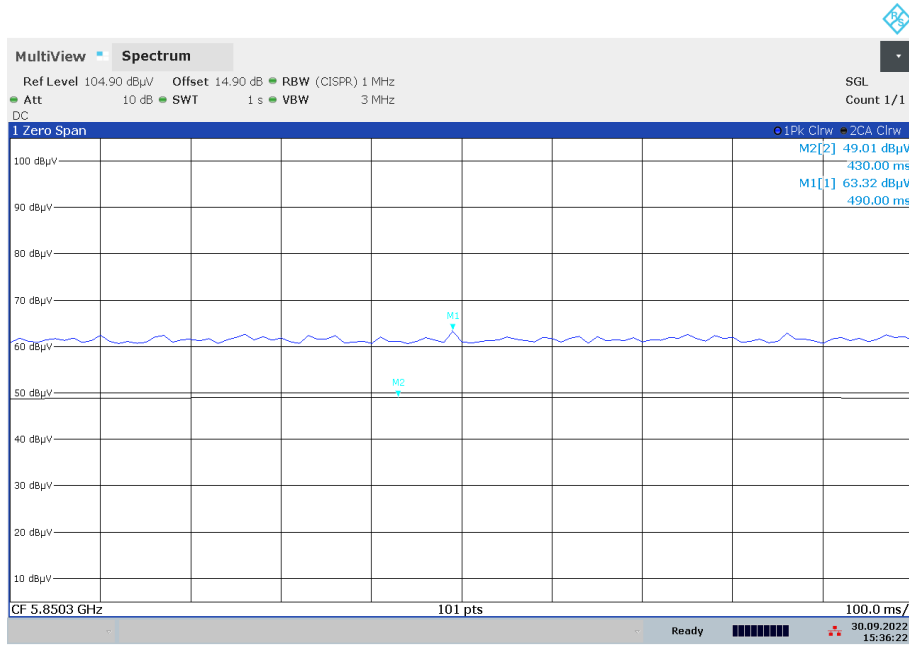

15:36:22 30.09.2022

Radio Technology = WLAN ax 40 MHz, Operating Frequency = low, Subband = U-NII-1 (S02\_AC02)

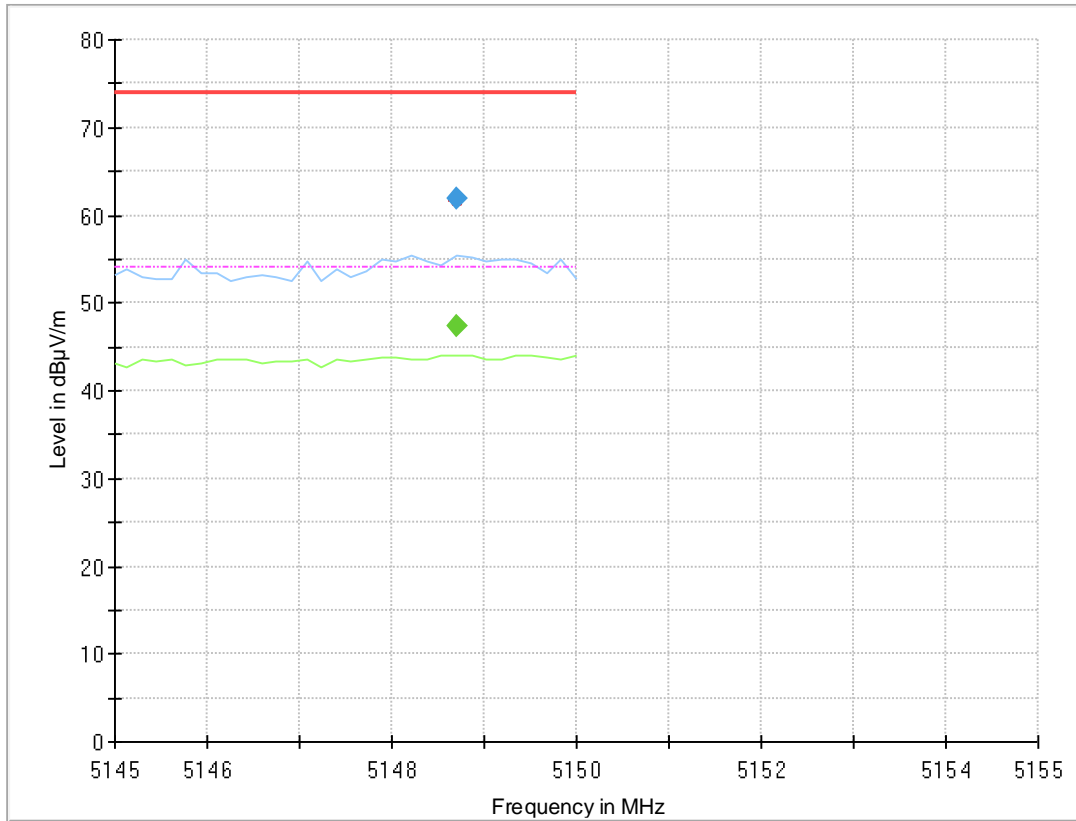

**Final Result**

Frequency (MHz)	MaxPeak (dBµV/m)	CAverage (dBµV/m)	Limit (dBµV/m)	Margin (dB)	Meas. Time (ms)	Bandwidth (kHz)	Height (cm)	Pol	Azimuth (deg)	Elevation (deg)	Corr. (dB/m)
5148.700	---	47.4	54.00	6.57	1000.0	1000.000	150.0	H	42.0	84.0	13.5
5148.700	61.9	---	74.00	12.06	1000.0	1000.000	150.0	H	42.0	84.0	13.5

Radio Technology = WLAN ax 40 MHz, Operating Frequency = low, Subband = U-NII-3 (S02\_AC02)

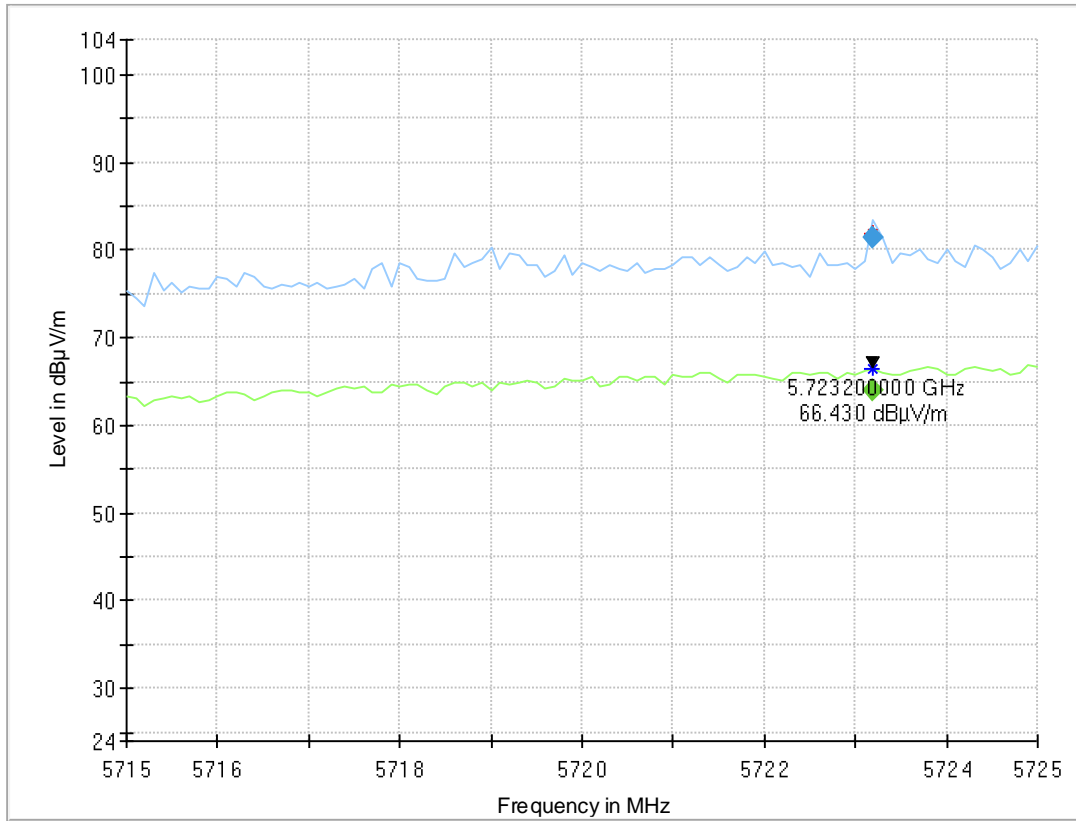

### Final Result

Frequency (MHz)	MaxPeak (dBµV/m)	CAverage (dBµV/m)	Limit (dBµV/m)	Margin (dB)	Meas. Time (ms)	Bandwidth (kHz)	Height (cm)	Pol	Azimuth (deg)	Elevation (deg)	Corr. (dB/m)
5723.200	---	64.1	---	---	1000.0	1000.000	150.0	H	56.0	100.0	14.2
5723.200	81.4	---	118.1	36.67	1000.0	1000.000	150.0	H	56.0	100.0	14.2

Radio Technology = WLAN ax 40 MHz, Operating Frequency = high, Subband = U-NII-3 (S02\_AC02)

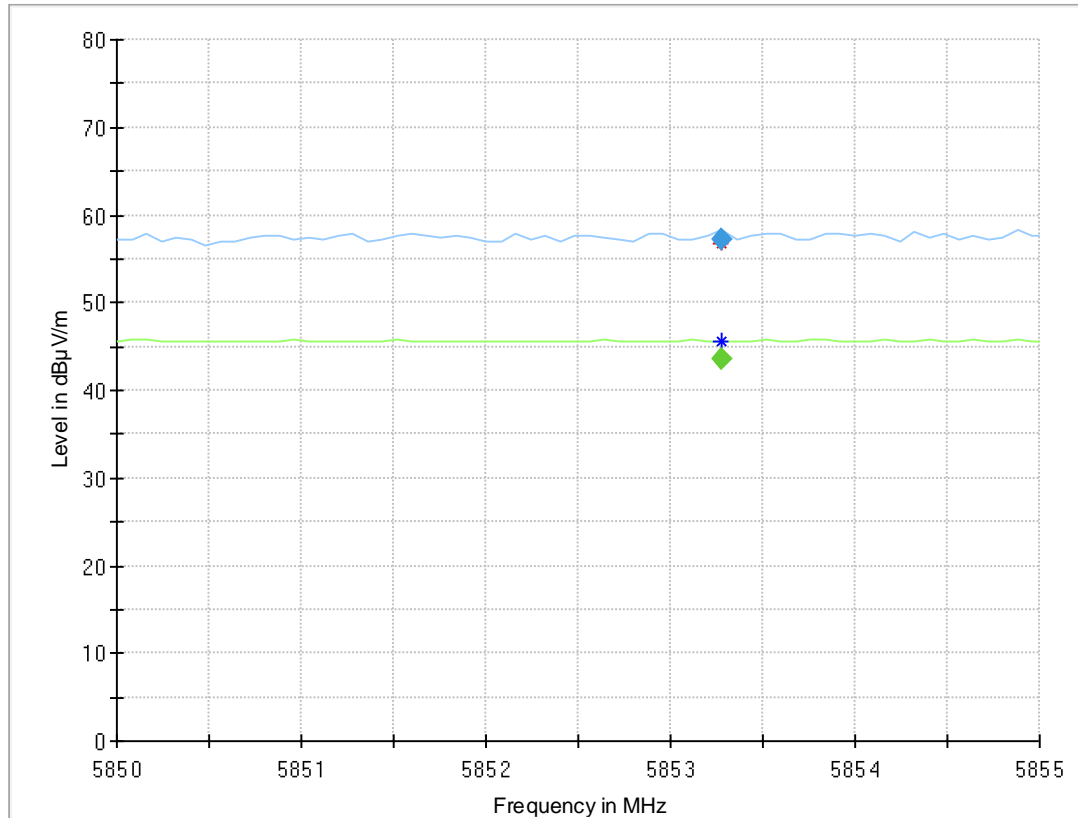

### Final Result

Frequency (MHz)	MaxPeak (dBµV/m)	CAverage (dBµV/m)	Limit (dBµV/m)	Margin (dB)	Meas. Time (ms)	Bandwidth (kHz)	Height (cm)	Pol	Azimuth (deg)	Elevation (deg)	Corr. (dB/m)
5853.280	---	43.6	---	---	1000.0	1000.000	150.0	H	-124.0	78.0	14.9
5853.280	57.2	---	114.7	57.53	1000.0	1000.000	150.0	H	-124.0	78.0	14.9

Radio Technology = WLAN ax 80 MHz MIMO, Operating Frequency = mid, Subband = U-NII-1 (S02\_AC02)

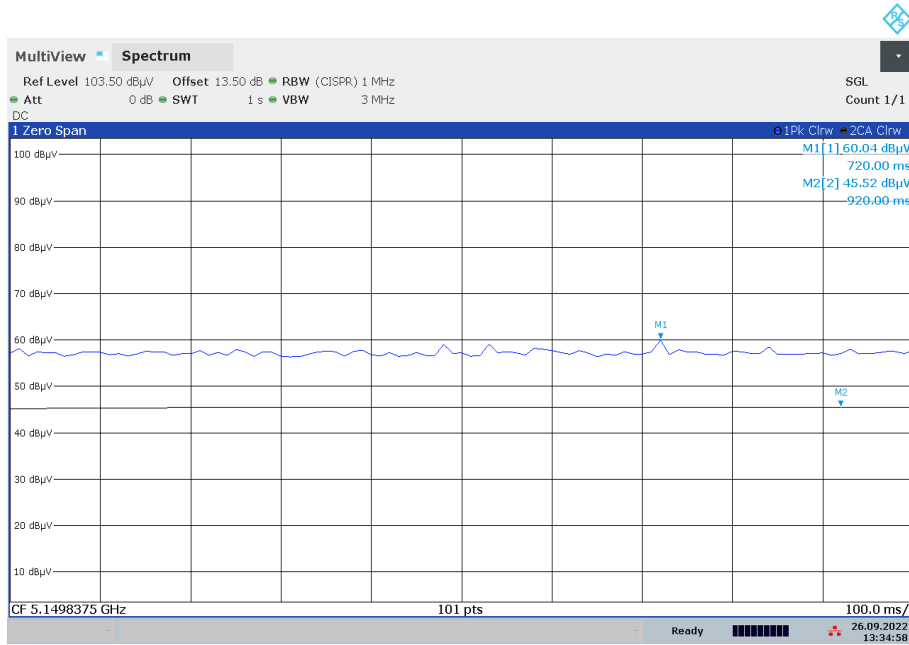

13:34:59 26.09.2022

Radio Technology = WLAN ax 80 MHz MIMO, Operating Frequency = mid, Subband = U-NII-3 (S02\_AC02)

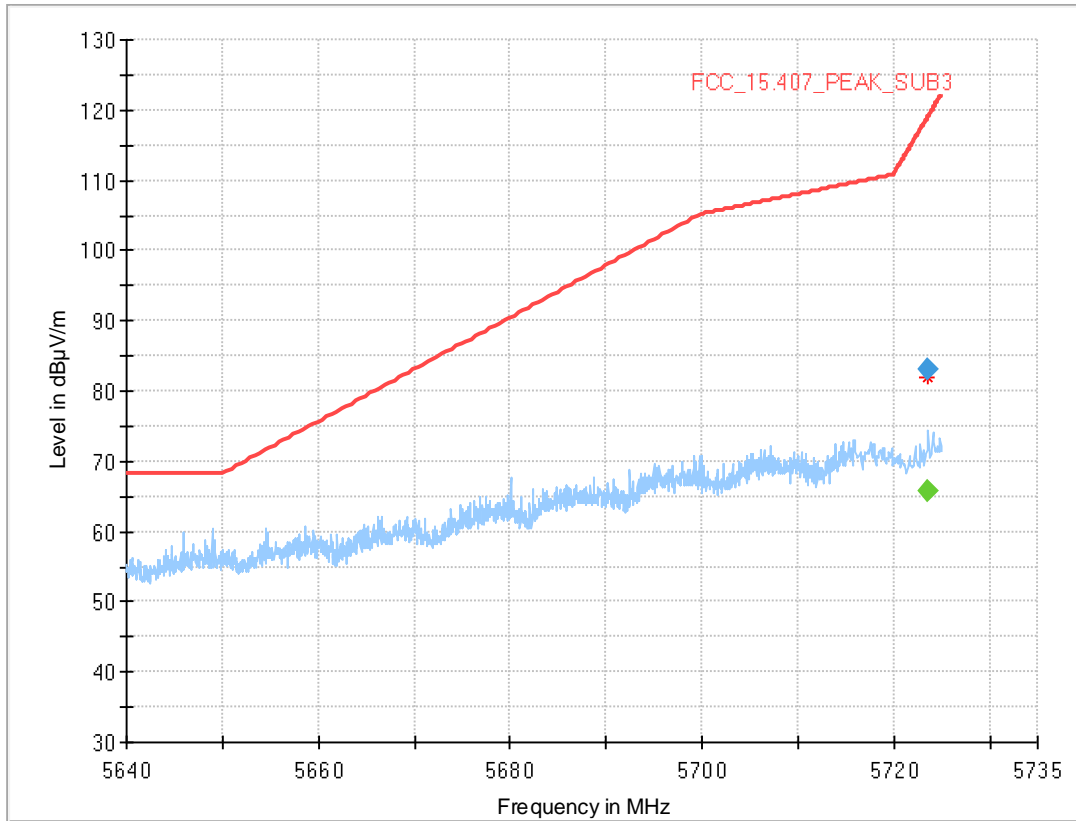

**Final Result**

Frequency (MHz)	MaxPeak (dBµV/m)	CAverage (dBµV/m)	Limit (dBµV/m)	Margin (dB)	Meas. Time (ms)	Bandwidth (kHz)	Height (cm)	Pol	Azimuth (deg)	Elevation (deg)	Corr. (dB/m)
5723.600	---	65.9	---	---	1000.0	1000.000	150.0	H	-54.0	103.0	14.2
5723.600	83.0	---	119.0	36.06	1000.0	1000.000	150.0	H	-54.0	103.0	14.2



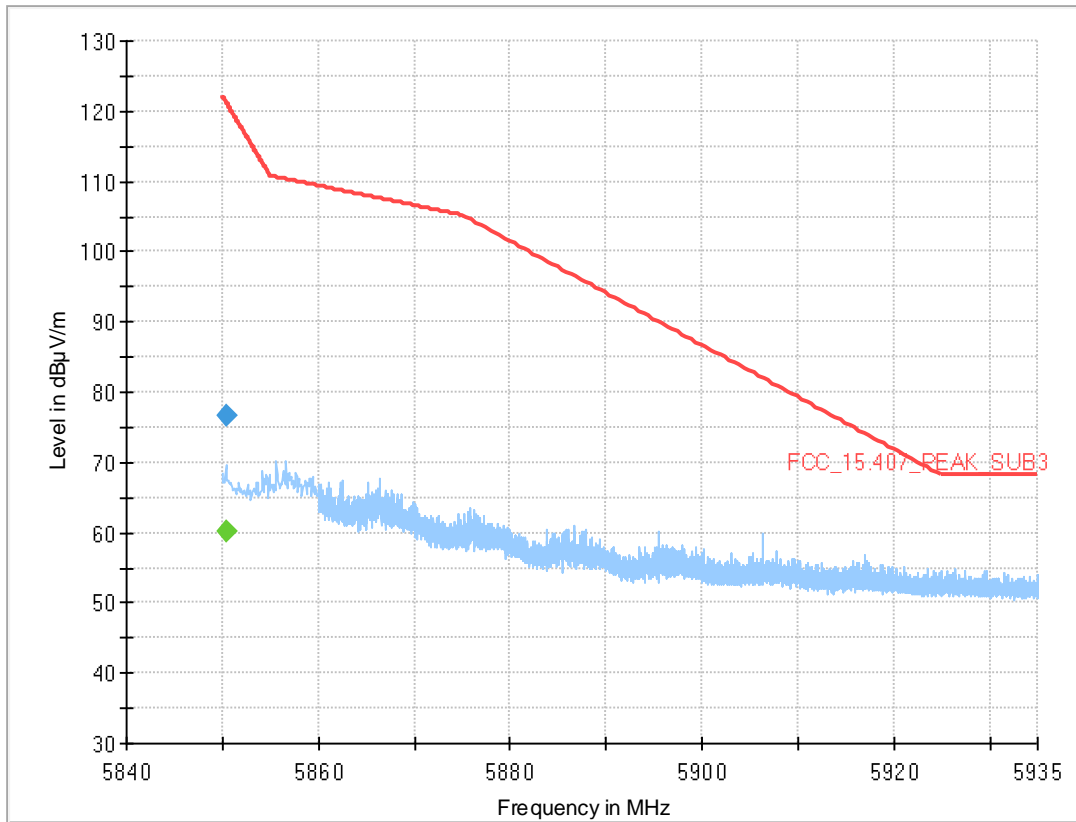

### Final Result

Frequency (MHz)	MaxPeak (dBµV/m)	CAverage (dBµV/m)	Limit (dBµV/m)	Margin (dB)	Meas. Time (ms)	Bandwidth (kHz)	Height (cm)	Pol	Azimuth (deg)	Elevation (deg)	Corr. (dB/m)
5850.400	---	60.1	---	---	1000.0	1000.000	150.0	V	-38.0	15.0	14.9
5850.400	76.7	---	121.2	44.55	1000.0	1000.000	150.0	V	-38.0	15.0	14.9

Radio Technology = WLAN a, Operating Frequency = low, Subband = U-NII-1 (S03\_AC02)

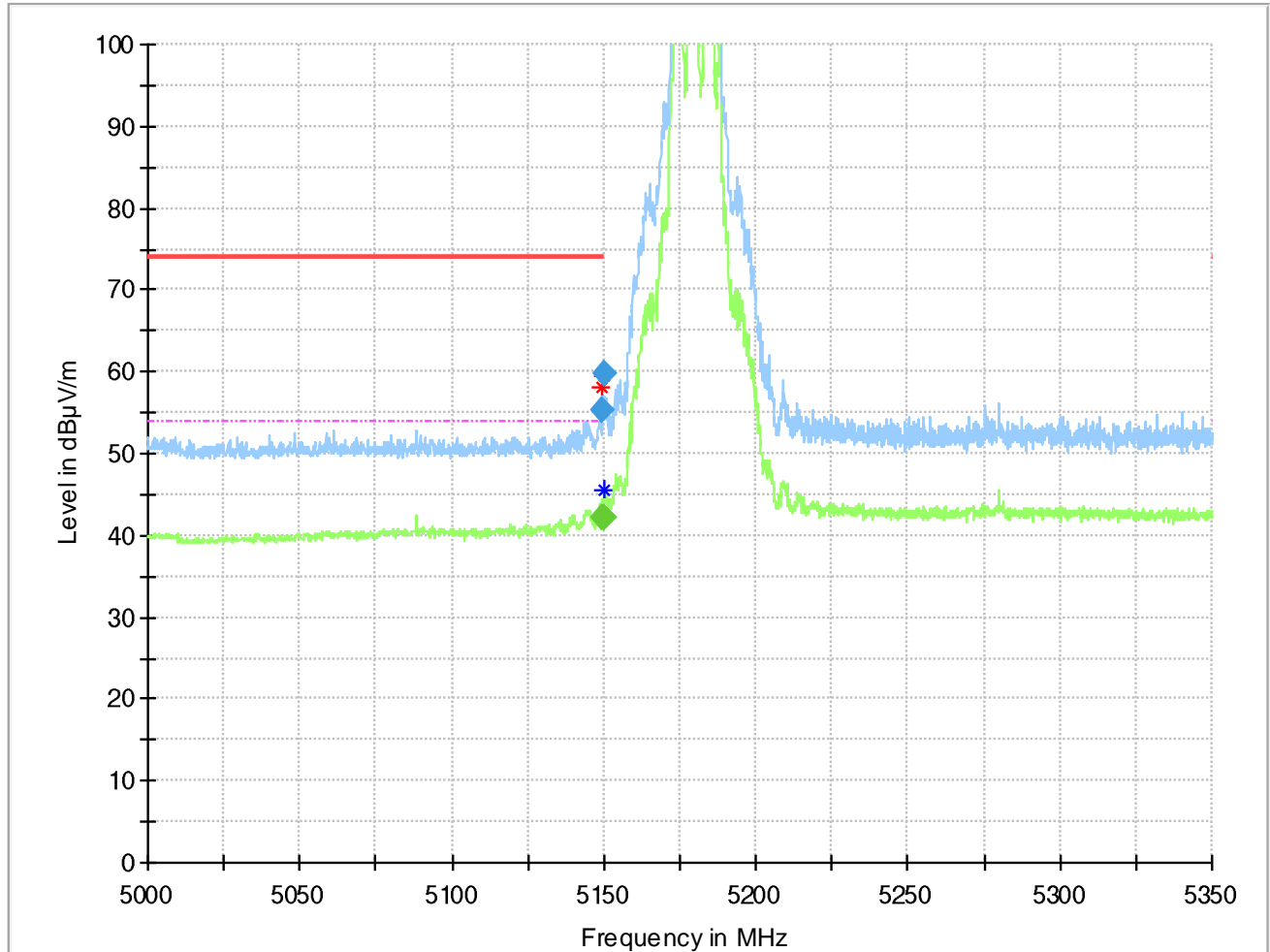

### Final Result

Frequency (MHz)	MaxPeak (dBµV/m)	CAverage (dBµV/m)	Limit (dBµV/m)	Margin (dB)	Meas. Time (ms)	Bandwidth (kHz)	Height (cm)	Pol	Azimuth (deg)	Elevation (deg)	Cor. (dB/m)
5149.675	---	42.3	54.0	11.73	1000.0	1000.00	150.	V	-10.0	75.0	13.5
5149.675	55.4	---	74.0	18.58	1000.0	1000.00	150.	V	-10.0	75.0	13.5
5150.000	---	42.3	---	---	1000.0	1000.00	150.	V	-1.0	97.0	13.5
5150.000	59.9	---	---	---	1000.0	1000.00	150.	V	-1.0	97.0	13.5

Radio Technology = WLAN a, Operating Frequency = low, Subband = U-NII-3  
(S03\_AC02)

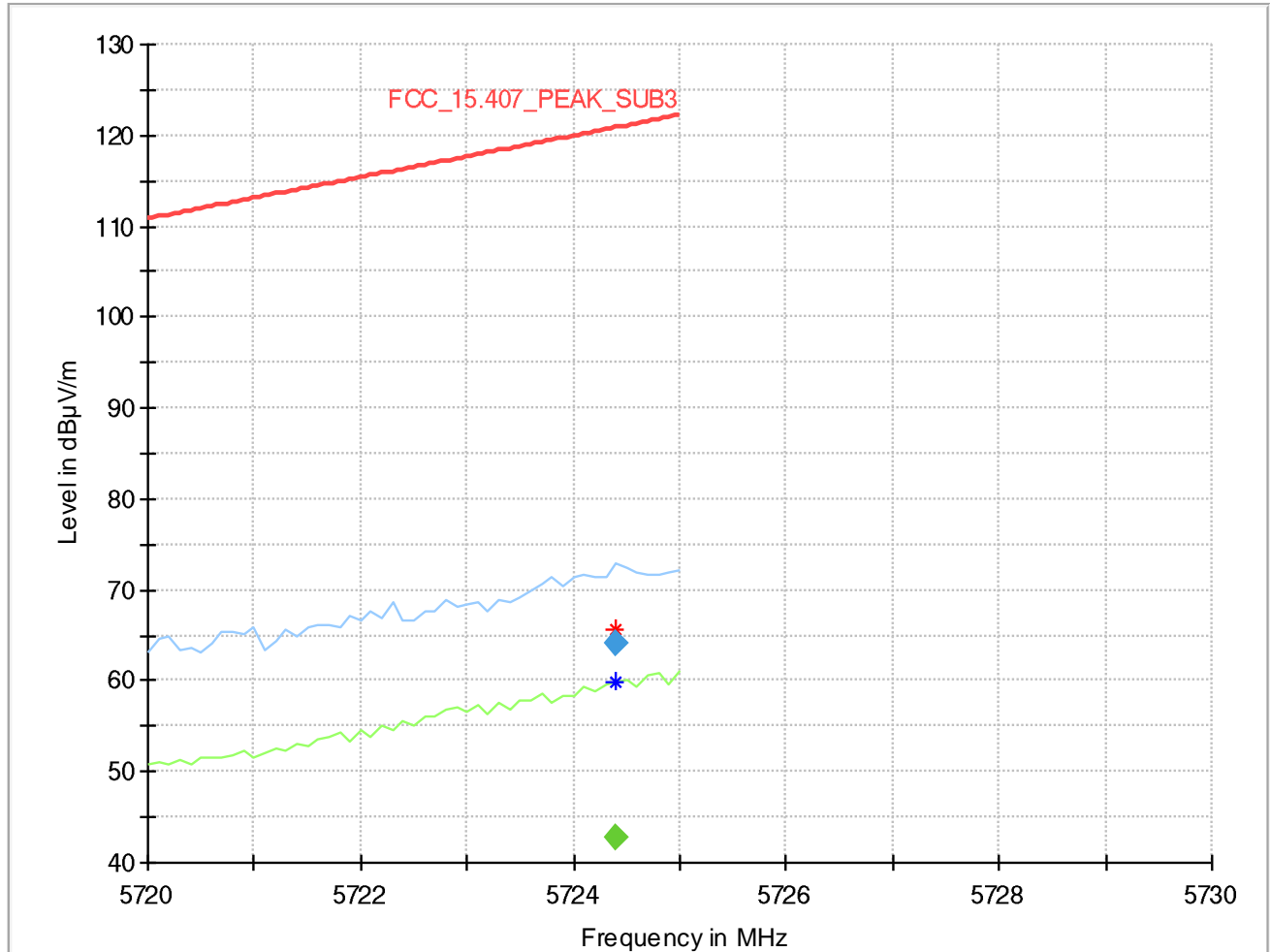

### Final Result

Frequency (MHz)	MaxPeak (dBµV/m)	CAverage (dBµV/m)	Limit (dBµV/m)	Marg in (dB)	Meas. Time (ms)	Bandwidth (kHz)	Height (cm)	Pol	Azimuth (deg)	Elevation (deg)	Cor. (dB/m)
5724.400	64.1	---	120.83	56.75	1000.0	1000.000	150.0	H	49.0	93.0	14.2
5724.400	---	42.7	---	---	1000.0	1000.000	150.0	H	49.0	93.0	14.2

Radio Technology = WLAN a, Operating Frequency = high, Subband = U-NII-3 (S03\_AC02)

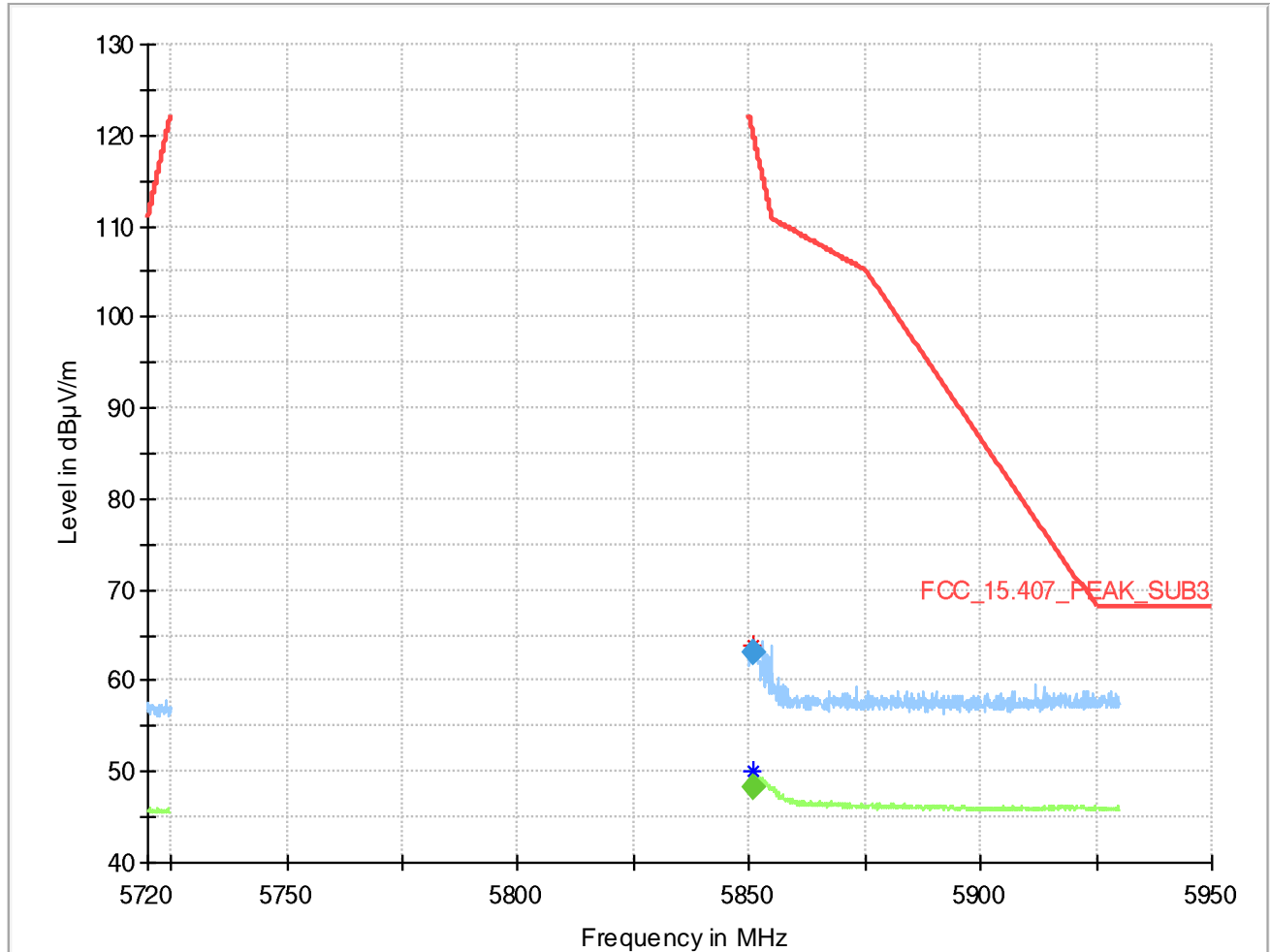

### Final Result

Frequency (MHz)	MaxPeak (dBµV/m)	CAverage (dBµV/m)	Limit (dBµV/m)	Marg in (dB)	Meas. Time (ms)	Bandwidth (kHz)	Height (cm)	Pol	Azimuth (deg)	Elevation (deg)	Corr. (dB/m)
5850.720	---	48.4	---	---	1000.0	1000.000	150.0	H	44.0	105.0	14.9
5850.720	63.2	---	120.56	57.36	1000.0	1000.000	150.0	H	44.0	105.0	14.9

Radio Technology = WLAN n 20 MHz, Operating Frequency = low, Subband = U-NII-1 (S03\_AC02)

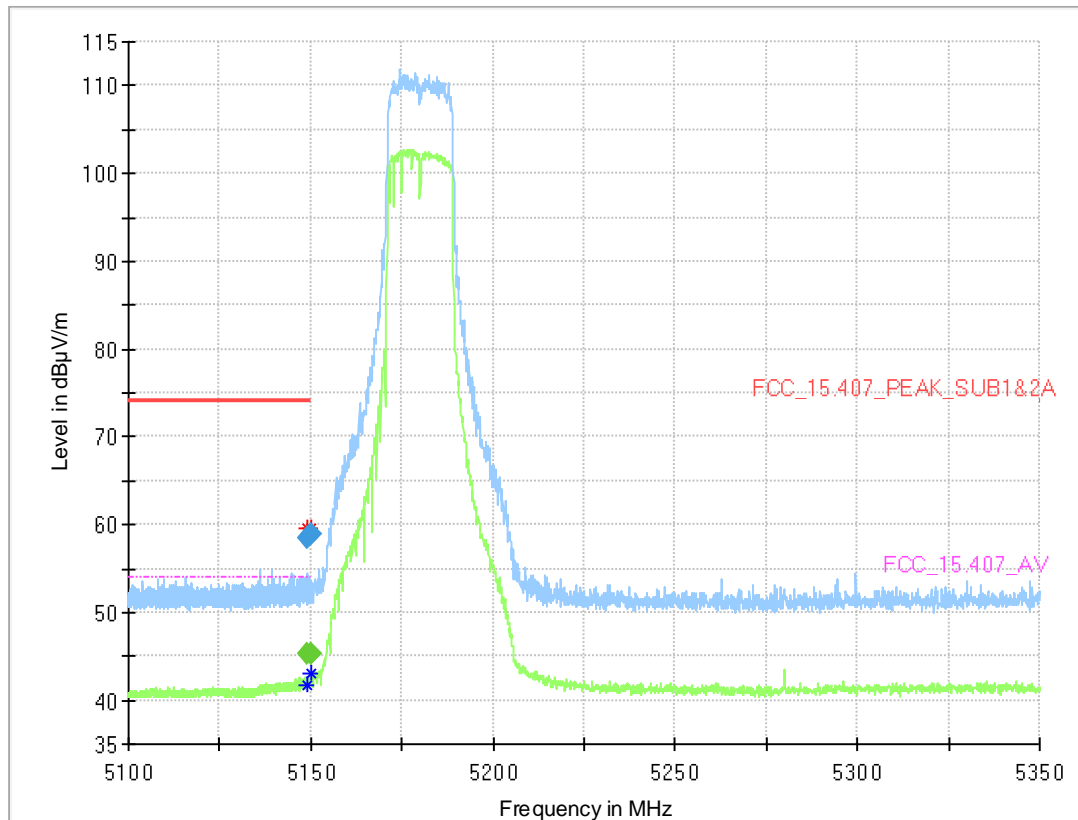

### Final Result

Frequency (MHz)	MaxPeak (dBµV/m)	CAverage (dBµV/m)	Limit (dBµV/m)	Margin (dB)	Meas. Time (ms)	Bandwidth (kHz)	Height (cm)	Pol	Azimuth (deg)	Elevation (deg)	Corr. (dB/m)
5148.813	---	45.3	54.00	8.72	1000.0	1000.000	150.0	H	2.0	86.0	13.5
5148.813	58.6	---	74.00	15.43	1000.0	1000.000	150.0	H	2.0	86.0	13.5
5150.000	---	45.3	54.00	8.74	1000.0	1000.000	150.0	H	-45.0	95.0	13.5
5150.000	58.8	---	74.00	15.15	1000.0	1000.000	150.0	H	-45.0	95.0	13.5

Radio Technology = WLAN n 20 MHz, Operating Frequency = low, Subband = U-NII-3  
(S03\_AC02)

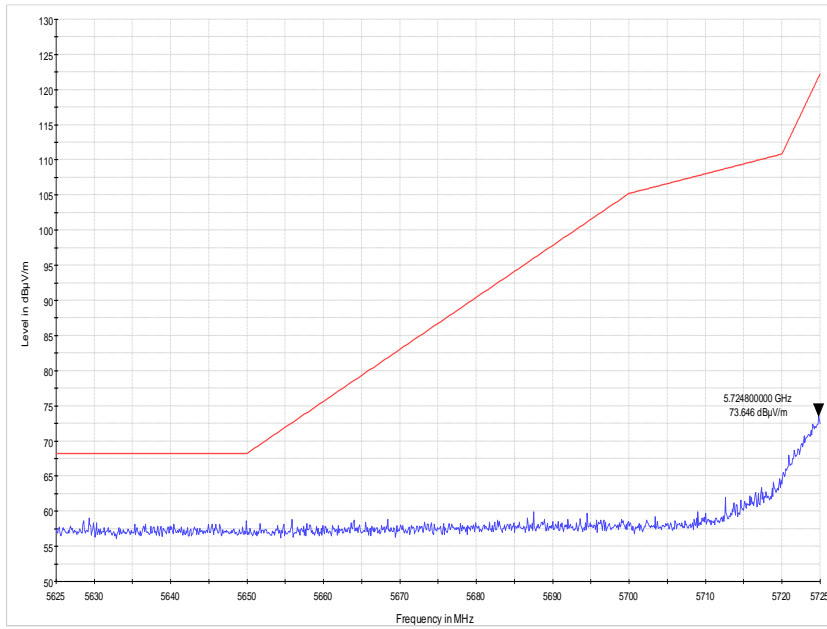

Radio Technology = WLAN n 40 MHz, Operating Frequency = low, Subband = U-NII-1 (S03\_AC02)

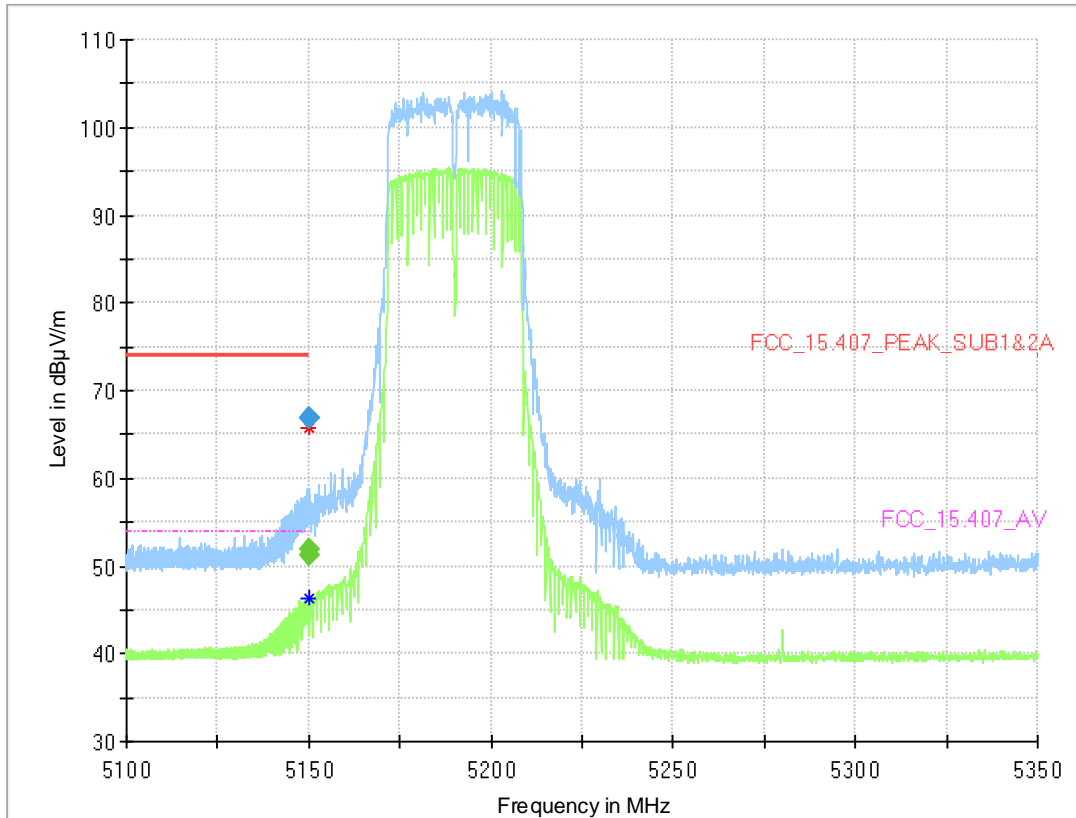

### Final Result

Frequency (MHz)	MaxPeak (dBµV/m)	CAverage (dBµV/m)	Limit (dBµV/m)	Margin (dB)	Meas. Time (ms)	Bandwidth (kHz)	Height (cm)	Pol	Azimuth (deg)	Elevation (deg)	Corr. (dB/m)
5149.900	---	51.2	54.00	2.81	1000.0	1000.000	150.0	V	4.0	78.0	13.5
5149.900	66.9	---	74.00	7.14	1000.0	1000.000	150.0	V	4.0	78.0	13.5
5149.913	---	51.8	54.00	2.15	1000.0	1000.000	150.0	V	-2.0	82.0	13.5
5149.913	66.9	---	74.00	7.14	1000.0	1000.000	150.0	V	-2.0	82.0	13.5

Radio Technology = WLAN n 40 MHz, Operating Frequency = low, Subband = U-NII-3 (S03\_AC02)

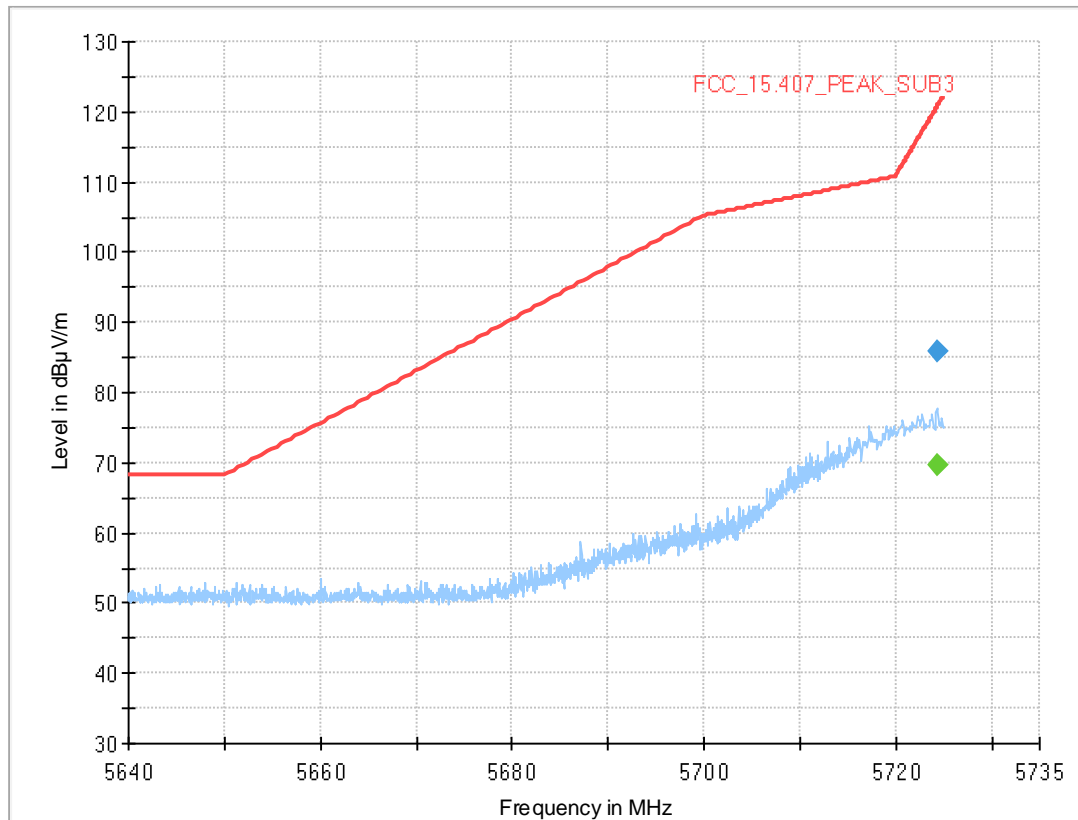

### Final Result

Frequency (MHz)	MaxPeak (dBµV/m)	CAverage (dBµV/m)	Limit (dBµV/m)	Margin (dB)	Meas. Time (ms)	Bandwidth (kHz)	Height (cm)	Pol	Azimuth (deg)	Elevation (deg)	Corr. (dB/m)
5724.300	---	69.7	---	---	1000.0	1000.000	150.0	H	11.0	102.0	14.2
5724.300	85.9	---	120.6	34.71	1000.0	1000.000	150.0	H	11.0	102.0	14.2



Radio Technology = WLAN ac 20 MHz, Operating Frequency = low, Subband = U-NII-1  
(S03\_AC02)

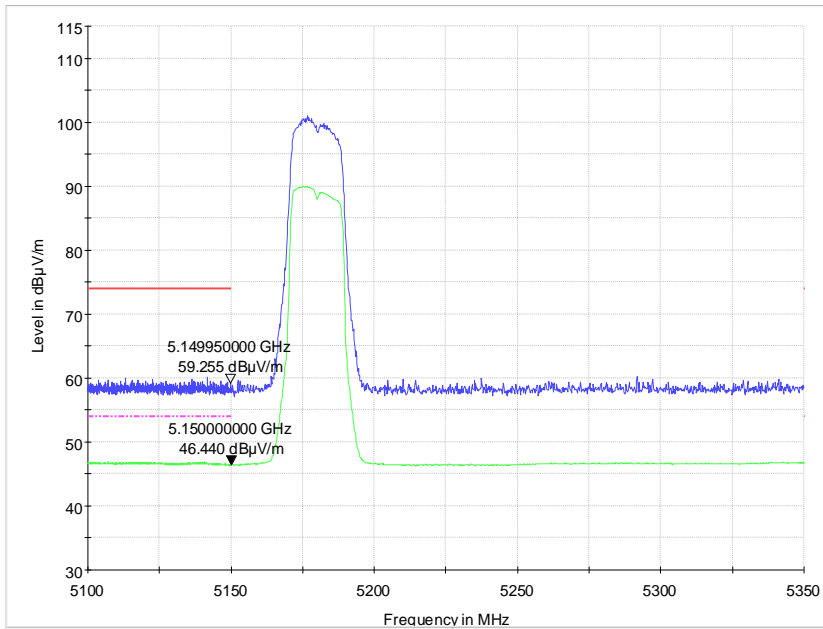

Radio Technology = WLAN ac 20 MHz, Operating Frequency = low, Subband = U-NII-3  
(S03\_AC02)

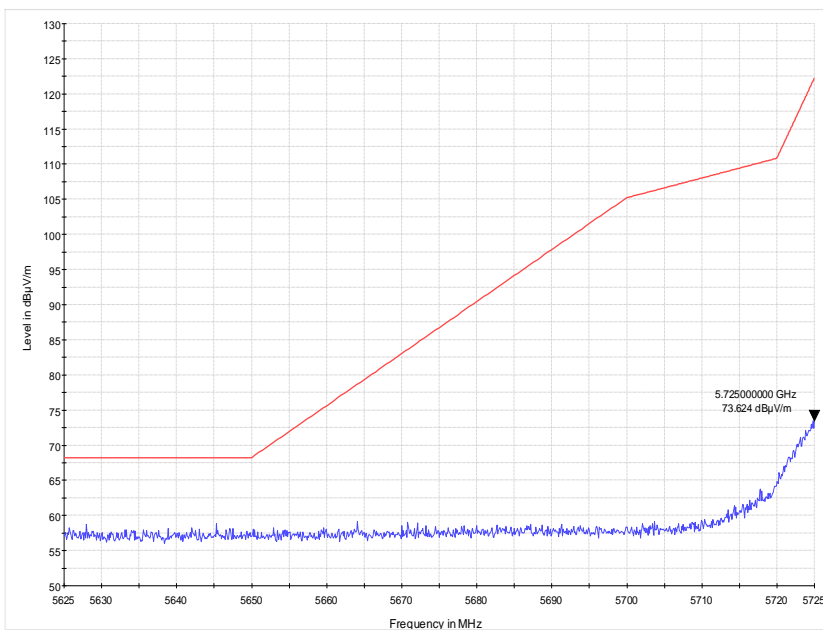

Radio Technology = WLAN ac 40 MHz, Operating Frequency = low, Subband = U-NII-1 (S03\_AC02)

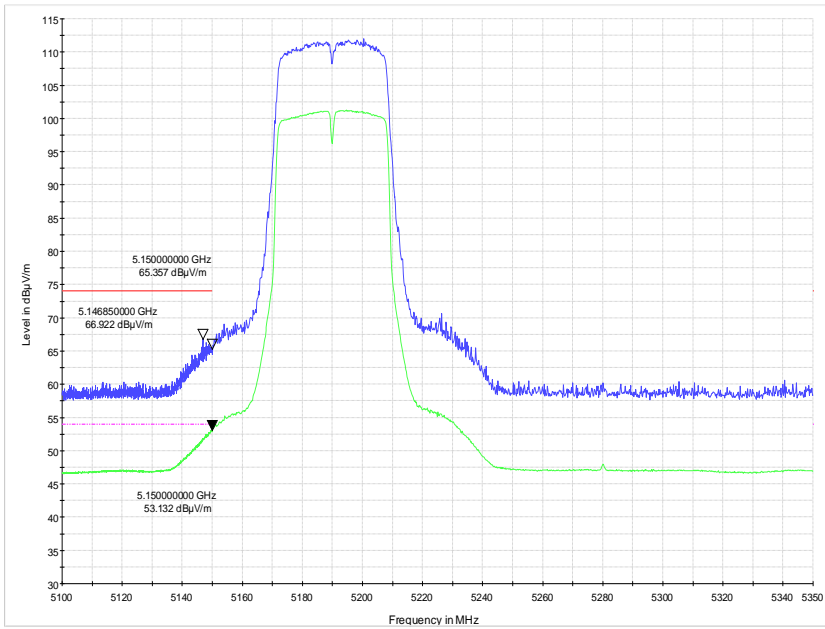

Radio Technology = WLAN ac 40 MHz, Operating Frequency = low, Subband = U-NII-3 (S03\_AC02)

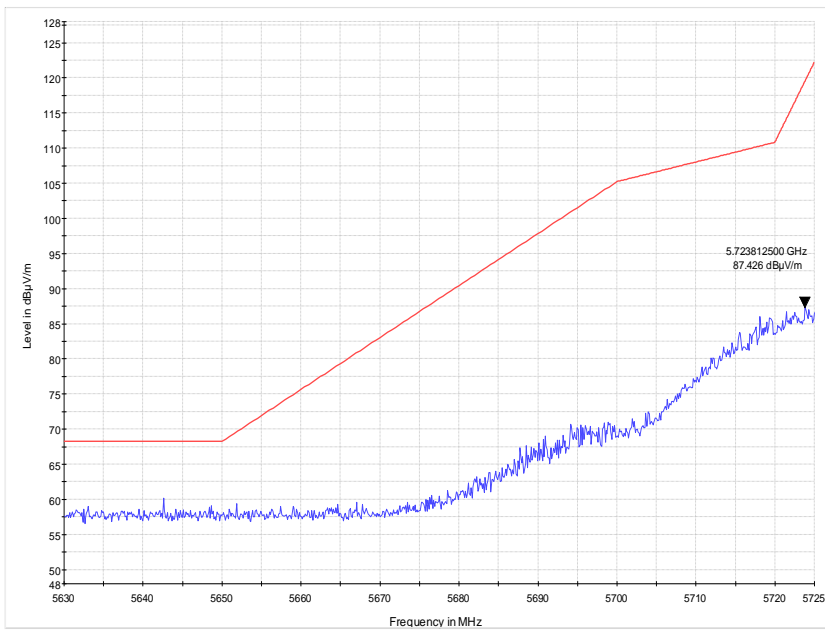

Radio Technology = WLAN ac 80 MHz, Operating Frequency = mid, Subband = U-NII-1 (S03\_AC02)

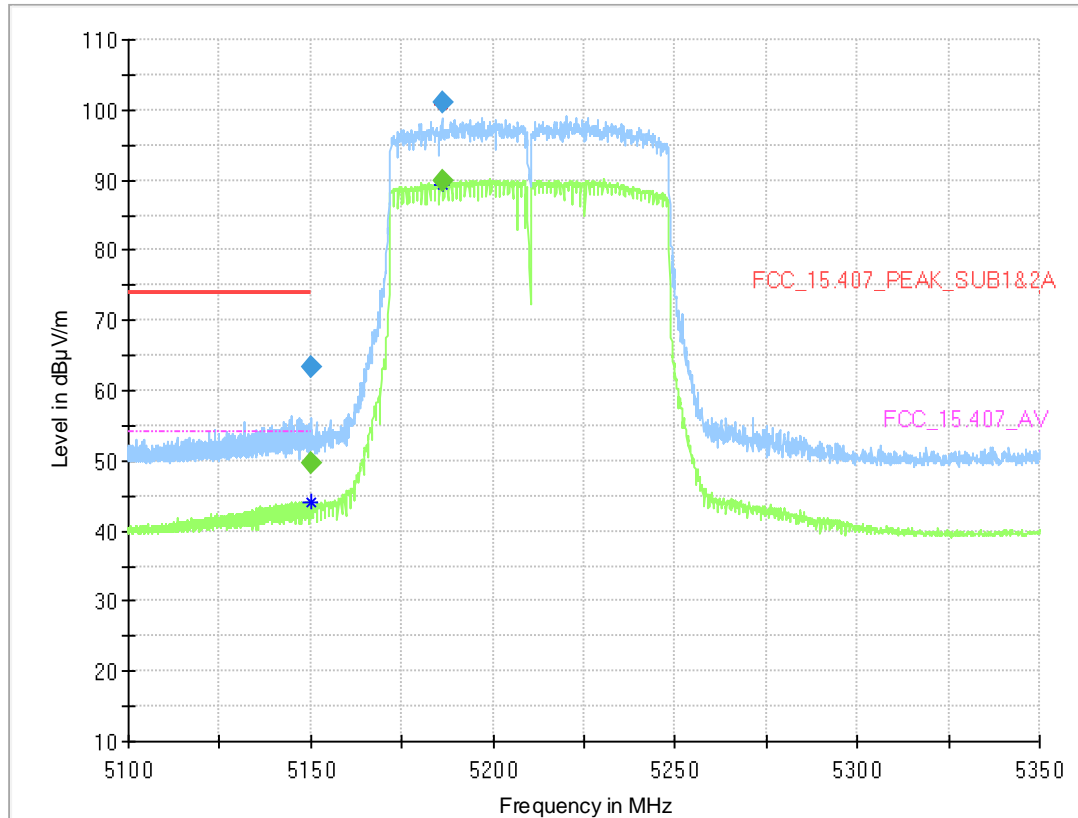

### Final\_Result

Frequency (MHz)	MaxPeak (dBµV/m)	CAverage (dBµV/m)	Limit (dBµV/m)	Margin (dB)	Meas. Time (ms)	Bandwidth (kHz)	Height (cm)	Pol	Azimuth (deg)	Elevation (deg)	Corr. (dB/m)
5150.000	---	49.7	54.00	4.35	1000.0	1000.000	150.0	H	-34.0	105.0	13.5
5150.000	63.4	---	74.00	10.57	1000.0	1000.000	150.0	H	-34.0	105.0	13.5
5186.000	---	90.0	---	---	1000.0	1000.000	150.0	H	-56.0	78.0	13.6
5186.000	100.9	---	---	---	1000.0	1000.000	150.0	H	-56.0	78.0	13.6

Radio Technology = WLAN n 20 MHz MIMO, Operating Frequency = low, Subband = U-NII-1 (S03\_AC02)

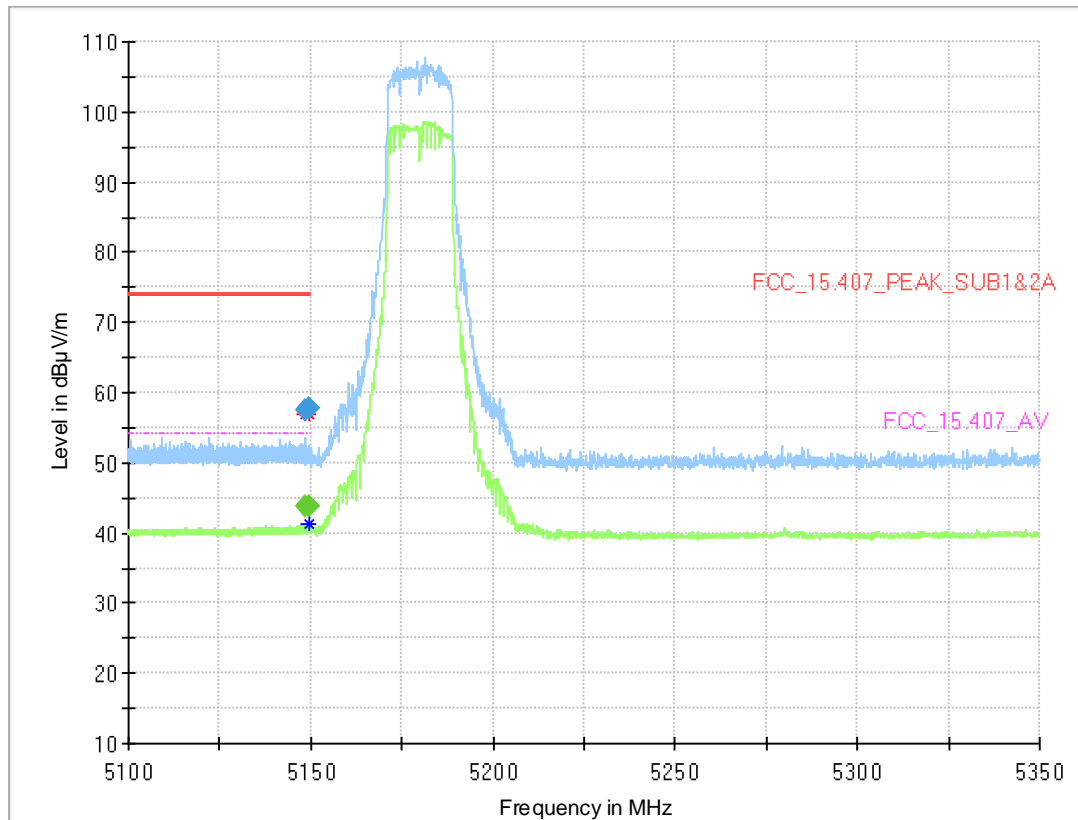

### Final Result

Frequency (MHz)	MaxPeak (dBµV/m)	CAverage (dBµV/m)	Limit (dBµV/m)	Margin (dB)	Meas. Time (ms)	Bandwidth (kHz)	Height (cm)	Pol	Azimuth (deg)	Elevation (deg)	Corr. (dB/m)
5148.350	---	43.9	54.00	10.09	1000.0	1000.000	150.0	V	8.0	82.0	13.5
5148.350	57.6	---	74.00	16.43	1000.0	1000.000	150.0	V	8.0	82.0	13.5
5149.825	---	43.7	54.00	10.29	1000.0	1000.000	150.0	V	-7.0	91.0	13.5
5149.825	57.8	---	74.00	16.25	1000.0	1000.000	150.0	V	-7.0	91.0	13.5

Radio Technology = WLAN n 20 MHz MIMO, Operating Frequency = low, Subband = U-NII-3 (S03\_AC02)

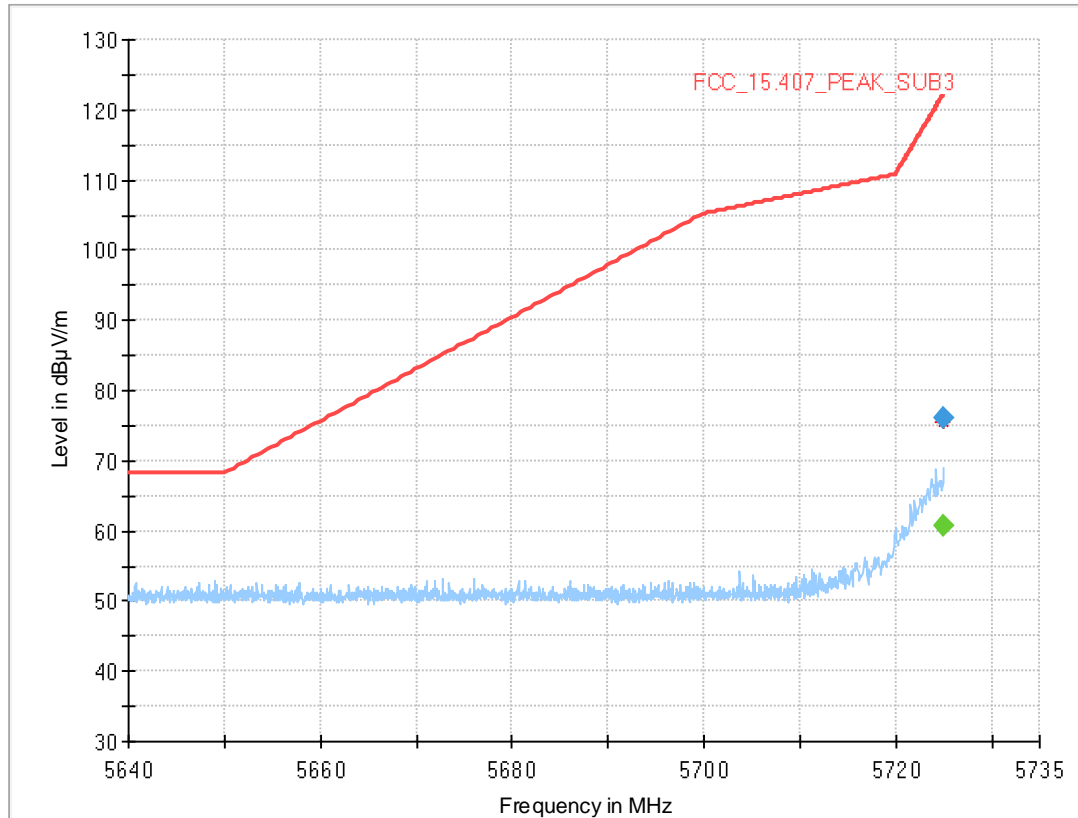

**Final Result**

Frequency (MHz)	MaxPeak (dBµV/m)	CAverage (dBµV/m)	Limit (dBµV/m)	Margin (dB)	Meas. Time (ms)	Bandwidth (kHz)	Height (cm)	Pol	Azimuth (deg)	Elevation (deg)	Corr. (dB/m)
5725.000	---	60.6	---	---	1000.0	1000.000	150.0	V	-11.0	79.0	14.2
5725.000	76.0	---	122.2	46.22	1000.0	1000.000	150.0	V	-11.0	79.0	14.2

Radio Technology = WLAN n 40 MHz MIMO, Operating Frequency = low, Subband = U-NII-1 (S03\_AC02)

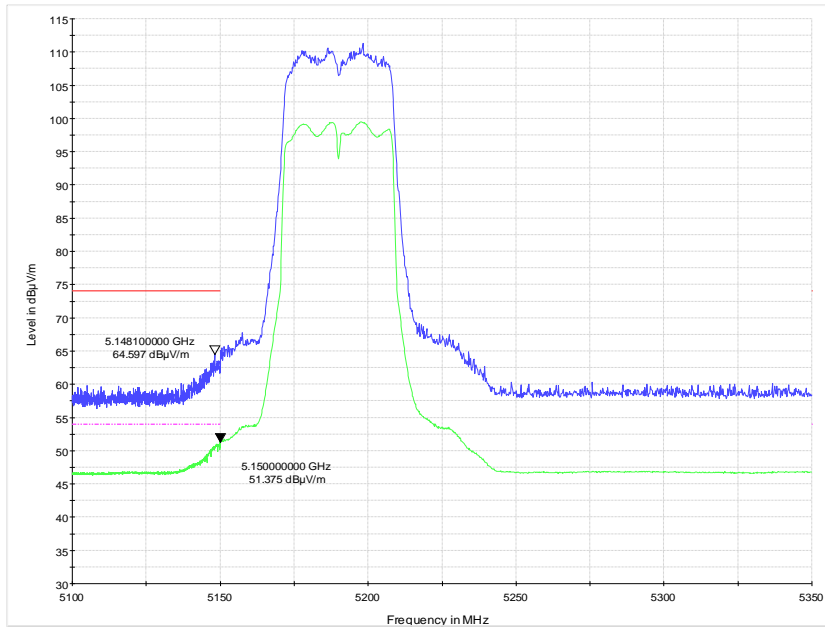

Radio Technology = WLAN n 40 MHz MIMO, Operating Frequency = low, Subband = U-NII-3 (S03\_AC02)

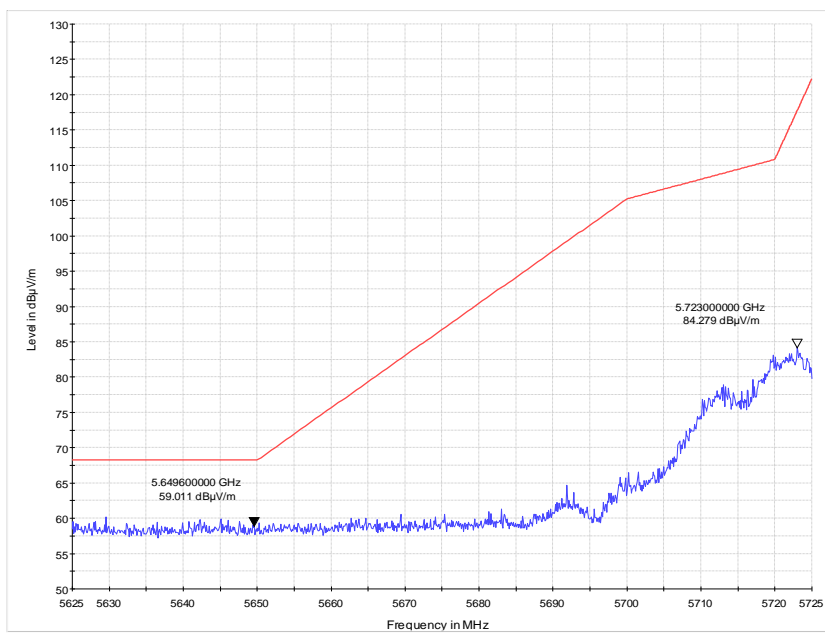

Radio Technology = WLAN ac 20 MHz MIMO, Operating Frequency = low, Subband = U-NII-1 (S03\_AC02)

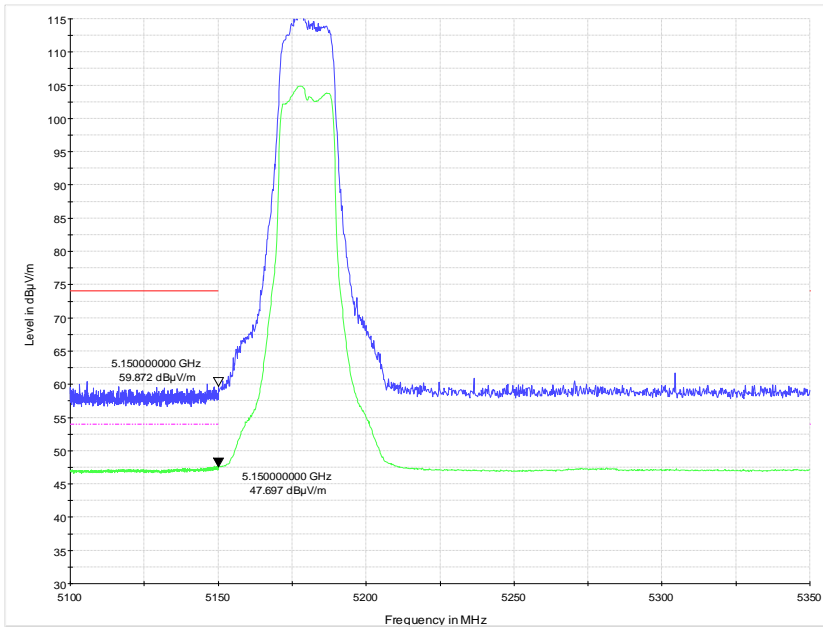

Radio Technology = WLAN ac 20 MHz MIMO, Operating Frequency = low, Subband = U-NII-3 (S03\_AC02)

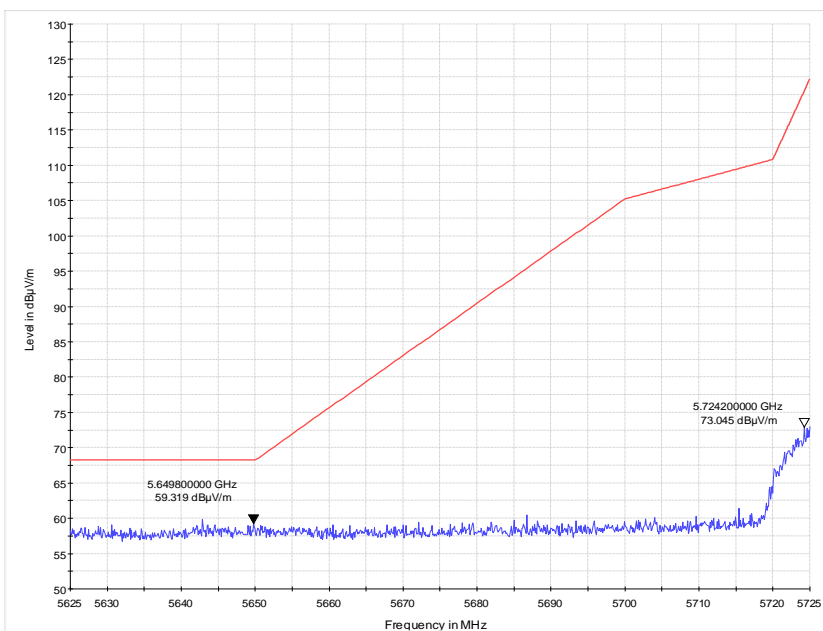

Radio Technology = WLAN ac 40 MHz MIMO, Operating Frequency = low, Subband = U-NII-1  
(S03\_AC02)

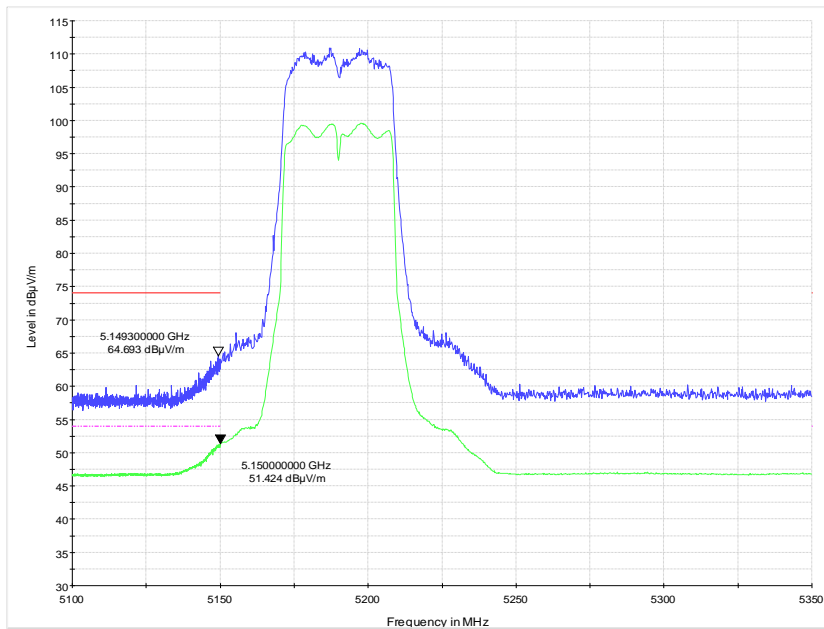

Radio Technology = WLAN ac 40 MHz MIMO, Operating Frequency = low, Subband = U-NII-3  
(S03\_AC02)

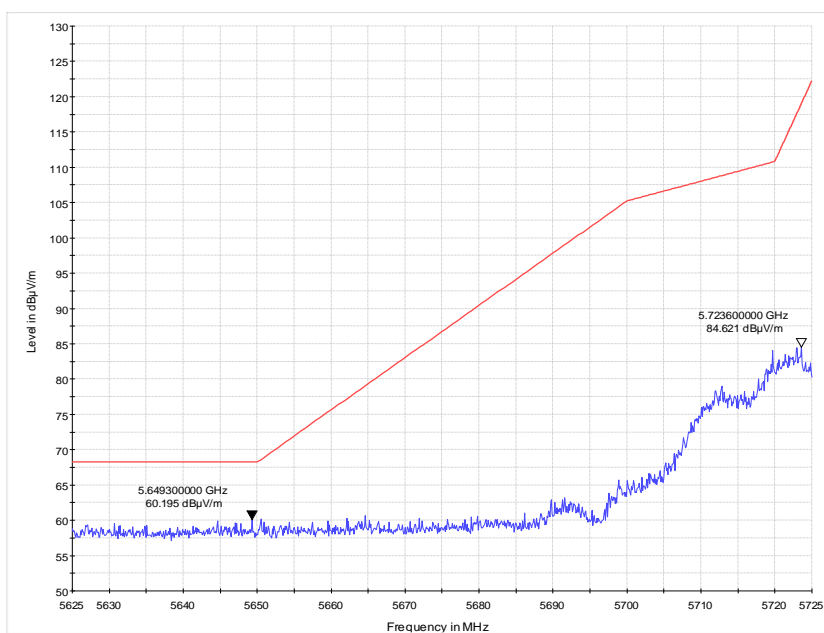



Radio Technology = WLAN ac 80 MHz MIMO, Operating Frequency = mid, Subband = U-NII-1 (S03\_AC02)

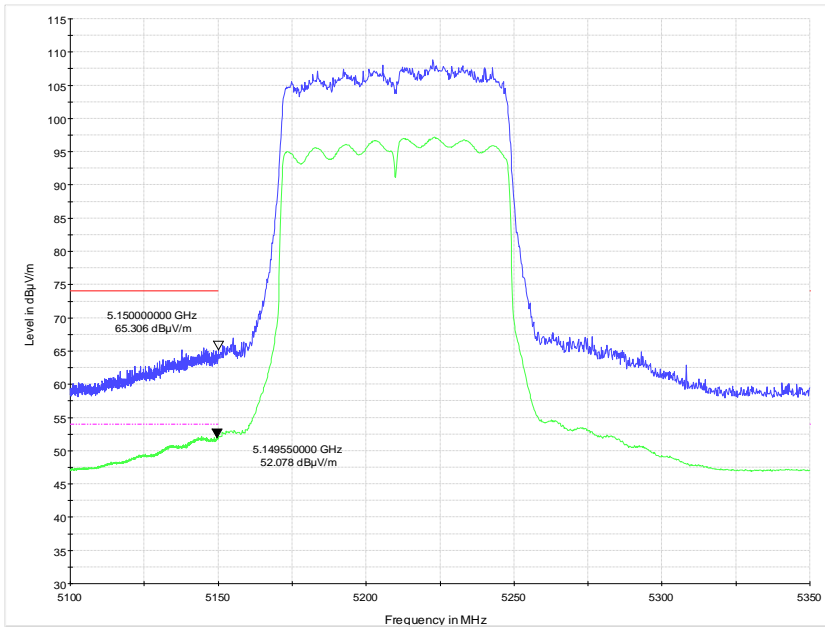

Radio Technology = WLAN ac 80 MHz MIMO, Operating Frequency = mid, Subband = U-NII-3 (S03\_AC02)

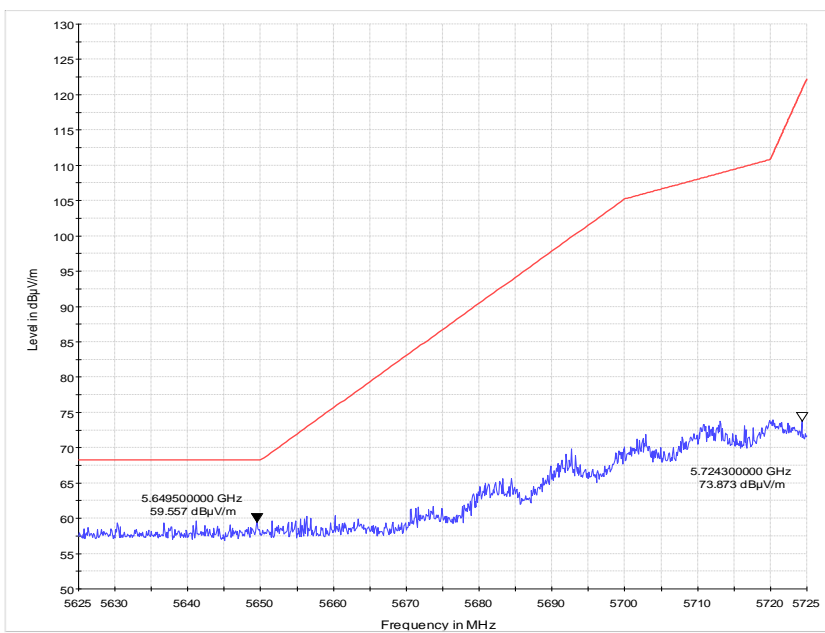

Radio Technology = WLAN ax 20 MHz, Operating Frequency = low, Subband = U-NII-1 (S03\_AC02)

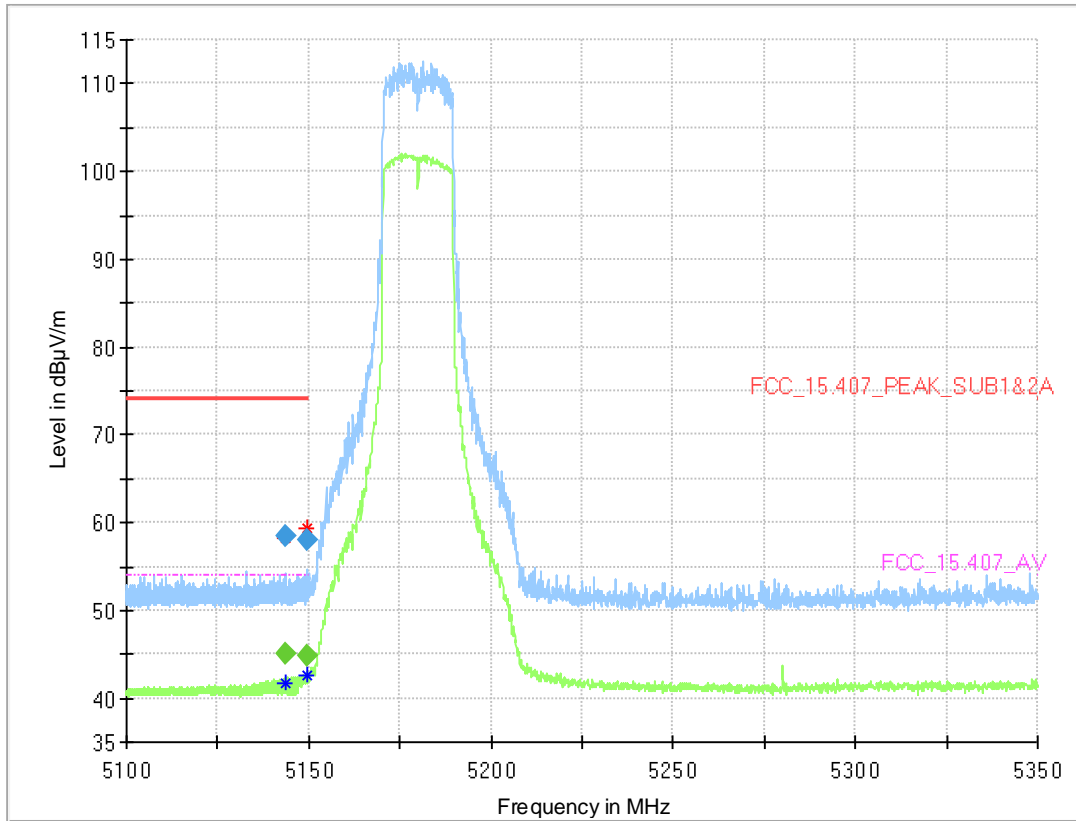

### Final Result

Frequency (MHz)	MaxPeak (dBµV/m)	CAverage (dBµV/m)	Limit (dBµV/m)	Margin (dB)	Meas. Time (ms)	Bandwidth (kHz)	Height (cm)	Pol	Azimuth (deg)	Elevation (deg)	Corr. (dB/m)
5143.500	---	45.0	54.00	9.02	1000.0	1000.000	150.0	H	11.0	96.0	13.7
5143.500	58.6	---	74.00	15.44	1000.0	1000.000	150.0	H	11.0	96.0	13.7
5149.500	---	44.8	54.00	9.16	1000.0	1000.000	150.0	H	-47.0	78.0	13.5
5149.500	58.1	---	74.00	15.91	1000.0	1000.000	150.0	H	-47.0	78.0	13.5

Radio Technology = WLAN ax 20 MHz, Operating Frequency = low, Subband = U-NII-3 (S03\_AC02)

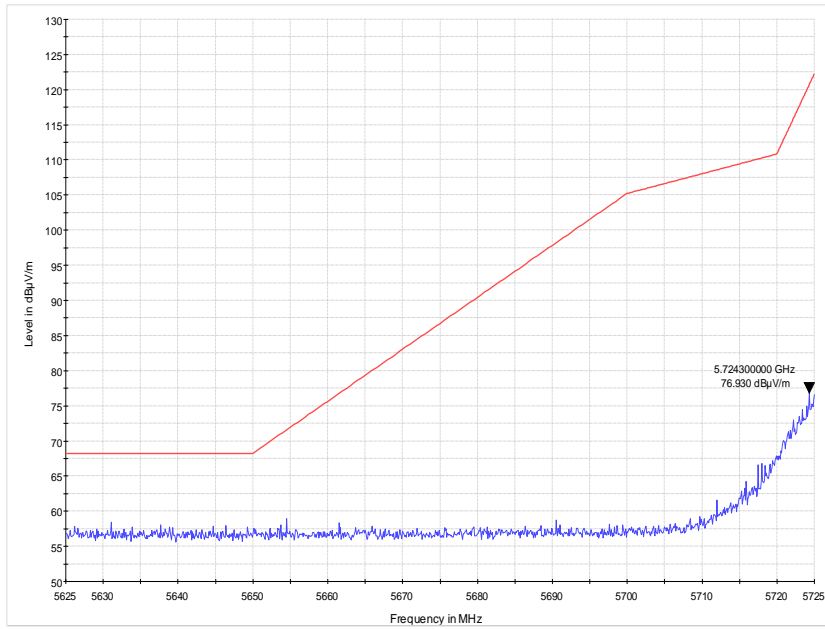

Radio Technology = WLAN ax 40 MHz, Operating Frequency = low, Subband = U-NII-1 (S03\_AC02)

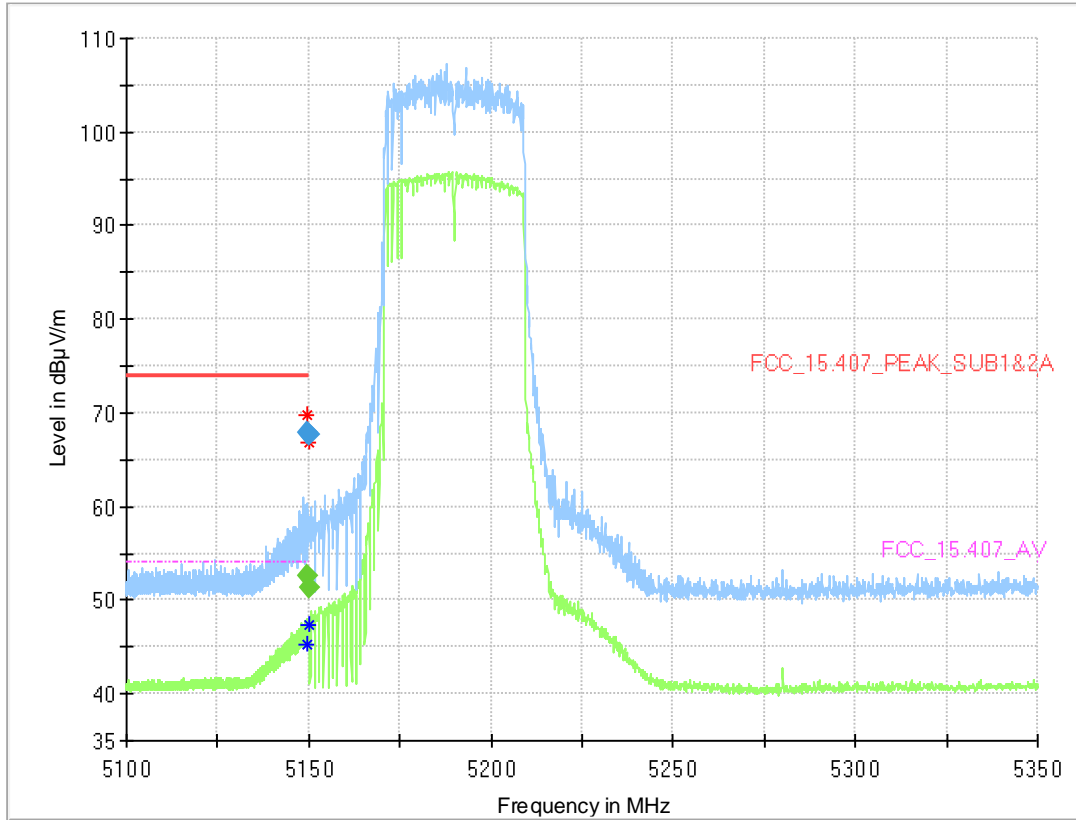

### Final Result

Frequency (MHz)	MaxPeak (dBµV/m)	CAverage (dBµV/m)	Limit (dBµV/m)	Margin (dB)	Meas. Time (ms)	Bandwidth (kHz)	Height (cm)	Pol	Azimuth (deg)	Elevation (deg)	Corr. (dB/m)
5149.488	67.9	---	74.00	6.07	1000.0	1000.000	150.0	H	12.0	97.0	13.5
5149.488	---	52.6	54.00	1.43	1000.0	1000.000	150.0	H	12.0	97.0	13.5
5149.975	67.7	---	74.00	6.28	1000.0	1000.000	150.0	H	-34.0	85.0	13.5
5149.975	---	51.3	54.00	2.68	1000.0	1000.000	150.0	H	-34.0	85.0	13.5

Radio Technology = WLAN ax 80 MHz, Operating Frequency = mid, Subband = U-NII-1 (S03\_AC02)

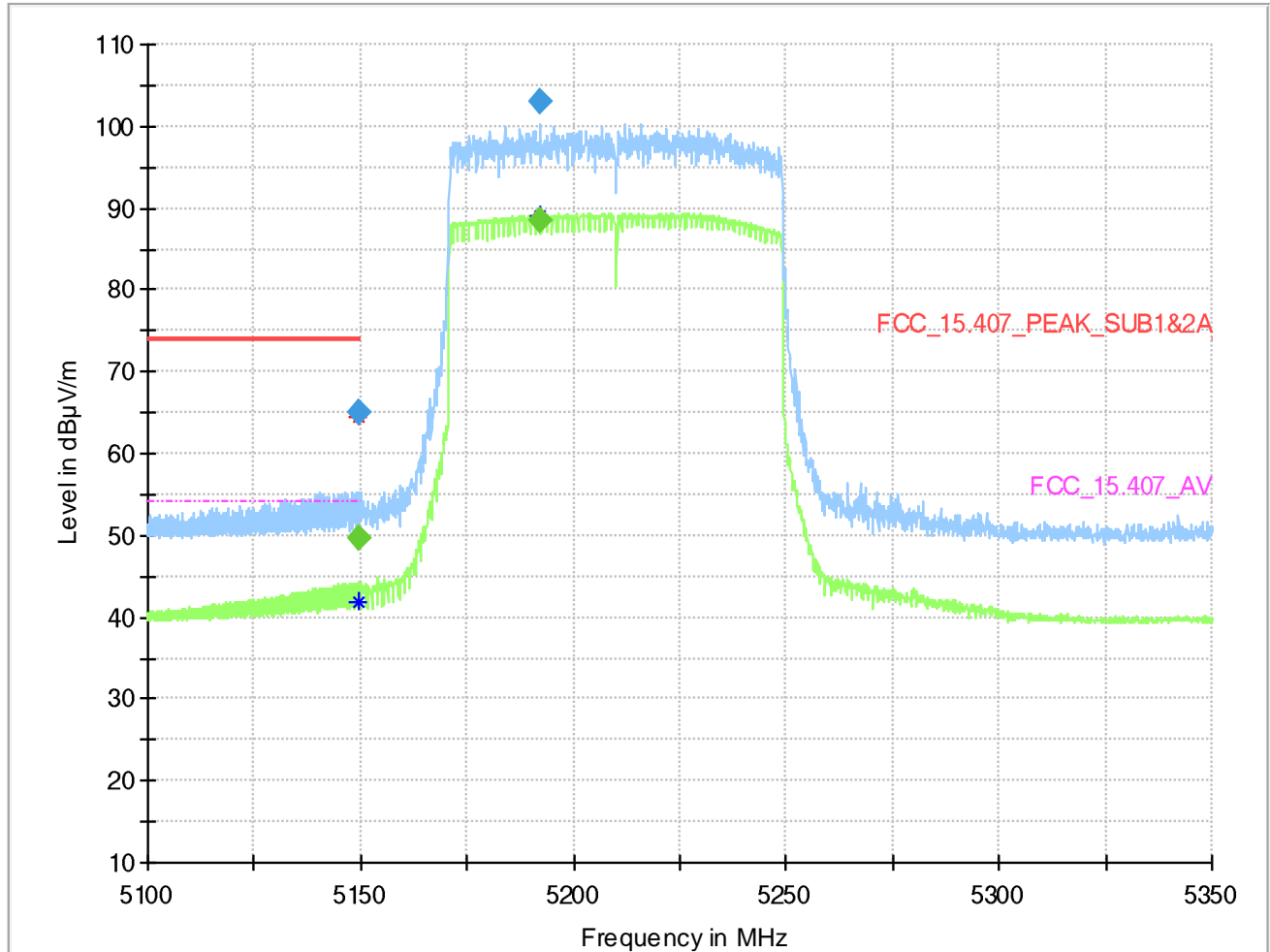

### Final Result

Frequency (MHz)	MaxPeak (dBµV/m)	CAverage (dBµV/m)	Limit (dBµV/m)	Marg in (dB)	Meas. Time (ms)	Bandwidth (kHz)	Height (cm)	Pol	Azimuth (deg)	Elevation (deg)	Cor. (dB/m)
5149.725	---	49.8	54.0	4.24	1000.0	1000.00	150.	H	11.0	95.0	13.5
5149.725	64.9	---	74.0	9.12	1000.0	1000.00	150.	H	11.0	95.0	13.5
5192.100	---	88.4	---	---	1000.0	1000.00	150.	H	-56.0	105.0	13.6
5192.100	103.0	---	---	---	1000.0	1000.00	150.	H	-56.0	105.0	13.6

Radio Technology = WLAN ax 20 MHz MIMO, Operating Frequency = low, Subband = U-NII-1 (S03\_AC02)

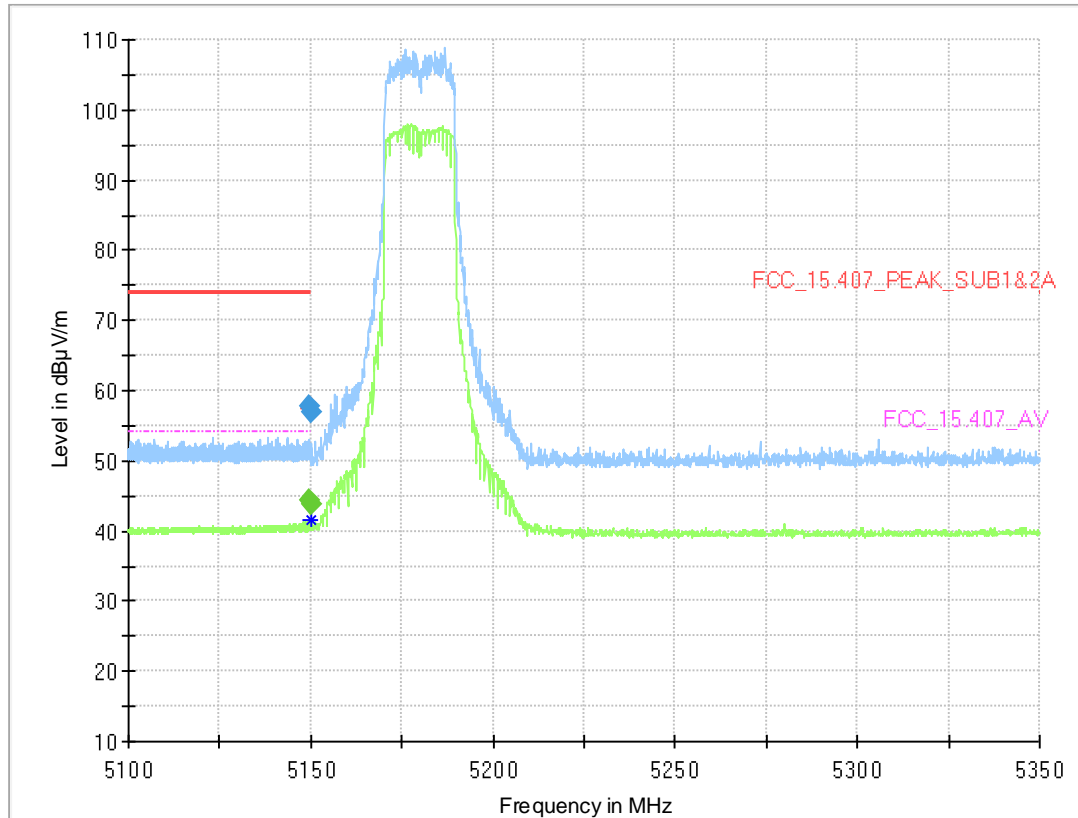

### Final Result

Frequency (MHz)	MaxPeak (dBµV/m)	CAverage (dBµV/m)	Limit (dBµV/m)	Margin (dB)	Meas. Time (ms)	Bandwidth (kHz)	Height (cm)	Pol	Azimuth (deg)	Elevation (deg)	Corr. (dB/m)
5149.625	---	44.3	54.00	9.71	1000.0	1000.000	150.0	V	2.0	78.0	13.5
5149.625	57.7	---	74.00	16.28	1000.0	1000.000	150.0	V	2.0	78.0	13.5
5149.950	---	43.8	54.00	10.21	1000.0	1000.000	150.0	V	-7.0	88.0	13.5
5149.950	56.9	---	74.00	17.12	1000.0	1000.000	150.0	V	-7.0	88.0	13.5

Radio Technology = WLAN ax 20 MHz MIMO, Operating Frequency = low, Subband = U-NII-3 (S03\_AC02)

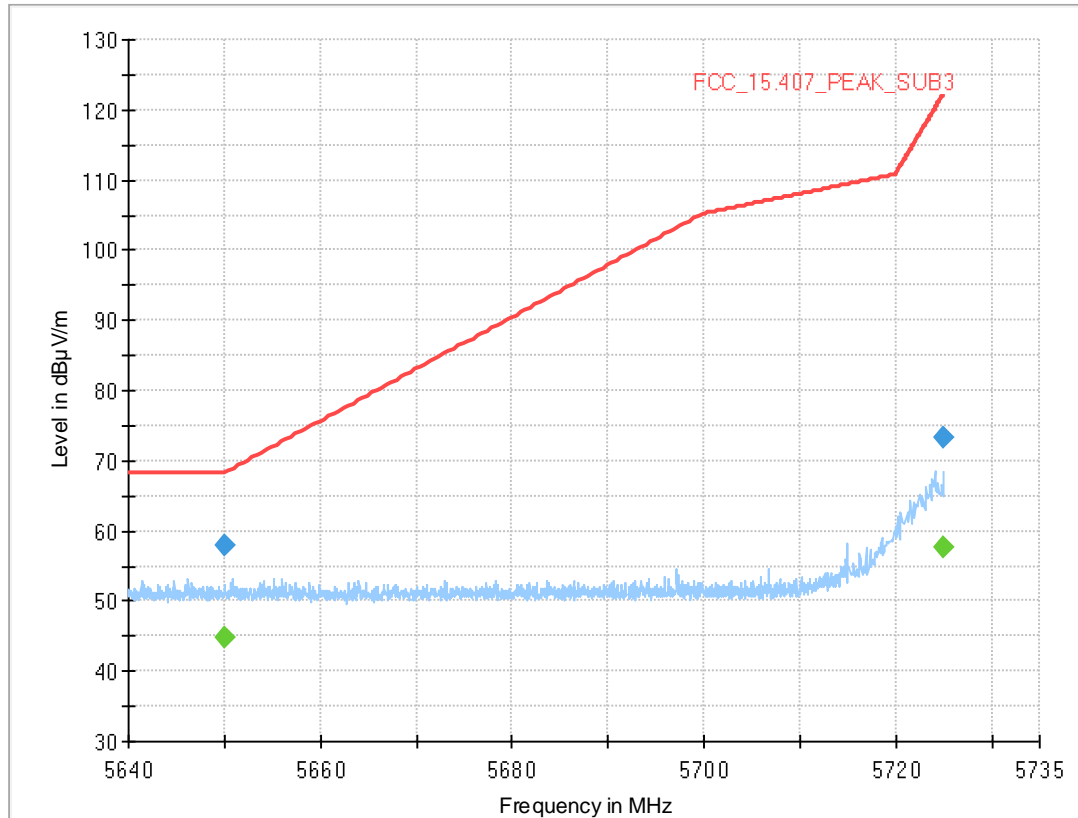

### Final Result

Frequency (MHz)	MaxPeak (dBµV/m)	CAverage (dBµV/m)	Limit (dBµV/m)	Margin (dB)	Meas. Time (ms)	Bandwidth (kHz)	Height (cm)	Pol	Azimuth (deg)	Elevation (deg)	Corr. (dB/m)
5649.975	---	44.8	---	---	1000.0	1000.000	150.0	V	2.0	82.0	14.1
5649.975	57.9	---	68.20	10.34	1000.0	1000.000	150.0	V	2.0	82.0	14.1
5725.000	---	57.7	---	---	1000.0	1000.000	150.0	H	34.0	96.0	14.2
5725.000	73.2	---	122.2	49.04	1000.0	1000.000	150.0	H	34.0	96.0	14.2

Radio Technology = WLAN ax 40 MHz MIMO, Operating Frequency = low, Subband = U-NII-1 (S03\_AC02)

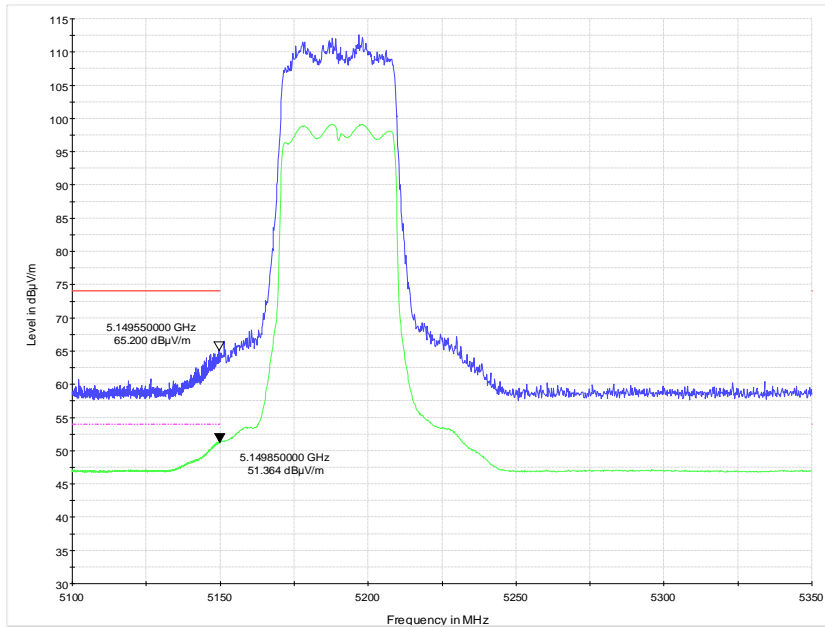

Radio Technology = WLAN ax 80 MHz MIMO, Operating Frequency = mid, Subband = U-NII-1 (S03\_AC02)

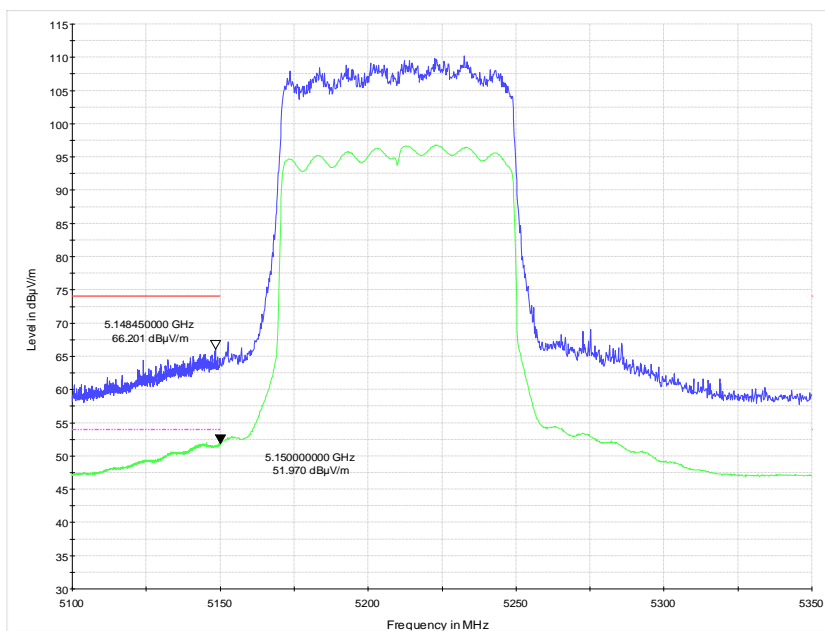



Radio Technology = WLAN ax 80 MHz MIMO, Operating Frequency = mid, Subband = U-NII-3 (S03\_AC02)

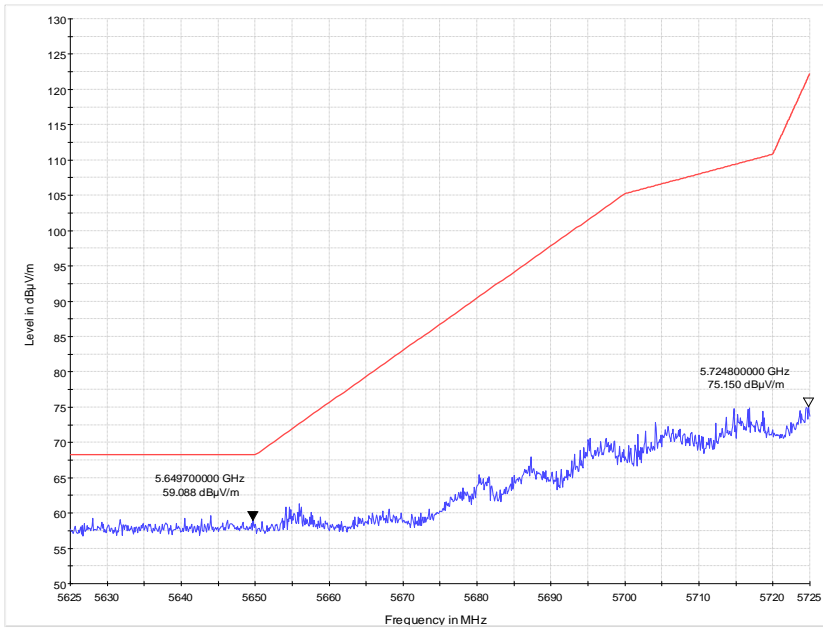

Radio Technology = WLAN a MIMO, Operating Frequency = low, Subband = U-NII-1 (S05\_AD02)

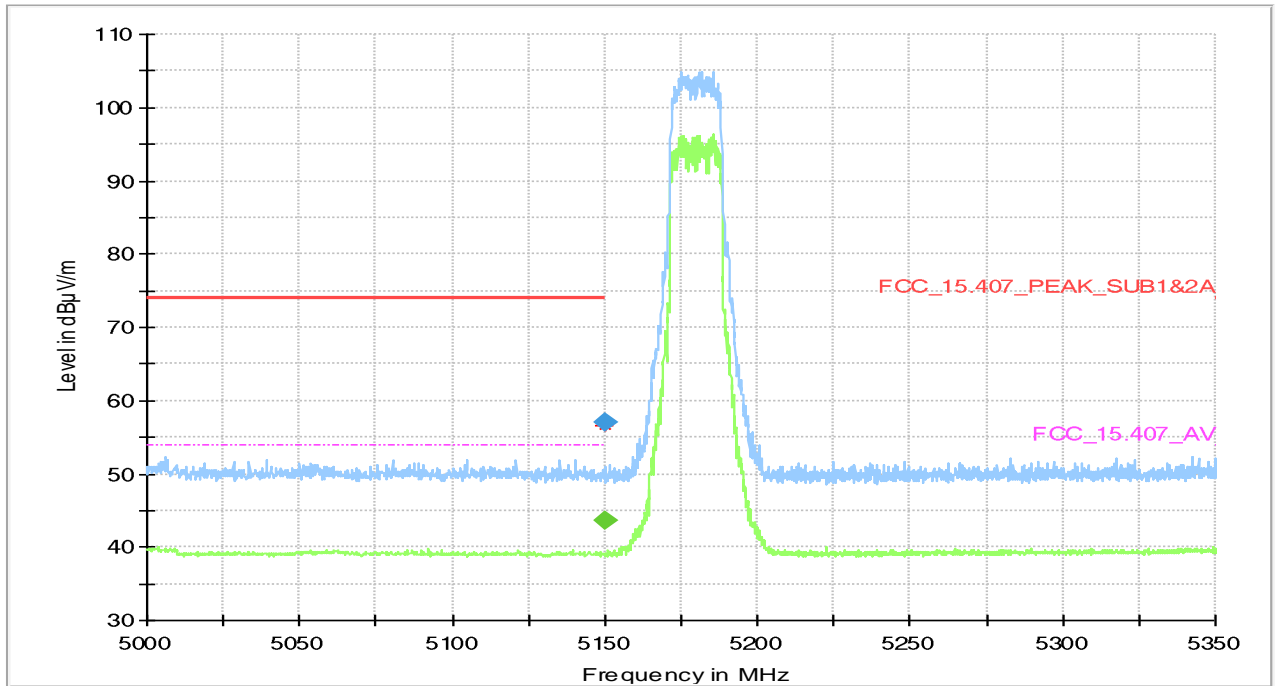

### Final Result

Frequency (MHz)	MaxPeak (dBµV/m)	CAverage (dBµV/m)	Limit (dBµV/m)	Margin (dB)	Meas. Time (ms)	Bandwidth (kHz)	Height (cm)	Pol	Azimuth (deg)	Elevation (deg)	Corr. (dB/m)
5150.000	57.0	---	74.0	17.03	1000.0	1000.00	150.	V	4.0	92.0	13.5
5150.000	---	43.6	54.0	10.43	1000.0	1000.00	150.	V	4.0	92.0	13.5

Radio Technology = WLAN a MIMO, Operating Frequency = low, Subband = U-NII-3 (S05\_AD02)

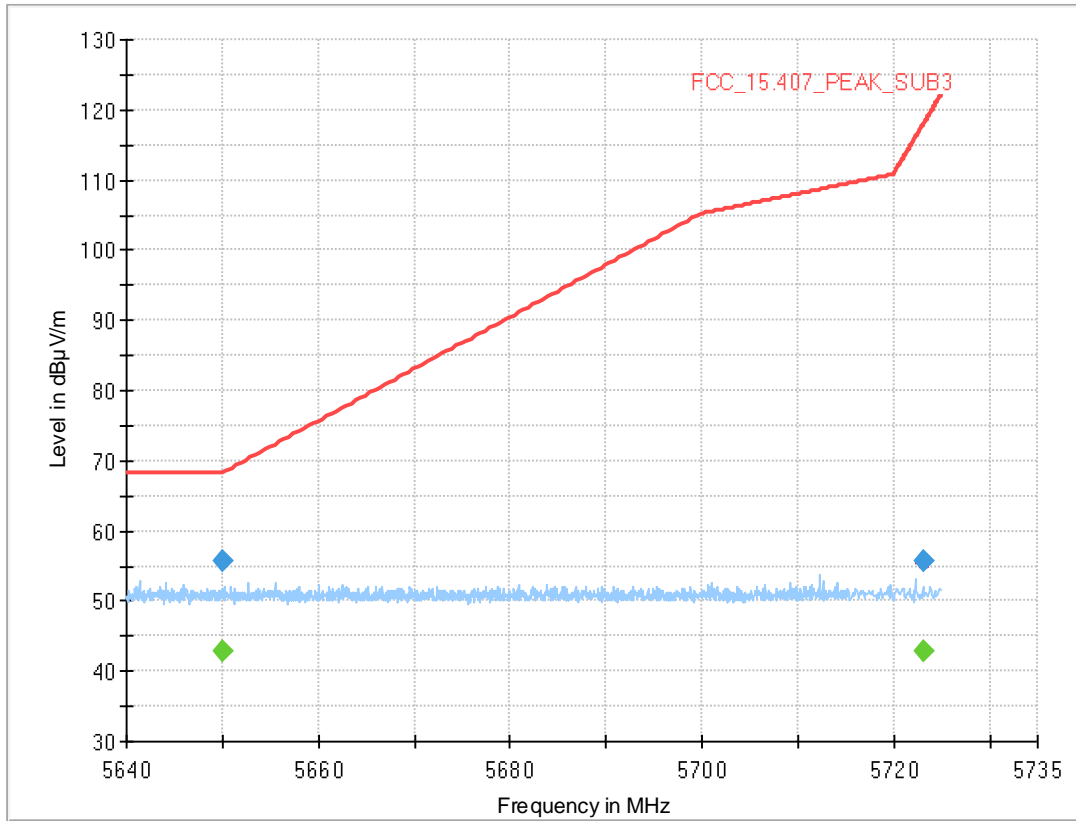

**Final Result**

Frequency (MHz)	MaxPeak (dBµV/m)	CAverage (dBµV/m)	Limit (dBµV/m)	Margin (dB)	Meas. Time (ms)	Bandwidth (kHz)	Height (cm)	Pol	Azimuth (deg)	Elevation (deg)	Corr. (dB/m)
5650.013	---	42.9	---	---	1000.0	1000.000	150.0	H	-176.0	15.0	14.1
5650.013	55.7	---	68.21	12.51	1000.0	1000.000	150.0	H	-176.0	15.0	14.1
5723.100	---	42.7	---	---	1000.0	1000.000	150.0	V	126.0	103.0	14.2
5723.100	55.8	---	117.8	62.03	1000.0	1000.000	150.0	V	126.0	103.0	14.2

Radio Technology = WLAN a MIMO, Operating Frequency = high, Subband = U-NII-3 (S05\_AD02)

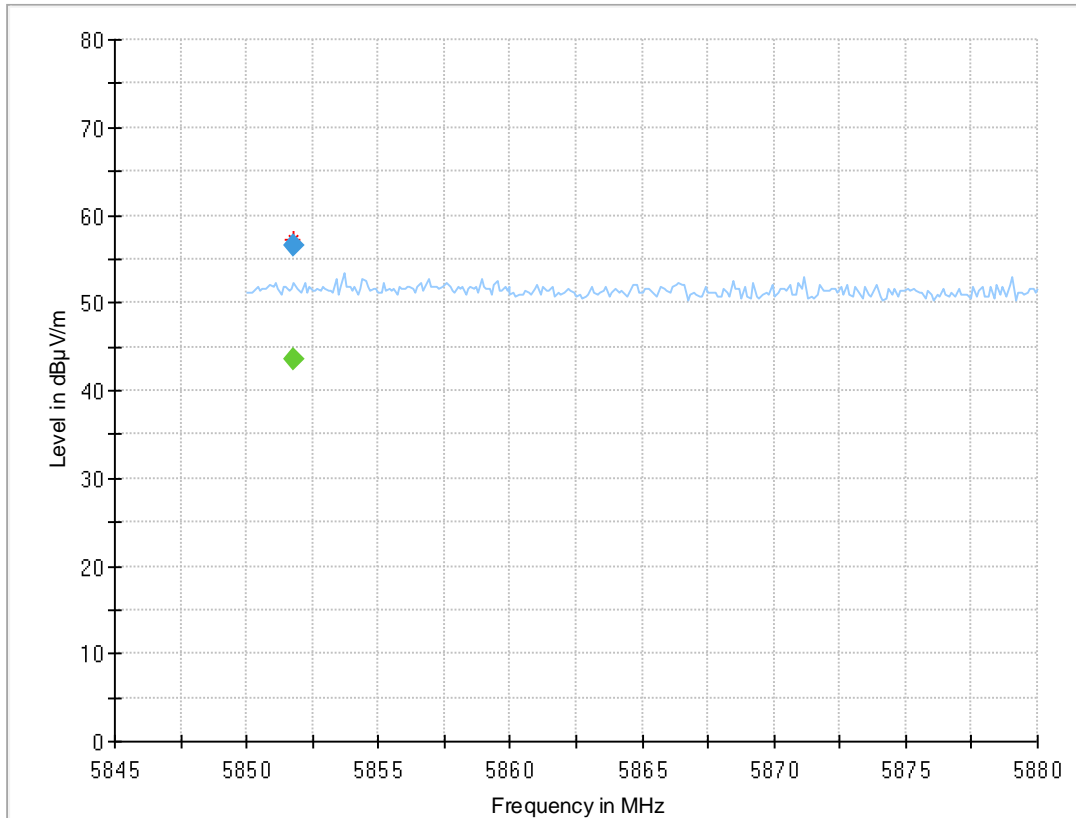

### Final Result

Frequency (MHz)	MaxPeak (dBµV/m)	CAverage (dBµV/m)	Limit (dBµV/m)	Margi n (dB)	Meas. Time (ms)	Bandwidt h (kHz)	Heigh t (cm)	Pol	Azimet h (deg)	Elevatio n (deg)	Corr. (dB/ m)
5851.800	---	43.6	---	---	1000.0	1000.000	150.0	H	51.0	78.0	14.9
5851.800	56.5	---	118.1	61.55	1000.0	1000.000	150.0	H	51.0	78.0	14.9

Radio Technology = WLAN n 20 MHz, Operating Frequency = low, Subband = U-NII-1 (S05\_AD02)

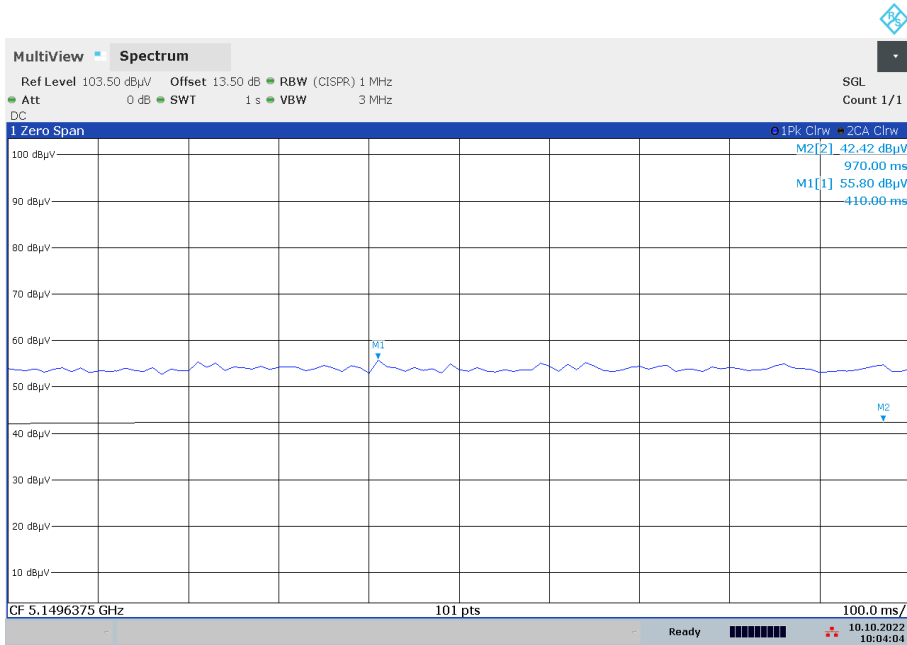

10:04:04 10.10.2022

Radio Technology = WLAN n 20 MHz, Operating Frequency = low, Subband = U-NII-3 (S05\_AD02)

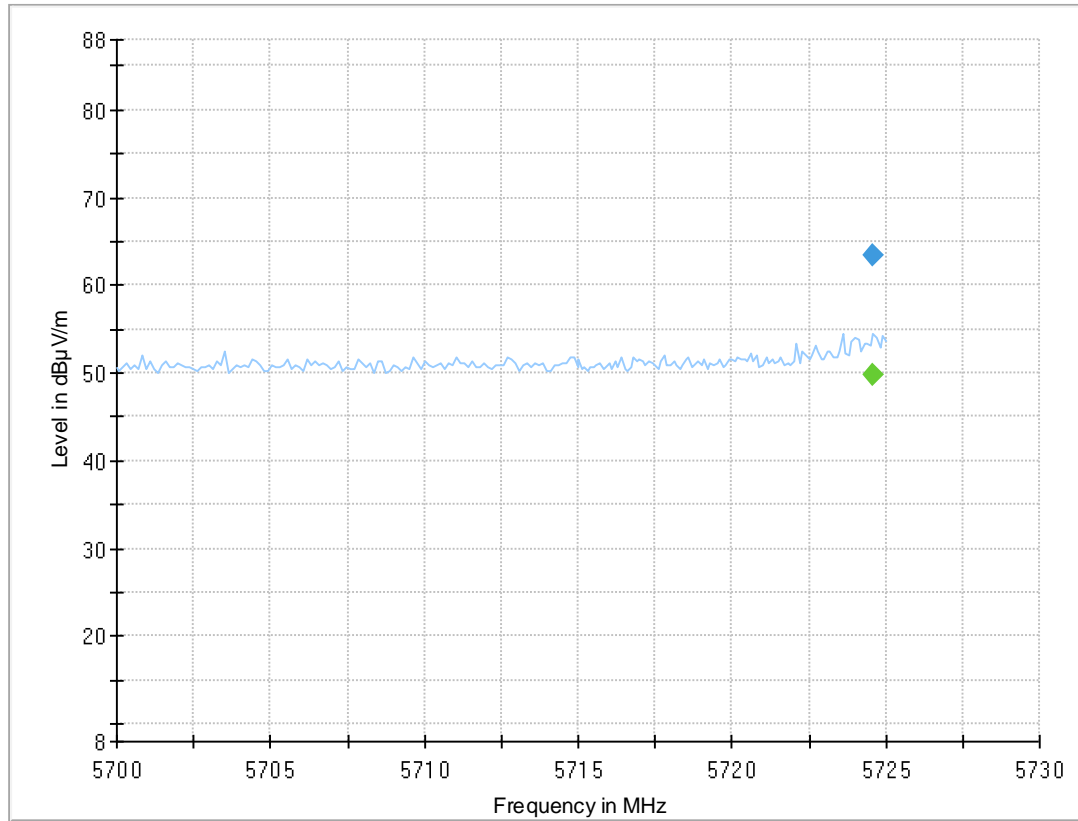

### Final Result

Frequency (MHz)	MaxPeak (dBµV/m)	CAverage (dBµV/m)	Limit (dBµV/m)	Margin (dB)	Meas. Time (ms)	Bandwidth (kHz)	Height (cm)	Pol	Azimuth (deg)	Elevation (deg)	Corr. (dB/m)
5724.600	---	49.7	---	---	1000.0	1000.000	150.0	V	-5.0	92.0	14.2
5724.600	63.5	---	121.2	57.77	1000.0	1000.000	150.0	V	-5.0	92.0	14.2

Radio Technology = WLAN n 20 MHz, Operating Frequency = high, Subband = U-NII-3 (S05\_AD02)

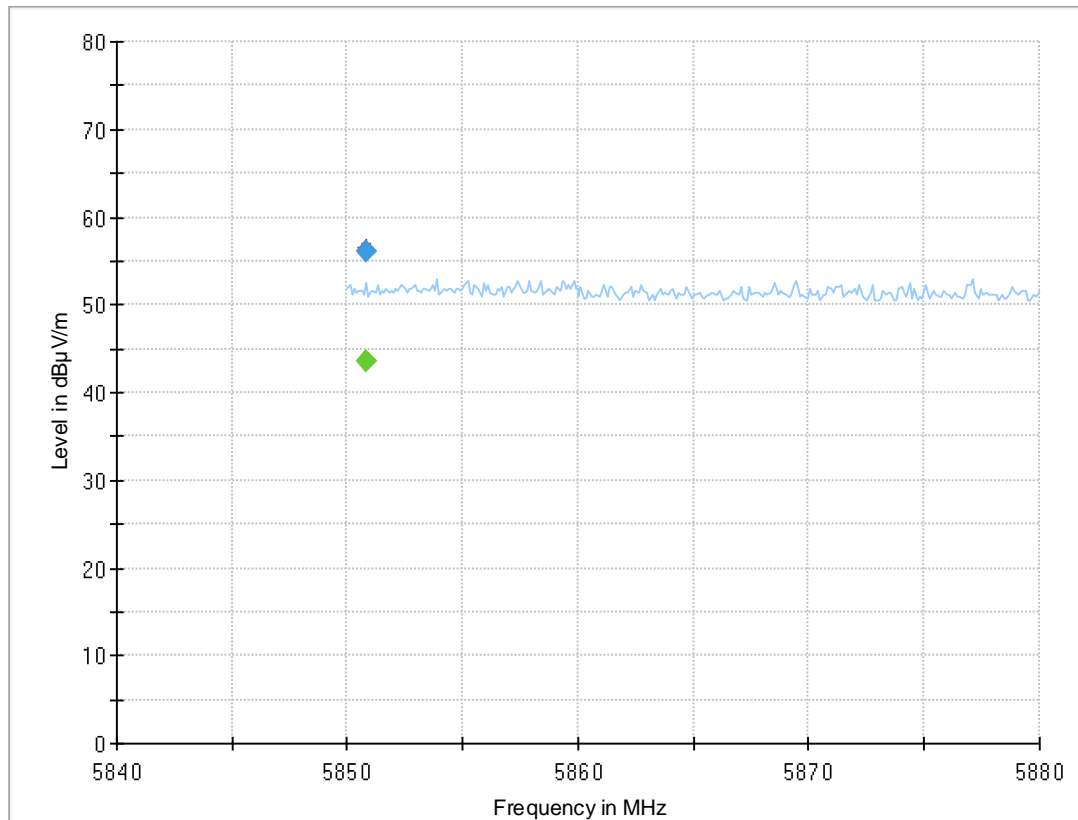

### Final Result

Frequency (MHz)	MaxPeak (dBµV/m)	CAverage (dBµV/m)	Limit (dBµV/m)	Margin (dB)	Meas. Time (ms)	Bandwidth (kHz)	Height (cm)	Pol	Azimuth (deg)	Elevation (deg)	Corr. (dB/m)
5850.800	---	43.6	---	---	1000.0	1000.000	150.0	V	40.0	15.0	14.9
5850.800	56.1	---	120.3	64.31	1000.0	1000.000	150.0	V	40.0	15.0	14.9

Radio Technology = WLAN ac 40 MHz, Operating Frequency = low, Subband = U-NII-1 (S05\_AD02)

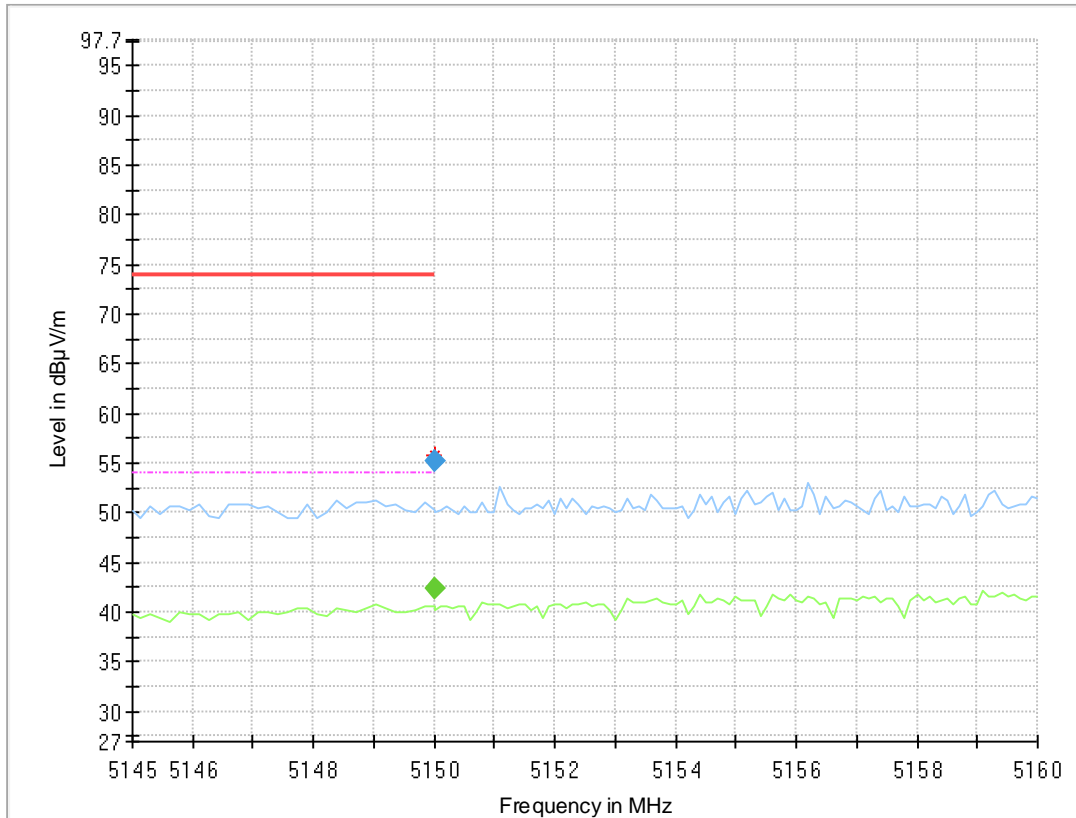

**Final Result**

Frequency (MHz)	MaxPeak (dBµV/m)	CAverage (dBµV/m)	Limit (dBµV/m)	Margin (dB)	Meas. Time (ms)	Bandwidth (kHz)	Height (cm)	Pol	Azimuth (deg)	Elevation (deg)	Corr. (dB/m)
5150.000	55.3	---	74.00	18.71	1000.0	1000.000	150.0	V	-184.0	-6.0	13.5
5150.000	---	42.3	54.00	11.70	1000.0	1000.000	150.0	V	-184.0	-6.0	13.5



Radio Technology = WLAN ac 40 MHz, Operating Frequency = low, Subband = U-NII-3 (S05\_AD02)

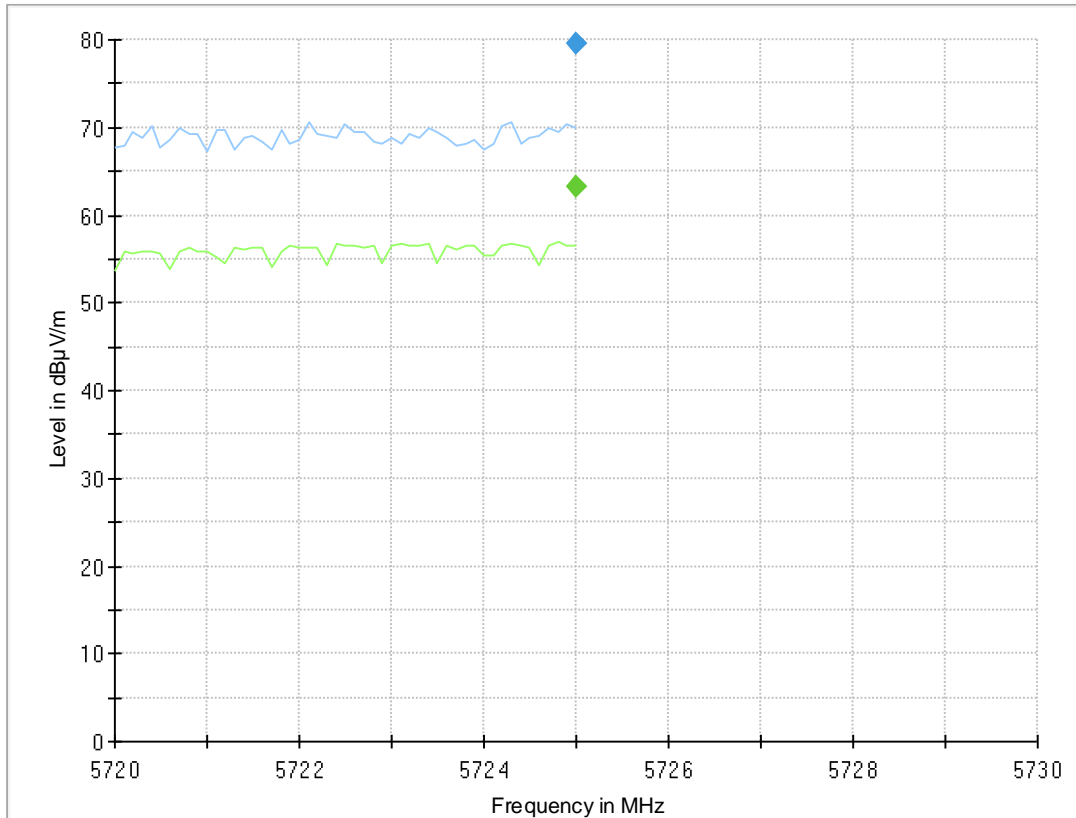

### Final Result

Frequency (MHz)	MaxPeak (dBµV/m)	CAverage (dBµV/m)	Limit (dBµV/m)	Margin (dB)	Meas. Time (ms)	Bandwidth (kHz)	Height (cm)	Pol	Azimuth (deg)	Elevation (deg)	Corr. (dB/m)
5725.000	---	63.3	---	---	1000.0	1000.000	150.0	V	-1.0	92.0	14.2
5725.000	79.6	---	122.2	42.65	1000.0	1000.000	150.0	V	-1.0	92.0	14.2

Radio Technology = WLAN ac 40 MHz, Operating Frequency = high, Subband = U-NII-3 (S05\_AD02)

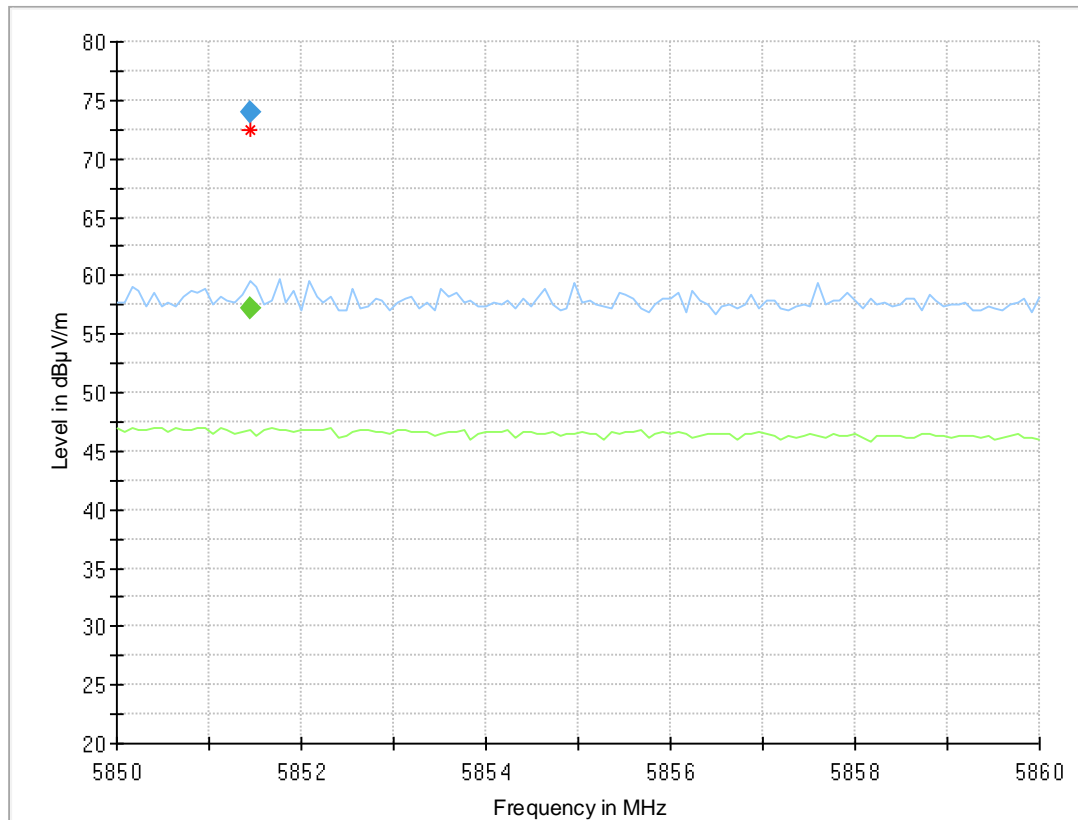

### Final Result

Frequency (MHz)	MaxPeak (dBµV/m)	CAverage (dBµV/m)	Limit (dBµV/m)	Margin (dB)	Meas. Time (ms)	Bandwidth (kHz)	Height (cm)	Pol	Azimuth (deg)	Elevation (deg)	Corr. (dB/m)
5851.440	---	57.1	---	---	1000.0	1000.000	150.0	V	-2.0	98.0	14.9
5851.440	74.0	---	118.9	44.96	1000.0	1000.000	150.0	V	-2.0	98.0	14.9

Radio Technology = WLAN n 40 MHz MIMO, Operating Frequency = low, Subband = U-NII-1 (S05\_AD02)

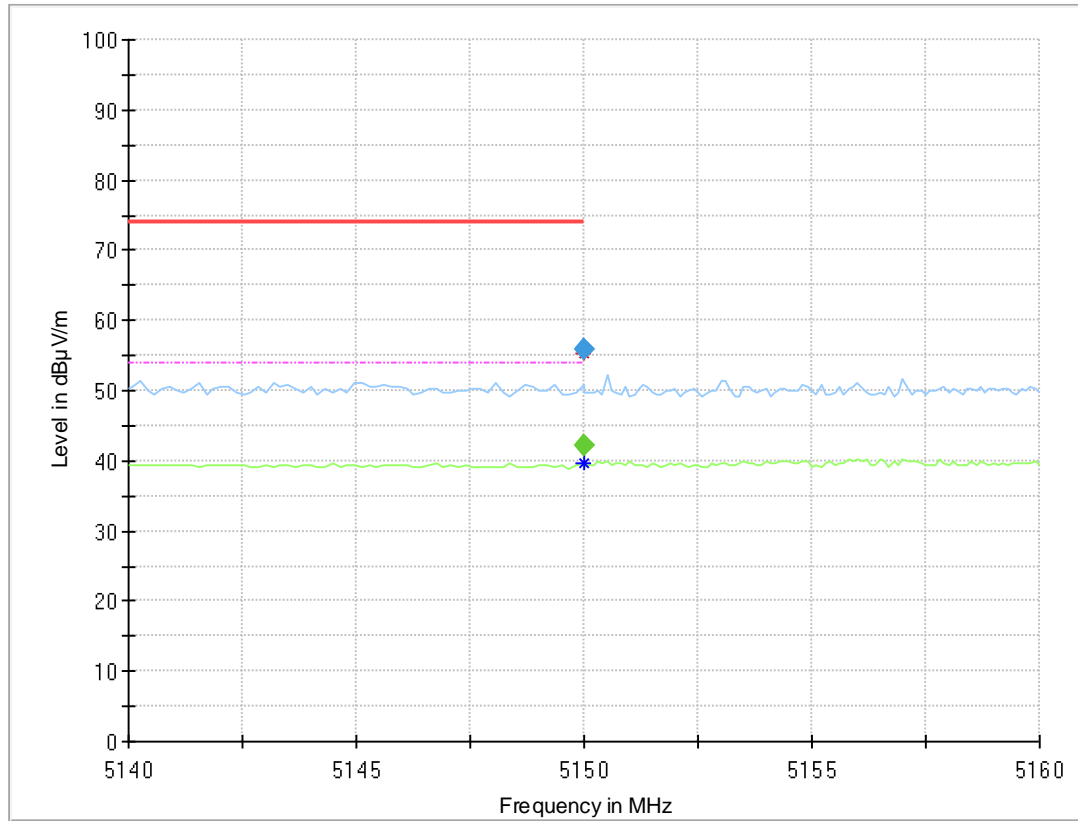

### Final Result

Frequency (MHz)	MaxPeak (dBµV/m)	CAverage (dBµV/m)	Limit (dBµV/m)	Margin (dB)	Meas. Time (ms)	Bandwidth (kHz)	Height (cm)	Pol	Azimuth (deg)	Elevation (deg)	Corr. (dB/m)
5150.000	---	42.3	54.00	11.74	1000.0	1000.000	150.0	H	-132.0	-9.0	13.5
5150.000	55.8	---	74.00	18.22	1000.0	1000.000	150.0	H	-132.0	-9.0	13.5

Radio Technology = WLAN n 40 MHz MIMO, Operating Frequency = low, Subband = U-NII-3 (S05\_AD02)

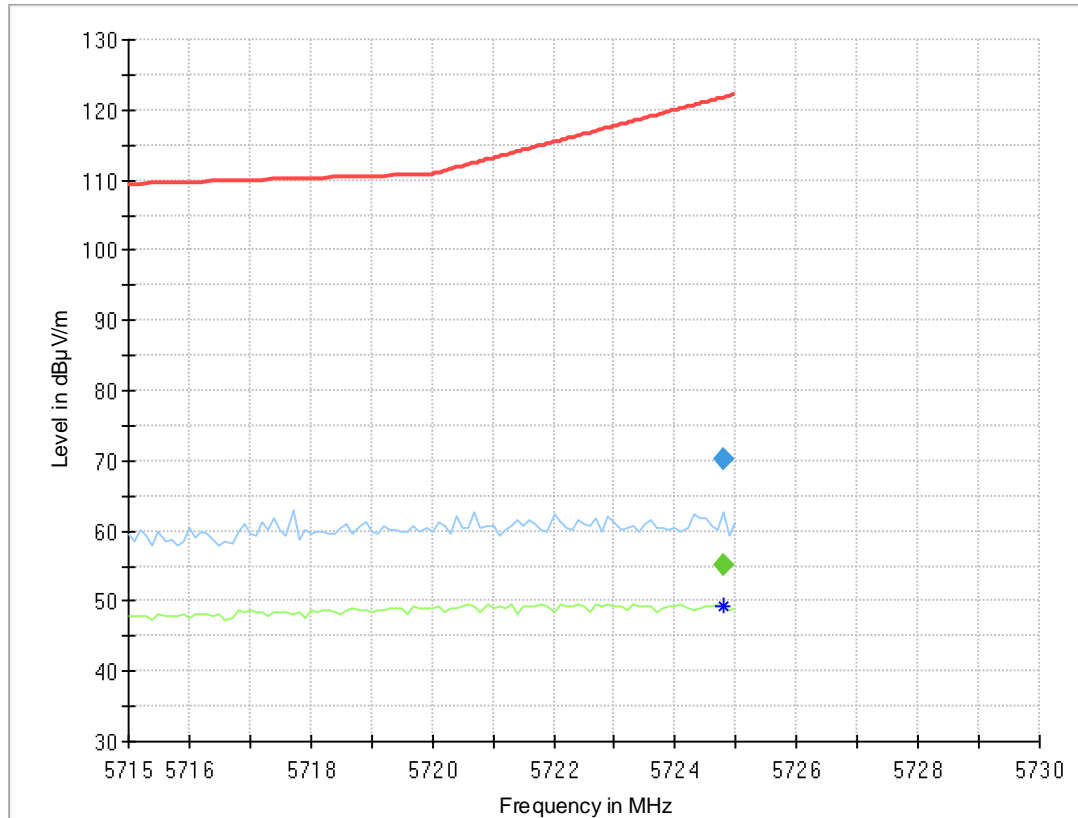

### Final Result

Frequency (MHz)	MaxPeak (dBµV/m)	CAverage (dBµV/m)	Limit (dBµV/m)	Margin (dB)	Meas. Time (ms)	Bandwidth (kHz)	Height (cm)	Pol	Azimuth (deg)	Elevation (deg)	Corr. (dB/m)
5724.800	---	55.1	---	---	1000.0	1000.000	150.0	H	0.0	97.0	14.2
5724.800	70.3	---	121.7	51.40	1000.0	1000.000	150.0	H	0.0	97.0	14.2

Radio Technology = WLAN n 40 MHz MIMO, Operating Frequency = high, Subband = U-NII-3 (S05\_AD02)

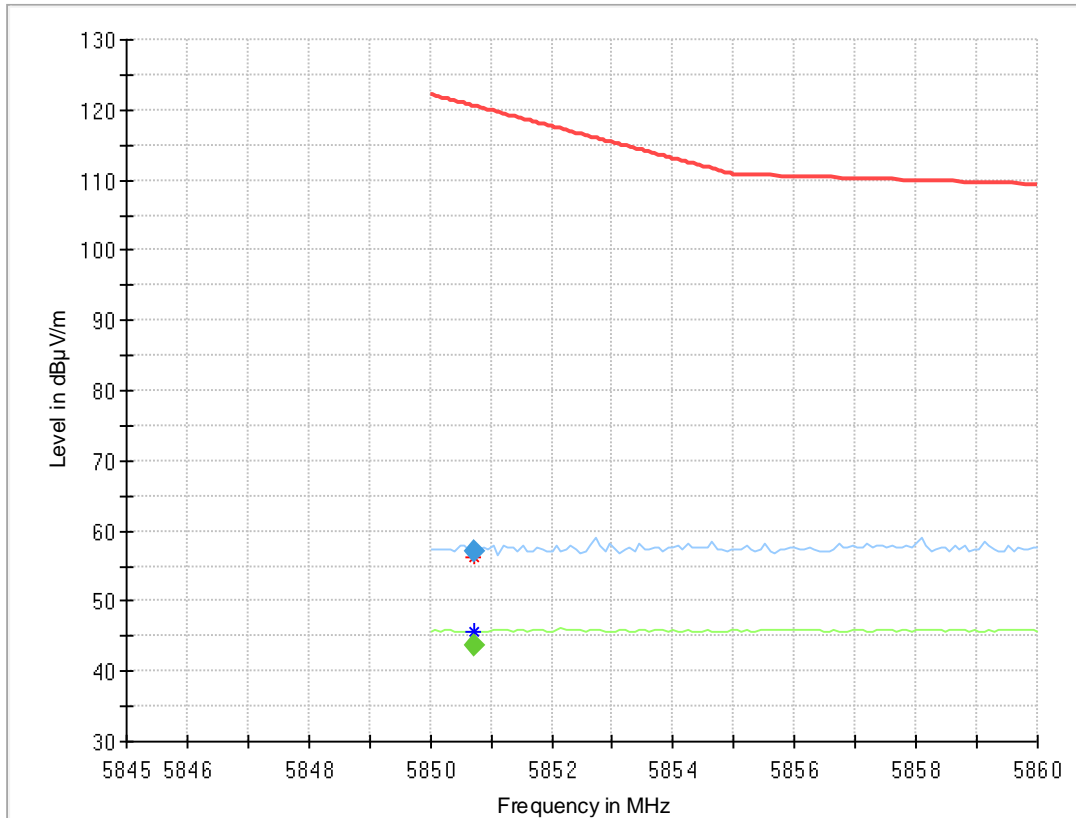

**Final Result**

Frequency (MHz)	MaxPeak (dBµV/m)	CAverage (dBµV/m)	Limit (dBµV/m)	Margi n (dB)	Meas. Time (ms)	Bandwidt h (kHz)	Heigh t (cm)	Pol	Azimut h (deg)	Elevatio n (deg)	Corr. (dB/ m)
5850.720	---	43.6	---	---	1000.0	1000.000	150.0	H	126.0	92.0	14.9
5850.720	57.0	---	120.5	63.55	1000.0	1000.000	150.0	H	126.0	92.0	14.9

Radio Technology = WLAN ac 20 MHz MIMO, Operating Frequency = low, Subband = U-NII-1 (S05\_AD02)

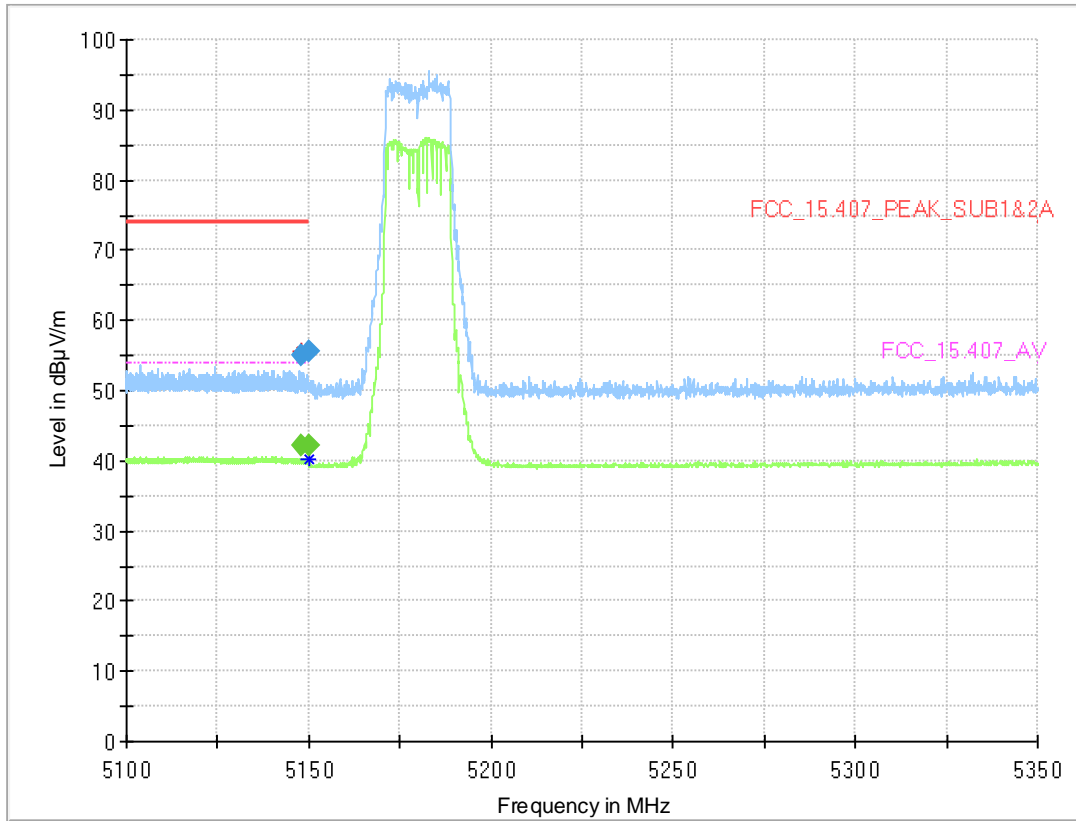

### Final Result

Frequency (MHz)	MaxPeak (dBµV/m)	CAverage (dBµV/m)	Limit (dBµV/m)	Margin (dB)	Meas. Time (ms)	Bandwidth (kHz)	Height (cm)	Pol	Azimuth (deg)	Elevation (deg)	Corr. (dB/m)
5148.200	---	42.3	54.00	11.68	1000.0	1000.000	150.0	V	50.0	-2.0	13.5
5148.200	55.2	---	74.00	18.84	1000.0	1000.000	150.0	V	50.0	-2.0	13.5
5149.975	---	42.2	54.00	11.77	1000.0	1000.000	150.0	H	46.0	8.0	13.5
5149.975	55.7	---	74.00	18.29	1000.0	1000.000	150.0	H	46.0	8.0	13.5

Radio Technology = WLAN ac 20 MHz MIMO, Operating Frequency = low, Subband = U-NII-3 (S05\_AD02)

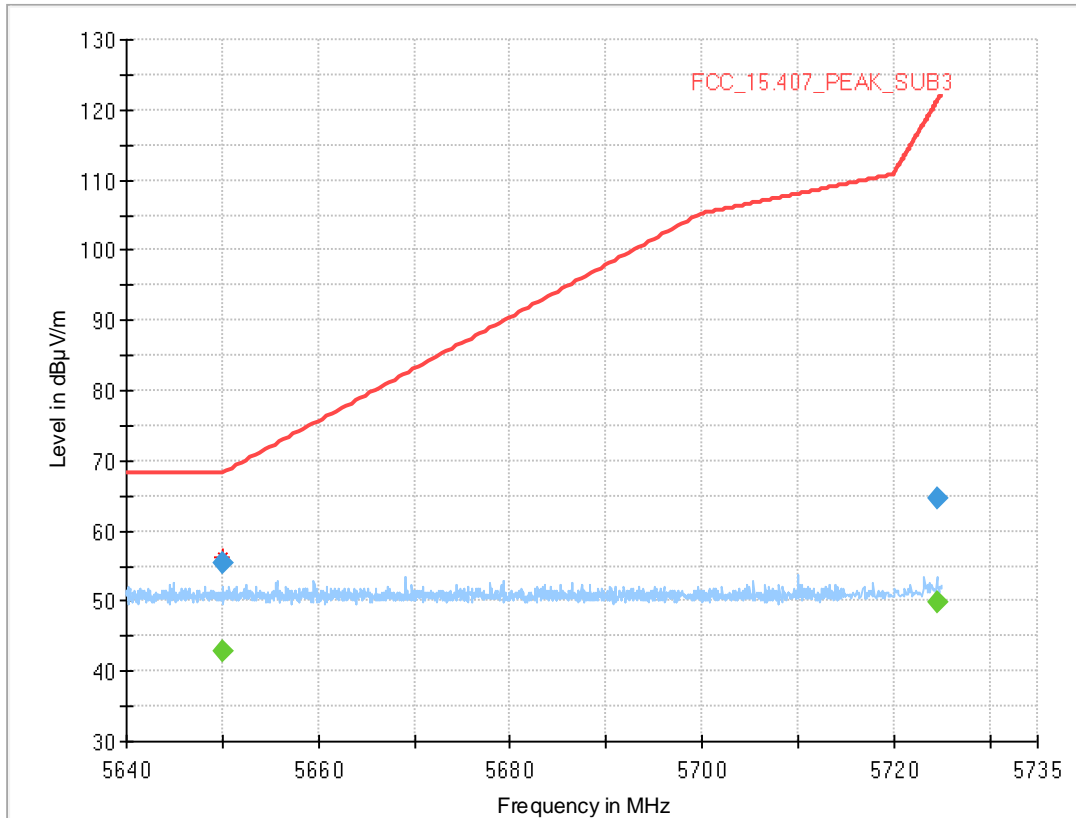

**Final Result**

Frequency (MHz)	MaxPeak (dBµV/m)	CAverage (dBµV/m)	Limit (dBµV/m)	Margin (dB)	Meas. Time (ms)	Bandwidth (kHz)	Height (cm)	Pol	Azimuth (deg)	Elevation (deg)	Corr. (dB/m)
5650.013	55.4	---	68.21	12.78	1000.0	1000.000	150.0	H	89.0	75.0	14.1
5650.013	---	42.9	---	---	1000.0	1000.000	150.0	H	89.0	75.0	14.1
5724.500	---	49.8	---	---	1000.0	1000.000	150.0	H	0.0	97.0	14.2
5724.500	64.6	---	121.0	56.41	1000.0	1000.000	150.0	H	0.0	97.0	14.2

Radio Technology = WLAN ac 20 MHz MIMO, Operating Frequency = high, Subband = U-NII-3 (S05\_AD02)

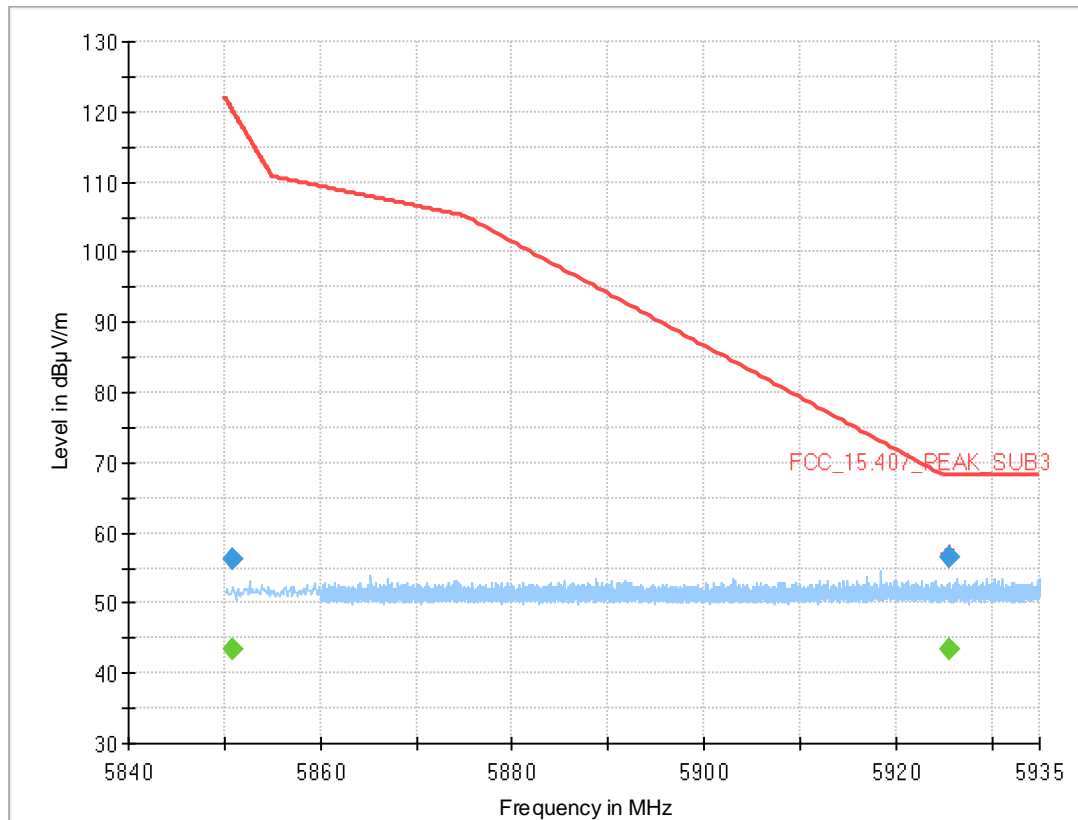

### Final Result

Frequency (MHz)	MaxPeak (dBµV/m)	CAverage (dBµV/m)	Limit (dBµV/m)	Margin (dB)	Meas. Time (ms)	Bandwidth (kHz)	Height (cm)	Pol	Azimuth (deg)	Elevation (deg)	Corr. (dB/m)
5850.900	---	43.5	---	---	1000.0	1000.000	150.0	V	44.0	4.0	14.9
5850.900	56.4	---	120.1	63.79	1000.0	1000.000	150.0	V	44.0	4.0	14.9
5925.520	---	43.5	---	---	1000.0	1000.000	150.0	H	46.0	105.0	15.0
5925.520	56.7	---	68.20	11.53	1000.0	1000.000	150.0	H	46.0	105.0	15.0



Radio Technology = WLAN ac 80 MHz MIMO, Operating Frequency = mid, Subband = U-NII-1 (S05\_AC02)

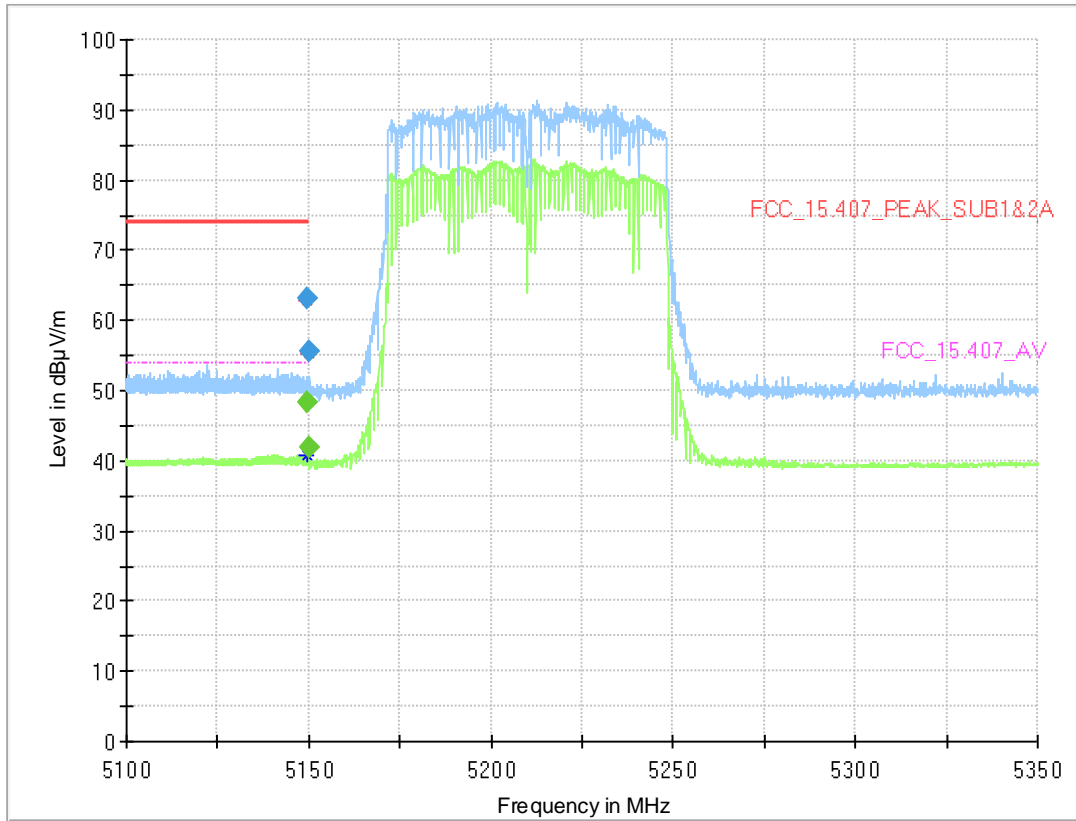

### Final Result

Frequency (MHz)	MaxPeak (dBµV/m)	CAverage (dBµV/m)	Limit (dBµV/m)	Margin (dB)	Meas. Time (ms)	Bandwidth (kHz)	Height (cm)	Pol	Azimuth (deg)	Elevation (deg)	Corr. (dB/m)
5149.813	---	48.4	54.00	5.58	1000.0	1000.000	150.0	V	7.0	96.0	13.5
5149.813	63.2	---	74.00	10.82	1000.0	1000.000	150.0	V	7.0	96.0	13.5
5149.975	---	41.9	54.00	12.06	1000.0	1000.000	150.0	V	-143.0	2.0	13.5
5149.975	55.6	---	74.00	18.39	1000.0	1000.000	150.0	V	-143.0	2.0	13.5

Radio Technology = WLAN ac 80 MHz MIMO, Operating Frequency = mid, Subband = U-NII-3 (S05\_AC02)

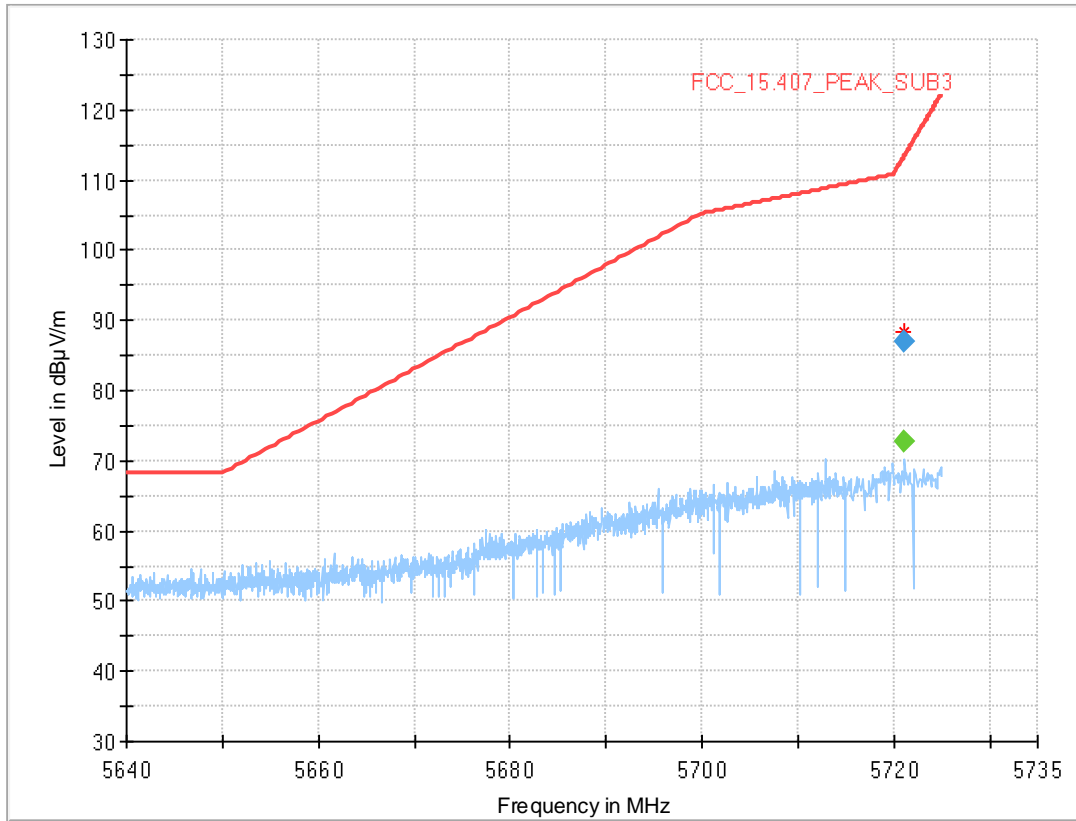

### Final Result

Frequency (MHz)	MaxPeak (dBµV/m)	CAverage (dBµV/m)	Limit (dBµV/m)	Margin (dB)	Meas. Time (ms)	Bandwidth (kHz)	Height (cm)	Pol	Azimuth (deg)	Elevation (deg)	Corr. (dB/m)
5721.100	---	72.7	---	---	1000.0	1000.000	150.0	V	-1.0	94.0	14.2
5721.100	87.1	---	113.3	26.24	1000.0	1000.000	150.0	V	-1.0	94.0	14.2

Radio Technology = WLAN ax 20 MHz, Operating Frequency = low, Subband = U-NII-1 (S05\_AD02)

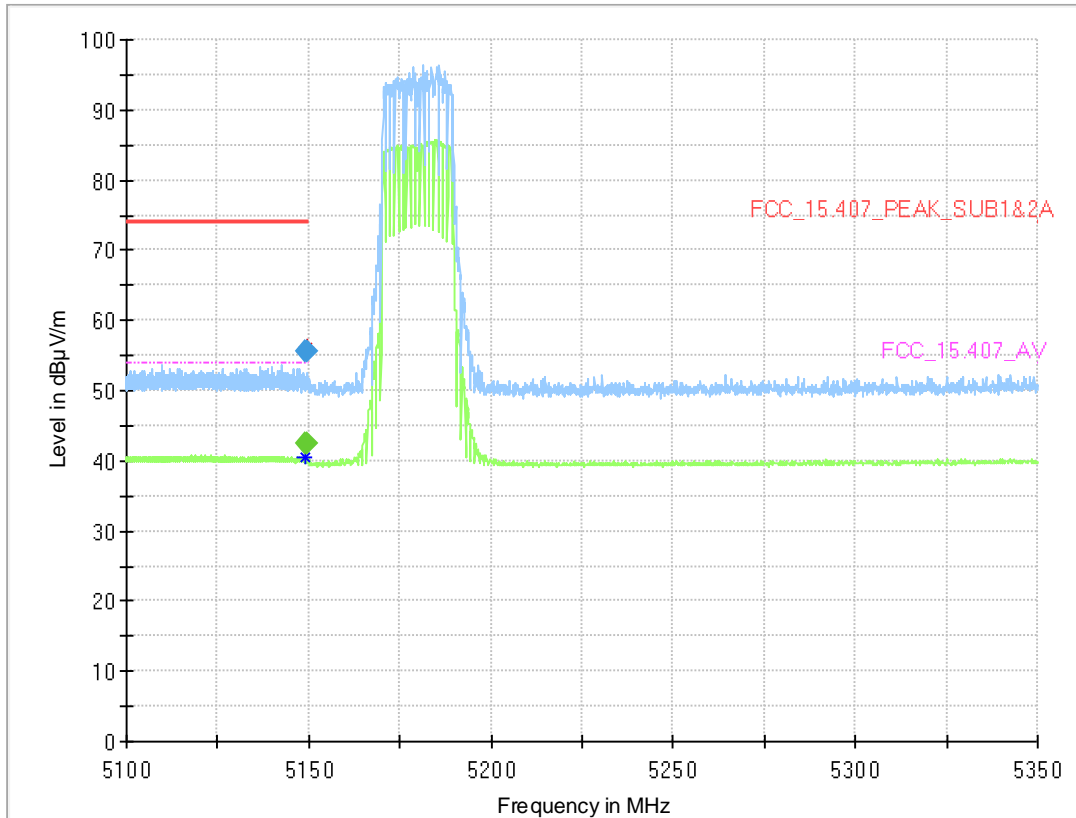

### Final Result

Frequency (MHz)	MaxPeak (dBµV/m)	CAverage (dBµV/m)	Limit (dBµV/m)	Margin (dB)	Meas. Time (ms)	Bandwidth (kHz)	Height (cm)	Pol	Azimuth (deg)	Elevation (deg)	Corr. (dB/m)
5148.925	---	42.5	54.00	11.51	1000.0	1000.000	150.0	V	-52.0	6.0	13.5
5148.925	55.6	---	74.00	18.41	1000.0	1000.000	150.0	V	-52.0	6.0	13.5
5149.638	---	42.5	54.00	11.54	1000.0	1000.000	150.0	H	146.0	78.0	13.5
5149.638	55.6	---	74.00	18.41	1000.0	1000.000	150.0	H	146.0	78.0	13.5

Radio Technology = WLAN ax 20 MHz, Operating Frequency = low, Subband = U-NII-3 (S05\_AD02)

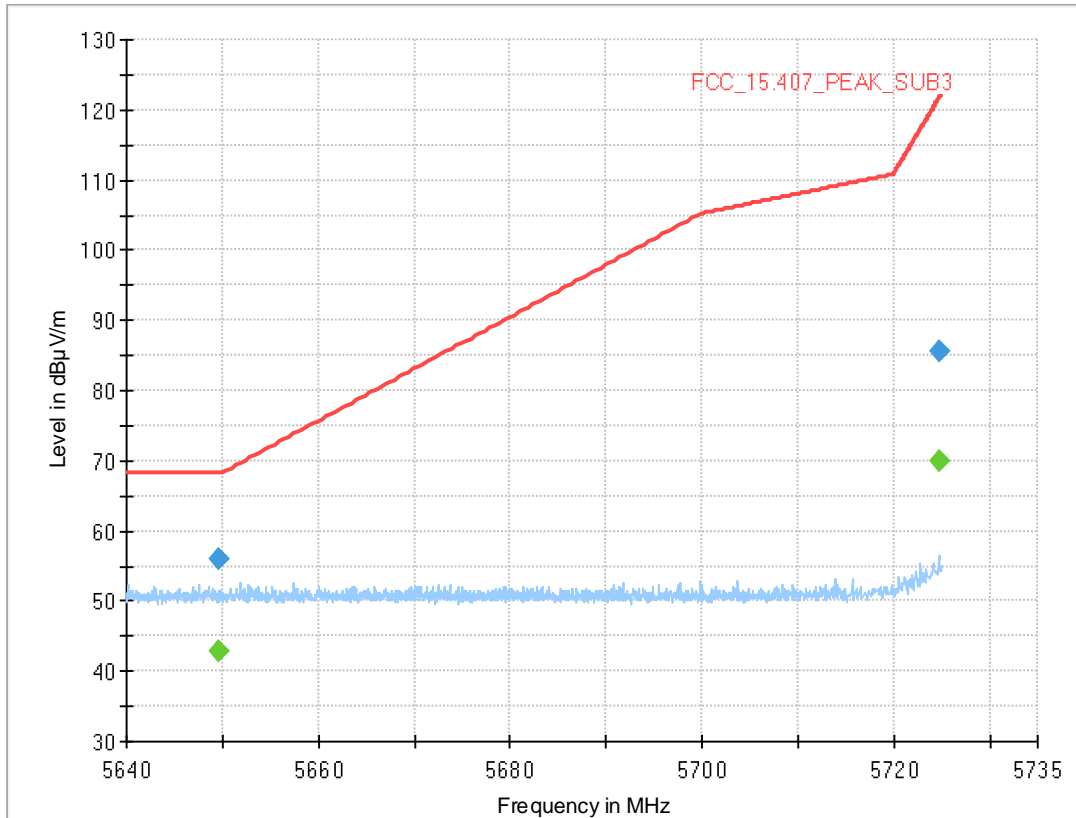

**Final Result**

Frequency (MHz)	MaxPeak (dBµV/m)	CAverage (dBµV/m)	Limit (dBµV/m)	Margin (dB)	Meas. Time (ms)	Bandwidth (kHz)	Height (cm)	Pol	Azimuth (deg)	Elevation (deg)	Corr. (dB/m)
5649.713	---	42.8	---	---	1000.0	1000.000	150.0	V	-43.0	12.0	14.1
5649.713	55.9	---	68.20	12.26	1000.0	1000.000	150.0	V	-43.0	12.0	14.1
5724.700	---	69.8	---	---	1000.0	1000.000	150.0	V	-4.0	96.0	14.2
5724.700	85.6	---	121.5	35.94	1000.0	1000.000	150.0	V	-4.0	96.0	14.2

Radio Technology = WLAN ax 20 MHz, Operating Frequency = high, Subband = U-NII-3 (S05\_AD02)

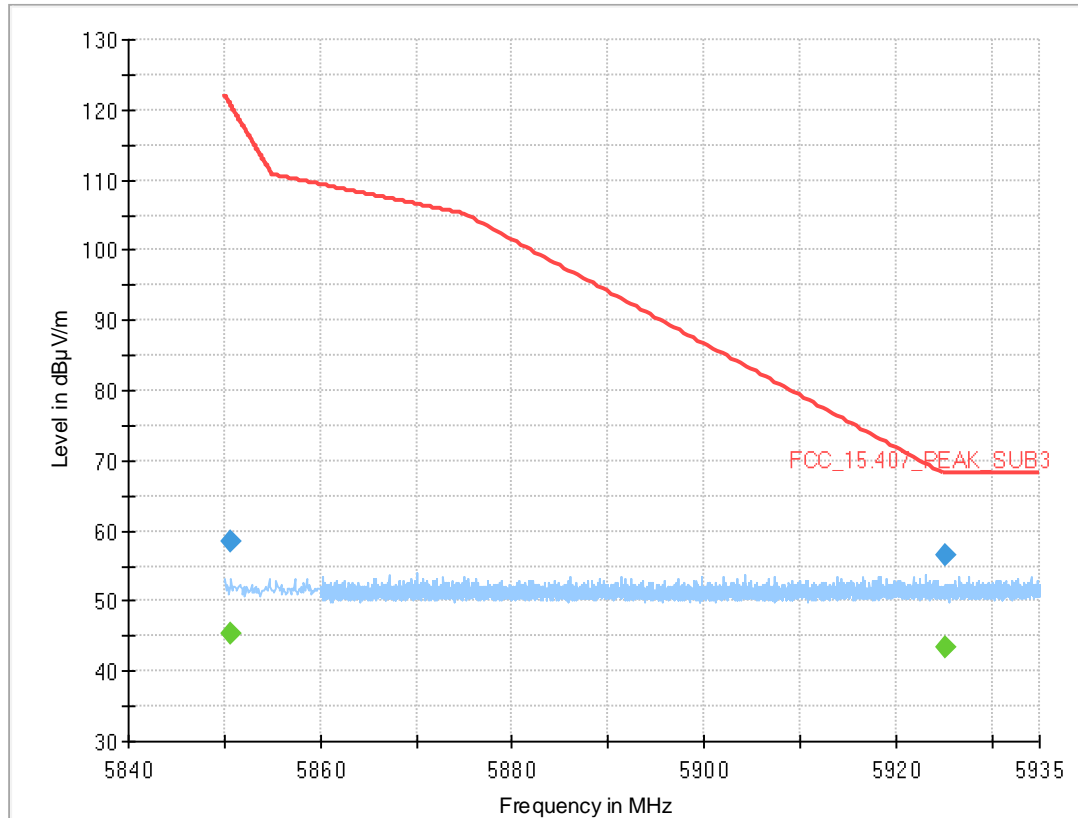

**Final Result**

Frequency (MHz)	MaxPeak (dBµV/m)	CAverage (dBµV/m)	Limit (dBµV/m)	Margin (dB)	Meas. Time (ms)	Bandwidth (kHz)	Height (cm)	Pol	Azimuth (deg)	Elevation (deg)	Corr. (dB/m)
5850.700	---	45.2	---	---	1000.0	1000.000	150.0	V	-4.0	92.0	14.9
5850.700	58.5	---	120.6	62.09	1000.0	1000.000	150.0	V	-4.0	92.0	14.9
5925.235	---	43.5	---	---	1000.0	1000.000	150.0	V	143.0	1.0	15.0
5925.235	56.7	---	68.20	11.53	1000.0	1000.000	150.0	V	143.0	1.0	15.0

Radio Technology = WLAN ax 40 MHz MIMO, Operating Frequency = low, Subband = U-NII-1 (S05\_AD02)

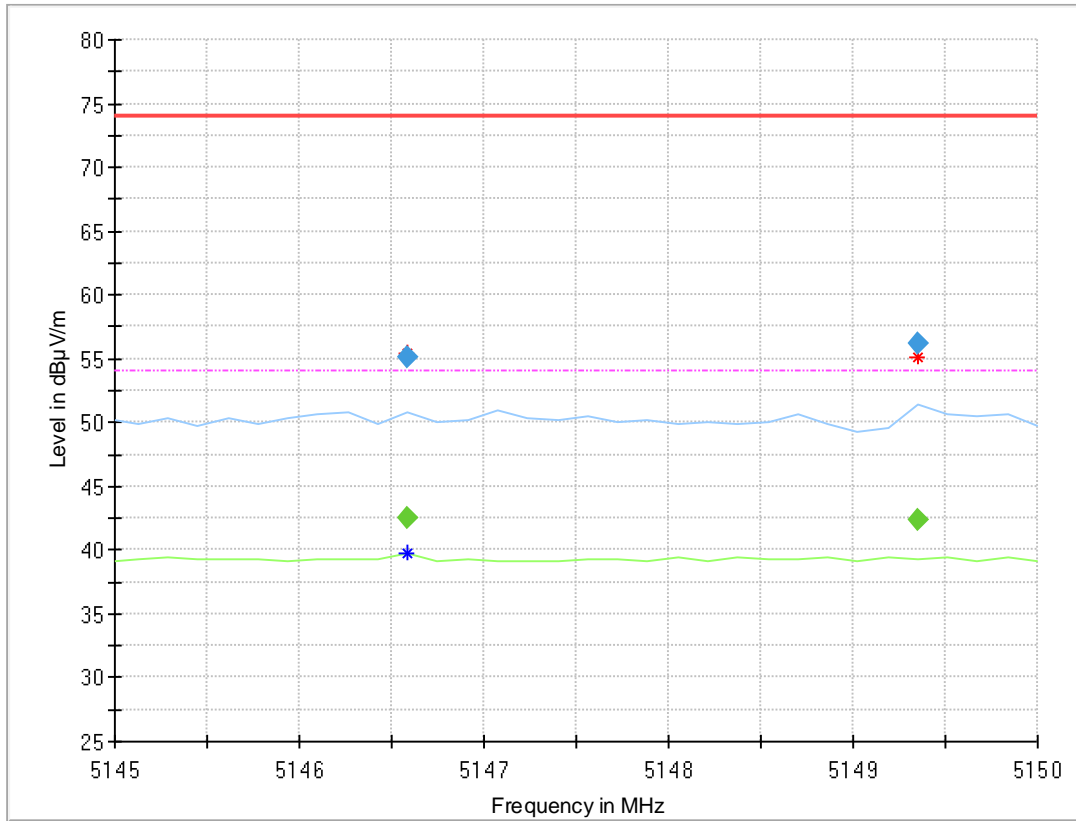

### Final Result

Frequency (MHz)	MaxPeak (dBµV/m)	CAverage (dBµV/m)	Limit (dBµV/m)	Margin (dB)	Meas. Time (ms)	Bandwidth (kHz)	Height (cm)	Pol	Azimuth (deg)	Elevation (deg)	Corr. (dB/m)
5146.588	---	42.5	54.00	11.52	1000.0	1000.000	150.0	V	7.0	105.0	13.6
5146.588	55.2	---	74.00	18.81	1000.0	1000.000	150.0	V	7.0	105.0	13.6
5149.350	---	42.3	54.00	11.72	1000.0	1000.000	150.0	V	85.0	14.0	13.5
5149.350	56.2	---	74.00	17.83	1000.0	1000.000	150.0	V	85.0	14.0	13.5

Radio Technology = WLAN ax 40 MHz MIMO, Operating Frequency = low, Subband = U-NII-3 (S05\_AD02)

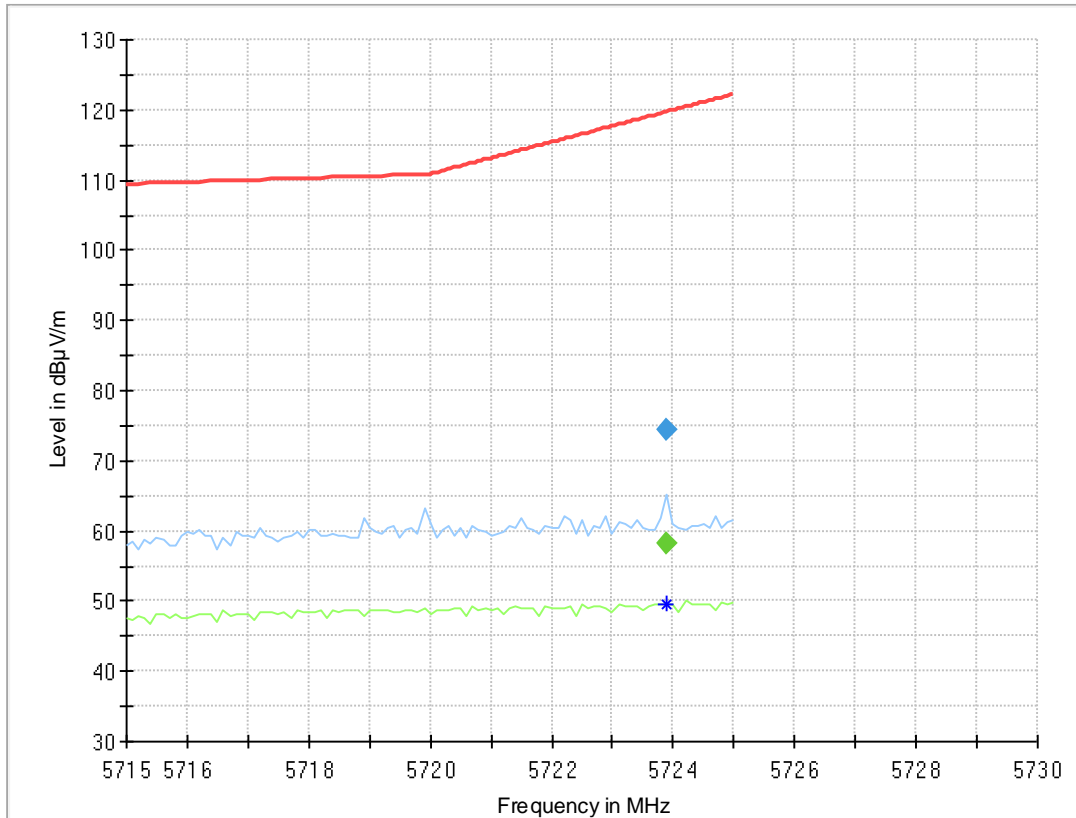

**Final Result**

Frequency (MHz)	MaxPeak (dBµV/m)	CAverage (dBµV/m)	Limit (dBµV/m)	Margin (dB)	Meas. Time (ms)	Bandwidth (kHz)	Height (cm)	Pol	Azimuth (deg)	Elevation (deg)	Corr. (dB/m)
5723.900	---	58.2	---	---	1000.0	1000.000	150.0	H	-2.0	98.0	14.2
5723.900	74.5	---	119.6	45.22	1000.0	1000.000	150.0	H	-2.0	98.0	14.2

Radio Technology = WLAN ax 40 MHz MIMO, Operating Frequency = high, Subband = U-NII-3 (S05\_AD02)

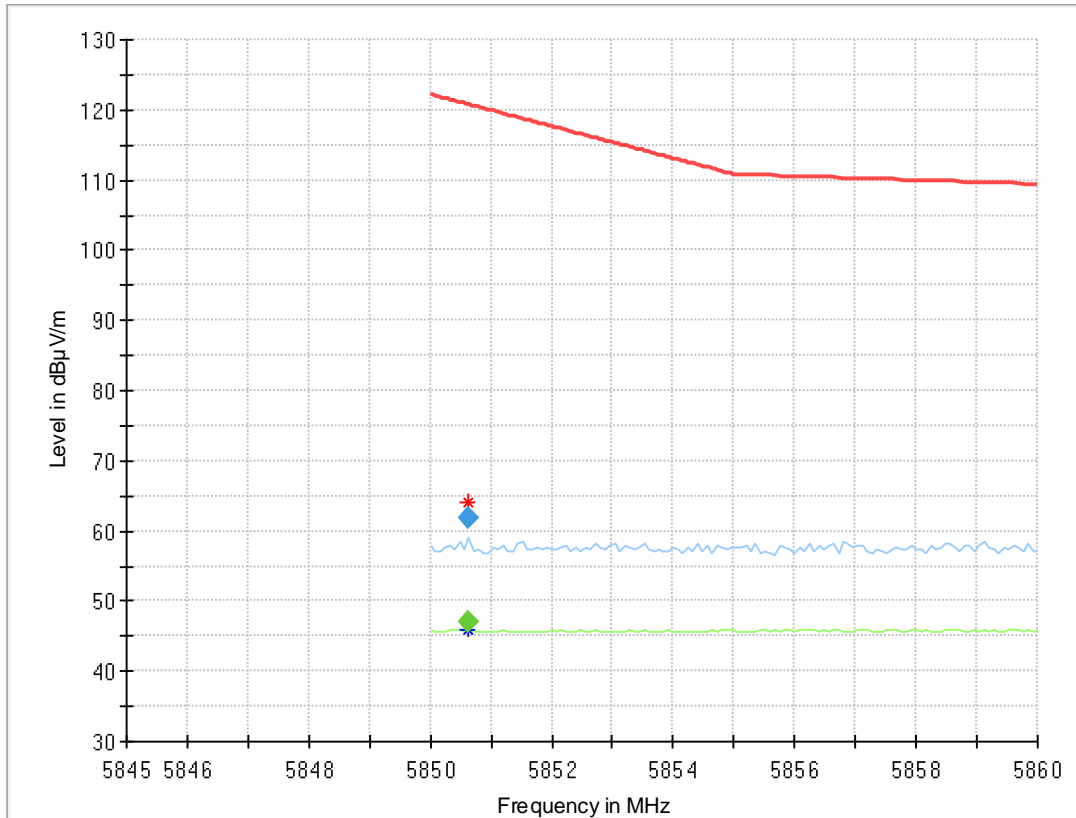

**Final Result**

Frequency (MHz)	MaxPeak (dBµV/m)	CAverage (dBµV/m)	Limit (dBµV/m)	Margin (dB)	Meas. Time (ms)	Bandwidth (kHz)	Height (cm)	Pol	Azimuth (deg)	Elevation (deg)	Corr. (dB/m)
5850.640	---	47.0	---	---	1000.0	1000.000	150.0	V	1.0	96.0	14.9
5850.640	61.9	---	120.7	58.89	1000.0	1000.000	150.0	V	1.0	96.0	14.9



Radio Technology = WLAN ax 80 MHz MIMO, Operating Frequency = mid, Subband = U-NII-1 (S05\_AC02)

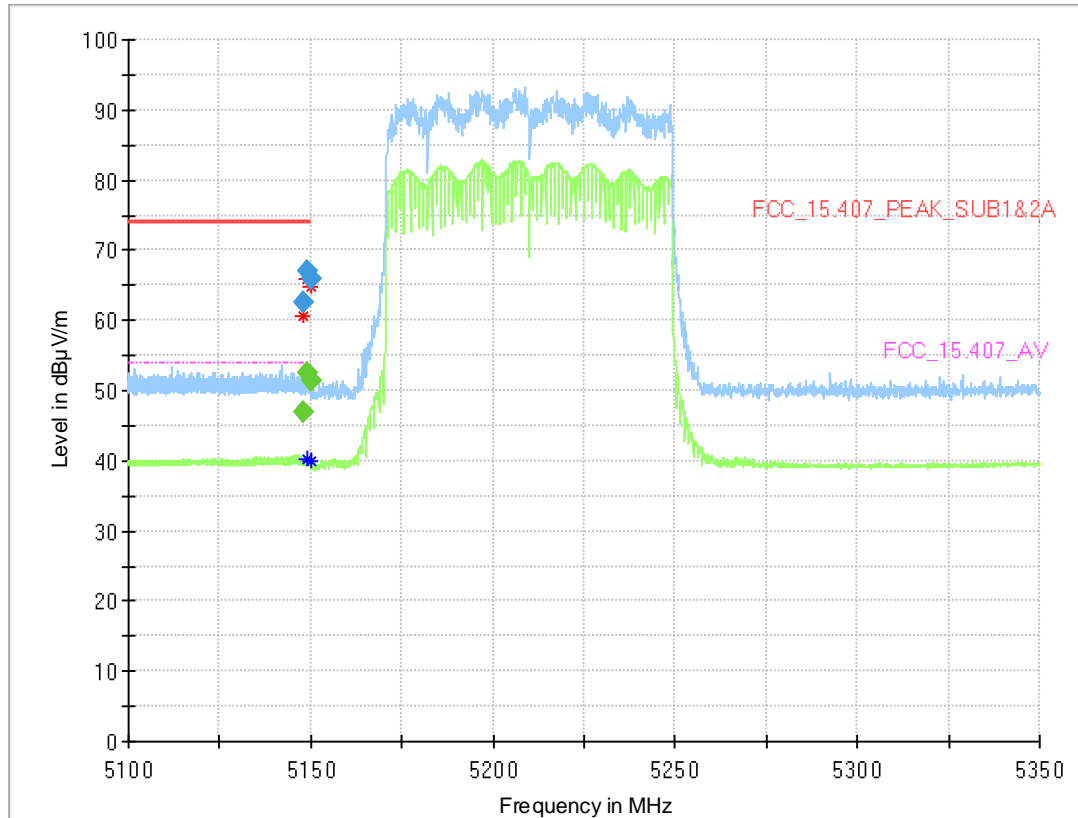

### Final Result

Frequency (MHz)	MaxPeak (dBµV/m)	CAverage (dBµV/m)	Limit (dBµV/m)	Margin (dB)	Meas. Time (ms)	Bandwidth (kHz)	Height (cm)	Pol	Azimuth (deg)	Elevation (deg)	Corr. (dB/m)
5148.000	---	47.0	54.00	6.95	1000.0	1000.000	150.0	H	9.0	100.0	13.6
5148.000	62.6	---	74.00	11.43	1000.0	1000.000	150.0	H	9.0	100.0	13.6
5148.925	---	52.6	54.00	1.36	1000.0	1000.000	150.0	V	3.0	97.0	13.5
5148.925	67.1	---	74.00	6.92	1000.0	1000.000	150.0	V	3.0	97.0	13.5
5149.950	---	51.3	54.00	2.66	1000.0	1000.000	150.0	V	5.0	96.0	13.5
5149.950	65.8	---	74.00	8.17	1000.0	1000.000	150.0	V	5.0	96.0	13.5

Radio Technology = WLAN ax 80 MHz MIMO, Operating Frequency = mid, Subband = U-NII-3 (S05\_AC02)

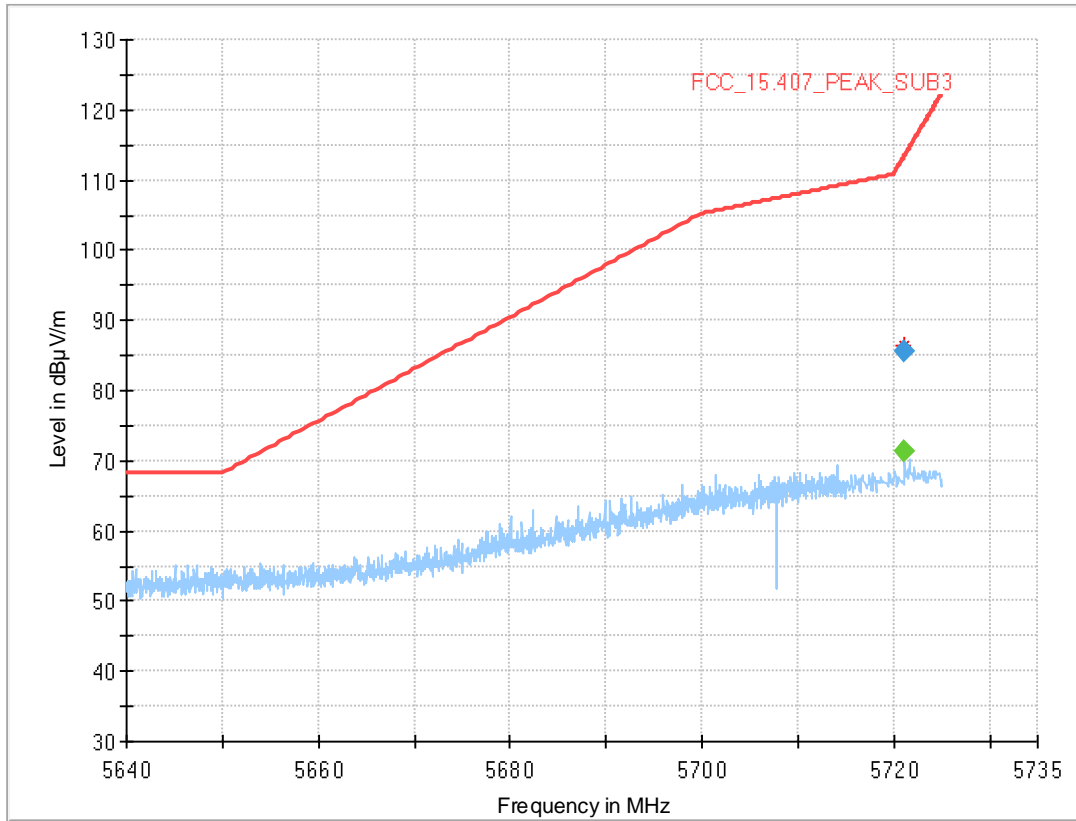

### Final Result

Frequency (MHz)	MaxPeak (dBµV/m)	CAverage (dBµV/m)	Limit (dBµV/m)	Margin (dB)	Meas. Time (ms)	Bandwidth (kHz)	Height (cm)	Pol	Azimuth (deg)	Elevation (deg)	Corr. (dB/m)
5721.100	---	71.4	---	---	1000.0	1000.000	150.0	V	1.0	94.0	14.2
5721.100	85.7	---	113.3	27.60	1000.0	1000.000	150.0	V	1.0	94.0	14.2

### 5.8.5 TEST EQUIPMENT USED

- Radiated Emissions FAR 5 GHz FCC

## 6 TEST EQUIPMENT

### 6.1 TEST EQUIPMENT HARDWARE

- 1 Conducted Emissions FCC  
Conducted Emissions AC Mains for FCC standards

Ref.No.	Device Name	Description	Manufacturer	Serial Number	Last Calibration	Calibration Due
1.1	MFS	Rubidium Frequency Normal	Datum GmbH	002	2021-11	2022-11
1.2	CS-RUB6	Rubidium Frequency Standard	Rohde & Schwarz GmbH & Co. KG	100321	2022-10	2023-10
1.3	Opus10 TPR (8253.00)	T/P Logger 13	Lufft Mess- und Regeltechnik GmbH	13936	2021-10	2023-10
1.4	Fluke 177	Digital Multimeter 03 (Multimeter)	Fluke Europe B.V.	86670383	2022-06	2024-06
1.5	ESH3-Z5	Two-Line V-Network (AUX)	Rohde & Schwarz GmbH & Co. KG	828304/029	2021-08	2023-08
1.6	Chroma 6404	AC Source	Chroma ATE INC.	64040001304		
1.7	Shielded Room 02	Shielded Room 4m x 3m	Frankonia Germany EMC Solution GmbH	-		
1.8	ESH3-Z5	Two-Line V-Network (EUT)	Rohde & Schwarz GmbH & Co. KG	829996/002	2021-08	2023-08
1.9	ESR 7	EMI Receiver / Spectrum Analyzer	Rohde & Schwarz	101424	2021-01	2023-01
1.10	Opus10 THI (8152.00)	T/H Logger 02	Lufft Mess- und Regeltechnik GmbH	7489	2021-10	2023-10
1.11	CS-RUB6	Rubidium Frequency Standard	Rohde & Schwarz GmbH & Co. KG	100321	2022-10	2023-10

- 2 R&S TS8997  
2.4 and 5 GHz Bands Conducted Test Lab

Ref.No.	Device Name	Description	Manufacturer	Serial Number	Last Calibration	Calibration Due
2.1	MFS	Rubidium Frequency Normal	Datum GmbH	002	2021-11	2022-11
2.2	CS-RUB6	Rubidium Frequency Standard	Rohde & Schwarz GmbH & Co. KG	100321	2022-10	2023-10
2.3	Opus10 TPR (8253.00)	T/P Logger 13	Lufft Mess- und Regeltechnik GmbH	13936	2021-10	2023-10
2.4	SMB100A	Signal Generator 9 kHz - 6 GHz	Rohde & Schwarz	107695	2021-06	2024-06
2.5	EX520	Digital Multimeter 12	Extech Instruments Corp	05157876	2022-06	2024-06
2.6	FSV30	Signal Analyzer 10 Hz - 30 GHz	Rohde & Schwarz	103005	2022-06	2024-06

Ref.No.	Device Name	Description	Manufacturer	Serial Number	Last Calibration	Calibration Due
2.7	NGSM 32/10	Power Supply	Rohde & Schwarz GmbH & Co. KG	3456	2022-01	2024-01
2.8	FSW43	Signal Analyser	Rohde & Schwarz GmbH & Co. KG	102013	2021-06 2023-07	2023-06 2025-07
2.9	Opus10 THI (8152.00)	T/H Logger 14	Lufft Mess- und Regeltechnik GmbH	13993	2021-08	2023-08
2.10	SMBV100A	Vector Signal Generator 9 kHz - 6 GHz	Rohde & Schwarz	259291	2019-11 2023-01	2022-11 2026-01
2.11	OSP120	Contains Power Meter and Switching Unit OSP-B157W8 PLUS	Rohde & Schwarz	101158	2021-08	2024-08

3 Radiated Emissions FAR 5 GHz FCC  
Radiated Emissions Tests for 5 GHz bands in a fully anechoic room

Ref.No.	Device Name	Description	Manufacturer	Serial Number	Last Calibration	Calibration Due
3.1	Opus10 TPR (8253.00)	T/P Logger 13	Lufft Mess- und Regeltechnik GmbH	13936	2021-10	2023-10
3.2	AMF-7D00101800-30-10P-R	Broadband Amplifier 100 MHz - 18 GHz	Miteq			
3.3	Anechoic Chamber 03	FAR, 8.80m x 4.60m x 4.05m (l x w x h)	Albatross Projects	P26971-647-001-PRB	2021-04	2023-04
3.4	Fluke 177	Digital Multimeter 03 (Multimeter)	Fluke Europe B.V.	86670383	2022-06	2024-06
3.5	JS4-18002600-32-5P	Broadband Amplifier 18 GHz - 26 GHz	Miteq	849785		
3.6	FSW43	Spectrum Analyzer	Rohde & Schwarz GmbH & Co. KG	103779	2022-11	2024-11
3.7	EP 1200/B, NA/B1	AC Source, Amplifier with integrated variable Oscillator	Spitzenberger & Spies GmbH & Co. KG	B6278		
3.8	3160-09	Standard Gain / Pyramidal Horn Antenna 26.5 GHz	EMCO Elektronik GmbH	00083069		
3.9	WHKX 7.0/18G-8SS	High Pass Filter	Wainwright Instruments GmbH	09		
3.10	TT 1.5 WI	Turn Table	Maturo GmbH	-		
3.11	3160-10	Standard Gain / Pyramidal Horn Antenna 40 GHz	EMCO Elektronik GmbH	00086675		
3.12	FSW43	Signal Analyser	Rohde & Schwarz GmbH & Co. KG	102013	2021-06	2023-06
3.13	Opus 20 THI (8120.00)	ThermoHygro Datalogger	Lufft Mess- und Regeltechnik GmbH	115.0318.0802.033	2020-10	2022-10

Ref.No.	Device Name	Description	Manufacturer	Serial Number	Last Calibration	Calibration Due
3.14	TD1.5-10kg	EUT Tilt Device (Rohacell)	Maturo GmbH	TD1.5-10kg/024/3790709		
3.15	PAS 2.5 - 10 kg	Antenna Mast	Maturo GmbH	-		
3.16	AFS42-00101800-25-S-42	Broadband Amplifier 25 MHz - 18 GHz	Miteq	2035324		
3.17	HF 907	Double-ridged horn	Rohde & Schwarz	102444	2021-09	2024-09

4 Radiated Emissions SAC H-Field  
Radiated emission tests in the H-Field in a semi anechoic room

Ref.No.	Device Name	Description	Manufacturer	Serial Number	Last Calibration	Calibration Due
4.1	N5000/NP	Filter for EUT, 2 Lines, 250 V, 16 A	ETS-LINDGREN	241515		
4.2	Opus10 TPR (8253.00)	T/P Logger 13	Lufft Mess- und Regeltechnik GmbH	13936	2021-10	2023-10
4.3	ESW44	EMI Receiver / Spectrum Analyzer	Rohde & Schwarz GmbH & Co. KG	101603	2022-01	2024-01
4.4	Anechoic Chamber 01	SAC/FAR, 10.58 m x 6.38 m x 6.00 m	Frankonia	none		
4.5	Fluke 177	Digital Multimeter 03 (Multimeter)	Fluke Europe B.V.	86670383	2022-06	2024-06
4.6	Opus10 THI (8152.00)	T/H Logger 10	Lufft Mess- und Regeltechnik GmbH	12488	2021-08	2023-08
4.7	EP 1200/B, NA/B1	AC Source, Amplifier with integrated variable Oscillator	Spitzenberger & Spies GmbH & Co. KG	B6278		
4.8	DS 420S	Turn Table 2 m diameter	HD GmbH	420/573/99		
4.9	HFH2-Z2	Loop Antenna + 3 Axis Tripod	Rohde & Schwarz GmbH & Co. KG	829324/006	2021-01	2024-01

5 Radiated Emissions SAC up to 1 GHz  
Radiated emission tests up to 1 GHz in a semi anechoic room

Ref.No.	Device Name	Description	Manufacturer	Serial Number	Last Calibration	Calibration Due
5.1	N5000/NP	Filter for EUT, 2 Lines, 250 V, 16 A	ETS-LINDGREN	241515		
5.2	Opus10 TPR (8253.00)	T/P Logger 13	Lufft Mess- und Regeltechnik GmbH	13936	2021-10	2023-10
5.3	ESW44	EMI Receiver / Spectrum Analyzer	Rohde & Schwarz GmbH & Co. KG	101603	2022-01	2024-01

Ref.No.	Device Name	Description	Manufacturer	Serial Number	Last Calibration	Calibration Due
5.4	Anechoic Chamber 01	SAC/FAR, 10.58 m x 6.38 m x 6.00 m	Frankonia	none		
5.5	HL 562 ULTRALOG	Biconical-log-per antenna (30 MHz - 3 GHz) with HL 562E biconicals	Rohde & Schwarz GmbH & Co. KG	830547/003	2021-09	2024-09
5.6	Fluke 177	Digital Multimeter 03 (Multimeter)	Fluke Europe B.V.	86670383	2022-06	2024-06
5.7	Opus10 THI (8152.00)	T/H Logger 10	Lufft Mess- und Regeltechnik GmbH	12488	2021-08	2023-08
5.8	EP 1200/B, NA/B1	AC Source, Amplifier with integrated variable Oscillator	Spitzenberger & Spies GmbH & Co. KG	B6278		
5.9	DS 420S	Turn Table 2 m diameter	HD GmbH	420/573/99		
5.10	AM 4.0	Antenna Mast 4 m	Maturo GmbH	AM4.0/180/1192 0513		

The calibration interval is the time interval between "Last Calibration" and "Calibration Due"

## 6.2 TEST EQUIPMENT SOFTWARE

<b>Semi-Anechoic Chamber:</b>	
Software	Version
EMC32 Measurement Software	10.60.10
INNCO Mast Controller	1.02.62
MATURO Mast Controller	12.19
MATURO Turn-Table Controller	30.10
<b>Fully-Anechoic Chamber:</b>	
Software	Version
EMC32 Measurement Software	10.60.10
MATURO Turn-Unit Cotrolller	11.10
MATURO Mast Controller	12.10
MATURO Turntable Controller	12.11
<b>Conducted AC Emissions:</b>	
Software	Version
EMC32 Measurement Software	10.60.20

## 7 ANTENNA FACTORS, CABLE LOSS AND SAMPLE CALCULATIONS

This chapter contains the antenna factors with their corresponding path loss of the used measurement path for all antennas as well as the insertion loss of the LISN.

### 7.1 LISN R&S ESH3-Z5 (150 KHZ – 30 MHZ)

Frequency MHz	Corr. dB	LISN insertion loss ESH3- Z5 dB	cable loss (incl. 10 dB atten- uator) dB
0.15	10.1	0.1	10.0
5	10.3	0.1	10.2
7	10.5	0.2	10.3
10	10.5	0.2	10.3
12	10.7	0.3	10.4
14	10.7	0.3	10.4
16	10.8	0.4	10.4
18	10.9	0.4	10.5
20	10.9	0.4	10.5
22	11.1	0.5	10.6
24	11.1	0.5	10.6
26	11.2	0.5	10.7
28	11.2	0.5	10.7
30	11.3	0.5	10.8

#### Sample calculation

$$U_{\text{LISN}} \text{ (dB } \mu\text{V)} = U \text{ (dB } \mu\text{V)} + \text{Corr. (dB)}$$

U = Receiver reading

LISN Insertion loss = Voltage Division Factor of LISN

Corr. = sum of single correction factors of used LISN, cables, switch units (if used)

Linear interpolation will be used for frequencies in between the values in the table.

## 7.2 ANTENNA R&S HFH2-Z2 (9 KHZ – 30 MHZ)

Frequency MHz	AF HFH-Z2) dB (1/m)	Corr. dB	cable loss 1 (inside chamber) dB	cable loss 2 (outside chamber) dB	cable loss 3 (switch unit) dB	cable loss 4 (to receiver) dB	distance corr. (-40 dB/ decade) dB	d <sub>Limit</sub> (meas. distance (limit) m	d <sub>used</sub> (meas. distance (used) m
0.009	20.50	-79.6	0.1	0.1	0.1	0.1	-80	300	3
0.01	20.45	-79.6	0.1	0.1	0.1	0.1	-80	300	3
0.015	20.37	-79.6	0.1	0.1	0.1	0.1	-80	300	3
0.02	20.36	-79.6	0.1	0.1	0.1	0.1	-80	300	3
0.025	20.38	-79.6	0.1	0.1	0.1	0.1	-80	300	3
0.03	20.32	-79.6	0.1	0.1	0.1	0.1	-80	300	3
0.05	20.35	-79.6	0.1	0.1	0.1	0.1	-80	300	3
0.08	20.30	-79.6	0.1	0.1	0.1	0.1	-80	300	3
0.1	20.20	-79.6	0.1	0.1	0.1	0.1	-80	300	3
0.2	20.17	-79.6	0.1	0.1	0.1	0.1	-80	300	3
0.3	20.14	-79.6	0.1	0.1	0.1	0.1	-80	300	3
0.49	20.12	-79.6	0.1	0.1	0.1	0.1	-80	300	3
0.490001	20.12	-39.6	0.1	0.1	0.1	0.1	-40	30	3
0.5	20.11	-39.6	0.1	0.1	0.1	0.1	-40	30	3
0.8	20.10	-39.6	0.1	0.1	0.1	0.1	-40	30	3
1	20.09	-39.6	0.1	0.1	0.1	0.1	-40	30	3
2	20.08	-39.6	0.1	0.1	0.1	0.1	-40	30	3
3	20.06	-39.6	0.1	0.1	0.1	0.1	-40	30	3
4	20.05	-39.5	0.2	0.1	0.1	0.1	-40	30	3
5	20.05	-39.5	0.2	0.1	0.1	0.1	-40	30	3
6	20.02	-39.5	0.2	0.1	0.1	0.1	-40	30	3
8	19.95	-39.5	0.2	0.1	0.1	0.1	-40	30	3
10	19.83	-39.4	0.2	0.1	0.2	0.1	-40	30	3
12	19.71	-39.4	0.2	0.1	0.2	0.1	-40	30	3
14	19.54	-39.4	0.2	0.1	0.2	0.1	-40	30	3
16	19.53	-39.3	0.3	0.1	0.2	0.1	-40	30	3
18	19.50	-39.3	0.3	0.1	0.2	0.1	-40	30	3
20	19.57	-39.3	0.3	0.1	0.2	0.1	-40	30	3
22	19.61	-39.3	0.3	0.1	0.2	0.1	-40	30	3
24	19.61	-39.3	0.3	0.1	0.2	0.1	-40	30	3
26	19.54	-39.3	0.3	0.1	0.2	0.1	-40	30	3
28	19.46	-39.2	0.3	0.1	0.3	0.1	-40	30	3
30	19.73	-39.1	0.4	0.1	0.3	0.1	-40	30	3

### Sample calculation

$$E \text{ (dB } \mu\text{V/m)} = U \text{ (dB } \mu\text{V)} + AF \text{ (dB 1/m)} + Corr. \text{ (dB)}$$

U = Receiver reading

AF = Antenna factor

Corr. = sum of single correction factors of used cables, switch unit, distance correction, amplifier (if applicable)

distance correction =  $-40 * \text{LOG} (d_{\text{Limit}} / d_{\text{used}})$

Linear interpolation will be used for frequencies in between the values in the table.

Table shows an extract of values



### 7.3 ANTENNA R&S HL562 (30 MHZ – 1 GHZ)

( $d_{Limit} = 3\text{ m}$ )

Frequency	AF R&S HL562	Corr.
MHz	dB (1/m)	dB
30	18.6	0.6
50	6.0	0.9
100	9.7	1.2
150	7.9	1.6
200	7.6	1.9
250	9.5	2.1
300	11.0	2.3
350	12.4	2.6
400	13.6	2.9
450	14.7	3.1
500	15.6	3.2
550	16.3	3.5
600	17.2	3.5
650	18.1	3.6
700	18.5	3.6
750	19.1	4.1
800	19.6	4.1
850	20.1	4.4
900	20.8	4.7
950	21.1	4.8
1000	21.6	4.9

cable loss 1 (inside chamber)	cable loss 2 (outside chamber)	cable loss 3 (switch unit)	cable loss 4 (to receiver)	distance corr. (-20 dB/decade)	$d_{Limit}$ (meas. distance (limit))	$d_{used}$ (meas. distance (used))
dB	dB	dB	dB	dB	m	m
0.29	0.04	0.23	0.02	0.0	3	3
0.39	0.09	0.32	0.08	0.0	3	3
0.56	0.14	0.47	0.08	0.0	3	3
0.73	0.20	0.59	0.12	0.0	3	3
0.84	0.21	0.70	0.11	0.0	3	3
0.98	0.24	0.80	0.13	0.0	3	3
1.04	0.26	0.89	0.15	0.0	3	3
1.18	0.31	0.96	0.13	0.0	3	3
1.28	0.35	1.03	0.19	0.0	3	3
1.39	0.38	1.11	0.22	0.0	3	3
1.44	0.39	1.20	0.19	0.0	3	3
1.55	0.46	1.24	0.23	0.0	3	3
1.59	0.43	1.29	0.23	0.0	3	3
1.67	0.34	1.35	0.22	0.0	3	3
1.67	0.42	1.41	0.15	0.0	3	3
1.87	0.54	1.46	0.25	0.0	3	3
1.90	0.46	1.51	0.25	0.0	3	3
1.99	0.60	1.56	0.27	0.0	3	3
2.14	0.60	1.63	0.29	0.0	3	3
2.22	0.60	1.66	0.33	0.0	3	3
2.23	0.61	1.71	0.30	0.0	3	3

( $d_{Limit} = 10\text{ m}$ )

30	18.6	-9.9
50	6.0	-9.6
100	9.7	-9.2
150	7.9	-8.8
200	7.6	-8.6
250	9.5	-8.3
300	11.0	-8.1
350	12.4	-7.9
400	13.6	-7.6
450	14.7	-7.4
500	15.6	-7.2
550	16.3	-7.0
600	17.2	-6.9
650	18.1	-6.9
700	18.5	-6.8
750	19.1	-6.3
800	19.6	-6.3
850	20.1	-6.0
900	20.8	-5.8
950	21.1	-5.6
1000	21.6	-5.6

0.29	0.04	0.23	0.02	-10.5	10	3
0.39	0.09	0.32	0.08	-10.5	10	3
0.56	0.14	0.47	0.08	-10.5	10	3
0.73	0.20	0.59	0.12	-10.5	10	3
0.84	0.21	0.70	0.11	-10.5	10	3
0.98	0.24	0.80	0.13	-10.5	10	3
1.04	0.26	0.89	0.15	-10.5	10	3
1.18	0.31	0.96	0.13	-10.5	10	3
1.28	0.35	1.03	0.19	-10.5	10	3
1.39	0.38	1.11	0.22	-10.5	10	3
1.44	0.39	1.20	0.19	-10.5	10	3
1.55	0.46	1.24	0.23	-10.5	10	3
1.59	0.43	1.29	0.23	-10.5	10	3
1.67	0.34	1.35	0.22	-10.5	10	3
1.67	0.42	1.41	0.15	-10.5	10	3
1.87	0.54	1.46	0.25	-10.5	10	3
1.90	0.46	1.51	0.25	-10.5	10	3
1.99	0.60	1.56	0.27	-10.5	10	3
2.14	0.60	1.63	0.29	-10.5	10	3
2.22	0.60	1.66	0.33	-10.5	10	3
2.23	0.61	1.71	0.30	-10.5	10	3

#### Sample calculation

$$E \text{ (dB } \mu\text{V/m)} = U \text{ (dB } \mu\text{V)} + \text{AF (dB 1/m)} + \text{Corr. (dB)}$$

U = Receiver reading

AF = Antenna factor

Corr. = sum of single correction factors of used cables, switch unit, distance correction, amplifier (if applicable)

distance correction =  $-20 * \text{LOG} (d_{Limit} / d_{used})$

Linear interpolation will be used for frequencies in between the values in the table.

Tables show an extract of values.

### 7.4 ANTENNA R&S HF907 (1 GHZ – 18 GHZ)

Frequency MHz	AF R&S HF907 dB (1/m)	Corr. dB
1000	24.4	-19.4
2000	28.5	-17.4
3000	31.0	-16.1
4000	33.1	-14.7
5000	34.4	-13.7
6000	34.7	-12.7
7000	35.6	-11.0

cable loss 1 (relay + cable inside chamber) dB	cable loss 2 (outside chamber) dB	cable loss 3 (switch unit, atten- uator & pre-amp) dB	cable loss 4 (to receiver) dB
0.99	0.31	-21.51	0.79
1.44	0.44	-20.63	1.38
1.87	0.53	-19.85	1.33
2.41	0.67	-19.13	1.31
2.78	0.86	-18.71	1.40
2.74	0.90	-17.83	1.47
2.82	0.86	-16.19	1.46

Frequency MHz	AF R&S HF907 dB (1/m)	Corr. dB
3000	31.0	-23.4
4000	33.1	-23.3
5000	34.4	-21.7
6000	34.7	-21.2
7000	35.6	-19.8

cable loss 1 (relay inside chamber) dB	cable loss 2 (inside chamber) dB	cable loss 3 (outside chamber) dB	cable loss 4 (switch unit, atten- uator & pre-amp) dB	cable loss 5 (to receiver) dB	used for FCC 15.247
0.47	1.87	0.53	-27.58	1.33	
0.56	2.41	0.67	-28.23	1.31	
0.61	2.78	0.86	-27.35	1.40	
0.58	2.74	0.90	-26.89	1.47	
0.66	2.82	0.86	-25.58	1.46	

Frequency MHz	AF R&S HF907 dB (1/m)	Corr. dB
7000	35.6	-57.3
8000	36.3	-56.3
9000	37.1	-55.3
10000	37.5	-56.2
11000	37.5	-55.3
12000	37.6	-53.7
13000	38.2	-53.5
14000	39.9	-56.3
15000	40.9	-54.1
16000	41.3	-54.1
17000	42.8	-54.4
18000	44.2	-54.7

cable loss 1 (relay inside chamber) dB	cable loss 2 (High Pass) dB	cable loss 3 (pre- amp) dB	cable loss 4 (inside chamber) dB	cable loss 5 (outside chamber) dB	cable loss 6 (to receiver) dB
0.56	1.28	-62.72	2.66	0.94	1.46
0.69	0.71	-61.49	2.84	1.00	1.53
0.68	0.65	-60.80	3.06	1.09	1.60
0.70	0.54	-61.91	3.28	1.20	1.67
0.80	0.61	-61.40	3.43	1.27	1.70
0.84	0.42	-59.70	3.53	1.26	1.73
0.83	0.44	-59.81	3.75	1.32	1.83
0.91	0.53	-63.03	3.91	1.40	1.77
0.98	0.54	-61.05	4.02	1.44	1.83
1.23	0.49	-61.51	4.17	1.51	1.85
1.36	0.76	-62.36	4.34	1.53	2.00
1.70	0.53	-62.88	4.41	1.55	1.91

#### Sample calculation

$$E \text{ (dB } \mu\text{V/m)} = U \text{ (dB } \mu\text{V)} + \text{AF (dB 1/m)} + \text{Corr. (dB)}$$

U = Receiver reading

AF = Antenna factor

Corr. = sum of single correction factors of used cables, switch unit, distance correction, amplifier (if applicable)

Linear interpolation will be used for frequencies in between the values in the table.

Tables show an extract of values.

### 7.5 ANTENNA EMCO 3160-09 (18 GHZ – 26.5 GHZ)

Frequency MHz	AF EMCO 3160-09 dB (1/m)	Corr. dB
18000	40.2	-23.5
18500	40.2	-23.2
19000	40.2	-22.0
19500	40.3	-21.3
20000	40.3	-20.3
20500	40.3	-19.9
21000	40.3	-19.1
21500	40.3	-19.1
22000	40.3	-18.7
22500	40.4	-19.0
23000	40.4	-19.5
23500	40.4	-19.3
24000	40.4	-19.8
24500	40.4	-19.5
25000	40.4	-19.3
25500	40.5	-20.4
26000	40.5	-21.3
26500	40.5	-21.1

cable loss 1 (inside chamber) dB	cable loss 2 (pre- amp) dB	cable loss 3 (inside chamber) dB	cable loss 4 (switch unit) dB	cable loss 5 (to receiver) dB
0.72	-35.85	6.20	2.81	2.65
0.69	-35.71	6.46	2.76	2.59
0.76	-35.44	6.69	3.15	2.79
0.74	-35.07	7.04	3.11	2.91
0.72	-34.49	7.30	3.07	3.05
0.78	-34.46	7.48	3.12	3.15
0.87	-34.07	7.61	3.20	3.33
0.90	-33.96	7.47	3.28	3.19
0.89	-33.57	7.34	3.35	3.28
0.87	-33.66	7.06	3.75	2.94
0.88	-33.75	6.92	3.77	2.70
0.90	-33.35	6.99	3.52	2.66
0.88	-33.99	6.88	3.88	2.58
0.91	-33.89	7.01	3.93	2.51
0.88	-33.00	6.72	3.96	2.14
0.89	-34.07	6.90	3.66	2.22
0.86	-35.11	7.02	3.69	2.28
0.90	-35.20	7.15	3.91	2.36

#### Sample calculation

$$E \text{ (dB } \mu\text{V/m)} = U \text{ (dB } \mu\text{V)} + AF \text{ (dB 1/m)} + Corr. \text{ (dB)}$$

U = Receiver reading

AF = Antenna factor

Corr. = sum of single correction factors of used cables, switch unit, distance correction, amplifier (if applicable)

Linear interpolation will be used for frequencies in between the values in the table.

Table shows an extract of values.

## 7.6 ANTENNA EMCO 3160-10 (26.5 GHZ – 40 GHZ)

Frequency GHz	AF EMCO 3160-10 dB (1/m)	Corr. dB	cable loss 1 (inside chamber) dB	cable loss 2 (outside chamber) dB	cable loss 3 (switch unit) dB	cable loss 4 (to receiver) dB	distance corr. (-20 dB/ decade) dB	d <sub>Limit</sub> (meas. distance (limit) m	d <sub>used</sub> (meas. distance (used) m
26.5	43.4	-11.2	4.4				-9.5	3	1.0
27.0	43.4	-11.2	4.4				-9.5	3	1.0
28.0	43.4	-11.1	4.5				-9.5	3	1.0
29.0	43.5	-11.0	4.6				-9.5	3	1.0
30.0	43.5	-10.9	4.7				-9.5	3	1.0
31.0	43.5	-10.8	4.7				-9.5	3	1.0
32.0	43.5	-10.7	4.8				-9.5	3	1.0
33.0	43.6	-10.7	4.9				-9.5	3	1.0
34.0	43.6	-10.6	5.0				-9.5	3	1.0
35.0	43.6	-10.5	5.1				-9.5	3	1.0
36.0	43.6	-10.4	5.1				-9.5	3	1.0
37.0	43.7	-10.3	5.2				-9.5	3	1.0
38.0	43.7	-10.2	5.3				-9.5	3	1.0
39.0	43.7	-10.2	5.4				-9.5	3	1.0
40.0	43.8	-10.1	5.5				-9.5	3	1.0

### Sample calculation

$E \text{ (dB } \mu\text{V/m)} = U \text{ (dB } \mu\text{V)} + \text{AF (dB 1/m)} + \text{Corr. (dB)}$

U = Receiver reading

AF = Antenna factor

Corr. = sum of single correction factors of used cables, switch unit, distance correction, amplifier (if applicable)

Linear interpolation will be used for frequencies in between the values in the table.

distance correction =  $-20 * \text{LOG} (d_{\text{Limit}} / d_{\text{used}})$

Linear interpolation will be used for frequencies in between the values in the table.

Table shows an extract of values.

## 8 MEASUREMENT UNCERTAINTIES

Test Case	Parameter	Uncertainty
AC Power Line	Power	$\pm 3.4$ dB
Field Strength of spurious radiation	Power	$\pm 5.5$ dB
6 dB / 26 dB / 99% Bandwidth	Power Frequency	$\pm 2.9$ dB $\pm 11.2$ kHz
Conducted Output Power	Power	$\pm 2.2$ dB
Band Edge Compliance	Power Frequency	$\pm 2.2$ dB $\pm 11.2$ kHz
Frequency Stability	Frequency	$\pm 25$ Hz
Power Spectral Density	Power	$\pm 2.2$ dB

The measurement uncertainties for all parameters are calculated with an expansion factor (coverage factor)  $k = 1.96$ . This means, that the true value is in the corresponding interval with a probability of 95 %.

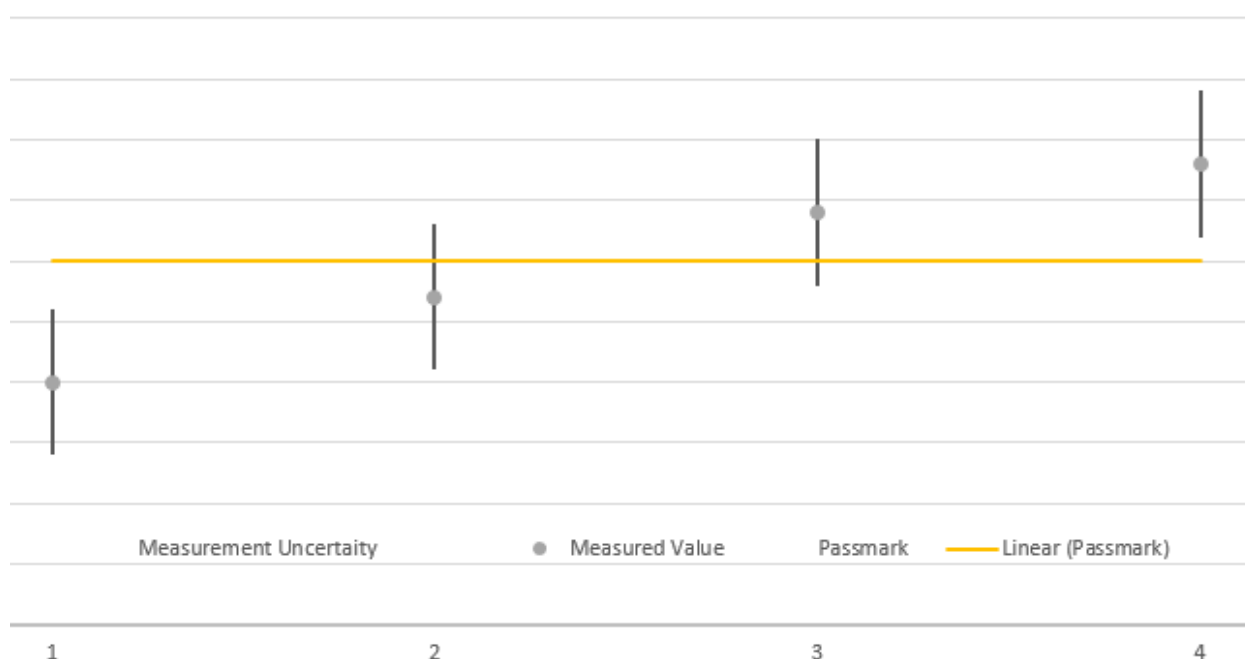

The verdicts in this test report are given according the above diagram:

Case	Measured Value	Uncertainty Range	Verdict
1	below pass mark	below pass mark	Passed
2	below pass mark	within pass mark	Passed
3	above pass mark	within pass mark	Failed
4	above pass mark	above pass mark	Failed

That means, the laboratory applies, as decision rule (see ISO/IEC 17025:2017), the so called shared risk principle.

## 9 PHOTO REPORT

Please see separate photo report.