

SIEMENS

SIMATIC

Industrial PC Tablet SIMATIC ITP1000

Operating Instructions

Preface

Overview

1

Safety notes

2

Commissioning the device

3

Device functions and operating the device

4

Device maintenance and repair

5

Technical specifications

6

Technical Support

A

Labels and symbols

B

Abbreviations

C

Legal information

Warning notice system

This manual contains notices you have to observe in order to ensure your personal safety, as well as to prevent damage to property. The notices referring to your personal safety are highlighted in the manual by a safety alert symbol, notices referring only to property damage have no safety alert symbol. These notices shown below are graded according to the degree of danger.

⚠ DANGER
indicates that death or severe personal injury will result if proper precautions are not taken.
⚠ WARNING
indicates that death or severe personal injury may result if proper precautions are not taken.
⚠ CAUTION
indicates that minor personal injury can result if proper precautions are not taken.
NOTICE
indicates that property damage can result if proper precautions are not taken.

If more than one degree of danger is present, the warning notice representing the highest degree of danger will be used. A notice warning of injury to persons with a safety alert symbol may also include a warning relating to property damage.

Qualified Personnel

The product/system described in this documentation may be operated only by **personnel qualified** for the specific task in accordance with the relevant documentation, in particular its warning notices and safety instructions. Qualified personnel are those who, based on their training and experience, are capable of identifying risks and avoiding potential hazards when working with these products/systems.

Proper use of Siemens products

Note the following:

⚠ WARNING
Siemens products may only be used for the applications described in the catalog and in the relevant technical documentation. If products and components from other manufacturers are used, these must be recommended or approved by Siemens. Proper transport, storage, installation, assembly, commissioning, operation and maintenance are required to ensure that the products operate safely and without any problems. The permissible ambient conditions must be complied with. The information in the relevant documentation must be observed.

Trademarks

All names identified by ® are registered trademarks of Siemens AG. The remaining trademarks in this publication may be trademarks whose use by third parties for their own purposes could violate the rights of the owner.

Disclaimer of Liability

We have reviewed the contents of this publication to ensure consistency with the hardware and software described. Since variance cannot be precluded entirely, we cannot guarantee full consistency. However, the information in this publication is reviewed regularly and any necessary corrections are included in subsequent editions.

Preface

Purpose of this documentation

These operating instructions contain all the information you need for commissioning and operating the SIMATIC ITP1000.

It is intended both for testing/debugging personnel who commission the device and connect it with other units (automation systems, further programming devices), as well as for service and maintenance personnel who install expansions or carry out fault/error analyses.

Validity of this documentation

This documentation applies to all the variants of the SIMATIC ITP1000 and relates to devices supplied as of January 2017.

Position in the information scheme

These operating instructions are available on supplied USB flash drive "Documentation and Drivers".

For supplementary instructions on how to handle the software, please refer to the corresponding manuals.

Conventions

The term "device" is sometimes used to refer to the SIMATIC ITP1000 product in this documentation.

History

Currently released versions of this operating manual:

Issue	Comment
01/2017	First edition

Table of contents

	Preface	3
1	Overview	7
1.1	Product description	7
1.1.1	Overview	7
1.1.2	Application areas	8
1.1.3	Highlights	8
1.1.4	Features	9
1.2	Design of the device	11
1.2.1	Exterior design	11
1.2.1.1	Front.....	11
1.2.1.2	Back	12
1.2.1.3	Top view.....	12
1.2.1.4	Bottom view.....	13
1.2.1.5	Left view	13
1.2.1.6	Right view.....	14
1.2.2	Operator controls	15
1.2.2.1	On/off button	15
1.2.2.2	Buttons	15
1.2.3	Status displays	16
1.3	Layout of the docking station	17
1.4	Accessories.....	19
2	Safety notes	20
2.1	General safety instructions	20
2.2	Safety note on barcode reader and RFID reader	24
2.3	Safety guidelines for transport	24
2.4	Notes about usage.....	25
3	Commissioning the device	26
3.1	Preparations.....	26
3.1.1	Checking delivery.....	26
3.1.2	Noting the device identification data	26
3.2	General information on commissioning	27
3.3	Power supply.....	28
3.3.1	Notes on battery operation.....	28
3.3.2	Connecting the power supply.....	31
3.4	Switching on the unit.....	34
3.5	Operating modes	35
3.6	Connecting peripheral devices.....	36

4	Devise functions and operating the device	38
4.1	Notes on operation.....	38
4.1.1	Operating the device.....	38
4.1.2	Charging the device.....	39
4.1.3	Configuring the device	40
4.1.4	Using barcode reader	40
4.1.5	Use RFID reader.....	42
4.1.6	Using SD cards and multimedia cards.....	42
4.1.7	Using camera.....	43
4.2	Connecting the device to systems and networks	44
4.3	Intel Active Management Technology.....	45
4.4	Trusted Platform Module (TPM)	46
4.5	WLAN and Bluetooth	47
4.5.1	General information about WLAN and Bluetooth	47
4.5.2	Safety notices for WLAN and Bluetooth operation	48
5	Device maintenance and repair	49
5.1	Maintaining and caring for the touch screen.....	49
5.2	Replacement interval	50
5.3	Installing and removing hardware.....	50
5.3.1	Replacing rechargeable battery.....	50
5.3.2	SSD kit.....	52
5.3.3	Change SSD	53
5.3.4	Replacing the backup battery	53
5.4	Reinstalling the software.....	54
5.4.1	Installing drivers and software	54
5.4.2	Reinstalling the operating system.....	55
5.4.3	Restoring the delivery state	56
5.4.4	Updating the operating system	57
5.4.5	Installing Windows 7	58
5.4.6	Setting up partitions in Windows 7.....	60
5.4.7	Setting up the language selection using the Multilanguage User Interface (MUI)	61
5.5	Backing up data	62
5.6	Recycling and disposal	62
6	Technical specifications.....	63
6.1	Certificates and approvals	63
6.2	Directives and declarations.....	64
6.2.1	Guidelines and declarations	64
6.2.2	ESD Guidelines.....	65
6.3	Technical specifications.....	67

6.4	External interfaces	72
6.4.1	DC-In	72
6.4.2	USB 3.0 Type A	72
6.4.3	USB 3.0 Type C	73
6.4.4	RS232 (COM1)	74
6.4.5	Mini DisplayPort	75
6.4.6	RJ45 Ethernet	76
6.4.7	UAJ	76
6.5	System resources	77
6.6	BIOS description	77
6.6.1	Overview	77
6.6.2	Keyboard inputs for the BIOS	78
6.6.3	Opening the BIOS selection menu.....	79
6.6.4	Structure of the BIOS Setup menu	81
6.6.5	Exit menu	82
6.6.6	Default BIOS Setup entries.....	83
6.6.7	BIOS update.....	87
6.6.8	Alarm, error and system messages	89
6.7	Active Management Technology (AMT)	90
6.7.1	Introduction	90
6.7.2	Overview of AMT.....	91
6.7.3	Enabling Intel® AMT / basic configuration.....	91
6.7.4	Reset Intel® AMT to default settings with Un-configure	93
6.7.5	Determining the network address	93
6.7.6	Forcing user consent	94
A	Technical Support.....	95
A.1	Service and support	95
A.2	Troubleshooting	96
A.2.1	General problems	96
A.2.2	Problems with WLAN	97
B	Labels and symbols	98
B.1	Overview	98
B.2	Safety	98
B.3	Operator controls	98
B.4	Certificates, approvals and markings.....	99
B.5	Interfaces	100
C	Abbreviations.....	101
C.1	Abbreviations	101
	Index.....	103

Overview

1.1 Product description

1.1.1 Overview

SIMATIC ITP1000 is a high-performance Tablet PC and specially customized to the requirements of industrial applications.

- High-level performance and high graphics performance
- High functionality
- Extremely robust
- Compact design



1.1.2 Application areas

SIMATIC ITP offers system integrators, plant constructors and integrators of manufacturing plants a Tablet PC platform for high-performance applications and IT applications for:

- Process and visualization applications
- mobile service
- Measuring and test tasks
- Operator control and monitoring
- Quality assurance tasks and monitoring tasks
- Data acquisition and management

SIMATIC ITP has CE certification for use in the industrial sector as well as in residential and commercial areas and small businesses. In addition to the industrial applications, therefore, it can also be used in building automation or in public facilities.

1.1.3 Highlights

- High-performance semi-rugged device
- Functional expansions such as RFID reader, barcode reader, camera
- Freely configurable function keys
- Openness for various applications, such as SIMATIC Runtime software products
- Externally accessible ports such as LAN, serial port, USB type A and type C, MiniDisplay port
- Touch screen with multitouch function
- Continuous running duty up to +45 °C
- Height of fall tested according to MIL810

1.1.4 Features

General features	
Type of construction	Mobile device
Processor	<ul style="list-style-type: none"> Intel® Core™ i5 QuadCore (Skylake H)
RAM	<ul style="list-style-type: none"> 4 GB 8 GB
Graphics	<ul style="list-style-type: none"> Graphic controller: Intel® HD graphics 530 Graphics memory: part of the graphic memory is dynamically shared in the system memory Resolutions/frequencies/colors: according to the setting options of the graphics driver
Display	<ul style="list-style-type: none"> 10.1" (1280 x 800) Multi-touch (capacitive touch screen, PCAP technology)
Power supply	<ul style="list-style-type: none"> 100 to 240 V, wide range Connection of power supply directly to the device or to the docking station
Front keys	<ul style="list-style-type: none"> On/off button Function keys F1 to F6 are freely configurable Home Locking
Status displays on the device (LEDs)	<ul style="list-style-type: none"> Rechargeable battery Operation Mass storage User program Card reader WLAN/Bluetooth
Camera	Full HD, for documentation purposes
Storage media	
SSD	<ul style="list-style-type: none"> SSD, ≥ 256 GB M.2, SATA For information on capacity, refer to the ordering documents
Reader	
Barcode reader	1D/2D barcode scanner
RFID reader	Reading RFID tags
Card reader	<ul style="list-style-type: none"> SD card incl. SC UHS-II Multi Media Card (MMC)

1.1 Product description

General features	
Interfaces	
COM	Serial port RS 232 (COM1)
USB	<ul style="list-style-type: none"> • 2 x USB 3.0 Type A, SuperSpeed • 1 x USB 3.0 Type C
Ethernet	1 x GB Ethernet (RJ45)
WLAN	IEEE 802.11 a/b/g/n
Bluetooth	Bluetooth 4.0
Audio	Universal audio jack (UAJ)
Safety	
TPM	TPM 2.0 module
Anti-theft protection	Kensington lock

Software	
Operating system:	Installed: <ul style="list-style-type: none"> • Windows 7 Ultimate 64-bit, 6 languages German, English, French, Spanish, Italian, Chinese

1.2 Design of the device

1.2.1 Exterior design

1.2.1.1 Front

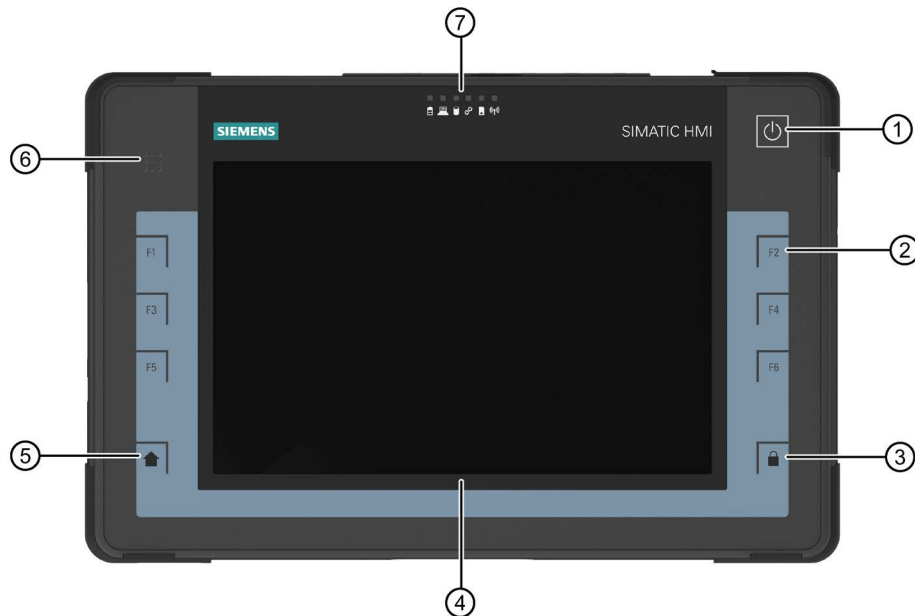

- ① On/off button
- ② Function keys F1 to F6, on left and right
- ③ Locking key
- ④ Display
- ⑤ HOME key
- ⑥ RFID reader (optional)
- ⑦ Status displays

You will find information on the functions of the individual components in the following sections:

- On/off button (Page 15)
- Buttons (Page 15)
- Status displays (Page 16)
- Use RFID reader (Page 42)

1.2.1.2 Back

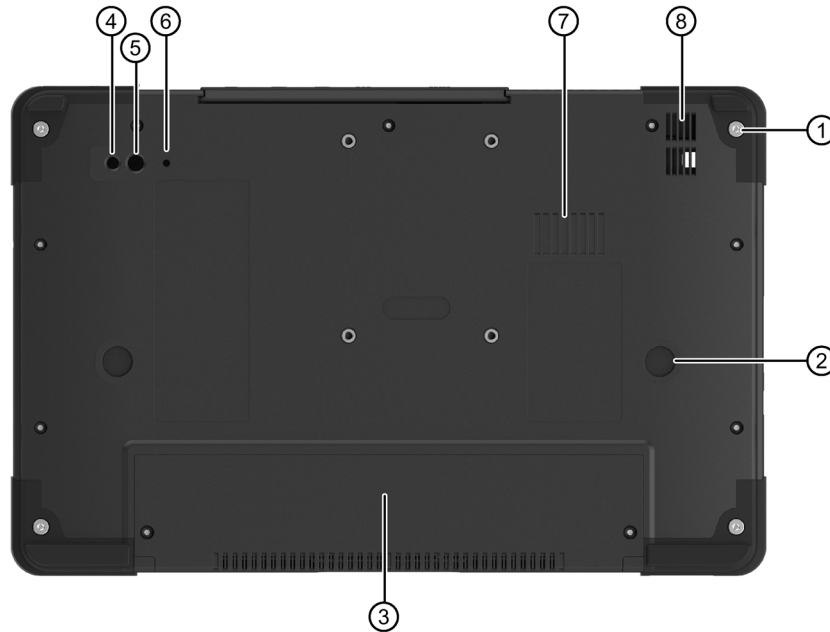

- ① 4 x screws for fastening accessories, for example, carrying strap
- ② 2 x support points for docking station
- ③ Cover for battery
- ④ Lighting / flash for camera
- ⑤ Camera lens (optional)
- ⑥ Camera LED
 - BLUE: Camera active
- ⑦ Ventilation slots
- ⑧ Loudspeaker

1.2.1.3 Top view

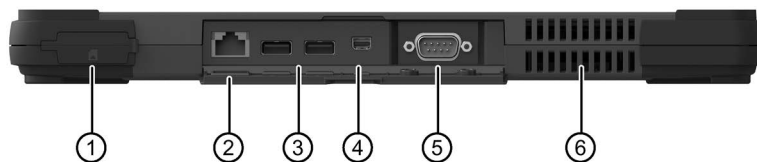

- ① Card reader for:
 - SD card (including SD UHS-II)
 - Multi Media Card (MMC)
- ② Ethernet
- ③ 2 x USB 3.0 Type A
- ④ Mini DisplayPort
- ⑤ RS-232
- ⑥ Ventilation slots

1.2.1.4 Bottom view

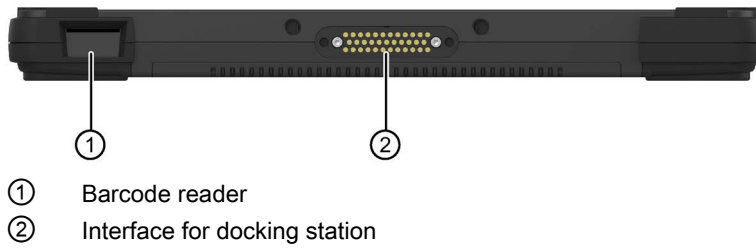

1.2.1.5 Left view

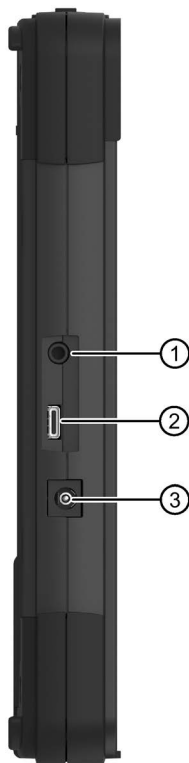

- ① Universal audio jack (UAJ) Connection for audio devices
- ② USB 3.0 Type C
- ③ Socket for connection to the power supply: DC-In 19 V

1.2.1.6 Right view

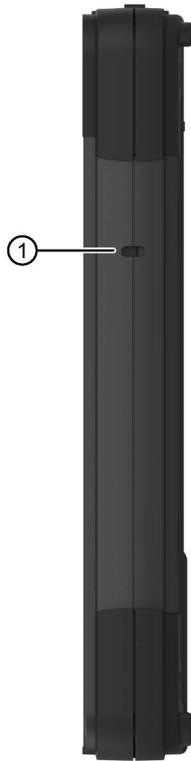

① Opening for Kensington lock

1.2.2 Operator controls

1.2.2.1 On/off button

The on-off button is located on the front of the device, see section "Front (Page 11)".

The on/off button (power) has the following functions:

- Switch device on/off (hold the button down for approximately 1 second; the response depends on the Windows power option settings)
- Switch device off in the event of a fault (hold down for more than 5 seconds)

1.2.2.2 Buttons

The keys are located on the front of the device, see section "Front (Page 11)".

HOME key

- Opens the Windows Start menu
- <Home-Key> + <On-Off-Key>:
Opens the logon mask; corresponds to the shortcut "<Ctrl> + <Alt> + " for PCs

Locking key

- locks the display from inadvertent operation: Unlock by pressing the Locking key again
- Display is dimmed, no input and no display are possible

Function keys



- freely configurable with the SIMATIC IPC Configuration Center
- SIMATIC IPC Configuration Center is pre-installed in delivery condition.
- For more information, refer to SIMATIC IPC Configuration Center in section "Configuring the device (Page 40)".

1.2.3 Status displays

The status displays (LEDs) are located on the front of the device, see section "Front (Page 11)".

System LEDs

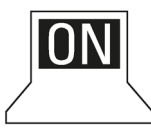
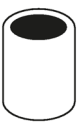
System LEDs indicate various operating states.

Symbol	Meaning	Colors	Meaning of colors
	Rechargeable battery	GREEN ORANGE RED OFF	Battery is charged Battery is being charged. Battery capacity too low (only with battery operation) No battery available
	Operation	GREEN ORANGE GREEN flashing ORANGE flashing OFF	Mains operation Battery operation Mains operations, device is in sleep mode Battery operation, device is in sleep mode Device is switched off
	Mass storage	GREEN	Access to the external memory (hard disk, optical drive)
	User program	RED GREEN	User program inactive Active user program The status display can be controlled from the user program.
	Card reader	GREEN	Card reader for SD cards and multimedia cards is active

Wireless LED

The wireless LED relates both to WLAN and to Bluetooth. You may customize both functions in the corresponding application during installation of the software.

Symbol	Meaning	Colors	Meaning of colors
	WLAN/Bluetooth	ORANGE OFF	Radio connection switched on Radio connection switched off

1.3 Layout of the docking station

Device in docking station



Front view

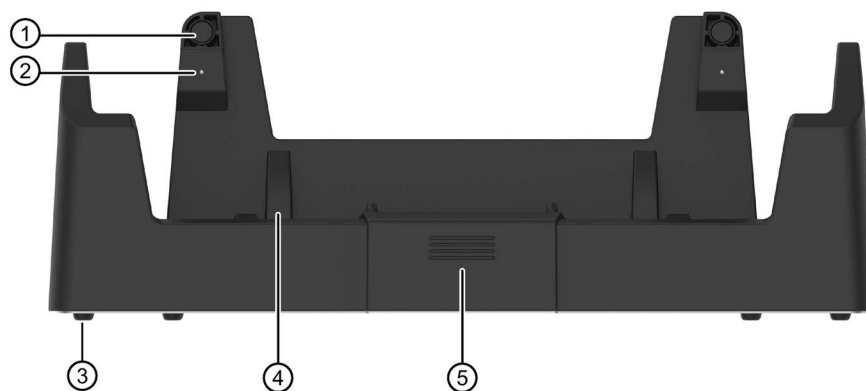

- ① 2 x latching, magnetic
- ② 2 x Docking Detect buttons
- ③ 4 x supporting foot
- ④ 2 x sliding surface for centering the device
- ⑤ Cover for docking connector

Top view



① Docking connector

Connections to the docking station

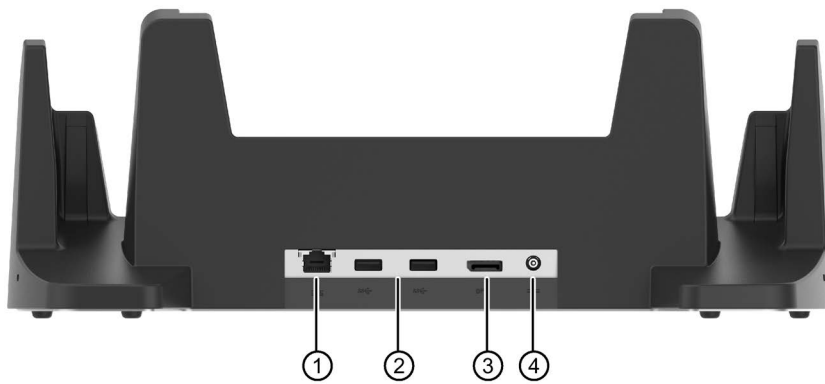

- ① Ethernet
- ② 2 x USB 2.0 Type A
- ③ Display Port
- ④ Socket for connection to the power supply: DC-In 19 V

1.4 Accessories

Accessories which are not included in the scope of delivery are available for your device.

NOTICE

Risk of malfunction or damage to the device

Non-compatible accessories or incorrect replacement part can damage the device and lead to malfunctions.

Use only the supplied accessories and original replacement parts that are ordered via SIEMENS Industry Mall.

You can find information on the Internet at the following address:

- Industry Mall (<https://mall.industry.siemens.com>)
- IPC expansion components (http://www.automation.siemens.com/mcms/pc-based-automation/en/industrial-pc/expansion_components_accessories)

Order accessories and original replacement parts via SIEMENS Industry Mall

1. Navigate to the Internet URL of the Industry Mall (<https://mall.industry.siemens.com>).
2. Log in with your customer data (login on the top right).
3. Select the user language.
4. Navigate to your device in the product catalog (tree structure on the left):
"Automation Engineering > PC-based automation > Industry PC > Tablet PC > ..."
5. In the tree structure on the left, click: SIMATIC ITP1000.
6. Select the "Accessories" tab in the display area.

Safety notes

2.1 General safety instructions

This device is compliant with the relevant safety measures to IEC, EN, VDE, UL, and CSA. You can get information on reliability of use of the device in the intended environment from our Service contact partners.

Use of the device

 CAUTION
Observe safety instructions Please note the legal information at the start of this document You should not expand your device before you have read the relevant safety instructions.

 WARNING
Risk of the device falling If the device falls, because it is accidentally let go, this can lead to personal injury or damage to property. Take suitable precautions to avoid this danger.

 CAUTION
Hazardous emission of light For devices that are equipped with a camera, a camera LED for lighting and the camera's flash are located on the rear of the device (Page 12). The camera LED is assigned to Risk Group 2 according to IEC/EN 62471 and can, if used improperly, damage the eyes. The risk for the user depends on the use of the camera. Do not look directly in the light beam of the camera LED when using the camera. Keep a distance of at least 20 cm between your eyes and the camera LED.

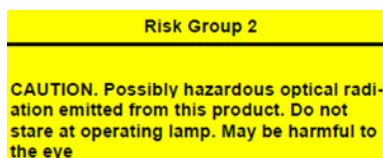

Figure 2-1 Warning notice on the rear of the device.

Repairs

 WARNING**Damage to property and personal injury**

Only qualified personnel are permitted to repair the device.

Unauthorized opening and improper repairs can cause considerable damage to property or danger for the user.

System expansions

 CAUTION**Risk of damage to the system or the plant**

The installation of expansions that are not intended for this device can damage the system and violate the radio-interference suppression regulations.

Only install system expansion devices designed for this device.

Contact your technical support team or where you purchased your PC to find out which system expansion devices may safely be installed.

NOTICE**Warranty**

If you install or exchange system expansions and damage your device, the warranty becomes void.

Battery

This device is equipped with a lithium battery for supplying power to the internal real-time clock. Batteries may only be replaced by qualified personnel.

 CAUTION**Risk of explosion when replacing and disposing of the battery**

There is the risk of an explosion if the battery is not replaced as directed. Replace only with the same type or with an equivalent type recommended by the manufacturer. When disposing of batteries, observe the locally applicable legal regulations.

 WARNING**Risk of explosion and release of harmful substances!**

Do not throw lithium batteries into an open fire, do not solder, or open the cell body, do not short-circuit, or reverse polarity, do not heat up above 100 °C, follow the disposal instructions, and protect against direct exposure to sunlight, humidity, and condensation.

ESD guidelines

Modules containing electrostatic sensitive devices (ESDs) can be identified by the following label:

Strictly follow the guidelines mentioned below when handling modules which are sensitive to ESD:



- Before working with modules containing ESDs, you must discharge all your personal static e.g. by touching a grounded object.
- All devices and tools must be free of static charge.
- Always pull the mains connector and disconnect the battery before you install or remove modules which are sensitive to ESD.
- Handle modules fitted with ESDs by their edges only.
- Do not touch any wiring posts or conductors on modules containing ESDs.

Industrial Security

Siemens provides products and solutions with industrial security functions that support the secure operation of plants, systems, machines and networks.

In order to protect plants, systems, machines and networks against cyber threats, it is necessary to implement – and continuously maintain – a holistic, state-of-the-art industrial security concept. Siemens' products and solutions only form one element of such a concept.

Customer is responsible to prevent unauthorized access to its plants, systems, machines and networks. Systems, machines and components should only be connected to the enterprise network or the internet if and to the extent necessary and with appropriate security measures (e.g. use of firewalls and network segmentation) in place.

Additionally, Siemens' guidance on appropriate security measures should be taken into account. For more information about industrial security, please visit (<http://www.siemens.com/industrialsecurity>).

Siemens' products and solutions undergo continuous development to make them more secure. Siemens strongly recommends to apply product updates as soon as available and to always use the latest product versions. Use of product versions that are no longer supported, and failure to apply latest updates may increase customer's exposure to cyber threats.

To stay informed about product updates, subscribe to the Siemens Industrial Security RSS Feed under (<https://support.industry.siemens.com>).

Disclaimer for third-party software updates

This product includes third-party software. Siemens AG only provides a warranty for updates/patches of the third-party software, if these have been distributed as part of a Siemens software update service contract or officially released by Siemens AG. Otherwise, updates/patches are undertaken at your own risk. You can find more information about our Software Update Service offer on the Internet at Software Update Service (<http://www.automation.siemens.com/mcms/automation-software/en/software-update-service>).

Notes on protecting administrator accounts

A user with administrator privileges has extensive access and manipulation options in the system.

Therefore, ensure there are adequate safeguards for protecting the administrator accounts to prevent unauthorized changes. To do this, use secure passwords and a standard user account for normal operation. Other measures, such as the use of security policies, should be applied as needed.

2.2 Safety note on barcode reader and RFID reader

The barcode reader and RFID reader used are open systems that are freely configurable. Various options are available to increase industrial security. For more information on this, please contact SIEMENS Customized Automation (<http://w3.siemens.com/mcms/human-machine-interface/en/customized-products/Pages/Default.aspx>).

2.3 Safety guidelines for transport

Before you set off

Observe the following information when you are traveling with the device:

- Save important data from the SSD drive.
- For safety reasons, switch off the radio component (WLAN) if you cannot be sure that the transmitted radio waves will not interfere with any electrical or electronic equipment in your vicinity.
- If you want to use your device during a flight, first of all ask the airline company if you are permitted to do so.
- When traveling abroad, ensure the power adapter can be used with the local mains voltage. If this is not the case, you must acquire the appropriate adapter for your device. Do not use any other voltage transformers!

Note

Using the device in different countries

Verify the compatibility of local mains and power cable specifications are compatible when using the PG abroad. If this is not the case, purchase a power cable that complies with the local conditions. Do not use connection adapters for electrical appliances in order to connect the device to them.

Transport

Despite the fact that the device is of a rugged design, its internal components are sensitive to severe vibrations or shock. With just a few simple transport precautions you can help to create a trouble-free operation.

- Switch off the device (see section On/off button (Page 15)).
- Disconnect the peripheral devices from the device.

You should always use the **original packaging** for shipping and transporting the device.

NOTICE
<p>Risk of damage to the device!</p> <p>If you are transporting the device in extreme weather conditions with large fluctuations in temperature, care must be taken to ensure that no moisture forms on or in the device (condensation).</p> <p>If condensation develops, wait at least 12 hours before switching on the device.</p>

2.4 Notes about usage

NOTICE
<p>Possible restricted functions in case of non-validated function of the plant.</p> <p>The device is tested and certified based on the technical standards. In some cases function restrictions can occur during the operation of your plant.</p> <p>To avoid restrictions, validate the correct function of the plant.</p>

Note

Ventilation of the device

The device is cooled through several ventilation slots: Ensure that these ventilation slots are not covered or closed during operation.

Note

Requirements for base on which device is operated

Avoid any damage to the device from scratching or overheating.

Only place the device on a flat, even, clean and hard base.

Commissioning the device

3.1 Preparations

3.1.1 Checking delivery

Unpacking the device

Note the following points when unpacking the device:

- Keep the original packaging of the device in case you have to transport the device again.
- Keep the enclosed documentation in a safe place. It is required for initial commissioning and is part of the device.
- Check the delivery unit for any signs of visible transport damage.
- Check the delivery and your specially ordered accessories against the packaging list to ensure nothing is missing.
- If you determine any transport damage or defects when unpacking the device, notify your local sales outlet.

3.1.2 Noting the device identification data

The device can be clearly identified with the help of the identification data in case of repairs or loss.

The figures below are examples. The data of your device may differ from the data in these examples.

Rating plate

The rating plate is located on the rear of the device.

Example:

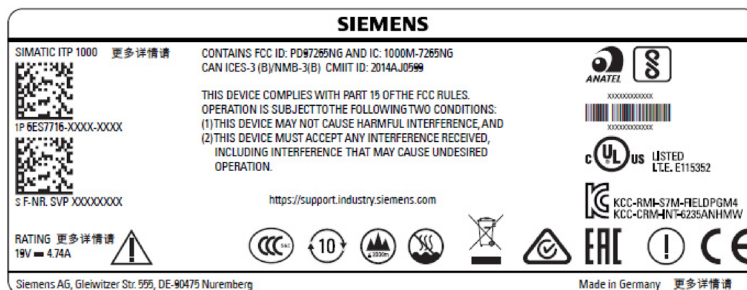

COA label

The COA label is located on the rear of the device.

Note

Only for devices that are delivered with operating system.

The COA label is only found on devices that are delivered with installed operating system.

It is located on the underside of the device.

Example:



Write down identification data

1. Transfer the identification data in the table shown below into the "Value" column.

In the "Source" column you can find information on where you can find the required value.

Identification data	Source	Value
Order number	Rating plate	6AV...
Serial number	Rating plate	S VP...
Product Key (Microsoft Windows Product Key)	COA-label	
Ethernet address 1	See BIOS selection menu > SCU > (Page 79) Menu "Advanced" > "Peripheral Configuration"	

3.2 General information on commissioning

NOTICE

Risk of damage to the device!

Make sufficient allowances for the device to warm up to room temperature before you put it into use. If condensation develops, wait at least 12 hours before switching on the device.

Requirements for commissioning

- The power supply is connected or the battery is fully charged.

3.3 Power supply

3.3.1 Notes on battery operation

Danger notices

 WARNING
Risk of personal injury or damage to property due to improper handling of the battery
A battery can cause burns, it can explode or release toxic substances.
Do not open or damage the battery. Do not expose battery to heat or fire. Keep the battery away from children.

 WARNING
Danger of damage to the device or destruction of the battery
Only use the supplied battery or an original spare part. Information on original spare parts for devices is available in section "Accessories (Page 19)".

Disposal

Lithium ion batteries can be recycled. Their components can be used as raw materials for new batteries or other products. A requirement for effective recycling is the collection of used batteries.

NOTICE
Risk of fire - Hazardous to people and the environment
The improper disposal of batteries may cause fire.
Observe the local regulations for the disposal of recyclable materials.
Dispose of batteries properly.

Battery operation

The battery (lithium ion) enables mobile use of the device, independently of an external power supply. It also protects against data loss in the even of a power failure.

The battery will start charging as soon as the device is connected to the power supply. In doing so, the following conditions are important:

- When the device is switched off the charging process takes around 2 hours.
- When the device is switched on, the duration of the charging process depends strongly on the system load and can lengthen accordingly.
- The charging process is terminated as soon as the battery is fully charged.
- A charged battery will discharge itself during storage (depending on the temperature, and whether or not it is installed) over a few months. It will then have to be recharged.
- The battery charging is terminated when the battery is fully charged or if, for example, the upper temperature limit for charging is exceeded. You can check the battery charge level in Windows.
- At high ambient temperatures the battery is protected against overheating by reducing the charging current. The charging process can hereby extend accordingly.

If, with a connected power supply, the battery LED lights up green, the battery is full and will not be charged any further.

Current consumption in battery operation

You can reduce the off-state battery power consumption of your device to the minimum by disabling the Intel® AMT in the BIOS. As a precaution, you should remove the battery from the device if you are planning on not operating the device for several months. Ideal storage conditions for the battery pack: Ambient temperature of approximately 20 °C and battery charging state of approximately 50%.

Note

The battery pack may be completely or partially discharged (e.g. due to self-discharge) during commissioning. Prior to completion of the discharge, when merely a residual charge is existent, the LED battery in the battery operation lights up red as a warning. End your work and save your data. There are now only a few minutes battery running time left.

Please note that for a complete disconnection from the mains the mains connector must be removed.

Service life of the battery

Due to the technology used, the capacity of the lithium ion battery used in the device reduces with each charge/discharge process. A gradual reduction in capacity also takes place if stored at too high or too low temperatures. The operating times of one battery charge in a network-independent operation can therefore gradually reduce over time.

The battery has a typical life span of c. 300 charges and is therefore designed in such a way that with standard handling within six months after purchase of your device it can still be charged and discharged. A loss of capacity over time is technology-dependent and, as with all manufacturers of comparable devices, it is excluded from the warranty. In the case of a significant drop of efficiency we recommend that you replace the battery. Use only Siemens original spare parts.

You should note the following with regard to the life span of the battery:

- If possible, the battery should always be completely discharged/charged.
- Frequency of use: The more often the battery is used, the faster it reaches the end of its effective life span. A lithium ion battery has a typical life of around 300 charge cycles.

3.3.2 Connecting the power supply

The battery charges as soon as the device is connected to the power supply.

Note

Always operate the device with the battery inserted.

For the proper operation of the device with external power supply, a battery must be also be inserted.

When connecting to the power supply, note the information in the section "Charging the device (Page 39)".

Note

Power supply only with the original power supply unit

Only use the supplied original power supply unit for the power supply of the device. This applies to both the connection to the device and to the connection to the docking station.

It is used to supply power to the device in mains operation with 120 V and 230 V power supply networks.

The setting of the voltage range takes place automatically.

Procedure

1. Insert the supplied power supply cable into the external power supply.
2. Insert the low-voltage connector into the corresponding socket for connection to the power supply on the device or to the docking station.
3. Plug the external power supply into a socket with a grounded protective conductor.

The device is operated with line current. The battery is charged during the operation.

Note

No mobile operation of the device when the power supply is connected

When connected to the power supply, only operate the device on a table or in the docking station, refer to section "Left view (Page 13)".

Note during mains operation

 WARNING
Risk of lightning strikes Lightning may enter the mains cables and data transmission cables and jump to a person. Death, serious injury and burns can be caused by lightning strikes. Take the following precautions: <ul style="list-style-type: none">• Pull out the power plug in good time when a thunderstorm is approaching.• Do not touch mains cables and data transmission cables during a thunderstorm.• Keep a sufficient distance from electric cables, distributors, systems, etc.

 WARNING
Risk of fire and electric shock The On/Off button does not completely isolate the device from the power supply. If the device is switched off with the On/Off button, there is still a risk of electric shock and fire, for example, if the device or the connecting cables are damaged or in the event of improper use. When working on the device or if the device is not used for a long period of time, always disconnect it fully from the power supply. Shut down the operating system and if you are using the device in mains operation, pull out the power plug.

Note before connecting to mains operation

 WARNING
Operation only in grounded power supply systems The device is designed only to be used in grounded power supply systems (TN systems to VDE 0100, part 300, or IEC 60364-3). It must not be used in ungrounded, or impedance-grounded power systems (IT systems).

 WARNING
Danger of damage to the device or destruction of the battery Only use the supplied battery or an original spare part. You can find more information on the original replacement parts of the device in section: "Accessories (Page 19)".

Localized information

For the United States and Canada

For the United States and Canada, a CSA or UL-listed power cord must be used.

The connector must be compliant with NEMA 1-15P (NEMA; National Electrical Manufacturers Association).

- **120 V/240 V supply voltage**

A flexible cable with UL approval and CSA marking must be used. In addition, the cable must exhibit the following properties:

- SPT-2 or SVT with three wires
- At least 18 AWG conductor cross-section (AWG: American Wire Gauge, US standard for cable diameter)
- Max. length of 4.5 m
- Connector 15 A, min. 125 V

For countries other than the USA and Canada

- **230 V supply voltage**

This device is equipped with a safety-tested power cord. If you choose not to use this cable, you must use a flexible cable of the following type: At least 18 AWG (0.82 mm²) conductor cross-section and 15 A/250 V connector. The cable set must conform to the safety regulations of the country in which the devices are installed, and bear the prescribed markings in each case.

3.4 Switching on the unit

The operating system and system software of your device are preinstalled on the hard disk. Following the initial switch on, the operating system is set up automatically on the device.

NOTICE
Faulty installation
If you change the default values in the BIOS setup or if you turn off the device during installation, you disrupt the installation and the operating system is not installed correctly. The operating safety of the device and the plant is at risk.
Do not switch off the device during the entire installation process. Do not change the default values in the BIOS setup.

Initial power on

1. Press the ON/OFF button for approximately 1 second.

The green LED "ON" lights up. The device performs a self-test. The following message is output during the self-test:

`Press Esc for boot options`

2. Wait for the message to disappear. The operating system is started.
3. Follow the instructions on the screen.
4. Type in the Product Key as required.

The product key can be found on the COA label, see section "Noting the device identification data (Page 26)".

Define the language, region and formats for the user account

The menus, dialogs, and keyboard layout are set up in English under Windows. Use the Control Panel to change to another language and keyboard layout.

Select: "Start > Control Panel > Clock, Language, and Region > Regional and Language Options".

- You can make your required changes for the user account in the "Formats", "Location and Keyboards and Languages" tabs.
- You can make changes for the default account in the "Administrative" tab. You copy the settings by clicking the respective button.

Also read the information provided in sections "Setting up the language selection using the Multilanguage User Interface (MUI) (Page 61)" and "Installing Windows 7 (Page 58)".

Result

The device is restarted automatically and the user interface of the respective operating system is displayed.

From now on, after you switch on the PC, the user interface of the operating system is automatically opened when the startup routine is completed.

3.5 Operating modes

In accordance with the settings in the Windows Power Options, the device supports different operating states. You can manually or automatically, after a particular time interval, put the device in the following operating states:

- Switch off screen
- Power-saving mode, depending on the configuration, one of the following power-saving states:
 - Sleep (Save to RAM)
 - Hibernate (Hibernate, Save to Disk)
- On
- Off

Parameterize the possible operating modes of the device to the following actions in the power options:

- Operating the on/off button
- Shutting down the operating system (Windows)
- Inactivity of touch or keyboard and mouse

Reactivating the device after standby or hibernation

In standby mode the corresponding system LED flashes; in hibernation, all the LEDs are switched off. To reactivate the device after these two operating modes, press the on/off button briefly.

Parameterize the change to the different operating states

In Windows you can set parameters for the time interval and the actions for change to a different operating mode in the power options. Select:

- "Control Panel\All Control Panel Items\Power Options".

Before changing the power options, make a note of the factory settings, if necessary.

Note

Deactivate hibernation or standby

By changing the power settings, and by adding extra hardware (such as USB-components) or software to the device, you can modify the operating states so that the device cannot switch to **Hibernation** or **Standby mode**. Even though the screen display is dark, relevant consumers remain switched on in the device.

Operating modes during transportation of the device

Please remember to always shut down the device or set it to Hibernation prior to transporting it. You will recognize these operating states, as all status-LEDs of the device are switched off when power supply is removed. This way you can ensure the device is not switched on and the battery is not unintentionally discharged during transportation.

3.6 Connecting peripheral devices

To be noted before you connect the device

NOTICE
Fault caused by peripheral devices The connection of peripheral devices can cause faults in the device. The result may be personal injury and damage to the machine or plant. Note the following: <ul style="list-style-type: none">• Only connect peripheral devices which are approved for industrial applications in accordance with EN 61000-6-2/IEC 61000-6-2.• Peripheral devices that are incapable of hot-plugging may only be connected after the device has been disconnected from the power supply.• Use high quality connection cables and adapters for the peripheral devices.• Use the shortest possible connection cables for the peripheral devices.
Damage through regenerative feedback <ul style="list-style-type: none">• Regenerative feedback of voltage to ground by a connected or installed component can damage the device.• Connected or built-in peripheral device, for example, a USB drive, must not supply any voltage to the device. Regenerative feedback is generally not permitted.

NOTICE
Observe the documentation of your peripheral devices Strictly adhere to the specifications for peripheral equipment.

 WARNING
Equipotential bonding of the signal cable shields When you connect long signal cables (particularly with connections between buildings), make sure the signal cables are always integrated into the local equipotential bonding system (connecting the cable shielding to the protective conductor).

 WARNING
Inter-building networks Only the LAN interface on the docking station is permitted for inter-building networks.

Location of the connection sockets on the device and on the docking station

You will find information on the connection sockets for peripheral devices in the following sections:

- Design of the device (Page 11)
- Layout of the docking station (Page 17)

Connecting a monitor

You can also use the appropriate adapters to connect monitors with other corresponding interfaces to the DisplayPort connection.

Connecting devices to the USB socket

Connect devices such as drives, mouse, keyboard, printer and USB headsets to the USB sockets.

Connecting audio devices to the UAJ socket

The audio socket on the left-hand side of the device is a so-called UAJ connection (Universal Audio Jack) for a 3.5mm jack.

Depending on the function, a UAJ connector has 2 to 4 contact areas. Depending on their position, they are generally referred to as Tip, Ring 1, Ring 2 and Sleeve.

Depending on the function or standard, the contacts are assigned differently.

The audio controller of the device recognizes the assignment of the contacts of the UAJ connector depending on the connected audio device and is automatically configured.

You can connect the following audio devices to the UAJ connection:

- Audio device with line-out
- Audio device with line-in
- Headphones
- Microphone
- Headset (with headphones and microphone) with the following standards:
 - OMTP: Standard for audio devices from Nokia, etc.
 - CTIA: Standard for audio devices from Apple®

Note

Connection of microphone and headphones with two 3.5mm jacks

An adapter is needed to simultaneously connect a microphone and headphones to a 3.5-mm-jack.

Devise functions and operating the device

4.1 Notes on operation

4.1.1 Operating the device

You can operate the device in the following service positions.

Operating device on table

- Place the device on a flat, even, clean and stable base surface, such as a desk.
- Protect the device adequately against inadvertent falling, i.e. do not place the device over the edge of the surface.
- Make sure that the ventilation slots are not covered.

Operating device in mobile mode

- For mobile use, hold the device on the right- and left-hand sides.
- Make sure that the ventilation slots are not covered.



CAUTION

Risk of damage to the device

Make sure to protect the device from inadvertent falling.

Operating device in docking station

- Place the device in the docking station (Page 17).
- Place the docking station on a stable, flat base, such as a desk.
- Connect the docking station to the power supply. To do so, only use the external power supply unit supplied with the device or an original power supply unit.
- The LAN and USB interfaces on the docking station are only active when the docking station is connected to the external power supply unit.
- Make sure that the devices latches properly into the docking station. This is necessary for the battery to charge during operation of the device in the docking station. You can check the current charging status of the battery using the "Battery" LED.

Remove device from docking station

- Tilt the device slightly forward to release it from the magnetic latching.
- Then remove the device by pulling it upwards.

4.1.2 Charging the device

The battery charges as soon as the device is connected to the power supply.

Adhere to the Notes on power supply (Page 31).

Connect the device to the power supply as soon as the "Battery" LED displays a battery capacity that is too low. You can find additional information in section: "Status displays (Page 16)".

Note

Power supply only with the original power supply unit

Only use the supplied original power supply unit for the power supply of the device. This applies to both the connection to the device and to the connection to the docking station.

It is used to supply power to the device in mains operation with 120 V and 230 V power supply networks.

The setting of the voltage range takes place automatically.

The following methods are available for charging the device:

Charging the device in the docking station

- Connect the external power supply to the docking station.
- Place the device correctly in the docking station, refer to section: "Operating the device (Page 38)".

Charging the device with external power supply unit

- Connect the external power supply unit to the device.
- Operate the device during the charging operation only on a table and not in mobile mode.

4.1.3 Configuring the device

You can configure various functions of the device with the "IPC Configuration Center" software, for example:

- Display brightness
- Key assignment
- Screen saver

Open the IPC Configuration Center

1. Double-click the corresponding icon on your desktop:



Call the documentation on IPC Configuration Center

The can find documentation on the IPC Configuration Center on the supplied USB stick in the "Tablet Drivers and Tools" manual ("itp_tdt_user_manual" file).

4.1.4 Using barcode reader

You can find information on the position of the barcode reader in the section "Front (Page 11)".

The barcode reader is freely configurable.

Technical support is available from SIEMENS Customized Automation (<http://w3.siemens.com/mcms/human-machine-interface/en/customized-products/Pages/Default.aspx>).

Scanning barcode

1. Press and hold down the function key to activate the barcode reader. Refer to the Configuration of the function keys (Page 15).
2. Pass the red LED light (Aiming LED) over the barcode.
3. The barcode is output at the current cursor position of an opened program.

Resetting the barcode reader to delivery state

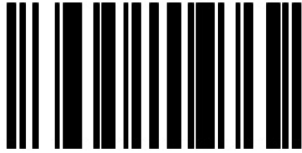

Deactivate parameter scan

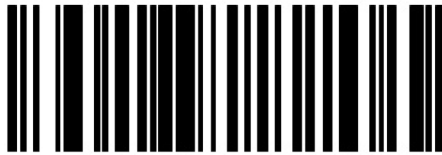

Activate parameter scan

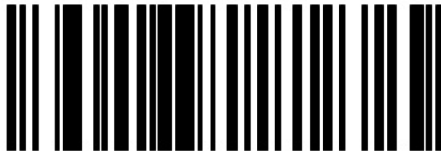

Activate 2 out of 5 interleaved



4.1.5 Use RFID reader

Information about the position of the RFID reader can be found in the section "Front (Page 11)".

The RFID reader is freely configurable.

Technical support is available from SIEMENS Customized Automation (<http://w3.siemens.com/mcms/human-machine-interface/en/customized-products/Pages/Default.aspx>).

Recording RFID tag

1. Press the key to activate the RFID reader Refer to the Configuration of the function keys (Page 15).

The RFID reader is active for 30 seconds after activation.

2. Guide the RFID tag at the RFID reader.
3. The RFID tag is output at the current cursor position of an opened program.

4.1.6 Using SD cards and multimedia cards

You can use the following cards with the Card Reader:

- SD card (including SD UHS-II)
- MMC (Multi Media Card)

Information about the position of the card reader can be found in the section "Front (Page 11)".

The contact areas of the card face downward and point toward the display. When inserting the card, pay attention to the correct positioning of the card.

To remove the card press it lightly towards the device.

The card is operated by a push-push function.

NOTICE
Do not insert or remove cards while in use.
Inserting or removing a card while it is in use could damage it.
The card may not be removed as long the LED is lit, see section "Status displays (Page 16)".
Observe the ESD guidelines (Page 65).

4.1.7 Using camera

Optionally, the device can be ordered with a camera.

Information on the position of the camera lens, the lighting and the LED of the camera can be found in the section "Back (Page 12)".

The camera is operated with the pre-installed YouCam software. You can use to take pictures and record videos. You will find information on the functions and setting options of the camera in the documentation of the YouCam software.

Lighting and flash



CAUTION

Observe safety instructions

The camera LED is assigned to Risk Group 2 according to IEC/EN 62471. Before using the flash and the light, make sure to note the safety instructions in section "General safety instructions (Page 20)".

- The use of the lighting can be configured using the function keys. You can find additional information in section "Buttons (Page 15)" and section "Configuring the device (Page 40)".
- The lighting is active for 30 seconds after activation.
- The quality of the image depends on the local lighting conditions.

4.2 Connecting the device to systems and networks

The following options are available for the integration of the device in existing or planned system environments/networks:

Ethernet

The integrated Ethernet interfaces (10/100/1000 Mbps) can be used for communication and data exchange with programmable controllers.

WLAN

You can link the device to an Industrial Wireless LAN network using the integrated WLAN interface.

Information on Industrial Wireless LAN can be found in SIEMENS Industrial Wireless Communication (<http://www.automation.siemens.com/mcms/automation/en/industrial-communications/iwlan-industrial-wireless-communication>)

Further information

Additional information is available in the catalog and the online ordering system Industry Automation and Drive Technologies - Homepage (<http://www.siemens.com/automation/service&support>).

4.3 Intel Active Management Technology

Intel® Active Management Technology is a technology for remote maintenance of computers (AMT PCs). This remote maintenance encompasses the following functions:

- Remote power management:
AMT PCs can be switched on/off and be restarted from another PC.
- Keyboard–Video–Mouse–Redirection (KVM–Redirection)
Keyboard–Video–Mouse redirection. This enables remote access to the AMT PC, and operation of AMT PCs without functioning operating system.
- BIOS Setup Management
You can start and change the BIOS Setup remotely.
- Remote reboot:
An AMT PC can be booted from a bootable ISO file made available by another PC.
- SOL (Serial over LAN):
You can redirect data of a serial interface to the network. The function is used primarily for text-based remote control of an AMT PC in console mode.
- IDE redirection:
An ISO file contains a memory image of the content of a CD or DVD with ISO 9660 structure. An ISO file can be implemented on the AMT PC for use as virtual DVD drive on the help desk PC.

Configuration of the AMT PC

You configure AMT in the BIOS Setup and MEBx (Management Engine BIOS Extension). MEBx is a BIOS extension for configuring AMT.

Press <ESC> when the BIOS appears briefly during startup and select the BIOS start page MEBx.

Note

Password protection for the AMT PC

AMT enables virtually unrestricted access to the AMT PC. Protect access to the AMT PC by means of password.

4.4 Trusted Platform Module (TPM)

The device features a so-called Trusted Platform Module (TPM) according to standard 2.0. You can enable this module in the **Security** dialog of BIOS-Setup. Follow the instructions of BIOS Setup.

The Trusted Platform Module can be used, for example, in combination with the BitLocker drive encryption under Windows 7 and Windows 10 (available in a later delivery stage). Follow the instructions of the operating system.

Note

Improper usage poses the risk of data loss. Always keep the keys and passwords in a secure place. Encrypted data cannot be retrieved. The Siemens warranty does not cover a hardware reset after loss of the password.

Note

Hotfix required to use TPM 2.0 under Windows 7

When you install TP 2.0 under Windows 7 on your device yourself, note the following:

1. First boot Windows via UEFI.
2. Then install Hotfix KB2920188 from Microsoft.

For additional information, refer to the Internet at Update to add support for TPM 2.0 in Windows 7 (<https://support.microsoft.com/en-us/kb/2920188>).

4.5 WLAN and Bluetooth

4.5.1 General information about WLAN and Bluetooth

The device supports Bluetooth to standard 4.0.

The device is equipped with a network card for Wireless LAN (WLAN), i.e. you are **not** assigned to a cable network.

Depending on the infrastructure and the access rights set by the network administrator, you have exactly the same access to files, the printer and to the Internet with WLAN as with cable network.

Support is provided for the WLAN frequency ranges 2.4 GHz and 5 GHz.

Depending on the surrounding conditions, you can create connections through walls or at distances in the open air of up to 100 m.

The on-board network adapter operates based on the following standards:

- IEEE 802.11 a
- IEEE 802.11 b
- IEEE 802.11 g
- IEEE 802.11 n
- IEEE 802.11 ac

The IEEE standard offers two modes of operation, the ad hoc mode (Peer to Peer) and the infrastructure mode.

Ad hoc mode

The ad hoc network refers to a wireless network that is established directly between several computers, whereby all computers must have a WLAN facility. No additional devices are necessary.

Infrastructure mode

The infrastructure network uses access points to connect computers to wired networks with the aid of WLAN. These can be a local network (e.g. company networks) or a global network (e.g. Internet).

More detailed information on configuring and operating the WLAN can be found in the online help of the WLAN network adapter.

4.5.2 Safety notices for WLAN and Bluetooth operation

- The radio waves necessary for WLAN and Bluetooth can cause interference in hearing aids (unpleasant buzzing) and in the onboard electronics of vehicles. To prevent interference, switch off the device in aircraft, or when driving a vehicle.
- Radio waves caused by WLAN and Bluetooth may lead to malfunctioning of life-support systems. Switch off the WLAN and Bluetooth function if you are in the proximity of such systems, e.g. hospitals, medical electronic systems.
- The range of the wireless connection and the achievable data transmission rate depend on the ambient and environmental conditions.
- A WLAN and Bluetooth connection is not tap-proof. Unauthorized third parties can then receive data.

To protect the transmitted data, WLAN and Bluetooth have different encryption methods. We recommend that you activate an encryption in accordance with your WLAN and Bluetooth environment.

- If possible, do not bring the WLAN and Bluetooth connection in the vicinity of the following devices as the operation of these devices may result in faults or the complete failure of the WLAN and Bluetooth connection:
 - Microwaves
 - Wireless video-audio transmission systems
 - Wireless telephones (DECT)

 CAUTION
Risk of interference with pacemakers The radio waves of WLAN and Bluetooth may interfere with pacemakers. If you wear a pacemaker, keep a minimum distance of 20 cm from the device when WLAN or Bluetooth is activated.

 CAUTION
Danger of explosion The radio waves transmitted by WLAN and Bluetooth may trigger an explosion or fire. Switch off WLAN and Bluetooth of the device if you go in the vicinity of flammable gases or in an explosive environment (e.g. paint shop).

Siemens is not responsible for radio or television interference that has been caused by unauthorized changes to this device. Furthermore, Siemens shall not be held responsible for the use or replacement of connecting cables and devices that have not been recommended by Siemens. The user alone is responsible for remedying faults that have been caused by such an unauthorized change, or for the use or the replacement of the device.

Device maintenance and repair

5.1 Maintaining and caring for the touch screen.

The device is designed for low-maintenance operation. Nevertheless, you should clean the touch screen periodically.

Requirement

- Damp cleaning cloth
- Dishwashing liquid or foaming screen cleaning agent

Procedure

Note**Unintentional response**

If you clean the touch screen when it is switched on, you could cause a malfunction.

Switch off the device or, during ongoing operation, clean the touch screen only when it is in a locked state.

Damage caused by unauthorized cleaning products

Using compressed air or steam cleaners, or aggressive solutions or scouring agents will damage the device.

Do not clean the device with compressed air or steam jets. Do not use aggressive solvents or scouring powder.

Proceed as follows:

1. Switch off the device or disable the touch screen by pressing the locking key, see section "Buttons (Page 15)".
2. Spray the cleaning solution onto a cleaning cloth.
Do not spray directly onto the device.
3. Clean the device.
When cleaning the display wipe from the screen edge inwards.
4. Unlock the touch screen by pressing the Locking key again.

5.2 Replacement interval

To maintain high system availability, we recommend the preventative replacement of those PC components that are subject to wear in accordance with the intervals for replacement indicated in the table below:

Component	Replacement interval
SSD	3 years
Backup battery	5 years

5.3 Installing and removing hardware

5.3.1 Replacing rechargeable battery

⚠ WARNING
Observe the danger notices
Read the notes and information on the proper use and correct disposal of batteries in section "Notes on battery operation (Page 28)".

Requirement

The device is completely isolated from the line voltage.

Torx 8 screwdriver

An original replacement part, refer to section "Accessories (Page 19)".

Procedure

1. Turn the device over so that it is lying on a flat surface.
2. Remove the two screws ① on the underside of the device and store these safely.

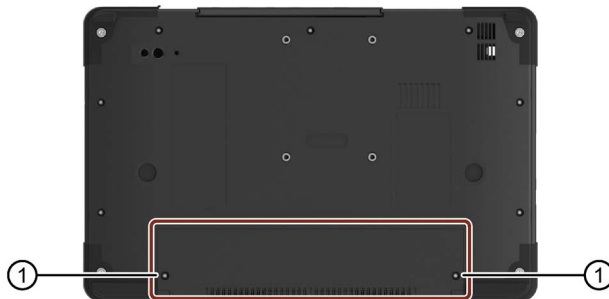

3. Open the battery cover by folding back from edge of device toward middle of device and place the battery cover with the attached battery on a flat surface.
4. Remove the two battery screws ② and store these separately from the two previously removed screws ①.



5. Fasten the new battery with the two battery screws ②.
6. Insert the new battery, as illustrated, obliquely from above ③ and then fold it downward ④.



7. Close the battery cover and fasten it with the two remaining screws ①.

5.3.2 SSD kit

The hard disk kit and SSD kit consist of the hard disk assembly or SSD assembly (see the order documents for details of the capacity of the HDD or SSD), a Torx screwdriver T8, and a transport and storage bag.

Hard disk kits or SSD kits can be ordered under the following order numbers:

- 6ES7791-2BA02-0AA0 (1 TB HDD)
- 6ES7791-2BA22-0AA0 (512 GB SSD)
- 6ES7791-2BA23-0AA0 (1 TB SSD)

SATA to USB 3.0 adapter

With the SATA to USB 3.0 adapter (order no. 6ES7790-1AA01-0AA0), you can easily create an image of your system for backup purposes, or as the basis for system-specific installations.



See also

Accessories (Page 19)

5.3.3 Change SSD

Note

The SSD module should only be exchanged by the SIEMENS Repair Service. You can find information on this on the Internet at: SIEMENS Repair Service (<https://support.industry.siemens.com/cs/ww/en/sc/2154>).

5.3.4 Replacing the backup battery

The device has a backup battery. This supplies the hardware clock with power even when the device has been switched off.

Batteries are subject to wear and tear and should be replaced after five years to make sure that your device works correctly.

Note

The backup battery should only be replaced by the SIEMENS Repair Service. You can find information on this on the Internet at: SIEMENS Repair Service (<https://support.industry.siemens.com/cs/ww/en/sc/2154>).

NOTICE**Risk of damage!**

The lithium battery may only be replaced with an identical battery or with a type recommended by the manufacturer (order no.: A5E00047601).

 WARNING**Danger of explosion and the release of harmful substances!**

Do not throw lithium batteries into an open fire, do not solder, or open the cell body, do not short-circuit, or reverse polarity, do not heat up above 100 °C, follow the disposal instructions, and protect against direct exposure to sunlight, humidity, and condensation.

NOTICE**Danger of explosion**

Batteries must be disposed of in accordance with local regulations.

5.4 Reinstalling the software

5.4.1 Installing drivers and software

Note

In the case of multilingual operating systems (MUI versions), you must set the menus and dialogs and the default language to English (US) in the regional settings before new drivers and operating system updates are installed.

Procedure

1. Connect the supplied USB stick to the USB port.
2. Start the program "START_DocuAndDrivers".
3. Select "Drivers" in the index.
4. Select the device and operating system.
5. Select the required driver.
6. Open the folder with the driver data by clicking on the link next to "Driver path".
7. Start the setup program in this folder.

Note

For a new installation of Windows operating systems, the chipset driver must be installed before all other drivers, if required.

5.4.2 Reinstalling the operating system

If your operating system is not responding correctly, you can reinstall it in one of two ways:

- With the recovery function of the supplied USB stick
- With the restore function of the supplied USB stick

For these functions, set up the USB stick as bootable. For this purpose, "USB Boot" must be set to "enabled" in the BIOS Setup.

Note

To install an operating system in UEFI mode, the USB stick must also be booted in UEFI mode.

In the BIOS selection menu Hotspot-Text, start the Boot Manager, refer to section "Opening the BIOS selection menu (Page 79)".

Recovery function

The supplied USB contains the installation program with tools for configuring the drives and installing the operating system with the supported languages.

The basic language of the installed operating system is English. To add other languages, install these languages from the supplied USB stick at a later time (directory "Languagepacks").

Restore function

If you have ordered a device with operating system, the Restore function is included on the USB stick.

Documentation and drivers

The supplied USB stick contains the directory "DocuAndDrivers". You can find the documentation, hardware drivers and updates here:

In Windows, these contains are available via a menu.

5.4.3 Restoring the delivery state

You can restore the original software using the Restore function. The supplied USB stick contains the necessary images and tools for transferring the software to the SSD of your device.

The following options are available for restoring the delivery state:

- Restore the entire hard SSD with drives C: (system) and D: (Data):

Use the option "Restore the complete hard disk".

NOTICE
Risk of data loss When "Restore entire hard disk" is set, ALL data, user settings, authorizations or license keys will be lost on the entire drive. The drive is restored to the delivery state with the partitions "C:" and "D:".

- Restore drive C: (System). This means that data stored on drive D: (Data) are retained.

Use the option "Restore only system partition".

NOTICE
Risk of data loss If "Restore system partition only" is set all data on drive C: (system partition) will be deleted. All data, user settings and all authorizations or license keys on drive C: are lost! All data on drive C: will be completely deleted, reformatted and overwritten with the original factory software.

Procedure

Note

The "USB Boot" option has to be set to "Enabled" in the BIOS menu "Boot" so that the device can boot from the USB stick.

1. Connect the supplied USB stick with to the device.
2. Reboot the device.
3. Press the <ESC> key or the corresponding function key when the following BIOS message appears, refer to section "Keyboard inputs for the BIOS (Page 78)":

Press Esc for Boot Options

The BIOS selection menu appears when the initialization has been completed.

4. To boot from the USB stick, select the "Boot Manager" in the BIOS selection menu, refer to section "Opening the BIOS selection menu (Page 79)".

5. Select the USB stick in the Boot Manager and confirm your entry.
 - To restore a system which boots in "UEFI" mode, you must also boot the supplied Restore USB stick using UEFI.
 - To boot the Restore USB stick in "UEFI" mode, select the corresponding entry in the Boot Manager.
 - To restore a system which boots in "Legacy" mode, you must also boot the Restore USB stick using Legacy.
 - To boot the Recovery functionality in "Legacy" mode, select the corresponding entry in the Boot Manager.
6. Select the function "Restore" and confirm your selection.
7. Follow the instructions on the screen.

Note

In delivery state, Windows 7 boots in "UEFI" mode.

In delivery state, Windows 10 (available in a later delivery stage) boots in "UEFI" mode.

5.4.4 Updating the operating system

Windows

The latest updates for the Windows operating system are available on the Internet at Microsoft (<http://www.microsoft.com/en-us>) and on the device in the Start menu "Start > All Programs > Windows Update > Check for updates".

Note

Before you install new drivers or operating system updates for Windows MUI versions, configure the regional menu and dialog settings and the default English (US) language.

other operating systems

Contact the corresponding manufacturer.

5.4.5 Installing Windows 7

Note

Specific information on using the Windows operating systems is available on the Internet:

- Microsoft Technet Windows (<http://technet.microsoft.com/windows>)

The respective manuals are not included in the scope of delivery.

Requirement

- USB keyboard
- Supplied USB stick with recovery function

Procedure

Note

The "USB Boot" option has to be set to "Enabled" in the BIOS menu "Boot" so that the device can boot from the USB stick.

1. Connect the USB stick to the device.
2. Reboot the device.
3. Press the <ESC> key or the corresponding function key when the following BIOS message appears, refer to section "Keyboard inputs for the BIOS (Page 78)":

`Press Esc for Boot Options`

The BIOS selection menu appears when the initialization has been completed.

4. To boot from the USB stick, select the Boot Manager.
5. Select the USB stick in the Boot Manager and confirm your entry.
6. Select the "Recovery" function and confirm the selection.
7. Follow the on-screen instructions.

After a few seconds, you will see the "Install Windows" installation program.

NOTICE
Risk of data loss
During the installation of Windows 7, all data, user settings and all authorizations or license keys on drive C: are deleted.
<ul style="list-style-type: none">• Back up all data.• Check the data and time in the BIOS Setup menu "Main" and correct the displayed date and time if required.

"Install Windows" installation program

The language of the installation program and the operating system is preset to English. You can change the language of the operating system after the installation. You can find information on this in section: "Setting up the language selection using the Multilanguage User Interface (MUI) (Page 61)".

Setting up partitions and integrating storage controllers unknown to the operating system

You can set up partitions during the installation process and integrate storage controllers that are unknown to the operating system. To do so, select "Custom (advanced)" when prompted for the installation type in the "Install Windows" installation program.

You can set up partitions during the installation process. The recommended minimum size for Windows 7 system partition varies, depending on the amount of RAM and additional software that you are going to use. For additional information see: "Setting up partitions in Windows 7 (Page 60)".

Information for systems with AHCI controller

Data carrier controllers unknown to the operating system must be made known to the operating system prior to installation in the "Install Windows" installation program.

Requirement

You have copied the relevant controller driver to a USB stick.

Procedure

1. Connect the USB stick with the controller driver to the device.
2. Start the "Install Windows" installation program as described above.
3. Select "Load Drivers" in the Windows installation window.
4. Select the respective driver on the USB stick.

5.4.6 Setting up partitions in Windows 7

You need to reset the partitions after installing a new drive if the partitions are corrupt or if you want to change the layout of the partitions.

Windows 7 partitions, factory setting

The following information applies to data storage media ≥ 100 GB.

In a device configuration with SSD < 200 GB, the "SYSTEM" party has a size of 100 GB.

Partition	Name	Size	File system
First		100 MB	Automatically set up by installation program
Second	SYSTEM	100 GB	NTFS not compressed
Third	DATA	Remainder	NTFS not compressed

Note

If you want to install the operating system on a data medium connected to a storage controller unknown to the operating system, you have to integrate the driver of the storage controller. Integrate this driver before you partition the data medium and before you install the operating system.

1. Make sure that the partition on which you want to install the operating system is large enough and is set up with a NTFS file system.

The recommended minimum size of this partition varies, depending on the operating system, how much RAM you have available and how much additional software you want to use. Information on how the data medium is partitioned in its factory state is available in the tables below.

2. Select the partition on which you want to install the operating system.
3. Click "Next".

Installation is started. The Windows operating system is installed on the data medium.

5.4.7 Setting up the language selection using the Multilanguage User Interface (MUI)

You can set the display of menus, dialogs or other information, such as date and time, to a different language. For this purpose, you can either select one of the preinstalled languages or install a new language package.

The following command sequences are described in English. Depending on the default setting, they can be displayed in another language.

Note

Specific information for setting up the language selection for Windows operating systems is available on the Internet:

- Microsoft Technet Windows (<http://technet.microsoft.com/windows>)

The respective manuals are not included in the scope of delivery.

Procedure

Changing the settings for language, region and formats of a registered user account

1. Choose:
"Start > Control Panel > Region and Language"
2. You can make the desired changes in the "Formats" and "Location und Keyboards and Languages" tabs.

Changing the settings for language, region and formats of the system account and the standard user account

You can change the settings for language, region and formats of the system account (for example, the language in the user login dialog) and the settings of the standard user account (standard setting for new users). The settings of the registered user are copied to the system account and the standard user account for this purpose.

1. Choose:
"Start > Control Panel > Region and Language"
2. You can make the required changes in the "Administrative" tab. You copy the settings by clicking the respective button.

Installing language package

The available language packages are described in the chapter "Features (Page 9)". Some language packages are available on the supplied USB stick under "Recovery" in the "Languagepacks" folder.

Windows 7:

1. Choose:
"Start > Control Panel > Clock, Language, and Region > Regional and Language Options"
2. Select the "Keyboards and Languages" tab.
3. Click the "Install/uninstall languages" button and make the required changes.

The following languages can be installed at a later time

Language	Windows 7
German	X
English	X
French	X
Italian	X
Spanish	X
Chinese (Hong-Kong)	X
Chinese (simplified)	X
Chinese (Taiwan)	X
Japanese	X
Russian	X

5.5 Backing up data

We recommend the software tool **SIMATIC IPC Image & Partition Creator** (as of V3.4) to back up data under Windows. This tool provides convenient and efficient functions for backing up and restoring the full content of memory cards, hard disks and individual partitions (images).

The **SIMATIC IPC Image & Partition Creator** can be ordered using the Siemens online ordering system (<https://mall.industry.siemens.com>). For more information about SIMATIC IPC Image & Partition Creator, refer to its product documentation.

5.6 Recycling and disposal

The devices described in these operating instructions can be recycled thanks to their low level of pollutants. Contact a certified disposal service company for environmentally sound recycling and disposal of your old devices.

Technical specifications

6.1 Certificates and approvals

ISO 9001 certificate

The Siemens quality assurance system for all product creation processes (development, production and sales) meets ISO 9001 requirements.

This has been certified by DQS (the German society for the certification of quality management systems).

Software License Agreement

If devices are supplied with preinstalled software, you must observe the corresponding license agreements.

Certificates for USA and Canada

Product safety.

The following approval is available for the device:



Underwriters Laboratories (UL) according to UL 60950-1 Second Edition and Canadian Standard CAN/CSA-C22.2 No. 60950-1-07 Second Edition.

WLAN

The integrated wireless LAN conforming to IEEE 802.11 a/b/g/n/ac is certified for Europe.

6.2 Directives and declarations

6.2.1 Guidelines and declarations

Notes on the CE mark



The following applies for this SIMATIC product:

RTTE directive

This product is designed for the following applications:

Application	Requirement for	
Industrial applications	EN 61000-6-4	EN 61000-6-2

The devices are compliant with EN 61000-3-2 (Transient currents) and EN 61000-3-3 (Voltage fluctuation and Flicker).

This product meets the requirements of EC directive 1999/5/EC "Radio Equipment and Telecommunications Terminal Equipment - Use of the Radio Spectrum":
EN 300 328 / EN 301 893 / EN 301 489-17 / EN 301 489-1 / EN300330-2

The directive contains the requirements of the Directive of the Council on the Approximation of the Laws of Member States relating to Electromagnetic Compatibility (EMC Directive).

- Safety: see Low voltage directive

Low voltage directive

This product fulfills the Directive 2014/35/EU of the European Parliament and of the Council on the harmonization of the laws of Member States relating to electrical equipment designed for use within certain voltage limits.

Compliance with this directive has been tested to EN 60950-1.

Declaration of conformity

The EC declaration of conformity and the corresponding documentation are made available to authorities in accordance with the EC directives stated above. Your sales representative can provide these on request.

Installation guidelines

The installation guidelines and safety notices specified in the supplied documentation must be adhered to during commissioning and operation.

Connecting peripherals

Noise immunity requirements to EN 61000-6-2 are met if connected peripherals are suitable for industrial applications. Peripheral devices must only be connected using shielded cables.

6.2.2 ESD Guidelines

Definition of ESD

All electronic modules are equipped with large-scale integrated ICs or components. Due to their design, these electronic elements are highly sensitive to overvoltage, and thus to any electrostatic discharge.

The electrostatic sensitive components/modules are commonly referred to as ESD devices. This is also the international abbreviation for such devices.

Electrostatic sensitive modules are identified by the following symbol:



NOTICE

Risk of overvoltage

Modules that are sensitive to electrostatic discharge can be destroyed by voltages well below those that can be perceived by human beings. Such voltages occur if you touch a component or electrical connectors of a module without first discharging the static from your body. The electrostatic discharge current may lead to latent failure of a module, that is, this damage may not be significant immediately, but in operation may cause malfunction.

Electrostatic charging

Anyone who is not connected to the electrical potential of their surroundings can be electrostatically charged.

The figure below shows the maximum electrostatic voltage which may build up on a person coming into contact with the materials indicated. These values correspond to IEC 801-2 specifications.

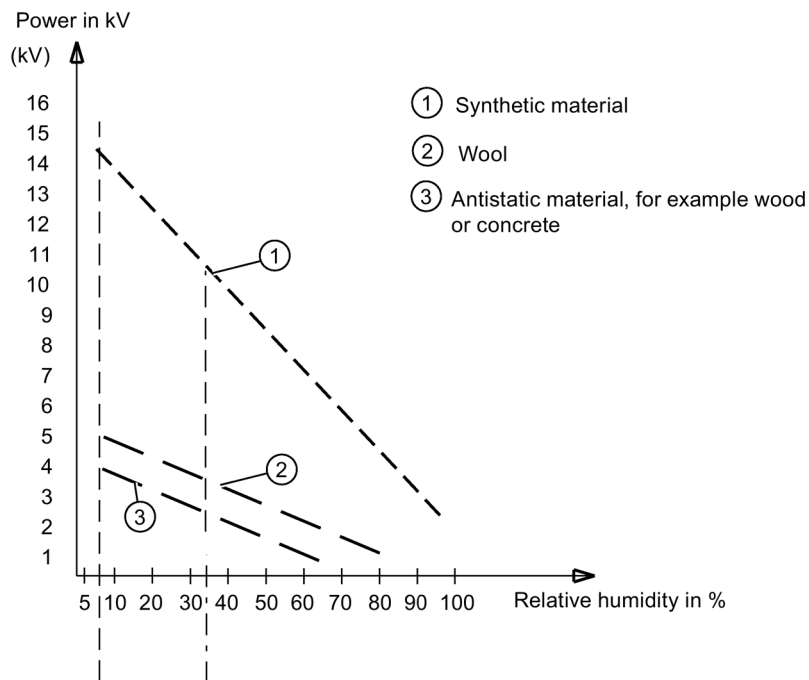

Figure 6-1 Electrostatic voltages which an operator can be subjected to

Basic protective measures against electrostatic discharge

- Ensure correct grounding:
When handling electrostatically sensitive devices, ensure that your body, working environment and any packaging are sufficiently grounded. This prevents electrostatic charge.
- Avoid direct contact:
As a general rule, only touch electrostatically sensitive devices when otherwise unavoidable (e.g. during maintenance work). Handle the modules without touching any chip pins or conductors. In this way, the discharged energy can not affect the sensitive devices.

Discharge your body before you start taking any measurements on a module. Do so by touching grounded metallic parts. Always use grounded measuring instruments.

6.3 Technical specifications

General technical data

Order nos.	see order documents or rating plate
Dimensions	330 x 214 x 32 (W x H x D in mm)
Weight	depending on device configuration: <ul style="list-style-type: none"> • Without battery Approx. 1.4 kg • With battery: Approx. 1.65 kg
Supply voltage (U _N)	100 V to 240 V AC (±10%); sinusoidal
Line voltage frequency	50 - 60 Hz (47 to 63 Hz)
Power consumption AC	Max. 100 W
Output voltage of the power supply unit (DC)	19 V
Output current of the power supply unit (DC)	Max. 4.7 A
Output power of power supply unit (DC)	Max. 90 W
Standby power (in battery operation)	Typically 1.5 W
Lithium ion battery (6 cells) with detection of charging condition)	Approx. 5700 mAh; 11.34 V with thermal switch and multi-fuse; recyclable; chargeable up to 45 °C; high number of cycles for use in harsh environments; low self-discharge
Noise emissions	< 45 dB(A) to DIN 45635
Degree of protection (entire device)	IP 40 (with closed covers) according to IEC 60529

Safety

Protection class	Safety class II according to IEC 61140
Safety specifications	<ul style="list-style-type: none"> • IEC 60950-1/EN 60950-1 • UL 60950-1 Second Edition • CAN/CSA-C22.2 No. 60950-1-07 Second Edition

Electromagnetic compatibility (EMC)

Emitted interference	EN 61000-6-3, EN 61000-3-2 Class D and EN 61000-3-3
Noise immunity: Mains borne disturbance variables on supply lines	± 2 kV; (according to IEC 61000-4-4; Burst) ± 1 kV; (according to IEC 61000-4-5; Surge sym./line to line) ± 2 kV; (according to IEC 61000-4-5; Surge sym./line to earth)
Noise immunity on signal lines	<ul style="list-style-type: none"> • ± 1 kV; (to IEC 61000-4-4; burst; length < 30 m) • ± 2 kV; (to IEC 61000-4-4; burst; length > 30 m) • ± 2 kV; (acc. to IEC 61000-4-5; surge pulse/cable to ground; length > 30 m)
Immunity to discharges of static electricity	± 4 kV, contact discharge (according to IEC 61000-4-2; ESD) ± 8 kV, air discharge (according to IEC 61000-4-2; ESD)
Immunity to RF interference	10 V/m with 80% amplitude modulation at 1 kHz, in accordance with SPH 150 kHz to 80 MHz (to IEC 61000-4-6) 10 V/m with 80 % amplitude modulation with 1kHz, 80 MHz to 1000 MHz (to IEC 61000-4-3) 3 V/m with 80% amplitude modulation at 1 kHz, 1.4 GHz - 2 GHz (acc. to IEC 61000-4-3) 1 V/m, with 80% amplitude modulation at 1 kHz, 2.0 GHz – 2.7 GHz (to IEC 61000-4-3)
Magnetic field	In accordance with SPH 30 A/m, 50 Hz and 60 Hz (acc. to IEC 61000-4-8)

Climatic conditions

Temperature	tested to IEC 60068-2-1, IEC 60068-2-2
During operation	+ 5 °C to + 45 °C max. 10 °C/h (no condensation)
Storage/transport	-20 °C to + 60 °C at max. 20 °C/h (no condensation)
Relative humidity	tested to IEC 60068-2-78, IEC 60068-2-30, IEC 60068-2-14
During operation	5% to 85% at 30°C/h (no condensation)
Storage/transport	5% to 95% at 25°C/h (no condensation)

Mechanical ambient conditions

Vibration	tested to DIN IEC 60068-2-6
Operation	10 to 58 Hz; amplitude 0.0375 mm 58 to 500 Hz; acceleration 4.9 m/s ²
Transport	5 to 9 Hz; amplitude 3.5 mm, 9 to 500 Hz: Acceleration 9.8 m/s ²
Shock	tested in accordance with IEC 60068-2-27
Operation	Half-sine, 50 m/s ² , 30 ms, 100 shocks
Storage/transport	Half-sine, 250 m/s ² , 6 ms, 1000 shocks

Special features

Quality assurance	to ISO 9001
-------------------	-------------

Motherboard

Processor	Processor specifications are listed in your order documents.
RAM	expandable to 16 GB DDR4 SODIMM

Drives

SSD	<ul style="list-style-type: none"> • SSD, ≥ 256 GB • M.2, SATA • For information on capacity, refer to the ordering documents
-----	--

Graphic

Graphic controller	Intel® HD graphics 530
Graphic controller memory	part of the graphic memory is dynamically shared in the system memory
Resolutions/frequencies/colors	according to the setting options of the graphics driver

LCD display

Type	TFT (Thin Film Transistor), 16: 9, anti-reflection
Size	10.1"
Screen resolution	1280 x 800 WXGA
Possible colors	max. 256 K
Vertical frequency	60 Hz
Contrast	> 200 : 1
Brightness	> 220 cd/m ²
Permissible defective areas	light and dark pixel: Max. 10

Audio

Audio controller	Realtek ALC255, UAA-compatible
Internal loudspeaker	max. output power 1 W

WLAN

IEEE 802.11 a/b/g/n and ac

Interfaces on the device

RS232 interface (COM1)	The RS232 interface is integrated in every device by default.
Mini DPP 1.2 (Mini DisplayPort)	Interface for external monitor <ul style="list-style-type: none"> • Monitor according to DP 1.2 standard with HBR2: 3840 x 2160 @ 60 Hz • Monitor according to DP 1.1a standard with HBR: 3840 x 2160 @ 30 Hz 2560 x 1140 @ 60 Hz • Monitor with DVI Single Link 1920 x 1200 @ 60 Hz
USB	<ul style="list-style-type: none"> • 1 x USB 3.0 Type C (left): Max. 1.5 A • 2 x USB 3.0 Type A (top): Max. 0.9 A
Ethernet	1 x Gigabit Ethernet (RJ45)
DC-In	DC power supply input, jack plug
Headphones, microphone, headset	UAJ connection for 3.5mm jack

Interfaces on the docking station

DPP 1.2 (display port) 2 lanes	Interface for external monitor <ul style="list-style-type: none">• Monitor according to DP 1.2 standard with HBR2: 3840 x 2160 @ 30 Hz 2560 x 1140 @ 60 Hz• Monitor according to DP 1.1a standard with HBR: 2560 x 1080 @ 60 Hz 1920 x 1200 @ 60 Hz• no support for DP++
USB	<ul style="list-style-type: none">• 2 x USB 3.0 Type A: Max. 0.9 A
Ethernet	1 x Gigabit Ethernet (RJ45)
DC-In	DC power supply input, jack plug

Card reader

Card reader	Interface for: <ul style="list-style-type: none">• SD card (including SD UHS-II)• Multi Media Cards
-------------	--

Status displays on the device

- Rechargeable battery
- Operation
- Mass storage
- User program
- Card reader
- WLAN/Bluetooth

6.4 External interfaces

6.4.1 DC-In

Power adapter socket. This socket has the following potentials:

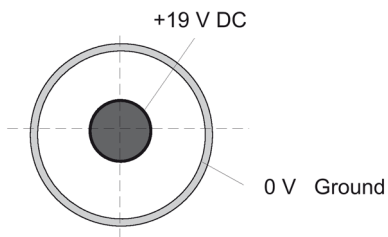

6.4.2 USB 3.0 Type A

Pin no.	Short description	Meaning	Input/output
1	VBUS	+ 5 V (fused) USB 3.0 Type A	Output
2	D-	Data line	Input/output
3	D+	Data line	Input/output
4	GND	Ground	–
5	RX-	Data line	Input
6	RX+	Data line	Input
7	GND	Ground	–
8	TX-	Data line	Output
9	TX+	Data line	Output

6.4.3 USB 3.0 Type C

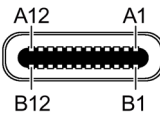

Pin no.	Short description	Meaning	Input/output
A1	GND	Ground	–
A2	TX1+	Data cable (USB 3.0)	Output
A3	TX1-	Data cable (USB 3.0)	Output
A4	VBUS	+ 5 V (fused)	Output
A5	CC1	Configuration channel	Input/output
A6	D+	Data cable (USB 2.0)	Input/output
A7	D-	Data cable (USB 2.0)	Input/output
A8	-	Not used	-
A9	VBUS	+ 5 V (fused)	Output
A10	RX2-	Data cable (USB 3.0)	Input
A11	RX2+	Data cable (USB 3.0)	Input
A12	GND	Ground	-
B1	GND	Ground	-
B2	TX2+	Data cable (USB 3.0)	Output
B3	TX2-	Data cable (USB 3.0)	Output
B4	VBUS	+ 5 V (fused)	Output
B5	VCONN	Configuration channel	Input/output
B6	D+	Data cable (USB 2.0)	Input/output
B7	D-	Data cable (USB 2.0)	Input/output
B8	-	Not used	-
B9	VBUS	+ 5 V (fused)	Output
B10	RX1-	Data cable (USB 3.0)	Input
B11	RX1+	Data cable (USB 3.0)	Input
B12	GND	Ground	-

6.4.4 RS232 (COM1)

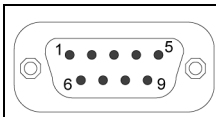

Pin no.	Short description	Meaning	Input / output
1	DCD	Data carrier detect	Input
2	RxD	Received data	Input
3	TxD	Transmit data	Output
4	DTR	Data terminal ready	Output
5	GND	Ground	-
6	DSR	Ready for operation	Input
7	RTS	Request to send	Output
8	CTS	Clear to send	Input
9	RI	Incoming call	Input

6.4.5 Mini DisplayPort

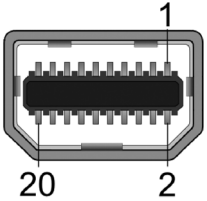

Pin no.	Short description	Meaning	Input/output
1	ML_Lane0+	DP data 0+	Output
2	GND	Ground	-
3	ML_Lane0-	DP data 0-	Output
4	ML_Lane1+	DP data 1+	Output
5	GND	Ground	-
6	ML_Lane1-	DP data 1-	Output
7	ML_Lane2+	DP data 2+	Output
8	GND	Ground	-
9	ML_Lane2-	DP data 2-	Output
10	ML_Lane3+	DP data 3+	Output
11	GND	Ground	-
12	ML_Lane3-	DP data 3-	Output
13	CONFIG1 CAD	Cable Adapter Detect	Input
14	CONFIG2	Ground (pull-down)	-
15	AUX_CH+	Auxiliary channel+	Bi-directional
16	GND	Ground	-
17	AUX_CH-	Auxiliary channel-	Bi-directional
18	HPD	Hot Plug Detect	Input
19	GND	Ground	-
20	DP_PWR	+3.3V (fused)	Output

6.4.6 RJ45 Ethernet

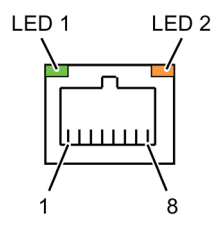

Pin no.	Short description	Meaning	Input/output
1	BI_DA+	Bi-directional data A+	Input/output
2	BI_DA-	Bi-directional data A-	Input/output
3	BI_DB+	Bi-directional data B+	Input/output
4	BI_DC+	Bi-directional data C+	Input/output
5	BI_DC-	Bi-directional data C-	Input/output
6	BI_DB-	Bi-directional data B-	Input/output
7	BI_DD+	Bi-directional data D+	Input/output
8	BI_DD-	Bi-directional data D-	Input/output
S		Shielding	-
	LED 1	OFF Lights up green Lights up orange	10 Mbps 100 Mbps 1 Gbps
	LED 2	Lights up green Flashes green	Connection is up indicates activity

6.4.7 UAJ

You can connect various audio devices to the UAJ connection (Universal Audio Jack). The audio controller socket recognizes the pin assignment of the connector, depending on the connected audio device. Information on connecting the audio devices can be found in section "Connecting peripheral devices (Page 36)".

The pins of a 3.5 mm jack are assigned as follows depending on the audio device:

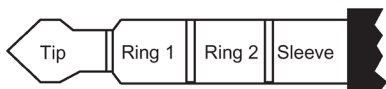

	Tip	Ring 1	Ring 2	Sleeve
Headphone out (stereo)	L	R	-	GND
Line out (stereo)	L	R	-	GND
Line in (stereo)	L	R	-	GND
Microphone in (mono)	MIC	-	-	GND
Headset (OMTP)	L	R	MIC	GND
Headset (CTIA)	L	R	GND	MIC

6.5 System resources

Currently allocated system resources

All system resources (hardware addresses, memory configuration, allocation of interrupts, DMA channels) are assigned dynamically by the Windows OS, depending on the hardware configuration, drivers and connected external devices.

You can in each case view information on the current configuration of system resources or any existing conflicts with the installed operating system as follows:

Windows 7 **Start** > Enter "cmd" in the search function, then enter "msinfo32" in the input box.

Windows 10 (in a later delivery stage)

6.6 BIOS description

6.6.1 Overview

Parameterize your device in the BIOS Setup.

BIOS Setup program

The BIOS Setup program, or BIOS Setup for short, is located, together with the setup parameters, in a FLASH block on the motherboard.

Change the setup parameters of the device in the BIOS Setup, e.g. system time or boot sequence.

Changing the device configuration

Your device configuration is preset for operating with the included software. You should only change the default setup parameters if technical modifications to your device require different parameters.

Note

Documentation

BIOS Setup is described for all devices and device configurations. Some BIOS submenus or Setup parameters may not be included, depending on your order. The interface of your BIOS Setup can deviate from the figures in this document.

You can find a detailed description of the BIOS on the Support website under Entry ID: 92189178 (<http://support.automation.siemens.com/WW/view/en/92189178>).

6.6.2 Keyboard inputs for the BIOS

Keyboard inputs are required to call and operate the BIOS. Use an externally connected USB keyboard or the function key on the front of the device for this purpose. These function keys are assigned as followed in the BIOS selection menu and in the BIOS Setup menu when the device starts:

Function	Key on the front of the device
ESC	F1
Enter	F2
Up arrow	F3
Right arrow	F4
Down arrow	F5
Left arrow	F6

See also

Buttons (Page 15)

6.6.3 Opening the BIOS selection menu

Procedure

Note

Key inputs without external keyboard

If you have not connected any external keyboard to your device, you can use the keys on the front of the device.

You can find information on which keys on the front of the device are to be pressed instead of the keyboard keys in the section "Keyboard inputs for the BIOS (Page 78)".

1. Reset the device (warm or cold restart).

Depending on the device version, the default settings can differ from the figures shown.

The following message appears briefly on the display at the end of the self-test:

Press ESC for boot options

2. Press <ESC> to open the BIOS selection menu:



The following keys are available in the BIOS selection menu:

Buttons	Function
Continue	Exit selection menu, continue start sequence
Boot Manager	Specify the boot media from which to boot: <ul style="list-style-type: none"> • Hard disk drive • USB drive (USB boot = enabled)
Device Management	Start device manager for UEFI boot media
Boot From File	Boot Maintenance Manager: <ul style="list-style-type: none"> • Boot Options: Set boot order • Driver Options: Configure drivers • Console Options: Configure connected input device • Boot from File: Start from an ".EFI" file • Reset System: Restoring factory settings
Secure Boot Option ¹	Configuration settings to start the device in Secure Boot mode. The only software modules loaded are those that are known to be safe for the BIOS or the operating system.
SCU	Start BIOS Setup via Setup Configuration Utility
BIOS Update	Update BIOS from USB flash drive
MEBx	Intel Management Engine AMT configuration

¹ Available as of Windows 8 or later

6.6.4 Structure of the BIOS Setup menu

The individual setup parameters are distributed between different menus and submenus. Not all menus are included in each supplied device configuration. The following table shows the menus.

Menu	Meaning
Main	Display system information, for example, BIOS version, processor and memory
Advanced	Configure hardware using different submenus
Security	Security functions, e.g., setting a password
Power	Specify CPU settings and switch-on functions.
Boot	Determine boot options, e.g., boot order
Exit	Save and exit (see Exit menu)

The menus always have the same structure. The figure below shows an example for the "Main" menu. Device-specific information is shown blurred.

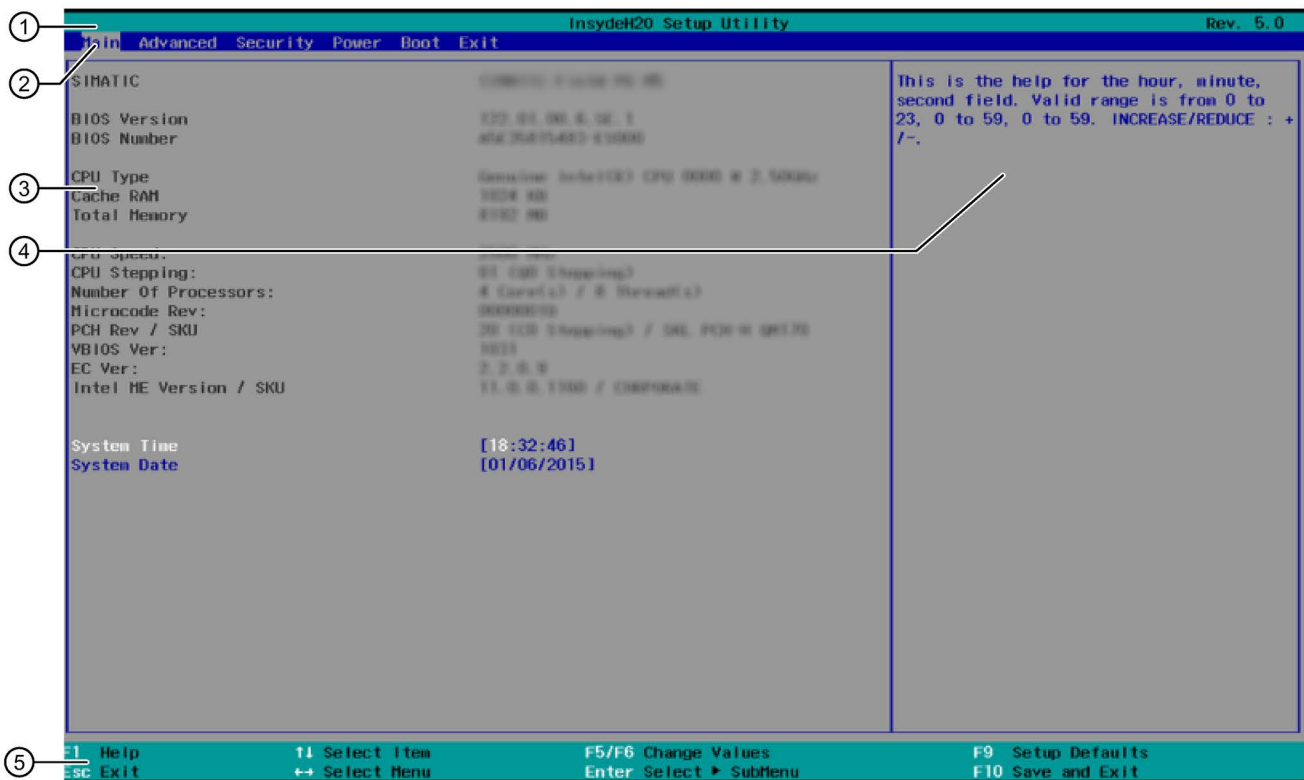

- ① Header
The current version of the selected BIOS Setup is displayed in the header.
- ② Menu bar
Switch between the various menus "Main", "Advanced", etc. in the menu bar at the top.
- ③ Settings, submenus and device-specific information
Information about your device is displayed in the center left-hand area; here you can edit settings which are partly in submenus.

- ④ Help area Short help texts on the currently selected setup parameters are displayed in the center right-hand area.
- ⑤ Key assignment The key assignment for navigation in the BIOS Setup is found in the footer.

6.6.5 Exit menu

You always exit BIOS Setup in this menu.

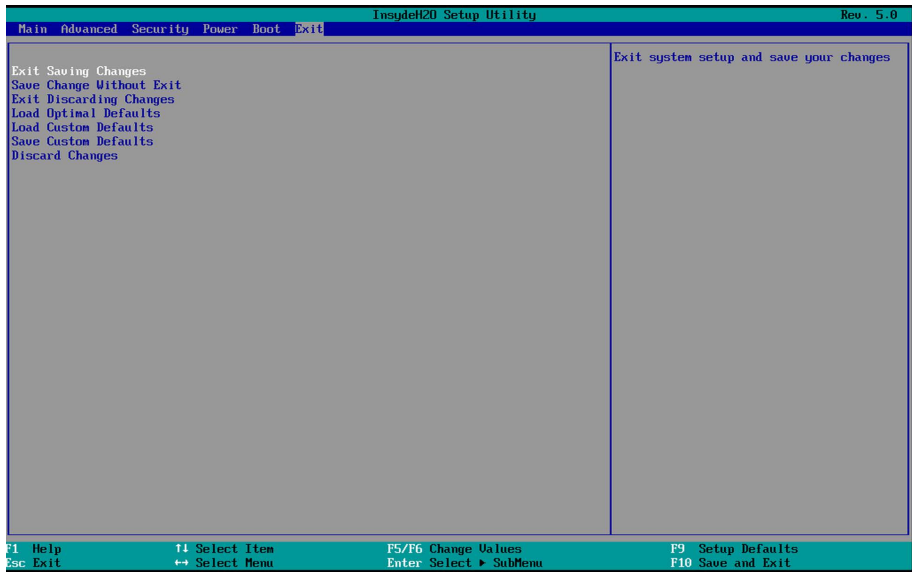

Exit Saving Changes	All changes are saved and the system is restarted with the new Setup parameters.
Save Change Without Exit	All changes are saved
Exit Discarding Changes	All changes are discarded and the system is restarted with the old Setup parameters.
Load Optimal Defaults	All setup parameters are reset to the safe default values. Notice: The existing Setup parameters are overwritten by this.
Load Custom Defaults	The profile must be loaded with the custom Setup parameters. Requirement: The parameters are saved prior to this with "Save Custom Defaults".
Save Custom Defaults	The currently configured Setup parameters are saved as a custom profile (see also "Load Custom Defaults").
Discard Changes	All changes are discarded.

6.6.6 Default BIOS Setup entries

Documenting your device configuration

If you have changed any default settings in Setup, you can enter them in the following table. You can then refer to these entries for any future hardware modifications.

Note

Print out the table below and keep the pages in a safe place once you have made your entries.

Main

System parameters	Defaults	Custom entries
System Time	hh:mm:sss	
System Date	MM/TT/JJJJ	

Advanced

System parameters	Defaults	Custom entries
HPET- HPET Support	Enabled	

Advanced > Boot Configuration

System parameters	Defaults	Custom entries
NumLock	On	
POST Errors	All without keyboard	

Advanced > Peripheral Configuration

System parameters	Defaults	Custom entries
Internal COM 1	Enabled	
Onboard Ethernet 1	Enabled	
Onboard Ethernet 1 Address	00:1B:1B:41:42:7B (example)	
WLAN	Last State	
Audio	Enabled	
SD-Card	Enabled	
USB-C: Left side	Enabled	
USB-A: Top side right	Enabled	
USB-A: Top side left	Enabled	
Camera	Enabled	
Barcode Imager	Enabled	
RFID	Enabled	

Advanced > SATA Configuration

System parameters	Defaults	Custom entries
Serial ATA Port 0	[Micron_M600_MTFDDAV128MBF] (example)	

Advanced > System Agent (SA) Configuration

System parameters	Defaults	Custom entries
SA PCIe Code Version	1.9.0.0 (Example)	
VT-d	Enabled	

Advanced > Active Management Technology Support

System parameters	Defaults	Custom entries
Intel AMT Support	Disabled	
Intel AMT Setup Prompt	Enabled	
MEBx Selection Screen	Disabled	
Un-Configure ME	Disabled	
Intel AMT Configuration Screens	Enabled	
USB Configure	Disabled	
Intel AMT Password Write	Enabled	
USB Configure	Disabled	
PET Progress	Enabled	
Intel AMT SPI Protected	Disabled	

Advanced > CPU Control

System parameters	Defaults	Custom entries
SW Guard Extensions (SGX)	Software Controlled	
Select Owner EPOCH input type	No change in Owner EPOCHs	
Intel (VMX) Virtualization Technology	Enabled	
Active Processor Cores	All	
Hyper-Threading	Enabled	
AES	Enabled	
Intel® SpeedStep™	Enabled	
Intel® Speed Shift Technology	Enabled	
Turbo Mode	Enabled	
C state	Enabled	

Security

System parameters	Defaults	Custom entries
TPM Operation	No Operation	
Supervisor Password	Not Installed	
User Password	Not Installed	

Power > CPU Configuration

System parameters	Defaults	Custom entries
SW Guard Extensions (SGX)	Software Controlled	
Select Owner EPOCH input type	No Change in Owner EPOCHs	
Intel (VMX) Virtualization Technology	Enabled	
Active Processor Cores	All	
Hyper-Threading	Enabled	
AES	Enabled	

Power > Power & Performance > CPU - Power Management Control

System parameters	Defaults	Custom entries
Intel (R) SpeedStep (tm)	Enabled	
Intel (R) Speed Shift Technology	Disabled	

Boot

System parameters	Defaults	Custom entries
Boot Type	Dual Boot Type	
Quick Boot	Enabled	
Quiet Boot	Enabled	
PXE Boot / Network Stack	Disabled	
PXE Boot capability	Disabled	
Add Boot Options	Auto	
USB Boot	Enabled	
EFI Device First	Enabled	
Timeout	[0]	

Boot > Boot Device Priority

System parameters	Defaults	Custom entries
Normal Boot Menu	Normal	

Boot > Boot Type Order

System parameters	Defaults	Custom entries
Hard Disk Drive	Micron_M600_MTFDDAV128MBF (example)	
USB	SIEMENS USB-FD 4	

6.6.7 BIOS update

Check regularly if updates are available for download to your device.

You can find additional information on the Internet at the following address: Auto-Hotspot.

Noting down and restoring BIOS Setup settings

NOTICE
<p>Irretrievable loss of data</p> <p>All BIOS Setup settings are deleted after the BIOS update. This can put the system in an undefined state. This may damage the device and the plant.</p> <ol style="list-style-type: none"> 1. Print out the table in the next section "General BIOS Setup settings". 2. Enter your specific BIOS Setup setting in this table before you run a BIOS update. 3. Start BIOS Setup after the BIOS update. 4. Load the BIOS Setup default settings with <F9> "Setup Defaults". Or use the BIOS Setup command "Load Optimal Defaults" in the "Exit" menu. 5. Make your own Setup settings based on the table you have printed out. 6. Save the BIOS Setup settings with <F10> "Save and Exit".

Performing a BIOS update

NOTICE
<p>Damage to the device</p> <p>If you switch off the device during the update, the BIOS will be incomplete and corrupt. This may result in malfunctions.</p> <p>Leave the device switched on during the update.</p>

If you have purchased a new BIOS update for your device, follow these steps to install the update:

1. Connect the device to the power supply.
2. Copy the update to a USB flash drive.
3. Reset the device (warm or cold restart).
4. The following message appears briefly on the display at the end of the self-test:

Press ESC for boot options

If you are using an external keyboard, press the <ESC> key or the corresponding key for the "ESC" function on the front side of the device, see section "Keyboard inputs for the BIOS (Page 78)".

6.6 BIOS description

5. Click the "BIOS Update" button.
6. Follow the instructions on the screen.

Note

Starting a BIOS update

The "Y" key must be pressed in order to start a BIOS update. This command is not assigned to any function key.

To start a BIOS update, connect an external keyboard.

Reboots

There may be several reboots after a BIOS update. These reboots are initiated by the Management Engine (ME). The reboots are required by the ME to adapt itself to the changes of the BIOS update.

See also

After Sales Information System (<http://www.siemens.com/asis>)

6.6.8 Alarm, error and system messages

During startup (the boot process), the BIOS first performs a **Power On Self Test (POST)** and checks whether certain functional units of the PC are operating error-free. The boot sequence is immediately interrupted if critical errors occur.

BIOS initializes and tests further functional units if the POST does not return any errors. In this startup phase, the graphics controller is initialized and any error messages are output to the screen.

The error messages output by system BIOS are listed below. For information on error messages output by the operating system or application programs, refer to the corresponding manuals.

On-screen error messages

On-screen error message	Meaning / tip
Operating system not found	Possible causes: <ul style="list-style-type: none"> • No operating system installed • Incorrect active boot partition • Wrong boot drive settings in SETUP
Keyboard controller error	Controller error. Contact your technical support team.
SMART failure detected on HDD	Hard disk reports pending failure through S.M.A.R.T.
CMOS battery failed	CMOS battery is not connected.
CMOS battery weak	CMOS battery is weak
Real-time clock has lost power	The CMOS clock was operated without battery or with a battery that was too weak, during battery change, for example. Check the CMOS clock.
Keyboard error	Function keys are defective
PLD configuration failed	Programming of the PLC on the motherboard has failed.

6.7 Active Management Technology (AMT)

6.7.1 Introduction

Intel® Active Management Technology (Intel® AMT) is an Intel technology for the remote maintenance of SIMATIC Industrial PCs (IPCs) with AMT technology using a management PC. It is not necessary to install an operating system on the SIMATIC IPC with Intel® AMT. Intel® AMT provides numerous functions, e.g.:

- **Keyboard Video Mouse (KVM) Redirection**

KVM connections are always possible using the KVM server that is integrated in the firmware. KVM enables access to IPCs with a corrupted or no operating system as the KVM server is integrated in the AMT hardware. KVM enables you to reboot a remote computer and make changes to its BIOS settings.

- **Remote power management**

SIMATIC IPC with Intel® AMT can be switched on and off or restarted using another PC.

- **IDE redirection**

An image on the management PC can be integrated and used on the SIMATIC IPC with Intel® AMT both as a CD/DVD drive and as a floppy drive. If the image is bootable, you can also boot the SIMATIC IPC with Intel® AMT from it.

The following figure shows remote maintenance of SIMATIC IPCs with Intel® AMT, e.g. for troubleshooting a corrupt operating system or incorrect BIOS settings:

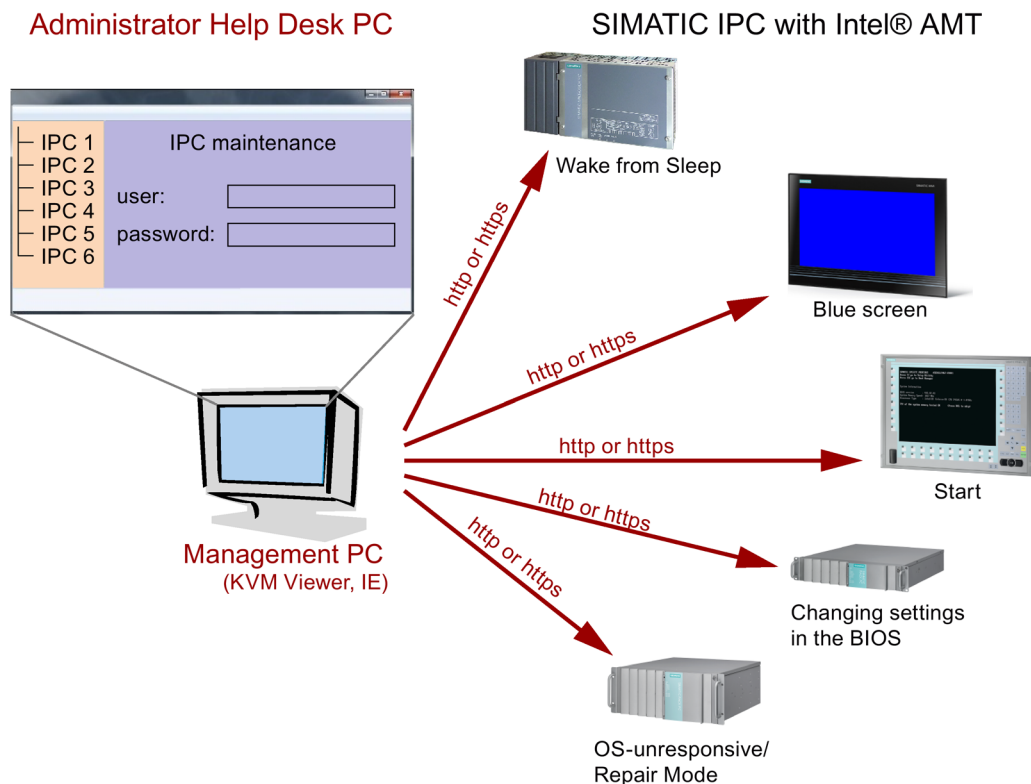

6.7.2 Overview of AMT

This section describes the required measures and settings on the local IPC so that the IPC can be controlled and maintained remotely from a management station known below as the help desk PC.

The local IPC is known below as the "AMT PC".

The sections contain the following information:

- AMT settings in the MEBx and in the BIOS setup
- Basic configuration of AMT
- Further useful notes

6.7.3 Enabling Intel® AMT / basic configuration

For security reasons, Intel® AMT is not enabled on new devices. The Management Engine (ME) is always active.

Procedure

For devices IPCxxxD, IPCxxxG, IPCxxxE, Field PG M4, Field PG M5, ITP:

1. If necessary, first reset Intel® AMT to the default status.
2. To open the BIOS selection menu, press the <ESC> key while the device is booting.
3. Open the BIOS Setup using the "Setup Configuration Utility (SCU)".
4. Select the "Active Management Technology Support" command in the Advanced menu.
Only for the devices IPC547D, IPC547E and IPC547G: Select "AMT Configuration".
5. Activate the option "Intel AMT Support".
6. Only for the devices IPC547D, IPC547E and IPC547G: Select the "Normal" setting for "MEBx Mode".
7. Exit the BIOS Setup with <F10> key (Save and Exit).

Only for the devices IPC547D, IPC547E and IPC547G: Exit the BIOS Setup with <F4> key.

Settings in the MEBx

1. To open the BIOS selection menu, press the <ESC> key while the device is booting.
2. Use the arrow keys to select "MEBx" and confirm with the <Enter> key.
3. Select "MEBx Login".

4. Enter the default password "admin".

Change the password. The new password must comprise:

- At least eight characters
- An upper case letter
- A lower case letter
- A number
- A special character (! @ # \$ % ^ & *)
- The underscore "_" and space characters are valid in the string but do not increase the complexity of the password.

Note

If the password is no longer available, you must reset the Intel® AMT to the default settings (Page 93).

Backup the password to protect it against loss.

5. Switch to the "Intel (R) AMT Configuration" submenu and enable "Manageability Feature Selection".
6. Switch to the "Intel(R) ME General Settings" submenu and enable access via the network with "Activate Network Access".
7. Confirm the dialogs that appear with "Y".

Drivers are automatically installed once with the Windows system start in the subsequent restart.

6.7.4 Reset Intel® AMT to default settings with Un-configure

If Intel® AMT was already configured, it is advisable to reset Intel® AMT to default settings. On reset to default settings Intel® AMT is deactivated, among others.

You can skip this item if the device is still in factory state.

Note

All previous settings in the management engine MEBx are deleted.

Correct operation in the plant may be at risk.

Note down all the settings in the MEBx. Make the settings again as necessary following Unconfigure.

1. Enable the "Unconfigure ME" entry in "Advanced > Active Management Technology Support" in the BIOS.
2. Exit the BIOS with the <F10> key "Save and Exit". The AMT PC restarts.
3. After the restart, a user prompt appears asking whether you really want to discard all the settings in the management engine:

```
Intel(R) Management Engine BIOS Extension v6.1.0.0005
Copyright(C) 2003-10 Intel Corporation. All Rights Reserved.

Found unconfigure of Intel(R) ME
Continue with unconfiguration (Y/N)
```

4. Confirm with "Y". On a German keyboard, this means pressing the <Z> key. The device continues to boot with the factory settings of the management engine.

6.7.5 Determining the network address

To connect the AMT PC with the AMT server, the network address that uniquely localizes the AMT server on the AMT PC must be entered.

If DHCP is set for the automatic assignment of the network address in "Network Setup" in the MEBx of the AMT PC, the network address is not fixed.

Procedure

If the AMT server uses the same network address as the operating system of the AMT PC (most common situation):

1. You can obtain the address of the AMT server in the command line in Windows using "ipconfig" and in UNIX using "ifconfig".

If the AMT server and operating system do not use the same network address, ask your network administrator for the address you have been assigned.

6.7.6 Forcing user consent

When a connection to the AMT PC is established, the KVM viewer may prompt the user to enter a six-figure code. This code is displayed on the screen of the AMT PC. The user of the AMT PC must inform the user of the KVM viewer of this code.

This code query needs to be set up on the KVM viewer.

Procedure

1. Select "Intel(R) AMT Configuration > User Consent" in the MEBx.
2. Select the value "KVM" for "User Consent".

To allow a user with administrator privileges to avoid this code query, follow these steps:

1. Select "Intel(R) AMT Configuration > User Consent" in the MEBx.
2. Select "Opt-in Configurable from Remote IT".

Technical Support

A.1 Service and support

You can find additional information and support for the products described on the Internet at the following addresses:

- Technical support (<https://support.industry.siemens.com>)
- Support request form (<http://www.siemens.com/automation/support-request>)
- After Sales Information System SIMATIC IPC/PG (<http://www.siemens.com/asis>)
- SIMATIC Documentation Collection (<http://www.siemens.com/simatic-tech-doku-portal>)
- Your local representative
(<http://www.automation.siemens.com/mcms/aspa-db/en/Pages/default.aspx>)
- Training center (<http://sitrain.automation.siemens.com/sitrainworld/?AppLang=en>)
- Industry Mall (<https://mall.industry.siemens.com>)

When contacting your local representative or Technical Support, please have the following information at hand:

- MLFB of the device
- BIOS version for industrial PC or image version of the device
- Other installed hardware
- Other installed software

Tools & downloads

Please check regularly if updates and hotfixes are available for download to your device. The download area is available on the Internet at the following link:

After Sales Information System SIMATIC IPC/PG (<http://www.siemens.com/asis>)

A.2 Troubleshooting

A.2.1 General problems

This chapter provides you with tips on how to locate and troubleshoot common problems.

Problem	Possible cause	To correct or avoid error
The device is not operational.	There is no power supply to the device.	Check the power supply, the power cord or the power plug.
	Device is switched off	Press the power button
	The battery is empty or not installed	Charge or install battery.
Wrong time and/or date on the device.		<ol style="list-style-type: none"> 1. Press <ESC> during the boot sequence to open BIOS-Setup. 2. Set the time and date in the setup menu.
Although the BIOS setting is OK, the time and data are still wrong.	The backup battery is dead.	In this case, please contact your technical support team.
USB device not responding.	The operating system does not support the USB ports.	Enable USB Legacy Support for the mouse and keyboard. For all other devices you will need USB drivers for the specific operating system.
A beep sounds when a key is pressed but no character is displayed	Keyboard buffer is full	<CTRL> <PAUSE>

A.2.2 Problems with WLAN

The following lists the possible causes for problems with Wireless LAN:

Cannot connect with WLAN

- Check that you have enabled the WLAN.
- Check that the other WLAN partner is active.
- Check the WLAN connection settings
Observe the corresponding notes on WLAN configuration and operation in the Online Help of the WLAN adapter.

Data transmission speed is too low

- Please note that the data rate stipulated and visible under Windows is only a theoretical value / corresponds to the gross value. Determined by the transmission procedure, the actual applicable data rate for the data transmission is usually around 50% of the gross value.
- The maximum data transmission speed depends on many factors.
Start by verifying that the transmission mode of all network components is set up in accordance with the IEEE 802.11 a/b/g/n or ac standard.
- The spatial arrangement of the network components can also negatively influence the transmission.
 - The distances between the components should be as short as possible.
 - Masonry or reinforced concrete walls have a negative effect on the transmission performance and can, under some circumstances, prevent a connection from being established. For the best performance, a line-of-sight connection of the network components is preferred.
 - A high load on the network, perhaps from too many simultaneous access attempts from different nodes, can lead to lower data rates or communication problems.









Labels and symbols

B.1 Overview



The following tables show all the symbols which may be found on your SIMATIC industrial PC, SIMATIC industrial monitor or SIMATIC Field PG in addition to the symbols which are explained in the operating instructions.

The symbols on your device may vary in some details from the symbols shown in the following tables.

B.2 Safety



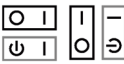







Symbol	Meaning		Symbol	Meaning
	Warning, observe the supplied documentation.			Lock is closed
	Attention, radio equipment			Lock is open
	Disconnect the power plug before opening			Opening for Kensington lock
	Attention ESD (Electrostatic sensitive device)			Warning of hot surface

B.3 Operator controls

















Symbol	Meaning		Symbol	Meaning
	On/off switch, without electrical isolation			Eject CD/DVD
	On/off switch, without electrical isolation			

B.4 Certificates, approvals and markings

The following table shows symbols relating to certificates, approvals and markings which may be on the device. You can find more information in the operating instructions for your device:

Symbol	Meaning	Symbol	Meaning
	Approved for Australia and New Zealand		Marking for the Eurasian Customs Union
	Approved for China		Test mark of Factory Mutual Research
	CE markings for European countries		Marking of Federal Communications Commission for the USA
	EFUP (Environment Friendly Use Period) marking for China		Approved for Korea
	Test mark of the Underwriters Laboratories		Disposal information, observe the local regulations.

B.5 Interfaces

Symbol	Meaning	Symbol	Meaning
	Connection to the power supply		PS/2 mouse interface
	Protective conductor terminal		PS/2 keyboard-interface
	Connection for functional earthing (equipotential bonding line)		Multimedia Card Reader
DPP	DisplayPort interface		Smart Card Reader
	DVI-D interface		Line In
LAN	LAN interface, not approved for connecting WAN or telephone		Line Out
	Serial port		Microphone input
	USB port		Universal Audio Jack
	USB 2.0 high-speed port		Headphone output
	USB 3.0 super-speed port		

Abbreviations

C.1 Abbreviations

Abbreviation	Term	Meaning
AC	Alternating current	Alternating current
AMT	Active Management Technology	Technology from Intel® that permits the diagnostics, management and remote control of PCs
AWG	American Wire Gauge	US standard for the cable diameter
BIOS	Basic Input Output System	Basic Input Output System
CAN	Controller Area Network	
CE	Communauté Européenne (CE symbol)	The product is in conformance with all applicable EC directives
CMOS	Complementary Metal Oxide Semiconductors	Complementary metal oxide semiconductors
COA	Certificate of authentication	Microsoft Windows Product Key
COM	Communications Port	Term for the serial interface
CPU	Central Processing Unit	CPU
CSA	Canadian Standards Association	Canadian organization for tests and certifications according to own or binational standards (with UL / USA) standards
CTS	Clear To Send	Clear to send
DC	Direct Current	DC current
DCD	Data Carrier Detect	Data carrier signal detection
DPP	Display Port	High-performance digital monitor interface
DQS	Deutsche Gesellschaft zur Zertifizierung von Qualitätsmanagement mBH	
DSR	Data Set Ready	Ready for operation
DTR	Data Terminal Ready	Data terminal is ready
ESD	Components sensitive to electrostatic charge	
EN	European standard	
GND	Ground	Chassis ground
IDE	Integrated Device Electronics	
IEC	International Electrotechnical Commission	
IP	Ingress Protection	Degree of protection
LAN	Local Area Network	Computer network that is limited to a local area.
LCD	Liquid Crystal Display	Liquid crystal display
LEDs	Light Emitting Diode	Light emitting diode
MLFB	Machine-readable product designation	Order number
MMC	Multi Media Card	Memory card of the format 32 mm x 24.5 mm

Abbreviations

C.1 Abbreviations

Abbreviation	Term	Meaning
MUI	Multilanguage User Interface	Language localization in Windows
NEMA	National Electrical Manufacturers Association	Syndicate of manufacturers of electrical components in the USA
PCAP	Projected capacitive touch screen technology	Technology for touch screen fronts. The touch screen with PCAP features a rugged, smooth glass front that is especially suited for in industrial environments. Advantages of this glass front are, for example, glare suppression, EM- or UV-shielding glasses, vision protection when viewed from the side
PXE	Preboot Execution Environment	Software for running new PCs without hard disk data via the network
RFID	Radio Frequency Identification	
RI	Ring Input	Incoming call
RTS	Reliable Transfer Service	Request to send
RxD	Receive Data	Data transfer signal
SATA	Serial Advanced Technology Attachment	
SMART	Self Monitoring Analysis and Reporting Technology	Hard disk error diagnostics program
SSD	Solid State Drive	Storage medium (not volatile)
S VP	Serial number of the device	
TFT	Thin-Film-Transistor	Type of LCD flat-screen
TTY	Tele Type	Asynchronous data transfer
TxD	Transmit Data	Data transfer signal
UL	Underwriters Laboratories Inc.	US organization for tests and certifications according to own or binational standards (with CSA / Canada) standards
V.24		ITU-T standardized recommendation for data transfer via serial ports
VDE	Verein deutscher Elektrotechniker (Union of German Electrical Engineers)	
VT	Virtualization Technology	Intel technology with which a virtually closed environment can be made available.
VT-D	Virtualization Technology for Directed I/O	Enables the direct assignment of a device (e.g. network adapter) to a virtual device.
WLAN	Wireless LAN	Wireless local area network

Index

2

2 from 5 interleaved, (Using barcode reader)

A

Abbreviations, 101

Ad hoc mode, 47

AHCI controller, (Data storage medium controller)

Approvals, 63

Audio device

connecting to a UAJ socket, 37

AWG, 33

B

Backup battery, (Battery)

Changing, 53

Barcode reader

Reset, 41

using, 40

Battery, 21

Changing, 53

BIOS Setup, 77

Defaults, 83

Exit menu, 82

Menu layout, 81

Boot sequence, 89

Buttons

Function keys, 15

HOME key, 15

Locking key, 15

C

Card reader

Multi Media Card, 42

SD card, 42

Care, 49

Certificates, 63

Cleaning product, 49

COA label, 27

COM1

Pin assignment of the interface, 74

COM1 port, 70

Configuration, (IPC Configuration Center)

Connecting, 32

Peripheral equipment, 36

Connecting an audio device

to the USB socket, 37

Creating an image, 62

D

Data backup, 62, 62

Data exchange, 44

Data storage medium controller

Making known to the operating system, 59

DC-In

Potentials, 72

Declarations of Conformity, 64

Degree of protection, 67

Delivery

Check, 26

Delivery state

Restore, 56

Device configuration, 83

Diagnostics

Error Messages, 89

Troubleshooting, 96

Dimensions, 67

Display port interface

Technical specifications of interface, 71

docking station

Operating device in docking, 38

Remove device from docking station, 38

DocuAndDrivers, 55

Documentation, (DocuAndDrivers)

Driver, (DocuAndDrivers)

E

Electrostatic sensitive devices, 22

Error messages

Troubleshooting, 96

ESD directives, 65

ESD guidelines, 22

Ethernet

Connection at device, 12

Connection to docking station, 18

Pin assignment of the interface, 76

Technical specifications of interface, 70, 71

Ethernet address, 27
 Ethernet interface, 10, 44

F

Function keys, (Pos.)
 Description, 15

G

Guidelines
 ESD directives, 65

H

Hard disk assembly, 52
 Hard disk kit
 Order number, 52
 Headphones, (Audio device)
 Headset, (Audio device)
 Hibernate, (Sleep mode), (Sleep mode)
 HOME key
 Description, 15
 Pos., 11

I

Identification data, 27
 Image & Partition Creator, 62
 Industrial WLAN, 44
 Infrastructure mode, 47
 Installing
 Windows, 58
 Installing language package, (MUI)
 Integration
 RJ45 Ethernet, 44
 Interfaces
 COM1, pin assignment, 74
 DC-In 19 V, 13, 18
 DC-In, potentials, 72
 Ethernet, 12, 18
 Mini DisplayPort, 12, 18
 Mini DisplayPort, pin assignment, 75
 RJ45 Ethernet, 44
 RS 232, pin assignment, 74
 RS-232, 12
 UAJ, 13
 UAJ, in assignment of the audio jack, 76
 USB 3.0 Type A, 12, 18
 USB 3.0 Type A, pin assignment, 72

USB 3.0 Type C, 13
 USB 3.0 Type C, pin assignment, 73
 USB Ethernet, pin assignment, 76
 USB RJ45, pin assignment, 76

IPC Configuration Center
 Documentation, 40
 Opening, 40
 IT communication, 44

L

License key, 56
 Lithium battery, (Battery)
 Localized information, 33
 Locking key
 Description, 15
 Pos., 11
 Loudspeaker, 12
 Low voltage directive, 64

M

Maintenance, 49
 Messages
 On the screen, 89
 Microphone, (Audio device)
 Mini DisplayPort
 Connection at device, 12
 Connection to docking station, 18
 Pin assignment of the interface, 75
 Mini DisplayPort
 Technical specifications of interface, 70
 MUI, 61
 Multi Media Card
 Card reader, 42
 Multi Media Card (MMC)
 Card reader, 12

N

NEMA, 33
 Network card, 47

O

On/off button
 Function, 15
 Pos., 11
 Switch off the device., 35
 Online ordering system, 44

On-screen error messages, 89

Operating mode

Off, 35

On, 35

Sleep mode, 35

Switch off screen, 35

Operating modes, 35

Operating system

Installing, 58

Starting for the first time, 34

Updates, 57

Order number, 27

P

Parameter scan, (Using barcode reader)

Partitions

Delivery state in Windows 7, 60

Setting up, 59

setting up in Windows 7, 60

Peripheral equipment, 36

Power button, (On/off button)

Power consumption, 67

Power options, 35

Power supply

Connection at device, 13

Connection to docking station, 18

via docking station, 39

with external power supply unit, 39

Power supply

Connecting, 32

Processor, 69

Product key, 27

PROFIBUS

Integration, 44

R

Rating plate, 26

Rechargeable battery

Battery operation, 29

Charging state, 29

Danger notices, 28

Recovery function, 55

Repair service, 53, 53

Repairs, 21

Restart, 34

Restore function, 55

RFID reader

Pos., 11

using, 42

RJ45

Pin assignment of the interface, 76

RJ45 Ethernet, 44

RS-232

Connection at device, 12

Interfaces on the device, 70

Pin assignment of the interface, 74

RTTE directive, 64

S

Safety instruction

Preventing inadvertent operation, 49

Unintentional response, 49

Safety instructions, 20

SD card

Card reader, 12, 42

Technical specifications, 71

Serial interface, 70

Serial number, 27

SIMATIC IPC Image & Partition Creator, (Image & Partition Creator)

SIMATIC S7

Integration, 44

Sleep

Sleep mode, 35

Sleep mode

Hibernate, 35

Hibernation, 35

Sleep, 35

Softnet S7

Integration, 44

SSD

Changing, 53

SSD assembly, 52

SSD kit

Order number, 52

Standard versions, 10

Starting for the first time, 34

Startup, 89

Status displays, 16, 71

Pos., 11

Supply voltage, 67

For countries other than the USA and Canada, 33

For the USA and Canada, 33

Switch off screen, (Operating mode)

System LEDs, (Status displays)

System partition, 56

System resources, 77

T

- Technical specifications, 67
- Temperature, 68
- TPM, 46
- Transport precautions, 25
- Troubleshooting/FAQs, 96
- Trusted Platform Module, (TPM)

U

- UAJ, 37
 - Pin assignment of the jack, 76
 - Technical specifications for stereo jack, 70
- Unpacking
 - Device, 26
- Updates
 - Operating system, 57
- USB
 - Technical specifications of interface on the docking station, 71
 - Technical specifications of the interface on the device, 70
- USB 3.0 Type A
 - Connection at device, 12
 - Connection to docking station, 18
- USB Type A
 - Pin assignment of the interface, 72
- USB Type C
 - Pin assignment of the interface, 73
- Using rechargeable batteries, 50

V

- Ventilation slots, 12, 12

W

- Weight, 67
- Windows
 - Installing, 58
 - Partitions, (Partitions)
- Wireless LAN, 44, 47
 - Regulations, 63
- WLAN
 - Standard, 70