

# MEASUREMENT REPORT

## FCC PART 15.247 & IC RSS-247 WLAN 802.11b/g/n

---

**FCC ID:** VPYLBEE5HY1MW  
**IC:** 772C-LBEE5HY1MW  
**APPLICANT:** Murata Manufacturing Co., Ltd.  
**Application Type:** Certification  
**Product:** Communication Module  
**Model No.:** LBEE5HY1MW  
**HVIN:** LBEE5HY1MW  
**FCC Classification:** Digital Transmission System (DTS)  
**FCC Rule Part(s):** Part 15 Subpart C (Section 15.247)  
**IC Rule(s):** RSS-247 Issue 2  
**Test Procedure(s):** ANSI C63.10-2013, KDB 558074 D01v04  
**Test Date:** February 08 ~ March 15, 2018

Reviewed By :   
( Kevin Guo )

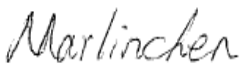
Approved By :   
( Marlin Chen )



The test results relate only to the samples tested.

This equipment has been shown to be capable of compliance with the applicable technical standards as indicated in the measurement report and was tested in accordance with the measurement procedures specified in KDB 558074 D01v04. Test results reported herein relate only to the item(s) tested.

The test report shall not be reproduced except in full without the written approval of MRT Technology (Suzhou) Co., Ltd.

---

## Revision History

Report No.	Version	Description	Issue Date	Note
1802WSU008-U1	Rev. 01	Initial report	05-15-2018	Valid

---

## CONTENTS

Description	Page
<b>§2.1033 General Information .....</b>	<b>5</b>
<b>1. INTRODUCTION .....</b>	<b>6</b>
1.1. Scope .....	6
1.2. MRT Test Location .....	6
<b>2. PRODUCT INFORMATION .....</b>	<b>7</b>
2.1. Feature of Equipment under Test .....	7
2.2. Product Specification Subjective to this Report.....	7
2.3. Operation Frequency / Channel List .....	7
2.4. Test Mode .....	8
2.5. Description of Test Software.....	8
2.6. Device Capabilities .....	8
2.7. Test Configuration .....	9
2.8. EMI Suppression Device(s)/Modifications.....	9
2.9. Labeling Requirements.....	10
<b>3. DESCRIPTION OF TEST .....</b>	<b>11</b>
3.1. Evaluation Procedure .....	11
3.2. AC Line Conducted Emissions .....	11
3.3. Radiated Emissions.....	12
<b>4. ANTENNA REQUIREMENTS.....</b>	<b>13</b>
<b>5. TEST EQUIPMENT CALIBRATION DATE .....</b>	<b>14</b>
<b>6. MEASUREMENT UNCERTAINTY.....</b>	<b>15</b>
<b>7. TEST RESULT .....</b>	<b>16</b>
7.1. Summary .....	16
7.2. 6dB Bandwidth Measurement.....	17
7.2.1. Test Limit .....	17
7.2.2. Test Procedure used.....	17
7.2.3. Test Setting.....	17
7.2.4. Test Setup.....	17
7.2.5. Test Result.....	18
7.3. Output Power Measurement.....	22
7.3.1. Test Limit .....	22
7.3.2. Test Procedure Used .....	22
7.3.3. Test Setting.....	22

7.3.4.	Test Setup.....	22
7.3.5.	Test Result of Output Power .....	23
7.4.	Power Spectral Density Measurement .....	25
7.4.1.	Test Limit .....	25
7.4.2.	Test Procedure Used .....	25
7.4.3.	Test Setting .....	25
7.4.4.	Test Setup.....	25
7.4.5.	Test Result.....	26
7.5.	Conducted Band Edge and Out-of-Band Emissions.....	30
7.5.1.	Test Limit .....	30
7.5.2.	Test Procedure Used .....	30
7.5.3.	Test Setting.....	30
7.5.4.	Test Setup.....	31
7.5.5.	Test Result.....	32
7.6.	Radiated Spurious Emission Measurement .....	39
7.6.1.	Test Limit .....	39
7.6.2.	Test Procedure Used .....	39
7.6.3.	Test Setting .....	39
7.6.4.	Test Setup.....	41
7.6.5.	Test Result.....	42
7.7.	Radiated Restricted Band Edge Measurement .....	53
7.7.1.	Test Limit .....	53
7.7.2.	Test Procedure Used .....	54
7.7.3.	Test Setting .....	54
7.7.4.	Test Setup.....	55
7.7.5.	Test Result.....	56
7.8.	AC Conducted Emissions Measurement.....	80
7.8.1.	Test Limit .....	80
7.8.2.	Test Setup.....	80
7.8.3.	Test Result.....	80
<b>8.</b>	<b>CONCLUSION.....</b>	<b>81</b>

## §2.1033 General Information

<b>Applicant:</b>	Murata Manufacturing Co., Ltd.
<b>Applicant Address:</b>	10-1, Higashikotari 1-chome, Nagaokakyo-shi, Kyoto 617-8555, Japan
<b>Manufacturer:</b>	Murata Manufacturing Co., Ltd.
<b>Manufacturer Address:</b>	10-1, Higashikotari 1-chome, Nagaokakyo-shi, Kyoto 617-8555, Japan
<b>Test Site:</b>	MRT Technology (Suzhou) Co., Ltd
<b>Test Site Address:</b>	D8 Building, No.2 Tian'edang Rd., Wuzhong Economic Development Zone, Suzhou, China
<b>FCC Registration No.:</b>	893164
<b>IC Registration No.:</b>	11384A-1
<b>Test Device Serial No.:</b>	N/A <input type="checkbox"/> Production <input checked="" type="checkbox"/> Pre-Production <input type="checkbox"/> Engineering
<b>FCC Classification:</b>	Digital Transmission System (DTS)

### Test Facility / Accreditations

Measurements were performed at MRT Laboratory located in Tian'edang Rd., Suzhou, China.

- MRT facility is a FCC registered (MRT Reg. No. 893164) test facility with the site description report on file and has met all the requirements specified in Section 2.948 of the FCC Rules.
- MRT facility is an IC registered (MRT Reg. No. 11384A-1) test laboratory with the site description on file at Industry Canada.
- MRT facility is a VCCI registered (R-20025, G-20034, C-20020, T-20020) test laboratory with the site description on file at VCCI Council.
- MRT Lab is accredited to ISO 17025 by the American Association for Laboratory Accreditation (A2LA) under the American Association for Laboratory Accreditation Program (A2LA Cert. No. 3628.01) in EMC, Telecommunications and Radio testing for FCC, Industry Canada, EU and TELEC Rules.



# 1. INTRODUCTION

## 1.1. Scope

Measurement and determination of electromagnetic emissions (EMC) of radio frequency devices including intentional and/or unintentional radiators for compliance with the technical rules and regulations of the Federal Communications Commission and the Industry Canada Certification and Engineering Bureau.

## 1.2. MRT Test Location

The map below shows the location of the MRT LABORATORY, its proximity to the Taihu Lake. These measurement tests were conducted at the MRT Technology (Suzhou) Co., Ltd. Facility located at D8 Building, Youxin Industrial Park, No.2 Tian'edang Rd., Wuzhong Economic Development Zone, Suzhou, China. The detailed description of the measurement facility was found to be in compliance with the requirements of § 2.948 according to ANSI C63.4-2009 on September 30, 2013.



## 2. PRODUCT INFORMATION

### 2.1. Feature of Equipment under Test

Product Name:	Communication Module
Model No.:	LBEE5HY1MW
HVIN:	LBEE5HY1MW
Wi-Fi Specification:	802.11a/b/g/n/ac
Bluetooth Specification:	V4.2 dual mode
Operating Temperature:	-30 ~ 85 °C
Power Type:	DC 3.3V

### 2.2. Product Specification Subjective to this Report

Frequency Range	802.11b/g/n-HT20: 2412 ~ 2462 MHz
Channel Number:	802.11b/g/n-HT20: 11
Type of Modulation	802.11b: DSSS 802.11g/n: OFDM
Data Rate:	802.11b: 1/2/5.5/11Mbps 802.11g: 6/9/12/18/24/36/48/54Mbps 802.11n: up to 72.2Mbps
Maximum Peak Output Power:	802.11b: 20.54dBm 802.11g: 23.83dBm 802.11n-HT20: 23.43dBm
Antenna Type:	PCB Antenna
Antenna Gain	0.1dBi

Note: For other features of this EUT, test report will be issued separately.

### 2.3. Operation Frequency / Channel List

802.11b/g/n-HT20

Channel	Frequency	Channel	Frequency	Channel	Frequency
01	2412 MHz	02	2417 MHz	03	2422 MHz
04	2427 MHz	05	2432 MHz	06	2437 MHz
07	2442 MHz	08	2447 MHz	09	2452 MHz
10	2457 MHz	11	2462 MHz	--	--

## 2.4. Test Mode

Test Mode	Mode 1: Transmit by 802.11b (11Mbps)
	Mode 2: Transmit by 802.11g (6Mbps)
	Mode 3: Transmit by 802.11n-HT20 (MCS0)

Note: Refer to section 7.3.5, we choose the maximum power output at various data rates for final test of each channel.

## 2.5. Description of Test Software

The test utility software used during testing was “Tera Term”, and the version was “4.85”.

### Power Parameter Value:

Test Mode	Channel No.	Test Frequency (MHz)	Power Parameter Value
11b	01	2412	68
	06	2437	68
	11	2462	68
11g	01	2412	48
	06	2437	64
	11	2462	48
11n-HT20	01	2412	48
	06	2437	56
	11	2462	48

## 2.6. Device Capabilities

This device contains the following capabilities:

802.11a/b/g/n/ac W-LAN, Bluetooth V4.2 dual mode (BDR/EDR/LE) device.

**Note:** 2.4GHz WLAN (DTS) operation is possible in 20MHz channel bandwidths. The maximum achievable duty cycle was determined based on measurements performed on a spectrum analyzer in zero-span mode with RBW = 8MHz, VBW = 50MHz, and detector = peak or average per the guidance of Section 6.0 b) of KDB 558074 D01v04. The RBW and VBW were both greater than 50/T, where T is the minimum transmission duration, and the number of sweep points across T was greater than 100. The duty cycles are as follows:

Test Mode	Duty Cycle
802.11b	99.74%
802.11g	98.21%
802.11n-HT20	98.16%



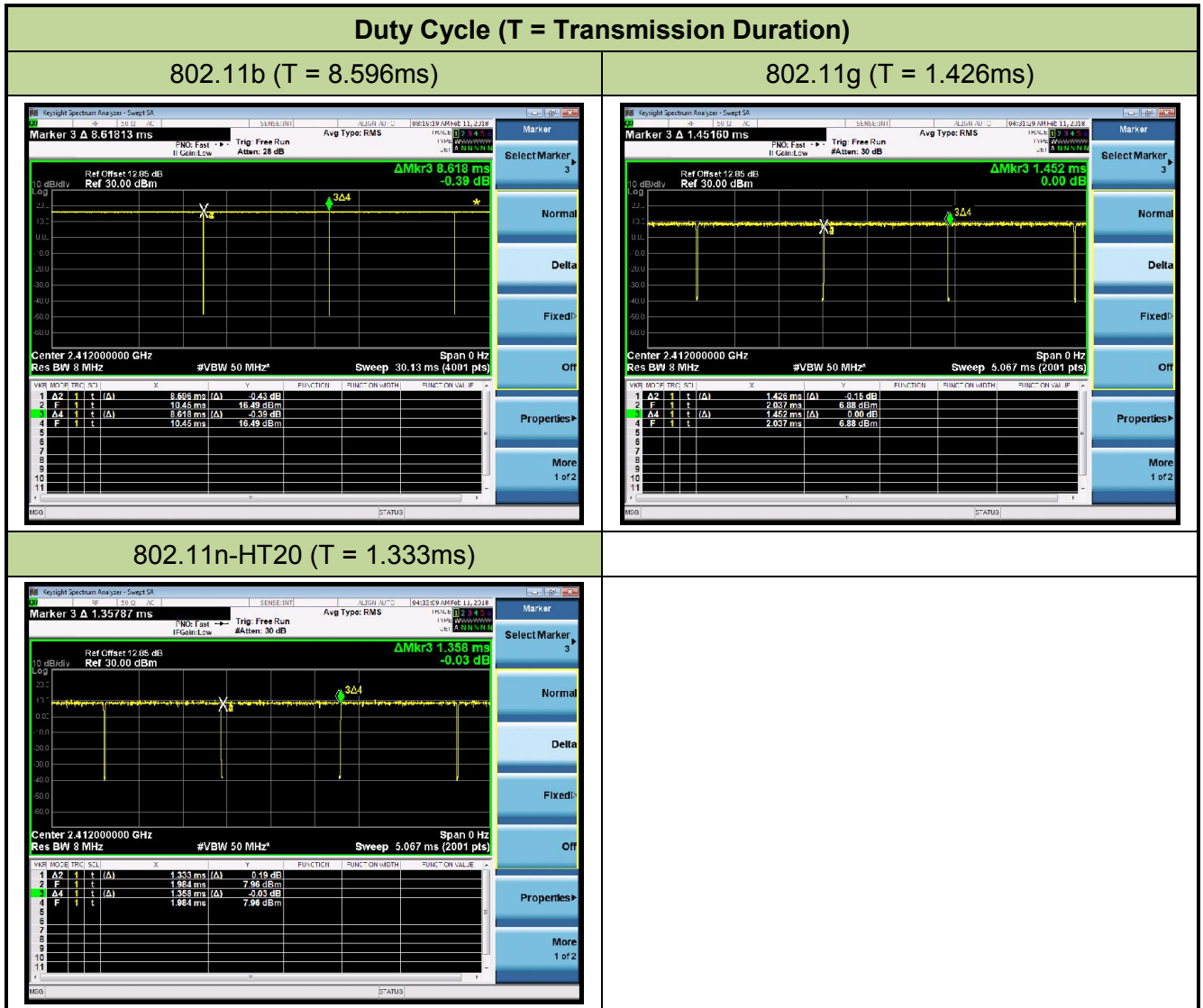

## 2.7. Test Configuration

The **Communication Module** was tested per the guidance of KDB 558074 D01v04. ANSI C63.10-2013 was used to reference the appropriate EUT setup for radiated spurious emissions testing and AC line conducted testing.

## 2.8. EMI Suppression Device(s)/Modifications

No EMI suppression device(s) were added and/or no modifications were made during testing.

## **2.9. Labeling Requirements**

Per 2.1074 & 15.19; Docket 95-19

The label shall be permanently affixed at a conspicuous location on the device; instruction manual or pamphlet supplied to the user and be readily visible to the purchaser at the time of purchase.

However, when the device is so small wherein placement of the label with specified statement is not practical, only the FCC ID must be displayed on the device per Section 15.19(a)(5). Please see attachment for FCC ID label and label location.

RSP-100 Issue 11 Section 3

The manufacturer, importer or distributor shall meet the labelling requirements set out in this section for every unit:

- (i) prior to marketing in Canada, for products manufactured in Canada
- (ii) prior to importation into Canada, for imported products

For information regarding the e-labelling option, see Notice 2014–DRS1003. The label for the certified product represents the manufacturer’s or importer’s compliance with Innovation, Science and Economic Development Canada’s (ISED) regulatory requirements.

Please see attachment for IC label and label location.

### 3. DESCRIPTION OF TEST

#### 3.1. Evaluation Procedure

The measurement procedures described in the American National Standard for Testing Unlicensed Wireless Devices (ANSI C63.10-2013), and the guidance provided in KDB 558074 D01v04 were used in the measurement of the device.

**Deviation from measurement procedure.....None**

#### 3.2. AC Line Conducted Emissions

The line-conducted facility is located inside an 8'x4'x4' shielded enclosure. A 1m x 2m wooden table 80cm high is placed 40cm away from the vertical wall and 80cm away from the sidewall of the shielded room. Two 10kHz-30MHz, 50Ω/50uH Line-Impedance Stabilization Networks (LISNs) are bonded to the shielded room floor. Power to the LISNs is filtered by external high-current high-insertion loss power line filters. These filters attenuate ambient signal noise from entering the measurement lines. These filters are also bonded to the shielded enclosure.

The EUT is powered from one LISN and the support equipment is powered from the second LISN. All interconnecting cables more than 1 meter were shortened to a 1 meter length by non-inductive bundling (serpentine fashion) and draped over the back edge of the test table. All cables were at least 40cm above the horizontal reference ground-plane. Power cables for support equipment were routed down to the second LISN while ensuring that that cables were not draped over the second LISN.

Sufficient time for the EUT, support equipment, and test equipment was allowed in order for them to warm up to their normal operating condition. The RF output of the LISN was connected to the receiver and exploratory measurements were made to determine the frequencies producing the maximum emission from the EUT. The receiver was scanned from 150kHz to 30MHz. The detector function was set to peak mode for exploratory measurements while the bandwidth of the analyzer was set to 9kHz. The EUT, support equipment, and interconnecting cables were arranged and manipulated to maximize each emission. Each emission was also maximized by varying: power lines, the mode of operation or data exchange speed, or support equipment whichever determined the worst-case emission. Once the worst case emissions have been identified, the one EUT cable configuration/arrangement and mode of operation that produced these emissions are used for final measurements on the same test site. The analyzer is set to CISPR quasi-peak and average detectors with a 9kHz resolution bandwidth for final measurements.

An extension cord was used to connect to a single LISN which powered by EUT. The extension cord was calibrated with LISN, the impedance and insertion loss are compliance with the requirements as stated in ANSI C63.10-2013.

### 3.3. Radiated Emissions

The radiated test facilities consisted of an indoor 3 meter semi-anechoic chamber used for final measurements and exploratory measurements, when necessary. The measurement area is contained within the semi-anechoic chamber which is shielded from any ambient interference. For measurements above 1GHz absorbers are arranged on the floor between the turn table and the antenna mast in such a way so as to maximize the reduction of reflections. For measurements below 1GHz, the absorbers are removed. A MF Model 210SS turntable is used for radiated measurement. It is a continuously rotatable, remote controlled, metallic turntable and 2 meters (6.56 ft.) in diameter. The turn table is flush with the raised floor of the chamber in order to maintain its function as a ground plane. An 80cm high PVC support structure is placed on top of the turntable.

For all measurements, the spectrum was scanned through all EUT azimuths and from 1 to 4 meter receive antenna height using a broadband antenna from 30MHz up to the upper frequency shown in 15.33(b)(1) depending on the highest frequency generated or used in the device or on which the device operates or tunes. For frequencies above 1GHz, linearly polarized double ridge horn antennas were used. For frequencies below 30MHz, a calibrated loop antenna was used. When exploratory measurements were necessary, they were performed at 1 meter test distance inside the semi-anechoic chamber using broadband antennas, broadband amplifiers, and spectrum analyzers to determine the frequencies and modes producing the maximum emissions. Sufficient time for the EUT, support equipment, and test equipment was allowed in order for them to warm up to their normal operating condition. The test set-up for frequencies below 1GHz was placed on top of the 0.8 meter high, 1 x 1.5 meter table; and test set-up for frequencies 1-25GHz was placed on top of the 1.5 meter high, 1 x 1.5 meter table. The EUT, support equipment, and interconnecting cables were arranged and manipulated to maximize each emission. Appropriate precaution was taken to ensure that all emissions from the EUT were maximized and investigated. The system configuration, clock speed, mode of operation or video resolution, if applicable, turntable azimuth, and receive antenna height was noted for each frequency found.

Final measurements were made in the semi-anechoic chamber using calibrated, linearly polarized broadband and horn antennas. The test setup was configured to the setup that produced the worst case emissions. The spectrum analyzer was set to investigate all frequencies required for testing to compare the highest radiated disturbances with respect to the specified limits. The turntable containing the EUT was rotated through 360 degrees and the height of the receive antenna was varied 1 to 4 meters and stopped at the azimuth and height producing the maximum emission. Each emission was maximized by changing the orientation of the EUT through three orthogonal planes and changing the polarity of the receive antenna, whichever produced the worst-case emissions. According to 3dB Beam-Width of horn antenna, the horn antenna should be always directed to the EUT when rising height.

#### **4. ANTENNA REQUIREMENTS**

**Excerpt from §15.203 of the FCC Rules/Regulations:**

“An intentional radiator antenna shall be designed to ensure that no antenna other than that furnished by the responsible party can be used with the device. The use of a permanently attached antenna or of an antenna that uses a unique coupling to the intentional radiator shall be considered sufficient to comply with the provisions of this section.”

**Conclusion:**

The device unit complies with the requirement of §15.203.

## 5. TEST EQUIPMENT CALIBRATION DATE

### Conducted Emissions - SR2

Instrument	Manufacturer	Type No.	Asset No.	Cali. Interval	Cali. Due Date
EMI Test Receiver	R&S	ESR3	MRTSUE06185	1 year	2018/04/24
Two-Line V-Network	R&S	ENV 216	MRTSUE06002	1 year	2018/06/21
Two-Line V-Network	R&S	ENV 216	MRTSUE06003	1 year	2018/06/21
Thermohygrometer	Testo	608-H1	MRTSUE06404	1 year	2018/08/14
Shielding Anechoic Chamber	Mikebang	Chamber-SR2	MRTSUE06214	1 year	2018/05/10

### Radiated Emission - AC1

Instrument	Manufacturer	Type No.	Asset No.	Cali. Interval	Cali. Due Date
PXA Signal Analyzer	Keysight	9030B	MRTSUE06395	1 year	2018/09/13
Loop Antenna	Schwarzbeck	FMZB1519	MRTSUE06025	1 year	2018/11/20
Bilog Period Antenna	Schwarzbeck	VULB 9168	MRTSUE06172	1 year	2018/11/18
Horn Antenna	Schwarzbeck	BBHA9120D	MRTSUE06023	1 year	2018/10/21
Microwave System Amplifier	Agilent	83017A	MRTSUE06076	1 year	2018/11/17
Broadband Horn Antenna	Schwarzbeck	BBHA9170	MRTSUE06024	1 year	2018/04/25
Thermohygrometer	Testo	608-H1	MRTSUE06403	1 year	2018/08/14
Anechoic Chamber	TDK	Chamber-AC1	MRTSUE06212	1 year	2018/05/10

### Conducted Test Equipment - TR3

Instrument	Manufacturer	Type No.	Asset No.	Cali. Interval	Cali. Due Date
Spectrum Analyzer	Agilent	N9020A	MRTSUE06106	1 year	2018/04/25
Power Meter	Agilent	U2021XA	MRTSUE06030	1 year	2018/12/06
Thermohygrometer	Testo	608-H1	MRTSUE06401	1 year	2018/08/14

Software	Version	Function
e3	V8.3.5	EMI Test Software

## 6. MEASUREMENT UNCERTAINTY

Where relevant, the following test uncertainty levels have been estimated for tests performed on the EUT as specified in CISPR 16-4-2. This uncertainty represents an expanded uncertainty expressed at approximately the 95% confidence level using a coverage factor of  $k = 2$ .

<b>AC Conducted Emission Measurement - SR2</b>
Measuring Uncertainty for a Level of Confidence of 95% ( $U=2Uc(y)$ ): 150kHz~30MHz: 3.46dB
<b>Radiated Emission Measurement - AC1</b>
Measuring Uncertainty for a Level of Confidence of 95% ( $U=2Uc(y)$ ): 9kHz ~ 1GHz: 4.18dB 1GHz ~ 25GHz: 4.76dB
<b>Spurious Emissions, Conducted - TR3</b>
Measuring Uncertainty for a Level of Confidence of 95% ( $U=2Uc(y)$ ): 0.78dB
<b>Output Power - TR3</b>
Measuring Uncertainty for a Level of Confidence of 95% ( $U=2Uc(y)$ ): 1.13dB
<b>Power Spectrum Density - TR3</b>
Measuring Uncertainty for a Level of Confidence of 95% ( $U=2Uc(y)$ ): 1.15dB
<b>Occupied Bandwidth - TR3</b>
Measuring Uncertainty for a Level of Confidence of 95% ( $U=2Uc(y)$ ): 0.28%

## 7. TEST RESULT

### 7.1. Summary

**Company Name:** Murata Manufacturing Co., Ltd.  
**FCC ID:** VPYLBEE5HY1MW  
**IC:** 772C-LBEE5HY1MW

FCC Section(s)	IC Section(s)	Test Description	Test Limit	Test Condition	Test Result	Reference
15.247(a)(2)	RSS-247 [5.2]	6dB Bandwidth	$\geq 500\text{kHz}$	Conducted	Pass	Section 7.2
15.247(b)(3)	RSS-247 [5.4(4)]	Output Power	$\leq 30\text{dBm}$		Pass	Section 7.3
15.247(e)	RSS-247 [5.2]	Power Spectral Density	$\leq 8\text{dBm}/3\text{kHz}$		Pass	Section 7.4
15.247(d)	RSS-247 [5.5]	Band Edge / Out-of-Band Emissions	$\geq 20\text{dBc(Peak)}$		Pass	Section 7.5
15.205 15.209	RSS-247 [5.5]	General Field Strength Limits (Restricted Bands and Radiated Emission Limits)	Emissions in restricted bands must meet the radiated limits detailed in 15.209	Radiated	Pass	Section 7.6 & 7.7
15.207	RSS-Gen [8.8]	AC Conducted Emissions 150kHz - 30MHz	< FCC 15.207 limits	Line Conducted	N/A	Section 7.8

#### Notes:

- 1) The analyzer plots shown in this section were all taken with a correction table loaded into the analyzer. The correction table was used to account for the losses of the cables and attenuators used as part of the system to connect the EUT to the analyzer at all frequencies of interest.
- 2) All modes of operation and data rates were investigated. For radiated emission test, every axis (X, Y, Z) was also verified. The test results shown in the following sections represent the worst case emissions.



## 7.2. 6dB Bandwidth Measurement

### 7.2.1. Test Limit

The minimum 6dB bandwidth shall be at least 500 kHz.

### 7.2.2. Test Procedure used

KDB 558074 D01v04 – Section 8.2 Option 2

### 7.2.3. Test Setting

1. The Spectrum's automatic bandwidth measurement capability was used to perform the 6dB bandwidth measurement. The "X" dB bandwidth parameter was set to  $X = 6$ . The bandwidth measurement was not influenced by any intermediate power nulls in the fundamental emission.
2. Set RBW = 100 kHz
3. VBW  $\geq 3 \times$  RBW
4. Detector = Peak
5. Trace mode = max hold
6. Sweep = auto couple
7. Allow the trace was allowed to stabilize

### 7.2.4. Test Setup

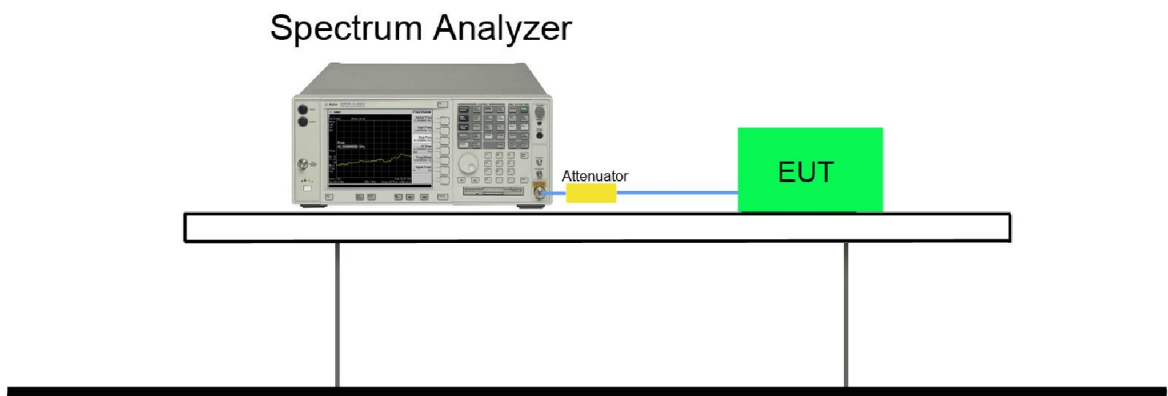

### 7.2.5. Test Result

Product	Communication Module	Temperature	23°C
Test Engineer	Dandy Li	Relative Humidity	54%
Test Site	TR3	Test Date	2018/02/11
Test Item	6dB Bandwidth		

Test Mode	Data Rate / MCS	Channel No.	Frequency (MHz)	6dB Bandwidth (MHz)	Limit (MHz)	Result
802.11b	11Mbps	01	2412	9.08	≥0.5	Pass
802.11b	11Mbps	06	2437	9.08	≥0.5	Pass
802.11b	11Mbps	11	2462	9.06	≥0.5	Pass
802.11g	6Mbps	01	2412	16.31	≥0.5	Pass
802.11g	6Mbps	06	2437	16.32	≥0.5	Pass
802.11g	6Mbps	11	2462	16.07	≥0.5	Pass
802.11n-HT20	MCS0	01	2412	17.29	≥0.5	Pass
802.11n-HT20	MCS0	06	2437	17.31	≥0.5	Pass
802.11n-HT20	MCS0	11	2462	16.02	≥0.5	Pass

**802.11b 6dB Bandwidth**

**Channel 01 (2412MHz)**

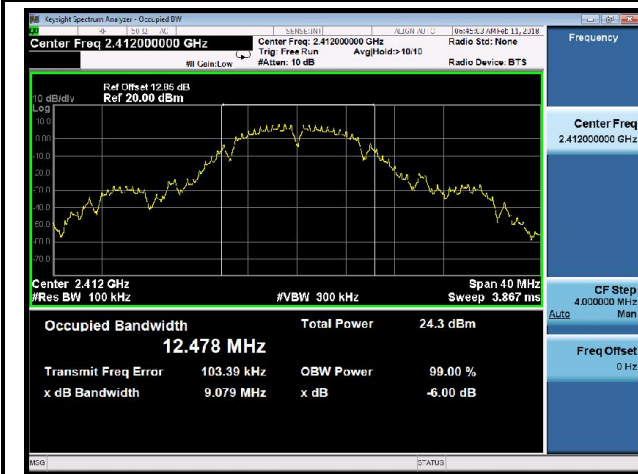

**Channel 06 (2437MHz)**

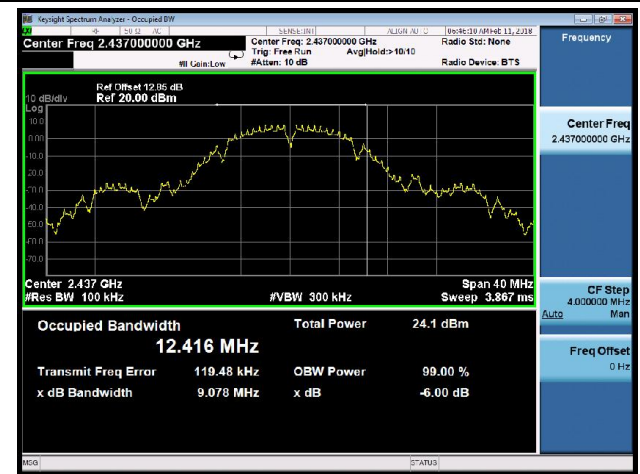

**Channel 11 (2462MHz)**



### 802.11g 6dB Bandwidth

#### Channel 01 (2412MHz)



#### Channel 06 (2437MHz)

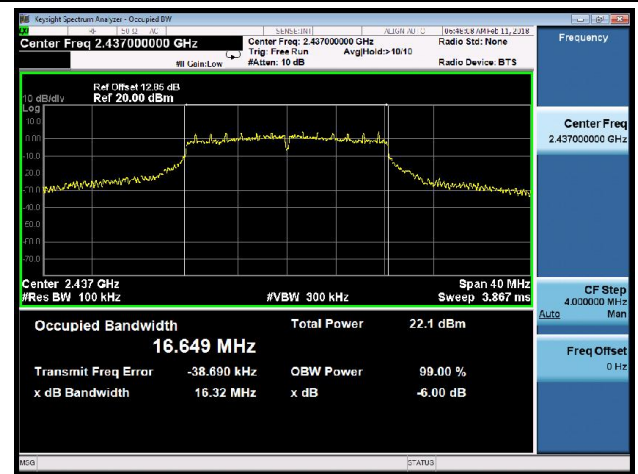

#### Channel 11 (2462MHz)

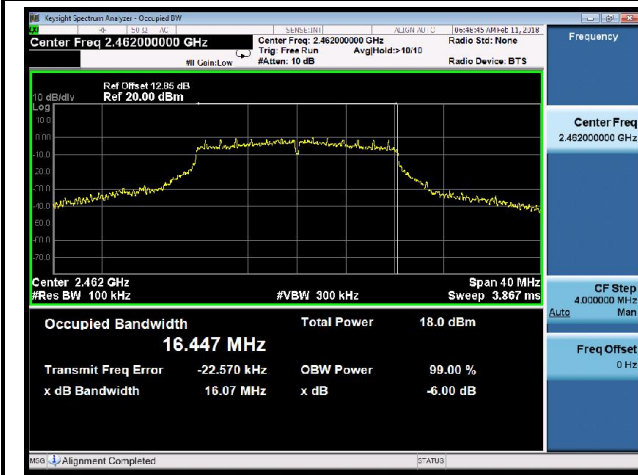

### 802.11n-HT20 6dB Bandwidth

#### Channel 01 (2412MHz)

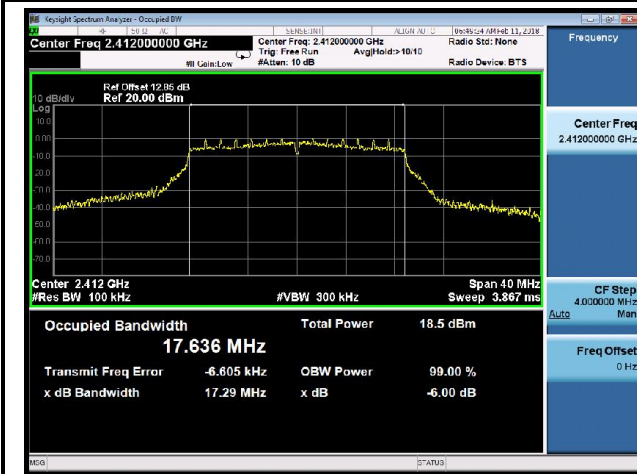

#### Channel 06 (2437MHz)

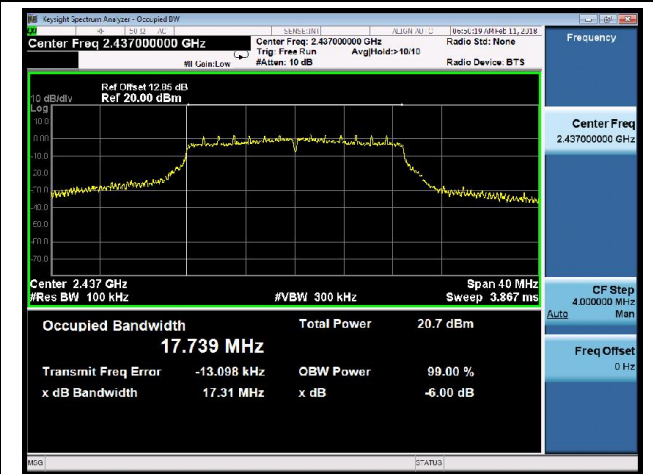

#### Channel 11 (2462MHz)

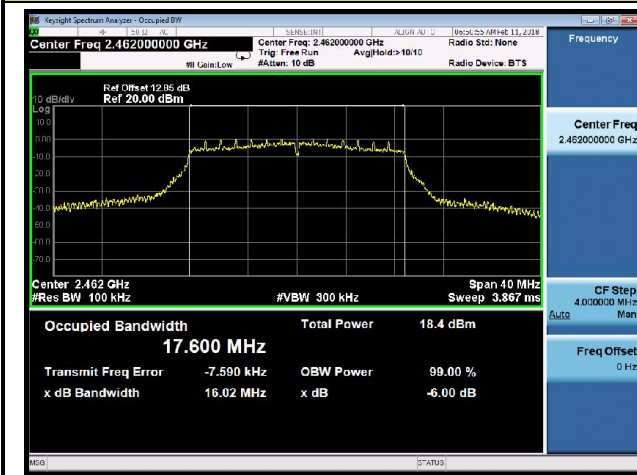

### 7.3. Output Power Measurement

#### 7.3.1. Test Limit

The maximum conducted output power shall be exceed 1 Watt (30dBm) and the E.I.R.P shall not exceed 4 Watt (36dBm).

#### 7.3.2. Test Procedure Used

KDB 558074 D01v04 - Section 9.1.3 PKPM1 - Peak Power Method

KDB 558074 D01v04 - Section 9.2.3.2 AVGPM-G Average Power Method

#### 7.3.3. Test Setting

##### **Method PKPM1 (Peak Power Measurement of Signals with DTS BW $\leq$ 50MHz)**

Peak power measurements were performed only when the EUT was transmitting at its maximum power control level using a broadband power meter with a pulse sensor. The pulse sensor employs a VBW = 50MHz so this method was only used for signals whose DTS bandwidth was less than or equal to 50MHz.

##### **Average Power Measurement**

Average power measurements were perform only when the EUT was transmitting at its maximum power control level using a broadband power meter with a pulse sensor. The power meter implemented triggering and gating capabilities which were set up such that power measurements were recorded only during the ON time of the transmitter.

#### 7.3.4. Test Setup

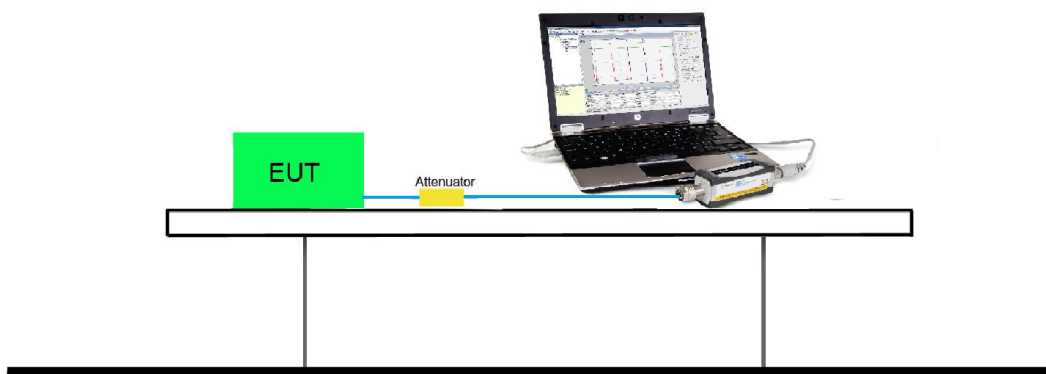

### 7.3.5. Test Result of Output Power

Power output test was verified over all data rates of each mode shown as below, and then choose the maximum power output (gray marker) for final test of each channel.

Output power at various data rates:

Test Mode	Bandwidth (MHz)	Channel No.	Frequency (MHz)	Data Rate / MCS	Power Parameter Value	Average Power (dBm)
802.11b	20	6	2437	1Mbps	68	16.55
				5.5Mbps	68	17.13
				11Mbps	68	17.14
802.11g	20	6	2437	6Mbps	64	15.78
				24Mbps	64	15.71
				54Mbps	52	12.79
802.11n	20	6	2437	MCS0	56	13.59
				MCS3	56	13.58
				MCS7	48	11.47

Product	Communication Module	Temperature	23°C
Test Engineer	Dandy Li	Relative Humidity	54%
Test Site	TR3	Test Date	2018/02/11
Test Item	Output Power		

### Test Result of Peak Output Power

Test Mode	Data Rate / MCS	Channel No.	Freq. (MHz)	Peak Power (dBm)	Limit (dBm)	Max EIRP (dBm)	EIRP Limit (dBm)	Result
11b	11Mbps	1	2412	20.33	≤ 30.00	20.43	≤ 36.00	Pass
11b	11Mbps	6	2437	20.16	≤ 30.00	20.26	≤ 36.00	Pass
11b	11Mbps	11	2462	20.54	≤ 30.00	20.64	≤ 36.00	Pass
11g	6Mbps	1	2412	21.98	≤ 30.00	22.08	≤ 36.00	Pass
11g	6Mbps	6	2437	23.83	≤ 30.00	23.93	≤ 36.00	Pass
11g	6Mbps	11	2462	21.75	≤ 30.00	21.85	≤ 36.00	Pass
11n-HT20	MCS0	1	2412	21.65	≤ 30.00	21.75	≤ 36.00	Pass
11n-HT20	MCS0	6	2437	23.43	≤ 30.00	23.53	≤ 36.00	Pass
11n-HT20	MCS0	11	2462	22.03	≤ 30.00	22.13	≤ 36.00	Pass

Note: Max EIRP (dBm) = Peak Power (dBm) + Antenna Gain (dBi), Antenna Gain (dBi) = 0.1dBi.

### Test Result of Average Output Power (Reporting Only)

Test Mode	Data Rate / MCS	Channel No.	Freq. (MHz)	Average Power (dBm)	Limit (dBm)	Max EIRP (dBm)	EIRP Limit (dBm)	Result
11b	11Mbps	1	2412	17.32	≤ 30.00	17.42	≤ 36.00	Pass
11b	11Mbps	6	2437	17.14	≤ 30.00	17.24	≤ 36.00	Pass
11b	11Mbps	11	2462	17.45	≤ 30.00	17.55	≤ 36.00	Pass
11g	6Mbps	1	2412	11.75	≤ 30.00	11.85	≤ 36.00	Pass
11g	6Mbps	6	2437	15.78	≤ 30.00	15.88	≤ 36.00	Pass
11g	6Mbps	11	2462	11.96	≤ 30.00	12.06	≤ 36.00	Pass
11n-HT20	MCS0	1	2412	11.32	≤ 30.00	11.42	≤ 36.00	Pass
11n-HT20	MCS0	6	2437	13.59	≤ 30.00	13.69	≤ 36.00	Pass
11n-HT20	MCS0	11	2462	11.40	≤ 30.00	11.50	≤ 36.00	Pass

Note: Max EIRP (dBm) = Average Power (dBm) + Antenna Gain (dBi), Antenna Gain (dBi) = 0.1dBi.



## 7.4. Power Spectral Density Measurement

### 7.4.1. Test Limit

The maximum permissible power spectral density is 8dBm in any 3 kHz band.

### 7.4.2. Test Procedure Used

KDB 558074 D01v04 - Section 10.2 Method PKPSD

### 7.4.3. Test Setting

- 1) Analyzer was set to the center frequency of the DTS channel under investigation
- 2) Span = 1.5 times the DTS channel bandwidth
- 3) RBW = 3kHz
- 4) VBW = 10kHz
- 5) Detector = peak
- 6) Sweep time = auto couple
- 7) Trace mode = max hold
- 8) Trace was allowed to stabilize

### 7.4.4. Test Setup

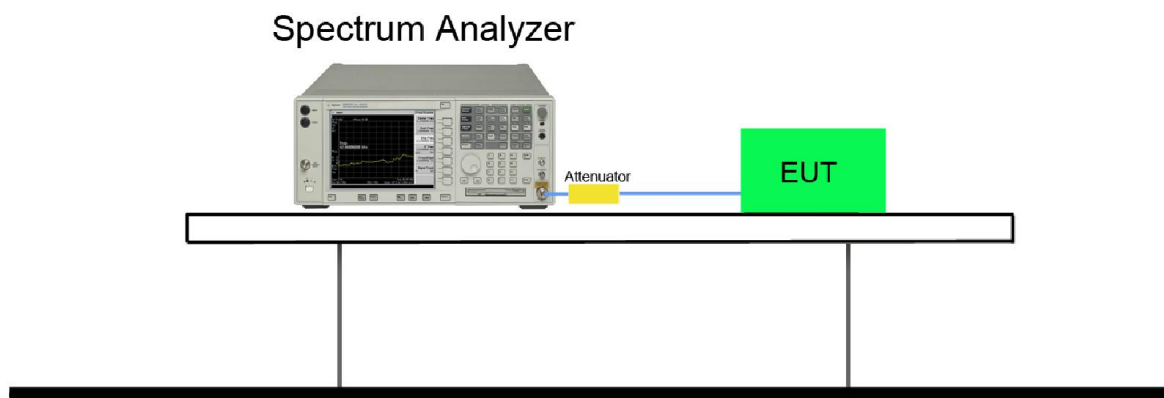

#### 7.4.5. Test Result

Product	Communication Module	Temperature	23°C
Test Engineer	Dandy Li	Relative Humidity	54%
Test Site	TR3	Test Date	2018/02/11
Test Item	Power Spectral Density		

Test Mode	Data Rate / MCS	Channel No.	Freq. (MHz)	PSD (dBm/3kHz)	Duty Cycle (%)	Final PSD (dBm/3kHz)	Limit (dBm/3kHz)	Result
11b	11Mbps	1	2412	-3.80	99.74	-3.80	≤ 8.0	Pass
11b	11Mbps	6	2437	-5.27	99.74	-5.27	≤ 8.0	Pass
11b	11Mbps	11	2462	-5.23	99.74	-5.23	≤ 8.0	Pass
11g	6Mbps	1	2412	-13.05	98.21	-13.05	≤ 8.0	Pass
11g	6Mbps	6	2437	-9.23	98.21	-9.23	≤ 8.0	Pass
11g	6Mbps	11	2462	-12.70	98.21	-12.70	≤ 8.0	Pass
11n-HT20	MCS0	1	2412	-12.73	98.16	-12.73	≤ 8.0	Pass
11n-HT20	MCS0	6	2437	-11.28	98.16	-11.28	≤ 8.0	Pass
11n-HT20	MCS0	11	2462	-11.99	98.16	-11.99	≤ 8.0	Pass

Note 1: When EUT duty cycle ≥ 98%, Final PSD (dBm/3kHz) = PSD (dBm/3kHz).

Note 2: When EUT duty cycle < 98%, Final PSD (dBm/3kHz) = PSD (dBm/3kHz) + 10\*log (1/duty cycle).

802.11b Peak PSD

Channel 01 (2412MHz)



Channel 06 (2437MHz)



Channel 11 (2462MHz)



802.11g Peak PSD

Channel 01 (2412MHz)

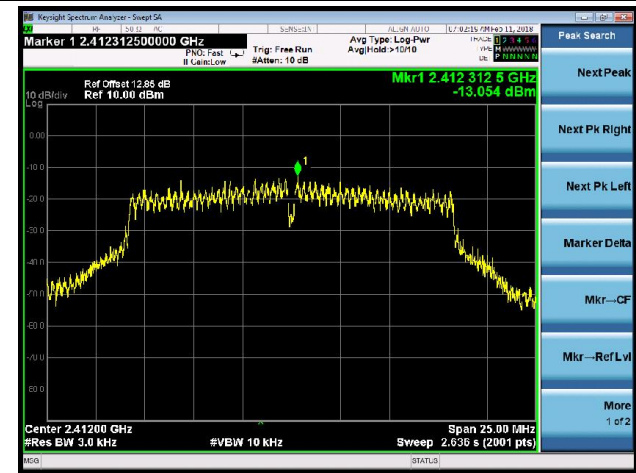

Channel 06 (2437MHz)

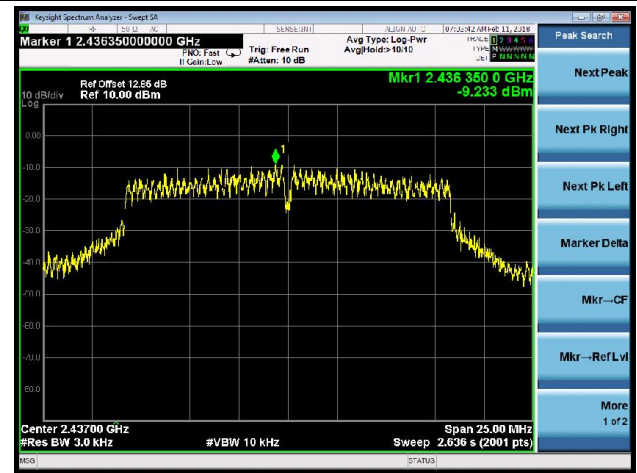

Channel 11 (2462MHz)



802.11n-HT20 Peak PSD

Channel 01 (2412MHz)



Channel 06 (2437MHz)



Channel 11 (2462MHz)



## **7.5. Conducted Band Edge and Out-of-Band Emissions**

### **7.5.1. Test Limit**

The limit for out-of-band spurious emissions at the band edge is 20dB below the fundamental emission level, as determined from the in-band power measurement of the DTS channel performed in a 100 kHz bandwidth per the PSD procedure.

### **7.5.2. Test Procedure Used**

KDB 558074 D01v04 - Section 11.2 & Section 11.3

### **7.5.3. Test Setting**

#### **Reference level measurement**

1. Set instrument center frequency to DTS channel center frequency
2. Set the span to  $\geq 1.5$  times the DTS bandwidth
3. Set the RBW = 100 kHz
4. Set the VBW  $\geq 3 \times$  RBW
5. Detector = peak
6. Sweep time = auto couple
7. Trace mode = max hold
8. Allow trace to fully stabilize

#### **Emission level measurement**

1. Set the center frequency and span to encompass frequency range to be measured
2. RBW = 100kHz
3. VBW = 300kHz
4. Detector = Peak
5. Trace mode = max hold
6. Sweep time = auto couple
7. The trace was allowed to stabilize

### 7.5.4. Test Setup

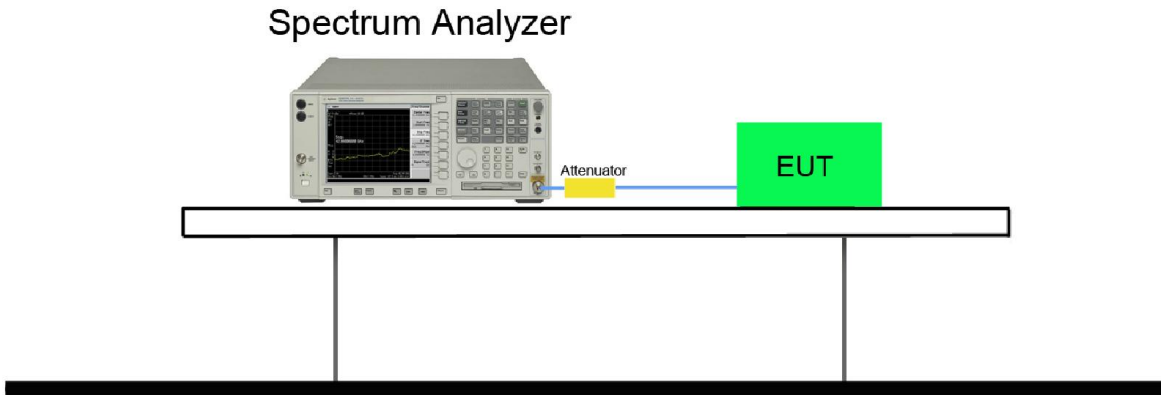

### 7.5.5. Test Result

Product	Communication Module	Temperature	23°C
Test Engineer	Dandy Li	Relative Humidity	54%
Test Site	TR3	Test Date	2018/03/15
Test Item	Conducted Band Edge and Out-of-Band Emissions		

Test Mode	Data Rate / MCS	Channel No.	Frequency (MHz)	Limit	Result
802.11b	11Mbps	01	2412	20dBc	Pass
802.11b	11Mbps	06	2437	20dBc	Pass
802.11b	11Mbps	11	2462	20dBc	Pass
802.11g	6Mbps	01	2412	20dBc	Pass
802.11g	6Mbps	06	2437	20dBc	Pass
802.11g	6Mbps	11	2462	20dBc	Pass
802.11n-HT20	MCS0	01	2412	20dBc	Pass
802.11n-HT20	MCS0	06	2437	20dBc	Pass
802.11n-HT20	MCS0	11	2462	20dBc	Pass



### 802.11b Out-of-Band Emissions

#### Channel 01 (2412MHz)

##### 100kHz PSD Reference Level



##### Low Band Edge

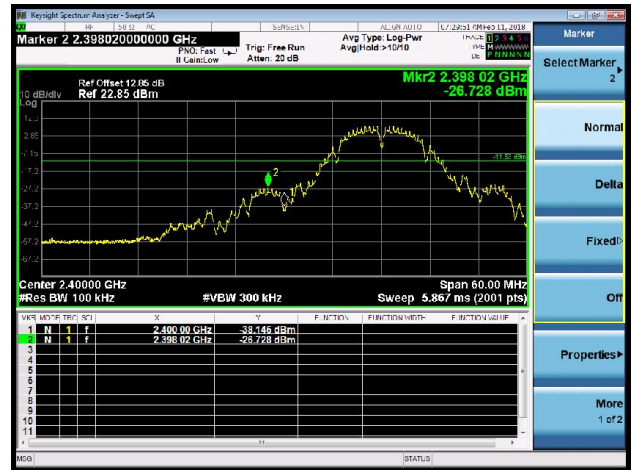

##### Spurious Emission

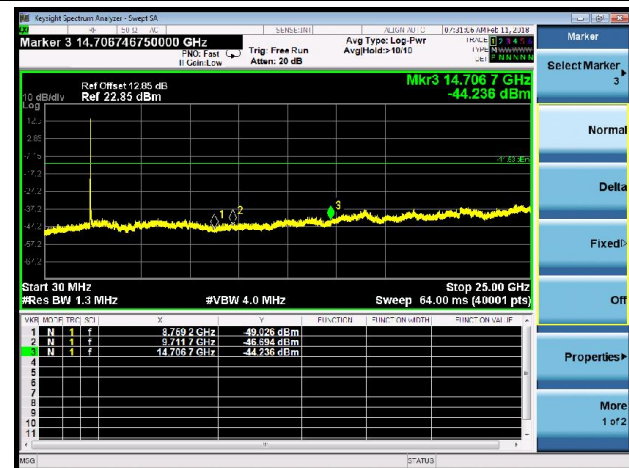

#### Channel 06 (2437MHz)

##### 100kHz PSD Reference Level



##### Spurious Emission

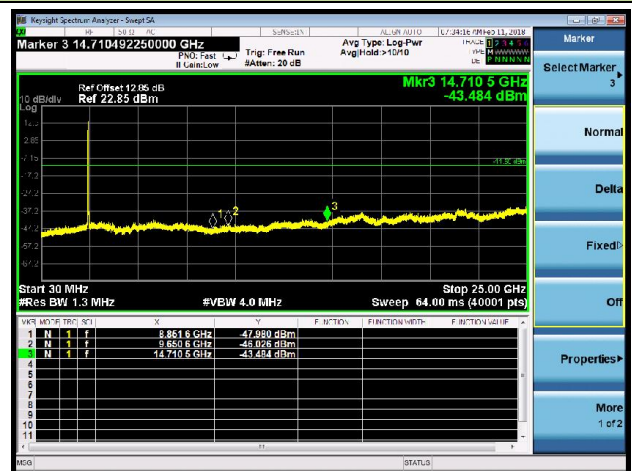

### Channel 11 (2462MHz)

#### 100kHz PSD Reference Level



#### High Band Edge

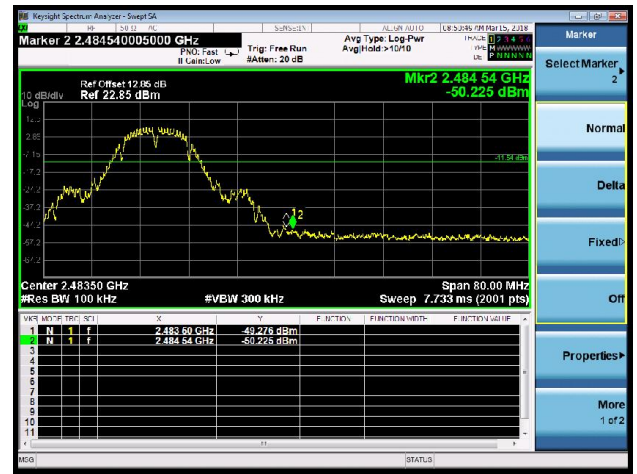

#### Spurious Emission

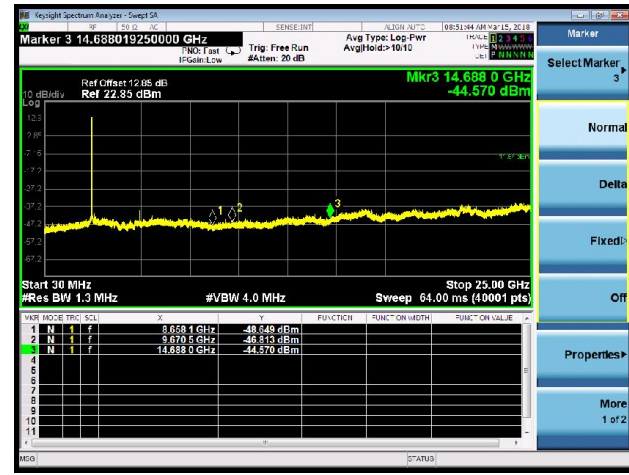

### 802.11g Out-of-Band Emissions

#### Channel 01 (2412MHz)

##### 100kHz PSD Reference Level



##### Low Band Edge

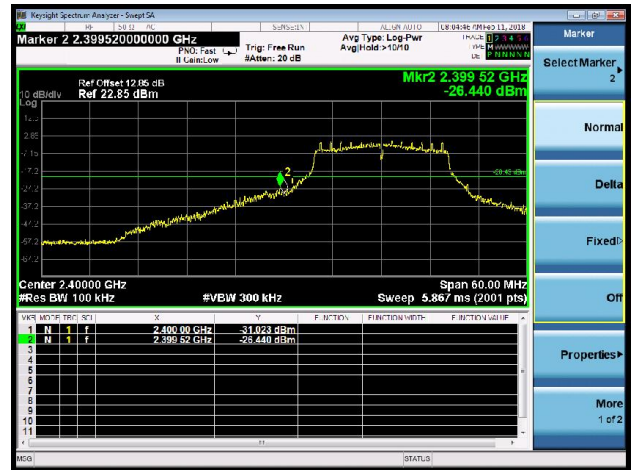

##### Spurious Emission

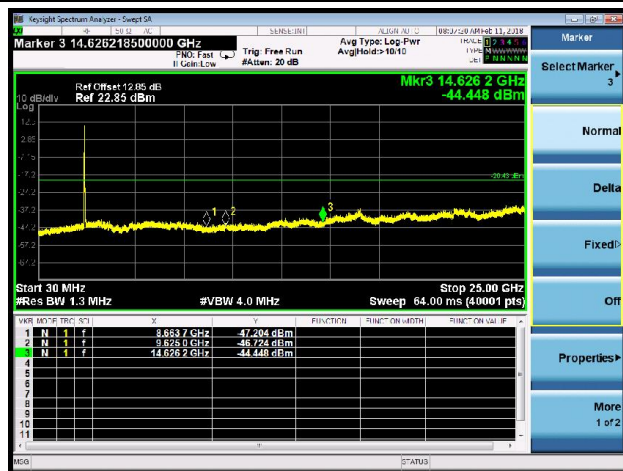

#### Channel 06 (2437MHz)

##### 100kHz PSD Reference Level

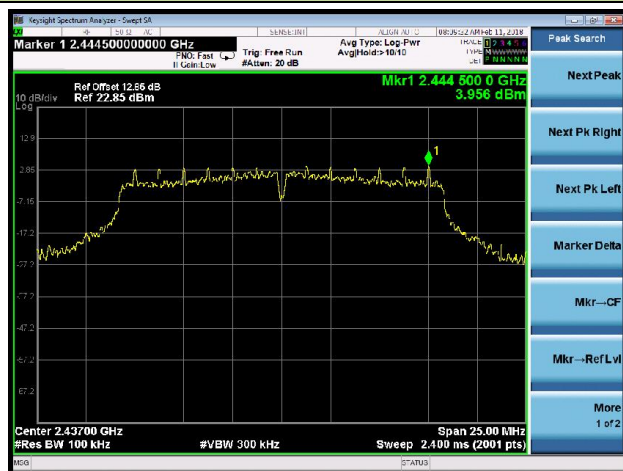

##### Spurious Emission

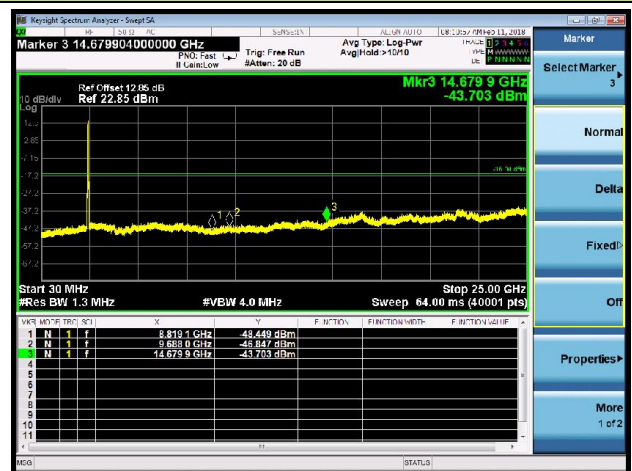

### Channel 11 (2462MHz)

#### 100kHz PSD Reference Level

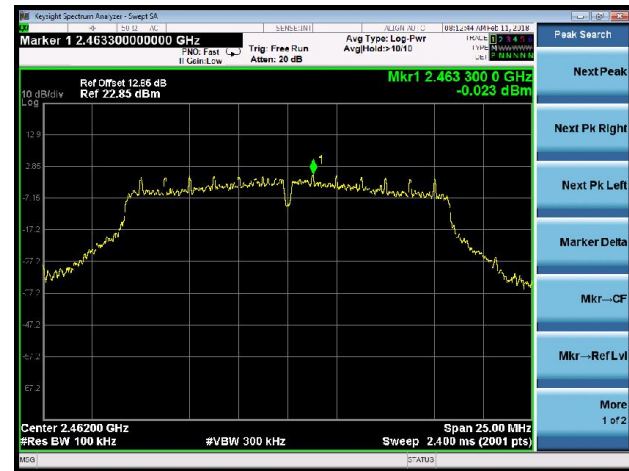

#### High Band Edge



#### Spurious Emission

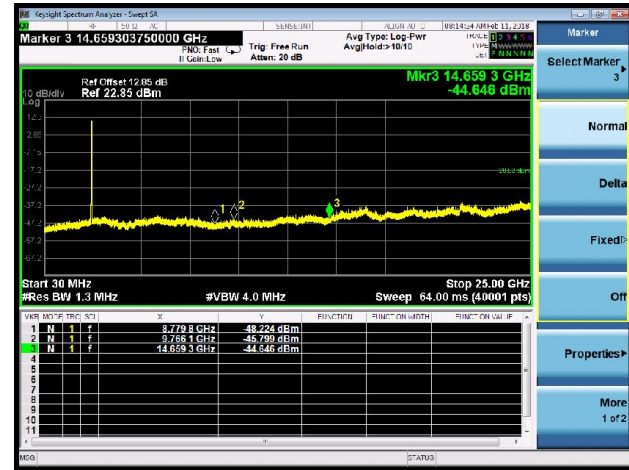

### 802.11n-HT20 Out-of-Band Emissions

#### Channel 01 (2412MHz)

##### 100kHz PSD Reference Level



##### Low Band Edge



##### Spurious Emission

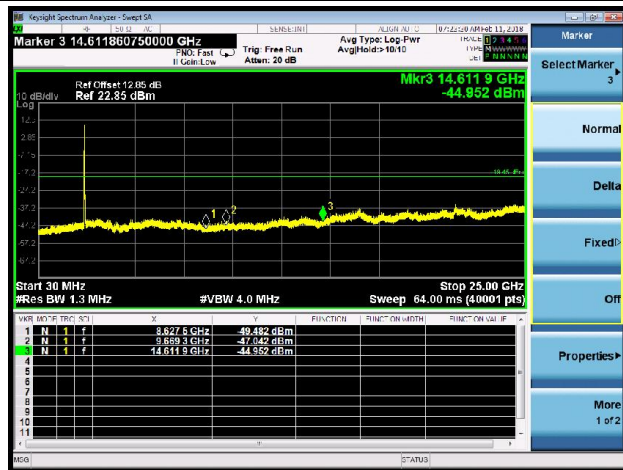

#### Channel 06 (2437MHz)

##### 100kHz PSD Reference Level

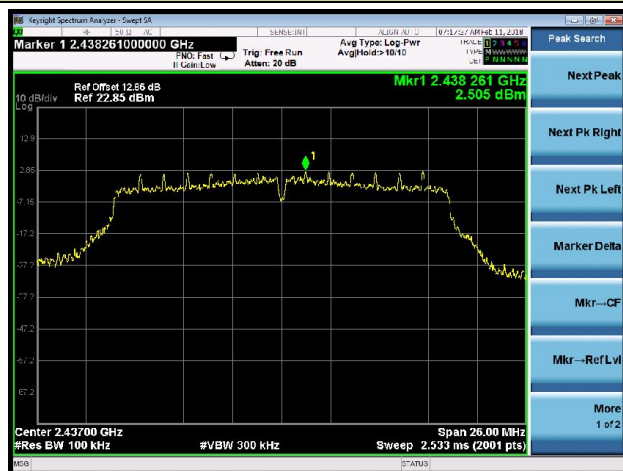

##### Spurious Emission

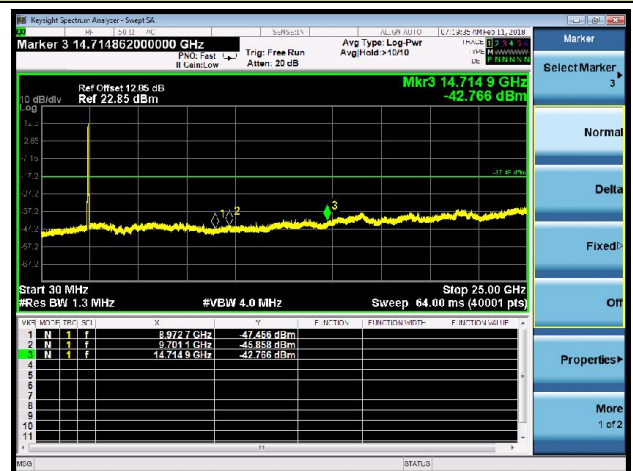

### Channel 11 (2462MHz)

#### 100kHz PSD Reference Level



#### High Band Edge

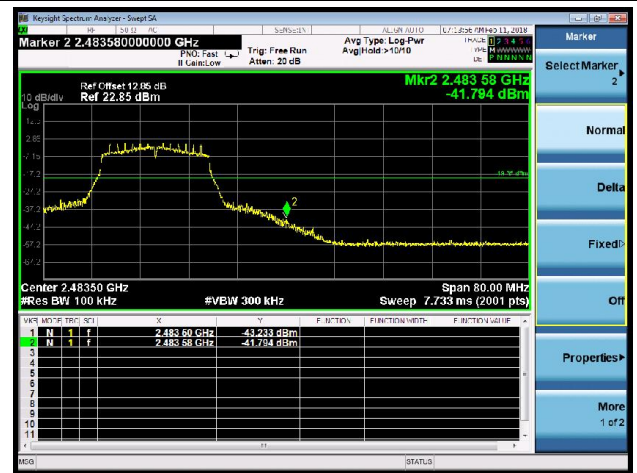

#### Spurious Emission

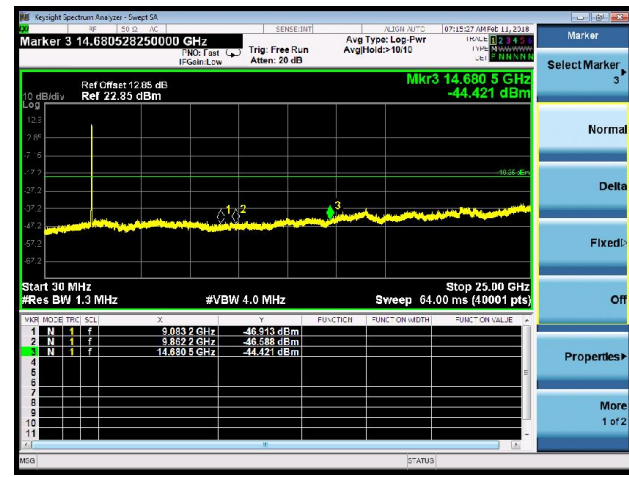

## 7.6. Radiated Spurious Emission Measurement

### 7.6.1. Test Limit

All out of band emissions appearing in a restricted band as specified in Section 15.205 of the Title 47 CFR must not exceed the limits shown in Table per Section 15.209.

FCC Part 15 Subpart C Paragraph 15.209		
Frequency [MHz]	Field Strength [uV/m]	Measured Distance [Meters]
0.009 - 0.490	2400/F (kHz)	300
0.490 - 1.705	24000/F (kHz)	30
1.705 - 30	30	30
30 - 88	100	3
88 - 216	150	3
216 - 960	200	3
Above 960	500	3

### 7.6.2. Test Procedure Used

ANSI C63.10 Section 6.3 (General Requirements)

ANSI C63.10 Section 6.4 (Standard test method below 30MHz)

ANSI C63.10 Section 6.5 (Standard test method above 30MHz to 1GHz)

ANSI C63.10 Section 6.6 (Standard test method above 1GHz)

### 7.6.3. Test Setting

#### Quasi-Peak Measurements below 1GHz

1. Analyzer center frequency was set to the frequency of the radiated spurious emission of interest
2. Span was set greater than 1MHz
3. RBW = as specified in Table 1
4. Detector = CISPR quasi-peak
5. Sweep time = auto couple
6. Trace was allowed to stabilize

**Table 1 - RBW as a function of frequency**

Frequency	RBW
9 ~ 150 kHz	200 ~ 300 Hz
0.15 ~ 30 MHz	9 ~ 10 kHz
30 ~ 1000 MHz	100 ~ 120 kHz

**Peak Measurements above 1GHz**

1. Analyzer center frequency was set to the frequency of the radiated spurious emission of interest
2. RBW = 1MHz
3. VBW = 3MHz
4. Detector = peak
5. Sweep time = auto couple
6. Trace mode = max hold
7. Trace was allowed to stabilize

**Average Measurements above 1GHz (Method VB)**

1. Analyzer center frequency was set to the frequency of the radiated spurious emission of interest
2. RBW = 1MHz
3. VBW; If the EUT is configured to transmit with duty cycle  $\geq 98\%$ , set VBW = 10 Hz.  
If the EUT duty cycle is  $< 98\%$ , set VBW  $\geq 1/T$ . T is the minimum transmission duration.
4. Detector = Peak
5. Sweep time = auto
6. Trace mode = max hold
7. Trace was allowed to stabilize



### 7.6.4. Test Setup

#### 9kHz ~ 30MHz Test Setup:

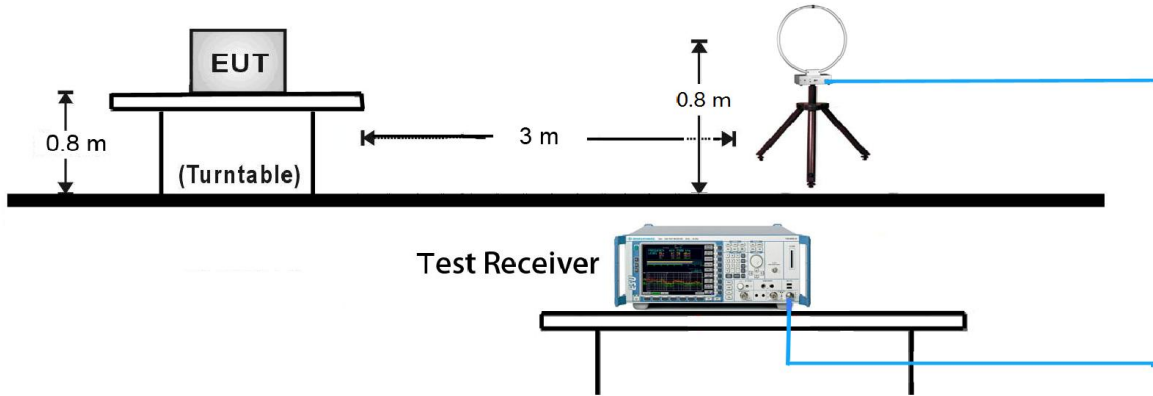

#### 30MHz ~ 1GHz Test Setup:

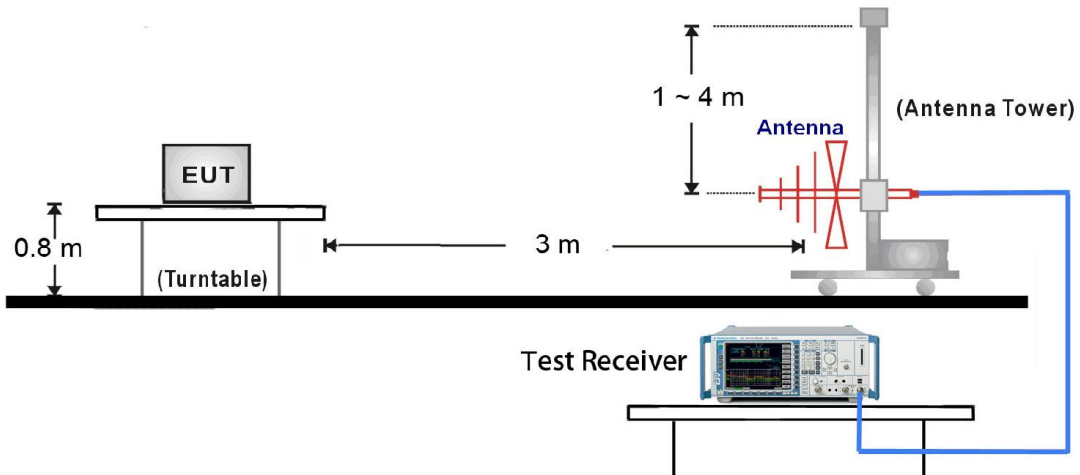

#### 1GHz ~ 25GHz Test Setup:

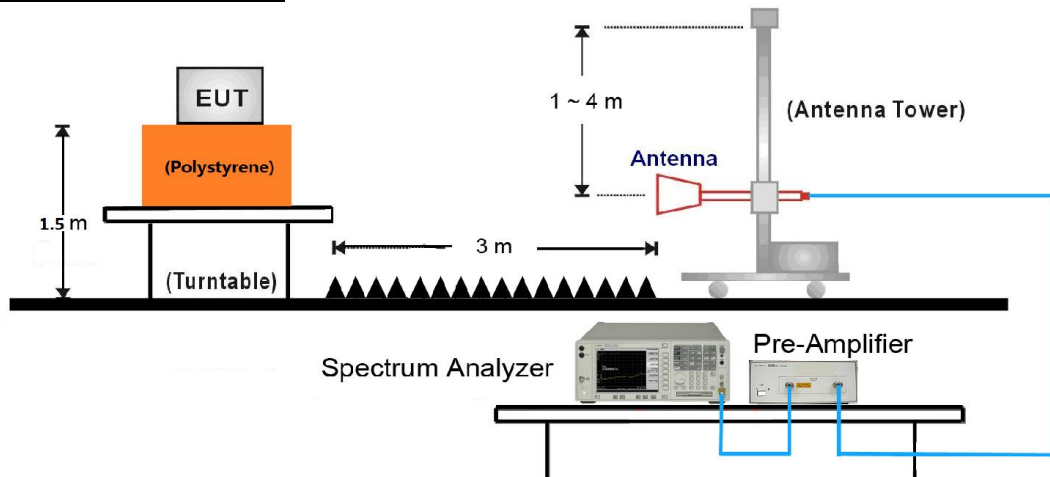

### 7.6.5. Test Result

Product	Communication Module	Temperature	26°C
Test Engineer	Dandy Li	Relative Humidity	56%
Test Site	AC1	Test Date	2018/03/09
Test Mode:	802.11b	Test Channel:	01
Remark:	1. Average measurement was not performed if peak level lower than average limit. 2. Other frequency was 20dB below limit line within 1-18GHz, there is not show in the report.		

Mark	Frequency (MHz)	Reading Level (dBμV)	Factor (dB)	Measure Level (dBμV/m)	Limit (dBμV/m)	Margin (dB)	Detector	Polarization
	7563.1	32.7	14.1	46.8	74.0	-27.2	Peak	Horizontal
	8277.9	31.1	14.0	45.1	74.0	-28.9	Peak	Horizontal
*	9993.6	30.1	17.4	47.5	88.6	-41.1	Peak	Horizontal
*	12893.9	28.8	21.1	49.9	88.6	-38.7	Peak	Horizontal
	7563.1	32.7	14.1	46.8	74.0	-27.2	Peak	Vertical
	8312.0	31.4	13.8	45.2	74.0	-28.8	Peak	Vertical
*	10211.5	31.2	18.2	49.4	88.6	-39.2	Peak	Vertical
*	12873.4	28.6	21.0	49.6	88.6	-39.0	Peak	Vertical

Note 1: "\*" is not in restricted band, its limit is 20dBc of the fundamental emission level (108.6dBμV/m) or 15.209 which is higher.

Note 2: Measure Level (dBμV/m) = Reading Level (dBμV) + Factor (dB)

Factor (dB) = Cable Loss (dB) + Antenna Factor (dB/m) - Pre\_Amplifier Gain (dB)

Product	Communication Module	Temperature	26°C
Test Engineer	Dandy Li	Relative Humidity	56%
Test Site	AC1	Test Date	2018/03/09
Test Mode:	802.11b	Test Channel:	06
Remark:	1. Average measurement was not performed if peak level lower than average limit. 2. Other frequency was 20dB below limit line within 1-18GHz, there is not show in the report.		

Mark	Frequency (MHz)	Reading Level (dBμV)	Factor (dB)	Measure Level (dBμV/m)	Limit (dBμV/m)	Margin (dB)	Detector	Polarization
	7481.4	32.2	14.0	46.2	74.0	-27.8	Peak	Horizontal
	8359.6	31.4	13.8	45.2	74.0	-28.8	Peak	Horizontal
*	9993.6	30.1	17.4	47.5	88.8	-41.3	Peak	Horizontal
*	12873.4	28.6	21.0	49.6	88.8	-39.2	Peak	Horizontal
	7481.4	32.2	14.0	46.2	74.0	-27.8	Peak	Vertical
	8427.7	31.8	13.9	45.7	74.0	-28.3	Peak	Vertical
*	10211.5	31.4	18.2	49.6	88.8	-39.2	Peak	Vertical
*	12893.9	29.8	21.1	50.9	88.8	-37.9	Peak	Vertical

Note 1: "\*" is not in restricted band, its limit is 20dBc of the fundamental emission level (108.8dBμV/m) or 15.209 which is higher.

Note 2: Measure Level (dBμV/m) = Reading Level (dBμV) + Factor (dB)

Factor (dB) = Cable Loss (dB) + Antenna Factor (dB/m) - Pre\_Amplifier Gain (dB)

Product	Communication Module	Temperature	26°C
Test Engineer	Dandy Li	Relative Humidity	56%
Test Site	AC1	Test Date	2018/03/09
Test Mode:	802.11b	Test Channel:	11
Remark:	1. Average measurement was not performed if peak level lower than average limit. 2. Other frequency was 20dB below limit line within 1-18GHz, there is not show in the report.		

Mark	Frequency (MHz)	Reading Level (dBμV)	Factor (dB)	Measure Level (dBμV/m)	Limit (dBμV/m)	Margin (dB)	Detector	Polarization
	7467.8	32.1	14.1	46.2	74.0	-27.8	Peak	Horizontal
	8386.9	32.4	13.8	46.2	74.0	-27.8	Peak	Horizontal
*	10122.9	32.3	18.0	50.3	88.9	-38.6	Peak	Horizontal
*	12893.9	29.8	21.1	50.9	88.9	-38.0	Peak	Horizontal
	7467.8	32.1	14.1	46.2	74.0	-27.8	Peak	Vertical
	8237.1	32.0	14.2	46.2	74.0	-27.8	Peak	Vertical
*	10075.3	30.7	17.5	48.2	88.9	-40.7	Peak	Vertical
*	12778.1	28.7	20.5	49.2	88.9	-39.7	Peak	Vertical

Note 1: "\*" is not in restricted band, its limit is 20dBc of the fundamental emission level (108.9dBμV/m) or 15.209 which is higher.

Note 2: Measure Level (dBμV/m) = Reading Level (dBμV) + Factor (dB)

Factor (dB) = Cable Loss (dB) + Antenna Factor (dB/m) - Pre\_Amplifier Gain (dB)

Product	Communication Module	Temperature	26°C
Test Engineer	Dandy Li	Relative Humidity	56%
Test Site	AC1	Test Date	2018/03/09
Test Mode:	802.11g	Test Channel:	01
Remark:	1. Average measurement was not performed if peak level lower than average limit. 2. Other frequency was 20dB below limit line within 1-18GHz, there is not show in the report.		

Mark	Frequency (MHz)	Reading Level (dBμV)	Factor (dB)	Measure Level (dBμV/m)	Limit (dBμV/m)	Margin (dB)	Detector	Polarization
	7501.8	32.7	14.1	46.8	74.0	-27.2	Peak	Horizontal
	8346.0	32.5	13.9	46.4	74.0	-27.6	Peak	Horizontal
*	9986.8	30.1	17.4	47.5	83.3	-35.8	Peak	Horizontal
*	12778.1	28.7	20.5	49.2	83.3	-34.1	Peak	Horizontal
	7501.8	32.7	14.1	46.8	74.0	-27.2	Peak	Vertical
	8284.7	32.3	13.9	46.2	74.0	-27.8	Peak	Vertical
*	10122.9	32.0	18.0	50.0	83.3	-33.3	Peak	Vertical
*	12893.9	29.8	21.1	50.9	83.3	-32.4	Peak	Vertical

Note 1: "\*" is not in restricted band, its limit is 20dBc of the fundamental emission level (103.3dBμV/m) or 15.209 which is higher.

Note 2: Measure Level (dBμV/m) = Reading Level (dBμV) + Factor (dB)

Factor (dB) = Cable Loss (dB) + Antenna Factor (dB/m) - Pre\_Amplifier Gain (dB)

Product	Communication Module	Temperature	26°C
Test Engineer	Dandy Li	Relative Humidity	56%
Test Site	AC1	Test Date	2018/03/09
Test Mode:	802.11g	Test Channel:	06
Remark:	1. Average measurement was not performed if peak level lower than average limit. 2. Other frequency was 20dB below limit line within 1-18GHz, there is not show in the report.		

Mark	Frequency (MHz)	Reading Level (dBμV)	Factor (dB)	Measure Level (dBμV/m)	Limit (dBμV/m)	Margin (dB)	Detector	Polarization
	7501.8	32.2	14.1	46.3	74.0	-27.7	Peak	Horizontal
	8400.5	30.8	13.8	44.6	74.0	-29.4	Peak	Horizontal
*	9952.7	30.5	17.3	47.8	83.6	-35.8	Peak	Horizontal
*	12893.9	29.8	21.1	50.9	83.6	-32.7	Peak	Horizontal
	7501.8	32.2	14.1	46.3	74.0	-27.7	Peak	Vertical
	8352.8	31.7	13.8	45.5	74.0	-28.5	Peak	Vertical
*	10197.8	31.4	18.1	49.5	83.6	-34.1	Peak	Vertical
*	12893.9	29.2	21.1	50.3	83.6	-33.3	Peak	Vertical

Note 1: "\*" is not in restricted band, its limit is 20dBc of the fundamental emission level (103.6dBμV/m) or 15.209 which is higher.

Note 2: Measure Level (dBμV/m) = Reading Level (dBμV) + Factor (dB)

Factor (dB) = Cable Loss (dB) + Antenna Factor (dB/m) - Pre\_Amplifier Gain (dB)

Product	Communication Module	Temperature	26°C
Test Engineer	Dandy Li	Relative Humidity	56%
Test Site	AC1	Test Date	2018/03/09
Test Mode:	802.11g	Test Channel:	11
Remark:	1. Average measurement was not performed if peak level lower than average limit. 2. Other frequency was 20dB below limit line within 1-18GHz, there is not show in the report.		

Mark	Frequency (MHz)	Reading Level (dBμV)	Factor (dB)	Measure Level (dBμV/m)	Limit (dBμV/m)	Margin (dB)	Detector	Polarization
	7556.3	32.7	14.2	46.9	74.0	-27.1	Peak	Horizontal
	8400.5	31.4	13.8	45.2	74.0	-28.8	Peak	Horizontal
*	9816.6	30.7	17.0	47.7	83.8	-36.1	Peak	Horizontal
*	12893.9	29.2	21.1	50.3	83.8	-33.5	Peak	Horizontal
	7556.3	32.7	14.2	46.9	74.0	-27.1	Peak	Vertical
	8495.8	33.5	14.2	47.7	74.0	-26.3	Peak	Vertical
*	10170.6	30.9	17.9	48.8	83.8	-35.0	Peak	Vertical
*	12893.9	29.9	21.1	51.0	83.8	-32.8	Peak	Vertical

Note 1: "\*" is not in restricted band, its limit is 20dBc of the fundamental emission level (103.8dBμV/m) or 15.209 which is higher.

Note 2: Measure Level (dBμV/m) = Reading Level (dBμV) + Factor (dB)

Factor (dB) = Cable Loss (dB) + Antenna Factor (dB/m) - Pre\_Amplifier Gain (dB)

Product	Communication Module	Temperature	26°C
Test Engineer	Dandy Li	Relative Humidity	56%
Test Site	AC1	Test Date	2018/03/09
Test Mode:	802.11n-HT20	Test Channel:	01
Remark:	1. Average measurement was not performed if peak level lower than average limit. 2. Other frequency was 20dB below limit line within 1-18GHz, there is not show in the report.		

Mark	Frequency (MHz)	Reading Level (dBμV)	Factor (dB)	Measure Level (dBμV/m)	Limit (dBμV/m)	Margin (dB)	Detector	Polarization
	7331.6	33.0	13.8	46.8	74.0	-27.2	Peak	Horizontal
	8441.3	31.0	13.9	44.9	74.0	-29.1	Peak	Horizontal
*	9993.6	30.3	17.4	47.7	82.9	-35.2	Peak	Horizontal
*	12893.9	29.9	21.1	51.0	82.9	-31.9	Peak	Horizontal
	7331.6	33.0	13.8	46.8	74.0	-27.2	Peak	Vertical
	8461.8	31.2	13.9	45.1	74.0	-28.9	Peak	Vertical
*	10184.2	32.4	18.0	50.4	82.9	-32.5	Peak	Vertical
*	12791.8	28.6	20.5	49.1	82.9	-33.8	Peak	Vertical

Note 1: "\*" is not in restricted band, its limit is 20dBc of the fundamental emission level (102.9dBμV/m) or 15.209 which is higher.

Note 2: Measure Level (dBμV/m) = Reading Level (dBμV) + Factor (dB)

Factor (dB) = Cable Loss (dB) + Antenna Factor (dB/m) - Pre\_Amplifier Gain (dB)



Product	Communication Module	Temperature	26°C
Test Engineer	Dandy Li	Relative Humidity	56%
Test Site	AC1	Test Date	2018/03/09
Test Mode:	802.11n-HT20	Test Channel:	06
Remark:	1. Average measurement was not performed if peak level lower than average limit. 2. Other frequency was 20dB below limit line within 1-18GHz, there is not show in the report.		

Mark	Frequency (MHz)	Reading Level (dBμV)	Factor (dB)	Measure Level (dBμV/m)	Limit (dBμV/m)	Margin (dB)	Detector	Polarization
	7420.1	32.3	14.1	46.4	74.0	-27.6	Peak	Horizontal
	8352.8	31.3	13.8	45.1	74.0	-28.9	Peak	Horizontal
*	9816.6	30.4	17.0	47.4	83.5	-36.1	Peak	Horizontal
*	12791.8	28.6	20.5	49.1	83.5	-34.4	Peak	Horizontal
	7420.1	32.3	14.1	46.4	74.0	-27.6	Peak	Vertical
	8386.9	32.2	13.8	46.0	74.0	-28.0	Peak	Vertical
*	10211.5	30.8	18.2	49.0	83.5	-34.5	Peak	Vertical
*	12784.9	28.5	20.5	49.0	83.5	-34.5	Peak	Vertical

Note 1: "\*" is not in restricted band, its limit is 20dBc of the fundamental emission level (103.5dBμV/m) or 15.209 which is higher.

Note 2: Measure Level (dBμV/m) = Reading Level (dBμV) + Factor (dB)

Factor (dB) = Cable Loss (dB) + Antenna Factor (dB/m) - Pre\_Amplifier Gain (dB)

Product	Communication Module	Temperature	26°C
Test Engineer	Dandy Li	Relative Humidity	56%
Test Site	AC1	Test Date	2018/03/09
Test Mode:	802.11n-HT20	Test Channel:	11
Remark:	1. Average measurement was not performed if peak level lower than average limit. 2. Other frequency was 20dB below limit line within 1-18GHz, there is not show in the report.		

Mark	Frequency (MHz)	Reading Level (dBμV)	Factor (dB)	Measure Level (dBμV/m)	Limit (dBμV/m)	Margin (dB)	Detector	Polarization
	7399.7	31.9	13.9	45.8	74.0	-28.2	Peak	Horizontal
	8427.7	31.2	13.9	45.1	74.0	-28.9	Peak	Horizontal
*	9877.9	30.6	17.3	47.9	83.8	-35.9	Peak	Horizontal
*	12784.9	28.5	20.5	49.0	83.8	-34.8	Peak	Horizontal
	7426.9	32.1	14.2	46.3	74.0	-27.7	Peak	Vertical
	8312.0	31.4	13.8	45.2	74.0	-28.8	Peak	Vertical
*	10000.4	30.0	17.5	47.5	83.8	-36.3	Peak	Vertical
*	12723.7	28.1	20.3	48.4	83.8	-35.4	Peak	Vertical

Note 1: "\*" is not in restricted band, its limit is 20dBc of the fundamental emission level (103.8dBμV/m) or 15.209 which is higher.

Note 2: Measure Level (dBμV/m) = Reading Level (dBμV) + Factor (dB)

Factor (dB) = Cable Loss (dB) + Antenna Factor (dB/m) - Pre\_Amplifier Gain (dB)

**The worst case of Radiated Emission below 1GHz:**

Site: AC1	Time: 2018/03/15 - 16:57
Limit: FCC_Part15.209_RSE(3m)	Engineer: Alex Ma
Probe: VULB 9168 _20-2000MHz	Polarity: Horizontal
EUT: Communication Module	Power: DC 3.3V
<b>Note: There is the worst case within frequency range 30MHz~1GHz.</b>	

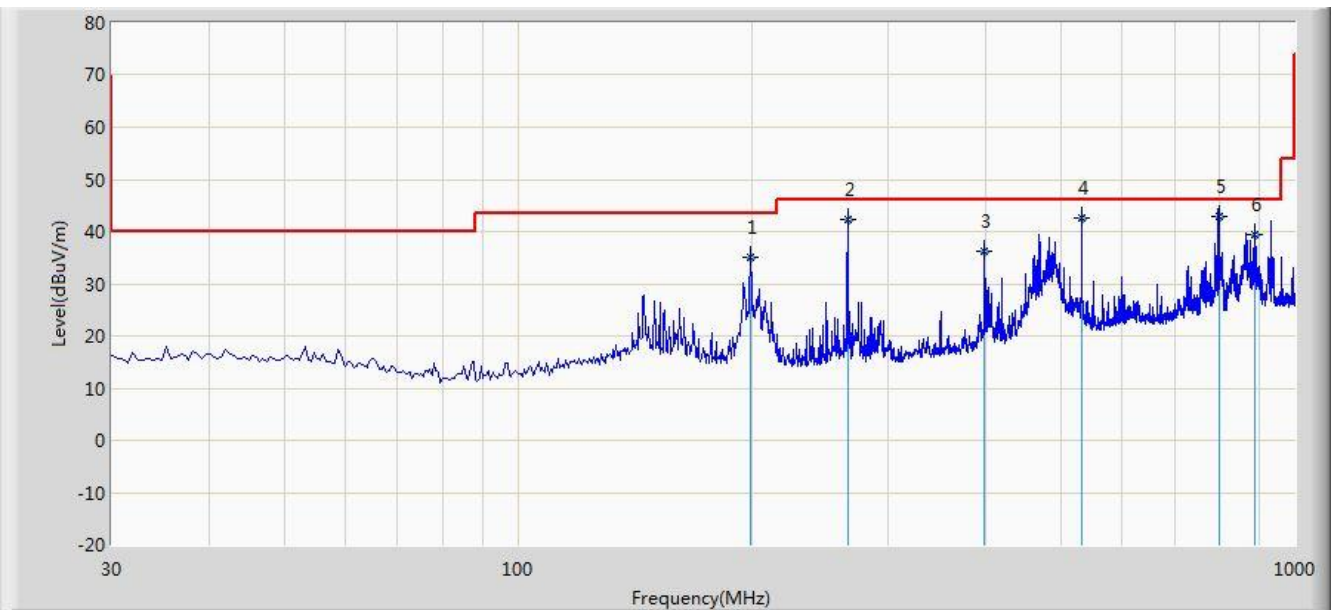

No	Flag	Mark	Frequency (MHz)	Measure Level (dBuV/m)	Reading Level (dBuV)	Margin (dB)	Limit (dBuV/m)	Factor (dB)	Type
1			199.265	35.084	23.841	-8.416	43.500	11.243	QP
2			265.710	42.343	28.893	-3.657	46.000	13.450	QP
3			399.058	36.182	19.616	-9.818	46.000	16.567	QP
4			531.984	42.707	23.495	-3.293	46.000	19.212	QP
5		*	798.240	43.036	19.734	-2.964	46.000	23.302	QP
6			886.995	39.417	15.168	-6.583	46.000	24.249	QP

Note 1: Measure Level (dBuV/m) = Reading Level (dBuV) + Factor (dB)

Factor (dB) = Cable Loss (dB) + Antenna Factor (dB/m)

Note 2: The test trace is same as the ambient noise and the amplitude of the emissions are attenuated more than 20dB below the permissible (the test frequency range: 9kHz ~ 30MHz, 18GHz ~ 25GHz), therefore no data appear in the report.

Site: AC1	Time: 2018/03/15 - 16:58
Limit: FCC_Part15.209_RSE(3m)	Engineer: Alex Ma
Probe: VULB 9168 _20-2000MHz	Polarity: Vertical
EUT: Communication Module	Power: DC 3.3V
<b>Note: There is the worst case within frequency range 30MHz~1GHz.</b>	

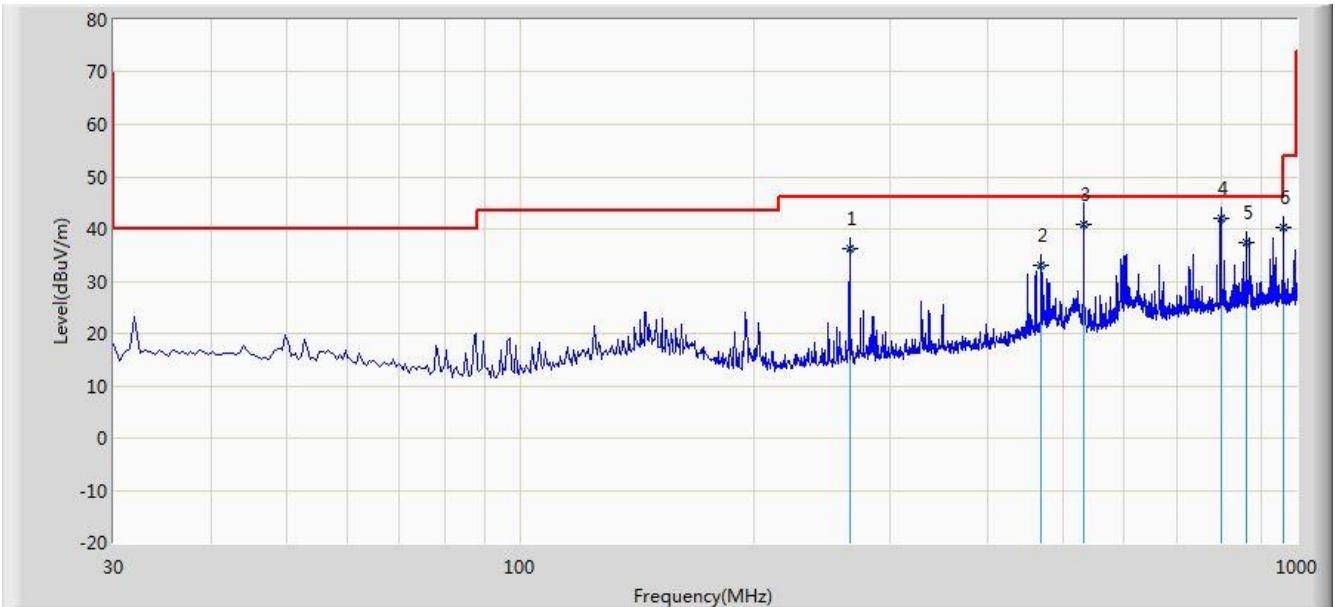

No	Flag	Mark	Frequency (MHz)	Measure Level (dBuV/m)	Reading Level (dBuV)	Margin (dB)	Limit (dBuV/m)	Factor (dB)	Type
1			265.740	36.149	22.698	-9.851	46.000	13.451	QP
2			469.410	33.142	14.987	-12.858	46.000	18.156	QP
3			531.978	40.817	21.605	-5.183	46.000	19.212	QP
4		*	798.240	42.074	18.772	-3.926	46.000	23.302	QP
5			860.320	37.302	13.429	-8.698	46.000	23.873	QP
6			960.230	40.183	15.141	-13.817	54.000	25.041	QP

Note 1: Measure Level (dBuV/m) = Reading Level (dBuV) + Factor (dB)

Factor (dB) = Cable Loss (dB) + Antenna Factor (dB/m)

Note 2: The test trace is same as the ambient noise and the amplitude of the emissions are attenuated more than 20dB below the permissible (the test frequency range: 9kHz ~ 30MHz, 18GHz ~ 25GHz), therefore no data appear in the report.

## 7.7. Radiated Restricted Band Edge Measurement

### 7.7.1. Test Limit

#### **For 15.205 requirement:**

Radiated emissions which fall in the restricted bands, as defined in Section 15.205(a) of FCC part 15, must also comply with the radiated emission limits specified in Section 15.209(a).

Frequency (MHz)	Frequency (MHz)	Frequency (MHz)	Frequency (GHz)
0.090 - 0.110	16.42 - 16.423	399.9 - 410	4.5 - 5.15
<sup>1</sup> 0.495 - 0.505	16.69475 - 16.69525	608 - 614	5.35 - 5.46
2.1735 - 2.1905	16.80425 - 16.80475	960 - 1240	7.25 - 7.75
4.125 - 4.128	25.5 - 25.67	1300 - 1427	8.25 - 8.5
4.17725 - 4.17775	37.5 - 38.25	1435 - 1626.5	9.0 - 9.2
4.20725 - 4.20775	73 - 74.6	1645.5 - 1646.5	9.3 - 9.5
6.215 - 6.218	74.8 - 75.2	1660 - 1710	10.6 - 12.7
6.26775 - 6.26825	108 - 121.94	1718.8 - 1722.2	13.25 - 13.4
6.31175 - 6.31225	123 - 138	2200 - 2300	14.47 - 14.5
8.291 - 8.294	149.9 - 150.05	2310 - 2390	15.35 - 16.2
8.362 - 8.366	156.52475 - 156.525	2483.5 - 2500	17.7 - 21.4
8.37625 - 8.38675	156.7 - 156.9	2690 - 2900	22.01 - 23.12
8.41425 - 8.41475	162.0125 - 167.17	3260 - 3267	23.6 - 24.0
12.29 - 12.293	167.72 - 173.2	3332 - 3339	31.2 - 31.8
12.51975 - 12.52025	240 - 285	3345.8 - 3358	36.43 - 36.5
12.57675 - 12.57725	322 - 335.4	3600 - 4400	( <sup>2</sup> )
13.36 - 13.41	--	--	--

All out of band emissions appearing in a restricted band as specified in Section 15.205 of the Title 47CFR must not exceed the limits shown in Table per Section 15.209.

FCC Part 15 Subpart C Paragraph 15.209		
Frequency [MHz]	Field Strength [uV/m]	Measured Distance [Meters]
0.009 – 0.490	2400/F (kHz)	300
0.490 – 1.705	24000/F (kHz)	30
1.705 - 30	30	30
30 - 88	100	3
88 - 216	150	3
216 - 960	200	3
Above 960	500	3

**7.7.2. Test Procedure Used**

ANSI C63.10 Section 6.3 (General Requirements)

ANSI C63.10 Section 6.6 (Standard test method above 1GHz)

**7.7.3. Test Setting**

**Peak Field Strength Measurements**

1. Analyzer center frequency was set to the frequency of the radiated spurious emission of interest
2. RBW = 1MHz
3. VBW = 3MHz
4. Detector = peak
5. Sweep time = auto couple
6. Trace mode = max hold
7. Trace was allowed to stabilize

### Average Measurements above 1GHz (Method VB)

1. Analyzer center frequency was set to the frequency of the radiated spurious emission of interest
2. RBW = 1MHz
3. VBW; If the EUT is configured to transmit with duty cycle  $\geq 98\%$ , set VBW = 10 Hz.  
If the EUT duty cycle is  $< 98\%$ , set VBW  $\geq 1/T$ . T is the minimum transmission duration.
4. Detector = Peak
5. Sweep time = auto
6. Trace mode = max hold
7. Trace was allowed to stabilize

#### **7.7.4. Test Setup**

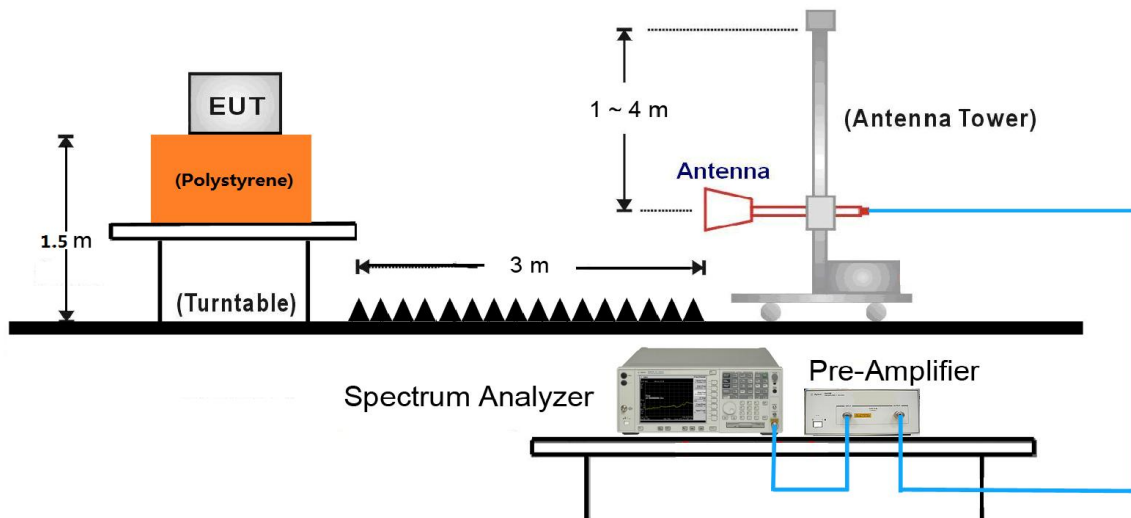

Note: This item was performed with the WIFI antenna connected.

### 7.7.5. Test Result

Site: AC1	Time: 2018/03/08 - 01:50
Limit: FCC_Part15.209_RE(3m)	Engineer: Jone Zhang
Probe: BBHA9120D_1-18GHz	Polarity: Horizontal
EUT: Communication Module	Power: DC 3.3V
Test Mode: Transmit by 802.11b at Channel 2412MHz	

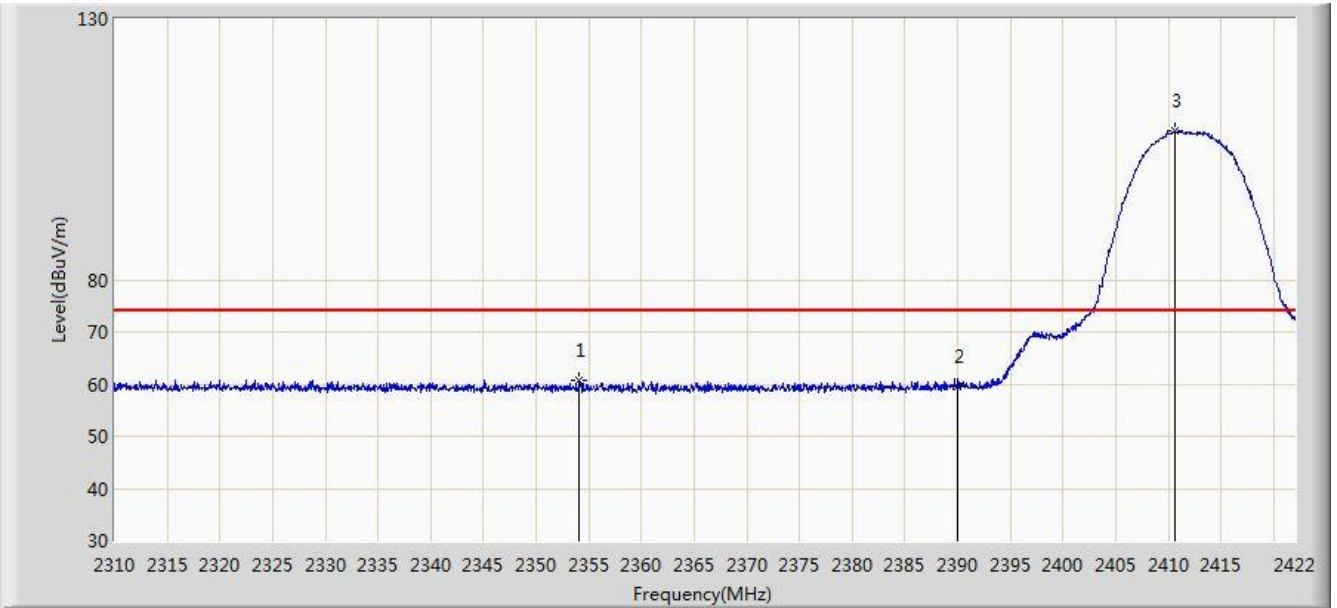

No	Flag	Mark	Frequency (MHz)	Measure Level (dBuV/m)	Reading Level (dBuV)	Over Limit (dB)	Limit (dBuV/m)	Factor (dB)	Type
1			2354.072	60.736	28.099	-13.264	74.000	32.637	PK
2			2390.000	59.709	27.134	-14.291	74.000	32.575	PK
3		*	2410.576	108.568	76.018	N/A	N/A	32.549	PK

Note: Measure Level (dB $\mu$ V/m) = Reading Level (dB $\mu$ V) + Factor (dB)

Factor (dB) = Cable Loss (dB) + Antenna Factor (dB/m)



Site: AC1	Time: 2018/03/08 - 01:59
Limit: FCC_Part15.209_RE(3m)	Engineer: Jone Zhang
Probe: BBHA9120D_1-18GHz	Polarity: Horizontal
EUT: Communication Module	Power: DC 3.3V
Test Mode: Transmit by 802.11b at Channel 2412MHz	

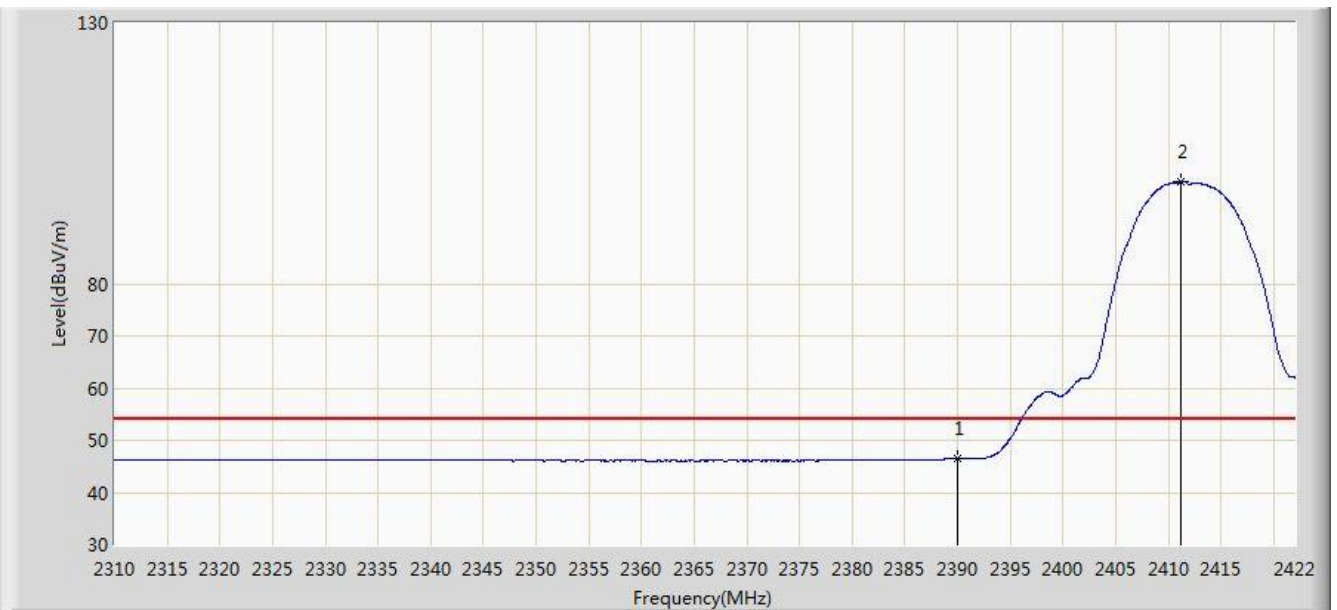

No	Flag	Mark	Frequency (MHz)	Measure Level (dBuV/m)	Reading Level (dBuV)	Over Limit (dB)	Limit (dBuV/m)	Factor (dB)	Type
1			2390.000	46.473	13.898	-7.527	54.000	32.575	AV
2		*	2411.248	99.537	66.988	N/A	N/A	32.549	AV

Note: Measure Level (dB $\mu$ V/m) = Reading Level (dB $\mu$ V) + Factor (dB)

Factor (dB) = Cable Loss (dB) + Antenna Factor (dB/m)

Site: AC1	Time: 2018/03/08 - 02:01
Limit: FCC_Part15.209_RE(3m)	Engineer: Jone Zhang
Probe: BBHA9120D_1-18GHz	Polarity: Vertical
EUT: Communication Module	Power: DC 3.3V
Test Mode: Transmit by 802.11b at Channel 2412MHz	

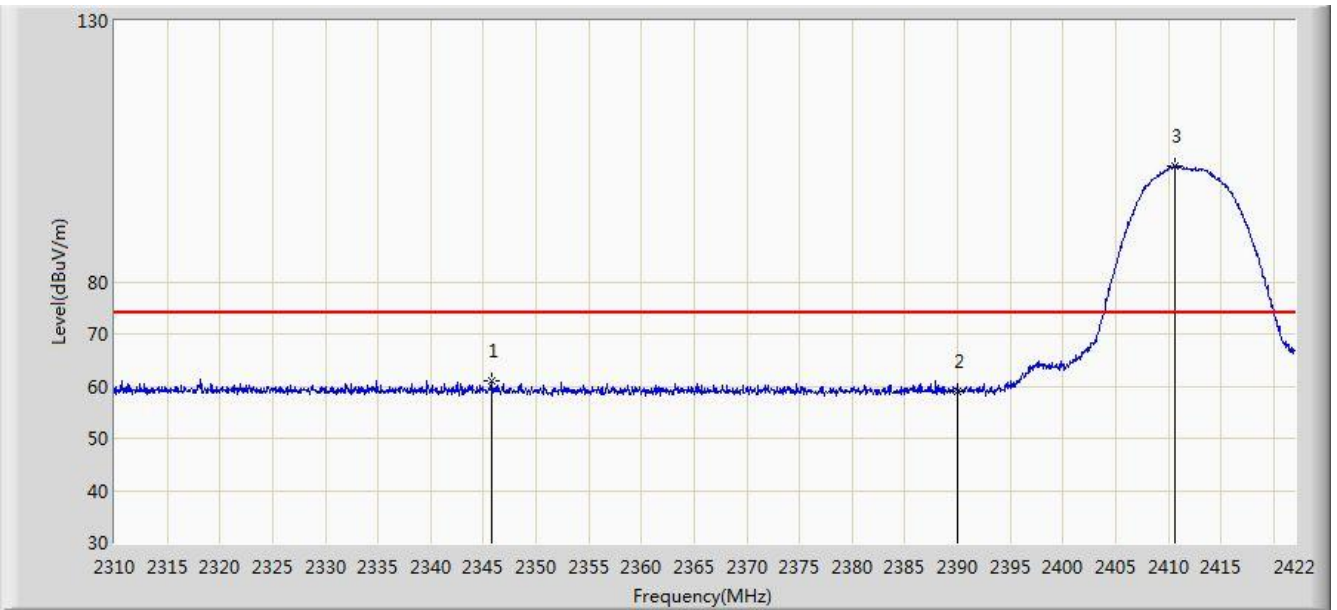

No	Flag	Mark	Frequency (MHz)	Measure Level (dBuV/m)	Reading Level (dBuV)	Over Limit (dB)	Limit (dBuV/m)	Factor (dB)	Type
1			2345.728	60.908	28.245	-13.092	74.000	32.663	PK
2			2390.000	59.010	26.435	-14.990	74.000	32.575	PK
3		*	2410.688	102.298	69.748	N/A	N/A	32.550	PK

Note: Measure Level (dB $\mu$ V/m) = Reading Level (dB $\mu$ V) + Factor (dB)

Factor (dB) = Cable Loss (dB) + Antenna Factor (dB/m)

Site: AC1	Time: 2018/03/08 - 02:04
Limit: FCC_Part15.209_RE(3m)	Engineer: Jone Zhang
Probe: BBHA9120D_1-18GHz	Polarity: Vertical
EUT: Communication Module	Power: DC 3.3V
Test Mode: Transmit by 802.11b at Channel 2412MHz	

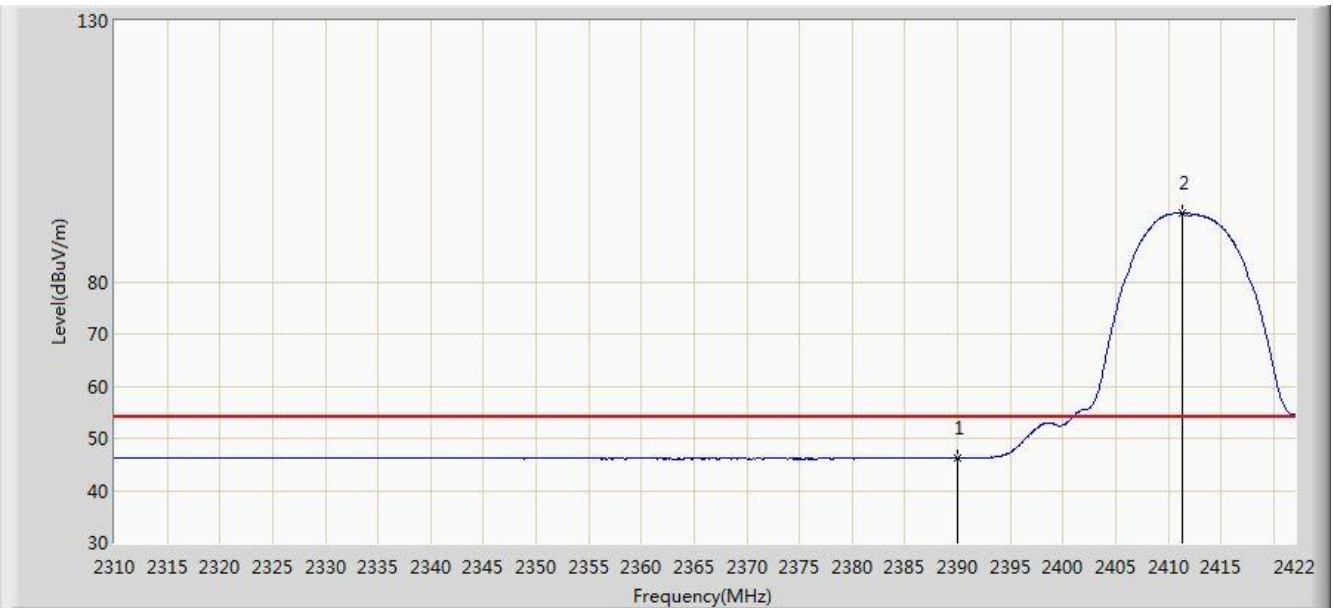

No	Flag	Mark	Frequency (MHz)	Measure Level (dBuV/m)	Reading Level (dBuV)	Over Limit (dB)	Limit (dBuV/m)	Factor (dB)	Type
1			2390.000	46.265	13.690	-7.735	54.000	32.575	AV
2		*	2411.304	93.199	60.650	N/A	N/A	32.549	AV

Note: Measure Level (dB $\mu$ V/m) = Reading Level (dB $\mu$ V) + Factor (dB)

Factor (dB) = Cable Loss (dB) + Antenna Factor (dB/m)

Site: AC1	Time: 2018/03/08 - 02:05
Limit: FCC_Part15.209_RE(3m)	Engineer: Jone Zhang
Probe: BBHA9120D_1-18GHz	Polarity: Horizontal
EUT: Communication Module	Power: DC 3.3V
Test Mode: Transmit by 802.11b at Channel 2462MHz	

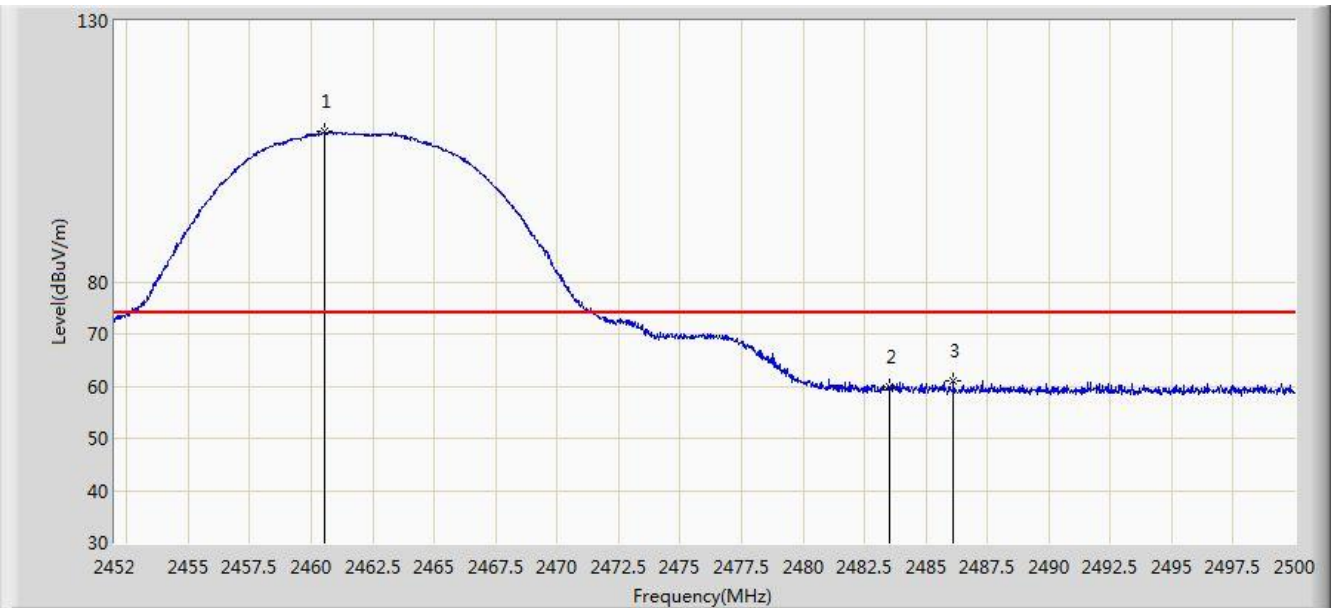

No	Flag	Mark	Frequency (MHz)	Measure Level (dBuV/m)	Reading Level (dBuV)	Over Limit (dB)	Limit (dBuV/m)	Factor (dB)	Type
1		*	2460.568	108.872	76.335	N/A	N/A	32.537	PK
2			2483.500	59.722	27.126	-14.278	74.000	32.596	PK
3			2486.128	61.114	28.512	-12.886	74.000	32.602	PK

Note: Measure Level (dB $\mu$ V/m) = Reading Level (dB $\mu$ V) + Factor (dB)

Factor (dB) = Cable Loss (dB) + Antenna Factor (dB/m)

Site: AC1	Time: 2018/03/08 - 02:09
Limit: FCC_Part15.209_RE(3m)	Engineer: Jone Zhang
Probe: BBHA9120D_1-18GHz	Polarity: Horizontal
EUT: Communication Module	Power: DC 3.3V
Test Mode: Transmit by 802.11b at Channel 2462MHz	

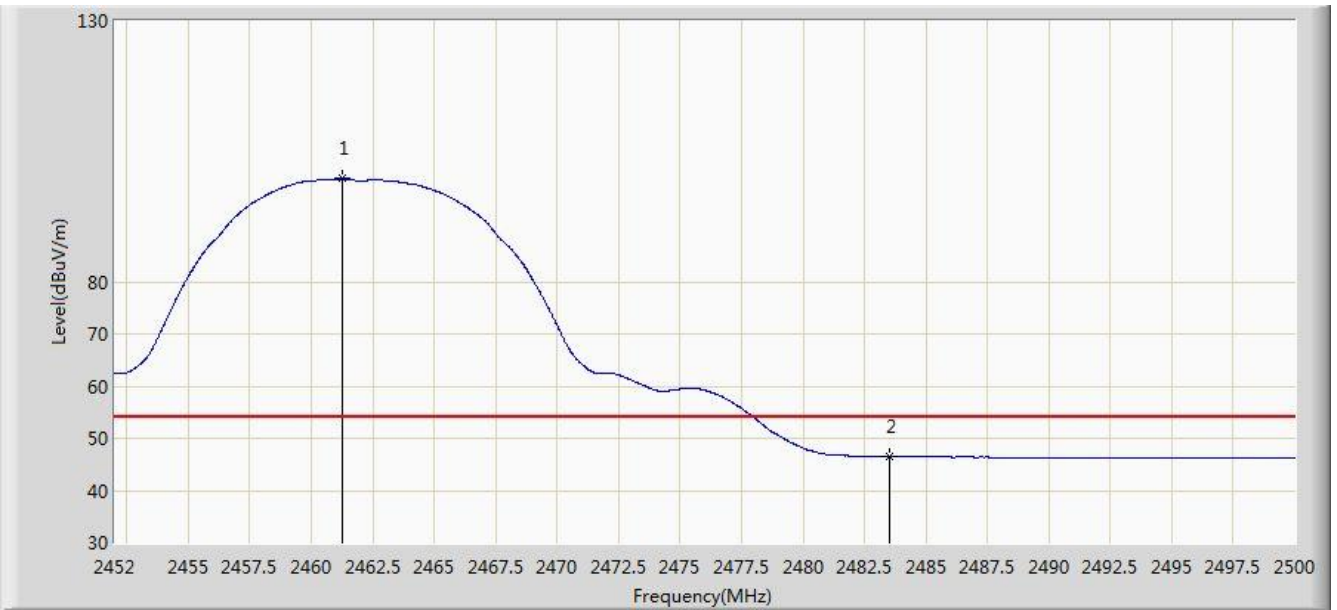

No	Flag	Mark	Frequency (MHz)	Measure Level (dBuV/m)	Reading Level (dBuV)	Over Limit (dB)	Limit (dBuV/m)	Factor (dB)	Type
1		*	2461.288	99.730	67.191	N/A	N/A	32.539	AV
2			2483.500	46.622	14.026	-7.378	54.000	32.596	AV

Note: Measure Level (dBμV/m) = Reading Level (dBμV) + Factor (dB)

Factor (dB) = Cable Loss (dB) + Antenna Factor (dB/m)

Site: AC1	Time: 2018/03/08 - 02:09
Limit: FCC_Part15.209_RE(3m)	Engineer: Jone Zhang
Probe: BBHA9120D_1-18GHz	Polarity: Vertical
EUT: Communication Module	Power: DC 3.3V
Test Mode: Transmit by 802.11b at Channel 2462MHz	

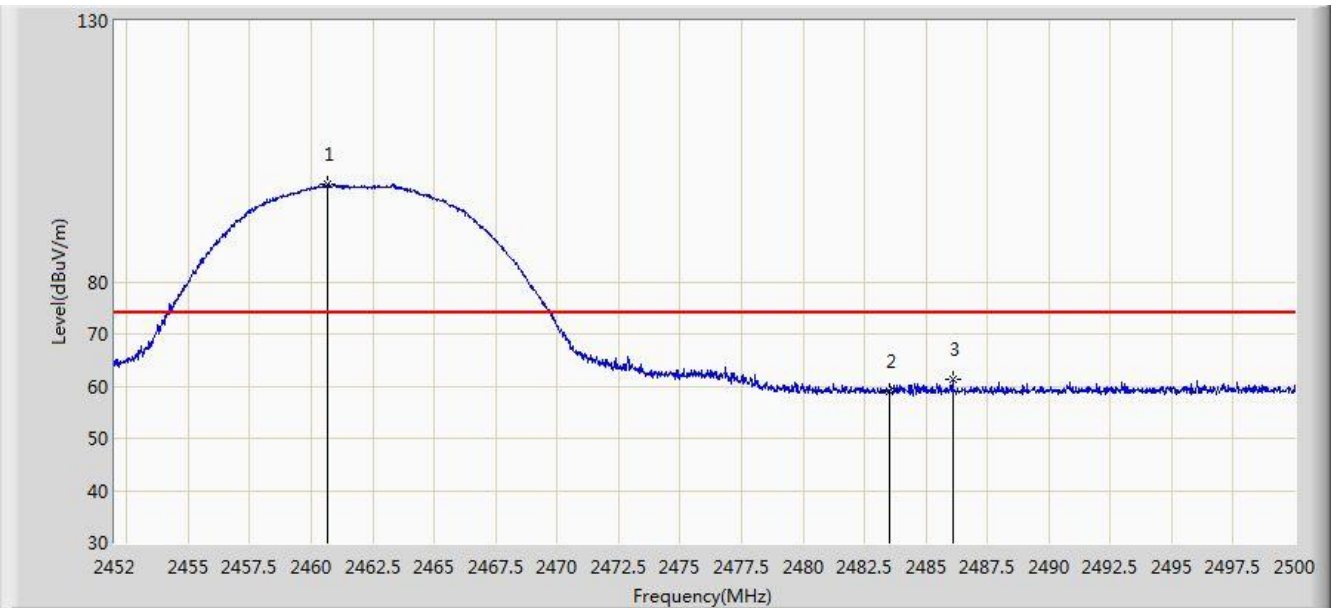

No	Flag	Mark	Frequency (MHz)	Measure Level (dBuV/m)	Reading Level (dBuV)	Over Limit (dB)	Limit (dBuV/m)	Factor (dB)	Type
1		*	2460.640	98.660	66.123	N/A	N/A	32.537	PK
2			2483.500	58.996	26.400	-15.004	74.000	32.596	PK
3			2486.104	61.383	28.781	-12.617	74.000	32.602	PK

Note: Measure Level (dBμV/m) = Reading Level (dBμV) + Factor (dB)

Factor (dB) = Cable Loss (dB) + Antenna Factor (dB/m)

Site: AC1	Time: 2018/03/08 - 02:12
Limit: FCC_Part15.209_RE(3m)	Engineer: Jone Zhang
Probe: BBHA9120D_1-18GHz	Polarity: Vertical
EUT: Communication Module	Power: DC 3.3V
Test Mode: Transmit by 802.11b at Channel 2462MHz	

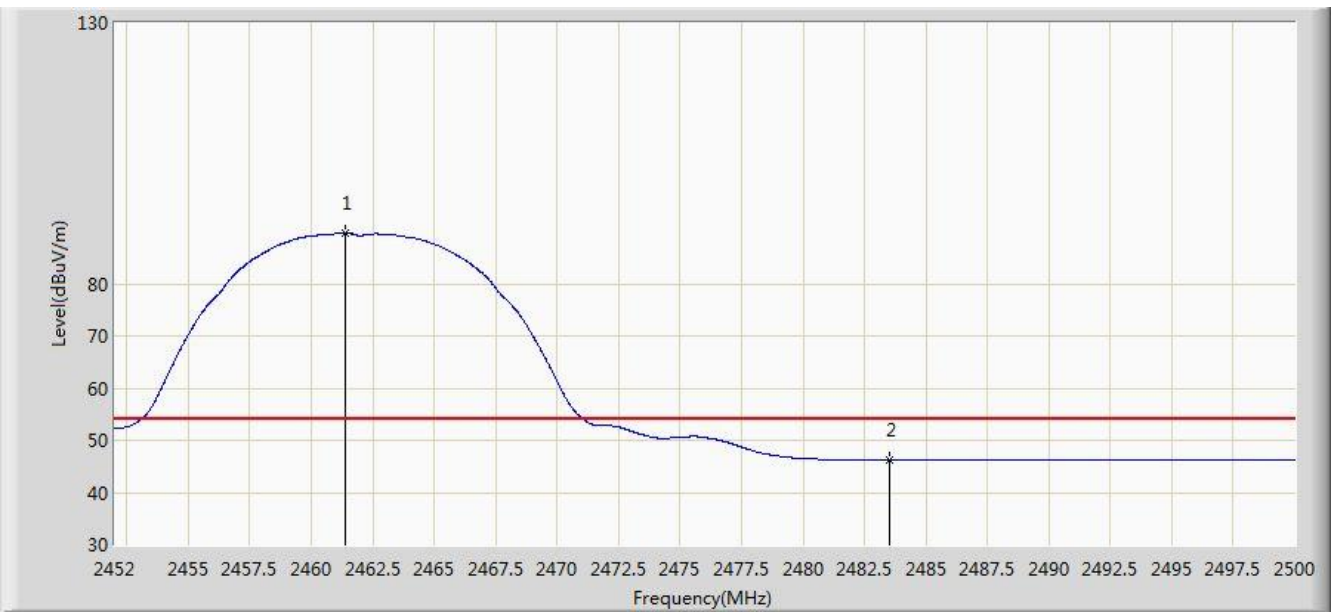

No	Flag	Mark	Frequency (MHz)	Measure Level (dBuV/m)	Reading Level (dBuV)	Over Limit (dB)	Limit (dBuV/m)	Factor (dB)	Type
1		*	2461.384	89.694	57.155	N/A	N/A	32.539	AV
2			2483.500	46.305	13.709	-7.695	54.000	32.596	AV

Note: Measure Level (dBμV/m) = Reading Level (dBμV) + Factor (dB)

Factor (dB) = Cable Loss (dB) + Antenna Factor (dB/m)

Site: AC1	Time: 2018/03/08 - 02:13
Limit: FCC_Part15.209_RE(3m)	Engineer: Jone Zhang
Probe: BBHA9120D_1-18GHz	Polarity: Horizontal
EUT: Communication Module	Power: DC 3.3V
Test Mode: Transmit by 802.11g at Channel 2412MHz	



No	Flag	Mark	Frequency (MHz)	Measure Level (dBuV/m)	Reading Level (dBuV)	Over Limit (dB)	Limit (dBuV/m)	Factor (dB)	Type
1			2389.800	69.962	37.387	-4.038	74.000	32.575	PK
2			2390.000	69.196	36.621	-4.804	74.000	32.575	PK
3		*	2411.248	103.260	70.711	N/A	N/A	32.549	PK

Note: Measure Level (dB $\mu$ V/m) = Reading Level (dB $\mu$ V) + Factor (dB)

Factor (dB) = Cable Loss (dB) + Antenna Factor (dB/m)



Site: AC1	Time: 2018/03/08 - 02:16
Limit: FCC_Part15.209_RE(3m)	Engineer: Jone Zhang
Probe: BBHA9120D_1-18GHz	Polarity: Horizontal
EUT: Communication Module	Power: DC 3.3V
Test Mode: Transmit by 802.11g at Channel 2412MHz	

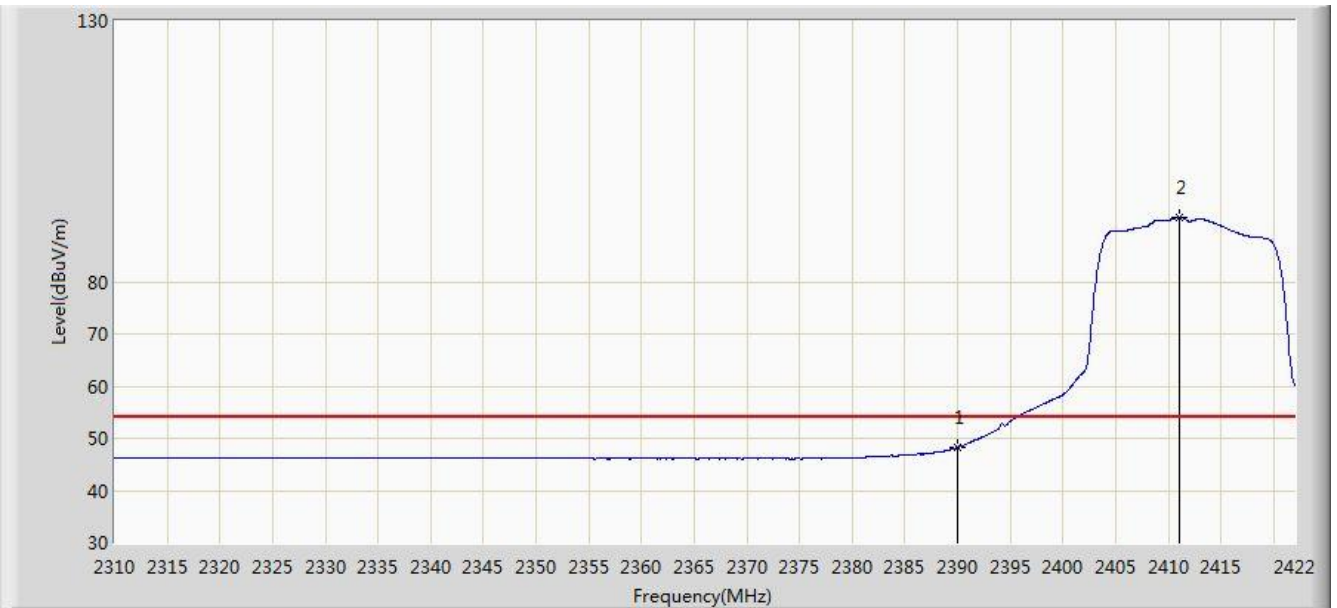

No	Flag	Mark	Frequency (MHz)	Measure Level (dBuV/m)	Reading Level (dBuV)	Over Limit (dB)	Limit (dBuV/m)	Factor (dB)	Type
1			2390.000	48.278	15.703	-5.722	54.000	32.575	AV
2		*	2411.024	92.354	59.805	N/A	N/A	32.549	AV

Note: Measure Level (dB $\mu$ V/m) = Reading Level (dB $\mu$ V) + Factor (dB)

Factor (dB) = Cable Loss (dB) + Antenna Factor (dB/m)

Site: AC1	Time: 2018/03/08 - 02:19
Limit: FCC_Part15.209_RE(3m)	Engineer: Jone Zhang
Probe: BBHA9120D_1-18GHz	Polarity: Vertical
EUT: Communication Module	Power: DC 3.3V
Test Mode: Transmit by 802.11g at Channel 2412MHz	

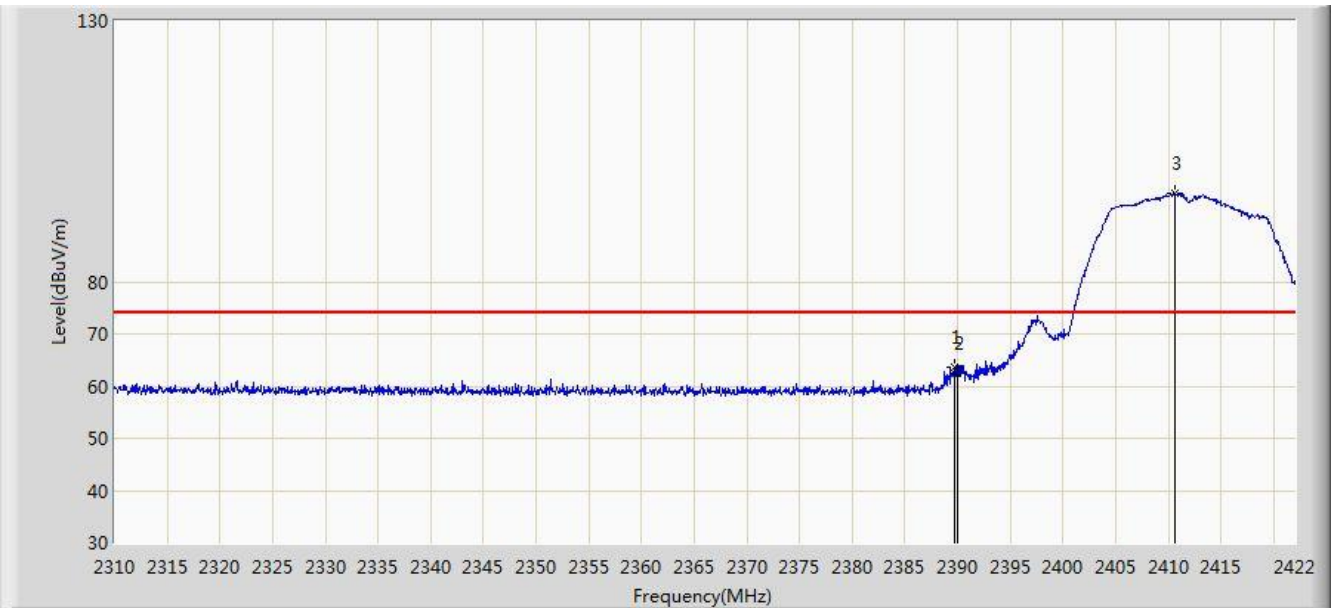

No	Flag	Mark	Frequency (MHz)	Measure Level (dBuV/m)	Reading Level (dBuV)	Over Limit (dB)	Limit (dBuV/m)	Factor (dB)	Type
1			2389.688	63.502	30.927	-10.498	74.000	32.575	PK
2			2390.000	62.573	29.998	-11.427	74.000	32.575	PK
3		*	2410.576	96.938	64.388	N/A	N/A	32.549	PK

Note: Measure Level (dB $\mu$ V/m) = Reading Level (dB $\mu$ V) + Factor (dB)

Factor (dB) = Cable Loss (dB) + Antenna Factor (dB/m)

Site: AC1	Time: 2018/03/08 - 02:21
Limit: FCC_Part15.209_RE(3m)	Engineer: Jone Zhang
Probe: BBHA9120D_1-18GHz	Polarity: Vertical
EUT: Communication Module	Power: DC 3.3V
Test Mode: Transmit by 802.11g at Channel 2412MHz	

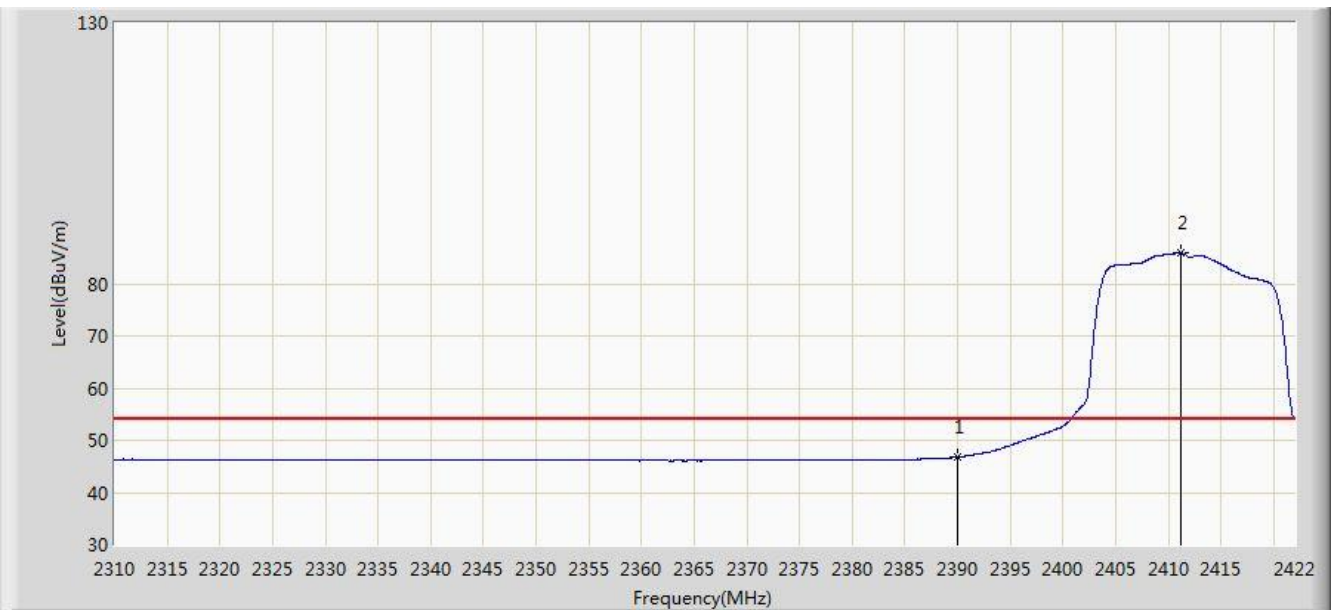

No	Flag	Mark	Frequency (MHz)	Measure Level (dBuV/m)	Reading Level (dBuV)	Over Limit (dB)	Limit (dBuV/m)	Factor (dB)	Type
1			2390.000	46.779	14.204	-7.221	54.000	32.575	AV
2		*	2411.136	85.968	53.419	N/A	N/A	32.549	AV

Note: Measure Level (dB $\mu$ V/m) = Reading Level (dB $\mu$ V) + Factor (dB)

Factor (dB) = Cable Loss (dB) + Antenna Factor (dB/m)

Site: AC1	Time: 2018/03/08 - 02:22
Limit: FCC_Part15.209_RE(3m)	Engineer: Jone Zhang
Probe: BBHA9120D_1-18GHz	Polarity: Horizontal
EUT: Communication Module	Power: DC 3.3V
Test Mode: Transmit by 802.11g at Channel 2462MHz	

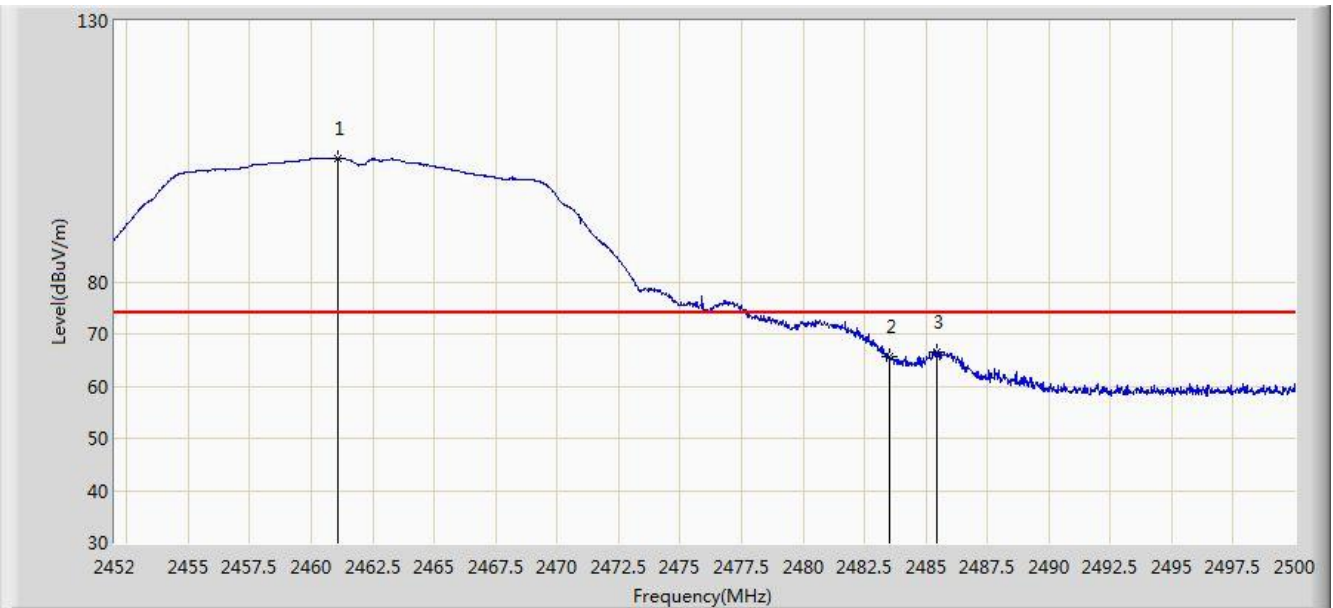

No	Flag	Mark	Frequency (MHz)	Measure Level (dBuV/m)	Reading Level (dBuV)	Over Limit (dB)	Limit (dBuV/m)	Factor (dB)	Type
1		*	2461.072	103.760	71.222	N/A	N/A	32.539	PK
2			2483.500	65.525	32.929	-8.475	74.000	32.596	PK
3			2485.432	66.621	34.020	-7.379	74.000	32.601	PK

Note: Measure Level (dB $\mu$ V/m) = Reading Level (dB $\mu$ V) + Factor (dB)

Factor (dB) = Cable Loss (dB) + Antenna Factor (dB/m)

Site: AC1	Time: 2018/03/08 - 02:24
Limit: FCC_Part15.209_RE(3m)	Engineer: Jone Zhang
Probe: BBHA9120D_1-18GHz	Polarity: Horizontal
EUT: Communication Module	Power: DC 3.3V
Test Mode: Transmit by 802.11g at Channel 2462MHz	

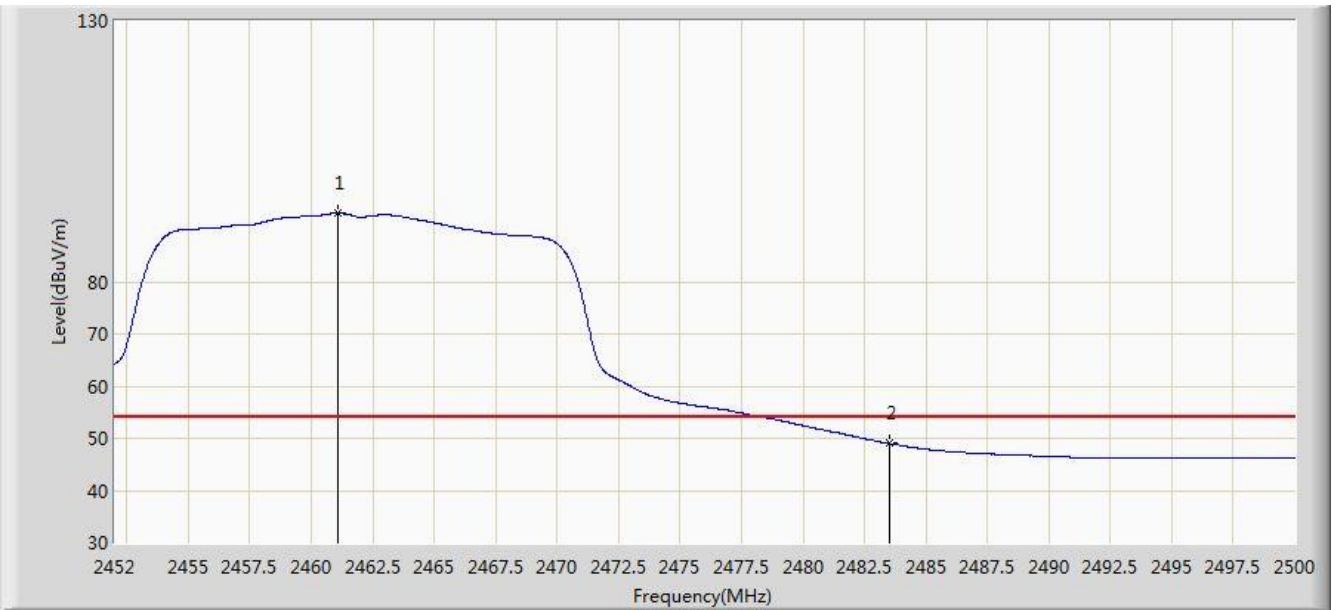

No	Flag	Mark	Frequency (MHz)	Measure Level (dBuV/m)	Reading Level (dBuV)	Over Limit (dB)	Limit (dBuV/m)	Factor (dB)	Type
1		*	2461.096	93.150	60.612	N/A	N/A	32.539	AV
2			2483.500	48.990	16.394	-5.010	54.000	32.596	AV

Note: Measure Level (dBμV/m) = Reading Level (dBμV) + Factor (dB)

Factor (dB) = Cable Loss (dB) + Antenna Factor (dB/m)

Site: AC1	Time: 2018/03/08 - 02:25
Limit: FCC_Part15.209_RE(3m)	Engineer: Jone Zhang
Probe: BBHA9120D_1-18GHz	Polarity: Vertical
EUT: Communication Module	Power: DC 3.3V
Test Mode: Transmit by 802.11g at Channel 2462MHz	

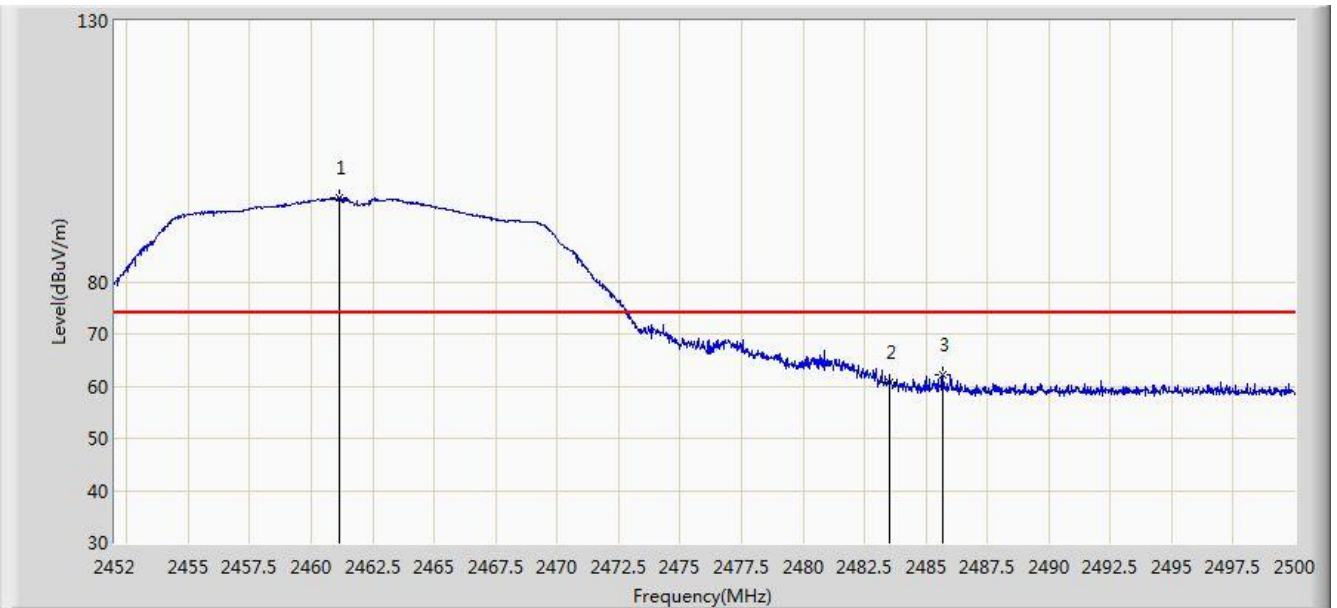

No	Flag	Mark	Frequency (MHz)	Measure Level (dBuV/m)	Reading Level (dBuV)	Over Limit (dB)	Limit (dBuV/m)	Factor (dB)	Type
1		*	2461.144	96.071	63.533	N/A	N/A	32.539	PK
2			2483.500	60.690	28.094	-13.310	74.000	32.596	PK
3			2485.672	62.286	29.685	-11.714	74.000	32.602	PK

Note: Measure Level (dB $\mu$ V/m) = Reading Level (dB $\mu$ V) + Factor (dB)

Factor (dB) = Cable Loss (dB) + Antenna Factor (dB/m)

Site: AC1	Time: 2018/03/08 - 02:26
Limit: FCC_Part15.209_RE(3m)	Engineer: Jone Zhang
Probe: BBHA9120D_1-18GHz	Polarity: Vertical
EUT: Communication Module	Power: DC 3.3V
Test Mode: Transmit by 802.11g at Channel 2462MHz	

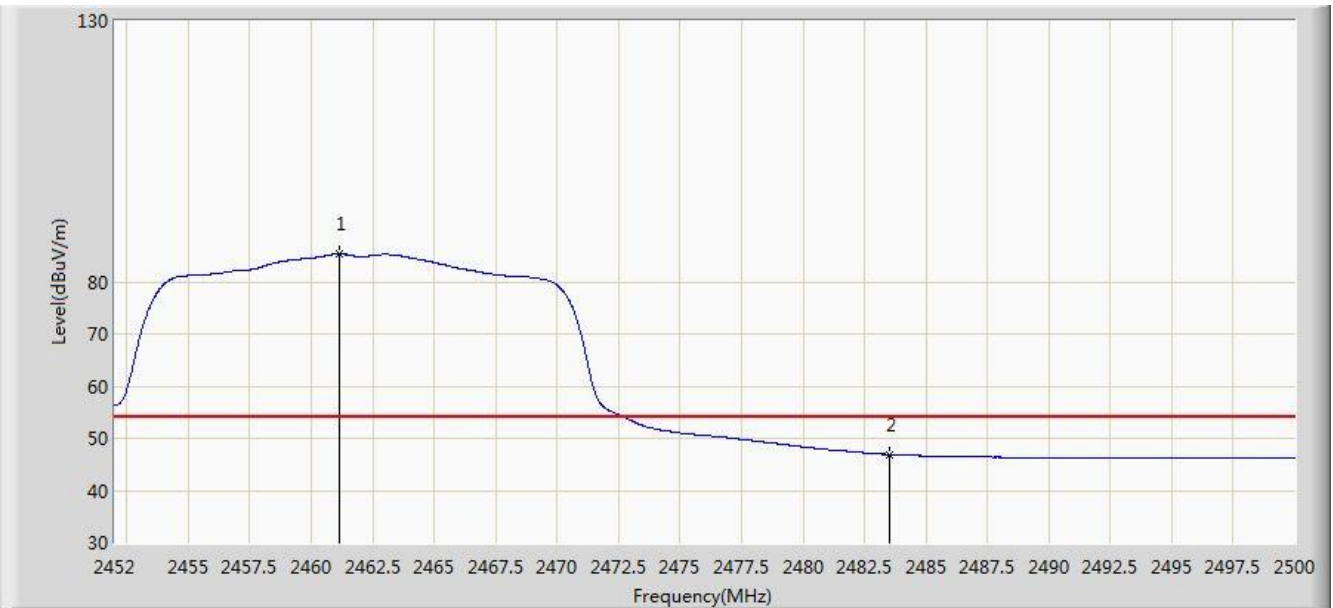

No	Flag	Mark	Frequency (MHz)	Measure Level (dBuV/m)	Reading Level (dBuV)	Over Limit (dB)	Limit (dBuV/m)	Factor (dB)	Type
1		*	2461.144	85.349	52.811	N/A	N/A	32.539	AV
2			2483.500	46.920	14.324	-7.080	54.000	32.596	AV

Note: Measure Level (dB $\mu$ V/m) = Reading Level (dB $\mu$ V) + Factor (dB)

Factor (dB) = Cable Loss (dB) + Antenna Factor (dB/m)

Site: AC1	Time: 2018/03/08 - 02:28
Limit: FCC_Part15.209_RE(3m)	Engineer: Jone Zhang
Probe: BBHA9120D_1-18GHz	Polarity: Horizontal
EUT: Communication Module	Power: DC 3.3V
Test Mode: Transmit by 802.11n-HT20 at Channel 2412MHz	

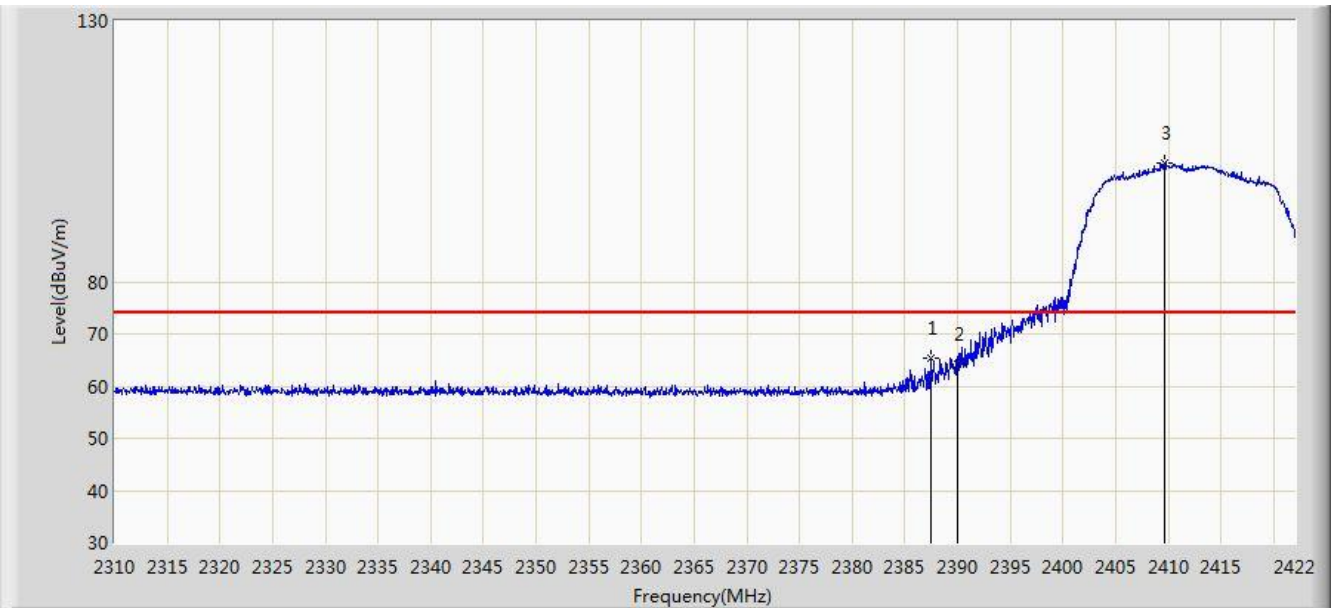

No	Flag	Mark	Frequency (MHz)	Measure Level (dBuV/m)	Reading Level (dBuV)	Over Limit (dB)	Limit (dBuV/m)	Factor (dB)	Type
1			2387.448	65.366	32.787	-8.634	74.000	32.579	PK
2			2390.000	64.246	31.671	-9.754	74.000	32.575	PK
3		*	2409.624	102.857	70.306	N/A	N/A	32.551	PK

Note: Measure Level (dB $\mu$ V/m) = Reading Level (dB $\mu$ V) + Factor (dB)

Factor (dB) = Cable Loss (dB) + Antenna Factor (dB/m)



Site: AC1	Time: 2018/03/08 - 02:30
Limit: FCC_Part15.209_RE(3m)	Engineer: Jone Zhang
Probe: BBHA9120D_1-18GHz	Polarity: Horizontal
EUT: Communication Module	Power: DC 3.3V
Test Mode: Transmit by 802.11n-HT20 at Channel 2412MHz	

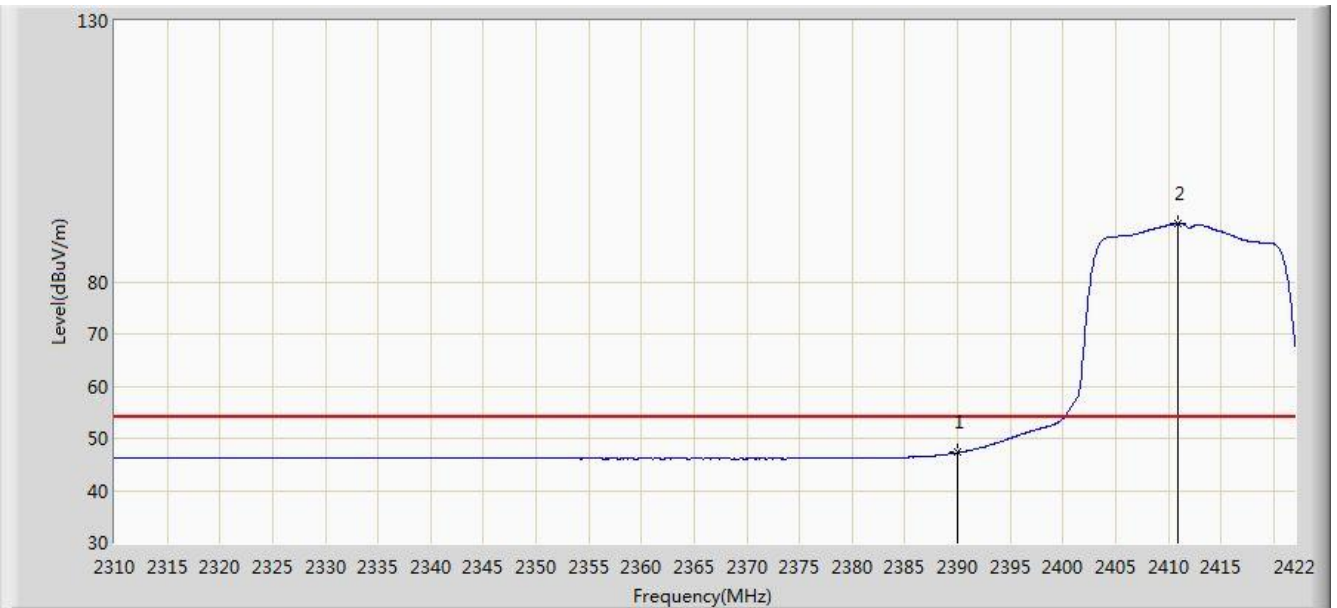

No	Flag	Mark	Frequency (MHz)	Measure Level (dBuV/m)	Reading Level (dBuV)	Over Limit (dB)	Limit (dBuV/m)	Factor (dB)	Type
1			2390.000	47.278	14.703	-6.722	54.000	32.575	AV
2		*	2410.856	91.178	58.629	N/A	N/A	32.550	AV

Note: Measure Level (dB $\mu$ V/m) = Reading Level (dB $\mu$ V) + Factor (dB)

Factor (dB) = Cable Loss (dB) + Antenna Factor (dB/m)

Site: AC1	Time: 2018/03/08 - 02:31
Limit: FCC_Part15.209_RE(3m)	Engineer: Jone Zhang
Probe: BBHA9120D_1-18GHz	Polarity: Vertical
EUT: Communication Module	Power: DC 3.3V
Test Mode: Transmit by 802.11n-HT20 at Channel 2412MHz	

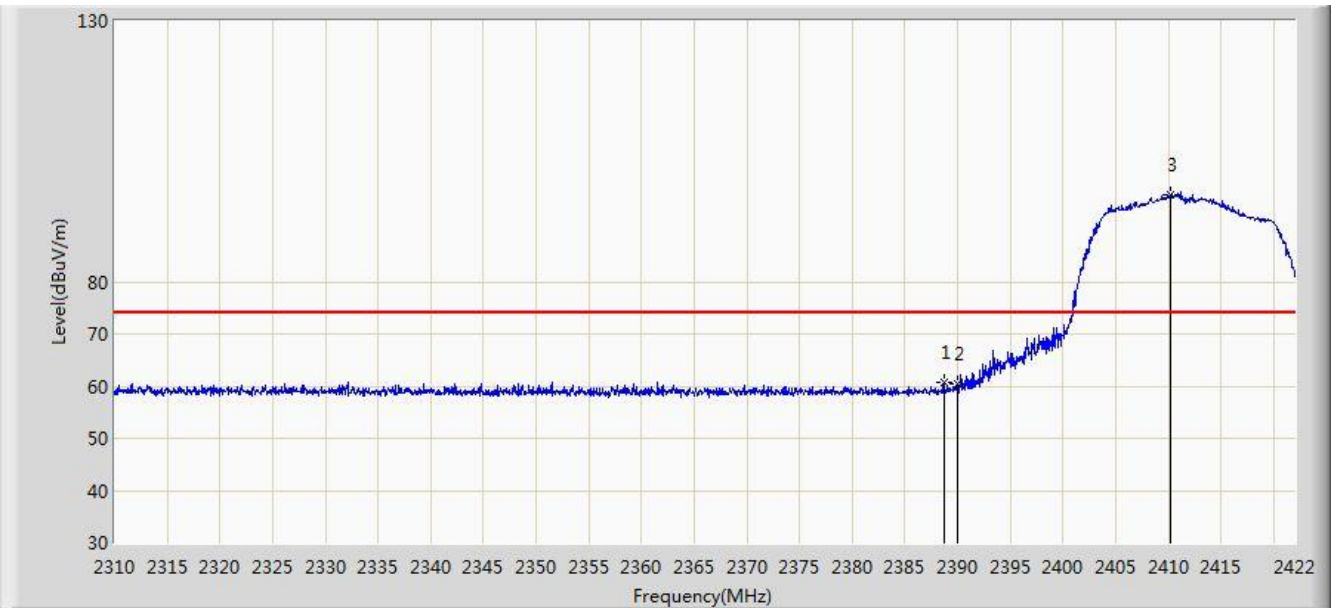

No	Flag	Mark	Frequency (MHz)	Measure Level (dBuV/m)	Reading Level (dBuV)	Over Limit (dB)	Limit (dBuV/m)	Factor (dB)	Type
1			2388.736	60.774	28.197	-13.226	74.000	32.577	PK
2			2390.000	60.405	27.830	-13.595	74.000	32.575	PK
3		*	2410.240	96.716	64.166	N/A	N/A	32.550	PK

Note: Measure Level (dB $\mu$ V/m) = Reading Level (dB $\mu$ V) + Factor (dB)

Factor (dB) = Cable Loss (dB) + Antenna Factor (dB/m)

Site: AC1	Time: 2018/03/08 - 02:32
Limit: FCC_Part15.209_RE(3m)	Engineer: Jone Zhang
Probe: BBHA9120D_1-18GHz	Polarity: Vertical
EUT: Communication Module	Power: DC 3.3V
Test Mode: Transmit by 802.11n-HT20 at Channel 2412MHz	

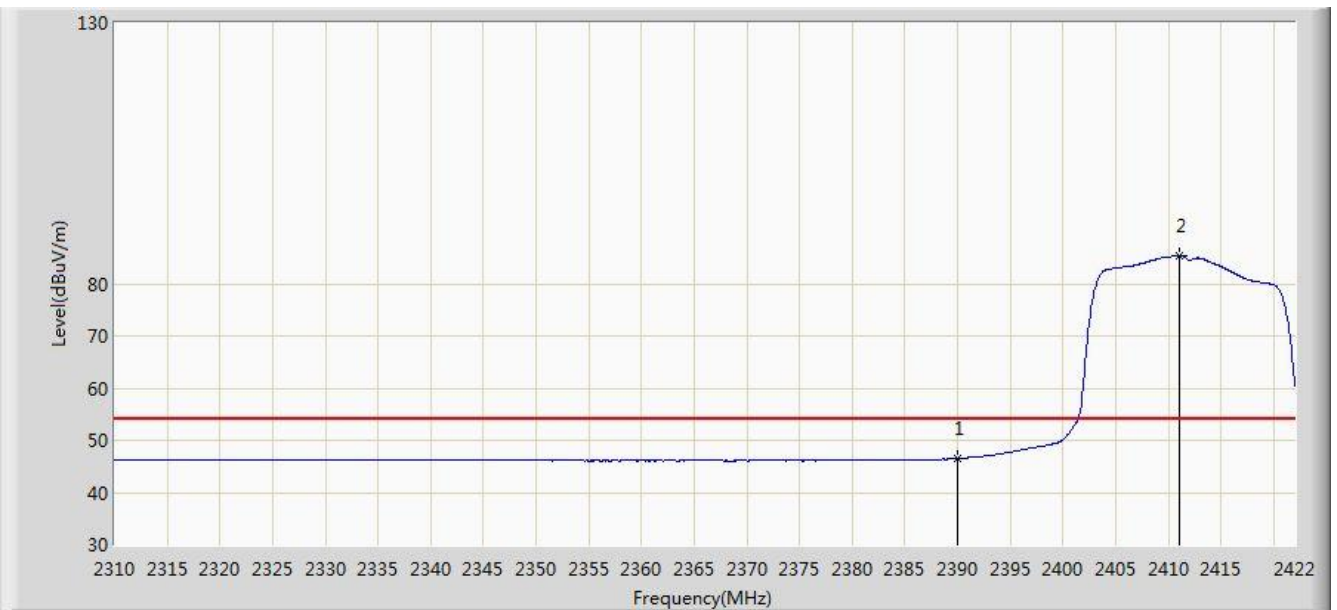

No	Flag	Mark	Frequency (MHz)	Measure Level (dBuV/m)	Reading Level (dBuV)	Over Limit (dB)	Limit (dBuV/m)	Factor (dB)	Type
1			2390.000	46.501	13.926	-7.499	54.000	32.575	AV
2		*	2411.024	85.476	52.927	N/A	N/A	32.549	AV

Note: Measure Level (dB $\mu$ V/m) = Reading Level (dB $\mu$ V) + Factor (dB)

Factor (dB) = Cable Loss (dB) + Antenna Factor (dB/m)

Site: AC1	Time: 2018/03/08 - 02:34
Limit: FCC_Part15.209_RE(3m)	Engineer: Jone Zhang
Probe: BBHA9120D_1-18GHz	Polarity: Horizontal
EUT: Communication Module	Power: DC 3.3V
Test Mode: Transmit by 802.11n-HT20 at Channel 2462MHz	

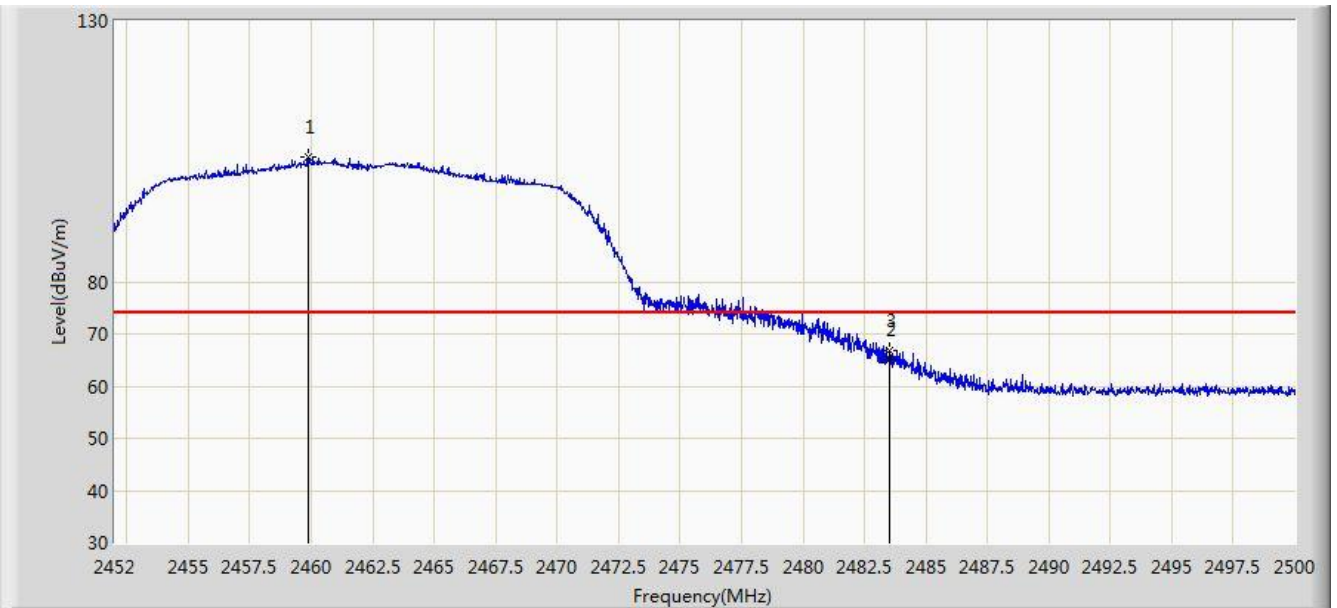

No	Flag	Mark	Frequency (MHz)	Measure Level (dBuV/m)	Reading Level (dBuV)	Over Limit (dB)	Limit (dBuV/m)	Factor (dB)	Type
1		*	2459.872	103.807	71.271	N/A	N/A	32.535	PK
2			2483.500	65.104	32.508	-8.896	74.000	32.596	PK
3			2483.536	66.905	34.309	-7.095	74.000	32.596	PK

Note: Measure Level (dB $\mu$ V/m) = Reading Level (dB $\mu$ V) + Factor (dB)

Factor (dB) = Cable Loss (dB) + Antenna Factor (dB/m)

Site: AC1	Time: 2018/03/08 - 02:36
Limit: FCC_Part15.209_RE(3m)	Engineer: Jone Zhang
Probe: BBHA9120D_1-18GHz	Polarity: Horizontal
EUT: Communication Module	Power: DC 3.3V
Test Mode: Transmit by 802.11n-HT20 at Channel 2462MHz	



No	Flag	Mark	Frequency (MHz)	Measure Level (dBuV/m)	Reading Level (dBuV)	Over Limit (dB)	Limit (dBuV/m)	Factor (dB)	Type
1		*	2461.000	91.811	59.273	N/A	N/A	32.538	AV
2			2483.500	47.270	14.674	-6.730	54.000	32.596	AV

Note: Measure Level (dBμV/m) = Reading Level (dBμV) + Factor (dB)

Factor (dB) = Cable Loss (dB) + Antenna Factor (dB/m)

Site: AC1	Time: 2018/03/08 - 02:37
Limit: FCC_Part15.209_RE(3m)	Engineer: Jone Zhang
Probe: BBHA9120D_1-18GHz	Polarity: Vertical
EUT: Communication Module	Power: DC 3.3V
Test Mode: Transmit by 802.11n-HT20 at Channel 2462MHz	

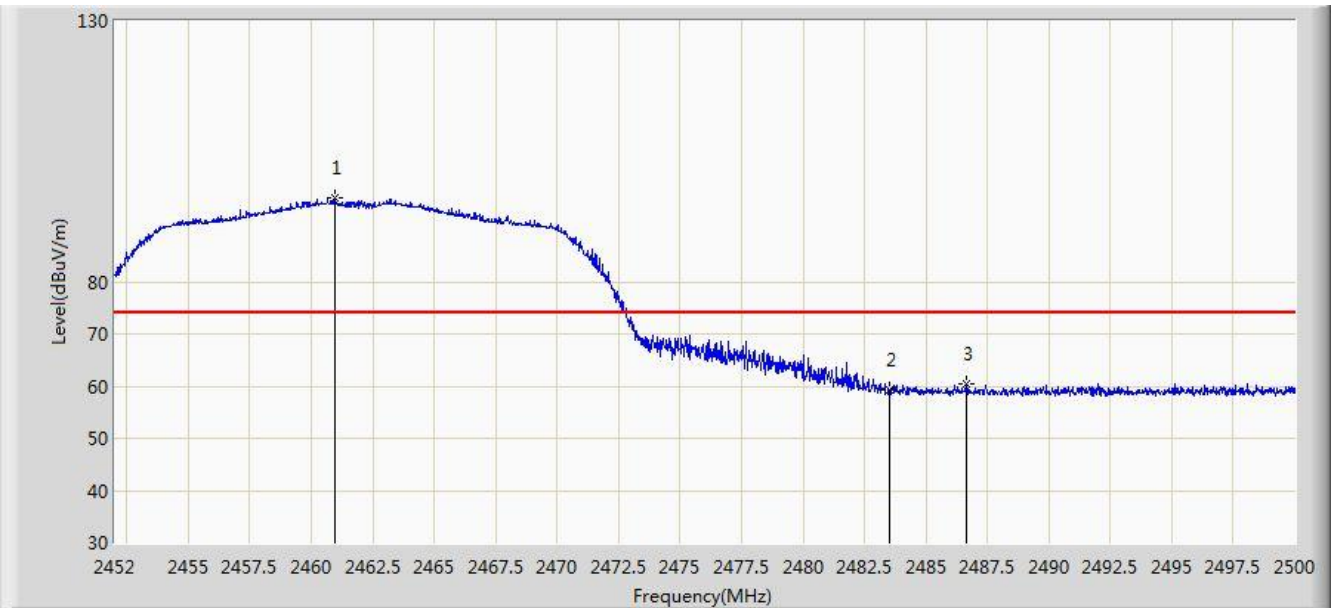

No	Flag	Mark	Frequency (MHz)	Measure Level (dBuV/m)	Reading Level (dBuV)	Over Limit (dB)	Limit (dBuV/m)	Factor (dB)	Type
1		*	2460.952	96.031	63.493	N/A	N/A	32.538	PK
2			2483.500	59.276	26.680	-14.724	74.000	32.596	PK
3			2486.656	60.327	27.723	-13.673	74.000	32.603	PK

Note: Measure Level (dB $\mu$ V/m) = Reading Level (dB $\mu$ V) + Factor (dB)

Factor (dB) = Cable Loss (dB) + Antenna Factor (dB/m)

Site: AC1	Time: 2018/03/08 - 02:38
Limit: FCC_Part15.209_RE(3m)	Engineer: Jone Zhang
Probe: BBHA9120D_1-18GHz	Polarity: Vertical
EUT: Communication Module	Power: DC 3.3V
Test Mode: Transmit by 802.11n-HT20 at Channel 2462MHz	

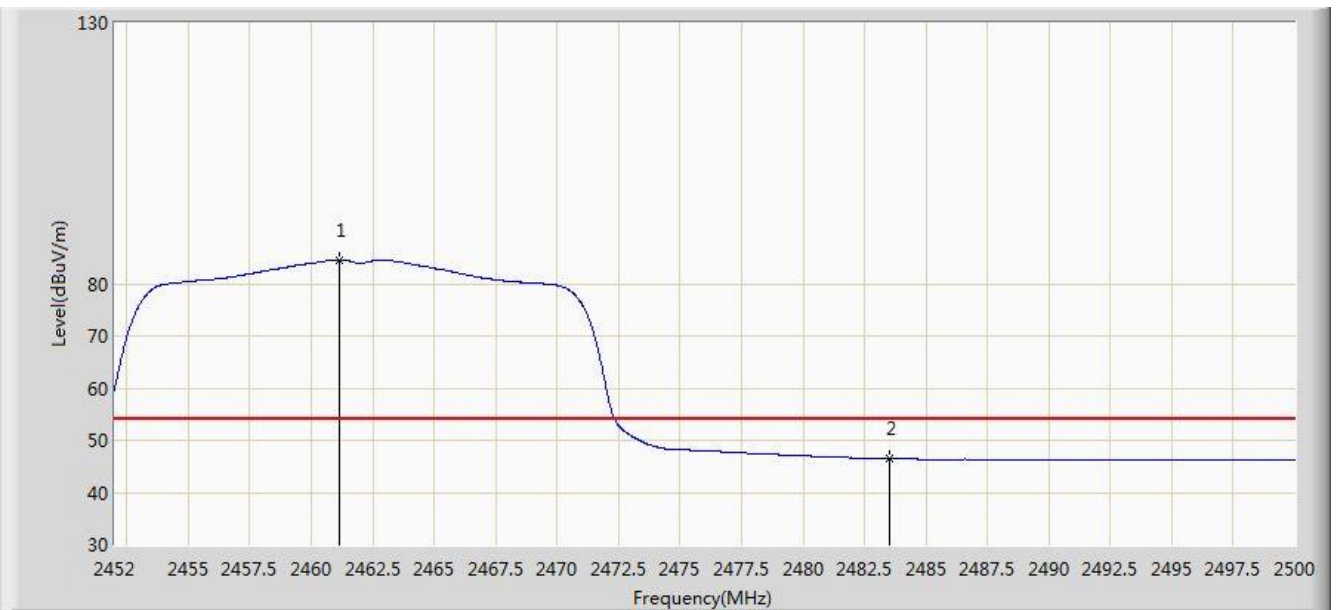

No	Flag	Mark	Frequency (MHz)	Measure Level (dBuV/m)	Reading Level (dBuV)	Over Limit (dB)	Limit (dBuV/m)	Factor (dB)	Type
1		*	2461.120	84.582	52.044	N/A	N/A	32.539	AV
2			2483.500	46.458	13.862	-7.542	54.000	32.596	AV

Note: Measure Level (dB $\mu$ V/m) = Reading Level (dB $\mu$ V) + Factor (dB)

Factor (dB) = Cable Loss (dB) + Antenna Factor (dB/m)

## 7.8. AC Conducted Emissions Measurement

### 7.8.1. Test Limit

FCC Part 15 Subpart C Paragraph 15.207 Limits		
Frequency (MHz)	QP (dBuV)	AV (dBuV)
0.15 - 0.50	66 - 56	56 - 46
0.50 - 5.0	56	46
5.0 - 30	60	50

Note 1: The lower limit shall apply at the transition frequencies.

Note 2: The limit decreases linearly with the logarithm of the frequency in the range 0.15MHz to 0.5MHz.

### 7.8.2. Test Setup

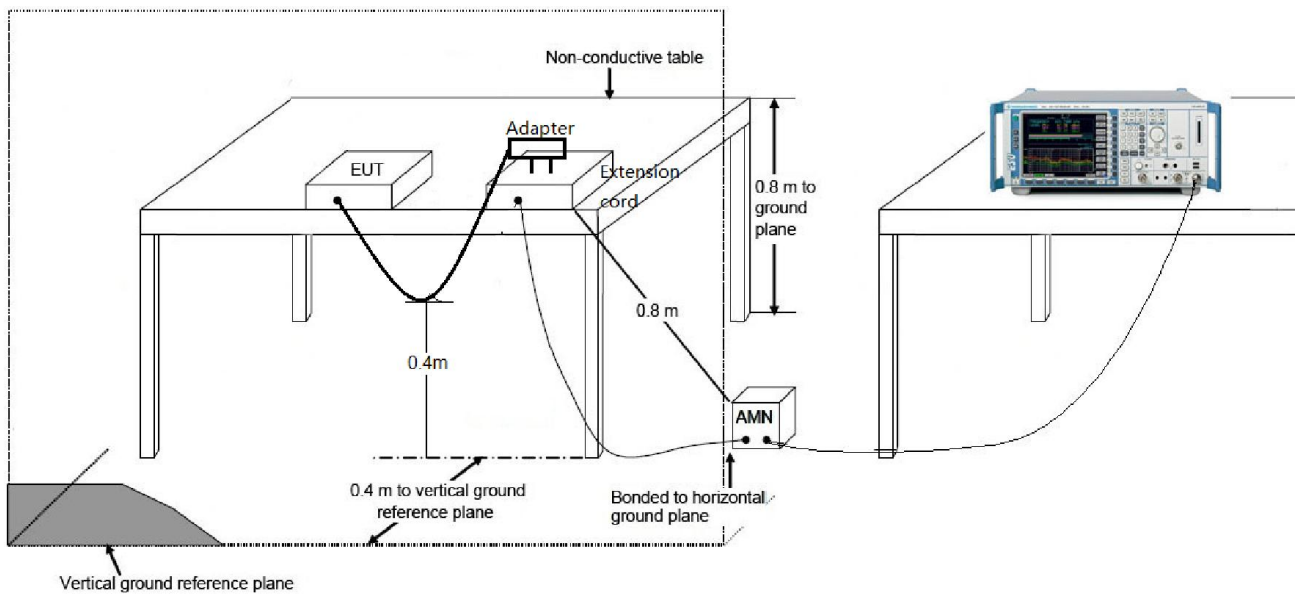

### 7.8.3. Test Result

The EUT is powered by DC Source (3.3V), so this test item is not applicable.



## 8. CONCLUSION

The data collected relate only the item(s) tested and show that the device is in compliance with Part 15C of the FCC Rules & IC Rules.

\_\_\_\_\_ The End \_\_\_\_\_