



# MEASUREMENT REPORT

## FCC PART 15.247 & IC RSS-247 Bluetooth

---

**FCC ID:** VPYLBEE5HY1MW  
**IC:** 772C-LBEE5HY1MW  
**APPLICANT:** Murata Manufacturing Co., Ltd.  
**Application Type:** Certification  
**Product:** Communication Module  
**Model No.:** LBEE5HY1MW  
**HVIN:** LBEE5HY1MW  
**FCC Classification:** FCC Part 15 Spread Spectrum Transmitter(DSS)  
**FCC Rule Part(s):** Part 15.247  
**IC Rule(s):** RSS-247 Issue 2, RSS-GEN Issue 4  
**Test Procedure(s):** ANSI C63.10-2013, KDB 558074 D01v04  
**Test Date:** February 08 ~ March 15, 2018

Reviewed By : Kevin Guo  
( Kevin Guo )

Approved By : Marlin Chen  
( Marlin Chen )



The test results relate only to the samples tested.

This equipment has been shown to be capable of compliance with the applicable technical standards as indicated in the measurement report and was tested in accordance with the measurement procedures specified in ANSI C63.10-2013. Test results reported herein relate only to the item(s) tested.

The test report shall not be reproduced except in full without the written approval of MRT Technology (Suzhou) Co., Ltd.

---

## Revision History

Report No.	Version	Description	Issue Date	Note
1802WSU008-U2	Rev. 01	Initial report	05-15-2018	Valid

## CONTENTS

Description	Page
<b>1. INTRODUCTION .....</b>	<b>7</b>
1.1. Scope .....	7
1.2. MRT Test Location .....	7
<b>2. PRODUCT INFORMATION .....</b>	<b>8</b>
2.1. Equipment Description.....	8
2.2. Product Specification Subjective to this Standard .....	8
2.3. Operation Frequency / Channel List .....	9
2.4. Test Mode .....	10
2.5. Pseudorandom Frequency Hopping Sequence.....	11
2.6. Device Capabilities .....	11
2.7. Test Configuration .....	12
2.8. Test Software .....	12
2.9. EMI Suppression Device(s)/Modifications.....	12
2.10. Labeling Requirements.....	13
<b>3. DESCRIPTION of TEST .....</b>	<b>14</b>
3.1. Evaluation Procedure .....	14
3.2. AC Line Conducted Emissions .....	14
3.3. Radiated Emissions.....	15
<b>4. ANTENNA REQUIREMENTS .....</b>	<b>16</b>
<b>5. TEST EQUIPMENT CALIBRATION DATE .....</b>	<b>17</b>
<b>6. MEASUREMENT UNCERTAINTY.....</b>	<b>18</b>
<b>7. TEST RESULT .....</b>	<b>19</b>
7.1. Summary .....	19
7.2. 20dB Bandwidth Measurement.....	20
7.2.1. Test Limit .....	20
7.2.2. Test Procedure used.....	20
7.2.3. Test Setting.....	20
7.2.4. Test Setup.....	20
7.2.5. Test Result.....	21
7.3. Output Power Measurement.....	25
7.3.1. Test Limit .....	25
7.3.2. Test Procedure Used .....	25
7.3.3. Test Setting.....	25

7.3.4.	Test Setup.....	25
7.3.5.	Test Result.....	26
7.4.	Carrier Frequency Separation Measurement.....	30
7.4.1.	Test Limit .....	30
7.4.2.	Test Procedure Used .....	30
7.4.3.	Test Setting.....	30
7.4.4.	Test Setup.....	30
7.4.5.	Test Result.....	31
7.5.	Number of Hopping Channels Measurement.....	35
7.5.1.	Test Limit .....	35
7.5.2.	Test Procedure Used .....	35
7.5.3.	Test Setting.....	35
7.5.4.	Test Setup.....	35
7.5.5.	Test Result.....	36
7.6.	Time of Occupancy Measurement .....	39
7.6.1.	Test Limit .....	39
7.6.2.	Test Procedure Used .....	39
7.6.3.	Test Setting.....	39
7.6.4.	Test Setup.....	40
7.6.5.	Test Result.....	41
7.7.	Band-edge Compliance Measurement.....	43
7.7.1.	Test Limit .....	43
7.7.2.	Test Procedure Used .....	43
7.7.3.	Test Setting.....	43
7.7.4.	Test Setup.....	44
7.7.5.	Test Result.....	45
7.8.	Conducted Spurious Emissions Measurement.....	48
7.8.1.	Test Limit .....	48
7.8.2.	Test Procedure Used .....	48
7.8.3.	Test Setting.....	48
7.8.4.	Test Setup.....	49
7.8.5.	Test Result.....	50
7.9.	Radiated Spurious Emission Measurement .....	54
7.9.1.	Test Limit .....	54
7.9.2.	Test Procedure Used .....	54
7.9.3.	Test Setting.....	55
7.9.4.	Test Setup.....	56
7.9.5.	Test Result.....	57

---

7.10.	Radiated Restricted Band Edge Measurement .....	68
7.10.1.	Test Procedure Used .....	69
7.10.2.	Test Setting .....	69
7.10.3.	Test Setup.....	70
7.10.4.	Test Result.....	71
7.11.	AC Conducted Emissions Measurement.....	95
7.11.1.	Test Limit .....	95
7.11.2.	Test Setup.....	95
7.11.3.	Test Result.....	95
<b>8.</b>	<b>CONCLUSION.....</b>	<b>96</b>

## §2.1033 General Information

<b>Applicant:</b>	Murata Manufacturing Co., Ltd.
<b>Applicant Address:</b>	10-1, Higashikotari 1-chome, Nagaokakyo-shi, Kyoto 617-8555, Japan
<b>Manufacturer:</b>	Murata Manufacturing Co., Ltd.
<b>Manufacturer Address:</b>	10-1, Higashikotari 1-chome, Nagaokakyo-shi, Kyoto 617-8555, Japan
<b>Test Site:</b>	MRT Technology (Suzhou) Co., Ltd
<b>Test Site Address:</b>	D8 Building, Youxin Industrial Park, No.2 Tian'edang Rd., Wuzhong Economic Development Zone, Suzhou, China
<b>FCC Registration No.:</b>	893164
<b>IC Registration No.:</b>	11384A-1
<b>Test Device Serial No.:</b>	N/A <input type="checkbox"/> Production <input checked="" type="checkbox"/> Pre-Production <input type="checkbox"/> Engineering
<b>FCC Classification:</b>	Spread Spectrum Transmitter(DSS)

### Test Facility / Accreditations

Measurements were performed at MRT Laboratory located in Tian'edang Rd., Suzhou, China.

- MRT facility is a FCC registered (MRT Reg. No. 893164) test facility with the site description report on file and has met all the requirements specified in Section 2.948 of the FCC Rules.
- MRT facility is an IC registered (MRT Reg. No. 11384A-1) test laboratory with the site description on file at Industry Canada.
- MRT facility is a VCCI registered (R-20025, G-20034, C-20020, T-20020) test laboratory with the site description on file at VCCI Council.
- MRT Lab is accredited to ISO 17025 by the American Association for Laboratory Accreditation (A2LA) under the American Association for Laboratory Accreditation Program (A2LA Cert. No. 3628.01) in EMC, Telecommunications and Radio testing for FCC, Industry Canada, EU and TELEC Rules.



# 1. INTRODUCTION

## 1.1. Scope

Measurement and determination of electromagnetic emissions (EMC) of radio frequency devices including intentional and/or unintentional radiators for compliance with the technical rules and regulations of the Federal Communications Commission and the Industry Canada Certification and Engineering Bureau.

## 1.2. MRT Test Location

The map below shows the location of the MRT LABORATORY, its proximity to the Taihu Lake. These measurement tests were conducted at the MRT Technology (Suzhou) Co., Ltd. Facility located at D8 Building, No.2 Tian'edang Rd., Wuzhong Economic Development Zone, Suzhou, China. The detailed description of the measurement facility was found to be in compliance with the requirements of § 2.948 according to ANSI C63.4-2009 on September 30, 2013.



## 2. PRODUCT INFORMATION

### 2.1. Equipment Description

Product Name:	Communication Module
Model No.:	LBEE5HY1MW
HVIN:	LBEE5HY1MW
Wi-Fi Specification:	802.11a/b/g/n/ac
Bluetooth Specification:	V4.2 dual mode
Operating Temperature:	-30 ~ 85 °C
Power Type:	DC 3.3V

### 2.2. Product Specification Subjective to this Standard

Operating Frequency	2402~2480MHz
Channel Number	79
Type of modulation	GFSK, Pi/4 DQPSK, 8DPSK
Data Rate	1Mbps(GFSK), 2Mbps(Pi/4 DQPSK), 3Mbps (8DPSK)
Antenna type	PCB Antenna
Antenna Gain	0.1dBi

The equipment under test (EUT) is the device. The test data contained in this report pertains only to the emissions due to the EUT's Bluetooth transmitter.

- 15.247(g): In accordance with the Bluetooth Industry Standard, the system is designed to comply with all of the regulations in Section 15.247 when the transmitter is presented with a continuous data (or information) system.
- 15.247(h): In accordance with the Bluetooth Industry Standard, the system does not coordinate its channels selection/ hopping sequence with other frequency hopping systems for the express purpose of avoiding the simultaneous occupancy of individual hopping frequencies by multiple transmitters.
- 15.247(h): The EUT employs Adaptive Frequency Hopping (AFH) which identifies sources of interference namely devices operating in 802.11 WLAN and excludes them from the list of available channels. The process of re-mapping reduces the number of test channels from 79 channels to a minimum number of 20 channels.



### 2.3. Operation Frequency / Channel List

Channel	Frequency	Channel	Frequency	Channel	Frequency
00	2402 MHz	01	2403 MHz	02	2404 MHz
03	2405 MHz	04	2406 MHz	05	2407 MHz
06	2408 MHz	07	2409 MHz	08	2410 MHz
09	2411 MHz	10	2412 MHz	11	2413 MHz
12	2414 MHz	13	2415 MHz	14	2416 MHz
15	2417 MHz	16	2418 MHz	17	2419 MHz
18	2420 MHz	19	2421 MHz	20	2422 MHz
21	2423 MHz	22	2424 MHz	23	2425 MHz
24	2426 MHz	25	2427 MHz	26	2428 MHz
27	2429 MHz	28	2430 MHz	29	2431 MHz
30	2432 MHz	31	2433 MHz	32	2434 MHz
33	2435 MHz	34	2436 MHz	35	2437 MHz
36	2438 MHz	37	2439 MHz	38	2440 MHz
39	2441 MHz	40	2442 MHz	41	2443 MHz
42	2444 MHz	43	2445 MHz	44	2446 MHz
45	2447 MHz	46	2448 MHz	47	2449 MHz
48	2450 MHz	49	2451 MHz	50	2452 MHz
51	2453 MHz	52	2454 MHz	53	2455 MHz
54	2456 MHz	55	2457 MHz	56	2458 MHz
57	2459 MHz	58	2460 MHz	59	2461 MHz
60	2462 MHz	61	2463 MHz	62	2464 MHz
63	2465 MHz	64	2466 MHz	65	2467 MHz
66	2468 MHz	67	2469 MHz	68	2470 MHz
69	2471 MHz	70	2472 MHz	71	2473 MHz
72	2474 MHz	73	2475 MHz	74	2476 MHz
75	2477 MHz	76	2478 MHz	77	2479 MHz
78	2480 MHz	-	-	-	-

## 2.4. Test Mode

Test Mode	Mode 1: Transmit by DH5 at Channel 00
	Mode 2: Transmit by DH5 at Channel 39
	Mode 3: Transmit by DH5 at Channel 78
	Mode 4: Transmit by 2DH5 at Channel 00
	Mode 5: Transmit by 2DH5 at Channel 39
	Mode 6: Transmit by 2DH5 at Channel 78
	Mode 7: Transmit by 3DH5 at Channel 00
	Mode 8: Transmit by 3DH5 at Channel 39
	Mode 9: Transmit by 3DH5 at Channel 78
	Mode 10: Transmit by DH5 at Hopping mode
	Mode 11: Transmit by 2DH5 at Hopping mode
	Mode 12: Transmit by 3DH5 at Hopping mode
	Mode 13: Transmit by 3DH1 at Hopping mode
	Mode 14: Transmit by 3DH3 at Hopping mode
	Mode 15: Transmit by 3DH5 at Hopping mode

Note: All test data for each data rate were verified, but only the worst case was reported.

## 2.5. Pseudorandom Frequency Hopping Sequence

The pseudorandom sequence may be generated in a nine-stage shift register whose 5th and 9th stage outputs are added in a modulo-two addition stage. And the result is fed back to the input of the first stage. The sequence begins with the first ONE of 9 consecutive ONES; i.e. the shift register is initialized with nine ones.

- Number of shift register stages: 9
- Length of pseudo-random sequence:  $2^9 - 1 = 511$  bits
- Longest sequence of zeros: 8 (non-inverted signal)

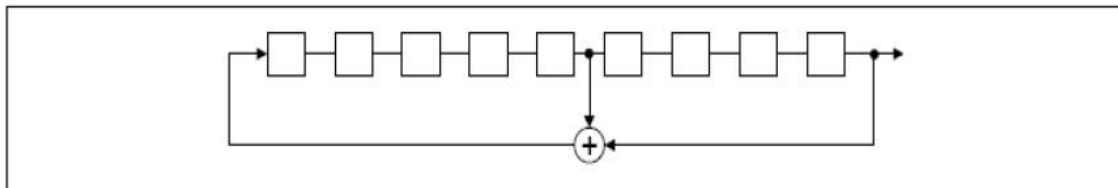

Linear Feedback Shift Register for Generation of the PRBS sequence

An example of Pseudorandom Frequency Hopping Sequence as follow:

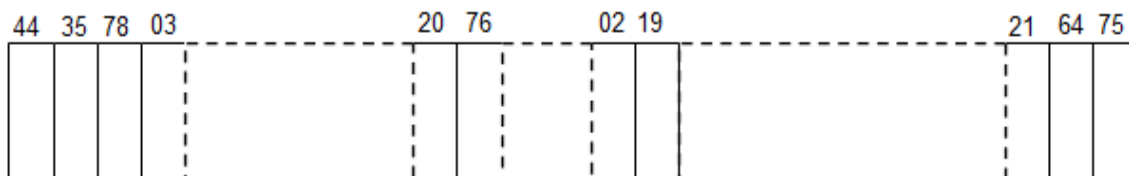

Each frequency used equally on the average by each transmitter.

The system receivers have input bandwidths that match the hopping channel bandwidths of their Corresponding transmitters and shift frequencies in synchronization with the transmitted signals.

## 2.6. Device Capabilities

This device contains the following capabilities:

802.11a/b/g/n/ac W-LAN, Bluetooth V4.2 dual mode (BDR/EDR/LE) device.

**Note:** The maximum achievable duty cycle was determined based on measurements performed on a spectrum analyzer in zero-span mode with RBW = 8MHz, VBW = 50MHz. The RBW and VBW were both greater than  $50/T$ , where T is the minimum transmission duration, and the number of sweep points across T was greater than 100. The duty cycles are as follows:

Test Mode	Duty Cycle
DH5	76.89%
2DH5	76.89%
3DH5	76.89%

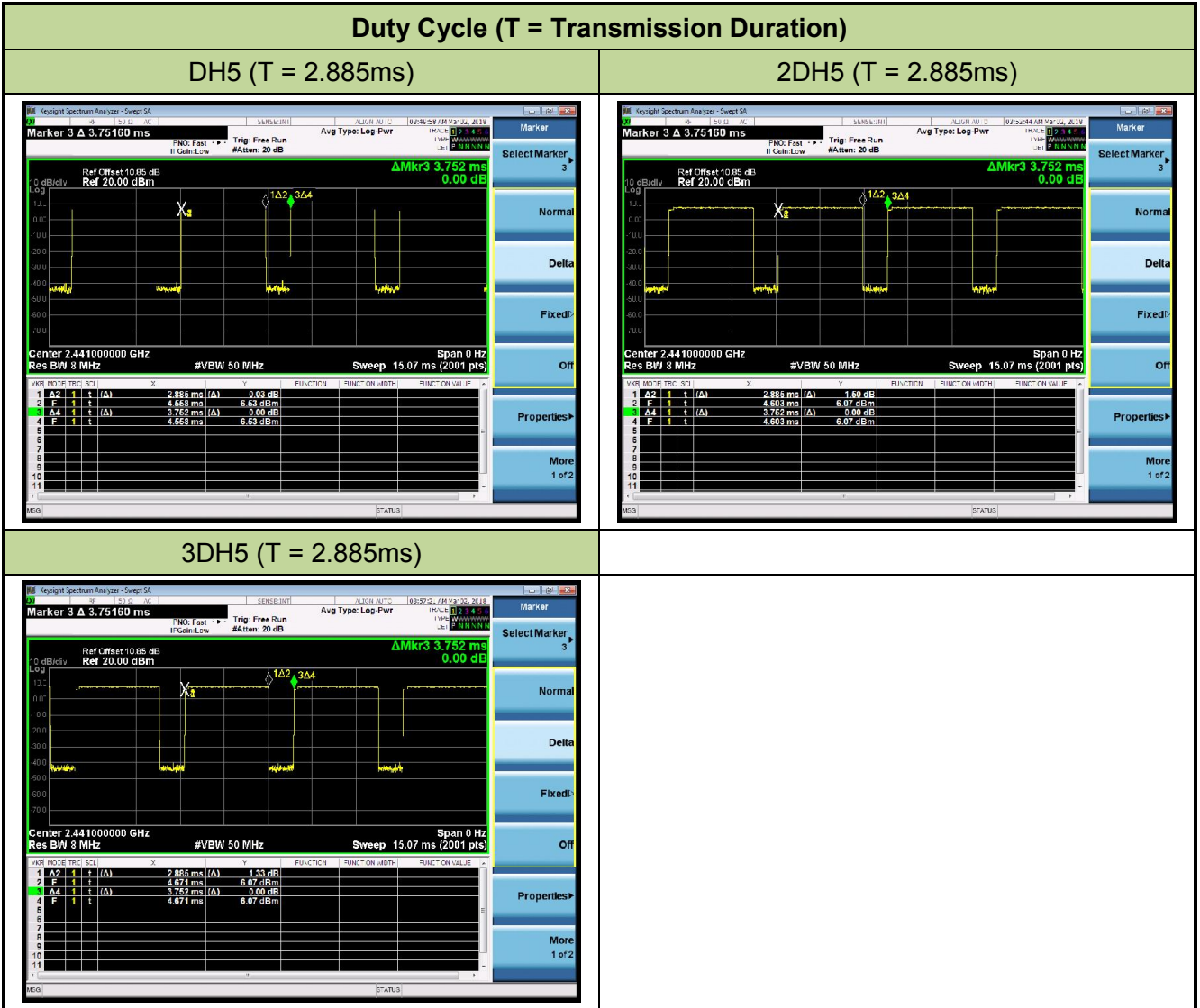

### 2.7. Test Configuration

The **Communication Module** was tested per the guidance of ANSI C63.10-2013. ANSI C63.10-2013 was used to reference the appropriate EUT setup for radiated spurious emissions testing and AC line conducted testing.

### 2.8. Test Software

The test utility software used during testing was “Broadcom BlueTool”, and the version was “v1.8.9.3”.

### 2.9. EMI Suppression Device(s)/Modifications

No EMI suppression device(s) were added and/or no modifications were made during testing.

## **2.10. Labeling Requirements**

Per 2.1074 & 15.19; Docket 95-19

The label shall be permanently affixed at a conspicuous location on the device; instruction manual or pamphlet supplied to the user and be readily visible to the purchaser at the time of purchase.

However, when the device is so small wherein placement of the label with specified statement is not practical, only the FCC ID must be displayed on the device per Section 15.19(a)(5). Please see attachment for FCC ID label and label location.

RSP-100 Issue 11 Section 3

The manufacturer, importer or distributor shall meet the labelling requirements set out in this section for every unit:

- (i) prior to marketing in Canada, for products manufactured in Canada
- (ii) prior to importation into Canada, for imported products

For information regarding the e-labelling option, see Notice 2014–DRS1003. The label for the certified product represents the manufacturer's or importer's compliance with Innovation, Science and Economic Development Canada's (ISED) regulatory requirements.

Please see attachment for IC label and label location.

### 3. DESCRIPTION of TEST

#### 3.1. Evaluation Procedure

The measurement procedures described in the American National Standard for Testing Unlicensed Wireless Devices (ANSI C63.10-2013), and the “Filing were used in the measurement of the device.

**Deviation from measurement procedure.....None**

#### 3.2. AC Line Conducted Emissions

The line-conducted facility is located inside an 8'x4'x4' shielded enclosure. A 1m x 2m wooden table 80cm high is placed 40cm away from the vertical wall and 80cm away from the sidewall of the shielded room. Two 10kHz-30MHz, 50Ω/50uH Line-Impedance Stabilization Networks (LISNs) are bonded to the shielded room floor. Power to the LISNs is filtered by external high-current high-insertion loss power line filters. These filters attenuate ambient signal noise from entering the measurement lines. These filters are also bonded to the shielded enclosure.

The EUT is powered from one LISN and the support equipment is powered from the second LISN. All interconnecting cables more than 1 meter were shortened to a 1 meter length by non-inductive bundling (serpentine fashion) and draped over the back edge of the test table. All cables were at least 40cm above the horizontal reference ground-plane. Power cables for support equipment were routed down to the second LISN while ensuring that that cables were not draped over the second LISN.

Sufficient time for the EUT, support equipment, and test equipment was allowed in order for them to warm up to their normal operating condition. The RF output of the LISN was connected to the receiver and exploratory measurements were made to determine the frequencies producing the maximum emission from the EUT. The receiver was scanned from 150kHz to 30MHz. The detector function was set to peak mode for exploratory measurements while the bandwidth of the analyzer was set to 9kHz. The EUT, support equipment, and interconnecting cables were arranged and manipulated to maximize each emission. Each emission was also maximized by varying: power lines, the mode of operation or data exchange speed, or support equipment whichever determined the worst-case emission. Once the worst case emissions have been identified, the one EUT cable configuration/arrangement and mode of operation that produced these emissions were used for final measurements on the same test site. The analyzer is set to CISPR quasi-peak and average detectors with a 9kHz resolution bandwidth for final measurements.

An extension cord was used to connect to a single LISN which powered by EUT. The extension cord was calibrated with LISN, the impedance and insertion loss are compliance with the requirements as stated in ANSI C63.10-2013.

### 3.3. Radiated Emissions

The radiated test facilities consisted of an indoor 3 meter semi-anechoic chamber used for final measurements and exploratory measurements, when necessary. The measurement area is contained within the semi-anechoic chamber which is shielded from any ambient interference. For measurements above 1GHz absorbers are arranged on the floor between the turn table and the antenna mast in such a way so as to maximize the reduction of reflections. For measurements below 1GHz, the absorbers are removed. An MF Model 210SS turntable is used for radiated measurement. It is a continuously rotatable, remote controlled, metallic turntable and 2 meters (6.56 ft.) in diameter. The turn table is flush with the raised floor of the chamber in order to maintain its function as a ground plane. An 80cm high PVC support structure is placed on top of the turntable.

For all measurements, the spectrum was scanned through all EUT azimuths and from 1 to 4 meter receive antenna height using a broadband antenna from 30MHz up to the upper frequency shown in 15.33(b)(1) depending on the highest frequency generated or used in the device or on which the device operates or tunes. For frequencies above 1GHz, linearly polarized double ridge horn antennas were used. For frequencies below 30MHz, a calibrated loop antenna was used. When exploratory measurements were necessary, they were performed at 1 meter test distance inside the semi-anechoic chamber using broadband antennas, broadband amplifiers, and spectrum analyzers to determine the frequencies and modes producing the maximum emissions. Sufficient time for the EUT, support equipment, and test equipment was allowed in order for them to warm up to their normal operating condition. The test set-up for frequencies below 1GHz was placed on top of the 0.8 meter high, 1 x 1.5 meter table; and test set-up for frequencies 1-40GHz was placed on top of the 1.5 meter high, 1 x 1.5 meter table. The EUT, support equipment, and interconnecting cables were arranged and manipulated to maximize each emission. Appropriate precaution was taken to ensure that all emissions from the EUT were maximized and investigated. The system configuration, clock speed, mode of operation or video resolution, if applicable, turntable azimuth, and receive antenna height was noted for each frequency found.

Final measurements were made in the semi-anechoic chamber using calibrated, linearly polarized broadband and horn antennas. The test setup was configured to the setup that produced the worst case emissions. The spectrum analyzer was set to investigate all frequencies required for testing to compare the highest radiated disturbances with respect to the specified limits. The turntable containing the EUT was rotated through 360 degrees and the height of the receive antenna was varied 1 to 4 meters and stopped at the azimuth and height producing the maximum emission. Each emission was maximized by changing the orientation of the EUT through three orthogonal planes and changing the polarity of the receive antenna, whichever produced the worst-case emissions. According to 3dB Beamwidth of horn antenna, the horn antenna should be always directed to the EUT when rising height.

#### **4. ANTENNA REQUIREMENTS**

**Excerpt from §15.203 of the FCC Rules/Regulations:**

“An intentional radiator antenna shall be designed to ensure that no antenna other than that furnished by the responsible party can be used with the device. The use of a permanently attached antenna or of an antenna that uses a unique coupling to the intentional radiator shall be considered sufficient to comply with the provisions of this section.”

**Conclusion:**

The device unit complies with the requirement of §15.203.



## 5. TEST EQUIPMENT CALIBRATION DATE

### Conducted Emissions - SR2

Instrument	Manufacturer	Type No.	Asset No.	Cali. Interval	Cali. Due Date
EMI Test Receiver	R&S	ESR3	MRTSUE06185	1 year	2018/04/24
Two-Line V-Network	R&S	ENV 216	MRTSUE06002	1 year	2018/06/21
Two-Line V-Network	R&S	ENV 216	MRTSUE06003	1 year	2018/06/21
Thermohygrometer	Testo	608-H1	MRTSUE06404	1 year	2018/08/14
Shielding Anechoic Chamber	Mikebang	Chamber-SR2	MRTSUE06214	1 year	2018/05/10

### Radiated Disturbance - AC1

Instrument	Manufacturer	Type No.	Asset No.	Cali. Interval	Cali. Due Date
PXA Signal Analyzer	Keysight	9030B	MRTSUE06395	1 year	2018/09/13
Loop Antenna	Schwarzbeck	FMZB1519	MRTSUE06025	1 year	2018/11/20
Bilog Period Antenna	Schwarzbeck	VULB 9168	MRTSUE06172	1 year	2018/11/18
Horn Antenna	Schwarzbeck	BBHA9120D	MRTSUE06023	1 year	2018/10/21
Microwave System Amplifier	Agilent	83017A	MRTSUE06076	1 year	2018/11/17
Broadband Horn Antenna	Schwarzbeck	BBHA9170	MRTSUE06024	1 year	2018/04/25
Thermohygrometer	Testo	608-H1	MRTSUE06403	1 year	2018/08/14
Anechoic Chamber	TDK	Chamber-AC1	MRTSUE06212	1 year	2018/05/10

### Conducted Test Equipment - TR3

Instrument	Manufacturer	Type No.	Asset No.	Cali. Interval	Cali. Due Date
Spectrum Analyzer	Agilent	N9020A	MRTSUE06106	1 year	2018/04/25
Power Meter	Agilent	U2021XA	MRTSUE06030	1 year	2018/12/06
Thermohygrometer	Testo	608-H1	MRTSUE06401	1 year	2018/08/14

Software	Version	Function
e3	V 8.3.5	EMI Test Software

## 6. MEASUREMENT UNCERTAINTY

Where relevant, the following test uncertainty levels have been estimated for tests performed on the EUT as specified in CISPR 16-4-2. This uncertainty represents an expanded uncertainty expressed at approximately the 95% confidence level using a coverage factor of  $k = 2$ .

<b>AC Conducted Emission Measurement - SR2</b>
Measuring Uncertainty for a Level of Confidence of 95% ( $U=2Uc(y)$ ): 150kHz~30MHz: 3.46dB
<b>Radiated Emission Measurement - AC1</b>
Measuring Uncertainty for a Level of Confidence of 95% ( $U=2Uc(y)$ ): 9kHz ~ 1GHz: 4.18dB 1GHz ~ 25GHz: 4.76dB
<b>Spurious Emissions, Conducted - TR3</b>
Measuring Uncertainty for a Level of Confidence of 95% ( $U=2Uc(y)$ ): 0.78dB
<b>Output Power - TR3</b>
Measuring Uncertainty for a Level of Confidence of 95% ( $U=2Uc(y)$ ): 1.13dB
<b>Power Spectrum Density - TR3</b>
Measuring Uncertainty for a Level of Confidence of 95% ( $U=2Uc(y)$ ): 1.15dB
<b>Occupied Bandwidth - TR3</b>
Measuring Uncertainty for a Level of Confidence of 95% ( $U=2Uc(y)$ ): 0.28%

## 7. TEST RESULT

### 7.1. Summary

**Company Name:** Murata Manufacturing Co., Ltd.  
**FCC ID:** VPYLBEE5HY1MW  
**IC:** 772C-LBEE5HY1MW

FCC Part Section(s)	IC Section(s)	Test Description	Test Limit	Test Condition	Test Result	Reference
15.247(a)(1)	RSS-247 [5.1]	20dB Bandwidth	N/A	Conducted	PASS	Section 7.2
15.247(b)(1)	RSS-247 [5.4(b)]	Peak Transmitter Output Power	<1 Watt if > 75 non-overlapping channels used		PASS	Section 7.3
15.247(a)(1)	RSS-247 [5.1]	Channel Separation	> 2/3 of 20 dB BW for systems with Output Power < 125mW		PASS	Section 7.4
15.247(a)(1)(ii i)	RSS-247 [5.1]	Number of Channels	> 15 Channels		PASS	Section 7.5
15.247(a)(1)(ii i)	RSS-247 [5.1]	Time of Occupancy	< 0.4 sec in 31.6 sec period		PASS	Section 7.6
15.247(d)	RSS-247 [5.5]	Band Edge / out-of-Band Emissions	Conducted $\geq$ 20dBc		PASS	Section 7.7 Section 7.8
15.205, 15.209	RSS-247 [5.5]	General Field Strength Limits (Restricted Bands and Radiated Emission Limits)	Emissions in restricted bands must meet the radiated limits detailed in 15.209	Radiated	PASS	Section 7.9 Section 7.10
15.207	RSS-Gen [8.8]	AC Conducted Emissions 150kHz - 30MHz	< FCC 15.207 limits	Line Conducted	N/A	Section 7.11

#### Notes:

- 1) The analyzer plots shown in this section were all taken with a correction table loaded into the analyzer. The correction table was used to account for the losses of the cables and attenuators used as part of the system to connect the EUT to the analyzer at all frequencies of interest.
- 2) All modes of operation and data rates were investigated. For radiated emission test, every axis (X, Y, Z) was also verified. The test results shown in the following sections represent the worst case emissions.

## 7.2. 20dB Bandwidth Measurement

### 7.2.1. Test Limit

N/A

### 7.2.2. Test Procedure used

ANSI C63.10-2013 - Section 6.9.2

### 7.2.3. Test Setting

1. Set RBW  $\geq$  1% to 5% of the 20dB bandwidth
2. VBW = approximately three times RBW
3. Span = approximately 2 to 5 times the 20dB bandwidth, centered on a hopping channel
4. Detector = Peak
5. Trace mode = max hold
6. Sweep = auto couple
7. Allow the trace to stabilize
8. Measure the maximum width of the emission that is constrained by the frequencies associated with the two outermost amplitude points (upper and lower frequencies) that are attenuated by 20 dB relative to the maximum level measured in the fundamental emission.

### 7.2.4. Test Setup

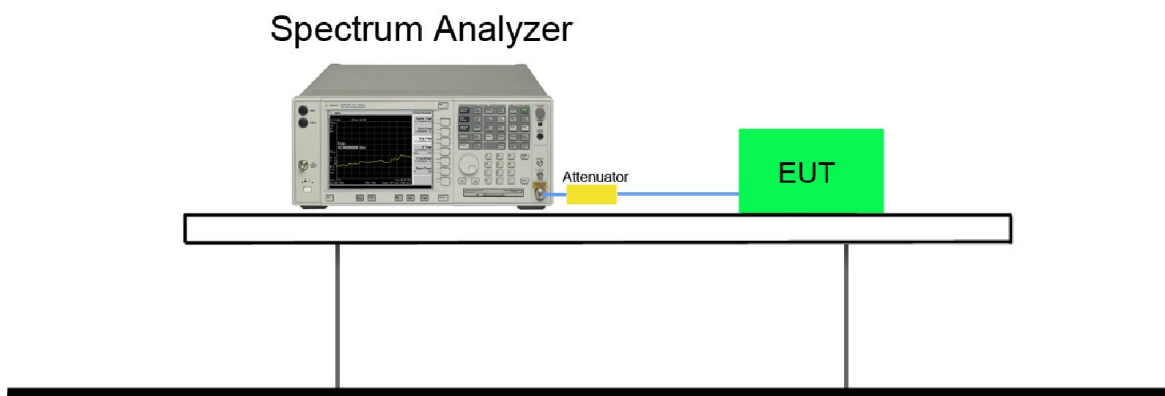

**7.2.5. Test Result**

Product	Communication Module	Temperature	23°C
Test Engineer	Hunk Li	Relative Humidity	54%
Test Site	TR3	Test Date	2018/03/01
Test Item	20dB Bandwidth		

Test Mode	Channel No.	Frequency (MHz)	20dB Bandwidth (kHz)	99% Bandwidth (kHz)	Result
DH5	00	2402	1025.0	934.3	Pass
DH5	39	2441	1007.0	932.6	Pass
DH5	78	2480	1021.0	933.3	Pass
2DH5	00	2402	1328.0	1290.8	Pass
2DH5	39	2441	1329.0	1257.2	Pass
2DH5	78	2480	1318.0	1232.4	Pass
3DH5	00	2402	1286.0	1273.8	Pass
3DH5	39	2441	1264.0	1243.4	Pass
3DH5	78	2480	1297.0	1227.4	Pass

**DH5 20dB Bandwidth**

**Channel 00 (2402MHz)**

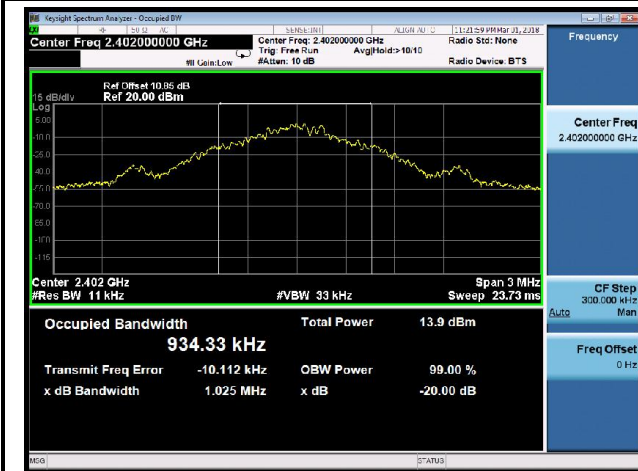

**Channel 39 (2441MHz)**



**Channel 78 (2480MHz)**



**2DH5 20dB Bandwidth**

**Channel 00 (2402MHz)**

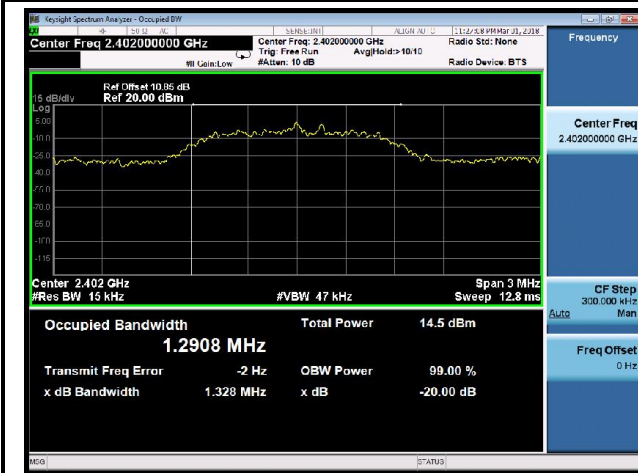

**Channel 39 (2441MHz)**

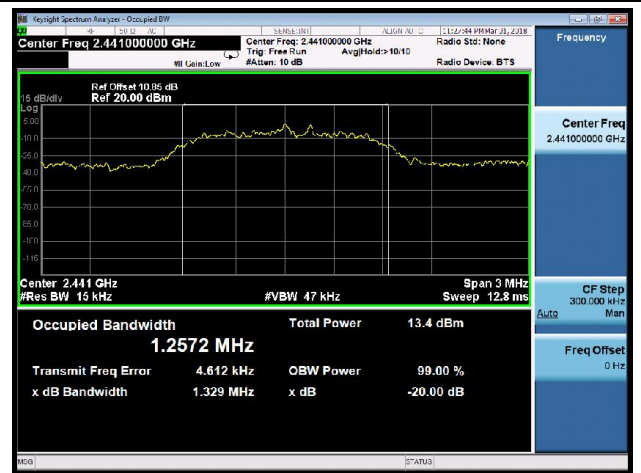

**Channel 78 (2480MHz)**



### 3DH5 20dB Bandwidth

#### Channel 00 (2402MHz)

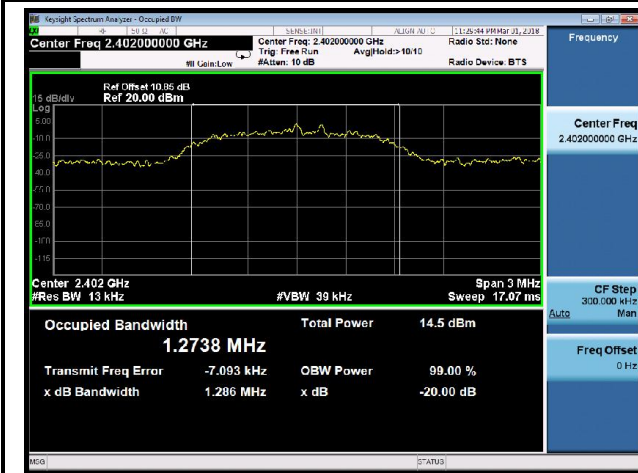

#### Channel 39 (2441MHz)

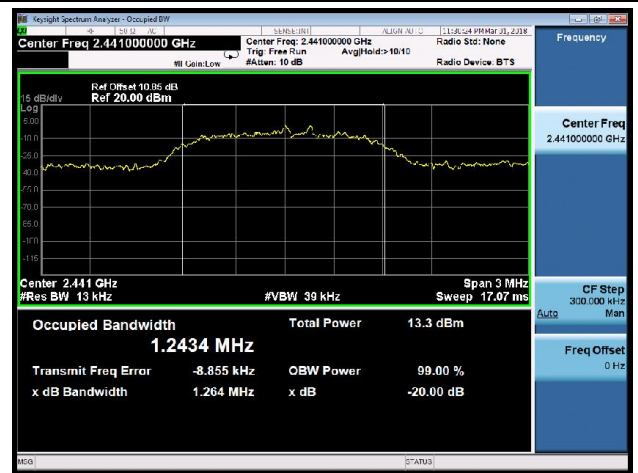

#### Channel 78 (2480MHz)





### 7.3. Output Power Measurement

#### 7.3.1. Test Limit

The maximum out power permissible output power is 1 Watt for all other frequency hopping systems operating in the 2400-2483.5 MHz band employing at least 75 non-overlapping hopping channels, and the E.I.R.P shall not exceed 4 W.

#### 7.3.2. Test Procedure Used

ANSI C63.10-2013 - Section 7.8.5

#### 7.3.3. Test Setting

1. Set RBW  $\geq$  the 20 dB bandwidth of the emission being measured.
2. VBW  $\geq$  RBW
3. Span = approximately five times the 20dB bandwidth, centered on a hopping channel
4. Detector = Peak
5. Trace mode = max hold
6. Sweep = auto couple
7. Allow the trace to stabilize, Use the marker-to-peak function to set the marker to the peak of the emission. The indicated level is the peak output power (don't forget added the external attenuation and cable loss)

#### 7.3.4. Test Setup

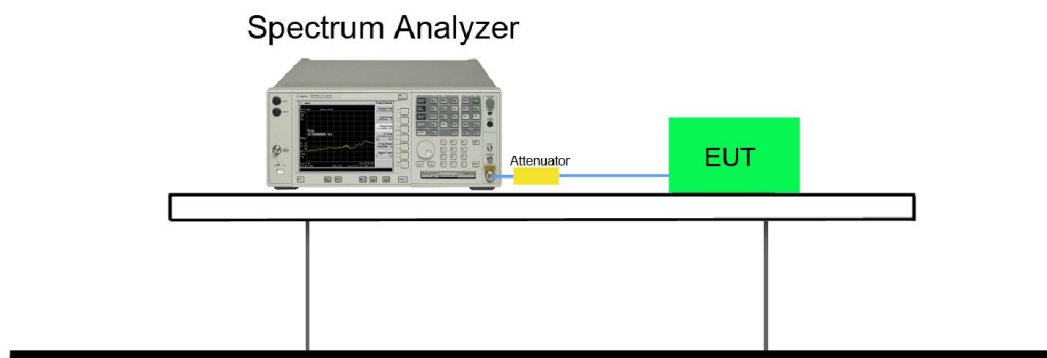

### 7.3.5. Test Result

Product	Communication Module	Temperature	23°C
Test Engineer	Hunk Li	Relative Humidity	54%
Test Site	TR3	Test Date	2018/03/01
Test Item	Output Power		

Test Mode	Channel No.	Frequency (MHz)	Peak Power (dBm)	Power Limit (dBm)	Max EIRP (dBm)	EIRP Limit (dBm)
DH5	00	2402	7.27	< 30.00	7.37	< 36.00
DH5	39	2441	6.62	< 30.00	6.72	< 36.00
DH5	78	2480	5.44	< 30.00	5.54	< 36.00
2DH5	00	2402	8.28	< 30.00	8.38	< 36.00
2DH5	39	2441	7.61	< 30.00	7.71	< 36.00
2DH5	78	2480	6.42	< 30.00	6.52	< 36.00
3DH5	00	2402	8.43	< 30.00	8.53	< 36.00
3DH5	39	2441	7.87	< 30.00	7.97	< 36.00
3DH5	78	2480	6.72	< 30.00	6.82	< 36.00

Note: Max EIRP (dBm) = Peak Power (dBm) + Antenna Gain (dBi), Antenna Gain = 0.1dBi.

### DH5 Output Power

**Channel 00 (2402MHz)**

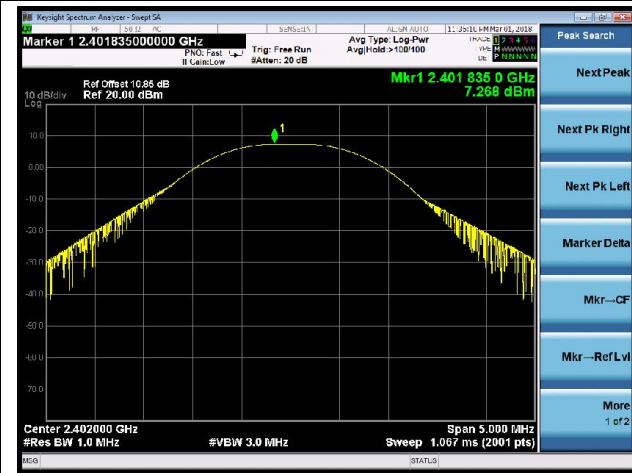

**Channel 39 (2441MHz)**



**Channel 78 (2480MHz)**

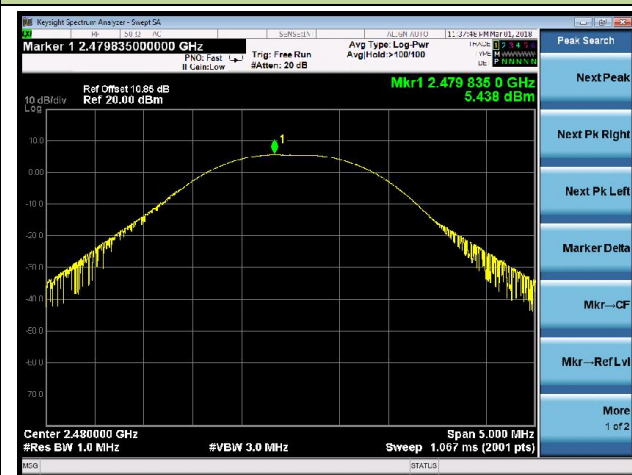

### 2DH5 Output Power

#### Channel 00 (2402MHz)



#### Channel 39 (2441MHz)



#### Channel 78 (2480MHz)



### 3DH5 Output Power

#### Channel 00 (2402MHz)

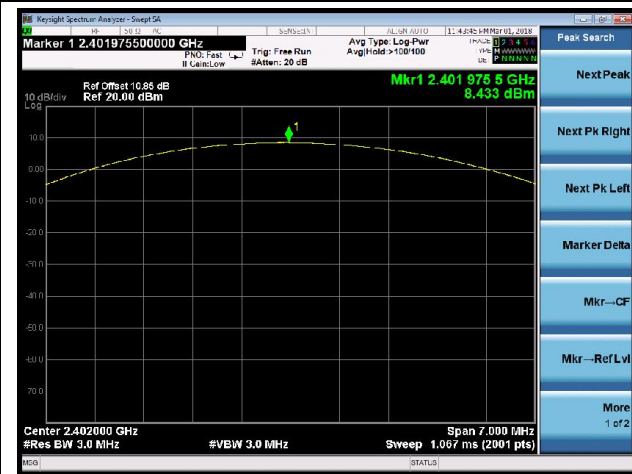

#### Channel 39 (2441MHz)



#### Channel 78 (2480MHz)



## 7.4. Carrier Frequency Separation Measurement

### 7.4.1. Test Limit

The minimum permissible channel separation for this system is  $2/3$  the value of the 20dB BW.

### 7.4.2. Test Procedure Used

ANSI C63.10-2013 - Section 7.8.2

### 7.4.3. Test Setting

1. Span = wide enough to capture the peaks of two adjacent channels.
2. Start with the RBW set to approximately 30% of the channel spacing; adjust as necessary to best identify the center of each individual channel.
3. VBW  $\geq$  RBW
4. Sweep time = Auto couple
5. Detector = Peak
6. Trace mode = Max hold
7. Allowed the trace to stabilize
8. Use the marker-delta function to determine the separation between the peaks of the adjacent channels.

### 7.4.4. Test Setup

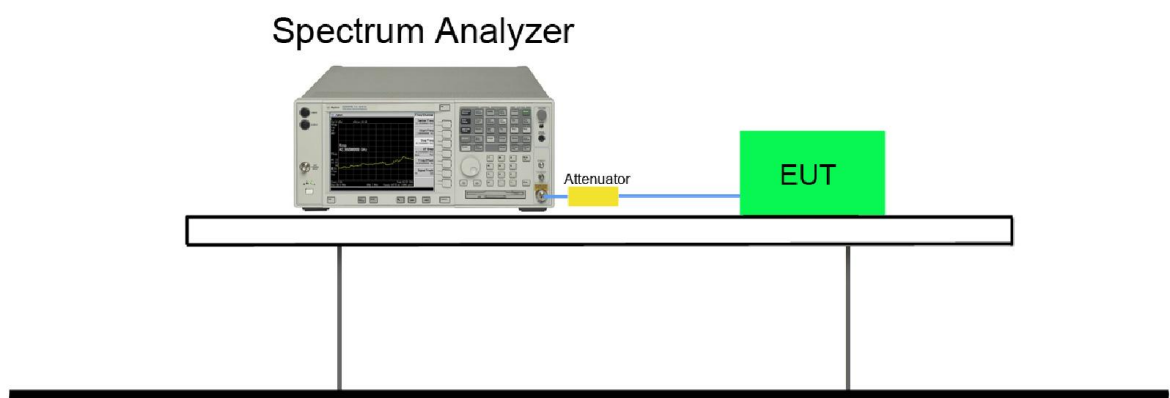

**7.4.5. Test Result**

Product	Communication Module	Temperature	23°C
Test Engineer	Hunk Li	Relative Humidity	54%
Test Site	TR3	Test Date	2018/03/02
Test Item	Carrier Frequency Separation		

Test Mode	Channel No.	Frequency (MHz)	Limit (kHz)	Result
DH5	00	2402	≥ 683.33	Pass
DH5	39	2441	≥ 671.33	Pass
DH5	78	2480	≥ 680.67	Pass
2DH5	00	2402	≥ 885.33	Pass
2DH5	39	2441	≥ 886.00	Pass
2DH5	78	2480	≥ 878.67	Pass
3DH5	00	2402	≥ 857.33	Pass
3DH5	39	2441	≥ 842.67	Pass
3DH5	78	2480	≥ 864.67	Pass

Note: The Limit is 2/3 the value of the 20dB BW.

### DH5 Carrier Frequency Separation

**Channel 00 (2402MHz)**

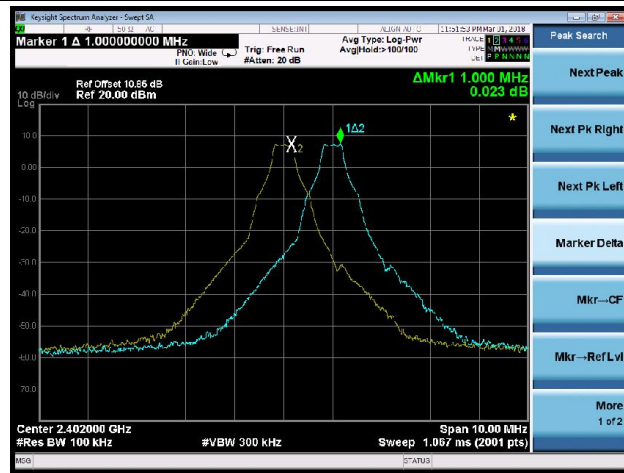

**Channel 39 (2441MHz)**

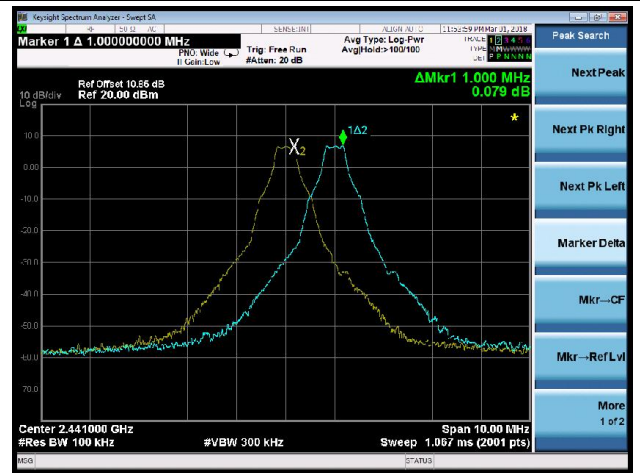

**Channel 78 (2480MHz)**

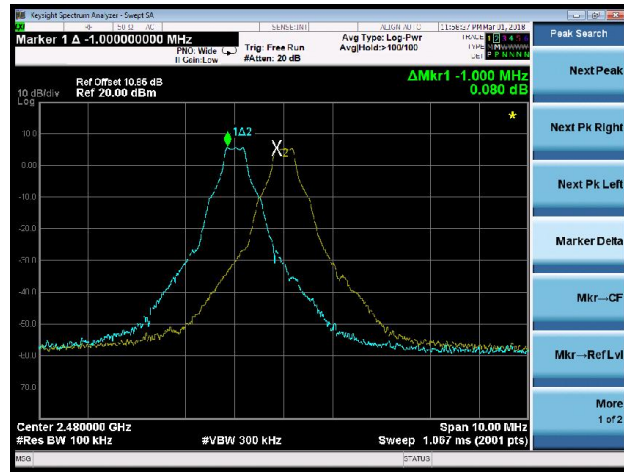



### 2DH5 Carrier Frequency Separation

#### Channel 00 (2402MHz)

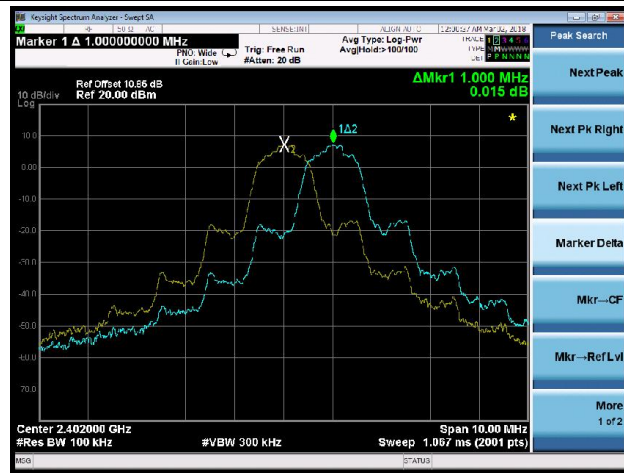

#### Channel 39 (2441MHz)



#### Channel 78 (2480MHz)

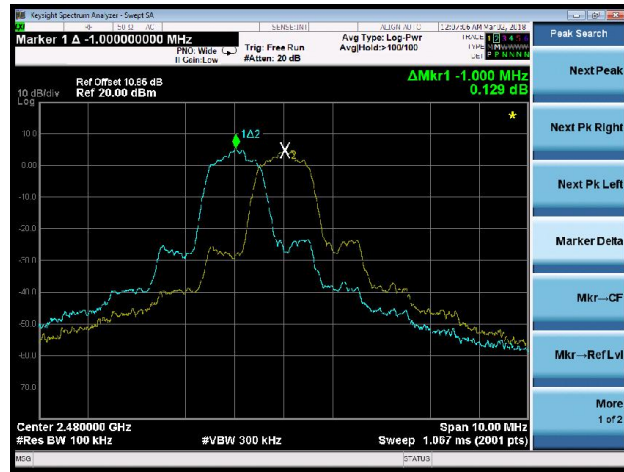

### 3DH5 Carrier Frequency Separation

#### Channel 00 (2402MHz)



#### Channel 39 (2441MHz)



#### Channel 78 (2480MHz)



## 7.5. Number of Hopping Channels Measurement

### 7.5.1. Test Limit

This frequency hopping system must employ a minimum of 15 hopping channels.

### 7.5.2. Test Procedure Used

ANSI C63.10-2013 - Section 7.8.3

### 7.5.3. Test Setting

1. Span = the frequency band of operation.
2. To identify clearly the individual channels, set the RBW to less than 30% of the channel spacing or the 20 dB bandwidth, whichever is smaller.
3. VBW  $\geq$  RBW
4. Sweep time = Auto couple
5. Detector = Peak
6. Trace mode = Max hold
7. Allow the trace to stabilize

### 7.5.4. Test Setup

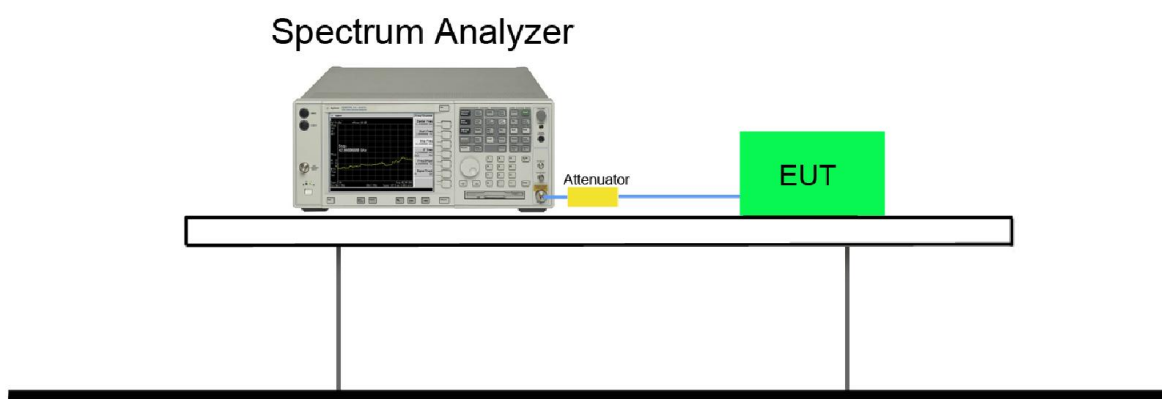

**7.5.5. Test Result**

Product	Communication Module	Temperature	23°C
Test Engineer	Hunk Li	Relative Humidity	54%
Test Site	TR3	Test Date	2018/03/02
Test Item	Output Power		

Test Mode (Hopping)	Channel Numbers	Frequency (MHz)	Limit (Hopping Channels)	Result
DH5	79	2402~2480	≥ 15	Pass
2DH5	79	2402~2480	≥ 15	Pass
3DH5	79	2402~2480	≥ 15	Pass

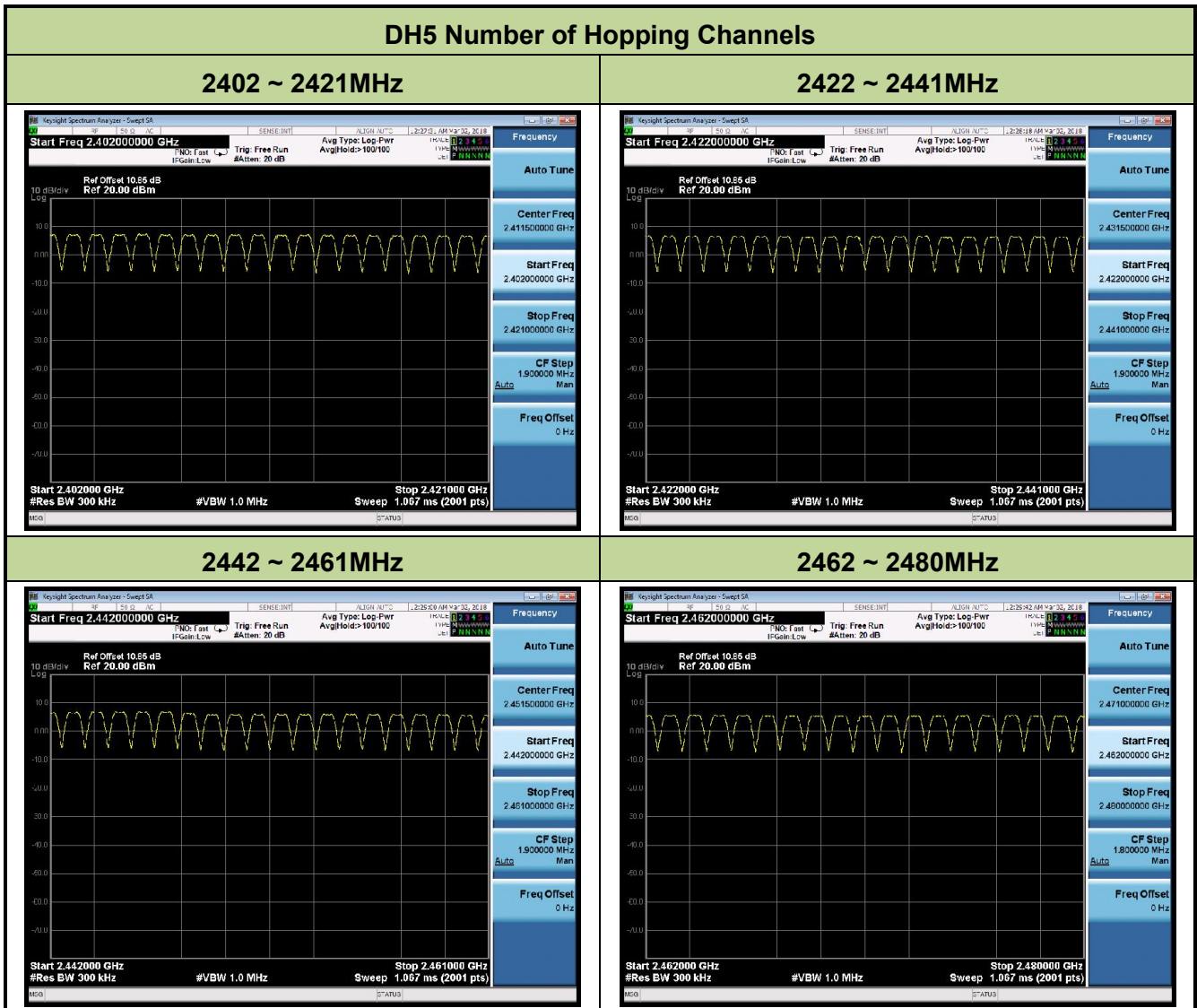

### 2DH5 Number of Hopping Channels

#### 2402 ~ 2421MHz

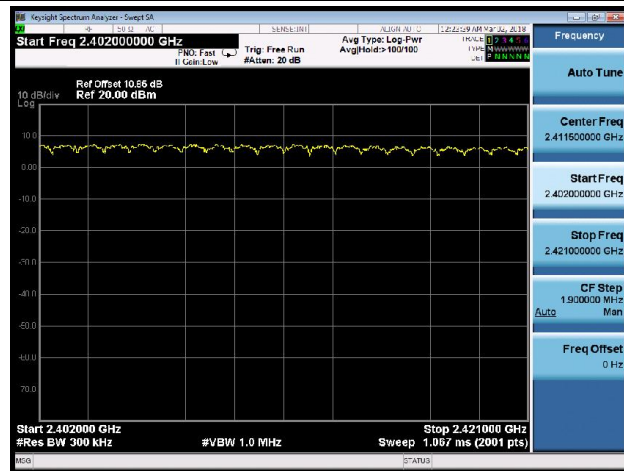

#### 2422 ~ 2441MHz

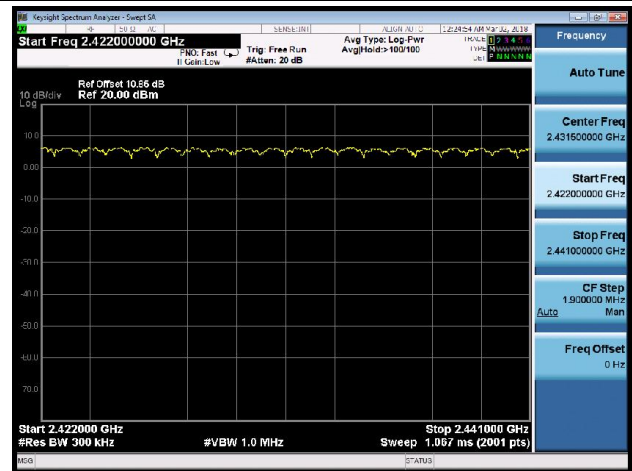

#### 2442 ~ 2461MHz

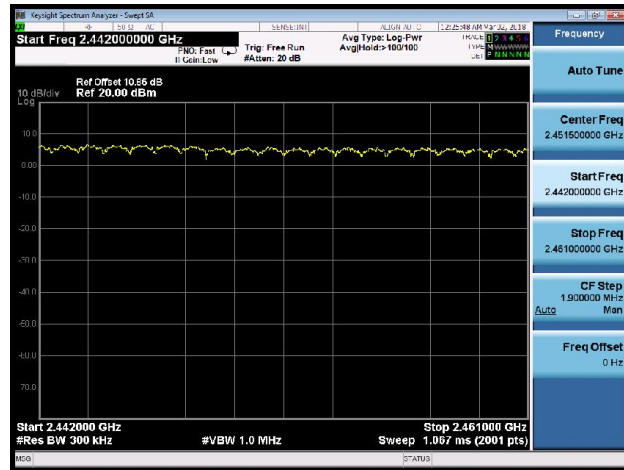

#### 2462 ~ 2480MHz

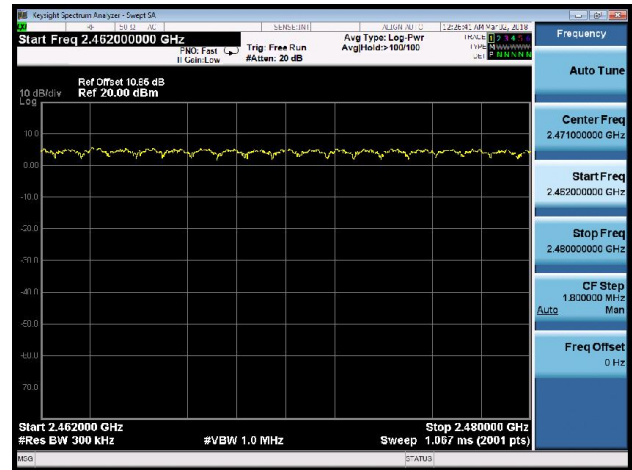

### 3DH5 Number of Hopping Channels

#### 2402 ~ 2421MHz

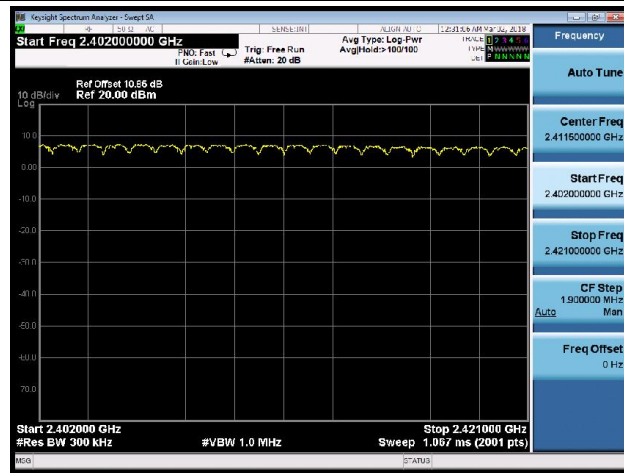

#### 2422 ~ 2441MHz

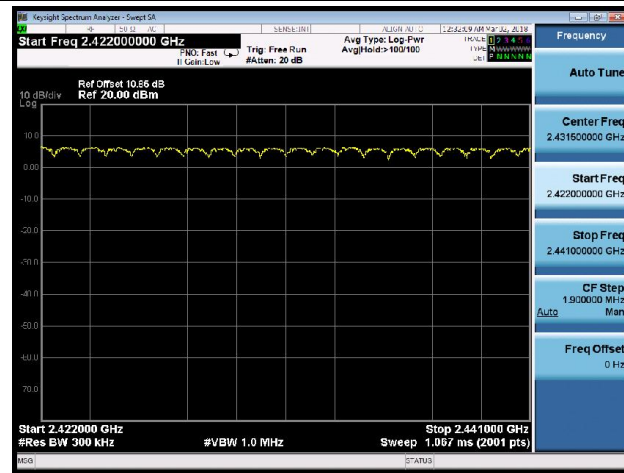

#### 2442 ~ 2461MHz

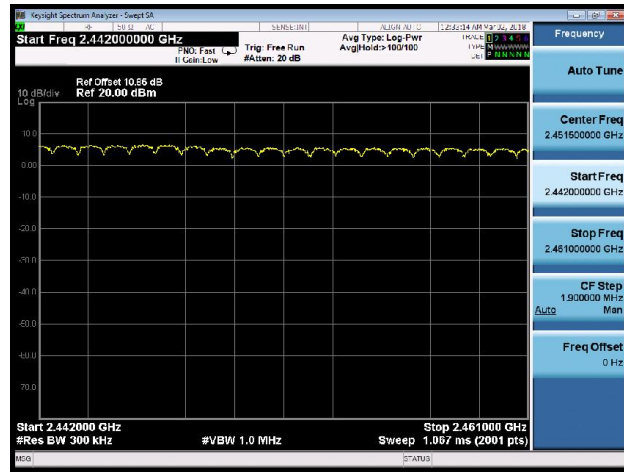

#### 2462 ~ 2480MHz

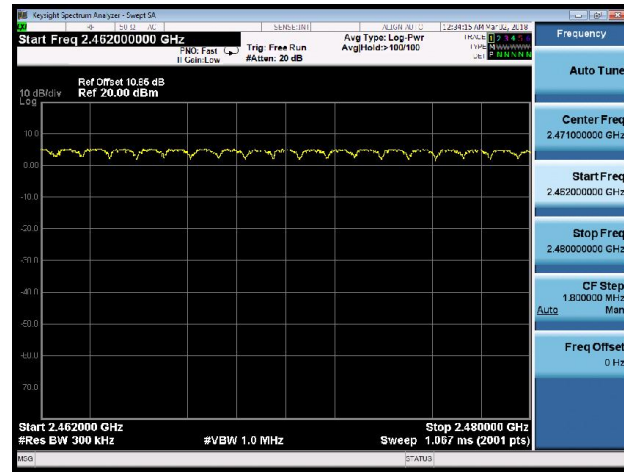

## **7.6. Time of Occupancy Measurement**

### **7.6.1. Test Limit**

The maximum permissible time of occupancy is 400ms within a period of 400ms multiplied by the number of hopping channels employed.

### **7.6.2. Test Procedure Used**

ANSI C63.10-2013 - Section 7.8.4

### **7.6.3. Test Setting**

1. Span = zero span, centered on a hopping channel.
2. RBW shall be  $\leq$  channel spacing and where possible RBW should be set  $\gg 1 / T$ , where T is the expected dwell time per channel.
3. VBW  $\geq$  RBW
4. Sweep time = as necessary to capture the entire dwell time per hopping channel
5. Detector = Peak
6. Trace mode = max hold
7. Use the marker-delta function to determine the transmit time per hop. If this value varies with different modes of operation (data rate, modulation format, number of hopping channels, etc.), then repeat this test for each variation in transmit time. An oscilloscope may be used instead of a spectrum analyzer. The EUT shall show compliance with the appropriate regulatory limit for the number of hopping channels. A plot of the data shall be included in the test report.

### 7.6.4. Test Setup

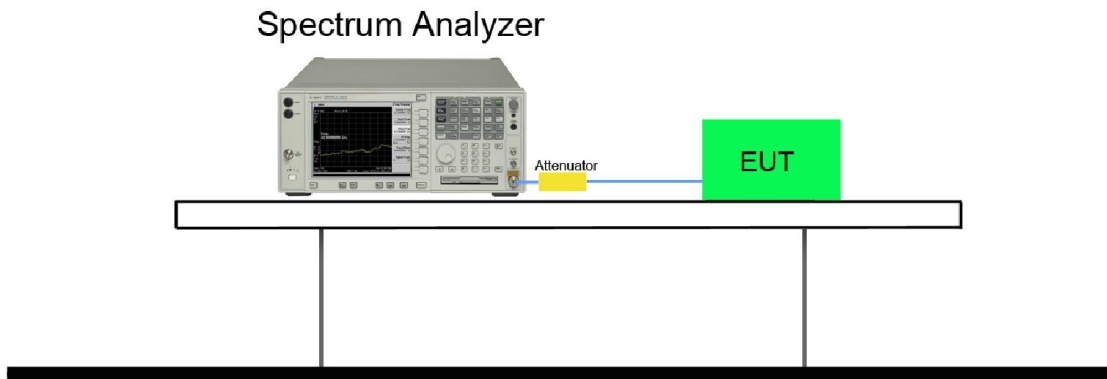



### 7.6.5. Test Result

Product	Communication Module	Temperature	23°C
Test Engineer	Hunk Li	Relative Humidity	54%
Test Site	TR3	Test Date	2018/03/02
Test Item	Time of Occupancy		

Test Mode	Channel No.	Frequency (MHz)	Hops Over Occupancy Time(Hops)	Packet Transfer Time (ms)	Time of Occupancy (ms)	Limit (ms)	Result
3DH1	39	2441	320	0.39	124.1	< 400	Pass
3DH3	39	2441	160	1.62	258.4	< 400	Pass
3DH5	39	2441	107	2.89	309.1	< 400	Pass

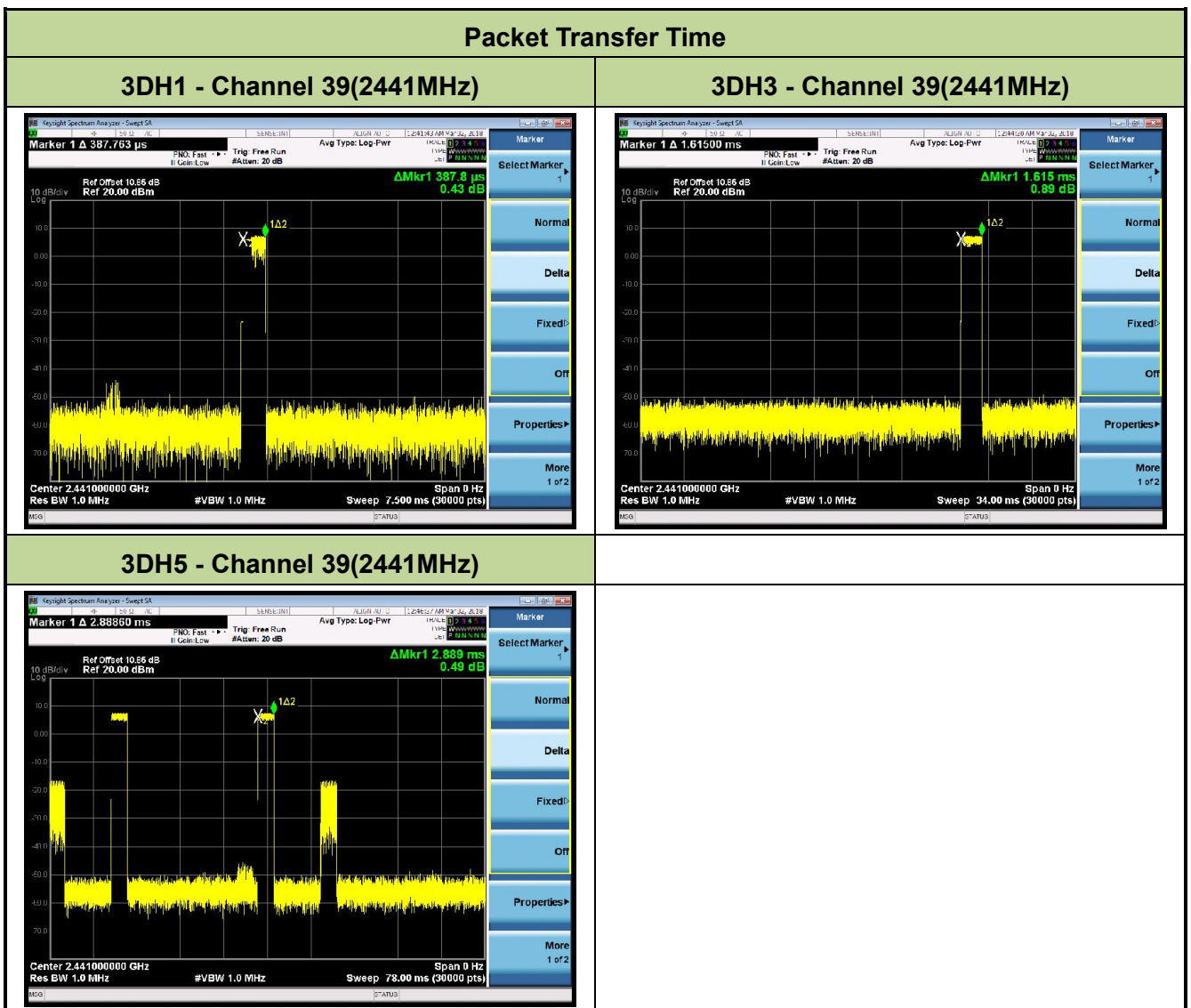

Note 1: According the Bluetooth Standard Specification, the nominal hop rate is 1600 hops/s. All Bluetooth unit participating in the piconet are time and hop synchronized to the channel.

Hops Over Occupancy Time in 31.6s for 3DH1 =  $1600 / 2 / 79 * 31.6 = 320$ .

Hops Over Occupancy Time in 31.6s for 3DH3 =  $1600 / 4 / 79 * 31.6 = 160$ .

Hops Over Occupancy Time in 31.6s for 3DH5 =  $1600 / 6 / 79 * 31.6 = 107$ .

Note 2: Time of Occupancy = Packet Transfer Time \* Hops Over Occupancy Time in 31.6s.

## **7.7. Band-edge Compliance Measurement**

### **7.7.1. Test Limit**

The maximum permissible emission level is 20dBc. Any emissions were lying outside of the emission bandwidth and in authorized band edges to a field strength limit specified in Section 15.209 of the Title 47 CFR.

### **7.7.2. Test Procedure Used**

ANSI C63.10-2013 - Section 6.10.4

### **7.7.3. Test Setting**

1. Span = wide enough to capture the peak level of the emission operating on the channel closest to the band edge, as well as any modulation products which fall outside of the authorized band of operation.
2. RBW  $\geq$  1% of spectrum analyzer display span
3. VBW  $\geq$  RBW
4. Detector = peak
5. Sweep time = auto couple
6. Trace mode = max hold
7. Trace was allowed to stabilize
8. Allow the trace to stabilize. Set the marker on the emission at the band edge, or on the highest modulation product outside of the band, if this level is greater than that at the band edge. Enable the marker-delta function, then use the marker-to-peak function to move the marker to the peak of the in-band emission.

### 7.7.4. Test Setup

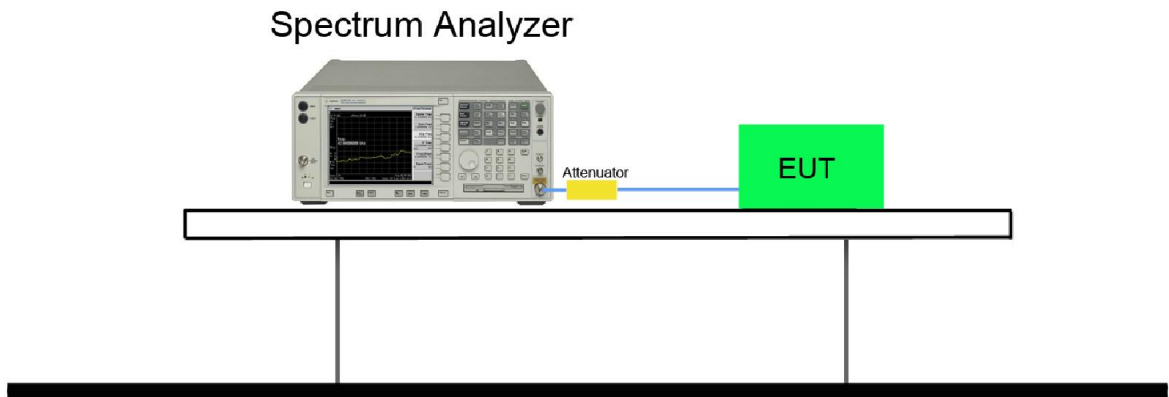

**7.7.5. Test Result**

Product	Communication Module	Temperature	23°C
Test Engineer	Hunk Li	Relative Humidity	54%
Test Site	TR3	Test Date	2018/03/02
Test Item	Band-edge Compliance		

Test Mode	Channel No.	Frequency (MHz)	Limit	Result
DH5	00	2402	20dBc	Pass
DH5	78	2480	20dBc	Pass
2DH5	00	2402	20dBc	Pass
2DH5	78	2480	20dBc	Pass
3DH5	00	2402	20dBc	Pass
3DH5	78	2480	20dBc	Pass

### DH5 Band-edge Compliance

#### Channel 00 (2402MHz)



#### Channel 78 (2480MHz)



### 2DH5 Band-edge Compliance

#### Channel 00 (2402MHz)



#### Channel 78 (2480MHz)



### 3DH5 Band-edge Compliance

#### Channel 00 (2402MHz)



#### Channel 78 (2480MHz)



### DH5 Operation Frequency Range of 20dB Bandwidth within Hopping Mode

Channel 00 (2402MHz)

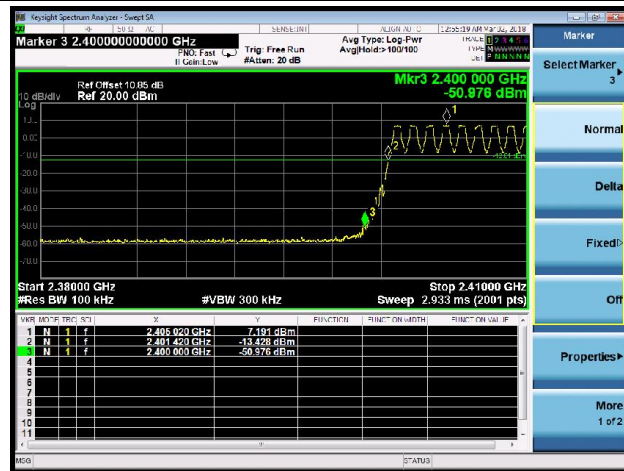

Channel 78 (2480MHz)

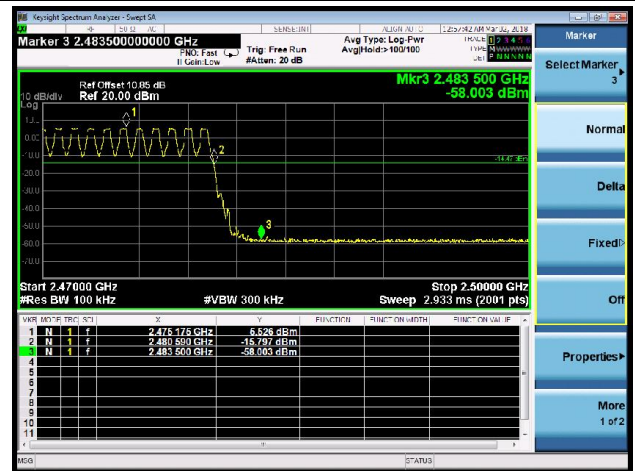

### 2DH5 Operation Frequency Range of 20dB Bandwidth within Hopping Mode

Channel 00 (2402MHz)

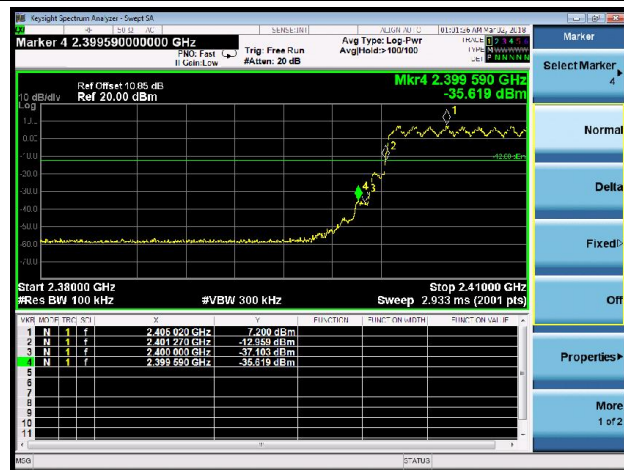

Channel 78 (2480MHz)



### 3DH5 Operation Frequency Range of 20dB Bandwidth within Hopping Mode

Channel 00 (2402MHz)



Channel 78 (2480MHz)



## **7.8. Conducted Spurious Emissions Measurement**

### **7.8.1. Test Limit**

In any 100 kHz bandwidth outside the frequency band in which the spread spectrum or digitally modulated intentional radiator is operating, the radio frequency power that is produced by the intentional radiator shall be at least 20 dB below that in the 100 kHz bandwidth within the band that contains the highest level of the desired power, based on either an RF conducted or a radiated measurement, provided the transmitter demonstrates compliance with the peak conducted or a radiated measurement, provided the transmitter demonstrates compliance with the peak conducted power limits. If the transmitter complies with the conducted power limits based on the use of RMS averaging over a time interval, the attenuation required under this paragraph shall be 30 dB instead of 20 dB.

### **7.8.2. Test Procedure Used**

ANSI C63.10-2013 - Section 7.8.8

### **7.8.3. Test Setting**

1. Span = wide enough to capture the peak level of the in-band emission and all spurious emissions (e.g., harmonics) from the lowest frequency generated in the EUT up through the 10th harmonic. Typically, several plots are required to cover this entire span.
2. RBW = 100 KHz
3. VBW  $\geq$  RBW
4. Detector = peak
5. Sweep time = auto couple
6. Trace mode = max hold
7. Trace was allowed to stabilize
8. Set the marker on the peak of any spurious emission recorded. The level displayed must comply with the limit specified in this section.



### 7.8.4. Test Setup

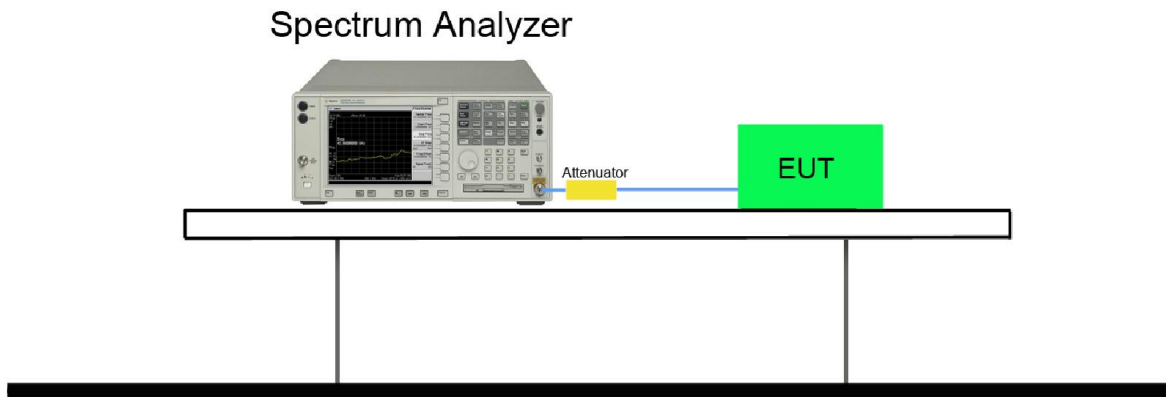

**7.8.5. Test Result**

Product	Communication Module	Temperature	23°C
Test Engineer	Hunk Li	Relative Humidity	54%
Test Site	TR3	Test Date	2018/03/02
Test Item	Conducted Spurious Emissions		

Test Mode	Channel No.	Frequency (MHz)	Limit (MHz)	Result
DH5	00	2402	20dBc	Pass
DH5	39	2441	20dBc	Pass
DH5	78	2480	20dBc	Pass
2DH5	00	2402	20dBc	Pass
2DH5	39	2441	20dBc	Pass
2DH5	78	2480	20dBc	Pass
3DH5	00	2402	20dBc	Pass
3DH5	39	2441	20dBc	Pass
3DH5	78	2480	20dBc	Pass

### DH5 Conducted Spurious Emissions

**Channel 00 (2402MHz)**



**Channel 39 (2441MHz)**



**Channel 78 (2480MHz)**



### 2DH5 Conducted Spurious Emissions

#### Channel 00 (2402MHz)

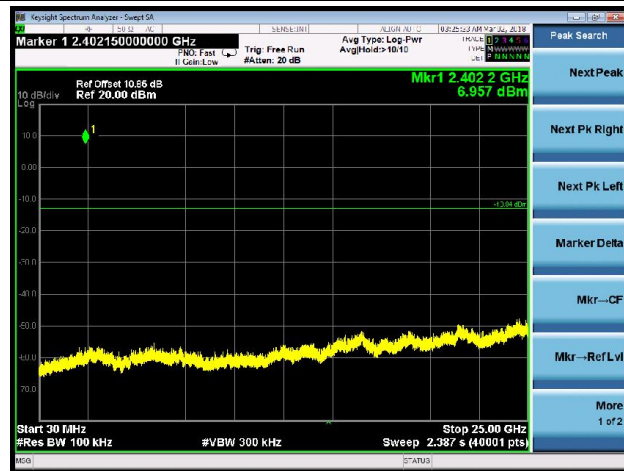

#### Channel 39 (2441MHz)



#### Channel 78 (2480MHz)

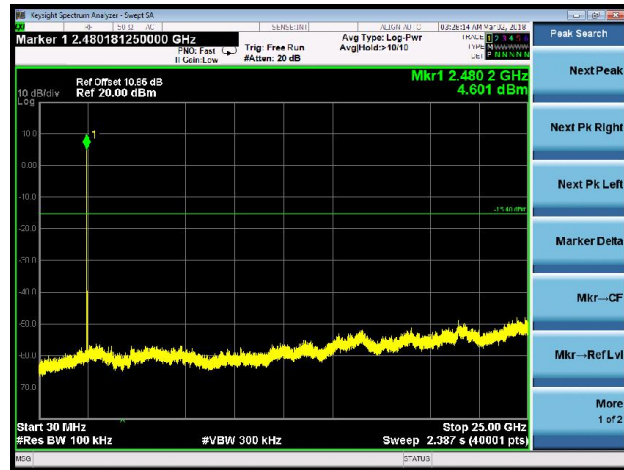

### 3DH5 Conducted Spurious Emissions

#### Channel 00 (2402MHz)

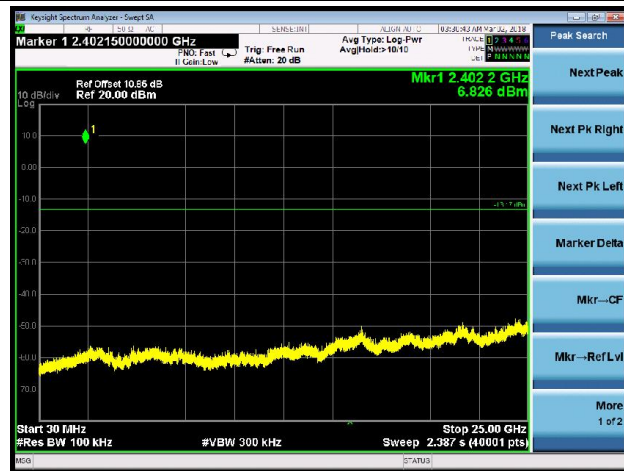

#### Channel 39 (2441MHz)



#### Channel 78 (2480MHz)

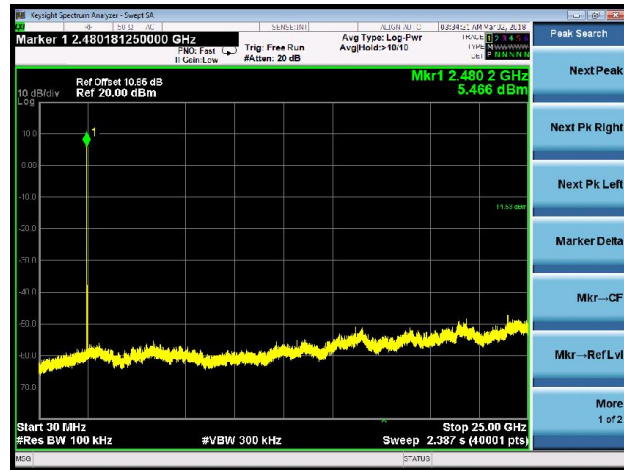

## 7.9. Radiated Spurious Emission Measurement

### 7.9.1. Test Limit

All out of band emissions appearing in a restricted band as specified in Section 15.205 of the Title 47 CFR must not exceed the limits shown in Table per Section 15.209.

FCC Part 15 Subpart C Paragraph 15.209		
Frequency [MHz]	Field Strength [uV/m]	Measured Distance [Meters]
0.009 - 0.490	2400/F (kHz)	300
0.490 - 1.705	24000/F (kHz)	30
1.705 – 30	30	30
30 – 88	100	3
88 – 216	150	3
216 – 960	200	3
Above 960	500	3

### 7.9.2. Test Procedure Used

ANSI C63.10 Section 6.3 (General Requirements)

ANSI C63.10 Section 6.4 (Standard test method below 30MHz)

ANSI C63.10 Section 6.5 (Standard test method above 30MHz to 1GHz)

ANSI C63.10 Section 6.6 (Standard test method above 1GHz)

**7.9.3. Test Setting**

**Quasi-Peak Measurements below 1GHz**

1. Analyzer center frequency was set to the frequency of the radiated spurious emission of interest
2. Span was set greater than 1MHz
3. RBW = as specified in Table 1
4. Detector = CISPR quasi-peak
5. Sweep time = auto couple
6. Trace was allowed to stabilize

**Table 1 - RBW as a function of frequency**

Frequency	RBW
9 ~ 150 kHz	200 ~ 300 Hz
0.15 ~ 30 MHz	9 ~ 10 kHz
30 ~ 1000 MHz	100 ~ 120 kHz

**Peak Measurements above 1GHz**

1. Analyzer center frequency was set to the frequency of the radiated spurious emission of interest
2. RBW = 1MHz
3. VBW = 3MHz
4. Detector = peak
5. Sweep time = auto couple
6. Trace mode = max hold
7. Trace was allowed to stabilize

**Average Measurements above 1GHz (Method VB)**

1. Analyzer center frequency was set to the frequency of the radiated spurious emission of interest
2. RBW = 1MHz
3. VBW; If the EUT is configured to transmit with duty cycle  $\geq 98\%$ , set VBW = 10 Hz.  
If the EUT duty cycle is  $< 98\%$ , set VBW  $\geq 1/T$ . T is the minimum transmission duration.
4. Detector = Peak
5. Sweep time = auto
6. Trace mode = max hold
7. Trace was allowed to stabilize

### 7.9.4. Test Setup

#### 9kHz ~ 30MHz Test Setup:

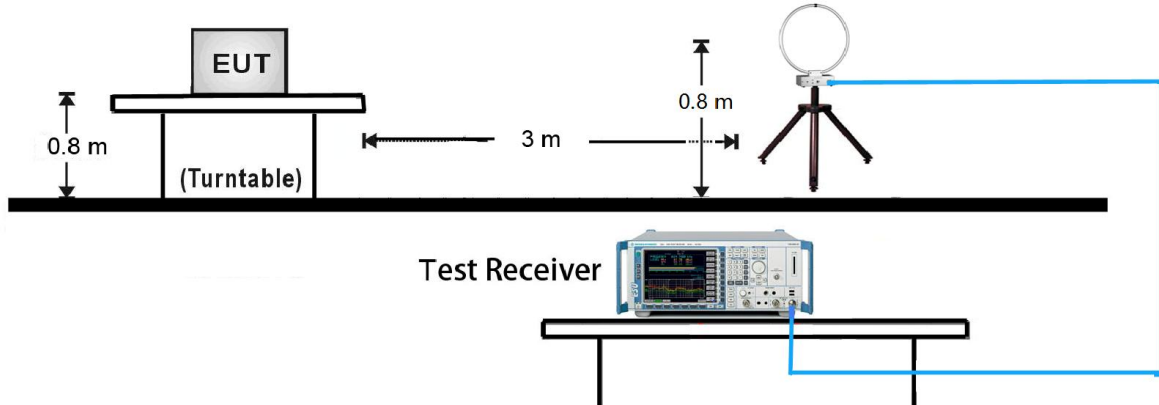

#### 30MHz ~ 1GHz Test Setup:

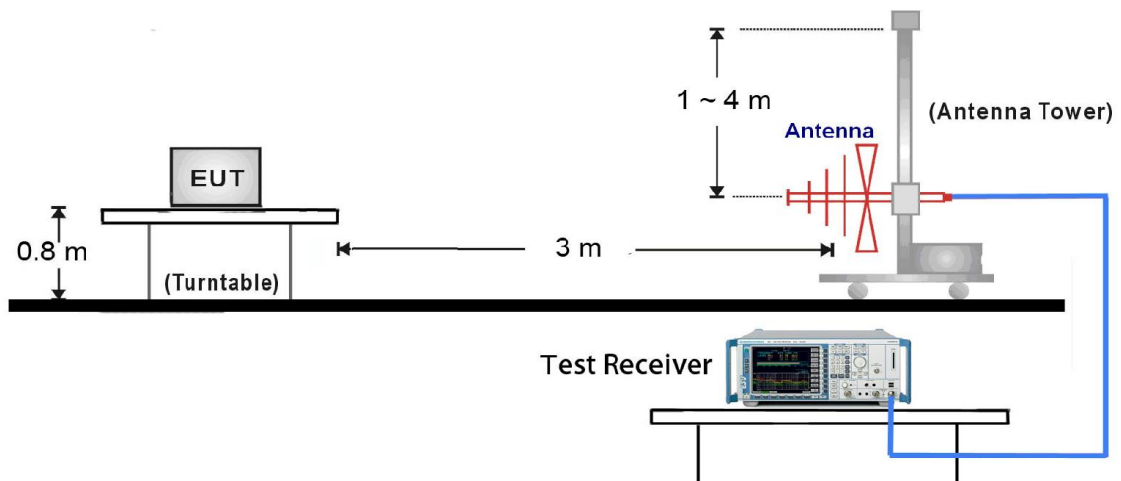

#### 1GHz ~ 25GHz Test Setup:

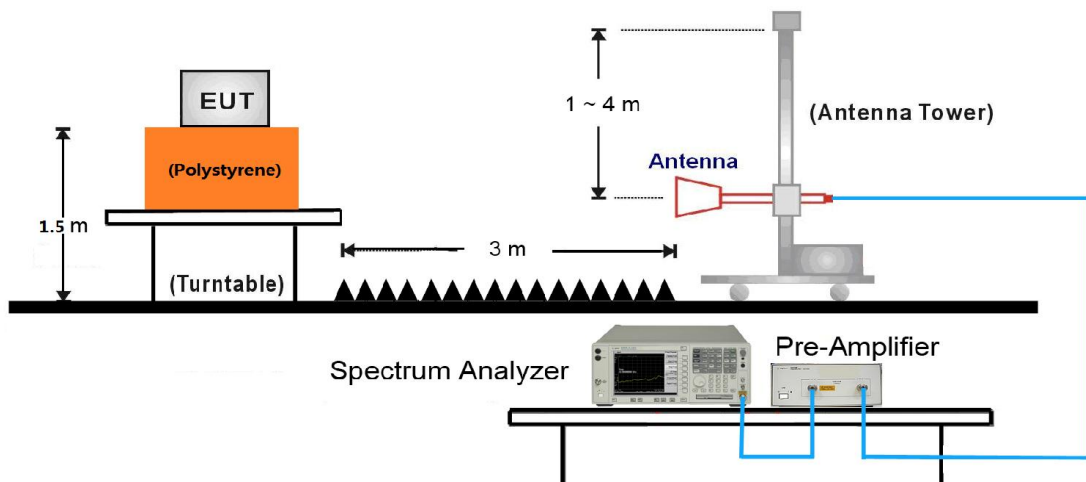



**7.9.5. Test Result**

Product	Communication Module	Temperature	26°C
Test Engineer	Dandy Li	Relative Humidity	56%
Test Site	AC1	Test Date	2018/03/09
Test Mode:	DH5	Test Channel:	00
Remark:	1. Average measurement was not performed if peak level lower than average limit. 2. Other frequency was 20dB below limit line within 1-18GHz, there is not show in the report.		

Mark	Frequency (MHz)	Reading Level (dBμV)	Factor (dB)	Measure Level (dBμV/m)	Limit (dBμV/m)	Margin (dB)	Detector	Polarization
	7467.8	31.9	14.1	46.0	74.0	-28.0	Peak	Horizontal
	8414.1	31.2	13.9	45.1	74.0	-28.9	Peak	Horizontal
*	9945.9	30.3	17.4	47.7	80.3	-32.6	Peak	Horizontal
*	12778.1	29.1	20.5	49.6	80.3	-30.7	Peak	Horizontal
	7467.8	32.1	14.1	46.2	74.0	-27.8	Peak	Vertical
	8468.6	32.2	14.0	46.2	74.0	-27.8	Peak	Vertical
*	10109.3	31.0	18.0	49.0	80.3	-31.3	Peak	Vertical
*	12778.1	29.1	20.5	49.6	80.3	-30.7	Peak	Vertical

Note 1: "\*" is not in restricted band, its limit is 20dBc of the fundamental emission level (100.3dBμV/m) or 15.209 which is higher.

Note 2: Measure Level (dBμV/m) = Reading Level (dBμV) + Factor (dB)

Factor (dB) = Cable Loss (dB) + Antenna Factor (dB/m) - Pre\_Amplifier Gain (dB)

Product	Communication Module	Temperature	26°C
Test Engineer	Dandy Li	Relative Humidity	56%
Test Site	AC1	Test Date	2018/03/09
Test Mode:	DH5	Test Channel:	39
Remark:	1. Average measurement was not performed if peak level lower than average limit. 2. Other frequency was 20dB below limit line within 1-18GHz, there is not show in the report.		

Mark	Frequency (MHz)	Reading Level (dBμV)	Factor (dB)	Measure Level (dBμV/m)	Limit (dBμV/m)	Margin (dB)	Detector	Polarization
	7467.8	32.1	14.1	46.2	74.0	-27.8	Peak	Horizontal
	8257.5	30.7	14.1	44.8	74.0	-29.2	Peak	Horizontal
*	9986.8	30.4	17.4	47.8	80.1	-32.3	Peak	Horizontal
*	12839.4	29.3	20.6	49.9	80.1	-30.2	Peak	Horizontal
	7413.3	32.3	14.0	46.3	74.0	-27.7	Peak	Vertical
	8312.0	31.7	13.8	45.5	74.0	-28.5	Peak	Vertical
*	10075.3	31.6	17.5	49.1	80.1	-31.0	Peak	Vertical
*	12839.4	29.3	20.6	49.9	80.1	-30.2	Peak	Vertical

Note 1: "\*" is not in restricted band, its limit is 20dBc of the fundamental emission level (100.1dBμV/m) or 15.209 which is higher.

Note 2: Measure Level (dBμV/m) = Reading Level (dBμV) + Factor (dB)

Factor (dB) = Cable Loss (dB) + Antenna Factor (dB/m) - Pre\_Amplifier Gain (dB)

Product	Communication Module	Temperature	26°C
Test Engineer	Dandy Li	Relative Humidity	56%
Test Site	AC1	Test Date	2018/03/09
Test Mode:	DH5	Test Channel:	78
Remark:	1. Average measurement was not performed if peak level lower than average limit. 2. Other frequency was 20dB below limit line within 1-18GHz, there is not show in the report.		

Mark	Frequency (MHz)	Reading Level (dBμV)	Factor (dB)	Measure Level (dBμV/m)	Limit (dBμV/m)	Margin (dB)	Detector	Polarization
	7413.3	32.3	14.0	46.3	74.0	-27.7	Peak	Horizontal
	8400.5	31.9	13.8	45.7	74.0	-28.3	Peak	Horizontal
*	10061.7	30.2	17.5	47.7	79.6	-31.9	Peak	Horizontal
*	12778.1	29.6	20.5	50.1	79.6	-29.5	Peak	Horizontal
	7365.6	32.0	13.9	45.9	74.0	-28.1	Peak	Vertical
	8250.7	30.6	14.1	44.7	74.0	-29.3	Peak	Vertical
*	10259.1	31.0	18.2	49.2	79.6	-30.4	Peak	Vertical
*	12778.1	29.6	20.5	50.1	79.6	-29.5	Peak	Vertical

Note 1: "\*" is not in restricted band, its limit is 20dBc of the fundamental emission level (99.6dBμV/m) or 15.209 which is higher.

Note 2: Measure Level (dBμV/m) = Reading Level (dBμV) + Factor (dB)

Factor (dB) = Cable Loss (dB) + Antenna Factor (dB/m) - Pre\_Amplifier Gain (dB)

Product	Communication Module	Temperature	26°C
Test Engineer	Dandy Li	Relative Humidity	56%
Test Site	AC1	Test Date	2018/03/09
Test Mode:	2DH5	Test Channel:	00
Remark:	1. Average measurement was not performed if peak level lower than average limit. 2. Other frequency was 20dB below limit line within 1-18GHz, there is not show in the report.		

Mark	Frequency (MHz)	Reading Level (dBμV)	Factor (dB)	Measure Level (dBμV/m)	Limit (dBμV/m)	Margin (dB)	Detector	Polarization
	7365.6	32.0	13.9	45.9	74.0	-28.1	Peak	Horizontal
	8277.9	31.3	14.0	45.3	74.0	-28.7	Peak	Horizontal
*	9898.3	30.5	17.3	47.8	81.1	-33.3	Peak	Horizontal
*	12893.9	28.8	21.1	49.9	81.1	-31.2	Peak	Horizontal
	7542.7	32.1	14.4	46.5	74.0	-27.5	Peak	Vertical
	8352.8	31.9	13.8	45.7	74.0	-28.3	Peak	Vertical
*	10034.4	31.0	17.7	48.7	81.1	-32.4	Peak	Vertical
*	12893.9	28.8	21.1	49.9	81.1	-31.2	Peak	Vertical

Note 1: "\*" is not in restricted band, its limit is 20dBc of the fundamental emission level (101.1dBμV/m) or 15.209 which is higher.

Note 2: Measure Level (dBμV/m) = Reading Level (dBμV) + Factor (dB)

Factor (dB) = Cable Loss (dB) + Antenna Factor (dB/m) - Pre\_Amplifier Gain (dB)

Product	Communication Module	Temperature	26°C
Test Engineer	Dandy Li	Relative Humidity	56%
Test Site	AC1	Test Date	2018/03/09
Test Mode:	2DH5	Test Channel:	39
Remark:	1. Average measurement was not performed if peak level lower than average limit. 2. Other frequency was 20dB below limit line within 1-18GHz, there is not show in the report.		

Mark	Frequency (MHz)	Reading Level (dBμV)	Factor (dB)	Measure Level (dBμV/m)	Limit (dBμV/m)	Margin (dB)	Detector	Polarization
	7392.9	31.7	13.8	45.5	74.0	-28.5	Peak	Horizontal
	8352.8	31.0	13.8	44.8	74.0	-29.2	Peak	Horizontal
*	10061.7	30.5	17.5	48.0	80.7	-32.7	Peak	Horizontal
*	12893.9	29.0	21.1	50.1	80.7	-30.6	Peak	Horizontal
	7392.9	31.7	13.8	45.5	74.0	-28.5	Peak	Vertical
	8277.9	30.9	14.0	44.9	74.0	-29.1	Peak	Vertical
*	9911.9	30.5	17.4	47.9	80.7	-32.8	Peak	Vertical
*	12839.4	29.2	20.6	49.8	80.7	-30.9	Peak	Vertical

Note 1: "\*" is not in restricted band, its limit is 20dBc of the fundamental emission level (100.7dBμV/m) or 15.209 which is higher.

Note 2: Measure Level (dBμV/m) = Reading Level (dBμV) + Factor (dB)

Factor (dB) = Cable Loss (dB) + Antenna Factor (dB/m) - Pre\_Amplifier Gain (dB)

Product	Communication Module	Temperature	26°C
Test Engineer	Dandy Li	Relative Humidity	56%
Test Site	AC1	Test Date	2018/03/09
Test Mode:	2DH5	Test Channel:	79
Remark:	1. Average measurement was not performed if peak level lower than average limit. 2. Other frequency was 20dB below limit line within 1-18GHz, there is not show in the report.		

Mark	Frequency (MHz)	Reading Level (dBμV)	Factor (dB)	Measure Level (dBμV/m)	Limit (dBμV/m)	Margin (dB)	Detector	Polarization
	7467.8	31.9	14.1	46.0	74.0	-28.0	Peak	Horizontal
	8386.9	31.5	13.8	45.3	74.0	-28.7	Peak	Horizontal
*	9986.8	29.8	17.4	47.2	80.4	-33.2	Peak	Horizontal
*	12839.4	29.2	20.6	49.8	80.4	-30.6	Peak	Horizontal
	7467.8	31.9	14.1	46.0	74.0	-28.0	Peak	Vertical
	8427.7	30.7	13.9	44.6	74.0	-29.4	Peak	Vertical
*	10157.0	31.1	17.8	48.9	80.4	-31.5	Peak	Vertical
*	12750.9	28.5	20.3	48.8	80.4	-31.6	Peak	Vertical

Note 1: "\*" is not in restricted band, its limit is 20dBc of the fundamental emission level (100.4dBμV/m) or 15.209 which is higher.

Note 2: Measure Level (dBμV/m) = Reading Level (dBμV) + Factor (dB)

Factor (dB) = Cable Loss (dB) + Antenna Factor (dB/m) - Pre\_Amplifier Gain (dB)

Product	Communication Module	Temperature	26°C
Test Engineer	Dandy Li	Relative Humidity	56%
Test Site	AC1	Test Date	2018/03/09
Test Mode:	3DH5	Test Channel:	00
Remark:	1. Average measurement was not performed if peak level lower than average limit. 2. Other frequency was 20dB below limit line within 1-18GHz, there is not show in the report.		

Mark	Frequency (MHz)	Reading Level (dBμV)	Factor (dB)	Measure Level (dBμV/m)	Limit (dBμV/m)	Margin (dB)	Detector	Polarization
	7454.1	31.5	14.2	45.7	74.0	-28.3	Peak	Horizontal
	8386.9	31.6	13.8	45.4	74.0	-28.6	Peak	Horizontal
*	10000.4	30.1	17.5	47.6	81.1	-33.5	Peak	Horizontal
*	12934.7	28.7	21.1	49.8	81.1	-31.3	Peak	Horizontal
	7454.1	31.5	14.2	45.7	74.0	-28.3	Peak	Vertical
	8359.6	31.8	13.8	45.6	74.0	-28.4	Peak	Vertical
*	10211.5	30.9	18.2	49.1	81.1	-32.0	Peak	Vertical
*	12778.1	29.6	20.5	50.1	81.1	-31.0	Peak	Vertical

Note 1: "\*" is not in restricted band, its limit is 20dBc of the fundamental emission level (101.1dBμV/m) or 15.209 which is higher.

Note 2: Measure Level (dBμV/m) = Reading Level (dBμV) + Factor (dB)

Factor (dB) = Cable Loss (dB) + Antenna Factor (dB/m) - Pre\_Amplifier Gain (dB)

Product	Communication Module	Temperature	26°C
Test Engineer	Dandy Li	Relative Humidity	56%
Test Site	AC1	Test Date	2018/03/09
Test Mode:	3DH5	Test Channel:	39
Remark:	1. Average measurement was not performed if peak level lower than average limit. 2. Other frequency was 20dB below limit line within 1-18GHz, there is not show in the report.		

Mark	Frequency (MHz)	Reading Level (dBμV)	Factor (dB)	Measure Level (dBμV/m)	Limit (dBμV/m)	Margin (dB)	Detector	Polarization
	7495.0	31.2	14.0	45.2	74.0	-28.8	Peak	Horizontal
	8366.4	31.0	13.8	44.8	74.0	-29.2	Peak	Horizontal
*	9857.4	31.9	17.3	49.2	80.9	-31.7	Peak	Horizontal
*	12778.1	29.4	20.5	49.9	80.9	-31.0	Peak	Horizontal
	7495.0	31.2	14.0	45.2	74.0	-28.8	Peak	Vertical
	8277.9	32.1	14.0	46.1	74.0	-27.9	Peak	Vertical
*	10218.3	31.7	18.2	49.9	80.9	-31.0	Peak	Vertical
*	12934.7	28.7	21.1	49.8	80.9	-31.1	Peak	Vertical

Note 1: "\*" is not in restricted band, its limit is 20dBc of the fundamental emission level (100.9dBμV/m) or 15.209 which is higher.

Note 2: Measure Level (dBμV/m) = Reading Level (dBμV) + Factor (dB)

Factor (dB) = Cable Loss (dB) + Antenna Factor (dB/m) - Pre\_Amplifier Gain (dB)



Product	Communication Module	Temperature	26°C
Test Engineer	Dandy Li	Relative Humidity	56%
Test Site	AC1	Test Date	2018/03/09
Test Mode:	3DH5	Test Channel:	78
Remark:	1. Average measurement was not performed if peak level lower than average limit. 2. Other frequency was 20dB below limit line within 1-18GHz, there is not show in the report.		

Mark	Frequency (MHz)	Reading Level (dBμV)	Factor (dB)	Measure Level (dBμV/m)	Limit (dBμV/m)	Margin (dB)	Detector	Polarization
	7399.7	31.3	13.9	45.2	74.0	-28.8	Peak	Horizontal
	8461.8	32.3	13.9	46.2	74.0	-27.8	Peak	Horizontal
*	9986.8	30.4	17.4	47.8	80.7	-32.9	Peak	Horizontal
*	12750.9	28.5	20.3	48.8	80.7	-31.9	Peak	Horizontal
	7399.7	31.3	13.9	45.2	74.0	-28.8	Peak	Vertical
	8475.4	32.6	14.0	46.6	74.0	-27.4	Peak	Vertical
*	10170.6	30.9	17.9	48.8	80.7	-31.9	Peak	Vertical
*	12778.1	29.4	20.5	49.9	80.7	-30.8	Peak	Vertical

Note 1: "\*" is not in restricted band, its limit is 20dBc of the fundamental emission level (100.7dBμV/m) or 15.209 which is higher.

Note 2: Measure Level (dBμV/m) = Reading Level (dBμV) + Factor (dB)

Factor (dB) = Cable Loss (dB) + Antenna Factor (dB/m) - Pre\_Amplifier Gain (dB)

**The worst case of Radiated Emission below 1GHz:**

Site: AC1	Time: 2018/03/15 - 16:59
Limit: FCC_Part15.209_RSE(3m)	Engineer: Alex Ma
Probe: VULB 9168 _20-2000MHz	Polarity: Horizontal
EUT: Communication Module	Power: DC 3.3V
<b>Note: There is the worst case within frequency range 30MHz~1GHz.</b>	

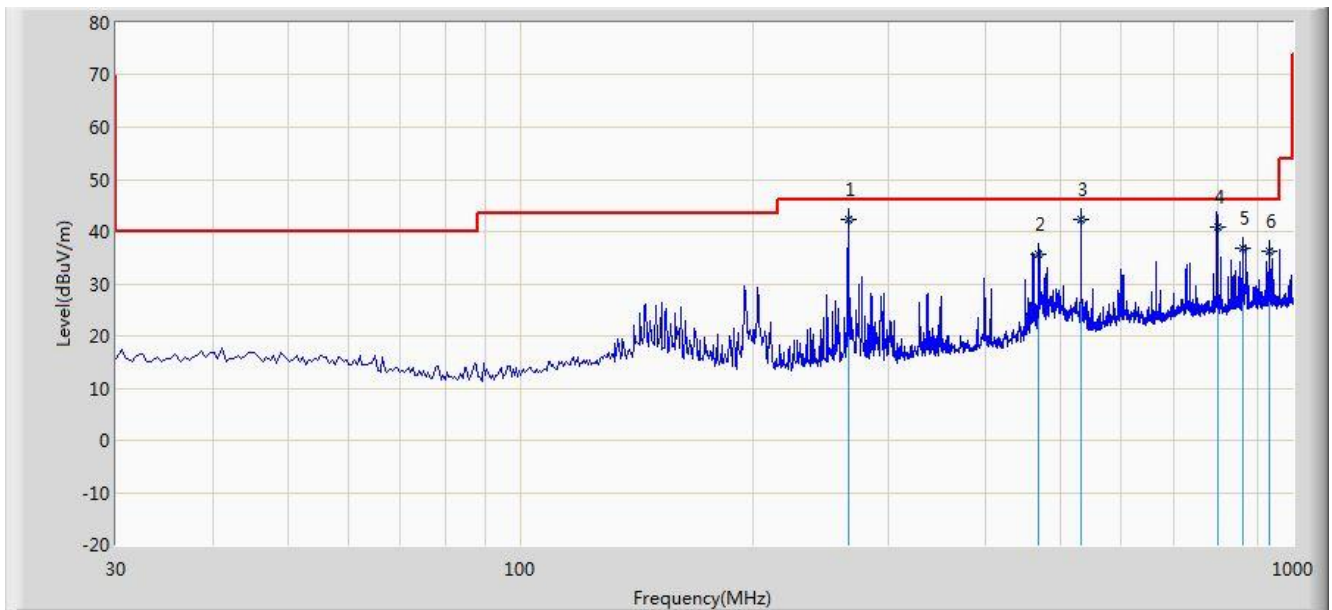

No	Flag	Mark	Frequency (MHz)	Measure Level (dBuV/m)	Reading Level (dBuV)	Over Limit (dB)	Limit (dBuV/m)	Factor (dB)	Type
1		*	265.714	42.360	28.910	-3.640	46.000	13.450	QP
2			469.410	35.789	17.634	-10.211	46.000	18.156	QP
3			531.965	42.354	23.142	-3.646	46.000	19.212	QP
4			798.240	40.953	17.651	-5.047	46.000	23.302	QP
5			860.805	36.771	12.891	-9.229	46.000	23.879	QP
6			931.130	36.199	11.358	-9.801	46.000	24.840	QP

Note 1: Measure Level (dBuV/m) = Reading Level (dBuV) + Factor (dB)

Factor (dB) = Cable Loss (dB) + Antenna Factor (dB/m)

Note 2: The test trace is same as the ambient noise and the amplitude of the emissions are attenuated more than 20dB below the permissible (the test frequency range: 9kHz ~ 30MHz, 18GHz ~ 25GHz), therefore no data appear in the report.

Site: AC1	Time: 2018/03/15 - 16:59
Limit: FCC_Part15.209_RSE(3m)	Engineer: Alex Ma
Probe: VULB 9168 _20-2000MHz	Polarity: Vertical
EUT: Communication Module	Power: DC 3.3V
<b>Note: There is the worst case within frequency range 30MHz~1GHz.</b>	

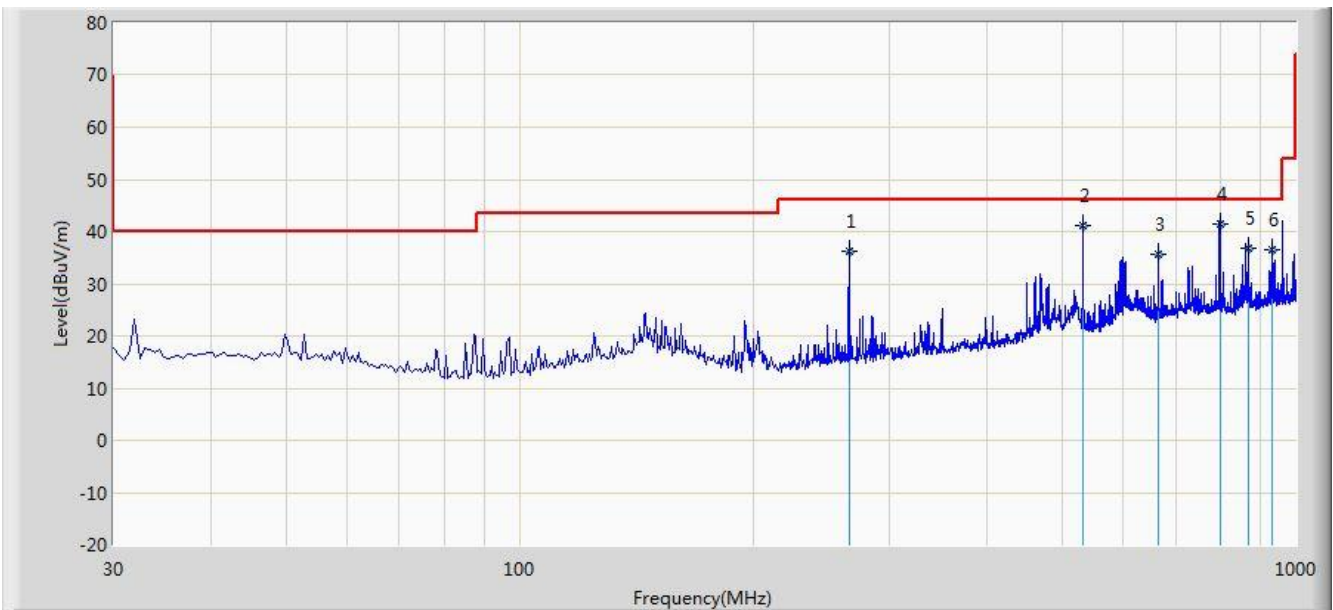

No	Flag	Mark	Frequency (MHz)	Measure Level (dBuV/m)	Reading Level (dBuV)	Over Limit (dB)	Limit (dBuV/m)	Factor (dB)	Type
1			265.710	36.234	22.784	-9.766	46.000	13.450	QP
2			531.975	41.192	21.980	-4.808	46.000	19.212	QP
3			664.865	35.736	14.070	-10.264	46.000	21.666	QP
4		*	798.250	41.577	18.275	-4.423	46.000	23.302	QP
5			868.584	36.811	12.832	-9.189	46.000	23.979	QP
6			931.150	36.661	11.820	-9.339	46.000	24.840	QP

Note 1: Measure Level (dBuV/m) = Reading Level (dBuV) + Factor (dB)

Factor (dB) = Cable Loss (dB) + Antenna Factor (dB/m)

Note 2: The test trace is same as the ambient noise and the amplitude of the emissions are attenuated more than 20dB below the permissible (the test frequency range: 9kHz ~ 30MHz, 18GHz ~ 25GHz), therefore no data appear in the report.

## 7.10. Radiated Restricted Band Edge Measurement

### For 15.205 requirement:

Radiated emissions which fall in the restricted bands, as defined in Section 15.205(a) of FCC part 15, must also comply with the radiated emission limits specified in Section 15.209(a).

Frequency (MHz)	Frequency (MHz)	Frequency (MHz)	Frequency (GHz)
0.090 - 0.110	16.42 - 16.423	399.9 - 410	4.5 - 5.15
<sup>1</sup> 0.495 - 0.505	16.69475 - 16.69525	608 - 614	5.35 - 5.46
2.1735 - 2.1905	16.80425 - 16.80475	960 - 1240	7.25 - 7.75
4.125 - 4.128	25.5 - 25.67	1300 - 1427	8.25 - 8.5
4.17725 - 4.17775	37.5 - 38.25	1435 - 1626.5	9.0 - 9.2
4.20725 - 4.20775	73 - 74.6	1645.5 - 1646.5	9.3 - 9.5
6.215 - 6.218	74.8 - 75.2	1660 - 1710	10.6 - 12.7
6.26775 - 6.26825	108 - 121.94	1718.8 - 1722.2	13.25 - 13.4
6.31175 - 6.31225	123 - 138	2200 - 2300	14.47 - 14.5
8.291 - 8.294	149.9 - 150.05	2310 - 2390	15.35 - 16.2
8.362 - 8.366	156.52475 - 156.525	2483.5 - 2500	17.7 - 21.4
8.37625 - 8.38675	156.7 - 156.9	2690 - 2900	22.01 - 23.12
8.41425 - 8.41475	162.0125 - 167.17	3260 - 3267	23.6 - 24.0
12.29 - 12.293	167.72 - 173.2	3332 - 3339	31.2 - 31.8
12.51975 - 12.52025	240 - 285	3345.8 - 3358	36.43 - 36.5
12.57675 - 12.57725	322 - 335.4	3600 - 4400	( <sup>2</sup> )
13.36 - 13.41	--	--	--

All out of band emissions appearing in a restricted band as specified in Section 15.205 of the Title 47CFR must not exceed the limits shown in Table per Section 15.209.

FCC Part 15 Subpart C Paragraph 15.209		
Frequency [MHz]	Field Strength [uV/m]	Measured Distance [Meters]
0.009 – 0.490	2400/F (kHz)	300
0.490 – 1.705	24000/F (kHz)	30
1.705 - 30	30	30
30 - 88	100	3
88 - 216	150	3
216 - 960	200	3
Above 960	500	3

**7.10.1. Test Procedure Used**

ANSI C63.10 Section 6.3 (General Requirements)

ANSI C63.10 Section 6.6 (Standard test method above 1GHz)

**7.10.2. Test Setting**

**Peak Field Strength Measurements**

1. Analyzer center frequency was set to the frequency of the radiated spurious emission of interest
2. RBW = 1MHz
3. VBW = 3MHz
4. Detector = peak
5. Sweep time = auto couple
6. Trace mode = max hold
7. Trace was allowed to stabilize

### Average Measurements above 1GHz (Method VB)

1. Analyzer center frequency was set to the frequency of the radiated spurious emission of interest
2. RBW = 1MHz
3. VBW; If the EUT is configured to transmit with duty cycle  $\geq 98\%$ , set VBW = 10 Hz.  
If the EUT duty cycle is  $< 98\%$ , set VBW  $\geq 1/T$ . T is the minimum transmission duration.
4. Detector = Peak
5. Sweep time = auto
6. Trace mode = max hold
7. Trace was allowed to stabilize

#### 7.10.3. Test Setup

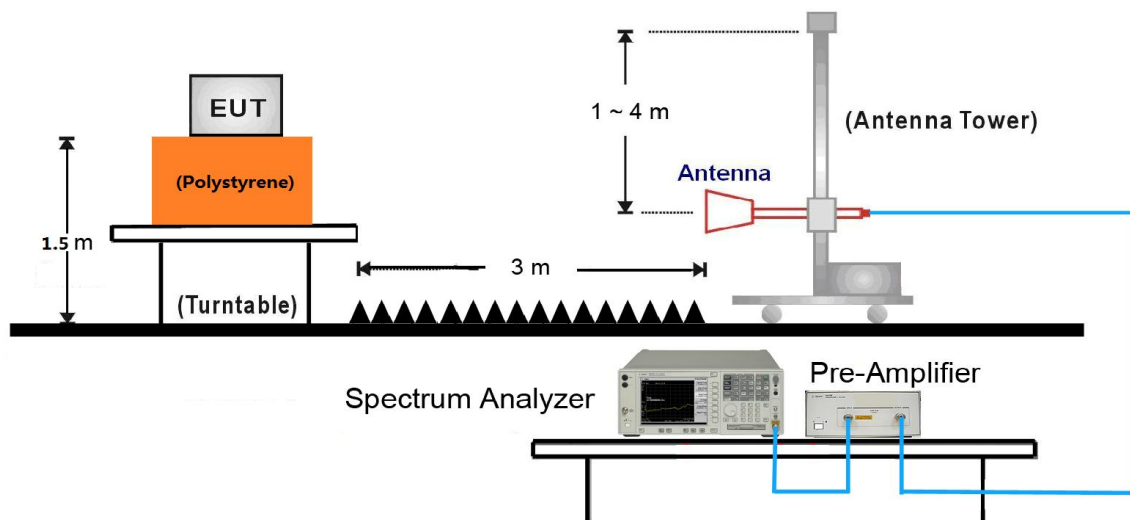

**7.10.4. Test Result**

Site: AC1	Time: 2018/03/08 - 00:22
Limit: FCC_Part15.209_RE(3m)	Engineer: Dandy Li
Probe: BBHA9120D_1-18GHz	Polarity: Horizontal
EUT: Communication Module	Power: DC 3.3V
Test Mode: Transmit by DH5 at channel 2402MHz	

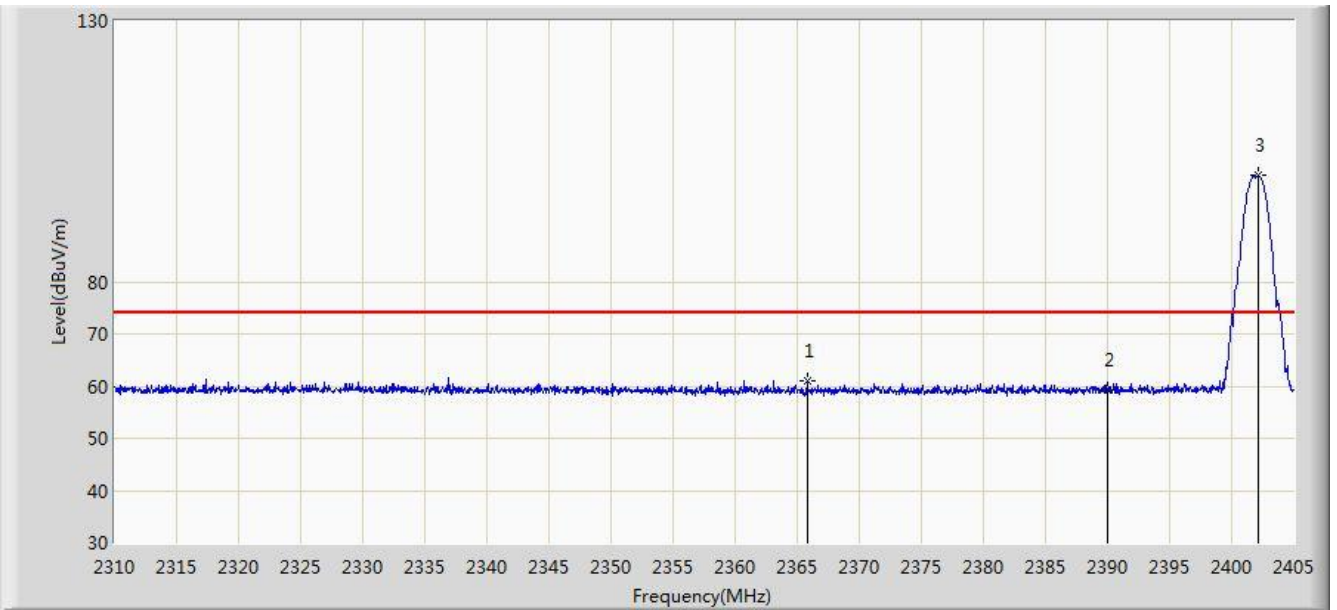

No	Flag	Mark	Frequency (MHz)	Measure Level (dBuV/m)	Reading Level (dBuV)	Over Limit (dB)	Limit (dBuV/m)	Factor (dB)	Type
1			2365.812	60.925	28.311	-13.075	74.000	32.614	PK
2			2390.000	59.378	26.803	-14.622	74.000	32.575	PK
3		*	2402.150	100.295	67.736	N/A	N/A	32.559	PK

Note: Measure Level (dB $\mu$ V/m) = Reading Level (dB $\mu$ V) + Factor (dB)

Factor (dB) = Cable Loss (dB) + Antenna Factor (dB/m)

Site: AC1	Time: 2018/03/08 - 00:46
Limit: FCC_Part15.209_RE(3m)	Engineer: Dandy Li
Probe: BBHA9120D_1-18GHz	Polarity: Horizontal
EUT: Communication Module	Power: DC 3.3V
Test Mode: Transmit by DH5 at channel 2402MHz	

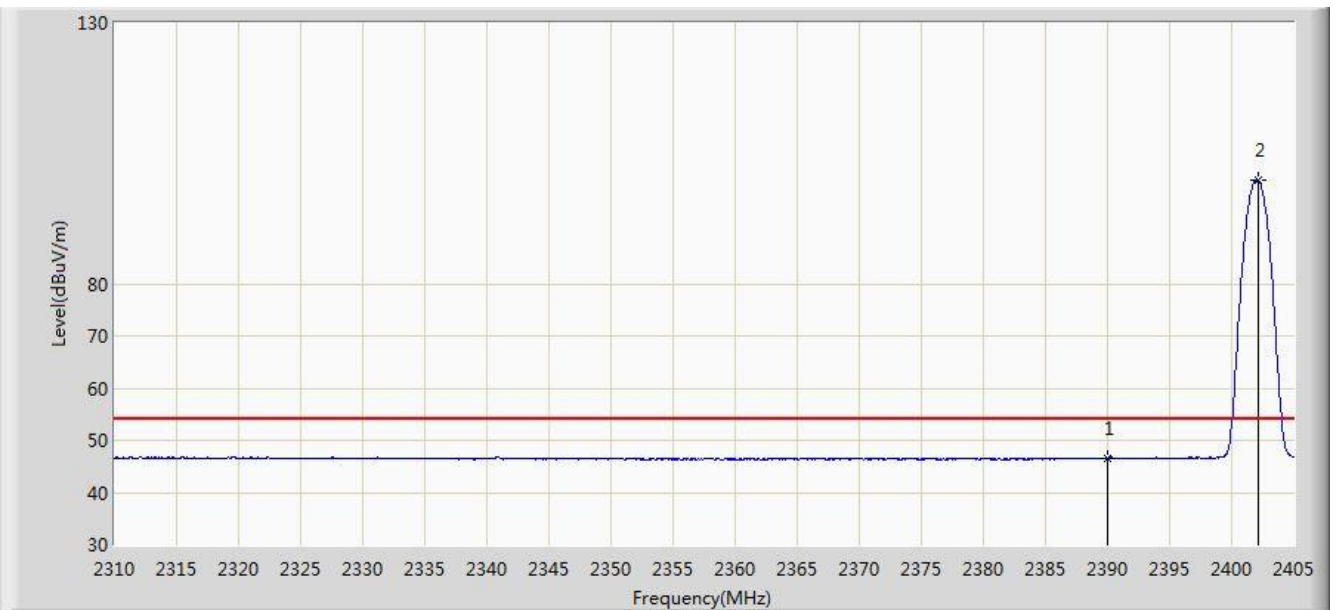

No	Flag	Mark	Frequency (MHz)	Measure Level (dBuV/m)	Reading Level (dBuV)	Over Limit (dB)	Limit (dBuV/m)	Factor (dB)	Type
1			2390.000	46.569	13.994	-7.431	54.000	32.575	AV
2		*	2402.150	99.865	67.306	N/A	N/A	32.559	AV

Note: Measure Level (dB $\mu$ V/m) = Reading Level (dB $\mu$ V) + Factor (dB)

Factor (dB) = Cable Loss (dB) + Antenna Factor (dB/m)



Site: AC1	Time: 2018/03/08 - 00:46
Limit: FCC_Part15.209_RE(3m)	Engineer: Dandy Li
Probe: BBHA9120D_1-18GHz	Polarity: Vertical
EUT: Communication Module	Power: DC 3.3V
Test Mode: Transmit by DH5 at channel 2402MHz	

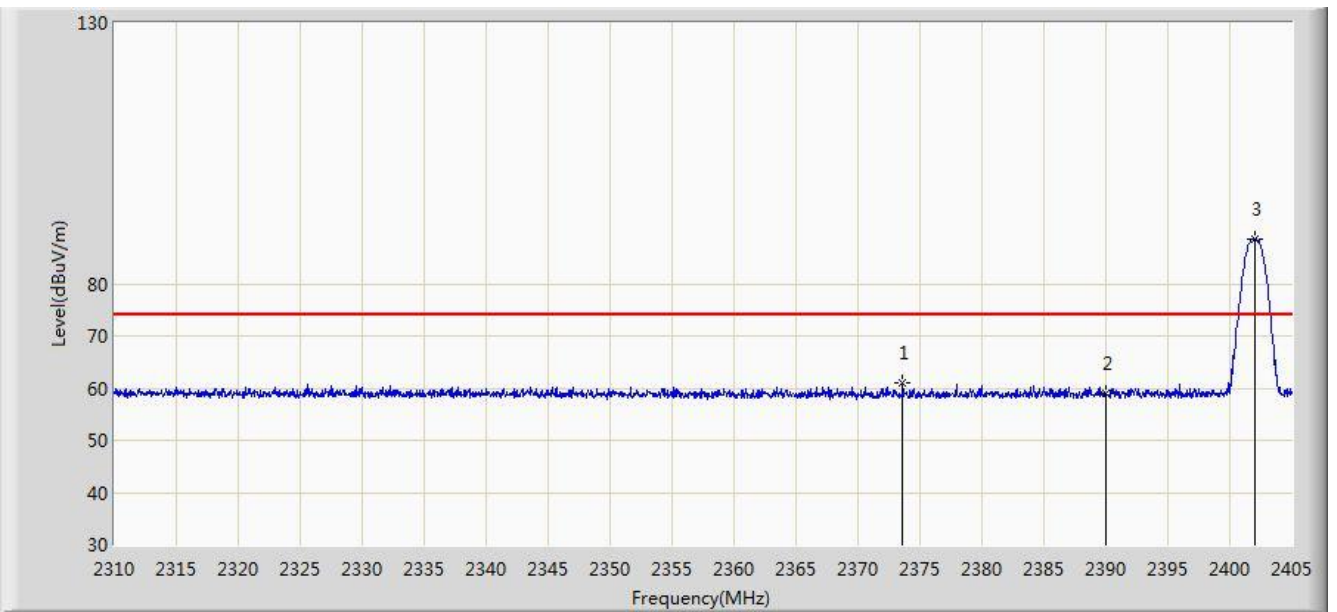

No	Flag	Mark	Frequency (MHz)	Measure Level (dBuV/m)	Reading Level (dBuV)	Over Limit (dB)	Limit (dBuV/m)	Factor (dB)	Type
1			2373.603	60.906	28.303	-13.094	74.000	32.602	PK
2			2390.000	58.930	26.355	-15.070	74.000	32.575	PK
3		*	2402.008	88.475	55.916	N/A	N/A	32.559	PK

Note: Measure Level (dB $\mu$ V/m) = Reading Level (dB $\mu$ V) + Factor (dB)

Factor (dB) = Cable Loss (dB) + Antenna Factor (dB/m)

Site: AC1	Time: 2018/03/08 - 00:48
Limit: FCC_Part15.209_RE(3m)	Engineer: Dandy Li
Probe: BBHA9120D_1-18GHz	Polarity: Vertical
EUT: Communication Module	Power: DC 3.3V
Test Mode: Transmit by DH5 at channel 2402MHz	

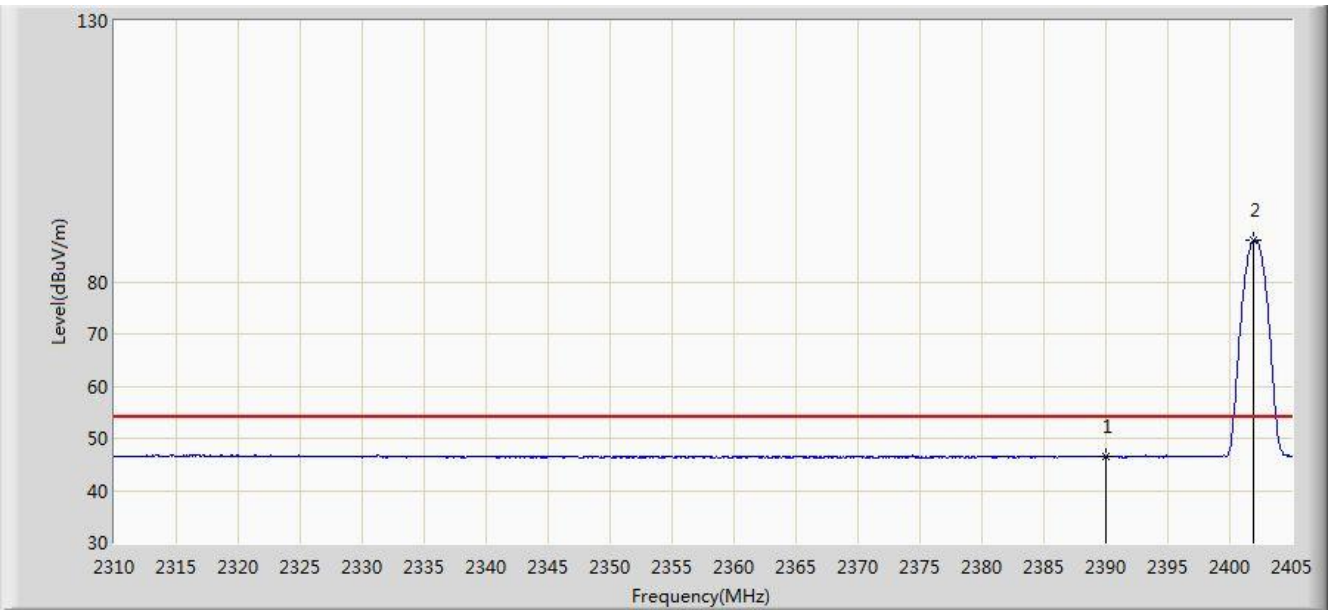

No	Flag	Mark	Frequency (MHz)	Measure Level (dBuV/m)	Reading Level (dBuV)	Over Limit (dB)	Limit (dBuV/m)	Factor (dB)	Type
1			2390.000	46.383	13.808	-7.617	54.000	32.575	AV
2		*	2401.960	87.967	55.408	N/A	N/A	32.559	AV

Note: Measure Level (dB $\mu$ V/m) = Reading Level (dB $\mu$ V) + Factor (dB)

Factor (dB) = Cable Loss (dB) + Antenna Factor (dB/m)

Site: AC1	Time: 2018/03/08 - 00:48
Limit: FCC_Part15.209_RE(3m)	Engineer: Dandy Li
Probe: BBHA9120D_1-18GHz	Polarity: Horizontal
EUT: Communication Module	Power: DC 3.3V
Test Mode: Transmit by DH5 at channel 2480MHz	

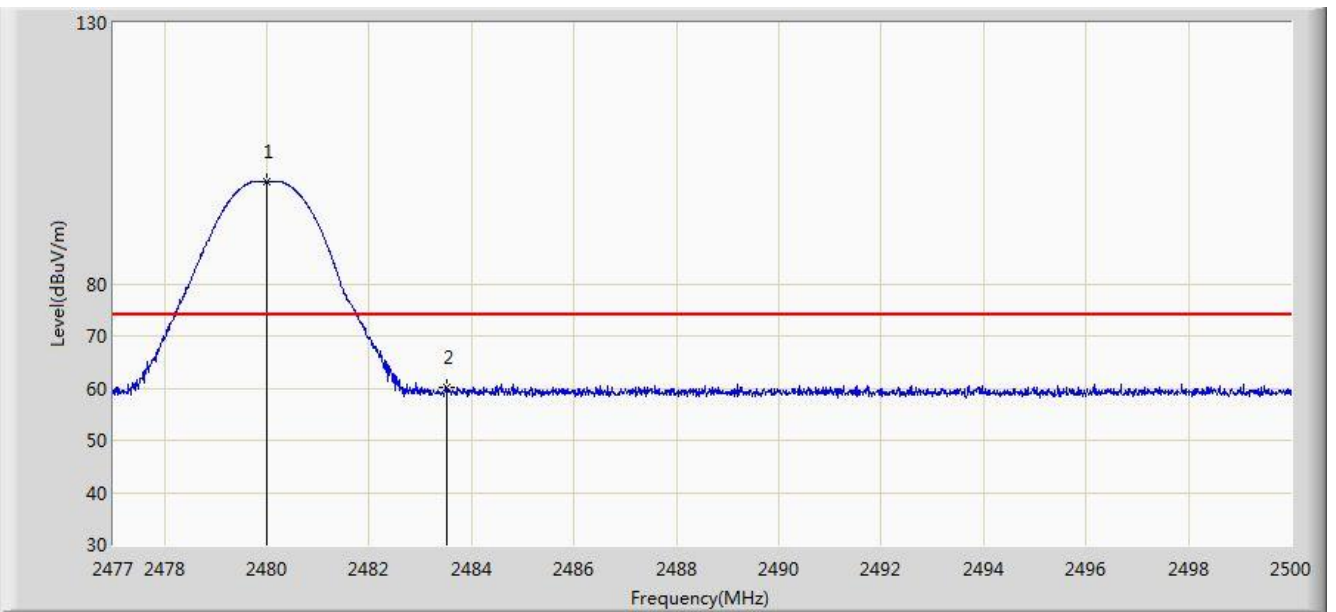

No	Flag	Mark	Frequency (MHz)	Measure Level (dBuV/m)	Reading Level (dBuV)	Over Limit (dB)	Limit (dBuV/m)	Factor (dB)	Type
1		*	2479.990	99.601	67.014	N/A	N/A	32.587	PK
2			2483.500	60.190	27.594	-13.810	74.000	32.596	PK

Note: Measure Level (dBμV/m) = Reading Level (dBμV) + Factor (dB)

Factor (dB) = Cable Loss (dB) + Antenna Factor (dB/m)

Site: AC1	Time: 2018/03/08 - 00:51
Limit: FCC_Part15.209_RE(3m)	Engineer: Dandy Li
Probe: BBHA9120D_1-18GHz	Polarity: Horizontal
EUT: Communication Module	Power: DC 3.3V
Test Mode: Transmit by DH5 at channel 2480MHz	

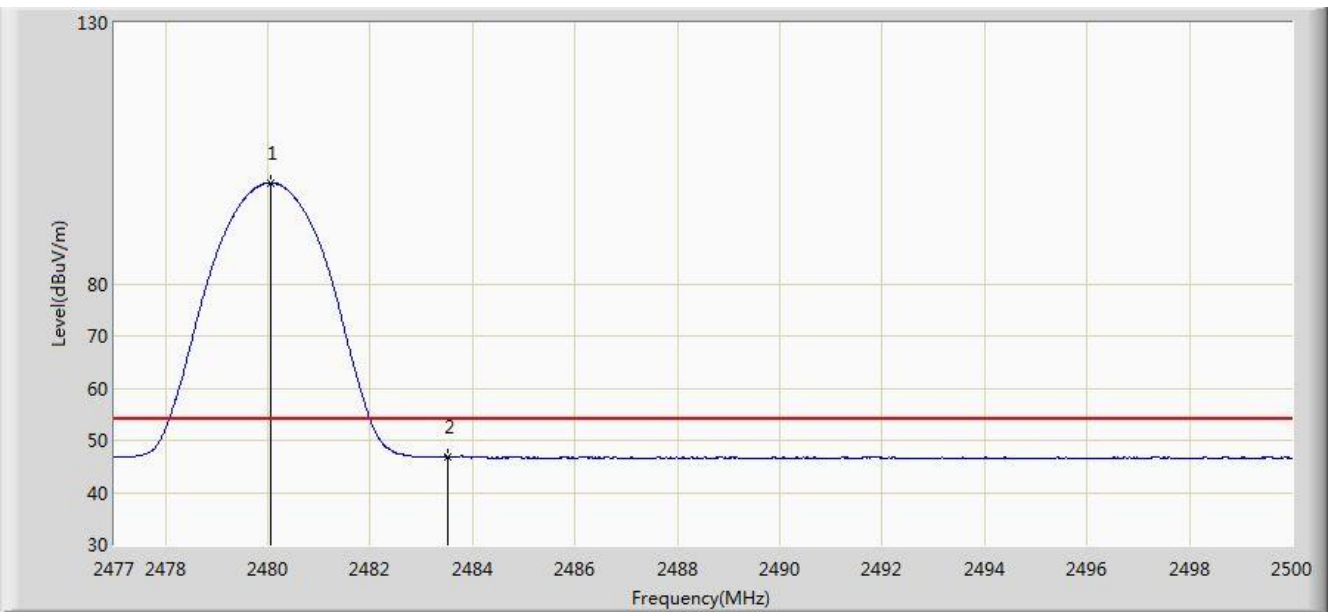

No	Flag	Mark	Frequency (MHz)	Measure Level (dBuV/m)	Reading Level (dBuV)	Over Limit (dB)	Limit (dBuV/m)	Factor (dB)	Type
1		*	2480.059	99.312	66.725	N/A	N/A	32.587	AV
2			2483.500	46.825	14.229	-7.175	54.000	32.596	AV

Note: Measure Level (dB $\mu$ V/m) = Reading Level (dB $\mu$ V) + Factor (dB)

Factor (dB) = Cable Loss (dB) + Antenna Factor (dB/m)

Site: AC1	Time: 2018/03/08 - 00:51
Limit: FCC_Part15.209_RE(3m)	Engineer: Dandy Li
Probe: BBHA9120D_1-18GHz	Polarity: Vertical
EUT: Communication Module	Power: DC 3.3V
Test Mode: Transmit by DH5 at channel 2480MHz	

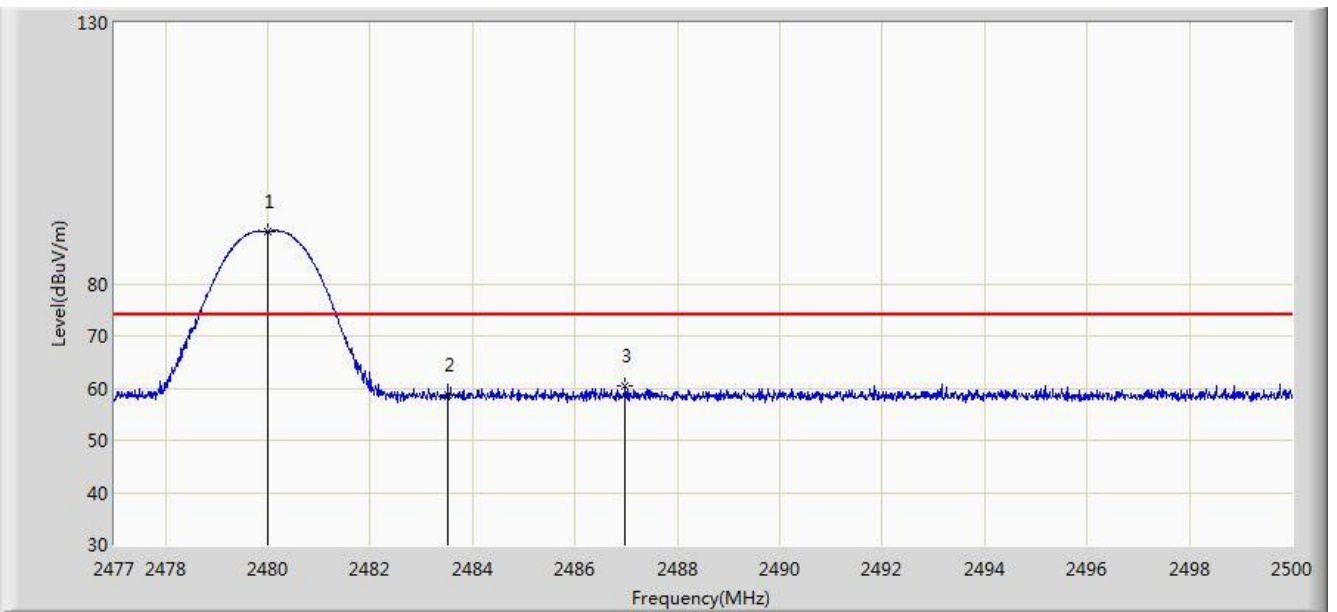

No	Flag	Mark	Frequency (MHz)	Measure Level (dBuV/m)	Reading Level (dBuV)	Over Limit (dB)	Limit (dBuV/m)	Factor (dB)	Type
1		*	2480.001	90.121	57.534	N/A	N/A	32.587	PK
2			2483.500	58.571	25.975	-15.429	74.000	32.596	PK
3			2486.982	60.439	27.834	-13.561	74.000	32.605	PK

Note: Measure Level (dB $\mu$ V/m) = Reading Level (dB $\mu$ V) + Factor (dB)

Factor (dB) = Cable Loss (dB) + Antenna Factor (dB/m)

Site: AC1	Time: 2018/03/08 - 00:54
Limit: FCC_Part15.209_RE(3m)	Engineer: Dandy Li
Probe: BBHA9120D_1-18GHz	Polarity: Vertical
EUT: Communication Module	Power: DC 3.3V
Test Mode: Transmit by DH5 at channel 2480MHz	

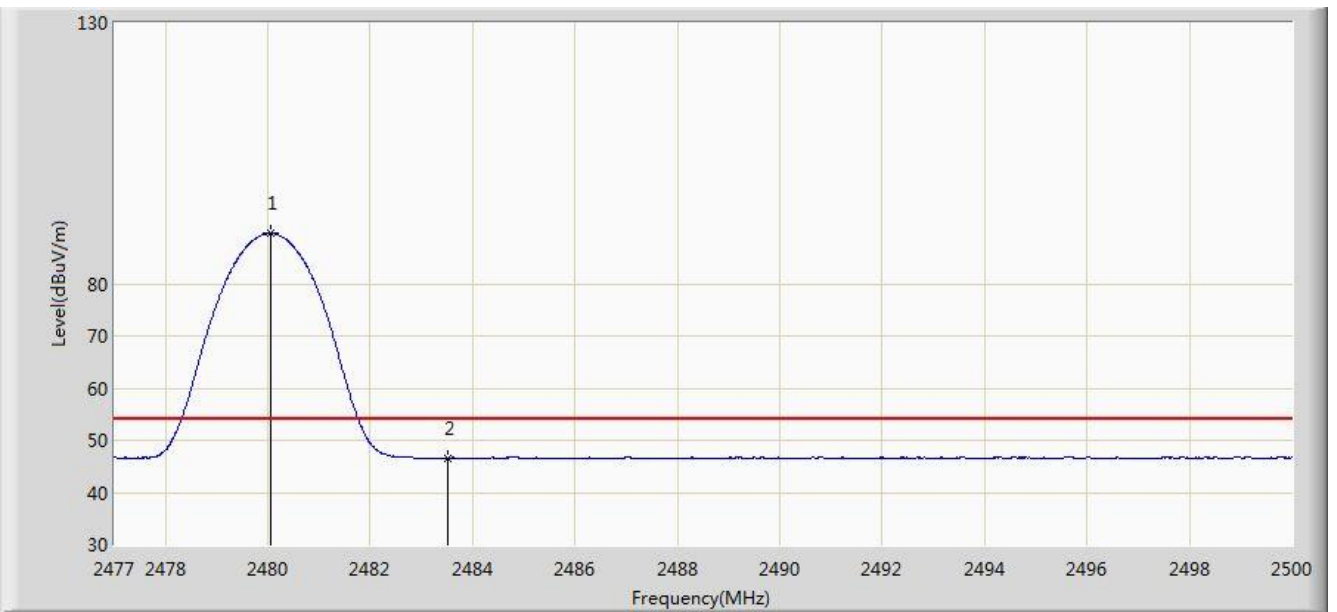

No	Flag	Mark	Frequency (MHz)	Measure Level (dBuV/m)	Reading Level (dBuV)	Over Limit (dB)	Limit (dBuV/m)	Factor (dB)	Type
1		*	2480.059	89.614	57.027	N/A	N/A	32.587	AV
2			2483.500	46.594	13.998	-7.406	54.000	32.596	AV

Note: Measure Level (dB $\mu$ V/m) = Reading Level (dB $\mu$ V) + Factor (dB)

Factor (dB) = Cable Loss (dB) + Antenna Factor (dB/m)

Site: AC1	Time: 2018/03/08 - 00:54
Limit: FCC_Part15.209_RE(3m)	Engineer: Dandy Li
Probe: BBHA9120D_1-18GHz	Polarity: Horizontal
EUT: Communication Module	Power: DC 3.3V
Test Mode: Transmit by 2DH5 at channel 2402MHz	

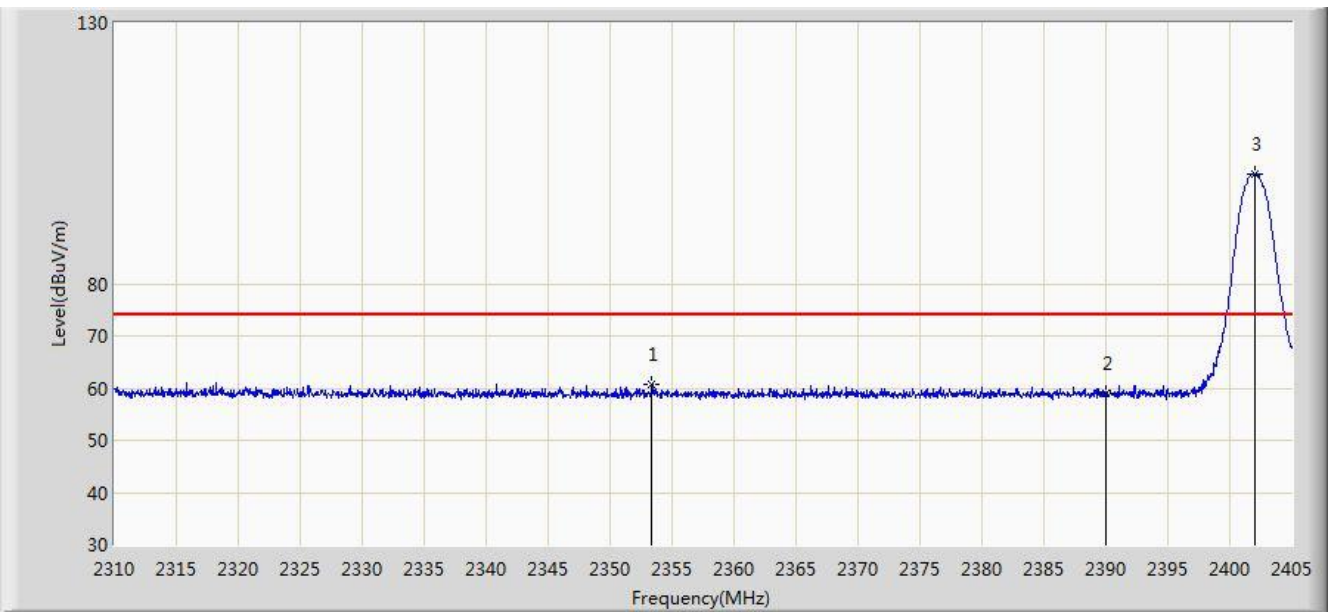

No	Flag	Mark	Frequency (MHz)	Measure Level (dBuV/m)	Reading Level (dBuV)	Over Limit (dB)	Limit (dBuV/m)	Factor (dB)	Type
1			2353.367	60.818	28.178	-13.182	74.000	32.640	PK
2			2390.000	58.856	26.281	-15.144	74.000	32.575	PK
3		*	2402.055	101.144	68.585	N/A	N/A	32.558	PK

Note: Measure Level (dB $\mu$ V/m) = Reading Level (dB $\mu$ V) + Factor (dB)

Factor (dB) = Cable Loss (dB) + Antenna Factor (dB/m)

Site: AC1	Time: 2018/03/08 - 00:57
Limit: FCC_Part15.209_RE(3m)	Engineer: Dandy Li
Probe: BBHA9120D_1-18GHz	Polarity: Horizontal
EUT: Communication Module	Power: DC 3.3V
Test Mode: Transmit by 2DH5 at channel 2402MHz	

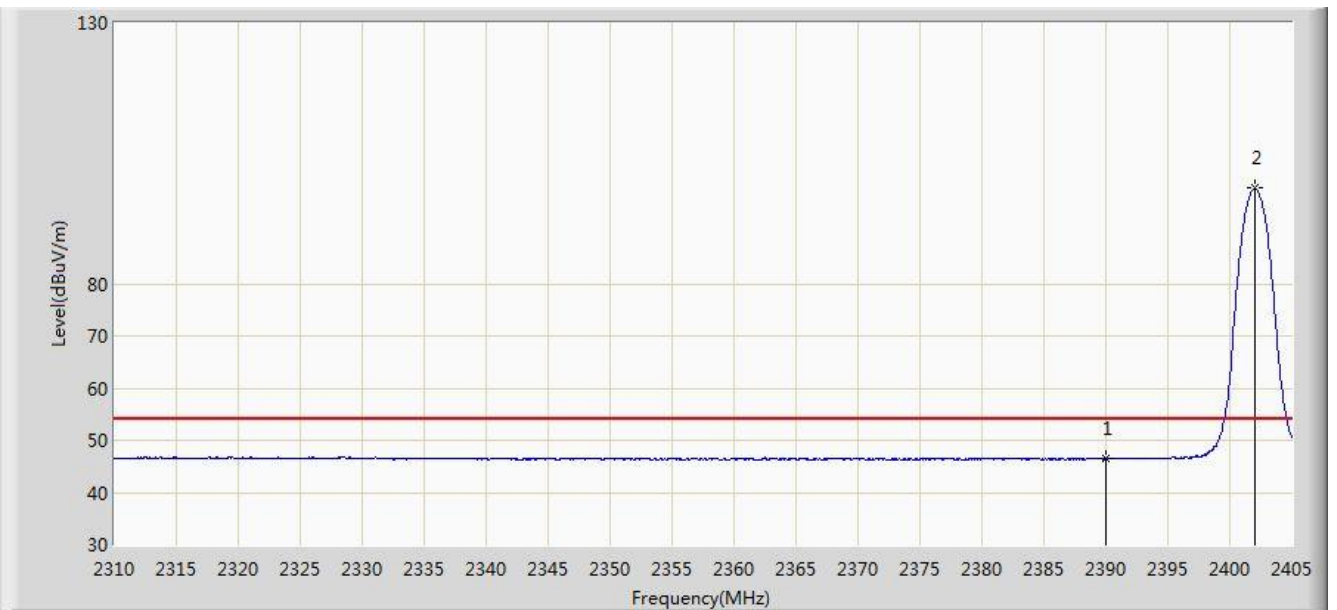

No	Flag	Mark	Frequency (MHz)	Measure Level (dBuV/m)	Reading Level (dBuV)	Over Limit (dB)	Limit (dBuV/m)	Factor (dB)	Type
1			2390.000	46.509	13.934	-7.491	54.000	32.575	AV
2		*	2402.008	98.306	65.747	N/A	N/A	32.559	AV

Note: Measure Level (dB $\mu$ V/m) = Reading Level (dB $\mu$ V) + Factor (dB)

Factor (dB) = Cable Loss (dB) + Antenna Factor (dB/m)



Site: AC1	Time: 2018/03/08 - 00:58
Limit: FCC_Part15.209_RE(3m)	Engineer: Dandy Li
Probe: BBHA9120D_1-18GHz	Polarity: Vertical
EUT: Communication Module	Power: DC 3.3V
Test Mode: Transmit by 2DH5 at channel 2402MHz	

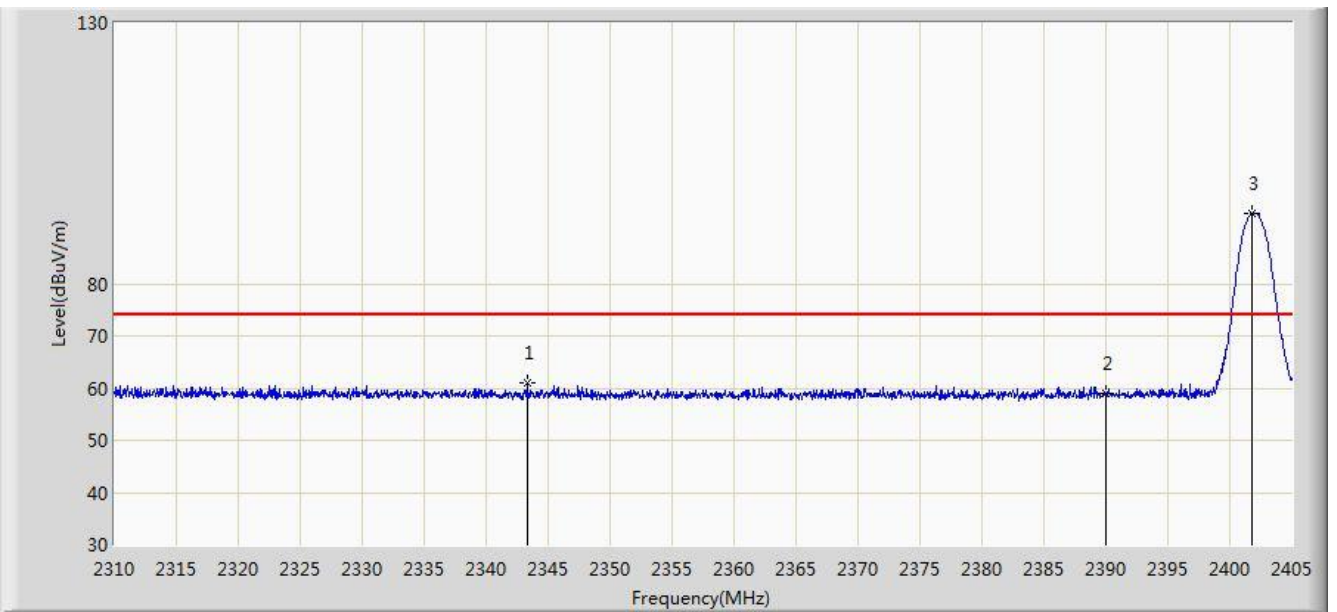

No	Flag	Mark	Frequency (MHz)	Measure Level (dBuV/m)	Reading Level (dBuV)	Over Limit (dB)	Limit (dBuV/m)	Factor (dB)	Type
1			2343.298	60.946	28.275	-13.054	74.000	32.671	PK
2			2390.000	58.920	26.345	-15.080	74.000	32.575	PK
3		*	2401.770	93.528	60.969	N/A	N/A	32.559	PK

Note: Measure Level (dB $\mu$ V/m) = Reading Level (dB $\mu$ V) + Factor (dB)

Factor (dB) = Cable Loss (dB) + Antenna Factor (dB/m)

Site: AC1	Time: 2018/03/08 - 00:59
Limit: FCC_Part15.209_RE(3m)	Engineer: Dandy Li
Probe: BBHA9120D_1-18GHz	Polarity: Vertical
EUT: Communication Module	Power: DC 3.3V
Test Mode: Transmit by 2DH5 at channel 2402MHz	

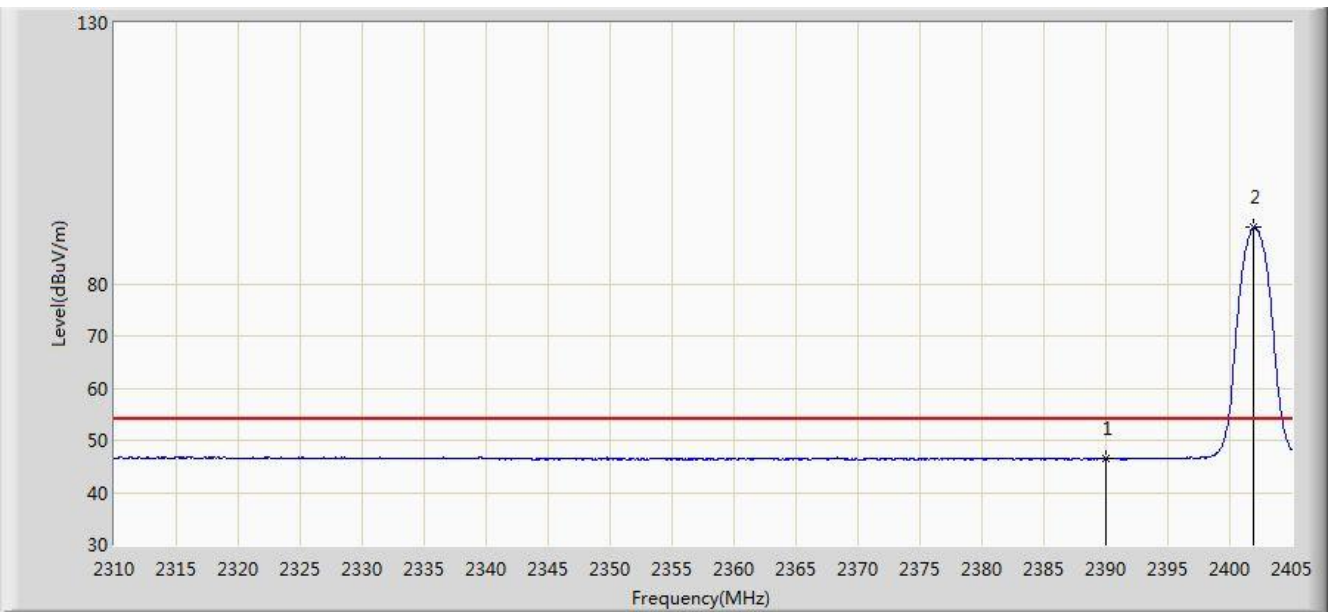

No	Flag	Mark	Frequency (MHz)	Measure Level (dBuV/m)	Reading Level (dBuV)	Over Limit (dB)	Limit (dBuV/m)	Factor (dB)	Type
1			2390.000	46.406	13.831	-7.594	54.000	32.575	AV
2		*	2401.913	90.801	58.242	N/A	N/A	32.559	AV

Note: Measure Level (dB $\mu$ V/m) = Reading Level (dB $\mu$ V) + Factor (dB)

Factor (dB) = Cable Loss (dB) + Antenna Factor (dB/m)

Site: AC1	Time: 2018/03/08 - 00:59
Limit: FCC_Part15.209_RE(3m)	Engineer: Dandy Li
Probe: BBHA9120D_1-18GHz	Polarity: Horizontal
EUT: Communication Module	Power: DC 3.3V
Test Mode: Transmit by 2DH5 at channel 2480MHz	

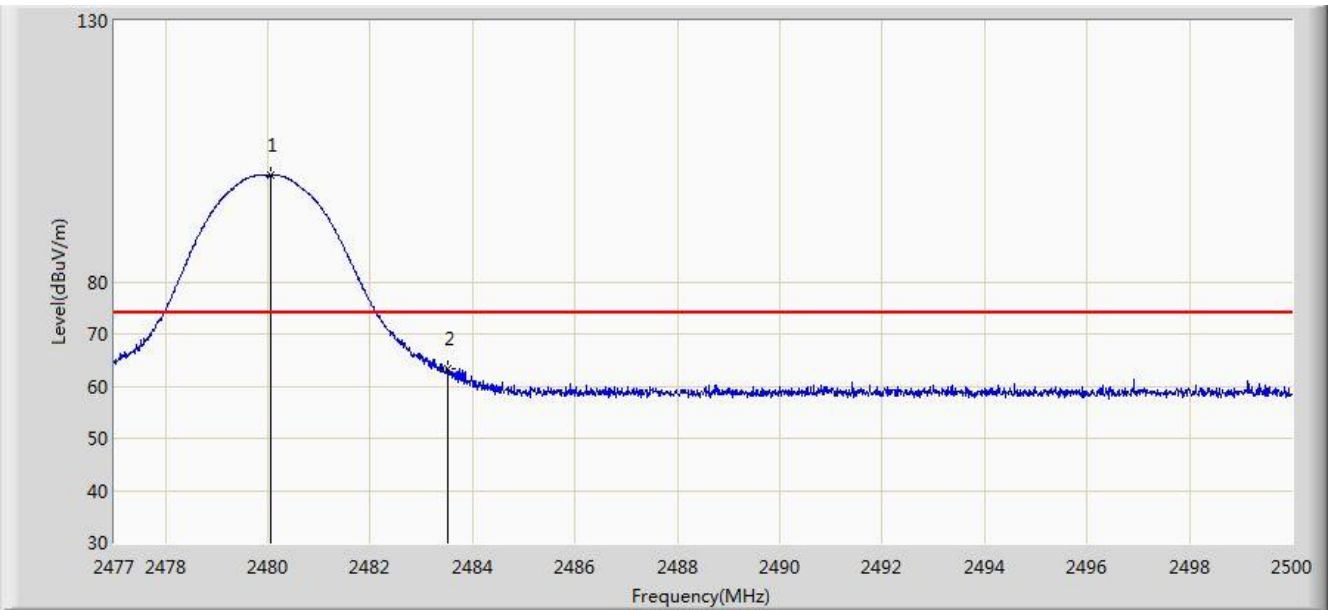

No	Flag	Mark	Frequency (MHz)	Measure Level (dBuV/m)	Reading Level (dBuV)	Over Limit (dB)	Limit (dBuV/m)	Factor (dB)	Type
1		*	2480.059	100.398	67.811	N/A	N/A	32.587	PK
2			2483.500	63.252	30.656	-10.748	74.000	32.596	PK

Note: Measure Level (dB $\mu$ V/m) = Reading Level (dB $\mu$ V) + Factor (dB)

Factor (dB) = Cable Loss (dB) + Antenna Factor (dB/m)

Site: AC1	Time: 2018/03/08 - 01:00
Limit: FCC_Part15.209_RE(3m)	Engineer: Dandy Li
Probe: BBHA9120D_1-18GHz	Polarity: Horizontal
EUT: Communication Module	Power: DC 3.3V
Test Mode: Transmit by 2DH5 at channel 2480MHz	

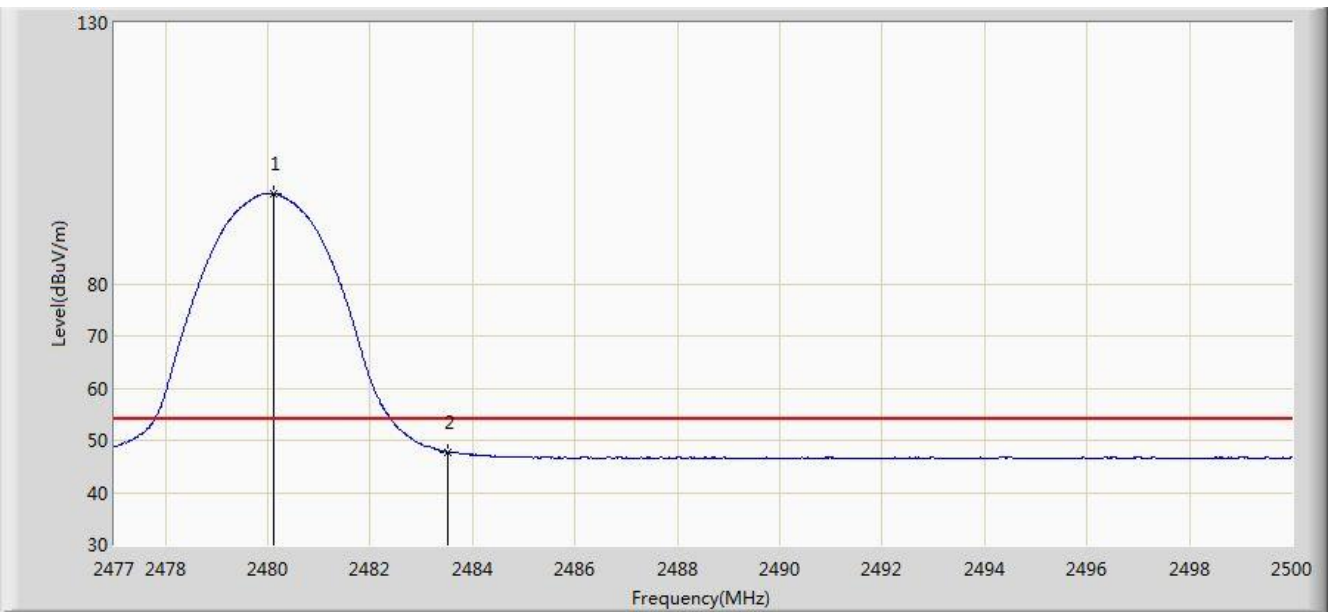

No	Flag	Mark	Frequency (MHz)	Measure Level (dBuV/m)	Reading Level (dBuV)	Over Limit (dB)	Limit (dBuV/m)	Factor (dB)	Type
1		*	2480.105	97.280	64.693	N/A	N/A	32.587	AV
2			2483.500	47.797	15.201	-6.203	54.000	32.596	AV

Note: Measure Level (dB $\mu$ V/m) = Reading Level (dB $\mu$ V) + Factor (dB)

Factor (dB) = Cable Loss (dB) + Antenna Factor (dB/m)

Site: AC1	Time: 2018/03/08 - 01:01
Limit: FCC_Part15.209_RE(3m)	Engineer: Dandy Li
Probe: BBHA9120D_1-18GHz	Polarity: Vertical
EUT: Communication Module	Power: DC 3.3V
Test Mode: Transmit by 2DH5 at channel 2480MHz	

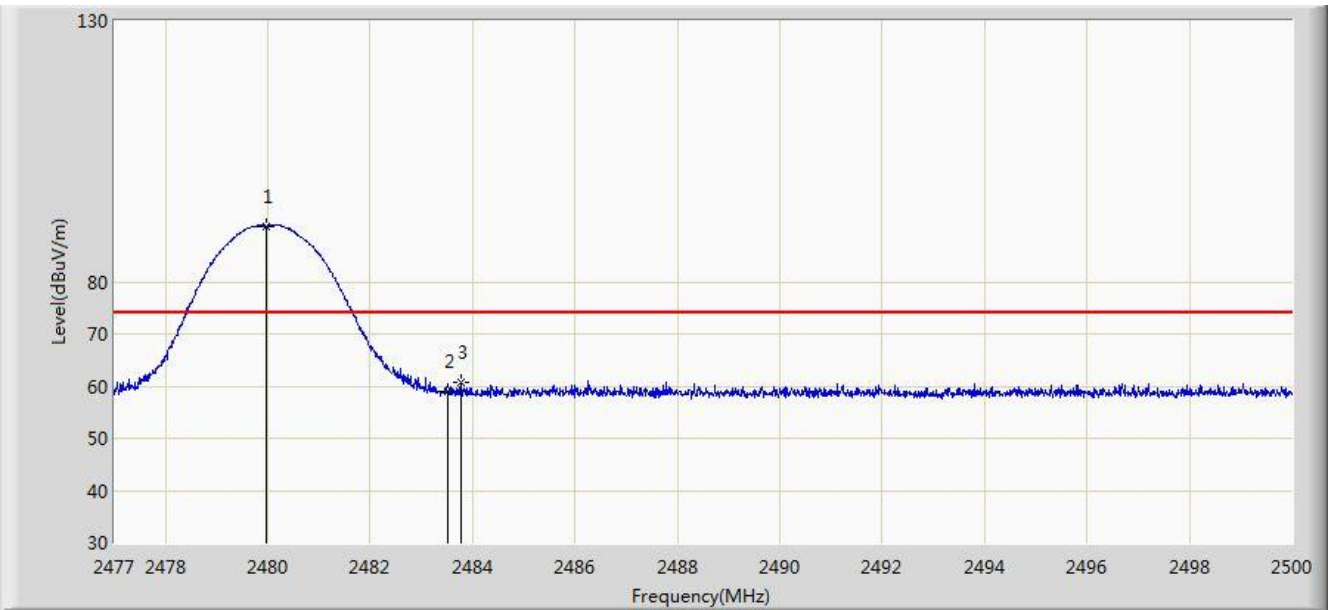

No	Flag	Mark	Frequency (MHz)	Measure Level (dBuV/m)	Reading Level (dBuV)	Over Limit (dB)	Limit (dBuV/m)	Factor (dB)	Type
1		*	2479.956	90.717	58.130	N/A	N/A	32.587	PK
2			2483.500	58.951	26.355	-15.049	74.000	32.596	PK
3			2483.785	60.766	28.169	-13.234	74.000	32.596	PK

Note: Measure Level (dB $\mu$ V/m) = Reading Level (dB $\mu$ V) + Factor (dB)

Factor (dB) = Cable Loss (dB) + Antenna Factor (dB/m)

Site: AC1	Time: 2018/03/08 - 01:02
Limit: FCC_Part15.209_RE(3m)	Engineer: Dandy Li
Probe: BBHA9120D_1-18GHz	Polarity: Vertical
EUT: Communication Module	Power: DC 3.3V
Test Mode: Transmit by 2DH5 at channel 2480MHz	

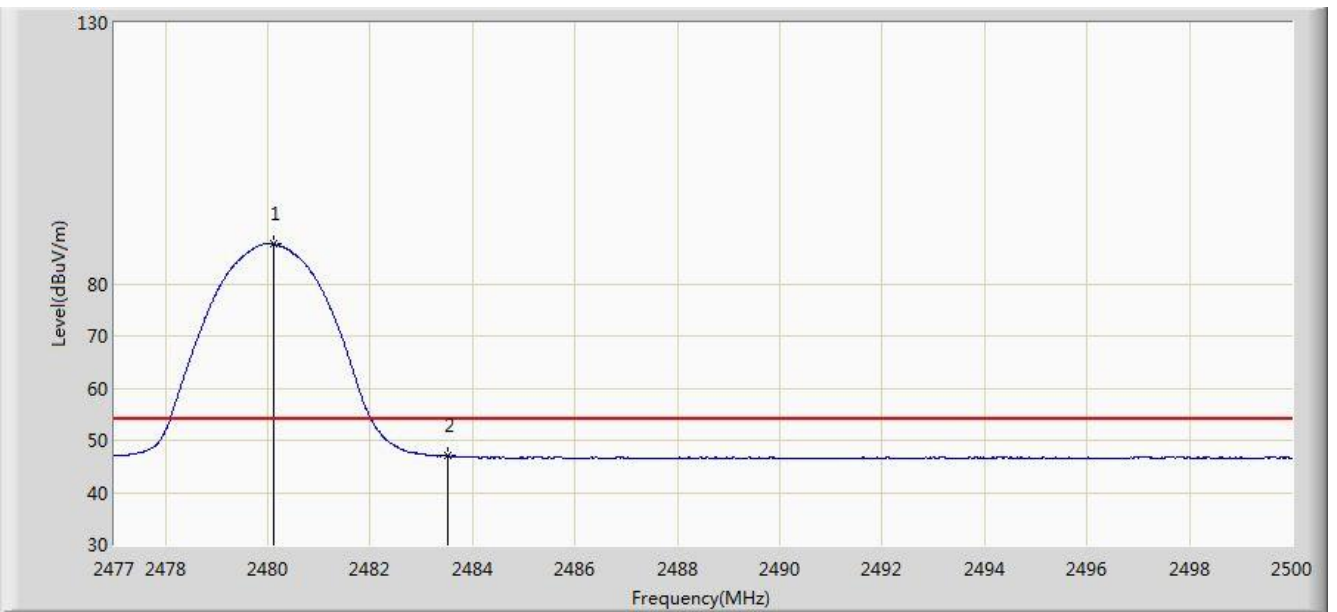

No	Flag	Mark	Frequency (MHz)	Measure Level (dBuV/m)	Reading Level (dBuV)	Over Limit (dB)	Limit (dBuV/m)	Factor (dB)	Type
1		*	2480.105	87.655	55.068	N/A	N/A	32.587	AV
2			2483.500	46.976	14.380	-7.024	54.000	32.596	AV

Note: Measure Level (dB $\mu$ V/m) = Reading Level (dB $\mu$ V) + Factor (dB)

Factor (dB) = Cable Loss (dB) + Antenna Factor (dB/m)

Site: AC1	Time: 2018/03/08 - 01:02
Limit: FCC_Part15.209_RE(3m)	Engineer: Dandy Li
Probe: BBHA9120D_1-18GHz	Polarity: Horizontal
EUT: Communication Module	Power: DC 3.3V
Test Mode: Transmit by 3DH5 at channel 2402MHz	

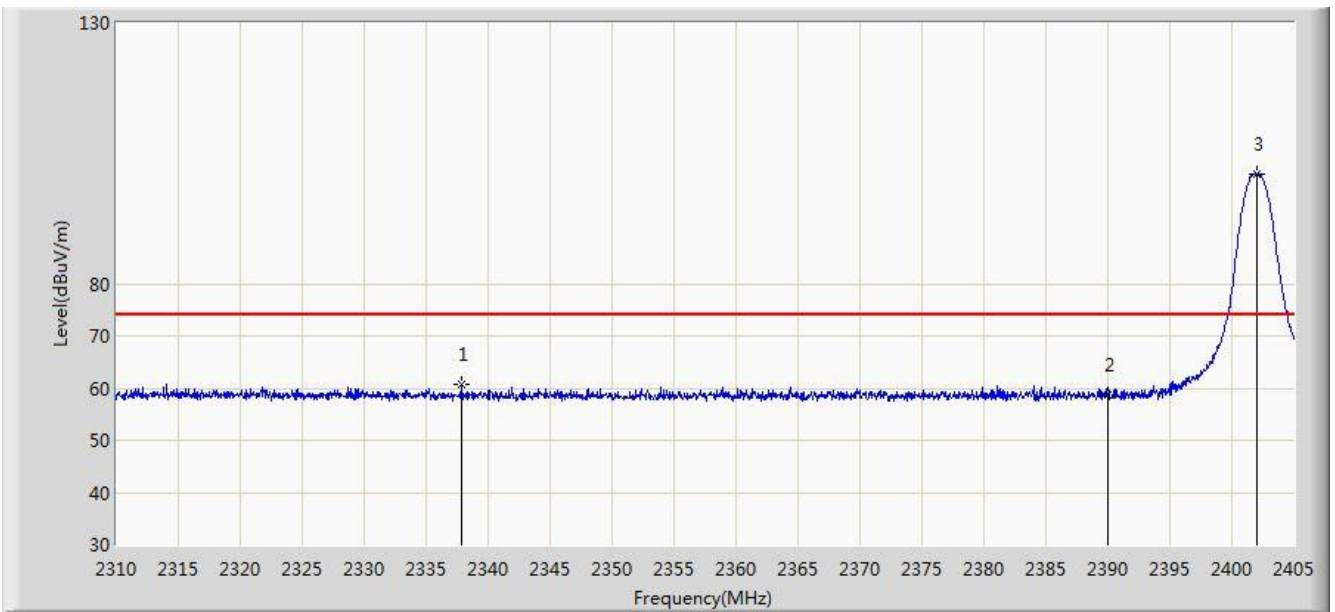

No	Flag	Mark	Frequency (MHz)	Measure Level (dBuV/m)	Reading Level (dBuV)	Over Limit (dB)	Limit (dBuV/m)	Factor (dB)	Type
1			2337.835	60.649	27.956	-13.351	74.000	32.693	PK
2			2390.000	58.789	26.214	-15.211	74.000	32.575	PK
3		*	2402.008	101.079	68.520	N/A	N/A	32.559	PK

Note: Measure Level (dBμV/m) = Reading Level (dBμV) + Factor (dB)

Factor (dB) = Cable Loss (dB) + Antenna Factor (dB/m)

Site: AC1	Time: 2018/03/08 - 01:03
Limit: FCC_Part15.209_RE(3m)	Engineer: Dandy Li
Probe: BBHA9120D_1-18GHz	Polarity: Horizontal
EUT: Communication Module	Power: DC 3.3V
Test Mode: Transmit by 3DH5 at channel 2402MHz	

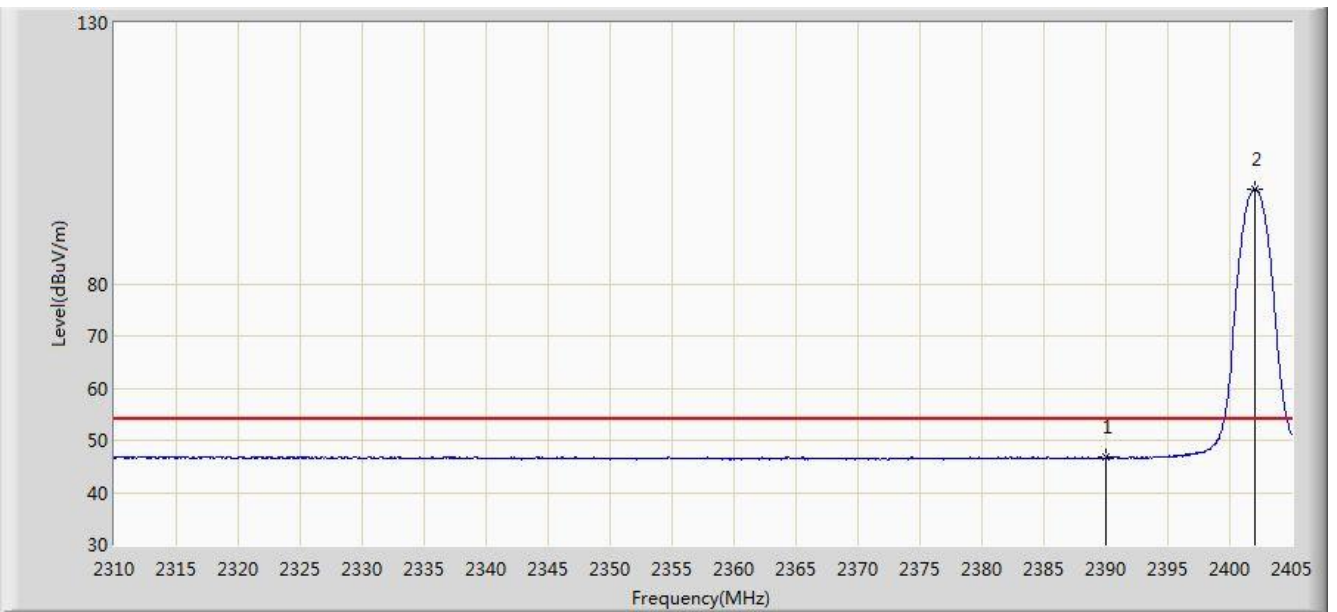

No	Flag	Mark	Frequency (MHz)	Measure Level (dBuV/m)	Reading Level (dBuV)	Over Limit (dB)	Limit (dBuV/m)	Factor (dB)	Type
1			2390.000	46.672	14.097	-7.328	54.000	32.575	AV
2		*	2402.008	98.172	65.613	N/A	N/A	32.559	AV

Note: Measure Level (dB $\mu$ V/m) = Reading Level (dB $\mu$ V) + Factor (dB)

Factor (dB) = Cable Loss (dB) + Antenna Factor (dB/m)



Site: AC1	Time: 2018/03/08 - 01:04
Limit: FCC_Part15.209_RE(3m)	Engineer: Dandy Li
Probe: BBHA9120D_1-18GHz	Polarity: Vertical
EUT: Communication Module	Power: DC 3.3V
Test Mode: Transmit by 3DH5 at channel 2402MHz	

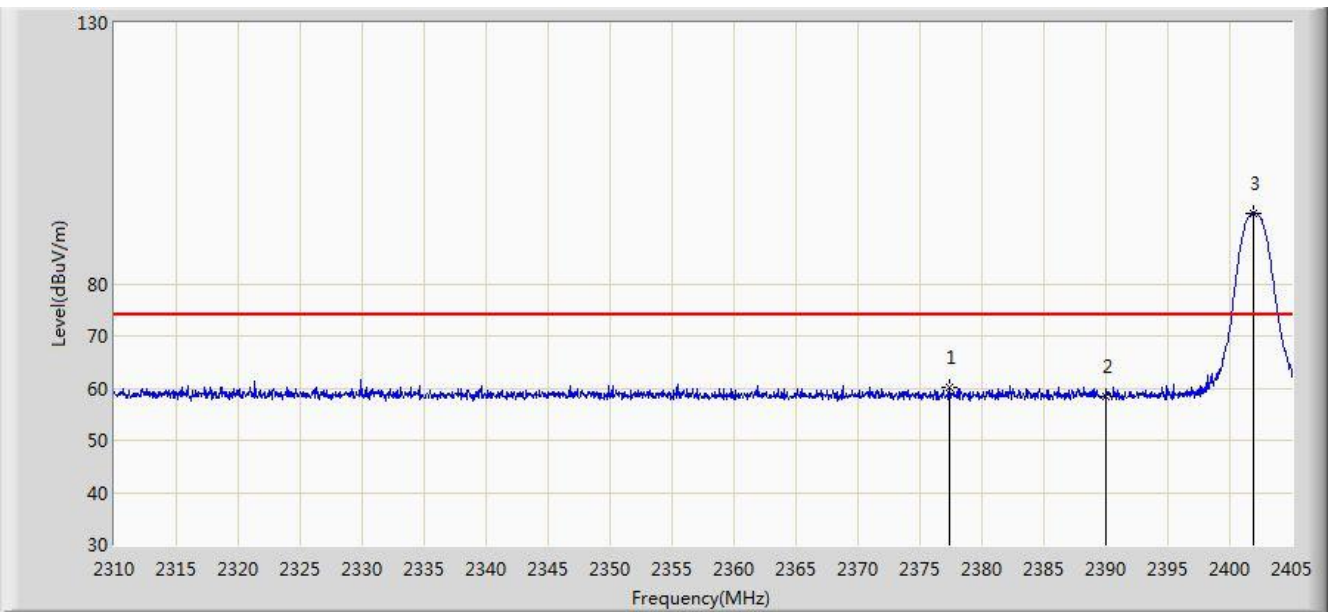

No	Flag	Mark	Frequency (MHz)	Measure Level (dBuV/m)	Reading Level (dBuV)	Over Limit (dB)	Limit (dBuV/m)	Factor (dB)	Type
1			2377.403	60.031	27.434	-13.969	74.000	32.597	PK
2			2390.000	58.518	25.943	-15.482	74.000	32.575	PK
3		*	2401.865	93.518	60.959	N/A	N/A	32.559	PK

Note: Measure Level (dB $\mu$ V/m) = Reading Level (dB $\mu$ V) + Factor (dB)

Factor (dB) = Cable Loss (dB) + Antenna Factor (dB/m)

Site: AC1	Time: 2018/03/08 - 01:05
Limit: FCC_Part15.209_RE(3m)	Engineer: Dandy Li
Probe: BBHA9120D_1-18GHz	Polarity: Vertical
EUT: Communication Module	Power: DC 3.3V
Test Mode: Transmit by 3DH5 at channel 2402MHz	

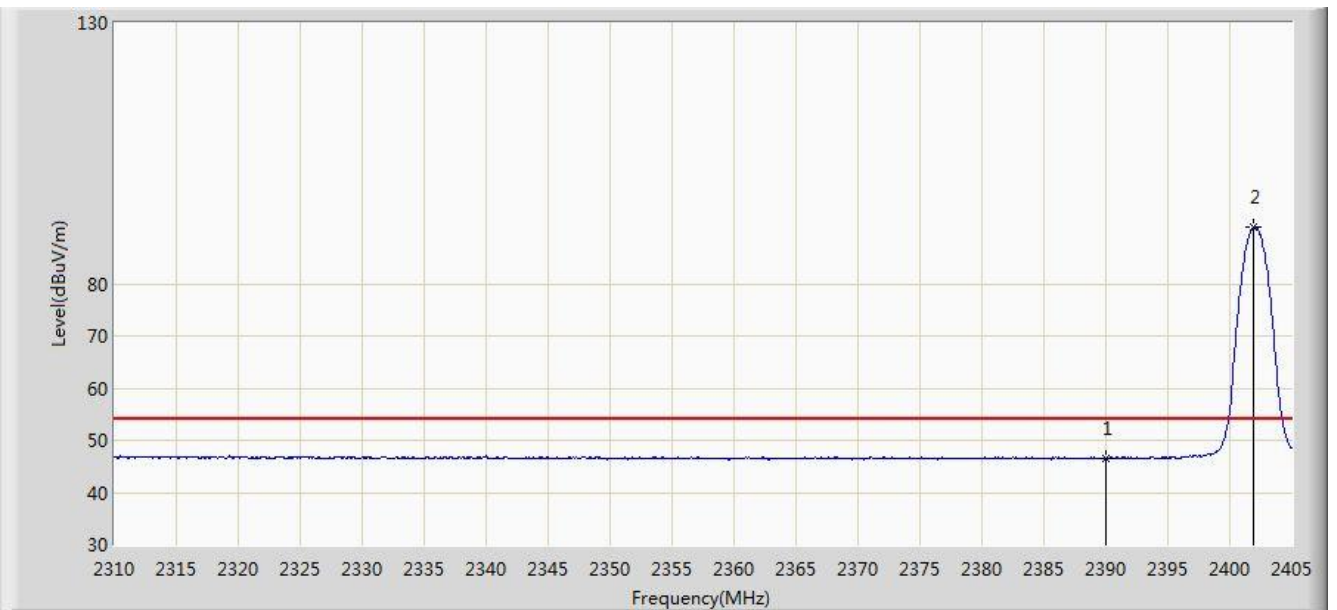

No	Flag	Mark	Frequency (MHz)	Measure Level (dBuV/m)	Reading Level (dBuV)	Over Limit (dB)	Limit (dBuV/m)	Factor (dB)	Type
1			2390.000	46.548	13.973	-7.452	54.000	32.575	AV
2		*	2401.960	90.775	58.216	N/A	N/A	32.559	AV

Note: Measure Level (dB $\mu$ V/m) = Reading Level (dB $\mu$ V) + Factor (dB)

Factor (dB) = Cable Loss (dB) + Antenna Factor (dB/m)

Site: AC1	Time: 2018/03/08 - 01:05
Limit: FCC_Part15.209_RE(3m)	Engineer: Dandy Li
Probe: BBHA9120D_1-18GHz	Polarity: Horizontal
EUT: Communication Module	Power: DC 3.3V
Test Mode: Transmit by 3DH5 at channel 2480MHz	

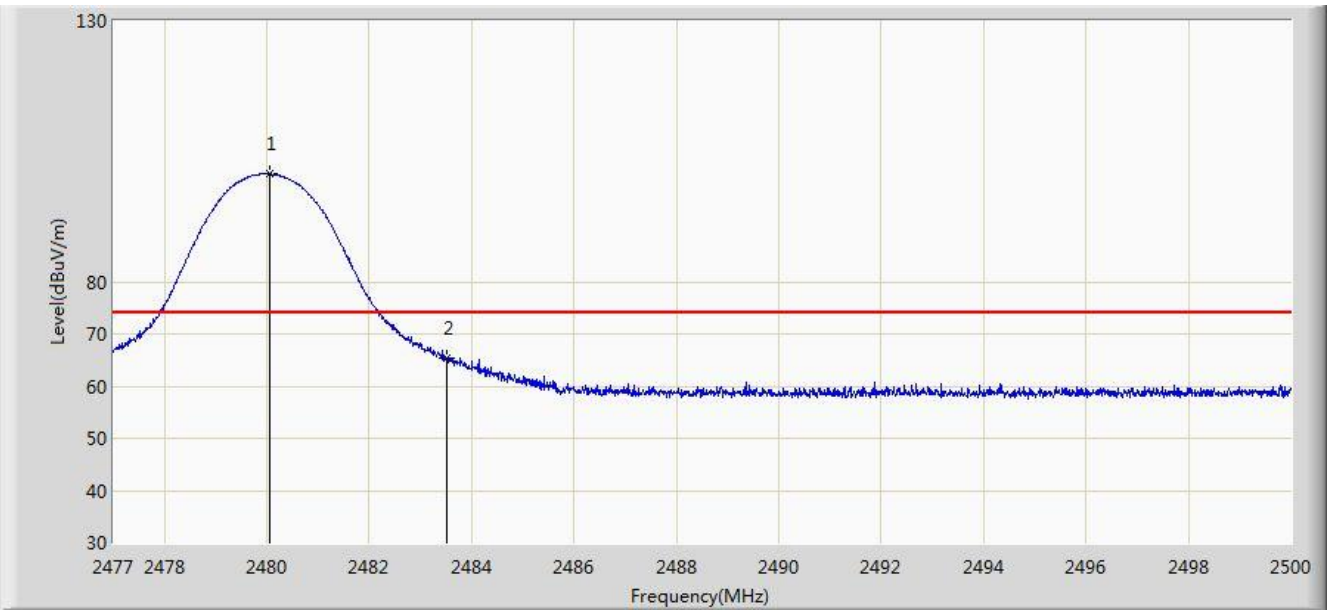

No	Flag	Mark	Frequency (MHz)	Measure Level (dBuV/m)	Reading Level (dBuV)	Over Limit (dB)	Limit (dBuV/m)	Factor (dB)	Type
1		*	2480.059	100.679	68.092	N/A	N/A	32.587	PK
2			2483.500	65.219	32.623	-8.781	74.000	32.596	PK

Note: Measure Level (dBμV/m) = Reading Level (dBμV) + Factor (dB)

Factor (dB) = Cable Loss (dB) + Antenna Factor (dB/m)

Site: AC1	Time: 2018/03/08 - 01:07
Limit: FCC_Part15.209_RE(3m)	Engineer: Dandy Li
Probe: BBHA9120D_1-18GHz	Polarity: Horizontal
EUT: Communication Module	Power: DC 3.3V
Test Mode: Transmit by 3DH5 at channel 2480MHz	

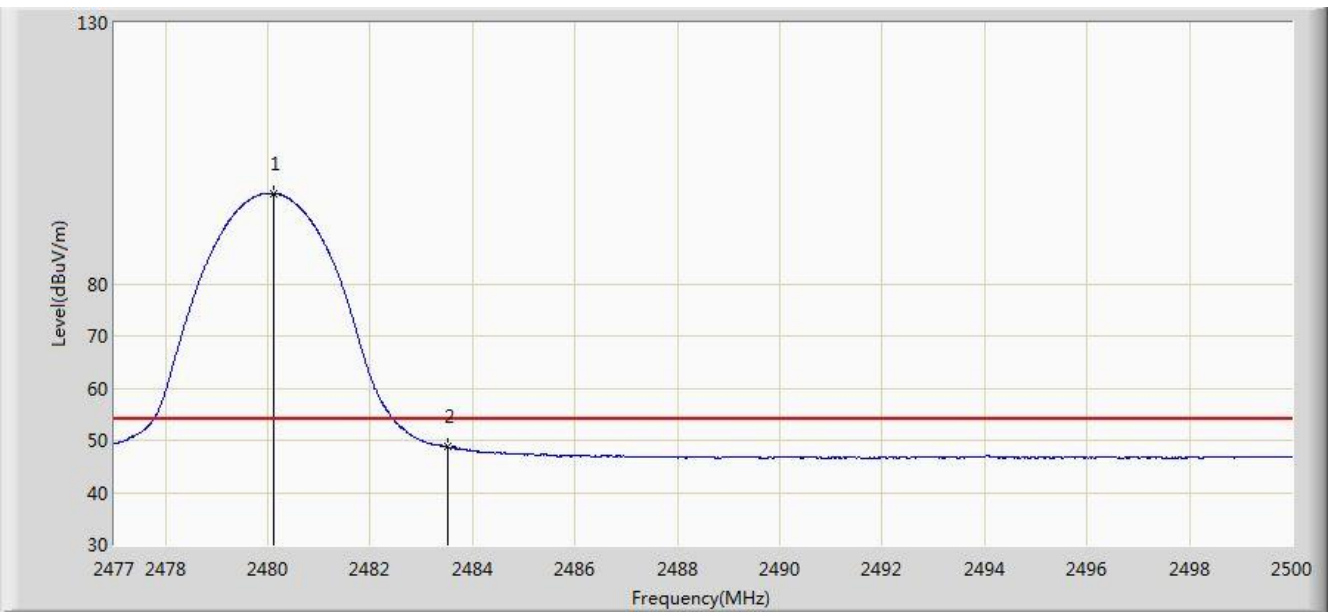

No	Flag	Mark	Frequency (MHz)	Measure Level (dBuV/m)	Reading Level (dBuV)	Over Limit (dB)	Limit (dBuV/m)	Factor (dB)	Type
1		*	2480.105	97.349	64.762	N/A	N/A	32.587	AV
2			2483.500	48.798	16.202	-5.202	54.000	32.596	AV

Note: Measure Level (dB $\mu$ V/m) = Reading Level (dB $\mu$ V) + Factor (dB)

Factor (dB) = Cable Loss (dB) + Antenna Factor (dB/m)

Site: AC1	Time: 2018/03/08 - 01:07
Limit: FCC_Part15.209_RE(3m)	Engineer: Dandy Li
Probe: BBHA9120D_1-18GHz	Polarity: Vertical
EUT: Communication Module	Power: DC 3.3V
Test Mode: Transmit by 3DH5 at channel 2480MHz	

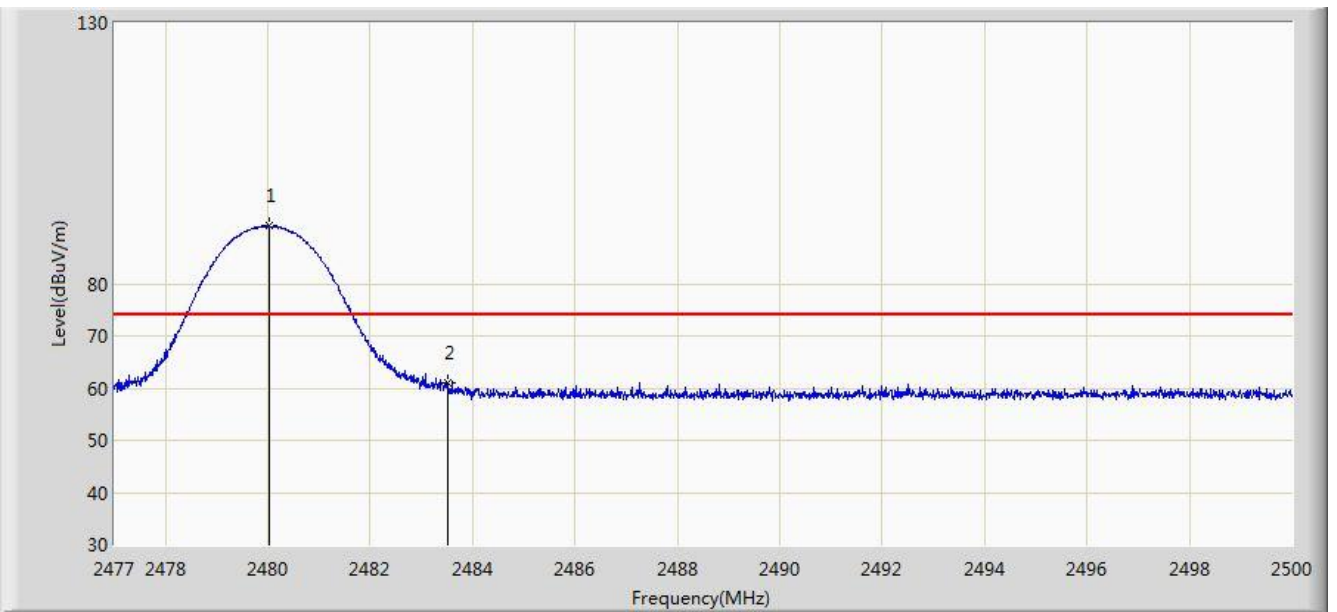

No	Flag	Mark	Frequency (MHz)	Measure Level (dBuV/m)	Reading Level (dBuV)	Over Limit (dB)	Limit (dBuV/m)	Factor (dB)	Type
1		*	2480.024	91.075	58.488	N/A	N/A	32.587	PK
2			2483.500	60.949	28.353	-13.051	74.000	32.596	PK

Note: Measure Level (dB $\mu$ V/m) = Reading Level (dB $\mu$ V) + Factor (dB)

Factor (dB) = Cable Loss (dB) + Antenna Factor (dB/m)

Site: AC1	Time: 2018/03/08 - 01:08
Limit: FCC_Part15.209_RE(3m)	Engineer: Dandy Li
Probe: BBHA9120D_1-18GHz	Polarity: Vertical
EUT: Communication Module	Power: DC 3.3V
Test Mode: Transmit by 3DH5 at channel 2480MHz	

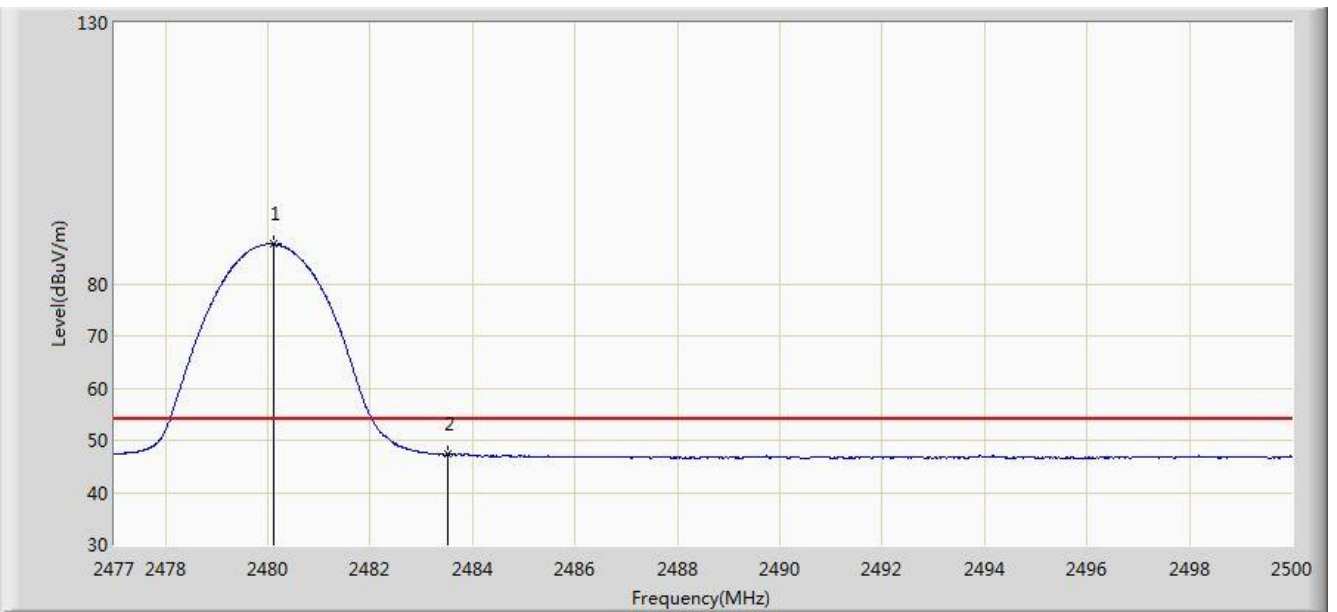

No	Flag	Mark	Frequency (MHz)	Measure Level (dBuV/m)	Reading Level (dBuV)	Over Limit (dB)	Limit (dBuV/m)	Factor (dB)	Type
1		*	2480.105	87.627	55.040	N/A	N/A	32.587	AV
2			2483.500	47.319	14.723	-6.681	54.000	32.596	AV

Note: Measure Level (dB $\mu$ V/m) = Reading Level (dB $\mu$ V) + Factor (dB)

Factor (dB) = Cable Loss (dB) + Antenna Factor (dB/m)

## 7.11. AC Conducted Emissions Measurement

### 7.11.1. Test Limit

FCC Part 15 Subpart C Paragraph 15.207 Limits		
Frequency (MHz)	QP (dB $\mu$ V)	Average (dB $\mu$ V)
0.15 - 0.50	66 - 56	56 - 46
0.50 - 5.0	56	46
5.0 - 30	60	50

Note 1: The lower limit shall apply at the transition frequencies.

Note 2: The limit decreases linearly with the logarithm of the frequency in the range 0.15MHz to 0.5MHz.

### 7.11.2. Test Setup

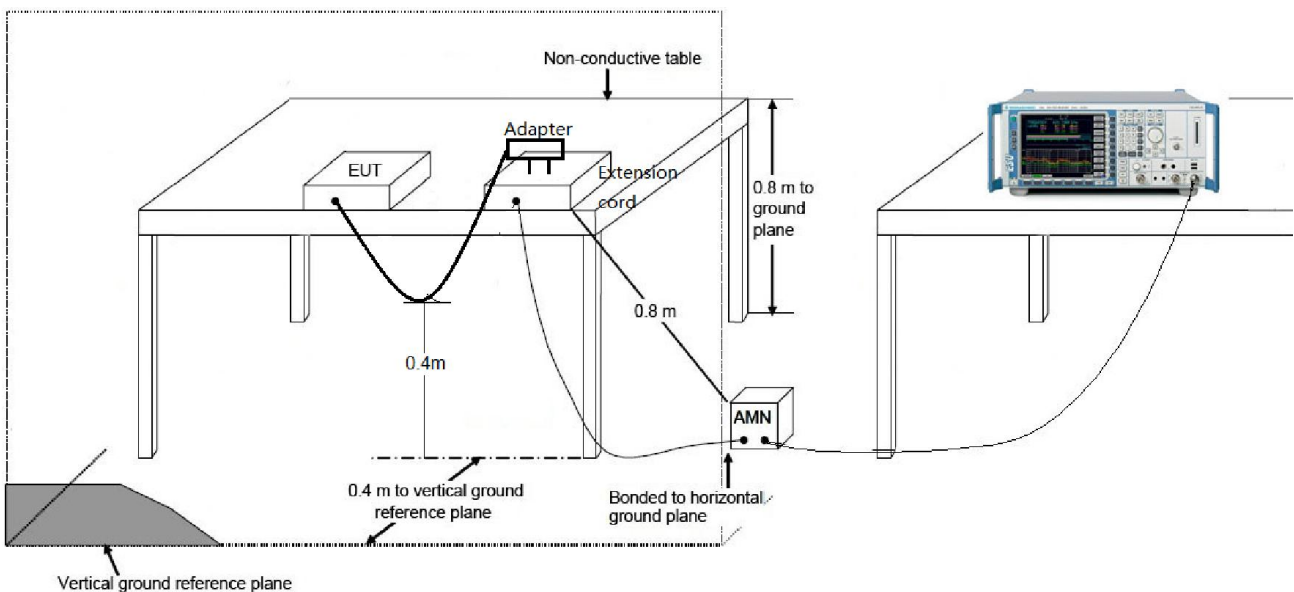

### 7.11.3. Test Result

Power supply of this device is by DC Source (3.3V), so this item is not assessed.

## 8. CONCLUSION

The data collected relate only the item(s) tested and show that the device is in compliance with Part 15C of the FCC Rules and IC Rules.

---

The End