

RF Exposure Lab

802 N. Twin Oaks Valley Road, Suite 105 • San Marcos, CA 92069 • U.S.A.

TEL (760) 471-2100 • FAX (760) 471-2121

<http://www.rfexposurelab.com>

CERTIFICATE OF TESTING SAR EVALUATION

Cubic Transportation Systems Inc.
5650 Kearny Mesa Road
San Diego, CA 92111

Dates of Test: Aug. 24-25, Sept. 3, 2020
Test Report Number: SAR.20200805
Revision B

FCC ID:	LVCVAL2LTE02
Model(s):	1098-10001
Marketing Name:	Cubic Platform Validator
Revision:	Hardware Revision: 1098-10001-2; Software Revision: 8500-99381-1 Rev. A
Contains WWAN Module:	Sierra Wireless Model HL7588 FCC ID: N7NHL7588
Contains WiFi Module:	TI Model WL1837MODGIMOCR FCC ID: Z64-WL18DBMOD
Test Sample:	Engineering Unit Same as Production
FID Number:	Eng 1
Equipment Type:	Wireless Ticket Kiosk
Classification:	Portable Transmitter Next to Extremity
TX Frequency Range:	704 – 716 MHz, 777 – 787 MHz, 824 – 849 MHz, 1710 – 1755 MHz; 1850 – 1910 MHz, 2412 – 2462 MHz
Frequency Tolerance:	± 2.5 ppm
Maximum RF Output:	750 MHz (LTE) – 25.0 dBm, 850 MHz (WCDMA) – 25.0 dBm, 850 MHz (LTE) – 25.0 dBm, 1750 MHz (LTE) – 25.0 dBm, 1900 MHz (WCDMA) – 25.0 dBm, 1900 MHz (LTE) – 25.0 dBm, 2450 MHz (b) – 17.3 dBm, 2450 MHz (g) – 17.1 dBm, 2450 MHz (n) – 16.1 dBm Conducted
Signal Modulation:	WCDMA, QPSK, 16QAM, DSSS, OFDM
Antenna Type:	WWAN – Taoglas, P/N FXUB64, WLAN – Tyco, P/N 1513504-1 (WLAN0, WLAN1)
Application Type:	Certification
FCC Rule Parts:	Part 2, 15C, 22, 24, 27
KDB Test Methodology:	KDB 447498 D01 v06, KDB 248227 v02r02, KDB 941225 D01 v03r01, D02 v02r01, D05 v02r01
Max. Stand Alone SAR Value:	3.81 W/kg Reported
Max. Simultaneous SAR Value:	3.85 W/kg Reported
Separation Distance:	0 mm

This wireless mobile and/or portable device has been tested for localized specific absorption rate (SAR) for uncontrolled environment/general exposure limits specified in ANSI/IEEE Std. C95.1-1992 and had been tested in accordance with the measurement procedures specified in IEEE 1528-2013 and IEC 62209-2:2010 (See test report).

I attest to the accuracy of the data. All measurements were performed by myself or were made under my supervision and are correct to the best of my knowledge and belief. I assume full responsibility for the completeness of these measurements and vouch for the qualifications of all persons taking them.

RF Exposure Lab, LLC certifies that no party to this application is subject to a denial of Federal benefits that includes FCC benefits pursuant to Section 5301 of the Anti-Drug Abuse Act of 1988, 21 U.S.C. 853(a).



Jay M. Moulton
Vice President



Testing Cert. # 2387.01

Table of Contents

1.	Introduction	4
	SAR Definition [5].....	5
2.	SAR Measurement Setup	6
	Robotic System	6
	System Hardware.....	6
	System Electronics.....	7
	Probe Measurement System	7
3.	Probe and Dipole Calibration.....	15
4.	Phantom & Simulating Tissue Specifications.....	16
	Head & Body Simulating Mixture Characterization	16
5.	ANSI/IEEE C95.1 – 1992 RF Exposure Limits [2].....	17
	Uncontrolled Environment	17
	Controlled Environment.....	17
6.	Measurement Uncertainty.....	18
7.	System Validation.....	19
	Tissue Verification.....	19
	Test System Verification.....	19
8.	LTE Document Checklist	20
9.	SAR Test Data Summary	24
	Procedures Used To Establish Test Signal	24
	Device Test Condition	24
10.	FCC 3G Measurement Procedures.....	26
	10.1 Procedures Used to Establish RF Signal for SAR	26
	10.2 SAR Measurement Conditions for WCDMA/HSDPA/HSUPA.....	26
	10.5 SAR Measurement Conditions for LTE Bands	32
	SAR Data Summary – 750 MHz Body – LTE Band 17	48
	SAR Data Summary – 750 MHz Body – LTE Band 13	49
	SAR Data Summary – 835 MHz Body - WCDMA	50
	SAR Data Summary – 835 MHz Body – LTE Band 5	51
	SAR Data Summary – 1750 MHz Body – LTE Band 4	52
	SAR Data Summary – 1900 MHz Body - WCDMA	53
	SAR Data Summary – 1900 MHz Body – LTE Band 2	54
	SAR Data Summary – 2450 MHz Body 802.11b	55
	SAR Data Summary – Simultaneous Transmit (Worst Case) WWAN – WiFi (Tx0).....	56
	SAR Data Summary – Simultaneous Transmit (Worst Case) WWAN – WiFi (Tx1).....	56
	Carrier Aggregation Evaluation.....	57
11.	Test Equipment List.....	58
12.	Conclusion.....	59
13.	References	60
	Appendix A – System Validation Plots and Data	61
	Appendix B – SAR Test Data Plots	74
	Appendix C – SAR Test Setup Photos	83
	Appendix D – Probe Calibration Data Sheets.....	90
	Appendix E – Dipole Calibration Data Sheets	100
	Appendix F – Phantom Calibration Data Sheets.....	141
	Appendix G – Validation Summary.....	143

Comment/Revision	Date
Original Release	September 9, 2020
Revision A – Correct the FCC ID	May 14, 2021
Revision B – Add Antenna Location Drawing	May 28, 2021

Note: The latest version supersedes all previous versions listed in the above table. The latest version shall be used.

1. Introduction

This measurement report shows compliance of the Cubic Transportation Systems Inc. Model 1098-10001 FCC ID: LVCVAL2LTE02 with FCC Part 2.1093, ET Docket 93-62 Rules for mobile and portable devices. The FCC has adopted the guidelines for evaluating the environmental effects of radio frequency radiation in ET Docket 93-62 on August 6, 1996 to protect the public and workers from the potential hazards of RF emissions due to FCC regulated portable devices. [1], [6]

The test results recorded herein are based on a single type test of Cubic Transportation Systems Inc. Model 1098-10001 and therefore apply only to the tested sample.

The test procedures and limits, as described in ANSI C95.1 – 1999 Standard for Safety Levels with Respect to Human Exposure to Radio Frequency Electromagnetic Fields, 3 kHz to 300 GHz [2], ANSI C95.3 – 2002 Recommended Practice for the Measurement of Potentially Hazardous Electromagnetic Fields [3], IEEE Std.1528 – 2013 Recommended Practice [4], and Industry Canada Safety Code 6 Limits of Human Exposure to Radiofrequency Electromagnetic Fields in the Frequency Range from 3kHz to 300 GHz were employed.

The following table indicates all the wireless technologies operating in the 1098-10001 Wireless Ticket Kiosk. The table also shows the tolerance for the power level for each mode.

Band	Technology	Class	3GPP Nominal Power dBm	Calibrated Nominal Power dBm	Tolerance dBm	Lower Tolerance dBm	Upper Tolerance dBm
Band 2 – 1900 MHz	LTE	3	23.0	23.0	±2.0	21.0	25.0
Band 4 – 1750 MHz	LTE	3	23.0	23.0	±2.0	21.0	25.0
Band 5 – 835 MHz	LTE	3	23.0	23.0	±2.0	21.0	25.0
Band 13 – 750 MHz	LTE	3	23.0	23.0	±2.0	21.0	25.0
Band 17 – 700 MHz	LTE	3	23.0	23.0	±2.0	21.0	25.0
Band 2 – 1900 MHz	WCDMA/HSPA	3	23.0	23.0	±2.0	21.0	25.0
Band 5 – 850 MHz	WCDMA/HSPA	3	23.0	23.0	±2.0	21.0	25.0
WLAN – 2.4 GHz	802.11b	N/A	N/A	N/A	N/A	N/A	17.3
WLAN – 2.4 GHz	802.11g	N/A	N/A	N/A	N/A	N/A	17.1
WLAN – 2.4 GHz	802.11n	N/A	N/A	N/A	N/A	N/A	16.1
Bluetooth – BR	Bluetooth	N/A	N/A	N/A	N/A	N/A	11.7
Bluetooth – EDR	Bluetooth	N/A	N/A	N/A	N/A	N/A	7.2
Bluetooth – BLE	Bluetooth	N/A	N/A	N/A	N/A	N/A	7.0
NFC – 13.56 MHz	NFC	N/A	N/A	N/A	N/A	N/A	17.0

Note: This device has a Bluetooth transmitter. The Bluetooth transmitter is excluded from SAR testing due to the low power and distance of the antenna to the user.

SAR Definition [5]

Specific Absorption Rate is defined as the time derivative (rate) of the incremental energy (dW) absorbed by (dissipated in) an incremental mass (dm) contained in a volume element (dV) of a given density (ρ).

$$SAR = \frac{d}{dt} \left(\frac{dW}{dm} \right) = \frac{d}{dt} \left(\frac{dW}{\rho dV} \right)$$

SAR is expressed in units of watts per kilogram (W/kg). SAR can be related to the electric field at a point by

$$SAR = \frac{\sigma |E|^2}{\rho}$$

where:

σ = conductivity of the tissue (S/m)

ρ = mass density of the tissue (kg/m³)

E = rms electric field strength (V/m)

2. SAR Measurement Setup

Robotic System

These measurements are performed using the DASY52 automated dosimetric assessment system. The DASY52 is made by Schmid & Partner Engineering AG (SPEAG) in Zurich, Switzerland and consists of high precision robotics system (Staubli), robot controller, Intel Core2 computer, near-field probe, probe alignment sensor, and the generic twin phantom containing the brain equivalent material. The robot is a six-axis industrial robot performing precise movements to position the probe to the location (points) of maximum electromagnetic field (EMF) (see Fig. 2.1).

System Hardware

A cell controller system contains the power supply, robot controller teach pendant (Joystick), and a remote control used to drive the robot motors. The PC consists of the HP Intel Core2 computer with Windows XP system and SAR Measurement Software DASY52, A/D interface card, monitor, mouse, and keyboard. The Staubli Robot is connected to the cell controller to allow software manipulation of the robot. A data acquisition electronic (DAE) circuit that performs the signal amplification, signal multiplexing, AD-conversion, offset measurements, mechanical surface detection, collision detection, etc. is connected to the Electro-optical coupler (EOC). The EOC performs the conversion from the optical into digital electric signal of the DAE and transfers data to the PC plug-in card.

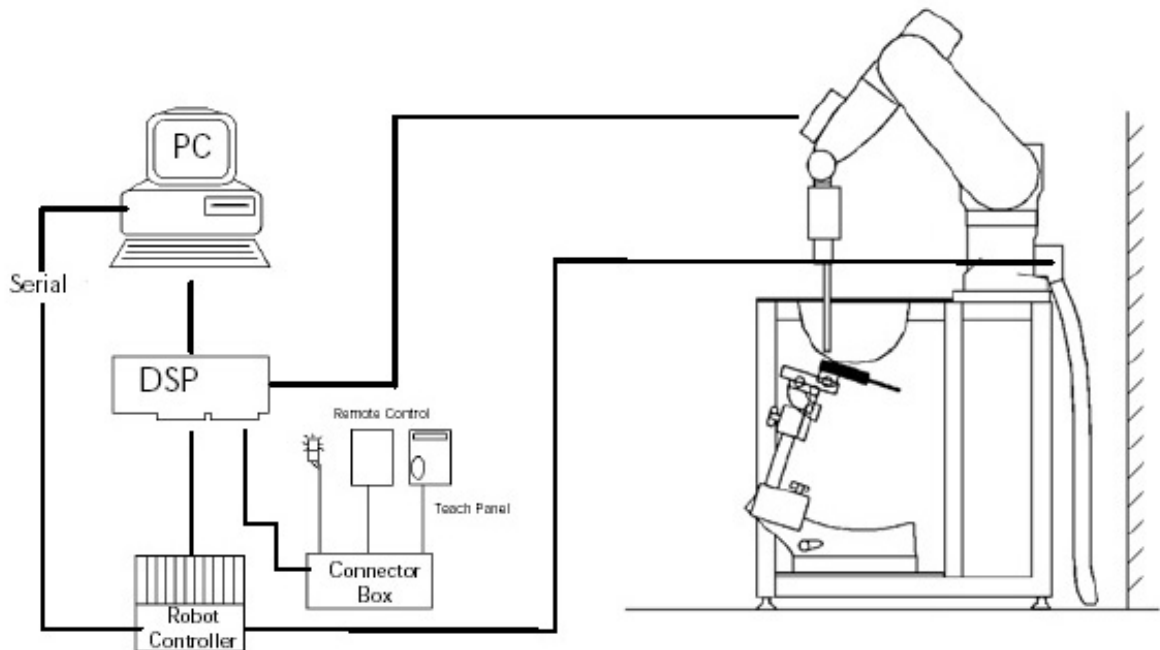

Figure 2.1 SAR Measurement System Setup

System Electronics

The DAE4 consists of a highly sensitive electrometer-grade preamplifier with auto-zeroing, a channel and gain-switching multiplexer, a fast 16 bit AD-converter and a command decoder and control logic unit. Transmission to the PC-card is accomplished through an optical downlink for data and status information and an optical uplink for commands and clock lines. The mechanical probe mounting device includes two different sensor systems for frontal and sidewise probe contacts. They are also used for mechanical surface detection and probe collision detection. The robot uses its own controller with a built in VME-bus computer. The system is described in detail in.

Probe Measurement System

The SAR measurements were conducted with the dosimetric probe EX3DV4, designed in the classical triangular configuration (see Fig. 2.2) and optimized for dosimetric evaluation. The probe is constructed using the thick film technique; with printed resistive lines on ceramic substrates. The probe is equipped with an optical multi fiber line ending at the front of the probe tip. (see Fig. 2.3) It is connected to the EOC box on the robot arm and provides an automatic detection of the phantom surface. Half of the fibers are connected to a pulsed infrared transmitter, the other half to a synchronized receiver. As the probe approaches the surface, the reflection from the surface produces a coupling from the transmitting to the receiving fibers. This reflection increases first during the approach, reaches maximum and then decreases. If the probe is flatly touching the surface, the coupling is zero. The distance of the coupling maximum to the surface is independent of the surface reflectivity and largely independent of the surface to probe angle. The DASY52 software reads the reflection during a software approach and looks for the maximum using a 2nd order fitting. The approach is stopped at reaching the maximum.



DAE System

Probe Specifications

Calibration: In air from 10 MHz to 6.0 GHz
In brain and muscle simulating tissue at Frequencies of 450 MHz, 835 MHz, 1750 MHz, 1900 MHz, 2450 MHz, 2600 MHz, 3500 MHz, 5200 MHz, 5300 MHz, 5600 MHz, 5800 MHz

Frequency: 10 MHz to 6 GHz

Linearity: ± 0.2 dB (30 MHz to 6 GHz)

Dynamic: 10 mW/kg to 100 W/kg

Range: Linearity: ± 0.2 dB

Dimensions: Overall length: 330 mm

Tip length: 20 mm

Body diameter: 12 mm

Tip diameter: 2.5 mm

Distance from probe tip to sensor center: 1 mm

Application: SAR Dosimetry Testing
Compliance tests of wireless device

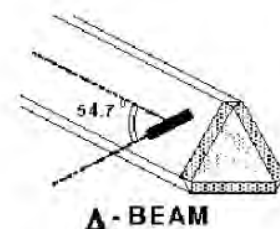

Figure 2.2 Triangular Probe Configurations



Figure 2.3 Probe Thick-Film Technique

Probe Calibration Process

Dosimetric Assessment Procedure

Each probe is calibrated according to a dosimetric assessment procedure described in with accuracy better than +/- 10%. The spherical isotropy was evaluated with the procedure described in and found to be better than +/-0.25dB. The sensitivity parameters (Norm X, Norm Y, Norm Z), the diode compression parameter (DCP) and the conversion factor (Conv F) of the probe is tested.

Free Space Assessment

The free space E-field from amplified probe outputs is determined in a test chamber. This is performed in a TEM cell for frequencies below 1 GHz, and in a waveguide above 1GHz for free space. For the free space calibration, the probe is placed in the volumetric center of the cavity at the proper orientation with the field. The probe is then rotated 360 degrees until the three channels show the maximum reading. The power density readings equates to 1 mW/cm².

Temperature Assessment *

E-field temperature correlation calibration is performed in a flat phantom filled with the appropriate simulated brain tissue. The measured free space E-field in the medium, correlates to temperature rise in a dielectric medium. For temperature correlation calibration a RF transparent thermistor based temperature probe is used in conjunction with the E-field probe

$$SAR = C \frac{\Delta T}{\Delta t}$$

$$SAR = \frac{|E|^2 \cdot \sigma}{\rho}$$

where:

where:

Δt = exposure time (30 seconds),

σ = simulated tissue conductivity,

C = heat capacity of tissue (brain or muscle),

ρ = Tissue density (1.25 g/cm³ for brain tissue)

ΔT = temperature increase due to RF exposure.

SAR is proportional to $\Delta T / \Delta t$, the initial rate of tissue heating, before thermal diffusion takes place.

Now it's possible to quantify the electric field in the simulated tissue by equating the thermally derived SAR to the E- field;

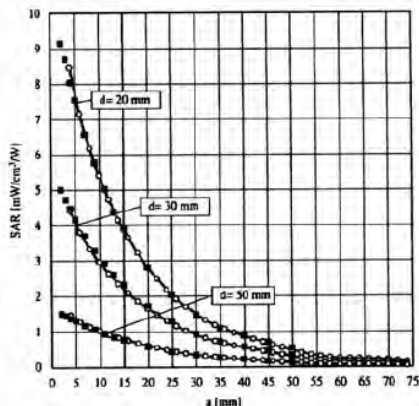

Figure 2.4 E-Field and Temperature Measurements at 900MHz

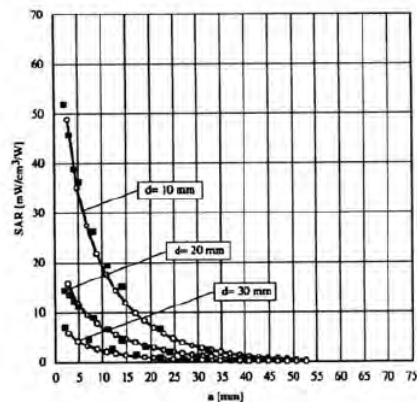

Figure 2.5 E-Field and Temperature Measurements at 1800MHz

Data Extrapolation

The DASY52 software automatically executes the following procedures to calculate the field units from the microvolt readings at the probe connector. The first step of the evaluation is a linearization of the filtered input signal to account for the compression characteristics of the detector diode. The compensation depends on the input signal, the diode type and the DC-transmission factor from the diode to the evaluation electronics. If the exciting field is pulsed, the crest factor of the signal must be known to correctly compensate for peak power. The formula for each channel can be given like below;

$$V_i = U_i + U_i^2 \cdot \frac{cf}{dcp_i}$$

with V_i = compensated signal of channel i (i=x,y,z)
 U_i = input signal of channel i (i=x,y,z)
 cf = crest factor of exciting field (DASY parameter)
 dcp_i = diode compression point (DASY parameter)

From the compensated input signals the primary field data for each channel can be evaluated:

E-field probes:

$$E_i = \sqrt{\frac{V_i}{Norm_i \cdot ConvF}}$$

with V_i = compensated signal of channel i (i = x,y,z)
 $Norm_i$ = sensor sensitivity of channel i (i = x,y,z)
 $\mu V/(V/m)^2$ for E-field probes
 $ConvF$ = sensitivity of enhancement in solution
 E_i = electric field strength of channel i in V/m

The RSS value of the field components gives the total field strength (Hermetian magnitude):

$$E_{tot} = \sqrt{E_x^2 + E_y^2 + E_z^2}$$

The primary field data are used to calculate the derived field units.

$$SAR = E_{tot}^2 \cdot \frac{\sigma}{\rho \cdot 1000}$$

with SAR = local specific absorption rate in W/g
 E_{tot} = total field strength in V/m
 σ = conductivity in [mho/m] or [Siemens/m]
 ρ = equivalent tissue density in g/cm^3

The power flow density is calculated assuming the excitation field to be a free space field.

$$P_{free} = \frac{E_{tot}^2}{3770}$$

with P_{pwe} = equivalent power density of a plane wave in W/cm^2
 E_{tot} = total electric field strength in V/m

Scanning procedure

- The DASY installation includes predefined files with recommended procedures for measurements and system check. They are read-only document files and destined as fully defined but unmeasured masks. All test positions (head or body-worn) are tested with the same configuration of test steps differing only in the grid definition for the different test positions.
- The „reference“ and „drift“ measurements are located at the beginning and end of the batch process. They measure the field drift at one single point in the liquid over the complete procedure. The indicated drift is mainly the variation of the DUT’s output power and should vary max. +/- 5 %.
- The highest integrated SAR value is the main concern in compliance test applications. These values can mostly be found at the inner surface of the phantom and cannot be measured directly due to the sensor offset in the probe. To extrapolate the surface values, the measurement distances to the surface must be known accurately. A distance error of 0.5mm could produce SAR errors of 6% at 1800 MHz. Using predefined locations for measurements is not accurate enough. Any shift of the phantom (e.g., slight deformations after filling it with liquid) would produce high uncertainties. For an automatic and accurate detection of the phantom surface, the DASY5 system uses the mechanical surface detection. The detection is always at touch, but the probe will move backward from the surface the indicated distance before starting the measurement.
- The „area scan“ measures the SAR above the DUT or verification dipole on a parallel plane to the surface. It is used to locate the approximate location of the peak SAR with 2D spline interpolation. The robot performs a stepped movement along one grid axis while the local electrical field strength is measured by the probe. The probe is touching the surface of the SAM during acquisition of measurement values. The scan uses different grid spacings for different frequency measurements. Standard grid spacing for head measurements in frequency ranges ≤ 2 GHz is 15 mm in x - and y-dimension. For higher frequencies a finer resolution is needed, thus for the grid spacing is reduced according the following table:

Area scan grid spacing for different frequency ranges	
Frequency range	Grid spacing
≤ 2 GHz	≤ 15 mm
2 – 4 GHz	≤ 12 mm
4 – 6 GHz	≤ 10 mm

Grid spacing and orientation have no influence on the SAR result. For special applications where the standard scan method does not find the peak SAR within the grid, e.g. mobile phones with flip cover, the grid can be adapted in orientation. Results of this coarse scan are shown in annex B.

- A „zoom scan” measures the field in a volume around the 2D peak SAR value acquired in the previous „coarse” scan. It uses a fine meshed grid where the robot moves the probe in steps along all the 3 axis (x,y and z-axis) starting at the bottom of the Phantom. The grid spacing for the cube measurement is varied according to the measured frequency range, the dimensions are given in the following table:

Zoom scan grid spacing and volume for different frequency ranges			
Frequency range	Grid spacing for x, y axis	Grid spacing for z axis	Minimum zoom scan volume
≤ 2 GHz	≤ 8 mm	≤ 5 mm	≥ 30 mm
2 – 3 GHz	≤ 5 mm	≤ 5 mm	≥ 28 mm
3 – 4 GHz	≤ 5 mm	≤ 4 mm	≥ 28 mm
4 – 5 GHz	≤ 4 mm	≤ 3 mm	≥ 25 mm
5 – 6 GHz	≤ 4 mm	≤ 2 mm	≥ 22 mm

DASY is also able to perform repeated zoom scans if more than 1 peak is found during area scan. In this document, the evaluated peak 1g and 10g averaged SAR values are shown in the 2D-graphics in annex B. Test results relevant for the specified standard (see section 3) are shown in table form in section 7.

Spatial Peak SAR Evaluation

The spatial peak SAR - value for 1 and 10 g is evaluated after the Cube measurements have been done. The basis of the evaluation are the SAR values measured at the points of the fine cube grid consisting of all points in the three directions x, y and z. The algorithm that finds the maximal averaged volume is separated into three different stages.

- The data between the dipole center of the probe and the surface of the phantom are extrapolated. This data cannot be measured since the center of the dipole is 1 to 2.7 mm away from the tip of the probe and the distance between the surface and the lowest measuring point is about 1 mm (see probe calibration sheet). The extrapolated data from a cube measurement can be visualized by selecting 'Graph Evaluated'.
- The maximum interpolated value is searched with a straight-forward algorithm. Around this maximum the SAR - values averaged over the spatial volumes (1g or 10 g) are computed using the 3d-spline interpolation algorithm. If the volume cannot be evaluated (i.e., if a part of the grid was cut off by the boundary of the measurement area) the evaluation will be started on the corners of the bottom plane of the cube.
- All neighbouring volumes are evaluated until no neighbouring volume with a higher average value is found.

Extrapolation

The extrapolation is based on a least square algorithm [W. Gander, Computermathematik, p.168-180]. Through the points in the first 3 cm along the z-axis, polynomials of order four are calculated. These polynomials are then used to evaluate the points between the surface and the probe tip. The points, calculated from the surface, have a distance of 1 mm from each other.

Interpolation

The interpolation of the points is done with a 3d-Spline. The 3d-Spline is composed of three one-dimensional splines with the "Not a knot"-condition [W. Gander, Computermathematik, p.141-150] (x, y and z -direction) [Numerical Recipes in C, Second Edition, p.123ff].

Volume Averaging

At First the size of the cube is calculated. Then the volume is integrated with the trapezoidal algorithm. 8000 points (20x20x20) are interpolated to calculate the average.

Advanced Extrapolation

DASY uses the advanced extrapolation option which is able to compensate boundary effects on E-field probes.

SAM PHANTOM

The SAM Twin Phantom V4.0 is constructed of a fiberglass shell integrated in a wooden table. The shape of the shell is based on data from an anatomical study designed to determine the maximum exposure in at least 90% of all users. It enables the dosimetric evaluation of left and right hand phone usage as well as body mounted usage at the flat phantom region. A cover prevents the evaporation of the liquid. Reference markings on the Phantom allow the complete setup of all predefined phantom positions and measurement grids by manually teaching three points in the robot. (see Fig. 2.6)

Phantom Specification

Phantom: SAM Twin Phantom (V4.0)
Shell Material: Vivac Composite
Thickness: 2.0 ± 0.2 mm



Figure 2.6 SAM Twin Phantom

Device Holder for Transmitters

In combination with the SAM Twin Phantom V4.0 the Mounting Device (see Fig. 2.7), enables the rotation of the mounted transmitter in spherical coordinates whereby the rotation point is the ear opening. The devices can be easily, accurately, and repeatedly be positioned according to the FCC, CENELEC, IEC and IEEE specifications. The device holder can be locked at different phantom locations (left head, right head, flat phantom).



Figure 2.7 Mounting Device

Note: A simulating human hand is not used due to the complex anatomical and geometrical structure of the hand that may produce infinite number of configurations. To produce the worst-case condition (the hand absorbs antenna output power), the hand is omitted during the tests.

3. Probe and Dipole Calibration

See Appendix D and E.

4. Phantom & Simulating Tissue Specifications

Head & Body Simulating Mixture Characterization

The head and body mixtures consist of the material based on the table listed below. The mixture is calibrated to obtain proper dielectric constant (permittivity) and conductivity of the desired tissue. Body tissue parameters that have not been specified in IEEE1528 – 2013 are derived from the issue dielectric parameters computed from the 4-Cole-Cole equations.

Table 4.1 Typical Composition of Ingredients for Tissue

Ingredients		Simulating Tissue			
		750 MHz Head	835 MHz Head	1750 MHz Head	1900 MHz Head
Mixing Percentage					
Water		Proprietary Purchased From Speag	Proprietary Purchased From Speag	Proprietary Purchased From Speag	Proprietary Purchased From Speag
Sugar					
Salt					
HEC					
Bactericide					
DGBE					
Dielectric Constant	Target	41.69	41.52	40.08	40.00
Conductivity (S/m)	Target	0.89	0.91	1.37	1.40

Ingredients		Simulating Tissue
		2450 MHz Head
Mixing Percentage		
Water		Proprietary Mixture Procured from Speag
Sugar		
Salt		
HEC		
Bactericide		
DGBE		
Dielectric Constant	Target	39.20
Conductivity (S/m)	Target	1.80

5. ANSI/IEEE C95.1 – 1992 RF Exposure Limits [2]

Uncontrolled Environment

Uncontrolled Environments are defined as locations where there is the exposure of individuals who have no knowledge or control of their exposure. The general population/uncontrolled exposure limits are applicable to situations in which the general public may be exposed or in which persons who are exposed as a consequence of their employment may not be made fully aware of the potential for exposure or cannot exercise control over their exposure. Members of the general public would come under this category when exposure is not employment-related; for example, in the case of a wireless transmitter that exposes persons in its vicinity.

Controlled Environment

Controlled Environments are defined as locations where there is exposure that may be incurred by persons who are aware of the potential for exposure, (i.e. as a result of employment or occupation). In general, occupational/controlled exposure limits are applicable to situations in which persons are exposed as a consequence of their employment, who have been made fully aware of the potential for exposure and can exercise control over their exposure. This exposure category is also applicable when the exposure is of a transient nature due to incidental passage through a location where the exposure levels may be higher than the general population/uncontrolled limits, but the exposed person is fully aware of the potential for exposure and can exercise control over his or her exposure by leaving the area or by some other appropriate means.

Table 5.1 Human Exposure Limits

	UNCONTROLLED ENVIRONMENT General Population (W/kg) or (mW/g)	CONTROLLED ENVIROMENT Professional Population (W/kg) or (mW/g)
SPATIAL PEAK SAR ¹ Head	1.60	8.00
SPATIAL AVERAGE SAR ² Whole Body	0.08	0.40
SPATIAL PEAK SAR ³ Hands, Feet, Ankles, Wrists	4.00	20.00

¹ The Spatial Peak value of the SAR averaged over any 1 gram of tissue (defined as a tissue volume in the shape of a cube) and over the appropriate averaging time.

² The Spatial Average value of the SAR averaged over the whole body.

³ The Spatial Peak value of the SAR averaged over any 10 grams of tissue (defined as a tissue volume in the shape of a cube) and over the appropriate averaging time.

6. Measurement Uncertainty

Exposure Assessment Measurement Uncertainty

Relative DASYS Uncertainty Budget for SAR Tests								
According to IEC62209-2/2010 (30 MHz - 6 GHz range)								
Error Description	Uncertainty Value	Probability Distribution	Divisor	c_i	c_i	Standard Uncertainty		v_i^2 or
				(1g)	(10g)	$\pm \%$, (1g)	$\pm \%$, (10g)	v_{eff}
Measurement System								
Probe calibration	$\pm 6.6\%$	Normal	1	1	1	$\pm 6.6\%$	$\pm 6.6\%$	∞
Axial isotropy	$\pm 4.7\%$	Rectangular	$\sqrt{3}$	0.7	0.7	$\pm 1.9\%$	$\pm 1.9\%$	∞
Hemispherical isotropy	$\pm 9.6\%$	Rectangular	$\sqrt{3}$	0.7	0.7	$\pm 3.9\%$	$\pm 3.9\%$	∞
Boundary effects	$\pm 2.0\%$	Rectangular	$\sqrt{3}$	1	1	$\pm 1.2\%$	$\pm 1.2\%$	∞
Probe linearity	$\pm 4.7\%$	Rectangular	$\sqrt{3}$	1	1	$\pm 2.7\%$	$\pm 2.7\%$	∞
System detection limits	$\pm 1.0\%$	Rectangular	$\sqrt{3}$	1	1	$\pm 0.6\%$	$\pm 0.6\%$	∞
Modulation response	$\pm 2.4\%$	Rectangular	$\sqrt{3}$	1	1	$\pm 1.4\%$	$\pm 1.4\%$	∞
Readout electronics	$\pm 0.3\%$	Normal	1	1	1	$\pm 0.3\%$	$\pm 0.3\%$	∞
Response time	$\pm 0.8\%$	Rectangular	$\sqrt{3}$	1	1	$\pm 0.5\%$	$\pm 0.5\%$	∞
Integration time	$\pm 2.6\%$	Rectangular	$\sqrt{3}$	1	1	$\pm 1.5\%$	$\pm 1.5\%$	∞
RF ambient noise	$\pm 3.0\%$	Rectangular	$\sqrt{3}$	1	1	$\pm 1.7\%$	$\pm 1.7\%$	∞
RF ambient reflections	$\pm 3.0\%$	Rectangular	$\sqrt{3}$	1	1	$\pm 1.7\%$	$\pm 1.7\%$	∞
Probe positioner	$\pm 0.8\%$	Rectangular	$\sqrt{3}$	1	1	$\pm 0.5\%$	$\pm 0.5\%$	∞
Probe positioning	$\pm 6.7\%$	Rectangular	$\sqrt{3}$	1	1	$\pm 3.9\%$	$\pm 3.9\%$	∞
Post-processing	$\pm 4.0\%$	Rectangular	$\sqrt{3}$	1	1	$\pm 2.3\%$	$\pm 2.3\%$	∞
Test Sample Related								
Device positioning	$\pm 2.9\%$	Normal	1	1	1	$\pm 2.9\%$	$\pm 2.9\%$	145
Device holder uncertainty	$\pm 3.6\%$	Normal	1	1	1	$\pm 3.6\%$	$\pm 3.6\%$	5
Power drift	$\pm 5.0\%$	Rectangular	$\sqrt{3}$	1	1	$\pm 2.9\%$	$\pm 2.9\%$	∞
Phantom and Setup								
Phantom uncertainty	$\pm 7.9\%$	Rectangular	$\sqrt{3}$	1	1	$\pm 4.6\%$	$\pm 4.6\%$	∞
SAR algorithm correction	$\pm 1.9\%$	Normal	1	1	0.84	$\pm 1.9\%$	$\pm 1.9\%$	∞
Liquid conductivity (meas.)	$\pm 5.0\%$	Rectangular	$\sqrt{3}$	0.78	0.71	$\pm 0.1\%$	$\pm 0.1\%$	∞
Liquid permittivity (meas.)	$\pm 5.0\%$	Rectangular	$\sqrt{3}$	0.26	0.26	$\pm 0.1\%$	$\pm 0.1\%$	∞
Temp. Unc. – Conductivity	$\pm 3.4\%$	Rectangular	$\sqrt{3}$	0.78	0.71	$\pm 1.5\%$	$\pm 1.5\%$	∞
Temp. Unc. – Permittivity	$\pm 0.4\%$	Rectangular	$\sqrt{3}$	0.23	0.26	$\pm 0.1\%$	$\pm 0.1\%$	∞
Combined Uncertainty						$\pm 12.4\%$	$\pm 12.3\%$	330
Expanded Std. Uncertainty						$\pm 24.8\%$	$\pm 24.6\%$	

Worst case uncertainty budget for DASYS assessed according to IEC62209-2/2010 standard. The budget is valid for the frequency range 30 MHz – 6 GHz and represents a worst-case analysis. For specific tests and configurations, the uncertainty could be considerable smaller.

7. System Validation

Tissue Verification

Table 7.1 Measured Tissue Parameters

		750 MHz Head		835 MHz Head		1750 MHz Head	
Date(s)		Aug. 25, 2020		Aug. 24, 2020		Aug. 24, 2020	
Liquid Temperature (°C)	20.0	Target	Measured	Target	Measured	Target	Measured
Dielectric Constant: ϵ		41.94	41.55	41.52	41.24	40.08	39.63
Conductivity: σ		0.89	0.91	0.91	0.95	1.37	1.42
		1900 MHz Head		2450 MHz Head			
Date(s)		Aug. 24, 2020		Sep. 3, 2020			
Liquid Temperature (°C)	20.0	Target	Measured	Target	Measured		
Dielectric Constant: ϵ		35.36	34.35	39.20	38.60		
Conductivity: σ		5.22	5.30	1.80	1.83		

See Appendix A for data printout.

Test System Verification

Prior to assessment, the system is verified to the $\pm 10\%$ of the specifications at the test frequency by using the system kit. Power is normalized to 1 watt. (Graphic Plots Attached)

Table 7.2 System Dipole Validation Target & Measured

	Test Frequency	Targeted SAR _{10g} (W/kg)	Measure SAR _{10g} (W/kg)	Tissue Used for Verification	Deviation (%)	Plot Number
25-Aug-2020	750 MHz	5.38	5.35	Head	- 0.56	1
24-Aug-2020	835 MHz	6.10	6.14	Head	+ 0.66	2
24-Aug-2020	1750 MHz	19.00	19.10	Head	+ 0.53	3
24-Aug-2020	1900 MHz	21.40	21.30	Head	- 0.47	4
03-Sep-2020	2450 MHz	24.30	25.20	Head	+ 3.70	5

See Appendix A for data plots.

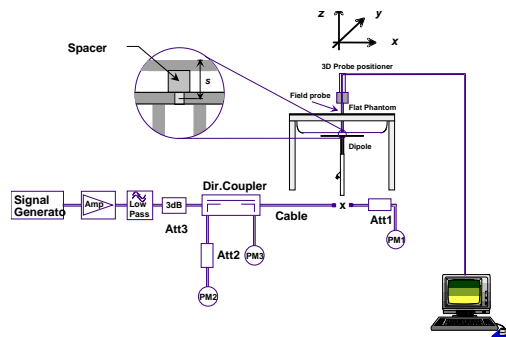

Figure 7.1 Dipole Validation Test Setup

8. LTE Document Checklist

- 1) Identify the operating frequency range of each LTE transmission band used by the device

LTE Operating Band	Uplink (transmit)	Downlink (Receive)	Duplex mode (FDD/TDD)
	Low - high	Low - high	
2	1850-1910	1930-1990	FDD
4	1710-1755	2110-2155	FDD
5	824-849	869-894	FDD
13	777-787	746-756	FDD
17	704-716	734-746	FDD

- 2) Identify the channel bandwidths used in each frequency band; 1.4, 3, 5, 10, 15, 20 MHz etc

LTE Band Class	Bandwidth (MHz)	Frequency or Freq. Band (MHz)
2	1.4, 3, 5, 10, 15, 20	1850-1910 MHz
4	1.4, 3, 5, 10, 15, 20	1710-1755 MHz
5	1.4, 3, 5, 10	824-849 MHz
13	5, 10	777-787 MHz
17	5, 10	704-716 MHz

- 3) Identify the high, middle and low (H, M, L) channel numbers and frequencies in each LTE frequency band

LTE Band Class	Bandwidth (MHz)	Frequency (MHz)/Channel #					
		Low		Mid		High	
2	1.4	1850.7	18607	1880.0	18900	1909.3	19193
2	3	1851.5	18615	1880.0	18900	1908.5	19185
2	5	1852.5	18625	1880.0	18900	1907.5	19175
2	10	1855.0	18650	1880.0	18900	1905.0	19150
2	15	1857.5	18675	1880.0	18900	1902.5	19125
2	20	1860.0	18700	1880.0	18900	1900.0	19100
4	1.4	1710.7	19957	1732.5	20175	1754.3	20393
4	3	1711.5	19965	1732.5	20175	1753.5	20385
4	5	1712.5	19975	1732.5	20175	1752.5	20375
4	10	1715.0	20000	1732.5	20175	1750.0	20350
4	15	1717.5	20025	1732.5	20175	1747.5	20325
4	20	1720.0	20050	1732.5	20175	1745.0	20300
5	1.4	824.7	20407	836.5	20525	848.3	20643
5	3	825.5	20415	836.5	20525	847.5	20635
5	5	826.5	20425	836.5	20525	846.5	20625
5	10	829.0	20450	836.5	20525	844.0	20600
13	5	779.5	23205	782.0	23230	784.5	23225
13	10	-----	-----	782.0	23230	-----	-----
17	5	706.5	23755	710.0	23790	713.5	23824
17	10	709.0	23780	710.0	23790	711.0	23799

- 4) Specify the UE category and uplink modulations used:
 - UE Category: 3
 - Uplink modulations: QPSK and 16QAM
- 5) Include descriptions of the LTE transmitter and antenna implementation; and also identify whether it is a standalone transmitter operating independently of other wireless transmitters in the device or sharing hardware components and/or antenna(s) with other transmitters etc

The device has 14 antennas:

- #0 WWAN Antenna (Transmit and Receive)
- #1 WWAN Antenna (Receive Only)
- #2 WLAN0 Antenna (Transmit and Receive)
- #3 WLAN1 Antenna (Transmit and Receive)

Transmission relationship

- All transmission (TX) is limited to the WWAN and WLAN antennas only
- The device is unable to transmit WCDMA/HSPA and LTE simultaneously.
- Rx is simultaneous
- Simultaneous Tx with the WWAN and WLAN is active.

- 6) Identify the LTE voice/data requirements in each operating mode and exposure condition with respect to head and body test configurations, antenna locations, handset flip-cover or slide positions, antenna diversity conditions etc

The device is a data only device. Data mode was tested in each operating mode and exposure condition in the body configuration. See test setup photos to see all configurations tested.

- 7) Identify if Maximum Power Reduction (MPR) is optional or mandatory, i.e. built-in by design:
 - a) Only mandatory MPR may be considered during SAR testing, when the maximum output power is permanently limited by the MPR implemented within the UE; and only for the applicable RB (resource block) configurations specified in LTE standards

MPR is mandatory, built-in by design on all production units. It was enabled during testing.

Modulation	Channel Bandwidth/transmission Bandwidth Configuration (RB)						MPR (dB)
	1.4 MHz	3.0 MHz	5 MHz	10 MHz	15 MHz	20 MHz	
QPSK	> 5	> 4	> 8	> 12	> 16	> 18	≤ 1
16QAM	≤ 5	≤ 4	≤ 8	≤ 12	≤ 16	≤ 18	≤ 1
16QAM	> 5	> 4	> 8	> 12	> 16	> 18	≤ 2

- b) A-MPR (additional MPR) must be disabled
- c) A-MPR was disabled during testing.

- 8) Include the maximum average conducted output power measured on the required test channels for each channel bandwidth and UL modulation used in each frequency band:

The maximum average conducted output power measured for the testing is listed on pages 32-41 of this report. The below table shows the factory set point with the allowable tolerance.

Band	Technology	Class	3GPP Nominal Power dBm	Calibrated Nominal Power dBm	Tolerance dBm	Lower Tolerance dBm	Upper Tolerance dBm
Band 2 – 1900 MHz	LTE	3	23.0	23.0	±2.0	21.0	25.0
Band 4 – 1750 MHz	LTE	3	23.0	23.0	±2.0	21.0	25.0
Band 5 – 835 MHz	LTE	3	23.0	23.0	±2.0	21.0	25.0
Band 13 – 750 MHz	LTE	3	23.0	23.0	±2.0	21.0	25.0
Band 17 – 700 MHz	LTE	3	23.0	23.0	±2.0	21.0	25.0

- 9) Identify all other U.S. wireless operating modes (3G, Wi-Fi, WiMax, Bluetooth etc), device/exposure configurations (head and body, antenna and handset flip-cover or slide positions, antenna diversity conditions etc.) and frequency bands used for these modes

Other wireless modes:

Band	Technology	Class	3GPP Nominal Power dBm	Calibrated Nominal Power dBm	Tolerance dBm	Lower Tolerance dBm	Upper Tolerance dBm
Band 2 – 1900 MHz	WCDMA/HSPA	3	23.0	23.0	±2.0	21.0	25.0
Band 5 – 850 MHz	WCDMA/HSPA	3	23.0	23.0	±2.0	21.0	25.0
WLAN – 2.4 GHz	802.11b	N/A	N/A	N/A	N/A	N/A	17.3
WLAN – 2.4 GHz	802.11g	N/A	N/A	N/A	N/A	N/A	17.1
WLAN – 2.4 GHz	802.11n	N/A	N/A	N/A	N/A	N/A	16.1
Bluetooth – BR	Bluetooth	N/A	N/A	N/A	N/A	N/A	11.7
Bluetooth – EDR	Bluetooth	N/A	N/A	N/A	N/A	N/A	7.2
Bluetooth – BLE	Bluetooth	N/A	N/A	N/A	N/A	N/A	7.0
NFC – 13.56 MHz	NFC	N/A	N/A	N/A	N/A	N/A	17.0

- 10) Include the maximum average conducted output power measured for the other wireless modes and frequency bands.

The maximum average conducted output power measured for the testing is listed on pages 26-27 of this report. The table in item 9 shows the factory set point with the allowable tolerance.

- 11) Identify the simultaneous transmission conditions for the voice and data configurations supported by all wireless modes, device configurations and frequency bands, for the head and body exposure conditions and device operating configurations (handset flip or cover positions, antenna diversity conditions etc.)

The device is unable to transmit WCDMA and LTE simultaneously.

The device is able to transmit WWAN and WLAN simultaneously.

TX Modes	WCDMA	LTE	802.11 b/g/n
1	ON	OFF	ON
2	OFF	ON	ON

- 12) When power reduction is applied to certain wireless modes to satisfy SAR compliance for simultaneous transmission conditions, other equipment certification or operating requirements, include the maximum average conducted output power measured in each power reduction mode applicable to the simultaneous voice/data transmission configurations for such wireless configurations and frequency bands; and also include details of the power reduction implementation and measurement setup

Power reduction was not required.

- 13) Include descriptions of the test equipment, test software, built-in test firmware etc. required to support testing the device when power reduction is applied to one or more transmitters/antennas for simultaneous voice/data transmission

Power reduction was not required.

- 14) When appropriate, include a SAR test plan proposal with respect to the above

Power reduction was not required.

- 15) If applicable, include preliminary SAR test data and/or supporting information in laboratory testing inquiries to address specific issues and concerns or for requesting further test reduction considerations appropriate for the device; for example, simultaneous transmission configurations.

Not applicable.

9. SAR Test Data Summary

See Measurement Result Data Pages

See Appendix B for SAR Test Data Plots.
See Appendix C for SAR Test Setup Photos.

Procedures Used To Establish Test Signal

The device was either placed into simulated transmit mode using the manufacturer's test codes or the actual transmission is activated through a base station simulator or similar equipment. See data pages for actual procedure used in measurement.

Device Test Condition

In order to verify that the device was tested at full power, conducted output power measurements were performed before and after each SAR measurement to confirm the output power unless otherwise noted. If a conducted power deviation of more than 5% occurred, the test was repeated. The power drift of each test is measured at the start of the test and again at the end of the test. The drift percentage is calculated by the formula $((\text{end}/\text{start})-1)*100$ and rounded to three decimal places. The drift percentage is calculated into the resultant SAR value on the data sheet for each test.

The testing was conducted on all edges closest to each antenna. The front of the antenna was tested for the WWAN antenna for WCDMA and LTE Bands B2, B4, B5, B13 and B17. The antenna was more than 2.5 cm from all other sides. The front of the LCD was tested for both WLAN antennas. The antennas were more than 2.5 cm from all other sides. All further test reductions are shown on page 30 for WCDMA bands, page 28-29 for WLAN and pages 42-46 for LTE bands. All testing was conducted per KDB 447498 D01 v06. See the photo in Appendix C for a pictorial of the setups.

The housing of the device was too large to fit completely under the phantom. Therefore, the control unit and antennas were removed from the case and tested in a standalone configuration. The WWAN antenna was tested using a 5 mm thick spacer with the equivalent dielectric properties as the housing of the device. This gave the most conservative SAR measurement on the device for the WWAN antenna. The WiFi was tested with the front face of the LCD screen flat against the phantom as it would be in normal operation. See the antenna locations in the drawing below. Please see the setup photos in Appendix C.

The WCDMA testing was conducted using 12.2 kbps RMC configured in Test Loop Mode 1. The HSPA testing was conducted with HS-DPCCH, E-DPCCH and E-DPDCH all enabled and a 12.2 kbps RMC. FRC was configured according to HS-DPCCH Sub-Test 1 using H-set 1 and QPSK.

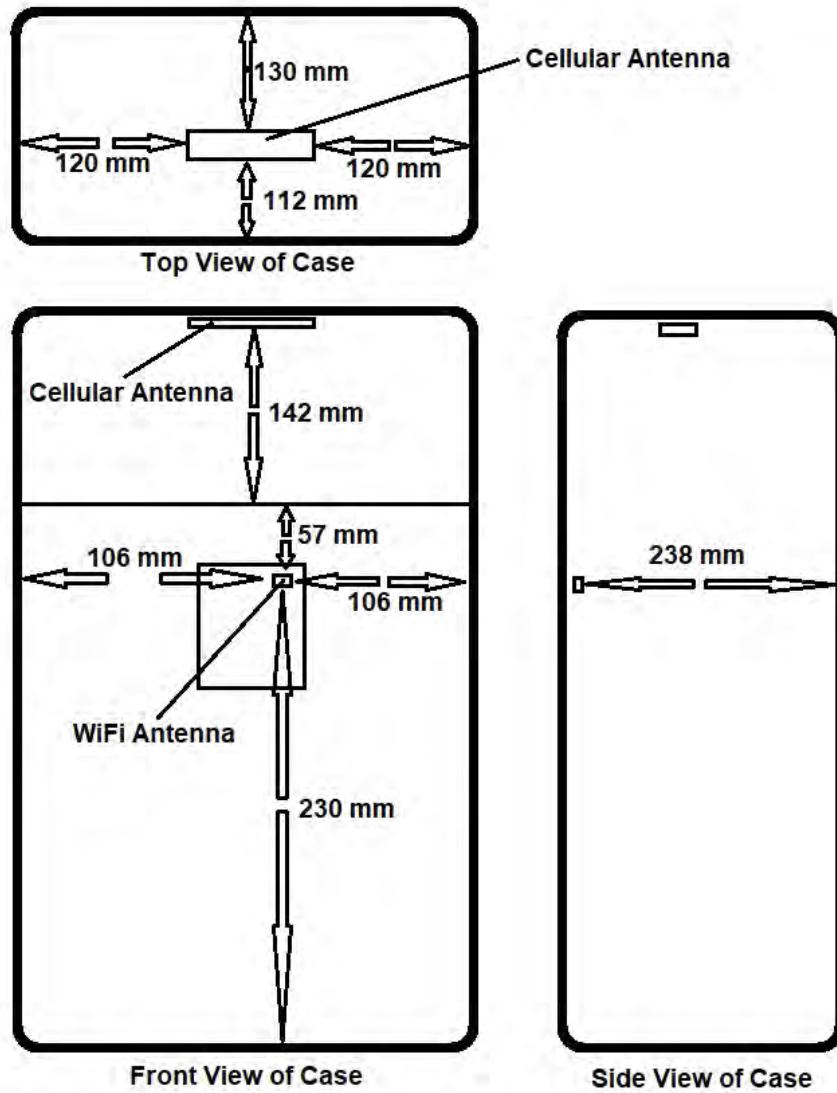

Antenna Location Drawing

10. FCC 3G Measurement Procedures

Power measurements were performed using a base station simulator under average power.

10.1 Procedures Used to Establish RF Signal for SAR

The device was placed into a simulated call using a base station simulator in a screen room. Such test signals offer a consistent means for testing SAR and recommended for evaluating SAR. The SAR measurement software calculates a reference point at the start and end of the test to check for power drifts. If conducted power deviations of more than 5% occurred, the tests were repeated.

10.2 SAR Measurement Conditions for WCDMA/HSDPA/HSUPA

Configure the call box 8960 to support all WCDMA tests in respect to the 3GPP 34.121 (listed in Table below). Measure the power at Ch4132, 4182 and 4233 for US cell; Ch9262, 9400 and 9538 for US PCS band.

For Rel99

- Set a Test Mode 1 loop back with a 12.2kbps Reference Measurement Channel (RMC).
- Set and send continuously Up power control commands to the device
- Measure the power at the device antenna connector using the power meter with average detector.

For HSDPA Rel 6

- Establish a Test Mode 1 look back with both 1 12.2kbps RMC channel and a H-Set1 Fixed Reference Channel (FRC). With the 8960 this is accomplished by setting the signal Channel Coding to "Fixed Reference Channel" and configuring for HSET-1 QKSP.
- Set beta values and HSDPA settings for HSDPA Subtest1 according to Table below.
- Send continuously Up power control commands to the device
- Measure the power at the device antenna connector using the power meter with modulated average detector.
- Repeat the measurement for the HSDPA Subtest2, 3 and 4 as given in Table below.

For HSUPA Rel 6

- Use UL RMC 12.2kbps and FRC H-Set1 QPSK, Test Mode 1 loop back. With the 8960 this is accomplished by setting the signal Channel Coding to "E-DCH Test Channel" and configuring the equipment category to Cat5_10ms.
- Set the Absolute Grant for HSUPA Subtest1 according to Table below.
- Set the device power to be at least 5dB lower than the Maximum output power
- Send power control bits to give one TPC_cmd = +1 command to the device. If device doesn't send any E-DPCH data with decreased E-TFCl within 500ms, then repeat this process until the decreased E-TFCl is reported.
- Confirm that the E-TFCl transmitted by the device is equal to the target E-TFCl in Table below. If the E-TFCl transmitted by the device is not equal to the target E-TFCl, then send power control bits to give one TPC_cmd = -1 command to the UE. If UE sends any E-DPCH data with decreased E-TFCl within 500 ms, send new power control bits to give one TPC_cmd = -1 command to the UE. Then confirm that the E-TFCl transmitted by the UE is equal to the target E-TFCl in Table below.
- Measure the power using the power meter with modulated average detector.
- Repeat the measurement for the HSUPA Subtest2, 3, 4 and 5 as given in Table below.

3GPP Release Version	Mode	Cellular Band [dBm]			Sub-Test (See Table Below)	MPR
		4132	4183	4233		
99	WCDMA	23.49	23.44	23.70	-	-
6	HSDPA	23.06	23.34	23.23	1	0
6		23.12	23.32	23.47	2	0
6		22.69	22.98	22.63	3	0.5
6		22.79	22.89	22.71	4	0.5
6	HSUPA	23.39	23.34	23.12	1	0
6		21.21	21.12	21.11	2	2
6		22.32	22.01	22.27	3	1
6		21.05	21.13	21.21	4	2
6		23.31	23.23	23.20	5	0

3GPP Release Version	Mode	PCS Band [dBm]			Sub-Test (See Table Below)	MPR
		9262	9400	9538		
99	WCDMA	24.79	24.81	24.82	-	-
6	HSDPA	24.00	24.44	24.02	1	0
6		24.01	24.26	24.09	2	0
6		23.56	23.62	23.88	3	0.5
6		23.53	23.62	23.80	4	0.5
6	HSUPA	24.24	24.01	24.15	1	0
6		22.12	22.40	22.45	2	2
6		23.47	23.12	23.47	3	1
6		22.24	22.30	22.09	4	2
6		24.03	24.03	24.17	5	0

Sub-Test Setup for Release 6 HSDPA

Sub-Test	β_c	β_d	B_c / β_d	β_{hs}
1	2/15	15/15	2/15	4/15
2	12/15	15/15	15/15	24/15
3	15/15	8/15	15/8	30/15
4	15/15	4/15	15/4	30/15

$\Delta_{ack}, \Delta_{nack}$ and $\Delta_{cqi} = 8$

Sub-Test Setup for Release 6 HSUPA

Sub-Test	β_c	β_d	B_c / β_d	β_{hs}	B_{ec}	B_{ed}	MPR	AG Index	E-TFCI
1	11/15	15/15	11/15	22/15	209/225	1039/225	0.0	20	75
2	6/15	15/15	6/15	12/15	12/15	94/75	2.0	12	67
3	15/15	9/15	15/9	30/15	30/15	47/15	1.0	15	92
4	2/15	15/15	2/15	4/15	2/15	56/15	2.0	17	71
5	15/15	15/15	15/15	30/15	24/15	134/15	0.0	21	81

$\Delta_{ack}, \Delta_{nack}$ and $\Delta_{cqi} = 8$

Band	Mode	Bandwidth (MHz)	Channel	Frequency (MHz)	Data Rate	Antenna	Avg Power (dBm)	Tune-up Pwr (dBm)
2450 MHz	802.11b	20	1	2412	1 Mbps	Tx0	17.25	17.30
			6	2437			17.30	17.30
			11	2462			17.20	17.30
			1	2412		Tx1	17.24	17.30
			6	2437			17.30	17.30
			11	2462			17.26	17.30
	802.11g	20	1	2412	6 Mbps	Tx0	17.07	17.10
			6	2437			17.04	17.10
			11	2462			17.04	17.10
			1	2412		Tx1	16.99	17.10
			6	2437			16.96	17.10
			11	2462			16.92	17.10
	802.11n	20	1	2412	HTO	Tx0	16.95	16.10
			6	2437			16.87	16.10
			11	2462			16.90	16.10
			1	2412		Tx1	16.91	16.10
			6	2437			16.88	16.10
			11	2462			16.89	16.10
	802.11n	40	3	2422	HTO	Tx0	16.95	16.10
			6	2437			16.87	16.10
			10	2457			16.90	16.10
			3	2422		Tx1	16.91	16.10
			6	2437			16.88	16.10
			10	2457			16.89	16.10

Band	Mode	Channel	Frequency (MHz)	Data Rate	Antenna	Avg Power (dBm)	Tune-up Pwr (dBm)
2450 MHz	Bluetooth v4.0	0	2402	Basic Rate GFSK	Tx1	11.40	11.70
		39	2441			11.47	11.70
		78	2480			11.42	11.70
		0	2402	EDR $\pi/4$ DQPSK		7.12	7.20
		39	2441			7.13	7.20
		78	2480			7.18	7.20
		0	2402	EDR 8-DPSK		7.14	7.20
		39	2441			7.11	7.20
		78	2480			7.13	7.20
		0	2402	Low Energy GFSK		6.99	7.00
		39	2441			6.88	7.00
		78	2480			6.93	7.00

Figure 10.1 Test Reduction Table – 2.4 GHz Tx0

Mode	Side	Required Channel	Tested/Reduced
802.11b	Front	1 – 2412 MHz	Reduced ¹
		6 – 2437 MHz	Tested
		11 – 2462 MHz	Reduced ¹
	All Other Sides	1 – 2412 MHz	Reduced ³
		6 – 2437 MHz	Reduced ³
		11 – 2462 MHz	Reduced ³
802.11g	Front	1 – 2412 MHz	Reduced ²
		6 – 2437 MHz	Reduced ²
		11 – 2462 MHz	Reduced ²
	All Other Sides	1 – 2412 MHz	Reduced ²
		6 – 2437 MHz	Reduced ²
		11 – 2462 MHz	Reduced ²
802.11n	Front	1 – 2412 MHz	Reduced ²
		6 – 2437 MHz	Reduced ²
		11 – 2462 MHz	Reduced ²
	All Other Sides	1 – 2412 MHz	Reduced ²
		6 – 2437 MHz	Reduced ²
		11 – 2462 MHz	Reduced ²

Reduced¹ – When the reported SAR is ≤ 1.0 W/kg, SAR is not required for the remaining test configuration per KDB 248227 D01 v02r02 section 5.1.1 1) page 9.

Reduced² – When the highest reported SAR for DSSS is adjusted by the ratio of OFDM to DSSS specified maximum output power and the adjusted SAR is ≤ 3.0 W/kg, SAR is not required per KDB 248227 D01 v02r02 section 5.2.2 2) page 10.

Reduced³ – When the antenna is more than 25 mm from a side, the test can be reduced per KDB447498 D01 v06 section 4.3.1 1) page 11. See below for calculations.

Reduced⁴ – When the reported SAR is > 1.0 W/kg, test the next highest configuration until the SAR value is ≤ 2.0 W/kg per KDB 248227 D01 v02r02 section 5.1.1 2) page 9.

Maximum power: 53.7 mW

Closest Distance to Other Sides: 57 mm

$[\{(3.0)/(\sqrt{2.462})\} * 50 \text{ mm}] + \{57 - 50 \text{ mm}\} * 10 = 165 \text{ mW}$ which is greater than 53.7 mW

Figure 10.2 Test Reduction Table – 2.4 GHz Tx1

Mode	Side	Required Channel	Tested/Reduced
802.11b	Front	1 – 2412 MHz	Reduced ¹
		6 – 2437 MHz	Tested
		11 – 2462 MHz	Reduced ¹
	All Other Sides	1 – 2412 MHz	Reduced ³
		6 – 2437 MHz	Reduced ³
		11 – 2462 MHz	Reduced ³
802.11g	Front	1 – 2412 MHz	Reduced ²
		6 – 2437 MHz	Reduced ²
		11 – 2462 MHz	Reduced ²
	All Other Sides	1 – 2412 MHz	Reduced ²
		6 – 2437 MHz	Reduced ²
		11 – 2462 MHz	Reduced ²
802.11n	Front	1 – 2412 MHz	Reduced ²
		6 – 2437 MHz	Reduced ²
		11 – 2462 MHz	Reduced ²
	All Other Sides	1 – 2412 MHz	Reduced ²
		6 – 2437 MHz	Reduced ²
		11 – 2462 MHz	Reduced ²

Reduced¹ – When the reported SAR is ≤ 1.0 W/kg, SAR is not required for the remaining test configuration per KDB 248227 D01 v02r02 section 5.1.1 1) page 9.

Reduced² – When the highest reported SAR for DSSS is adjusted by the ratio of OFDM to DSSS specified maximum output power and the adjusted SAR is ≤ 3.0 W/kg, SAR is not required per KDB 248227 D01 v02r02 section 5.2.2 2) page 10.

Reduced³ – When the antenna is more than 25 mm from a side, the test can be reduced per KDB447498 D01 v06 section 4.3.1 1) page 11. See below for calculations.

Reduced⁴ – When the reported SAR is > 1.0 W/kg, test the next highest configuration until the SAR value is ≤ 2.0 W/kg per KDB 248227 D01 v02r02 section 5.1.1 2) page 9.

Maximum power: 53.7 mW

Closest Distance to Other Sides: 57 mm

$[\{(3.0)/(\sqrt{2.462})\} * 50 \text{ mm}] + \{57 - 50 \text{ mm}\} * 10 = 165 \text{ mW}$ which is greater than 53.7 mW

Figure 10.3 Test Reduction Table – 3G

Band/ Frequency (MHz)	Technology	Side	Required Channel	Tested/ Reduced	
Band 5 824-849 MHz	WCDMA	Front	4132	Tested	
			4183	Tested	
			4233	Tested	
		All Other Sides	4132	Reduced ²	
			4183	Reduced ²	
			4233	Reduced ²	
Band 2 1850-1910 MHz		WCDMA	Front	9262	Tested
				9400	Tested
				9538	Tested
	All Other Sides		9262	Reduced ²	
			9400	Reduced ²	
			9538	Reduced ²	

Reduced¹ – When the mid channel is 3 dB below the limit, the remaining channels are not required per KDB 447498 D01 v06 section 4.3.3 page 14.

Reduced² – When the antenna is more than 25 mm from a side, the test can be reduced per KDB447498 D01 v06 section 4.3.1 1) page 11. See below for calculations.

Maximum power: 316.2 mW

Closest Distance: 112 mm

$[\{(3.0)/(\sqrt{0.849})\} * 50 \text{ mm}] + \{112 - 50 \text{ mm}\} * 10 = 782 \text{ mW}$ which is greater than 316.2 mW
 $[\{(3.0)/(\sqrt{1.91})\} * 50 \text{ mm}] + \{112 - 50 \text{ mm}\} * 10 = 728 \text{ mW}$ which is greater than 316.2 mW

10.5 SAR Measurement Conditions for LTE Bands

10.5.1 LTE Functionality

The follow table identifies all the channel bandwidths in each frequency band supported by this device.

LTE Band Class	Bandwidth (MHz)	Frequency or Freq. Band (MHz)
2	1.4, 3, 5, 10, 15, 20	1850-1910 MHz
4	1.4, 3, 5, 10, 15, 20	1710-1755 MHz
5	1.4, 3, 5, 10	824-849 MHz
13	5, 10	777-787 MHz
17	5, 10	704-716 MHz

10.5.2 Test Conditions

All SAR measurements for LTE were performed using the Anritsu MT8820C. A closed loop power control setting allowed the UE to transmit at the maximum output power during the SAR measurements. The Figure 11.1 table indicates all the test reduction utilized for this report.

MPR was enabled for this device. A-MPR was disabled for all SAR test measurements.

Table 10.5.1 LTE Power Measurements

Band	Bandwidth	RB Size	RB Offset	Channel	Frequency	QPSK	16QAM	
2	1.4 MHz	1	0	18607	1850.7	23.57	23.16	
				18900	1880.0	23.59	23.16	
				19193	1909.3	23.59	23.06	
			3	18607	1850.7	23.74	23.16	
				18900	1880.0	23.72	23.27	
				19193	1909.3	23.60	23.17	
			5	18607	1850.7	23.68	23.20	
				18900	1880.0	23.69	23.20	
				19193	1909.3	23.61	23.09	
		3	0	18607	1850.7	23.51	22.71	
				18900	1880.0	23.50	22.68	
				19193	1909.3	23.47	22.62	
			1	18607	1850.7	23.58	22.73	
				18900	1880.0	23.62	22.81	
				19193	1909.3	23.51	22.73	
			3	18607	1850.7	23.59	22.71	
				18900	1880.0	23.62	22.79	
				19193	1909.3	23.51	22.66	
	6	0	18607	1850.7	22.62	21.76		
			18900	1880.0	22.52	21.71		
			19193	1909.3	22.54	21.67		
	3 MHz	1	0	18615	1851.5	23.66	23.21	
				18900	1880.0	23.67	23.23	
				19185	1908.5	23.62	23.19	
				7	18615	1851.5	23.85	23.28
					18900	1880.0	23.86	23.27
					19185	1908.5	23.79	23.13
			14	18615	1851.5	23.68	23.22	
				18900	1880.0	23.80	23.33	
				19185	1908.5	23.68	23.26	
			8	0	18615	1851.5	22.75	21.88
					18900	1880.0	22.72	21.80
					19185	1908.5	22.64	21.82
				7	18615	1851.5	22.72	21.90
					18900	1880.0	22.77	21.87
					19185	1908.5	22.67	21.86
				14	18615	1851.5	22.72	21.88
					18900	1880.0	22.78	21.86
					19185	1908.5	22.72	21.81
		15	0	18615	1851.5	22.74	21.82	
				18900	1880.0	22.70	21.87	
				19185	1908.5	22.64	21.85	

Band	Bandwidth	RB Size	RB Offset	Channel	Frequency	QPSK	16QAM	
2	5 MHz	1	0	18625	1852.5	23.74	23.23	
				18900	1880.0	23.65	23.22	
				19175	1907.5	23.70	23.23	
			12	18625	1852.5	23.81	23.22	
				18900	1880.0	23.85	23.44	
				19175	1907.5	23.89	23.35	
			24	18625	1852.5	23.83	23.38	
				18900	1880.0	23.87	23.42	
				19175	1907.5	23.76	23.32	
		12	0	18625	1852.5	22.73	21.85	
				18900	1880.0	22.77	21.82	
				19175	1907.5	22.73	21.80	
			6	18625	1852.5	22.82	21.83	
				18900	1880.0	22.79	21.85	
				19175	1907.5	22.74	21.85	
			13	18625	1852.5	22.73	21.83	
				18900	1880.0	22.84	21.89	
				19175	1907.5	22.75	21.79	
		25	0	18625	1852.5	22.78	21.82	
				18900	1880.0	22.79	21.85	
				19175	1907.5	22.77	21.82	
		10 MHz	1	0	18650	1855.0	23.89	23.53
					18900	1880.0	23.94	23.55
					19150	1905.0	23.82	23.35
	24			18650	1855.0	23.89	23.50	
				18900	1880.0	24.00	23.56	
				19150	1905.0	23.82	23.56	
	49			18650	1855.0	23.89	23.36	
				18900	1880.0	23.84	23.42	
				19150	1905.0	23.81	23.27	
	25			0	18650	1855.0	22.80	21.90
					18900	1880.0	22.76	21.84
					19150	1905.0	22.70	21.80
				13	18650	1855.0	22.82	21.88
					18900	1880.0	22.80	21.90
					19150	1905.0	22.70	21.85
			25	18650	1855.0	22.85	21.88	
				18900	1880.0	22.82	21.95	
				19150	1905.0	22.81	21.85	
	50		0	18650	1855.0	22.85	21.87	
				18900	1880.0	22.76	21.85	
				19150	1905.0	22.77	21.77	

Band	Bandwidth	RB Size	RB Offset	Channel	Frequency	QPSK	16QAM	
2	15 MHz	1	0	18675	1857.5	23.84	23.40	
				18900	1880.0	23.87	23.37	
				19125	1902.5	23.88	23.32	
			37	18675	1857.5	23.78	23.30	
				18900	1880.0	23.93	23.29	
				19125	1902.5	23.94	23.23	
			74	18675	1857.5	23.89	23.40	
				18900	1880.0	23.88	23.44	
				19125	1902.5	23.77	23.29	
		36	0	18675	1857.5	22.77	21.82	
				18900	1880.0	22.82	21.87	
				19125	1902.5	22.76	21.80	
			19	18675	1857.5	22.85	21.87	
				18900	1880.0	22.87	21.87	
				19125	1902.5	22.84	21.88	
			39	18675	1857.5	22.84	21.93	
				18900	1880.0	22.95	21.95	
				19125	1902.5	22.88	21.87	
			75	0	18675	1857.5	22.89	21.91
					18900	1880.0	22.89	21.86
					19125	1902.5	22.83	21.85
		20 MHz	1	0	18700	1860.0	23.87	23.43
					18900	1880.0	23.72	23.26
					19100	1900.0	23.83	23.29
	49			18700	1860.0	23.88	23.38	
				18900	1880.0	23.88	23.33	
				19100	1900.0	23.76	23.23	
	99			18700	1860.0	23.94	23.40	
				18900	1880.0	23.83	23.37	
				19100	1900.0	23.78	23.21	
	50			0	18700	1860.0	22.82	21.85
					18900	1880.0	22.81	21.85
					19100	1900.0	22.82	21.81
				24	18700	1860.0	22.88	21.94
					18900	1880.0	22.89	21.90
					19100	1900.0	22.80	21.86
				50	18700	1860.0	22.94	21.91
					18900	1880.0	22.92	21.99
					19100	1900.0	22.86	21.92
	100		0	18700	1860.0	22.86	21.91	
				18900	1880.0	22.86	21.84	
				19100	1900.0	22.82	21.84	

Band	Bandwidth	RB Size	RB Offset	Channel	Frequency	QPSK	16QAM	
4	1.4 MHz	1	0	19957	1710.7	23.66	23.19	
				20175	1732.5	23.58	23.20	
				20393	1754.3	23.61	23.18	
			3	19957	1710.7	23.68	23.23	
				20175	1732.5	23.67	23.23	
				20393	1754.3	23.63	23.19	
			5	19957	1710.7	23.68	23.26	
				20175	1732.5	23.59	23.15	
				20393	1754.3	23.58	23.26	
		3	0	19957	1710.7	23.59	22.80	
				20175	1732.5	23.54	22.73	
				20393	1754.3	23.57	22.72	
			1	19957	1710.7	23.67	22.83	
				20175	1732.5	23.64	22.79	
				20393	1754.3	23.59	22.78	
			3	19957	1710.7	23.57	22.80	
				20175	1732.5	23.56	22.78	
				20393	1754.3	23.56	22.72	
		6	0	19957	1710.7	22.76	21.84	
				20175	1732.5	22.69	21.87	
				20393	1754.3	22.67	21.85	
		3 MHz	1	0	19965	1711.5	23.73	23.34
					20175	1732.5	23.65	23.25
					20385	1753.5	23.78	23.38
	7			19965	1711.5	23.89	23.36	
				20175	1732.5	23.80	23.38	
				20385	1753.5	23.85	23.28	
	14			19965	1711.5	23.80	23.46	
				20175	1732.5	23.79	23.49	
				20385	1753.5	23.79	23.26	
	8			0	19965	1711.5	22.75	21.93
					20175	1732.5	22.74	21.80
					20385	1753.5	22.73	21.88
			7	19965	1711.5	22.83	22.00	
				20175	1732.5	22.72	21.93	
				20385	1753.5	22.82	21.91	
			14	19965	1711.5	22.83	21.97	
				20175	1732.5	22.84	21.93	
				20385	1753.5	22.76	21.90	
	15		0	19965	1711.5	22.77	21.91	
				20175	1732.5	22.70	21.90	
				20385	1753.5	22.76	21.88	

Band	Bandwidth	RB Size	RB Offset	Channel	Frequency	QPSK	16QAM	
4	5 MHz	1	0	19975	1712.5	23.75	23.30	
				20175	1732.5	23.67	23.27	
				20375	1752.5	23.68	23.31	
			12	19975	1712.5	23.97	23.41	
				20175	1732.5	23.89	23.45	
				20375	1752.5	23.87	23.21	
			24	19975	1712.5	23.81	23.52	
				20175	1732.5	23.84	23.34	
				20375	1752.5	23.81	23.36	
		12	0	19975	1712.5	22.79	21.85	
				20175	1732.5	22.69	21.82	
				20375	1752.5	22.81	21.83	
			6	19975	1712.5	22.84	21.89	
				20175	1732.5	22.75	21.85	
				20375	1752.5	22.88	21.89	
			13	19975	1712.5	22.79	21.94	
				20175	1732.5	22.83	21.86	
				20375	1752.5	22.88	21.86	
		25	0	19975	1712.5	22.86	21.94	
				20175	1732.5	22.71	21.85	
				20375	1752.5	22.84	21.89	
		10 MHz	1	0	20000	1715.0	23.81	23.41
					20175	1732.5	23.88	23.32
					20350	1750.0	23.84	23.46
	24			20000	1715.0	23.95	23.44	
				20175	1732.5	23.86	23.32	
				20350	1750.0	23.87	23.54	
	49			20000	1715.0	23.83	23.40	
				20175	1732.5	24.00	23.46	
				20350	1750.0	23.82	23.32	
	25			0	20000	1715.0	22.80	21.91
					20175	1732.5	22.76	21.83
					20350	1750.0	22.78	21.85
			13	20000	1715.0	22.81	21.91	
				20175	1732.5	22.82	21.88	
				20350	1750.0	22.77	21.87	
			25	20000	1715.0	22.90	21.94	
				20175	1732.5	22.87	21.90	
				20350	1750.0	22.87	21.94	
	50		0	20000	1715.0	22.88	21.84	
				20175	1732.5	22.80	21.83	
				20350	1750.0	22.81	21.86	

Band	Bandwidth	RB Size	RB Offset	Channel	Frequency	QPSK	16QAM	
4	15 MHz	1	0	20025	1717.5	23.91	23.33	
				20175	1732.5	23.87	23.32	
				20325	1747.5	23.98	23.30	
			37	20025	1717.5	23.79	23.21	
				20175	1732.5	23.76	23.15	
				20325	1747.5	23.74	23.29	
			74	20025	1717.5	23.81	23.34	
				20175	1732.5	23.80	23.23	
				20325	1747.5	23.74	23.25	
		36	0	20025	1717.5	22.83	21.91	
				20175	1732.5	22.86	21.90	
				20325	1747.5	22.85	21.88	
			19	20025	1717.5	22.90	21.90	
				20175	1732.5	22.77	21.82	
				20325	1747.5	22.86	21.87	
			39	20025	1717.5	22.87	21.86	
				20175	1732.5	22.80	21.88	
				20325	1747.5	22.78	21.86	
		75	0	20025	1717.5	22.90	21.90	
				20175	1732.5	22.82	21.86	
				20325	1747.5	22.88	21.90	
		20 MHz	1	0	20050	1720.0	23.85	23.44
					20175	1732.5	23.84	23.51
					20300	1745.0	23.90	23.48
	49				20050	1720.0	23.84	23.30
					20175	1732.5	23.75	23.20
					20300	1745.0	23.76	23.32
	99			20050	1720.0	23.90	23.30	
				20175	1732.5	23.78	23.29	
				20300	1745.0	23.71	23.23	
	50			0	20050	1720.0	22.94	21.93
					20175	1732.5	22.90	21.90
					20300	1745.0	22.85	21.89
				24	20050	1720.0	22.93	21.97
					20175	1732.5	22.77	21.84
					20300	1745.0	22.86	21.84
				50	20050	1720.0	22.82	21.91
					20175	1732.5	22.83	21.85
					20300	1745.0	22.88	21.87
	100		0	20050	1720.0	22.86	21.92	
				20175	1732.5	22.83	21.88	
				20300	1745.0	22.81	21.85	

Band	Bandwidth	RB Size	RB Offset	Channel	Frequency	QPSK	16QAM	
5	1.4 MHz	1	0	20407	824.7	23.76	23.25	
				20525	836.5	23.60	23.16	
				20643	848.3	23.62	23.12	
			3	20407	824.7	23.78	23.27	
				20525	836.5	23.70	23.26	
				20643	848.3	23.66	23.18	
			5	20407	824.7	23.70	23.24	
				20525	836.5	23.59	23.15	
				20643	848.3	23.51	23.14	
		3	0	20407	824.7	23.68	22.82	
				20525	836.5	23.52	22.77	
				20643	848.3	23.54	22.74	
			1	20407	824.7	23.72	22.87	
				20525	836.5	23.68	22.83	
				20643	848.3	23.61	22.77	
			3	20407	824.7	23.57	22.81	
				20525	836.5	23.61	22.75	
				20643	848.3	23.56	22.67	
		6	0	20407	824.7	22.72	21.91	
				20525	836.5	22.72	21.89	
				20643	848.3	22.65	21.83	
		3 MHz	1	0	20415	825.5	23.81	23.28
					20525	836.5	23.71	23.36
					20635	847.5	23.66	23.19
	7			20415	825.5	23.74	23.26	
				20525	836.5	23.83	23.28	
				20635	847.5	23.82	23.18	
	14			20415	825.5	23.65	23.19	
				20525	836.5	23.72	23.25	
				20635	847.5	23.61	23.13	
	8			0	20415	825.5	22.85	21.96
					20525	836.5	22.80	21.86
					20635	847.5	22.61	21.82
			7	20415	825.5	22.80	21.94	
				20525	836.5	22.73	21.91	
				20635	847.5	22.74	21.90	
			14	20415	825.5	22.77	21.83	
				20525	836.5	22.67	21.85	
				20635	847.5	22.68	21.75	
	15		0	20415	825.5	22.77	21.94	
				20525	836.5	22.81	21.93	
				20635	847.5	22.58	21.73	

Band	Bandwidth	RB Size	RB Offset	Channel	Frequency	QPSK	16QAM	
5	5 MHz	1	0	20425	826.5	23.85	23.36	
				20525	836.5	23.80	23.33	
				20625	846.5	23.78	23.32	
			12	20425	826.5	23.77	23.23	
				20525	836.5	23.85	23.33	
				20625	846.5	23.84	23.21	
			24	20425	826.5	23.71	23.22	
				20525	836.5	23.67	23.31	
				20625	846.5	23.68	23.19	
		12	0	20425	826.5	22.82	21.92	
				20525	836.5	22.77	21.83	
				20625	846.5	22.70	21.78	
			6	20425	826.5	22.79	21.84	
				20525	836.5	22.72	21.78	
				20625	846.5	22.68	21.73	
			13	20425	826.5	22.82	21.78	
				20525	836.5	22.79	21.79	
				20625	846.5	22.63	21.74	
		25	0	20425	826.5	22.85	21.89	
				20525	836.5	22.75	21.91	
				20625	846.5	22.67	21.77	
		10 MHz	1	0	20450	829.0	23.86	23.34
					20525	836.5	24.00	21.42
					20600	844.0	23.84	23.40
	24			20450	829.0	23.81	23.33	
				20525	836.5	23.74	23.31	
				20600	844.0	23.80	23.25	
	49			20450	829.0	23.86	23.29	
				20525	836.5	23.73	23.22	
				20600	844.0	23.80	23.12	
	25			0	20450	829.0	22.73	21.83
					20525	836.5	22.74	21.84
					20600	844.0	22.79	21.85
				13	20450	829.0	22.82	21.93
					20525	836.5	22.84	21.90
					20600	844.0	22.85	21.88
			25	20450	829.0	22.85	21.92	
				20525	836.5	22.82	21.88	
				20600	844.0	22.77	21.84	
	50		0	20450	829.0	22.86	21.89	
				20525	836.5	22.85	21.84	
				20600	844.0	22.77	21.86	

Band	Bandwidth	RB Size	RB Offset	Channel	Frequency	QPSK	16QAM
13	5 MHz	1	0	23205	779.5	23.57	23.22
				23230	782.0	23.56	23.25
				23129	784.5	23.80	23.34
			12	23205	779.5	23.68	23.34
				23230	782.0	23.94	23.26
				23129	784.5	24.00	23.35
		24	23205	779.5	23.80	23.30	
			23230	782.0	23.75	23.26	
			23129	784.5	23.85	23.38	
		12	0	23205	779.5	22.75	21.93
				23230	782.0	22.74	21.78
				23129	784.5	22.88	21.93
			6	23205	779.5	22.75	21.88
				23230	782.0	22.74	21.78
				23129	784.5	22.94	22.04
			13	23205	779.5	22.82	21.85
				23230	782.0	22.80	21.83
				23129	784.5	22.94	21.93
	25	0	23205	779.5	22.80	21.88	
			23230	782.0	22.74	21.78	
			23129	784.5	22.95	21.99	
	10 MHz	1	0	23230	782.0	23.71	23.22
			24	23230	782.0	23.76	23.23
			49	23230	782.0	23.69	23.24
		25	0	23230	782.0	22.76	21.90
			13	23230	782.0	22.80	21.87
			25	23230	782.0	22.73	21.85
		50	0	23230	782.0	22.82	21.91

Band	Bandwidth	RB Size	RB Offset	Channel	Frequency	QPSK	16QAM	
17	5 MHz	1	0	23755	706.5	23.61	23.12	
				23790	710.0	23.63	23.25	
				23824	713.5	23.61	23.24	
			12	23755	706.5	23.85	23.20	
				23790	710.0	23.88	23.34	
				23824	713.5	23.91	23.27	
			24	23755	706.5	23.72	23.25	
				23790	710.0	23.78	23.42	
				23824	713.5	23.76	23.30	
		12	0	23755	706.5	22.72	21.79	
				23790	710.0	22.71	21.80	
				23824	713.5	22.76	21.76	
			6	23755	706.5	22.75	21.78	
				23790	710.0	22.74	21.79	
				23824	713.5	22.75	21.79	
			13	23755	706.5	22.78	21.81	
				23790	710.0	22.83	21.88	
				23824	713.5	22.84	21.85	
		25	0	23755	706.5	22.73	21.78	
				23790	710.0	22.75	21.79	
				23824	713.5	22.73	21.80	
		10 MHz	1	0	23780	709.0	23.73	23.16
					23790	710.0	23.84	23.23
					23799	711.0	23.77	23.19
	24			23780	709.0	23.75	23.26	
				23790	710.0	23.84	23.39	
				23799	711.0	23.84	23.38	
	49			23780	709.0	23.91	23.31	
				23790	710.0	24.00	23.36	
				23799	711.0	23.86	23.31	
	25			0	23780	709.0	22.68	21.71
					23790	710.0	22.69	21.77
					23799	711.0	22.69	21.80
			13	23780	709.0	22.85	21.87	
				23790	710.0	22.77	21.88	
				23799	711.0	22.79	21.83	
			25	23780	709.0	22.84	21.93	
				23790	710.0	22.90	21.93	
				23799	711.0	22.92	21.97	
	50		0	23780	709.0	22.84	21.84	
				23790	710.0	22.75	21.82	
				23799	711.0	22.80	21.79	

Table 10.5.2 Test Reduction Table – LTE

Band/ Frequency (MHz)	Side	Required Test Channel	Bandwidth	Modulation	RB Allocation	RB Offset	Tested/ Reduced	
Band 2 1850-1910 MHz	Front	18700	20 MHz	QPSK	50	0	Tested	
		18900					Tested	
		19100					Tested	
		18700			100	0	Reduced ¹	
		18900					Tested	
		19100					Reduced ¹	
		18700			1	49	Tested	
		18900					Tested	
		19100					Reduced ²	
		18700			99	99	Reduced ²	
		18900					Reduced ²	
		19100					Reduced ²	
		18700			50	25	Reduced ³	
		18900					Reduced ³	
		19100					Reduced ³	
		18700			100	0	Reduced ¹	
		18900					Reduced ¹	
		19100					Reduced ¹	
		18700			1	49	Reduced ⁴	
		18900					Reduced ⁴	
		19100					Reduced ⁴	
	18700	99	99	Reduced ⁴				
	18900			Reduced ⁴				
	19100			Reduced ⁴				
	All lower bandwidths (15 MHz, 10 MHz, 5 MHz, 3 MHz, 1.4 MHz)							Reduced ⁵
	All Other Sides	All Other Sides	18700	20 MHz	QPSK	50	25	Reduced ⁷
			18900					Reduced ⁷
			19100					Reduced ⁷
			18700			100	0	Reduced ⁷
			18900					Reduced ⁷
			19100					Reduced ⁷
			18700			1	49	Reduced ⁷
			18900					Reduced ⁷
			19100					Reduced ⁷
			18700			99	99	Reduced ⁷
			18900					Reduced ⁷
			19100					Reduced ⁷
			18700			50	25	Reduced ⁷
			18900					Reduced ⁷
			19100					Reduced ⁷
			18700			100	0	Reduced ⁷
			18900					Reduced ⁷
19100			Reduced ⁷					
18700			1			49	Reduced ⁷	
18900							Reduced ⁷	
19100							Reduced ⁷	
18700	99	99	Reduced ⁷					
18900			Reduced ⁷					
19100			Reduced ⁷					
All lower bandwidths (15 MHz, 10 MHz, 5 MHz, 3 MHz, 1.4 MHz)							Reduced ⁷	

Reduced¹ – If the SAR value in the 50% RB testing is less than 3.625 W/kg, the 100% RB testing is reduced per KDB941225 D05 3)

A) I) page 4.

Reduced² - If the SAR value in the 1 RB testing is less than 3.625 W/kg, the remaining channels are reduced per KDB941225 D05 3) B) I) page 4.

Reduced³ - If the SAR value in the 50% RB testing is less than 3.625 W/kg, the remaining channels are reduced per KDB941225 D05 4) A) I) page 4.

Reduced⁴- If the SAR value in the 1 RB testing is less than 3.625 W/kg, the remaining channels are reduced per KDB941225 D05 4) B) I) page 5.

Reduced⁵- If the conducted power is within ±0.5 dB, all testing where the SAR value is less than 3.625 W/kg is reduced per KDB941225 D05 5) B) I) page 5.

Reduced⁶- If the SAR value measured on the middle channel is less than 1.0 W/kg and the conducted power is within ±0.5 dB, the remaining channels are reduced per KDB941225 D05 page 4 footnote 2.

Reduced⁷ - Reduced based on distance in KDB 447498 D01 v06 (See below calculations).

Maximum power: 316.2 mW

Closest Distance: 112 mm

$\{[(3.0)/(\sqrt{1.91})]^2 * 50 \text{ mm}\} + \{[316 - 50 \text{ mm}]^2 * 10\} = 728 \text{ mW}$ which is greater than 316.2 mW

Band/ Frequency (MHz)	Side	Required Test Channel	Bandwidth	Modulation	RB Allocation	RB Offset	Tested/ Reduced	
Band 4 1710-1755 MHz	Front	20050	20 MHz	QPSK	50	25	Tested	
		20175					Tested	
		20300					Tested	
		20050			100	0	Reduced ¹	
		20175					Reduced ¹	
		20300					Tested	
		20050			1	49	Tested	
		20175					Tested	
		20300					Tested	
		20050					99	Reduced ²
		20175						Reduced ²
		20300						Reduced ²
		20050		50	25	Reduced ³		
		20175				Reduced ³		
		20300				Reduced ³		
		20050				100	0	Reduced ¹
		20175						Reduced ¹
		20300						Reduced ¹
		20050		1	49	Reduced ⁴		
		20175				Reduced ⁴		
		20300				Reduced ⁴		
		20050				99	Reduced ⁴	
		20175					Reduced ⁴	
		20300					Reduced ⁴	
	All lower bandwidths (15 MHz, 10 MHz, 5 MHz, 3 MHz, 1.4 MHz)							Reduced ⁵
	All Other Sides	QPSK	20050	20 MHz	50	25	Reduced ⁷	
			20175				Reduced ⁷	
			20300				Reduced ⁷	
			20050		100	0	Reduced ⁷	
			20175				Reduced ⁷	
			20300				Reduced ⁷	
			20050		1	49	Reduced ⁷	
			20175				Reduced ⁷	
			20300				Reduced ⁷	
			20050				99	Reduced ⁷
			20175					Reduced ⁷
			20300					Reduced ⁷
		20050	50		25	Reduced ⁷		
		20175				Reduced ⁷		
		20300				Reduced ⁷		
		20050				100	0	Reduced ⁷
		20175						Reduced ⁷
		20300						Reduced ⁷
		20050	1		49	Reduced ⁷		
		20175				Reduced ⁷		
		20300				Reduced ⁷		
		20050				99	Reduced ⁷	
		20175					Reduced ⁷	
20300		Reduced ⁷						
All lower bandwidths (15 MHz, 10 MHz, 5 MHz, 3 MHz, 1.4 MHz)							Reduced ⁷	

Reduced¹ – If the SAR value in the 50% RB testing is less than 3.625 W/kg, the 100% RB testing is reduced per KDB941225 D05 3) A) I) page 4.
 Reduced² - If the SAR value in the 1 RB testing is less than 3.625 W/kg, the remaining channels are reduced per KDB941225 D05 3) B) I) page 4.
 Reduced³ - If the SAR value in the 50% RB testing is less than 3.625 W/kg, the remaining channels are reduced per KDB941225 D05 4) A) I) page 4.
 Reduced⁴ - If the SAR value in the 1 RB testing is less than 3.625 W/kg, the remaining channels are reduced per KDB941225 D05 4) B) I) page 5.
 Reduced⁵ - If the conducted power is within ±0.5 dB, all testing where the SAR value is less than 3.625 W/kg is reduced per KDB941225 D05 5) B) I) page 5.
 Reduced⁶ - If the SAR value measured on the middle channel is less than 1.0 W/kg and the conducted power is within ±0.5 dB, the remaining channels are reduced per KDB941225 D05 page 4 footnote 2.
 Reduced⁷ - Reduced based on distance in KDB 447498 D01 v06 (See below calculations).

Maximum power: 316.2 mW
 Closest Distance: 112 mm

$$[{\{(3.0)/(\sqrt{1.755})\}^2 * 50 \text{ mm}}] + [112 - 50 \text{ mm}]^2 * 10 = 733 \text{ mW which is greater than } 316.2 \text{ mW}$$

Band/ Frequency (MHz)	Side	Required Test Channel	Bandwidth	Modulation	RB Allocation	RB Offset	Tested/ Reduced	
Band 5 824-849 MHz	Front	20450	10 MHz	QPSK	25	12	Reduced ⁶	
		20525					Tested	
		20600					Reduced ⁶	
		20450			50	0	Reduced ¹	
		20525					Reduced ¹	
		20600					Reduced ¹	
		20450			1	24	Tested	
		20525					Tested	
		20600					Tested	
		20450			49	49	Reduced ²	
		20525					Reduced ²	
		20600					Reduced ²	
		20450		25	12	Reduced ³		
		20525				Reduced ³		
		20600				Reduced ³		
		20450		50	0	Reduced ¹		
		20525				Reduced ¹		
		20600				Reduced ¹		
		20450		1	24	Reduced ⁴		
		20525				Reduced ⁴		
		20600				Reduced ⁴		
		20450		49	49	Reduced ⁴		
		20525				Reduced ⁴		
		20600				Reduced ⁴		
	All lower bandwidths (5 MHz)							Reduced ⁵
	All Other Sides		20450	10 MHz	QPSK	25	12	Reduced ⁷
			20525					Reduced ⁷
			20600					Reduced ⁷
			20450			50	0	Reduced ⁷
			20525					Reduced ⁷
			20600					Reduced ⁷
			20450			1	24	Reduced ⁷
			20525					Reduced ⁷
			20600					Reduced ⁷
			20450			49	49	Reduced ⁷
			20525					Reduced ⁷
			20600					Reduced ⁷
			20450		25	12	Reduced ⁷	
			20525				Reduced ⁷	
			20600				Reduced ⁷	
			20450		50	0	Reduced ⁷	
			20525				Reduced ⁷	
			20600				Reduced ⁷	
			20450		1	24	Reduced ⁷	
			20525				Reduced ⁷	
			20600				Reduced ⁷	
			20450		49	49	Reduced ⁷	
			20525				Reduced ⁷	
20600			Reduced ⁷					
All lower bandwidths (5 MHz)							Reduced ⁷	

- Reduced¹ – If the SAR value in the 50% RB testing is less than 3.625 W/kg, the 100% RB testing is reduced per KDB941225 D05 3) A) I) page 4.
- Reduced² - If the SAR value in the 1 RB testing is less than 3.625 W/kg, the remaining channels are reduced per KDB941225 D05 3) B) I) page 4.
- Reduced³ - If the SAR value in the 50% RB testing is less than 3.625 W/kg, the remaining channels are reduced per KDB941225 D05 4) A) I) page 4.
- Reduced⁴ - If the SAR value in the 1 RB testing is less than 3.625 W/kg, the remaining channels are reduced per KDB941225 D05 4) B) I) page 5.
- Reduced⁵- If the conducted power is within ±0.5 dB, all testing where the SAR value is less than 3.625 W/kg is reduced per KDB941225 D05 5) B) I) page 5.
- Reduced⁶- If the SAR value measured on the middle channel is less than 1.0 W/kg and the conducted power is within ±0.5 dB, the remaining channels are reduced per KDB941225 D05 page 4 footnote 2.
- Reduced⁷ - Reduced based on distance in KDB 447498 D01 v06 (See below calculations).

Maximum power: 316.2 mW
Closest Distance: 112 mm

$$[[(3.0)/(\sqrt{0.849})]*50 \text{ mm}]+[112-50 \text{ mm}]*10]=782 \text{ mW which is greater than 316.2 mW}$$

Band/ Frequency (MHz)	Side	Required Test Channel	Bandwidth	Modulation	RB Allocation	RB Offset	Tested/ Reduced	
Band 13 777-787 MHz	Front	23230	10 MHz	QPSK	25	12	Tested	
		23230			50	0	Reduced ¹	
		23230			1	24	Tested	
		23230				49	Reduced ²	
		23230		16QAM	25	12	Reduced ³	
		23230			50	0	Reduced ¹	
		23230			1	24	Reduced ⁴	
		23230				49	Reduced ⁴	
	All lower bandwidths (5 MHz)							Reduced ⁵
	All Other Sides	10 MHz	23230	QPSK	25	12	Reduced ⁷	
			23230		50	0	Reduced ⁷	
			23230		1	24	Reduced ⁷	
			23230			49	Reduced ⁷	
			23230	16QAM	25	12	Reduced ⁷	
			23230		50	0	Reduced ⁷	
			23230		1	24	Reduced ⁷	
			23230			49	Reduced ⁷	
	All lower bandwidths (5 MHz)							Reduced ⁷

Reduced¹ – If the SAR value in the 50% RB testing is less than 3.625 W/kg, the 100% RB testing is reduced per KDB941225 D05 3) A) I) page 4.

Reduced² - If the SAR value in the 1 RB testing is less than 3.625 W/kg, the remaining channels are reduced per KDB941225 D05 3) B) I) page 4.

Reduced³ - If the SAR value in the 50% RB testing is less than 3.625 W/kg, the remaining channels are reduced per KDB941225 D05 4) A) I) page 4.

Reduced⁴- If the SAR value in the 1 RB testing is less than 3.625 W/kg, the remaining channels are reduced per KDB941225 D05 4) B) I) page 5.

Reduced⁵- If the conducted power is within ±0.5 dB, all testing where the SAR value is less than 3.625 W/kg is reduced per KDB941225 D05 5) B) I) page 5.

Reduced⁶- If the SAR value measured on the middle channel is less than 1.0 W/kg and the conducted power is within ±0.5 dB, the remaining channels are reduced per KDB941225 D05 page 4 footnote 2.

Reduced⁷ - Reduced based on distance in KDB 447498 D01 v06 (See below calculations).

Maximum power: 316.2 mW

Closest Distance: 112 mm

$[(3.0/(\sqrt{0.787}) * 50 \text{ mm})] + [(112 - 50 \text{ mm}) * 10] = 789 \text{ mW}$ which is greater than 316.2 mW

Band/ Frequency (MHz)	Side	Required Test Channel	Bandwidth	Modulation	RB Allocation	RB Offset	Tested/ Reduced	
Band 17 704-716 MHz	Front	23780	10 MHz	QPSK	25	12	Reduced ⁶	
		23790					Tested	
		23799					Reduced ⁶	
		23780			50	0	Reduced ¹	
		23790					Tested	
		23799					Reduced ¹	
		23780			1	24	Tested	
		23790					Tested	
		23799					Reduced ²	
		23780			49	24	Reduced ²	
		23790					Reduced ²	
		23799					Reduced ²	
		23780			25	12	Reduced ³	
		23790					Reduced ³	
		23799					Reduced ³	
		23780			50	0	Reduced ¹	
		23790					Reduced ¹	
		23799					Reduced ¹	
		23780			1	24	Reduced ⁴	
		23790					Reduced ⁴	
		23799					Reduced ⁴	
	23780	49	24	Reduced ⁴				
	23790			Reduced ⁴				
	23799			Reduced ⁴				
	All lower bandwidths (5 MHz)							Reduced ⁵
	All Other Sided	All Other Sided	23780	10 MHz	QPSK	25	12	Reduced ⁷
			23790					Reduced ⁷
			23799					Reduced ⁷
			23780			50	0	Reduced ⁷
			23790					Reduced ⁷
			23799					Reduced ⁷
			23780			1	24	Reduced ⁷
			23790					Reduced ⁷
			23799					Reduced ⁷
			23780			49	24	Reduced ⁷
			23790					Reduced ⁷
			23799					Reduced ⁷
			23780			25	12	Reduced ⁷
			23790					Reduced ⁷
			23799					Reduced ⁷
			23780			50	0	Reduced ⁷
			23790					Reduced ⁷
23799			Reduced ⁷					
23780			1			24	Reduced ⁷	
23790							Reduced ⁷	
23799							Reduced ⁷	
23780	49	24	Reduced ⁷					
23790			Reduced ⁷					
23799			Reduced ⁷					
All lower bandwidths (5 MHz)							Reduced ⁷	

- Reduced¹ - If the SAR value in the 50% RB testing is less than 3.625 W/kg, the 100% RB testing is reduced per KDB941225 D05 3) A) I) page 4.
- Reduced² - If the SAR value in the 1 RB testing is less than 3.625 W/kg, the remaining channels are reduced per KDB941225 D05 3) B) I) page 4.
- Reduced³ - If the SAR value in the 50% RB testing is less than 3.625 W/kg, the remaining channels are reduced per KDB941225 D05 4) A) I) page 4.
- Reduced⁴ - If the SAR value in the 1 RB testing is less than 3.625 W/kg, the remaining channels are reduced per KDB941225 D05 4) B) I) page 5.
- Reduced⁵ - If the conducted power is within ±0.5 dB, all testing where the SAR value is less than 3.625 W/kg is reduced per KDB941225 D05 5) B) I) page 5.
- Reduced⁶ - If the SAR value measured on the middle channel is less than 1.0 W/kg and the conducted power is within ±0.5 dB, the remaining channels are reduced per KDB941225 D05 page 4 footnote 2.
- Reduced⁷ - Reduced based on distance in KDB 447498 D01 v06 (See below calculations).

Maximum power: 316.2 mW
Closest Distance: 112 mm

$$[[(3.0)/(\sqrt{0.716})]*50 \text{ mm}]+[112-50 \text{ mm}]*10]=797 \text{ mW which is greater than 316.2 mW}$$

SAR Data Summary – 750 MHz Body – LTE Band 17

MEASUREMENT RESULTS											
Gap	Plot	Position	Frequency		BW/ Modulation	RB Size	RB Offset	MPR Target	End Power (dBm)	Measured SAR (W/kg)	Reported SAR (W/kg)
			MHz	Ch.							
0 mm	-----	Front	709	23780	10 MHz/QPSK	1	24	0	23.75	0.903	1.20
	1		710	23790	10 MHz/QPSK	1	24	0	23.84	0.920	1.20
	-----		711	23800	10 MHz/QPSK	1	24	0	23.84	0.919	1.20
	-----		710	23790	10 MHz/QPSK	25	13	1	22.77	0.740	0.98
	-----		710	23790	10 MHz/QPSK	50	0	1	22.75	0.591	0.79
	-----	Repeat	710	23790	10 MHz/QPSK	1	24	0	23.84	0.915	1.20

Extremity
4.0 W/kg (mW/g)
 averaged over 10 gram

1. Battery is fully charged for all tests.
 Power Measured Conducted ERP EIRP
2. SAR Measurement
 Phantom Configuration Left Head Eli5 Right Head
 SAR Configuration Head Body
3. Test Signal Call Mode Test Code Base Station Simulator
4. Test Configuration With Belt Clip Without Belt Clip N/A
5. Tissue Depth is at least 15.0 cm



Jay M. Moulton
Vice President

SAR Data Summary – 750 MHz Body – LTE Band 13

MEASUREMENT RESULTS											
Gap	Plot	Position	Frequency		BW/ Modulation	RB Size	RB Offset	MPR Target	End Power (dBm)	Measured SAR (W/kg)	Reported SAR (W/kg)
			MHz	Ch.							
0 mm	2	Front	782.0	23230	10 MHz/QPSK	1	24	0	23.76	0.472	0.63
	-----		782.0	23230	10 MHz/QPSK	25	13	1	22.80	0.385	0.51
Extremity 4.0 W/kg (mW/g) averaged over 10 gram											

1. Battery is fully charged for all tests.
 Power Measured Conducted ERP EIRP
2. SAR Measurement
 Phantom Configuration Left Head Eli5 Right Head
 SAR Configuration Head Body
3. Test Signal Call Mode Test Code Base Station Simulator
4. Test Configuration With Belt Clip Without Belt Clip N/A
5. Tissue Depth is at least 15.0 cm

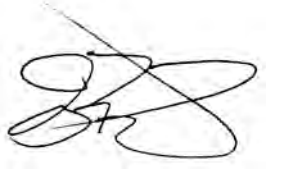

Jay M. Moulton
Vice President

SAR Data Summary – 835 MHz Body - WCDMA
MEASUREMENT RESULTS

Gap	Plot	Frequency		Modulation	Position	End Power (dBm)	RMC	Test Set Up	Measured SAR (W/kg)	Reported SAR (W/kg)
		MHz	Ch.							
0 mm	----	826.4	4132	WCDMA	Front	23.49	12.2 kbps	Test Loop 1	0.795	1.13
	----	836.6	4183	WCDMA		23.44	12.2 kbps	Test Loop 1	0.813	1.16
	3	846.4	4233	WCDMA		23.70	12.2 kbps	Test Loop 1	0.881	1.19
	----	846.4	4233	WCDMA	Repeat	23.70	12.2 kbps	Test Loop 1	0.872	1.18

Extremity
4.0 W/kg (mW/g)
 averaged over 10 gram

1. Battery is fully charged for all tests.
 Power Measured Conducted ERP EIRP
2. SAR Measurement
 Phantom Configuration Left Head Eli5 Right Head
 SAR Configuration Head Body
3. Test Signal Call Mode Test Code Base Station Simulator
4. Test Configuration With Belt Clip Without Belt Clip N/A
5. Tissue Depth is at least 15.0 cm



Jay M. Moulton
 Vice President

SAR Data Summary – 835 MHz Body – LTE Band 5

MEASUREMENT RESULTS											
Gap	Plot	Position	Frequency		BW/ Modulation	RB Size	RB Offset	MPR Target	End Power (dBm)	Measured SAR (W/kg)	Reported SAR (W/kg)
			MHz	Ch.							
0 mm	----	Front	829.0	20450	10 MHz/QPSK	1	24	0	23.81	0.629	0.83
	----		836.5	20525	10 MHz/QPSK	1	24	0	23.74	0.685	0.92
	4		844.0	20600	10 MHz/QPSK	1	24	0	23.80	0.720	0.95
	----		836.5	20525	10 MHz/QPSK	25	13	1	22.84	0.548	0.72
Extremity 4.0 W/kg (mW/g) averaged over 10 gram											

1. Battery is fully charged for all tests.
 Power Measured Conducted ERP EIRP
2. SAR Measurement
 Phantom Configuration Left Head Eli5 Right Head
 SAR Configuration Head Body
3. Test Signal Call Mode Test Code Base Station Simulator
4. Test Configuration With Belt Clip Without Belt Clip N/A
5. Tissue Depth is at least 15.0 cm



Jay M. Moulton
Vice President

SAR Data Summary – 1750 MHz Body – LTE Band 4

MEASUREMENT RESULTS											
Gap	Plot	Position	Frequency		BW/ Modulation	RB Size	RB Offset	MPR Target	End Power (dBm)	Measured SAR (W/kg)	Reported SAR (W/kg)
			MHz	Ch.							
0 mm	-----	Front	1720.0	20050	20 MHz/QPSK	1	49	0	23.84	2.64	3.45
	-----		1732.5	20175	20 MHz/QPSK	1	49	0	23.75	2.69	3.59
	5		1745.0	20300	20 MHz/QPSK	1	49	0	23.76	2.86	3.81
	-----		1720.0	20050	20 MHz/QPSK	50	24	1	22.93	2.23	2.85
	-----		1732.5	20175	20 MHz/QPSK	50	24	1	22.77	2.26	3.00
	-----		1745.0	20300	20 MHz/QPSK	50	24	1	22.86	2.34	3.04
	-----		1745.0	20300	20 MHz/QPSK	100	0	1	22.81	1.85	2.43
	-----	Repeat	1745.0	20300	20 MHz/QPSK	1	49	0	23.76	2.84	3.78

Extremity
4.0 W/kg (mW/g)
averaged over 10 gram

1. Battery is fully charged for all tests.
Power Measured Conducted ERP EIRP
2. SAR Measurement
Phantom Configuration Left Head Eli5 Right Head
SAR Configuration Head Body
3. Test Signal Call Mode Test Code Base Station Simulator
4. Test Configuration With Belt Clip Without Belt Clip N/A
5. Tissue Depth is at least 15.0 cm



Jay M. Moulton
Vice President

SAR Data Summary – 1900 MHz Body - WCDMA

MEASUREMENT RESULTS

Gap	Plot	Frequency		Rev Level/ Modulation	Position	End Power (dBm)	RMC	Test Set Up	Measured SAR (W/kg)	Reported SAR (W/kg)
		MHz	Ch.							
0 mm	----	1852.4	9262	WCDMA	Front	24.79	12.2 kbps	Test Loop 1	3.36	3.53
	6	1880.0	9400	WCDMA		24.81	12.2 kbps	Test Loop 1	3.48	3.64
	----	1907.6	9538	WCDMA		24.82	12.2 kbps	Test Loop 1	3.48	3.63
	----	1852.4	9262	WCDMA	Repeat	24.81	12.2 kbps	Test Loop 1	3.46	3.62

Extremity
1.6 W/kg (mW/g)
averaged over 10 gram

- Battery is fully charged for all tests.
 Power Measured Conducted ERP EIRP
- SAR Measurement
 Phantom Configuration Left Head Eli5 Right Head
 SAR Configuration Head Body
- Test Signal Call Mode Test Code Base Station Simulator
- Test Configuration With Belt Clip Without Belt Clip N/A
- Tissue Depth is at least 15.0 cm



Jay M. Moulton
 Vice President

SAR Data Summary – 1900 MHz Body – LTE Band 2

MEASUREMENT RESULTS

Gap	Plot	Position	Frequency		BW/ Modulation	RB Size	RB Offset	MPR Target	End Power (dBm)	Measured SAR (W/kg)	Reported SAR (W/kg)
			MHz	Ch.							
0 mm	----	Front	1860	18700	20 MHz/QPSK	1	49	0	23.88	2.54	3.29
	7		1880	18900	20 MHz/QPSK	1	49	0	23.88	2.82	3.65
	----		1900	19100	20 MHz/QPSK	1	49	0	23.76	2.42	3.22
	----		1860	18700	20 MHz/QPSK	50	24	1	22.88	2.23	2.89
	----		1880	18900	20 MHz/QPSK	50	24	1	22.89	2.34	3.02
	----		1900	19100	20 MHz/QPSK	50	24	1	22.80	2.30	3.03
	----		1880	18900	20 MHz/QPSK	100	0	1	22.86	1.76	2.29
	----	Repeat	1880	18900	20 MHz/QPSK	1	49	0	23.88	2.80	3.62

Extremity
4.0 W/kg (mW/g)
averaged over 10 gram

1. Battery is fully charged for all tests.
Power Measured Conducted ERP EIRP
2. SAR Measurement
Phantom Configuration Left Head Eli5 Right Head
SAR Configuration Head Body
3. Test Signal Call Mode Test Code Base Station Simulator
4. Test Configuration With Belt Clip Without Belt Clip N/A
5. Tissue Depth is at least 15.0 cm



Jay M. Moulton
Vice President

SAR Data Summary – 2450 MHz Body 802.11b

MEASUREMENT RESULTS

Gap	Plot	Position	Frequency		Modulation	Antenna	End Power	Measured SAR (W/kg)	Reported SAR (W/kg)
			MHz	Ch.			(dBm)		
0 mm	8	Front	2437	6	DSSS	Tx0	17.30	0.0364	0.04
	-----		2437	6	DSSS	Tx1	17.30	0.0211	0.02

Extremity
4.0 W/kg (mW/g)
 averaged over 10 gram

1. Battery is fully charged for all tests.
 Power Measured Conducted ERP EIRP
2. SAR Measurement
 Phantom Configuration Left Head Eli5 Right Head
 SAR Configuration Head Body
3. Test Signal Call Mode Test Code Base Station Simulator
4. Test Configuration With Belt Clip Without Belt Clip N/A
5. Tissue Depth is at least 15.0 cm



Jay M. Moulton
 Vice President

SAR Data Summary – Simultaneous Transmit (Worst Case) WWAN – WiFi (Tx0)

MEASUREMENT RESULTS								
Side	Frequency (WLAN)		Frequency (WWAN)		WWAN Technology	SAR (W/kg) WLAN	SAR (W/kg) WWAN	Total SAR (W/kg)
	MHz	Ch.	MHz	Ch.				
Front	2437	6	1745.0	20300	LTE Band 4	0.04	3.81	3.85
						Extremity 4.0 W/kg (mW/g) averaged over 10 gram		

SAR Data Summary – Simultaneous Transmit (Worst Case) WWAN – WiFi (Tx1)

MEASUREMENT RESULTS								
Side	Frequency (WLAN)		Frequency (WWAN)		WWAN Technology	SAR (W/kg) WLAN	SAR (W/kg) WWAN	Total SAR (W/kg)
	MHz	Ch.	MHz	Ch.				
Front	2437	6	1745.0	20300	LTE Band 4	0.02	3.81	3.83
						Extremity 4.0 W/kg (mW/g) averaged over 10 gram		

Carrier Aggregation Evaluation

MIMO

This device only supports LTE downlink 2x2 MIMO. Per Fall 2017 TCB Workshop Notes, SAR for LTE MIMO operations was not needed since the maximum average output power in LTE MIMO mode was not >0.25 dB higher than the maximum output power when MIMO is inactive. See Appendix H for conducted power data.

11. Test Equipment List

Table 11.1 Equipment Specifications

Type	Calibration Due Date	Calibration Done Date	Serial Number
Staubli Robot TX60L	N/A	N/A	F07/55M6A1/A/01
Measurement Controller CS8c	N/A	N/A	1012
ELI5 Flat Phantom	N/A	N/A	1251
Device Holder	N/A	N/A	N/A
Data Acquisition Electronics 4	08/18/2021	08/18/2020	759
SPEAG E-Field Probe EX3DV4	07/14/2021	07/14/2020	7531
Speag Validation Dipole D750V2	07/13/2021	07/13/2018	1016
Speag Validation Dipole D835V2	07/13/2021	07/13/2018	4d089
Speag Validation Dipole D1750V2	07/20/2021	07/20/2018	1018
Speag Validation Dipole D1900V2	07/13/2021	07/13/2018	5d116
Speag Validation Dipole D2450V2	07/12/2021	07/12/2018	829
Agilent N1911A Power Meter	04/27/2021	04/27/2020	GB45100254
Agilent N1922A Power Sensor	04/27/2021	04/27/2020	MY45240464
Advantest R3261A Spectrum Analyzer	03/16/2021	03/16/2020	31720068
Agilent (HP) 8350B Signal Generator	03/16/2021	03/16/2020	2749A10226
Agilent (HP) 83525A RF Plug-In	03/16/2021	03/16/2020	2647A01172
Agilent (HP) 8753C Vector Network Analyzer	03/16/2021	03/16/2020	3135A01724
Agilent (HP) 85047A S-Parameter Test Set	03/17/2021	03/17/2020	2904A00595
Agilent (HP) 8960 Base Station Sim.	05/31/2021	05/31/2020	MY48360364
Anritsu MT8820C	04/27/2021	04/27/2020	6201176199
Agilent 778D Dual Directional Coupler	N/A	N/A	MY48220184
MiniCircuits BW-N20W5+ Fixed 20 dB Attenuator	N/A	N/A	N/A
MiniCircuits SPL-10.7+ Low Pass Filter	N/A	N/A	R8979513746
Aprel Dielectric Probe Assembly	N/A	N/A	0011
Head Equivalent Matter (750 MHz)	N/A	N/A	N/A
Head Equivalent Matter (835 MHz)	N/A	N/A	N/A
Head Equivalent Matter (1750 MHz)	N/A	N/A	N/A
Head Equivalent Matter (1900 MHz)	N/A	N/A	N/A
Head Equivalent Matter (2450 MHz)	N/A	N/A	N/A

12. Conclusion

The SAR measurement indicates that the EUT complies with the RF radiation exposure limits of the FCC. These measurements are taken to simulate the RF effects exposure under worst-case conditions. Precise laboratory measures were taken to assure repeatability of the tests. The tested device complies with the requirements in respect to all parameters subject to the test. The test results and statements relate only to the item(s) tested.

Please note that the absorption and distribution of electromagnetic energy in the body is a very complex phenomena that depends on the mass, shape, and size of the body; the orientation of the body with respect to the field vectors; and, the electrical properties of both the body and the environment. Other variables that may play a substantial role in possible biological effects are those that characterize the environment (e.g. ambient temperature, air velocity, relative humidity, and body insulation) and those that characterize the individual (e.g. age, gender, activity level, debilitation, or disease). Because innumerable factors may interact to determine the specific biological outcome of an exposure to electromagnetic fields, any protection guide shall consider maximal amplification of biological effects as a result of field-body interactions, environmental conditions, and physiological variables.

13. References

- [1] Federal Communications Commission, ET Docket 93-62, Guidelines for Evaluating the Environmental Effects of Radio Frequency Radiation, August 1996
- [2] ANSI/IEEE C95.1 – 1992, American National Standard Safety Levels with respect to Human Exposure to Radio Frequency Electromagnetic Fields, 300kHz to 100GHz, New York: IEEE, 1992.
- [3] ANSI/IEEE C95.3 – 2002, IEEE Recommended Practice for the Measurement of Potentially Hazardous Electromagnetic Fields – RF and Microwave, New York: IEEE, 2002.
- [4] International Electrotechnical Commission, IEC 62209-2 (Edition 1.0), Human Exposure to radio frequency fields from hand-held and body mounted wireless communication devices – Human models, instrumentation, and procedures – Part 2: Procedure to determine the specific absorption rate (SAR) for wireless communication devices used in close proximity to the human body (frequency range of 30 MHz to 6 GHz), March 2010.
- [5] IEEE Standard 1528 – 2013, IEEE Recommended Practice for Determining the Peak-Spatial Average Specific Absorption Rate (SAR) in the Human Head from Wireless Communication Devices: Measurement Techniques, June 2013.
- [6] Industry Canada, RSS – 102 Issue 5, Radio Frequency Exposure Compliance of Radiocommunication Apparatus (All Frequency Bands), March 2015.
- [7] Health Canada, Safety Code 6, Limits of Human Exposure to Radiofrequency Electromagnetic Fields in the Frequency Range from 3kHz to 300 GHz, 2009.

Appendix A – System Validation Plots and Data

Test Result for UIM Dielectric Parameter

Tue 25/Aug/2020

Freq Frequency(GHz)

FCC_eH Limits for Head Epsilon

FCC_sH Limits for Head Sigma

Test_e Epsilon of UIM

Test_s Sigma of UIM

Freq	FCC_eH	FCC_sH	Test_e	Test_s
0.7000	42.20	0.89	41.85	0.89
0.7090	42.155	0.89	41.787	0.899*
0.7100	42.15	0.89	41.78	0.90
0.7110	42.145	0.89	41.775	0.901*
0.7200	42.10	0.89	41.73	0.91
0.7300	42.05	0.89	41.66	0.91
0.7400	41.99	0.89	41.60	0.91
0.7500	41.94	0.89	41.55	0.91
0.7600	41.89	0.89	41.49	0.92
0.7700	41.84	0.89	41.43	0.92
0.7800	41.79	0.90	41.37	0.92
0.7820	41.778	0.90	41.358	0.922*
0.7900	41.73	0.90	41.31	0.93
0.8000	41.68	0.90	41.27	0.93

* value interpolated

Test Result for UIM Dielectric Parameter

Mon 24/Aug/2020

Freq Frequency(GHz)

eH Limits for Head Epsilon

sH Limits for Head Sigma

Test_e Epsilon of UIM

Test_s Sigma of UIM

Freq	eH	sH	Test_e	Test_s
0.8000	41.68	0.90	41.31	0.92
0.8100	41.63	0.90	41.26	0.93
0.8200	41.58	0.90	41.2	0.94
0.8264	41.548	0.90	41.232	0.94*
0.8290	41.535	0.90	41.245	0.94*
0.8300	41.53	0.90	41.25	0.94
0.8350	41.515	0.905	41.235	0.945*
0.8365	41.511	0.907	41.231	0.947*
0.8366	41.51	0.907	41.23	0.947*
0.8400	41.50	0.91	41.22	0.95
0.8440	41.50	0.914	41.212	0.954*
0.8466	41.50	0.917	41.207	0.957*
0.8500	41.50	0.92	41.2	0.96
0.8600	41.50	0.93	41.18	0.97
0.8700	41.50	0.94	41.17	0.98

* value interpolated

Test Result for UIM Dielectric Parameter

Mon 24/Aug/2020

Freq Frequency(GHz)

eH Limits for Head Epsilon

sH Limits for Head Sigma

Test_e Epsilon of UIM

Test_s Sigma of UIM

Freq	eH	sH	Test_e	Test_s
1.7000	40.16	1.34	39.73	1.38
1.7100	40.14	1.35	39.71	1.39
1.7200	40.13	1.35	39.69	1.40
1.7300	40.11	1.36	39.67	1.40
1.7325	40.105	1.363	39.665	1.403*
1.7400	40.09	1.37	39.65	1.41
1.7450	40.085	1.37	39.64	1.415*
1.7500	40.08	1.37	39.63	1.42
1.7600	40.06	1.38	39.61	1.43
1.7700	40.05	1.38	39.59	1.44
1.7800	40.03	1.39	39.57	1.44
1.7900	40.02	1.39	39.55	1.45

* value interpolated

Test Result for UIM Dielectric Parameter

Mon 24/Aug/2020

Freq Frequency(GHz)

FCC_eH Limits for Head Epsilon

FCC_sH Limits for Head Sigma

Test_e Epsilon of UIM

Test_s Sigma of UIM

Freq	FCC_eH	FCC_sH	Test_e	Test_s
1.8500	40.00	1.40	39.52	1.41
1.8524	40.00	1.40	39.515	1.412*
1.8600	40.00	1.40	39.50	1.42
1.8700	40.00	1.40	39.48	1.43
1.8800	40.00	1.40	39.47	1.44
1.8900	40.00	1.40	39.46	1.44
1.9000	40.00	1.40	39.46	1.46
1.9076	40.00	1.40	39.445	1.468*
1.9100	40.00	1.40	39.44	1.47

*value interpolated

Test Result for UIM Dielectric Parameter

Thu 03/Sep/2020

Freq Frequency(GHz)

FCC_eH Limits for Head Epsilon

FCC_sH Limits for Head Sigma

Test_e Epsilon of UIM

Test_s Sigma of UIM

Freq	FCC_eH	FCC_sH	Test_e	Test_s
2.4100	39.26	1.76	38.70	1.78
2.4120	39.258	1.762	38.696	1.782*
2.4200	39.25	1.77	38.68	1.79
2.4300	39.24	1.78	38.66	1.80
2.4370	39.226	1.787	38.653	1.814*
2.4400	39.22	1.79	38.65	1.82
2.4500	39.20	1.80	38.60	1.83
2.4600	39.19	1.81	38.60	1.84
2.4620	39.186	1.812	38.596	1.842*
2.4700	39.17	1.82	38.58	1.85
2.4800	39.16	1.83	38.56	1.88

* value interpolated

RF Exposure Lab

Plot 1

DUT: Dipole 750 MHz D750V3; Type: D750V3; Serial: D750V3 - SN 1016

Communication System: CW; Frequency: 750 MHz; Duty Cycle: 1:1
 Medium: HSL750; Medium parameters used (interpolated): $f = 750$ MHz; $\sigma = 0.91$ S/m; $\epsilon_r = 41.55$; $\rho = 1000$ kg/m³
 Phantom section: Flat Section

Test Date: Date: 8/25/2020; Ambient Temp: 23 °C; Tissue Temp: 21 °C

Probe: EX3DV4 – SN7531; ConvF(10.64, 10.64, 10.64); Calibrated: 7/14/2020;
 Sensor-Surface: 2mm (Mechanical Surface Detection)
 Electronics: DAE4 Sn759; Calibrated: 8/18/2020
 Phantom: ELI v5.0; Type: QDOVA002AA; Serial: 1251
 Measurement SW: DASY52, Version 52.10 (0); SEMCAD X Version 14.6.10 (7417)

Procedure Notes:

750 MHz Head/Verification/Area Scan (41x121x1): Interpolated grid: $dx=1.500$ mm, $dy=1.500$ mm
 Maximum value of SAR (interpolated) = 0.752 W/kg

750 MHz Head/Verification /Zoom Scan (5x5x7)/Cube 0: Measurement grid: $dx=8$ mm, $dy=8$ mm, $dz=5$ mm
 Reference Value = 35.839 V/m; Power Drift = -0.02 dB
 Peak SAR (extrapolated) = 1.693 mW/g
 $P_{in} = 100$ mW
SAR(1 g) = 0.826 mW/g; SAR(10 g) = 0.535 mW/g
 Maximum value of SAR (measured) = 0.883 W/kg

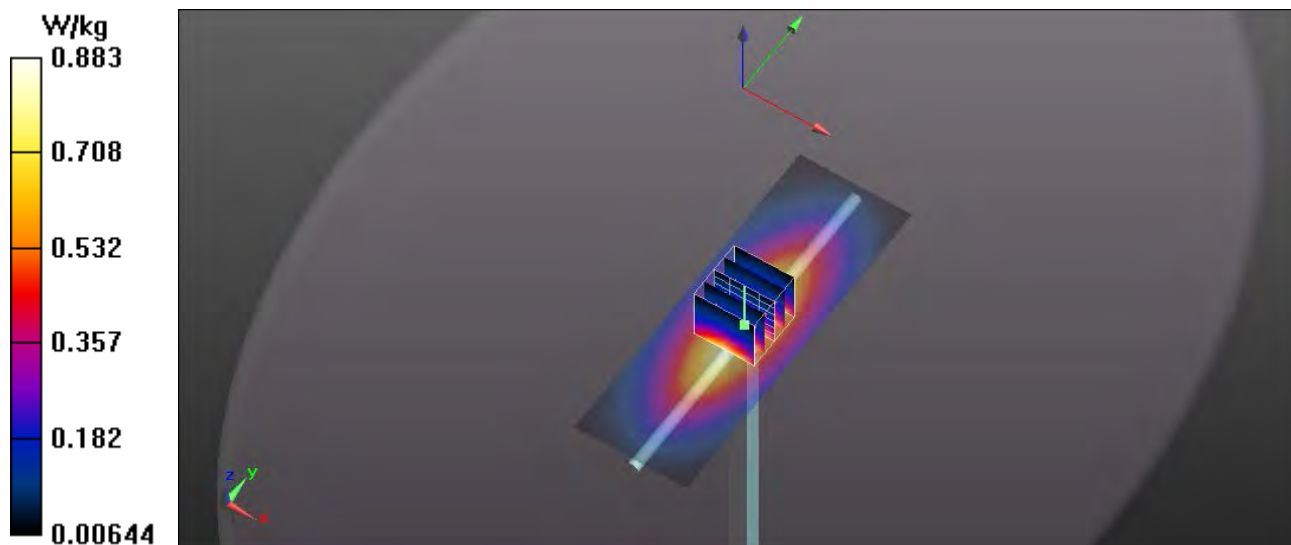

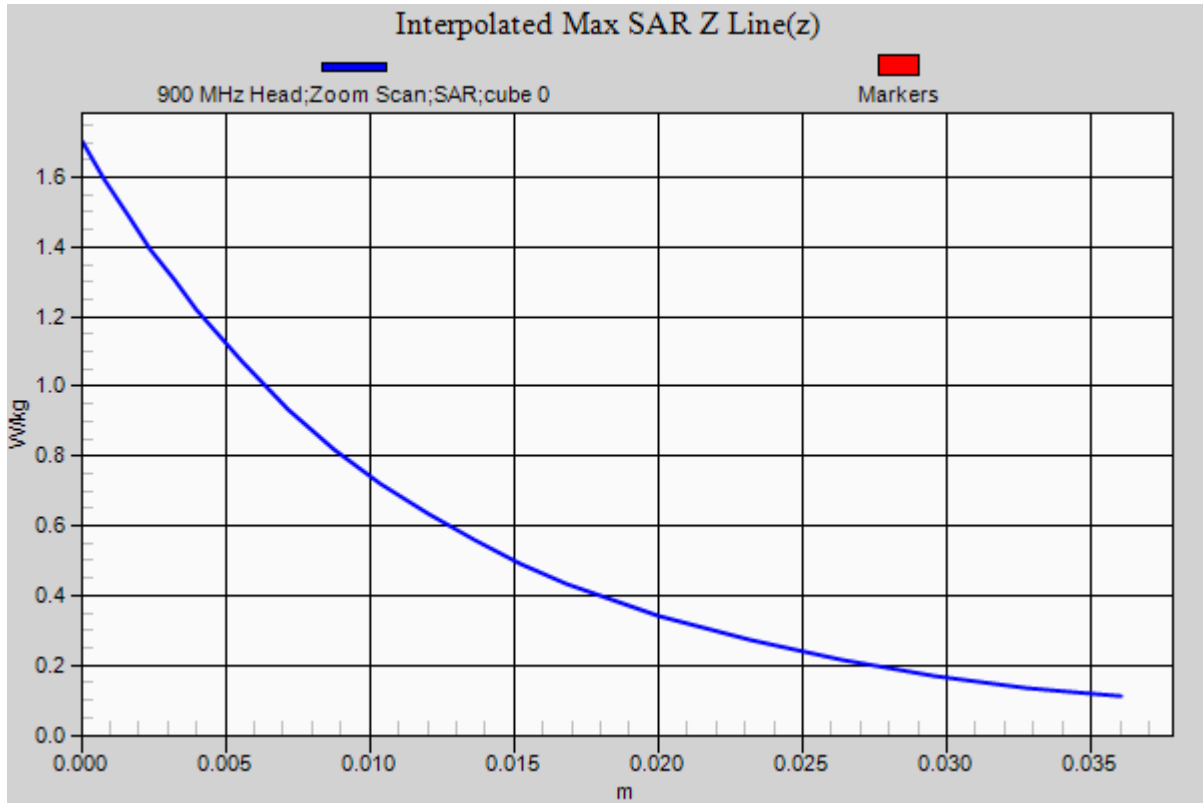

RF Exposure Lab

Plot 2

DUT: Dipole 835 MHz D835V2; Type: D835V2; Serial: D835V2 - SN:4d089

Communication System: CW; Frequency: 835 MHz; Duty Cycle: 1:1
 Medium: HSL835; Medium parameters used (interpolated): $f = 835$ MHz; $\sigma = 0.945$ S/m; $\epsilon_r = 41.235$; $\rho = 1000$ kg/m³
 Phantom section: Flat Section

Test Date: Date: 8/24/2020; Ambient Temp: 23 °C; Tissue Temp: 21 °C
 Probe: EX3DV4 – SN7531; ConvF(10.26, 10.26, 10.26); Calibrated: 7/14/2020;
 Sensor-Surface: 2mm (Mechanical Surface Detection)
 Electronics: DAE4 Sn759; Calibrated: 8/18/2020
 Phantom: ELI v5.0; Type: QDOVA002AA; Serial: 1251
 Measurement SW: DASY52, Version 52.10 (0); SEMCAD X Version 14.6.10 (7417)

Procedure Notes:

835 MHz/Verification/Area Scan (5x11x1): Measurement grid: dx=15mm, dy=15mm

[Info: Interpolated medium parameters used for SAR evaluation.](#)

Maximum value of SAR (measured) = 1.13 W/kg

835 MHz/Verification/Zoom Scan (5x5x7)/Cube 0: Measurement grid: dx=8mm, dy=8mm, dz=5mm

Reference Value = 33.125 V/m; Power Drift = -0.01 dB

Peak SAR (extrapolated) = 1.46 W/kg

Pin=100 mW

SAR(1 g) = 0.949 W/kg; SAR(10 g) = 0.614 W/kg

[Info: Interpolated medium parameters used for SAR evaluation.](#)

Maximum value of SAR (measured) = 1.21 W/kg

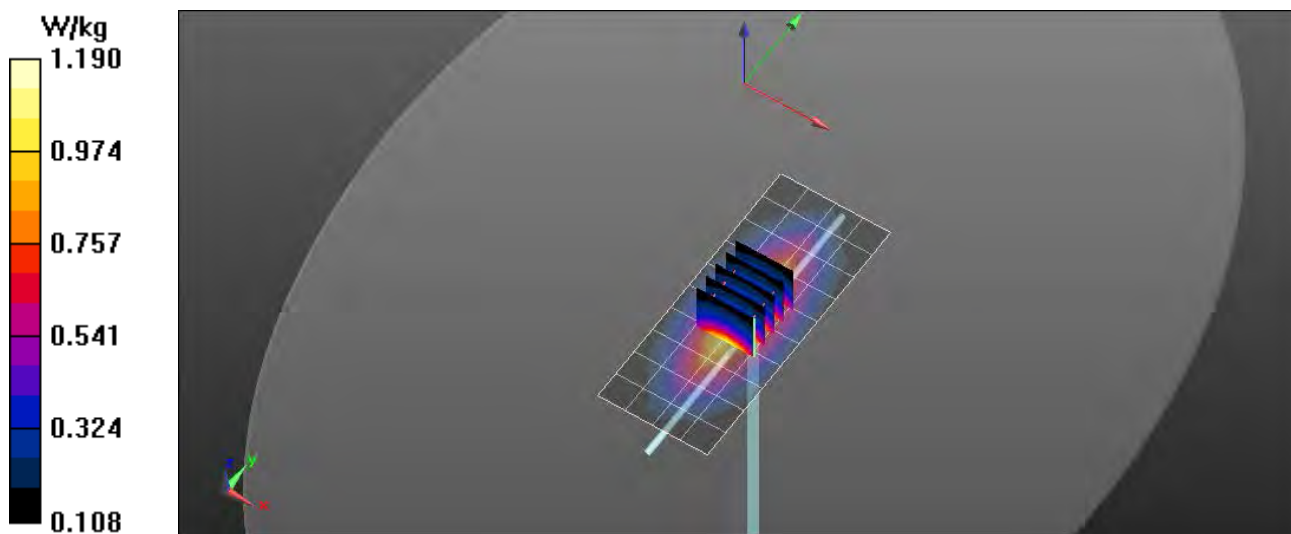

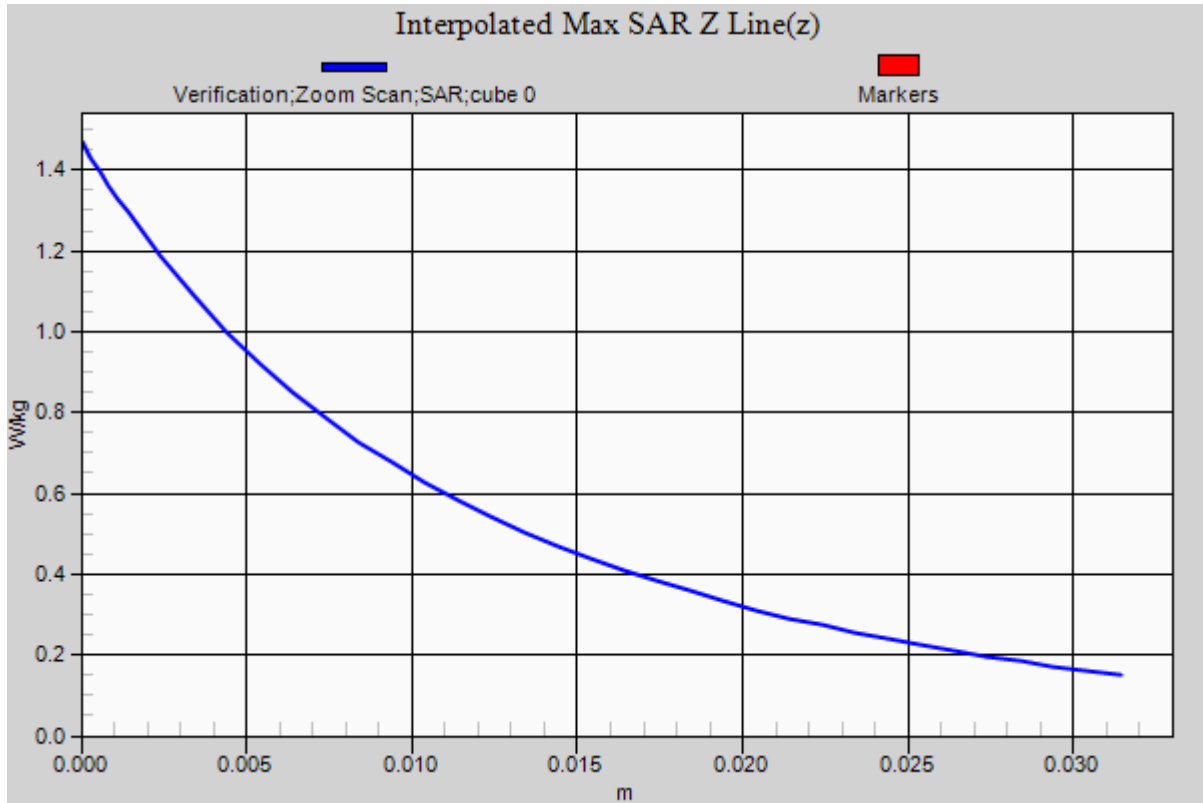

RF Exposure Lab

Plot 3

DUT: Dipole 1750 MHz D1750V2; Type: D1750V2; Serial: D1750V2 - SN: 1018

Communication System: CW; Frequency: 1750 MHz; Duty Cycle: 1:1
Medium: HSL1750; Medium parameters used: $f = 1750$ MHz; $\sigma = 1.42$ S/m; $\epsilon_r = 39.63$; $\rho = 1000$ kg/m³
Phantom section: Flat Section

Test Date: Date: 8/24/2020; Ambient Temp: 23 °C; Tissue Temp: 21 °C

Probe: EX3DV4 – SN7531; ConvF(8.55, 8.55, 8.55); Calibrated: 7/14/2020;
Sensor-Surface: 2mm (Mechanical Surface Detection)
Electronics: DAE4 Sn759; Calibrated: 8/18/2020
Phantom: ELI v5.0; Type: QDOVA002AA; Serial: 1251
Measurement SW: DASY52, Version 52.10 (0); SEMCAD X Version 14.6.10 (7417)

Procedure Notes:

1750 MHz/Verification/Area Scan (5x7x1): Measurement grid: dx=15mm, dy=15mm
Maximum value of SAR (measured) = 5.22 W/kg

1750 MHz/Verification/Zoom Scan (5x5x7)/Cube 0: Measurement grid: dx=8mm, dy=8mm, dz=5mm
Reference Value = 35.426 V/m; Power Drift = -0.01 dB
Peak SAR (extrapolated) = 6.88 W/kg
Pin=100 mW
SAR(1 g) = 3.67 W/kg; SAR(10 g) = 1.91 W/kg
Maximum value of SAR (measured) = 5.49 W/kg

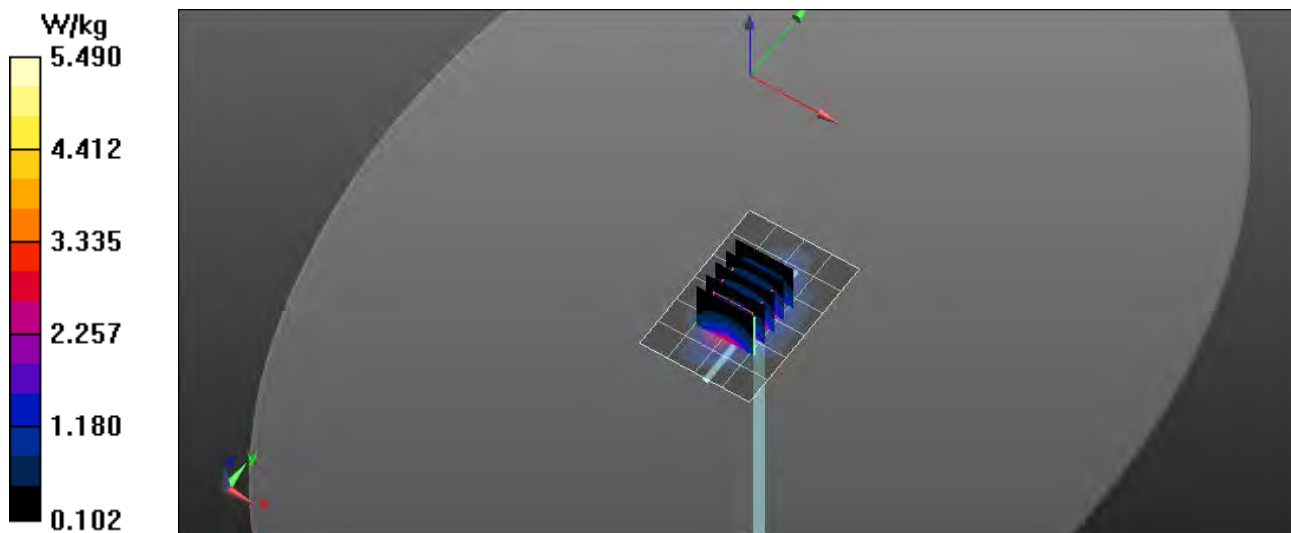

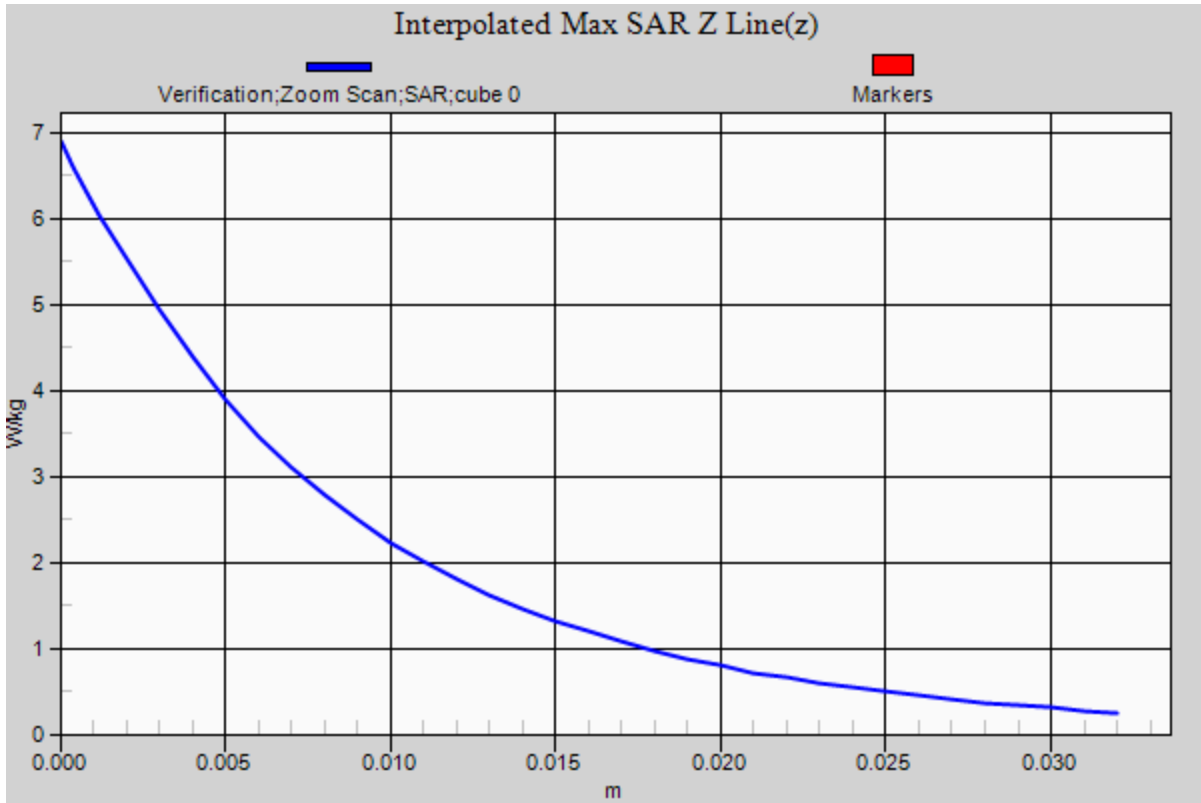

RF Exposure Lab

Plot 4

DUT: Dipole 1900 MHz D1900V2; Type: D1900V2; Serial: D1900V2 - SN: 5d116

Communication System: CW; Frequency: 1900 MHz; Duty Cycle: 1:1
 Medium: HSL1900; Medium parameters used: $f = 1900 \text{ MHz}$; $\sigma = 1.46 \text{ S/m}$; $\epsilon_r = 39.46$; $\rho = 1000 \text{ kg/m}^3$
 Phantom section: Flat Section

Test Date: Date: 8/24/2020; Ambient Temp: 23 °C; Tissue Temp: 21 °C

Probe: EX3DV4 – SN7531; ConvF(8.22, 8.22, 8.22); Calibrated: 7/14/2020;
 Sensor-Surface: 2mm (Mechanical Surface Detection)
 Electronics: DAE4 Sn759; Calibrated: 8/18/2020
 Phantom: ELI v5.0; Type: QDOVA002AA; Serial: 1251
 Measurement SW: DASY52, Version 52.10 (0); SEMCAD X Version 14.6.10 (7417)

Procedure Notes:

1900 MHz/Verification/Area Scan (5x7x1): Measurement grid: dx=15mm, dy=15mm
 Maximum value of SAR (measured) = 5.41 W/kg

1900 MHz/Verification/Zoom Scan (5x5x7)/Cube 0: Measurement grid: dx=8mm, dy=8mm, dz=5mm
 Reference Value = 33.114 V/m; Power Drift = -0.03 dB
 Peak SAR (extrapolated) = 7.18 W/kg
 Pin=100 mW
SAR(1 g) = 4.09 W/kg; SAR(10 g) = 2.13 W/kg
 Maximum value of SAR (measured) = 5.76 W/kg

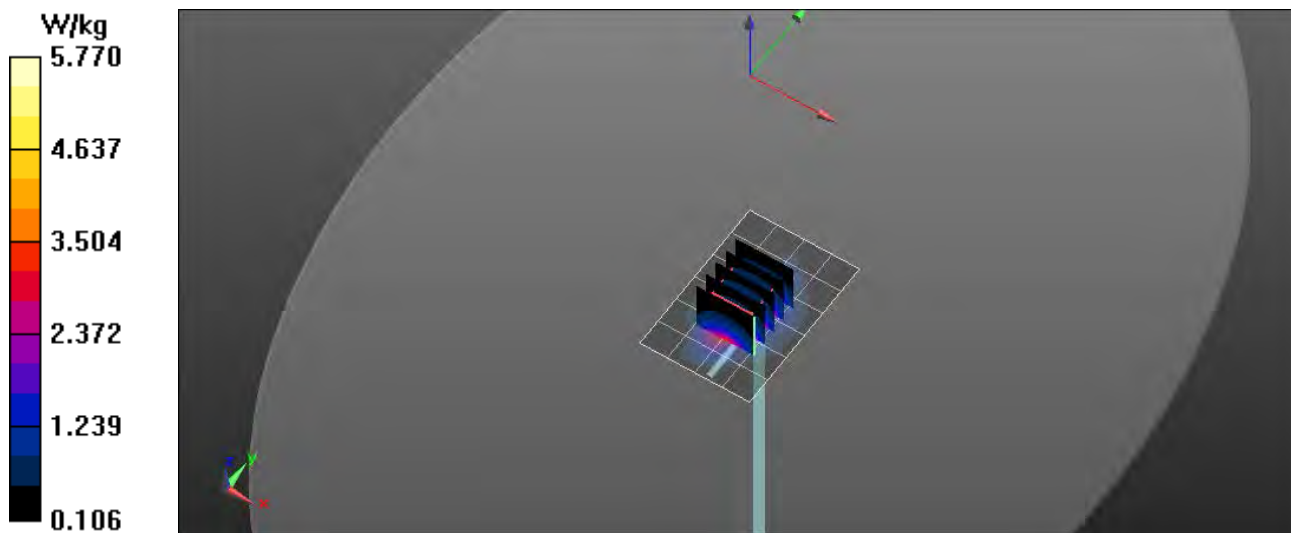

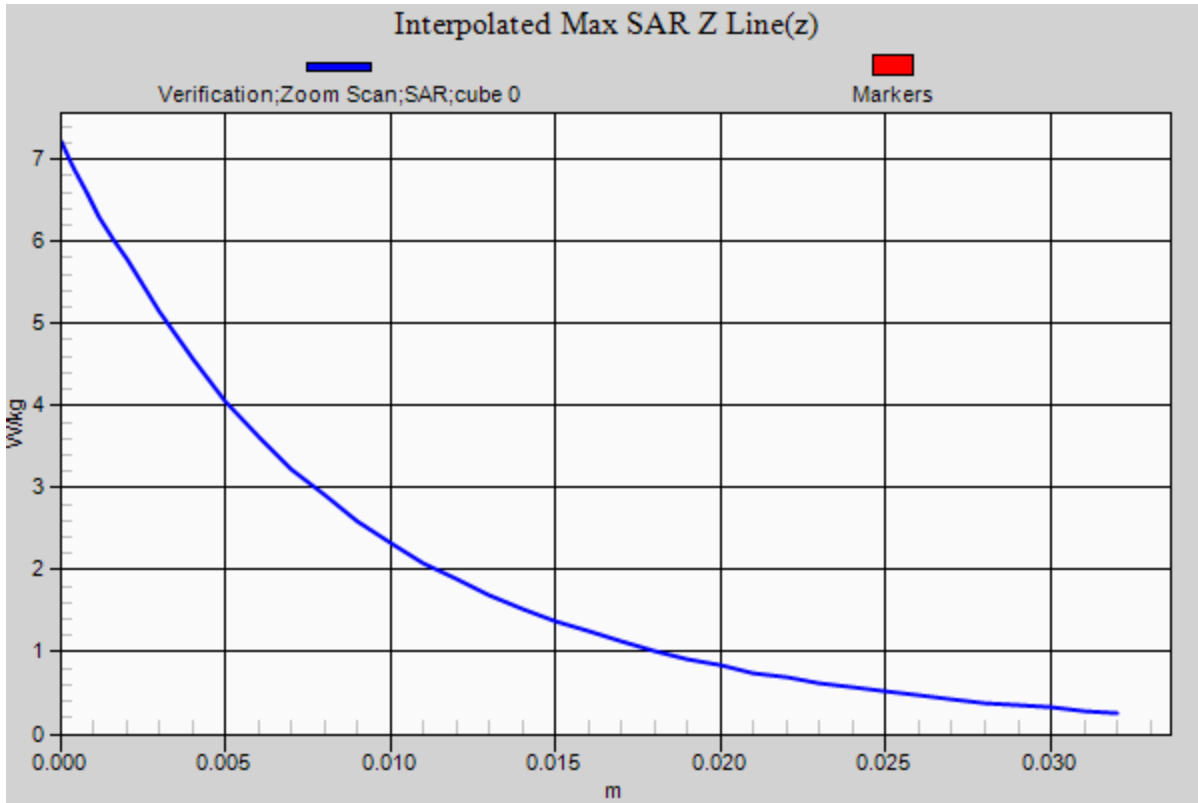

RF Exposure Lab

Plot 5

DUT: Dipole 2450 MHz D2450V2; Type: D2450V2; Serial: D2450V2 - SN: 829

Communication System: CW; Frequency: 2450 MHz; Duty Cycle: 1:1
Medium: HSL2450; Medium parameters used: $f = 2450$ MHz; $\sigma = 1.83$ S/m; $\epsilon_r = 38.6$; $\rho = 1000$ kg/m³
Phantom section: Flat Section

Test Date: Date: 9/3/2020; Ambient Temp: 23 °C; Tissue Temp: 21 °C
Probe: EX3DV4 – SN7531; ConvF(7.61, 7.61, 7.61); Calibrated: 7/14/2020;
Sensor-Surface: 2mm (Mechanical Surface Detection)
Electronics: DAE4 Sn759; Calibrated: 8/18/2020
Phantom: ELI v5.0; Type: QDOVA002AA; Serial: 1251
Measurement SW: DASY52, Version 52.10 (0); SEMCAD X Version 14.6.10 (7417)

Procedure Notes:

Head Verification/2450 MHz/Area Scan (61x101x1): Interpolated grid: dx=1.200 mm, dy=1.200 mm
Maximum value of SAR (interpolated) = 8.22 W/kg

Head Verification/2450 MHz/Zoom Scan (7x7x7)/Cube 0: Measurement grid: dx=5mm, dy=5mm, dz=5mm
Reference Value = 56.025 V/m; Power Drift = -0.03 dB
Peak SAR (extrapolated) = 11.05 W/kg
 $P_{in} = 100$ mW
SAR(1 g) = 5.26 W/kg; SAR(10 g) = 2.52 W/kg
Maximum value of SAR (measured) = 8.96 W/kg

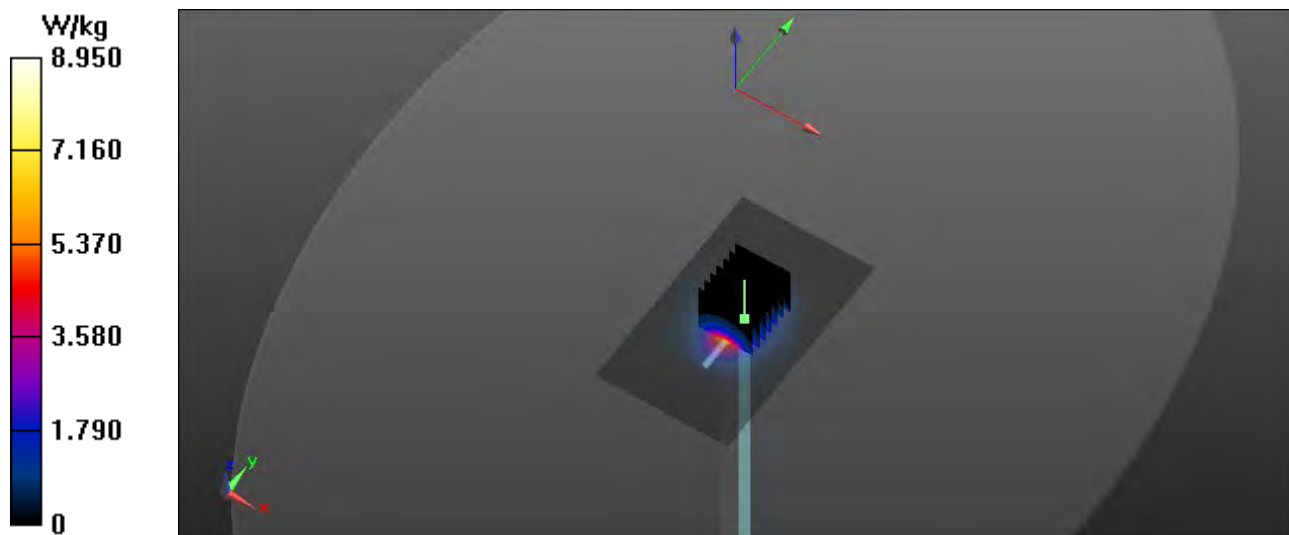

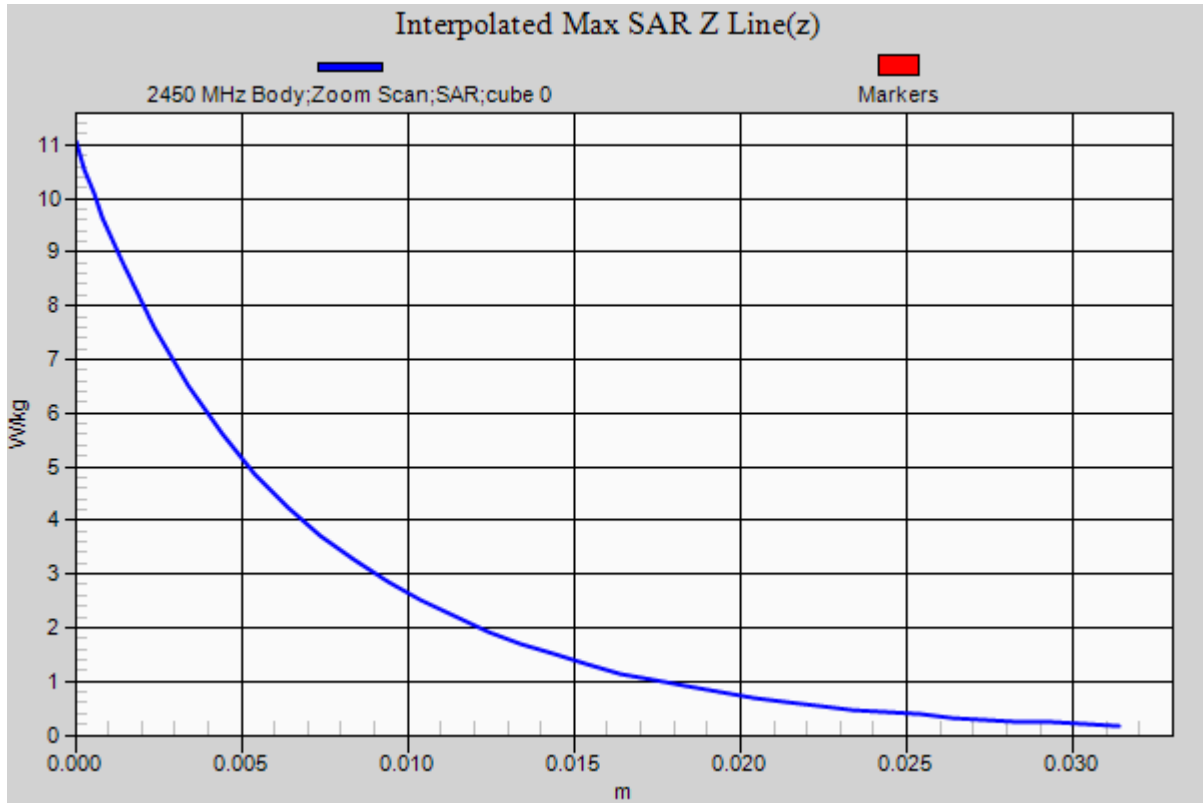

Appendix B – SAR Test Data Plots

RF Exposure Lab

Plot 1

DUT: 1098-10001; Type: Touch Screen Monitor; Serial: Eng 1

Communication System: LTE (SC-FDMA, 1 RB, 10 MHz, QPSK); Frequency: 710 MHz; Duty Cycle: 1:1
Medium: HSL750; Medium parameters used: $f = 710 \text{ MHz}$; $\sigma = 0.9 \text{ S/m}$; $\epsilon_r = 41.78$; $\rho = 1000 \text{ kg/m}^3$
Phantom section: Flat Section

Test Date: Date: 8/25/2020; Ambient Temp: 23 °C; Tissue Temp: 21 °C

Probe: EX3DV4 - SN7531; ConvF(10.64, 10.64, 10.64); Calibrated: 7/14/2020
Sensor-Surface: 2mm (Mechanical Surface Detection)
Electronics: DAE4 Sn759; Calibrated: 8/18/2020
Phantom: ELI v5.0; Type: QDOVA002AA; Serial: 1251
Measurement SW: DASY52, Version 52.10 (0); SEMCAD X Version 14.6.10 (7417)

Procedure Notes:

Band 17 LTE/Back 1 RB 49 Offset Mid/Area Scan (5x11x1): Measurement grid: dx=15mm, dy=15mm
Maximum value of SAR (measured) = 1.93 W/kg

Band 17 LTE/Back 1 RB 49 Offset Mid/Zoom Scan (5x5x7)/Cube 0: Measurement grid: dx=8mm, dy=8mm, dz=5mm
Reference Value = 42.00 V/m; Power Drift = -0.02 dB
Peak SAR (extrapolated) = 2.57 W/kg
SAR(1 g) = 1.44 W/kg; SAR(10 g) = 0.920 W/kg
Maximum value of SAR (measured) = 1.88 W/kg

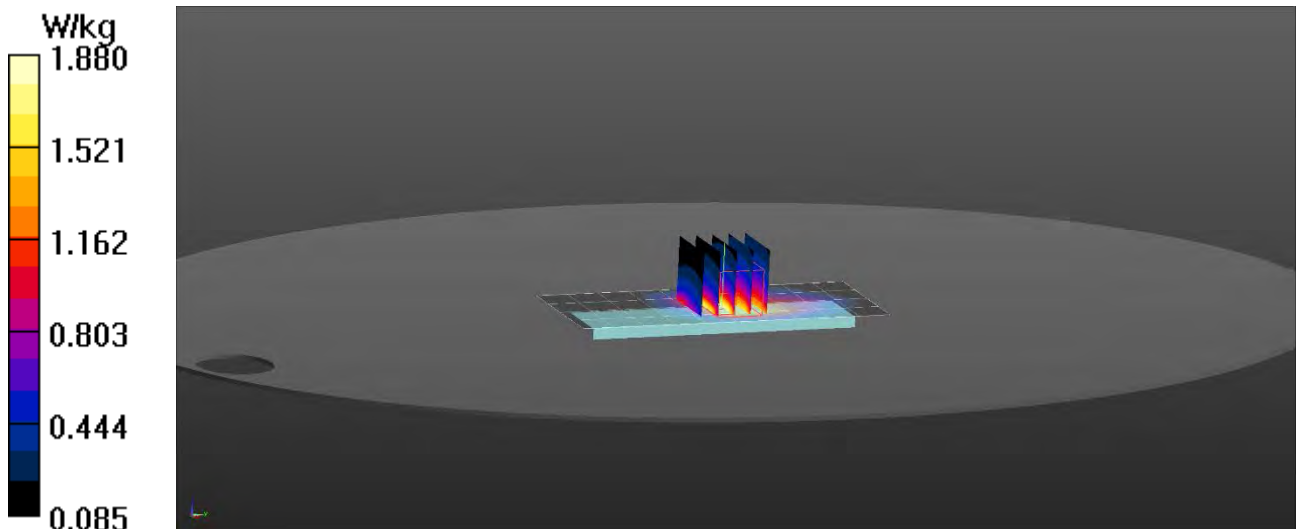

RF Exposure Lab

Plot 2

DUT: 1098-10001; Type: Touch Screen Monitor; Serial: Eng 1

Communication System: LTE (SC-FDMA, 1 RB, 10 MHz, QPSK); Frequency: 782 MHz; Duty Cycle: 1:1
Medium: HSL750; Medium parameters used (interpolated): $f = 782$ MHz; $\sigma = 0.922$ S/m; $\epsilon_r = 41.358$; $\rho = 1000$ kg/m³
Phantom section: Flat Section

Test Date: Date: 8/25/2020; Ambient Temp: 23 °C; Tissue Temp: 21 °C

Probe: EX3DV4 - SN7531; ConvF(10.64, 10.64, 10.64); Calibrated: 7/14/2020
Sensor-Surface: 2mm (Mechanical Surface Detection)
Electronics: DAE4 Sn759; Calibrated: 8/18/2020
Phantom: ELI v5.0; Type: QDOVA002AA; Serial: 1251
Measurement SW: DASY52, Version 52.10 (0); SEMCAD X Version 14.6.10 (7417)

Procedure Notes:

Band 13 LTE/Back 1 RB 24 Offset Mid/Area Scan (5x11x1): Measurement grid: dx=15mm, dy=15mm

[Info: Interpolated medium parameters used for SAR evaluation.](#)

Maximum value of SAR (measured) = 1.06 W/kg

Band 13 LTE/Back 1 RB 24 Offset Mid/Zoom Scan (5x5x7)/Cube 0: Measurement grid: dx=8mm, dy=8mm, dz=5mm

Reference Value = 29.16 V/m; Power Drift = -0.01 dB

Peak SAR (extrapolated) = 1.48 W/kg

SAR(1 g) = 0.748 W/kg; SAR(10 g) = 0.472 W/kg

[Info: Interpolated medium parameters used for SAR evaluation.](#)

Maximum value of SAR (measured) = 1.01 W/kg

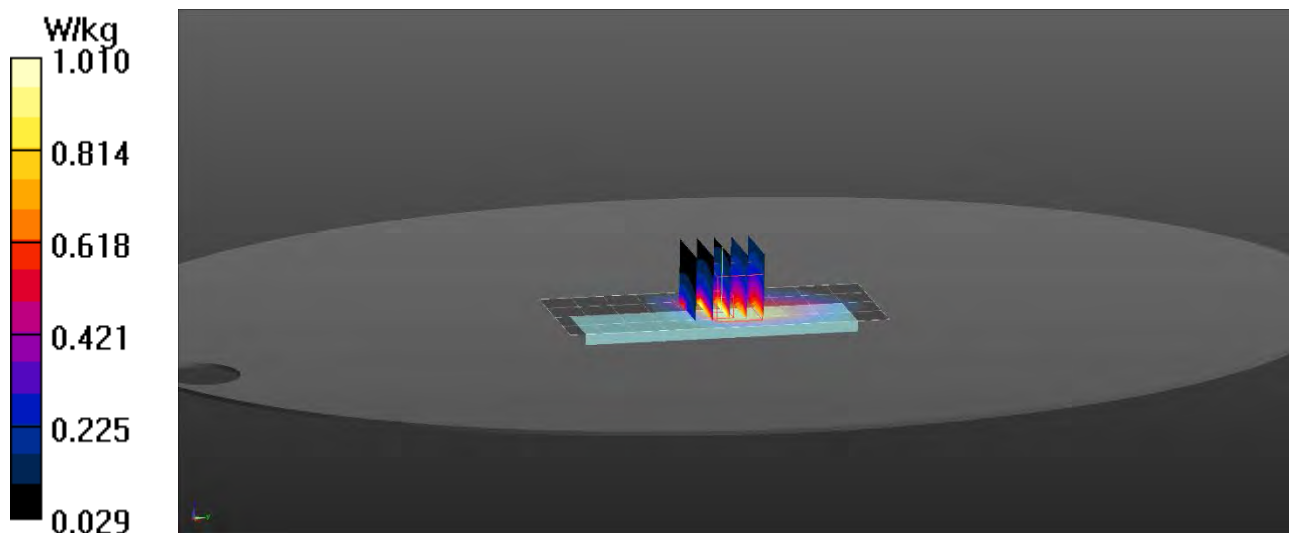

RF Exposure Lab

Plot 3

DUT: 1098-10001; Type: Touch Screen Monitor; Serial: Eng 1

Communication System: UMTS (WCDMA); Frequency: 846.6 MHz; Duty Cycle: 1:1
Medium: HSL835; Medium parameters used (interpolated): $f = 846.6$ MHz; $\sigma = 0.957$ S/m; $\epsilon_r = 41.207$; $\rho = 1000$ kg/m³
Phantom section: Flat Section

Test Date: Date: 8/25/2020; Ambient Temp: 23 °C; Tissue Temp: 21 °C

Probe: EX3DV4 - SN7531; ConvF(10.26, 10.26, 10.26); Calibrated: 7/14/2020
Sensor-Surface: 2mm (Mechanical Surface Detection)
Electronics: DAE4 Sn759; Calibrated: 8/18/2020
Phantom: ELI v5.0; Type: QDOVA002AA; Serial: 1251
Measurement SW: DASY52, Version 52.10 (0); SEMCAD X Version 14.6.10 (7417)

Procedure Notes:

Band 5 UMTS/Back High/Area Scan (5x11x1): Measurement grid: dx=15mm, dy=15mm

[Info: Interpolated medium parameters used for SAR evaluation.](#)

Maximum value of SAR (measured) = 2.23 W/kg

Band 5 UMTS/Back High/Zoom Scan (5x5x7)/Cube 0: Measurement grid: dx=8mm, dy=8mm, dz=5mm

Reference Value = 42.48 V/m; Power Drift = -0.03 dB

Peak SAR (extrapolated) = 3.40 W/kg

SAR(1 g) = 1.52 W/kg; SAR(10 g) = 0.881 W/kg

[Info: Interpolated medium parameters used for SAR evaluation.](#)

Maximum value of SAR (measured) = 2.29 W/kg

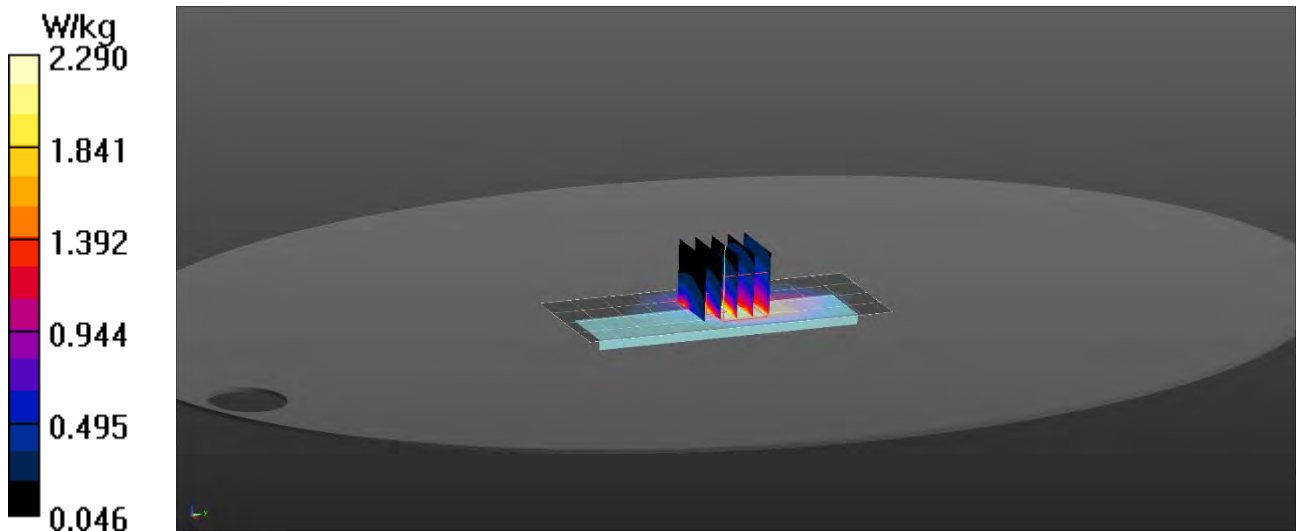

RF Exposure Lab

Plot 4

DUT: 1098-10001; Type: Touch Screen Monitor; Serial: Eng 1

Communication System: LTE (SC-FDMA, 1 RB, 10 MHz, QPSK); Frequency: 844 MHz; Duty Cycle: 1:1
 Medium: HSL835; Medium parameters used (interpolated): $f = 844$ MHz; $\sigma = 0.954$ S/m; $\epsilon_r = 41.212$; $\rho = 1000$ kg/m³
 Phantom section: Flat Section

Test Date: Date: 8/24/2020; Ambient Temp: 23 °C; Tissue Temp: 21 °C

Probe: EX3DV4 - SN7531; ConvF(10.26, 10.26, 10.26); Calibrated: 7/14/2020
 Sensor-Surface: 2mm (Mechanical Surface Detection)
 Electronics: DAE4 Sn759; Calibrated: 8/18/2020
 Phantom: ELI v5.0; Type: QDOVA002AA; Serial: 1251
 Measurement SW: DASY52, Version 52.10 (0); SEMCAD X Version 14.6.10 (7417)

Procedure Notes:

Band 5 LTE/Back 1 RB 49 Offset High/Area Scan (5x11x1): Measurement grid: dx=15mm, dy=15mm

[Info: Interpolated medium parameters used for SAR evaluation.](#)

Maximum value of SAR (measured) = 1.80 W/kg

Band 5 LTE/Back 1 RB 49 Offset High/Zoom Scan (5x5x7)/Cube 0: Measurement grid: dx=8mm, dy=8mm, dz=5mm

Reference Value = 38.21 V/m; Power Drift = -0.04 dB

Peak SAR (extrapolated) = 2.72 W/kg

SAR(1 g) = 1.23 W/kg; SAR(10 g) = 0.720 W/kg

[Info: Interpolated medium parameters used for SAR evaluation.](#)

Maximum value of SAR (measured) = 1.84 W/kg

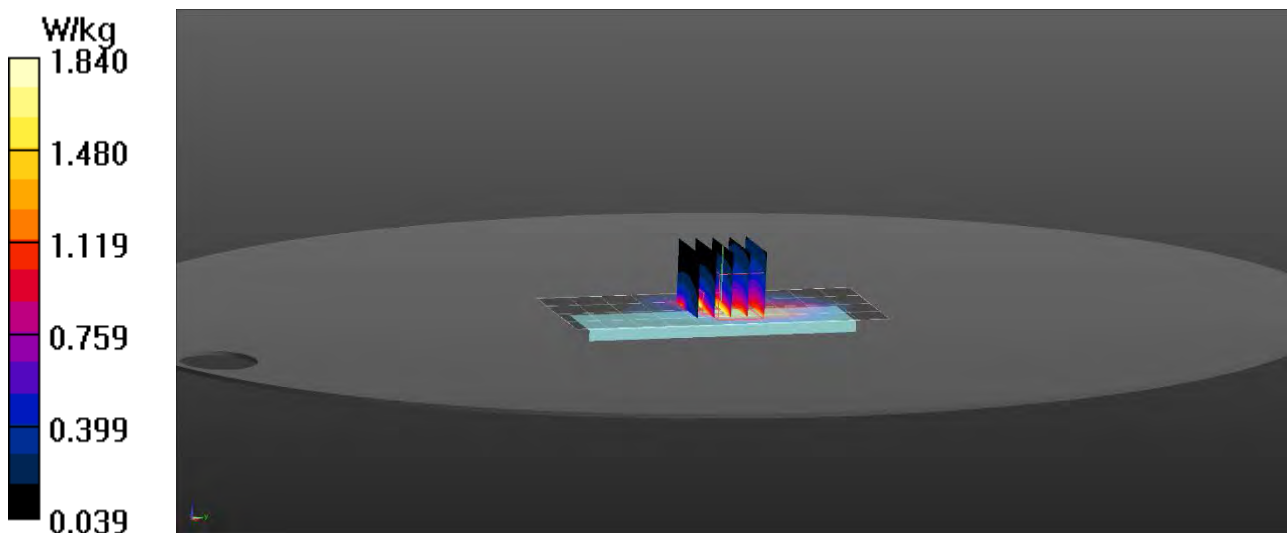

RF Exposure Lab

Plot 5

DUT: 1098-10001; Type: Touch Screen Monitor; Serial: Eng 1

Communication System: LTE (SC-FDMA, 1 RB, 20 MHz, QPSK); Frequency: 1745 MHz; Duty Cycle: 1:1
Medium: HSL1750; Medium parameters used (interpolated): $f = 1745$ MHz; $\sigma = 1.415$ S/m; $\epsilon_r = 39.64$; $\rho = 1000$ kg/m³
Phantom section: Flat Section

Test Date: Date: 8/24/2020; Ambient Temp: 23 °C; Tissue Temp: 21 °C

Probe: EX3DV4 - SN7531; ConvF(8.55, 8.55, 8.55); Calibrated: 7/14/2020
Sensor-Surface: 2mm (Mechanical Surface Detection)
Electronics: DAE4 Sn759; Calibrated: 8/18/2020
Phantom: ELI v5.0; Type: QDOVA002AA; Serial: 1251
Measurement SW: DASY52, Version 52.10 (0); SEMCAD X Version 14.6.10 (7417)

Procedure Notes:

Band 4 LTE/Back 1 RB 49 Offset High/Area Scan (5x11x1): Measurement grid: dx=15mm, dy=15mm

[Info: Interpolated medium parameters used for SAR evaluation.](#)

Maximum value of SAR (measured) = 5.27 W/kg

Band 4 LTE/Back 1 RB 49 Offset High/Zoom Scan (5x5x7)/Cube 0: Measurement grid: dx=8mm, dy=8mm, dz=5mm

Reference Value = 30.34 V/m; Power Drift = -0.02 dB

Peak SAR (extrapolated) = 6.17 W/kg

SAR(1 g) = 4.47 W/kg; SAR(10 g) = 2.86 W/kg

[Info: Interpolated medium parameters used for SAR evaluation.](#)

Maximum value of SAR (measured) = 5.40 W/kg

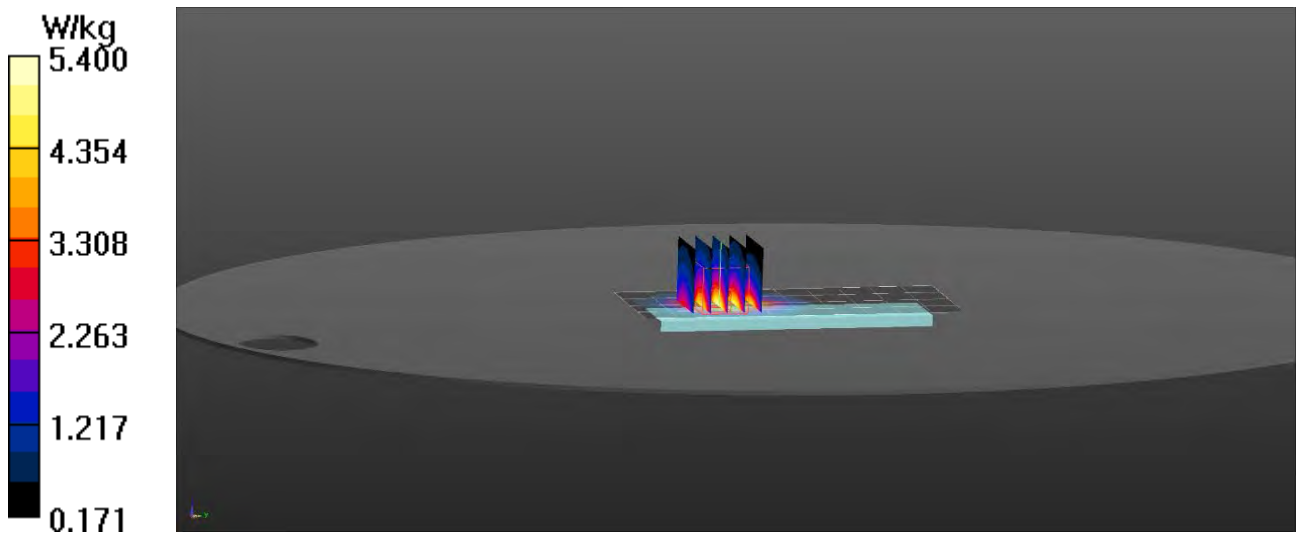

RF Exposure Lab

Plot 6

DUT: 1098-10001; Type: Touch Screen Monitor; Serial: Eng 1

Communication System: UMTS (WCDMA); Frequency: 1880 MHz; Duty Cycle: 1:1
Medium: HSL1900; Medium parameters used: $f = 1880 \text{ MHz}$; $\sigma = 1.44 \text{ S/m}$; $\epsilon_r = 39.47$; $\rho = 1000 \text{ kg/m}^3$
Phantom section: Flat Section

Test Date: Date: 8/24/2020; Ambient Temp: 23 °C; Tissue Temp: 21 °C

Probe: EX3DV4 - SN7531; ConvF(8.22, 8.22, 8.22); Calibrated: 7/14/2020
Sensor-Surface: 2mm (Mechanical Surface Detection)
Electronics: DAE4 Sn759; Calibrated: 8/18/2020
Phantom: ELI v5.0; Type: QDOVA002AA; Serial: 1251
Measurement SW: DASY52, Version 52.10 (0); SEMCAD X Version 14.6.10 (7417)

Procedure Notes:

Band 2 UMTS/Back Mid/Area Scan (5x11x1): Measurement grid: $dx=15\text{mm}$, $dy=15\text{mm}$
Maximum value of SAR (measured) = 6.21 W/kg

Band 2 UMTS/Back Mid/Zoom Scan (5x5x7)/Cube 0: Measurement grid: $dx=8\text{mm}$, $dy=8\text{mm}$, $dz=5\text{mm}$
Reference Value = 36.99 V/m; Power Drift = -0.03 dB
Peak SAR (extrapolated) = 7.63 W/kg
SAR(1 g) = 5.51 W/kg; SAR(10 g) = 3.48 W/kg
Maximum value of SAR (measured) = 6.74 W/kg

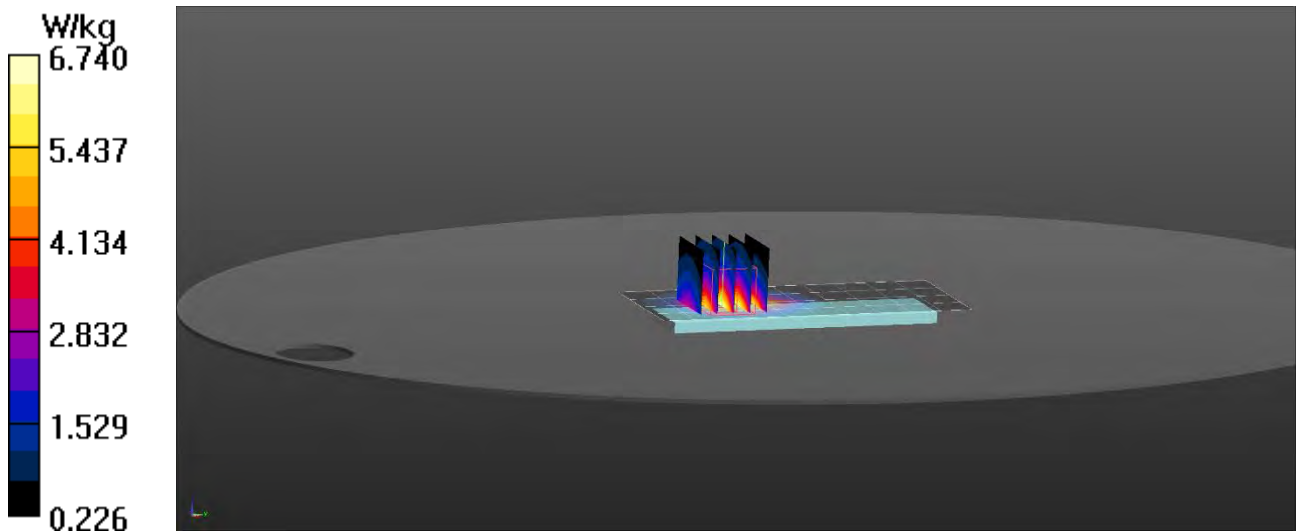

RF Exposure Lab

Plot 7

DUT: 1098-10001; Type: Touch Screen Monitor; Serial: Eng 1

Communication System: LTE (SC-FDMA, 1 RB, 20 MHz, QPSK); Frequency: 1880 MHz; Duty Cycle: 1:1
Medium: HSL1900; Medium parameters used: $f = 1880$ MHz; $\sigma = 1.44$ S/m; $\epsilon_r = 39.47$; $\rho = 1000$ kg/m³
Phantom section: Flat Section

Test Date: Date: 8/24/2020; Ambient Temp: 23 °C; Tissue Temp: 21 °C

Probe: EX3DV4 - SN7531; ConvF(8.22, 8.22, 8.22); Calibrated: 7/14/2020
Sensor-Surface: 2mm (Mechanical Surface Detection)
Electronics: DAE4 Sn759; Calibrated: 8/18/2020
Phantom: ELI v5.0; Type: QDOVA002AA; Serial: 1251
Measurement SW: DASY52, Version 52.10 (0); SEMCAD X Version 14.6.10 (7417)

Procedure Notes:

Band 2 LTE/Back 1 RB 49 Offset Mid/Area Scan (5x11x1): Measurement grid: dx=15mm, dy=15mm
Maximum value of SAR (measured) = 5.16 W/kg

Band 2 LTE/Back 1 RB 49 Offset Mid/Zoom Scan (5x5x7)/Cube 0: Measurement grid: dx=8mm, dy=8mm, dz=5mm
Reference Value = 34.05 V/m; Power Drift = -0.02 dB
Peak SAR (extrapolated) = 6.16 W/kg
SAR(1 g) = 4.45 W/kg; SAR(10 g) = 2.82 W/kg
Maximum value of SAR (measured) = 5.44 W/kg

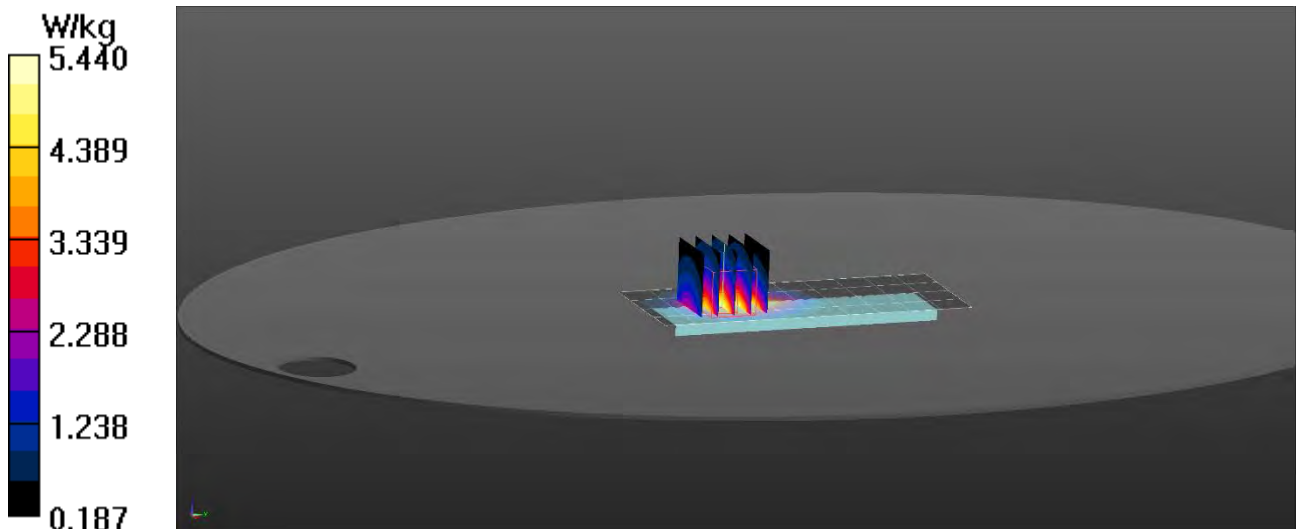

RF Exposure Lab

Plot 8

DUT: 1098-10001; Type: Touch Screen Monitor; Serial: Eng 1

Communication System: WiFi 802.11b (DSSS, 1 Mbps); Frequency: 2437 MHz; Duty Cycle: 1:1
 Medium: HSL2450; Medium parameters used (interpolated): $f = 2437$ MHz; $\sigma = 1.814$ S/m; $\epsilon_r = 38.653$; $\rho = 1000$ kg/m³
 Phantom section: Flat Section

Test Date: Date: 9/3/2020; Ambient Temp: 23 °C; Tissue Temp: 21 °C

Probe: EX3DV4 - SN7531; ConvF(7.61, 7.61, 7.61); Calibrated: 7/14/2020
 Sensor-Surface: 2mm (Mechanical Surface Detection)
 Electronics: DAE4 Sn759; Calibrated: 8/18/2020
 Phantom: ELI v5.0; Type: QDOVA002AA; Serial: 1251
 Measurement SW: DASY52, Version 52.10 (0); SEMCAD X Version 14.6.10 (7417)

Procedure Notes:

2450 MHz/Front Ant 0 Mid/Area Scan (13x7x1): Measurement grid: dx=10mm, dy=10mm

[Info: Interpolated medium parameters used for SAR evaluation.](#)
 Maximum value of SAR (measured) = 0.0792 W/kg

2450 MHz/Front Ant 0 Mid/Zoom Scan (7x7x7)/Cube 0: Measurement grid: dx=5mm, dy=5mm, dz=5mm

Reference Value = 0.7990 V/m; Power Drift = -0.03 dB
 Peak SAR (extrapolated) = 0.100 W/kg
SAR(1 g) = 0.062 W/kg; SAR(10 g) = 0.036 W/kg

[Info: Interpolated medium parameters used for SAR evaluation.](#)
 Maximum value of SAR (measured) = 0.0805 W/kg

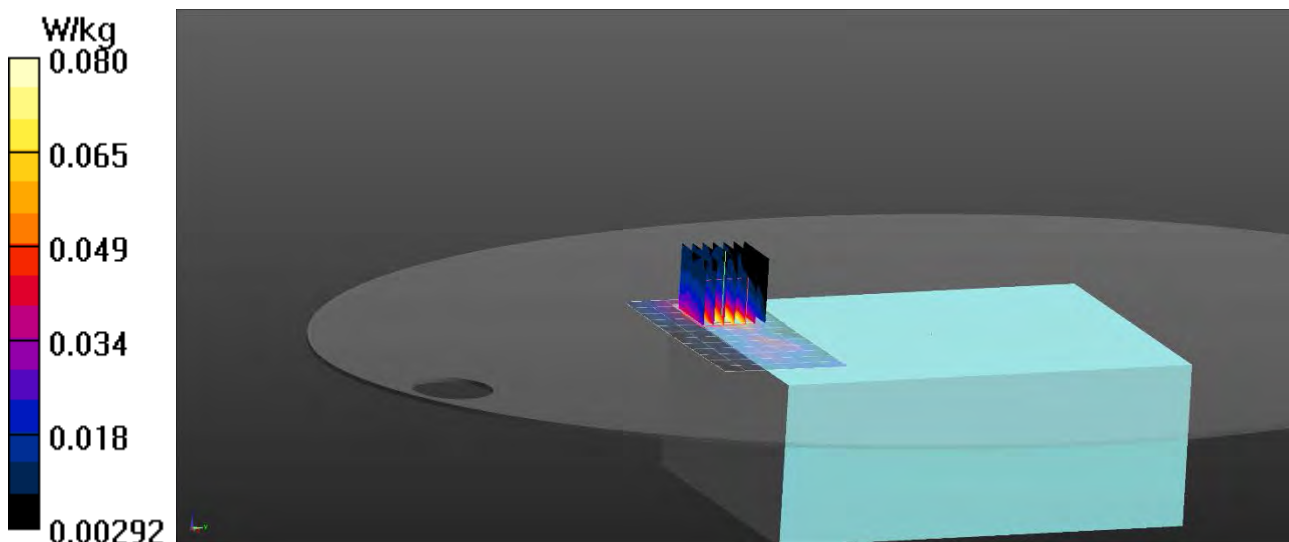

Appendix D – Probe Calibration Data Sheets

**Calibration Laboratory of
Schmid & Partner
Engineering AG**
Zeughausstrasse 43, 8004 Zurich, Switzerland



S Schweizerischer Kalibrierdienst
C Service suisse d'étalonnage
S Servizio svizzero di taratura
Swiss Calibration Service

Accredited by the Swiss Accreditation Service (SAS)
The Swiss Accreditation Service is one of the signatories to the EA
Multilateral Agreement for the recognition of calibration certificates

Accreditation No.: **SCS 0108**

Client **RF Exposure Lab**

Certificate No: **EX3-7531_Jul20/2**

CALIBRATION CERTIFICATE (Replacement of No: EX3-7531_Jul20)

Object **EX3DV4 - SN:7531**

Calibration procedure(s) **QA CAL-01.v9, QA CAL-12.v9, QA CAL-14.v6, QA CAL-23.v5,
QA CAL-25.v7
Calibration procedure for dosimetric E-field probes**

Calibration date: **July 14, 2020**

This calibration certificate documents the traceability to national standards, which realize the physical units of measurements (SI).
The measurements and the uncertainties with confidence probability are given on the following pages and are part of the certificate.

All calibrations have been conducted in the closed laboratory facility: environment temperature (22 ± 3)°C and humidity < 70%.

Calibration Equipment used (M&TE critical for calibration)

Primary Standards	ID	Cal Date (Certificate No.)	Scheduled Calibration
Power meter NRP	SN: 104778	01-Apr-20 (No. 217-03100/03101)	Apr-21
Power sensor NRP-Z91	SN: 103244	01-Apr-20 (No. 217-03100)	Apr-21
Power sensor NRP-Z91	SN: 103245	01-Apr-20 (No. 217-03101)	Apr-21
Reference 20 dB Attenuator	SN: CC2552 (20x)	31-Mar-20 (No. 217-03106)	Apr-21
DAE4	SN: 660	27-Dec-19 (No. DAE4-660_Dec19)	Dec-20
Reference Probe ES3DV2	SN: 3013	31-Dec-19 (No. ES3-3013_Dec19)	Dec-20
Secondary Standards	ID	Check Date (in house)	Scheduled Check
Power meter E4419B	SN: GB41293874	06-Apr-16 (in house check Jun-20)	In house check: Jun-22
Power sensor E4412A	SN: MY41498087	06-Apr-16 (in house check Jun-20)	In house check: Jun-22
Power sensor E4412A	SN: 000110210	06-Apr-16 (in house check Jun-20)	In house check: Jun-22
RF generator HP 8648C	SN: US3642U01700	04-Aug-99 (in house check Jun-20)	In house check: Jun-22
Network Analyzer E8358A	SN: US41080477	31-Mar-14 (in house check Oct-19)	In house check: Oct-20

Calibrated by: **Jeton Kastrati** (Name) / **Laboratory Technician** (Function) / *i.v. M. Kastrati* (Signature)

Approved by: **Katja Pokovic** (Name) / **Technical Manager** (Function) / *Katja Pokovic* (Signature)

Issued: July 22, 2020

This calibration certificate shall not be reproduced except in full without written approval of the laboratory.



Accredited by the Swiss Accreditation Service (SAS)

Accreditation No.: **SCS 0108**

The Swiss Accreditation Service is one of the signatories to the EA
Multilateral Agreement for the recognition of calibration certificates

Glossary:

TSL	tissue simulating liquid
NORM _{x,y,z}	sensitivity in free space
ConvF	sensitivity in TSL / NORM _{x,y,z}
DCP	diode compression point
CF	crest factor (1/duty_cycle) of the RF signal
A, B, C, D	modulation dependent linearization parameters
Polarization φ	φ rotation around probe axis
Polarization ϑ	ϑ rotation around an axis that is in the plane normal to probe axis (at measurement center), i.e., $\vartheta = 0$ is normal to probe axis
Connector Angle	information used in DASY system to align probe sensor X to the robot coordinate system

Calibration is Performed According to the Following Standards:

- a) IEEE Std 1528-2013, "IEEE Recommended Practice for Determining the Peak Spatial-Averaged Specific Absorption Rate (SAR) in the Human Head from Wireless Communications Devices: Measurement Techniques", June 2013
- b) IEC 62209-1, "Measurement procedure for the assessment of Specific Absorption Rate (SAR) from hand-held and body-mounted devices used next to the ear (frequency range of 300 MHz to 6 GHz)", July 2016
- c) IEC 62209-2, "Procedure to determine the Specific Absorption Rate (SAR) for wireless communication devices used in close proximity to the human body (frequency range of 30 MHz to 6 GHz)", March 2010
- d) KDB 865664, "SAR Measurement Requirements for 100 MHz to 6 GHz"

Methods Applied and Interpretation of Parameters:

- *NORM_{x,y,z}*: Assessed for E-field polarization $\vartheta = 0$ ($f \leq 900$ MHz in TEM-cell; $f > 1800$ MHz: R22 waveguide). *NORM_{x,y,z}* are only intermediate values, i.e., the uncertainties of *NORM_{x,y,z}* does not affect the E^2 -field uncertainty inside TSL (see below *ConvF*).
- *NORM(f)_{x,y,z}* = *NORM_{x,y,z}* * *frequency_response* (see Frequency Response Chart). This linearization is implemented in DASY4 software versions later than 4.2. The uncertainty of the frequency response is included in the stated uncertainty of *ConvF*.
- *DCP_{x,y,z}*: DCP are numerical linearization parameters assessed based on the data of power sweep with CW signal (no uncertainty required). DCP does not depend on frequency nor media.
- *PAR*: PAR is the Peak to Average Ratio that is not calibrated but determined based on the signal characteristics
- *A_{x,y,z}*; *B_{x,y,z}*; *C_{x,y,z}*; *D_{x,y,z}*; *VR_{x,y,z}*: *A, B, C, D* are numerical linearization parameters assessed based on the data of power sweep for specific modulation signal. The parameters do not depend on frequency nor media. *VR* is the maximum calibration range expressed in RMS voltage across the diode.
- *ConvF* and *Boundary Effect Parameters*: Assessed in flat phantom using E-field (or Temperature Transfer Standard for $f \leq 800$ MHz) and inside waveguide using analytical field distributions based on power measurements for $f > 800$ MHz. The same setups are used for assessment of the parameters applied for boundary compensation (alpha, depth) of which typical uncertainty values are given. These parameters are used in DASY4 software to improve probe accuracy close to the boundary. The sensitivity in TSL corresponds to *NORM_{x,y,z}* * *ConvF* whereby the uncertainty corresponds to that given for *ConvF*. A frequency dependent *ConvF* is used in DASY version 4.4 and higher which allows extending the validity from ± 50 MHz to ± 100 MHz.
- *Spherical isotropy (3D deviation from isotropy)*: in a field of low gradients realized using a flat phantom exposed by a patch antenna.
- *Sensor Offset*: The sensor offset corresponds to the offset of virtual measurement center from the probe tip (on probe axis). No tolerance required.
- *Connector Angle*: The angle is assessed using the information gained by determining the *NORM_x* (no uncertainty required).

DASY/EASY - Parameters of Probe: EX3DV4 - SN:7531

Basic Calibration Parameters

	Sensor X	Sensor Y	Sensor Z	Unc (k=2)
Norm ($\mu\text{V}/(\text{V}/\text{m})^2$) ^A	0.39	0.47	0.39	$\pm 10.1\%$
DCP (mV) ^B	98.5	98.5	103.6	

Calibration Results for Modulation Response

UID	Communication System Name		A dB	B dB $\sqrt{\mu\text{V}}$	C	D dB	VR mV	Max dev.	Unc ^E (k=2)
0	CW	X	0.0	0.0	1.0	0.00	142.3	$\pm 3.0\%$	$\pm 4.7\%$
		Y	0.0	0.0	1.0		136.0		
		Z	0.0	0.0	1.0		138.4		

The reported uncertainty of measurement is stated as the standard uncertainty of measurement multiplied by the coverage factor $k=2$, which for a normal distribution corresponds to a coverage probability of approximately 95%.

^A The uncertainties of Norm X,Y,Z do not affect the E^2 -field uncertainty inside TSL (see Page 5).

^B Numerical linearization parameter: uncertainty not required.

^E Uncertainty is determined using the max. deviation from linear response applying rectangular distribution and is expressed for the square of the field value.

DASY/EASY - Parameters of Probe: EX3DV4 - SN:7531

Other Probe Parameters

Sensor Arrangement	Triangular
Connector Angle (°)	-173.3
Mechanical Surface Detection Mode	enabled
Optical Surface Detection Mode	disabled
Probe Overall Length	337 mm
Probe Body Diameter	10 mm
Tip Length	9 mm
Tip Diameter	2.5 mm
Probe Tip to Sensor X Calibration Point	1 mm
Probe Tip to Sensor Y Calibration Point	1 mm
Probe Tip to Sensor Z Calibration Point	1 mm
Recommended Measurement Distance from Surface	1.4 mm

Note: Measurement distance from surface can be increased to 3-4 mm for an *Area Scan* job.

DASY/EASY - Parameters of Probe: EX3DV4 - SN:7531

Calibration Parameter Determined in Head Tissue Simulating Media

f (MHz) ^C	Relative Permittivity ^F	Conductivity (S/m) ^F	ConvF X	ConvF Y	ConvF Z	Alpha ^G	Depth ^G (mm)	Unc (k=2)
150	52.3	0.76	12.88	12.88	12.88	0.00	1.00	± 13.3 %
220	49.0	0.81	12.66	12.66	12.66	0.00	1.00	± 13.3 %
300	45.3	0.87	12.13	12.13	12.13	0.03	1.30	± 13.3 %
450	43.5	0.87	11.31	11.31	11.31	0.13	1.30	± 13.3 %
600	42.7	0.88	10.87	10.87	10.87	0.08	1.30	± 13.3 %
750	41.9	0.89	10.64	10.64	10.64	0.29	1.14	± 12.0 %
900	41.5	0.97	10.26	10.26	10.26	0.46	0.82	± 12.0 %
1750	40.1	1.37	8.55	8.55	8.55	0.34	0.86	± 12.0 %
1900	40.0	1.40	8.22	8.22	8.22	0.30	0.86	± 12.0 %
2300	39.5	1.67	7.96	7.96	7.96	0.31	0.90	± 12.0 %
2450	39.2	1.80	7.61	7.61	7.61	0.29	0.90	± 12.0 %
2600	39.0	1.96	7.48	7.48	7.48	0.38	0.90	± 12.0 %
3500	37.9	2.91	6.73	6.73	6.73	0.40	1.35	± 13.1 %
3700	37.7	3.12	6.42	6.42	6.42	0.40	1.35	± 13.1 %
5250	35.9	4.71	5.20	5.20	5.20	0.40	1.80	± 13.1 %
5600	35.5	5.07	4.66	4.66	4.66	0.40	1.80	± 13.1 %
5750	35.4	5.22	4.80	4.80	4.80	0.40	1.80	± 13.1 %

^C Frequency validity above 300 MHz of ± 100 MHz only applies for DASY v4.4 and higher (see Page 2), else it is restricted to ± 50 MHz. The uncertainty is the RSS of the ConvF uncertainty at calibration frequency and the uncertainty for the indicated frequency band. Frequency validity below 300 MHz is ± 10, 25, 40, 50 and 70 MHz for ConvF assessments at 30, 64, 128, 150 and 220 MHz respectively. Validity of ConvF assessed at 6 MHz is 4-9 MHz, and ConvF assessed at 13 MHz is 9-19 MHz. Above 5 GHz frequency validity can be extended to ± 110 MHz.

^F At frequencies below 3 GHz, the validity of tissue parameters (ϵ and σ) can be relaxed to ± 10% if liquid compensation formula is applied to measured SAR values. At frequencies above 3 GHz, the validity of tissue parameters (ϵ and σ) is restricted to ± 5%. The uncertainty is the RSS of the ConvF uncertainty for indicated target tissue parameters.

^G Alpha/Depth are determined during calibration. SPEAG warrants that the remaining deviation due to the boundary effect after compensation is always less than ± 1% for frequencies below 3 GHz and below ± 2% for frequencies between 3-6 GHz at any distance larger than half the probe tip diameter from the boundary.

Frequency Response of E-Field (TEM-Cell:ifi110 EXX, Waveguide: R22)

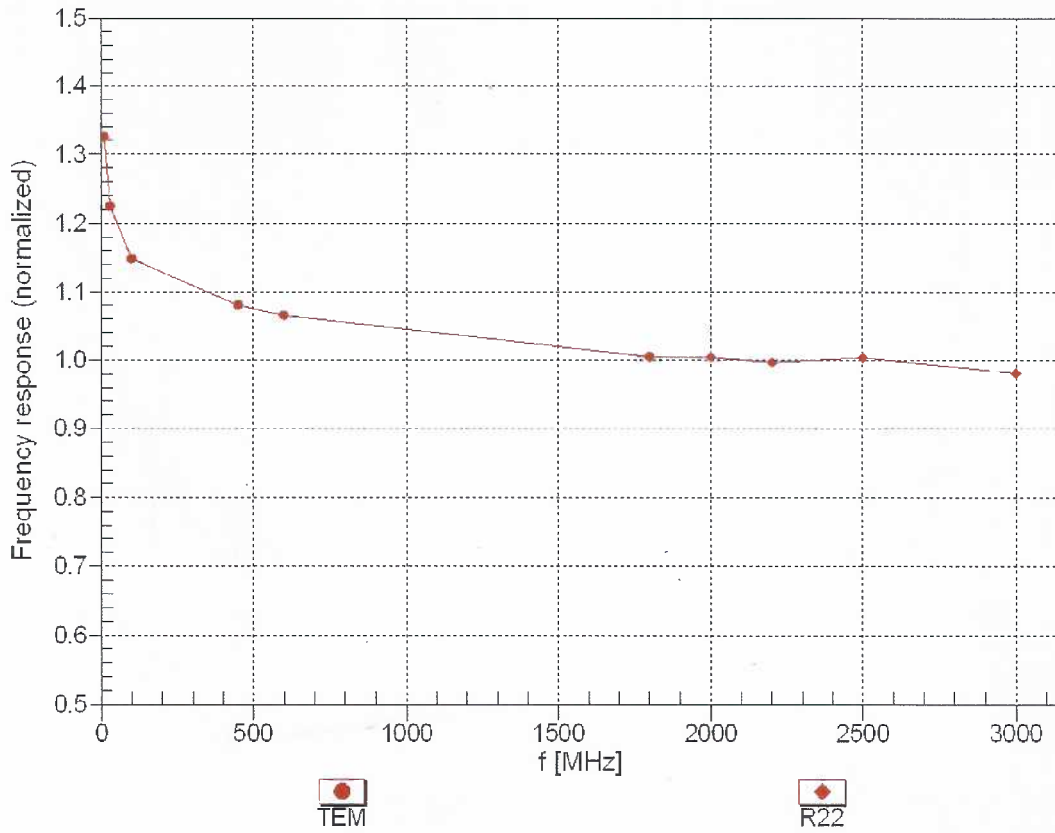

Uncertainty of Frequency Response of E-field: $\pm 6.3\%$ (k=2)

Receiving Pattern (ϕ), $\theta = 0^\circ$

f=600 MHz,TEM

f=1800 MHz,R22

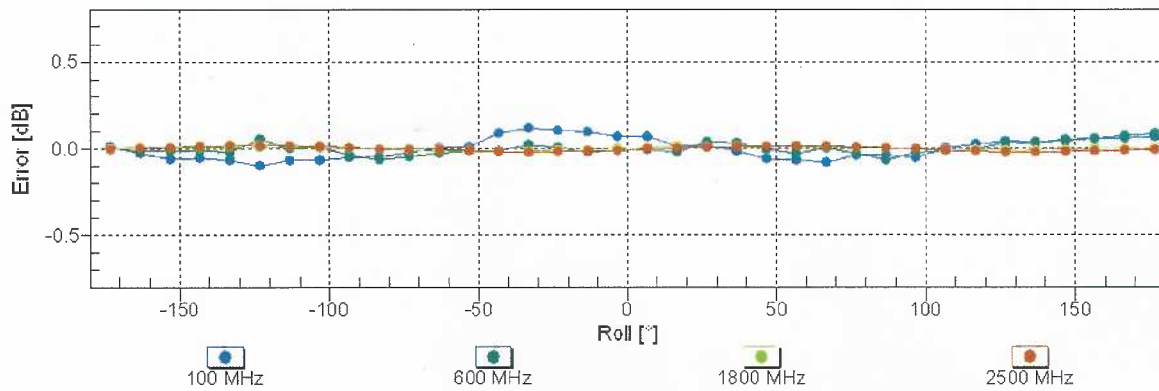
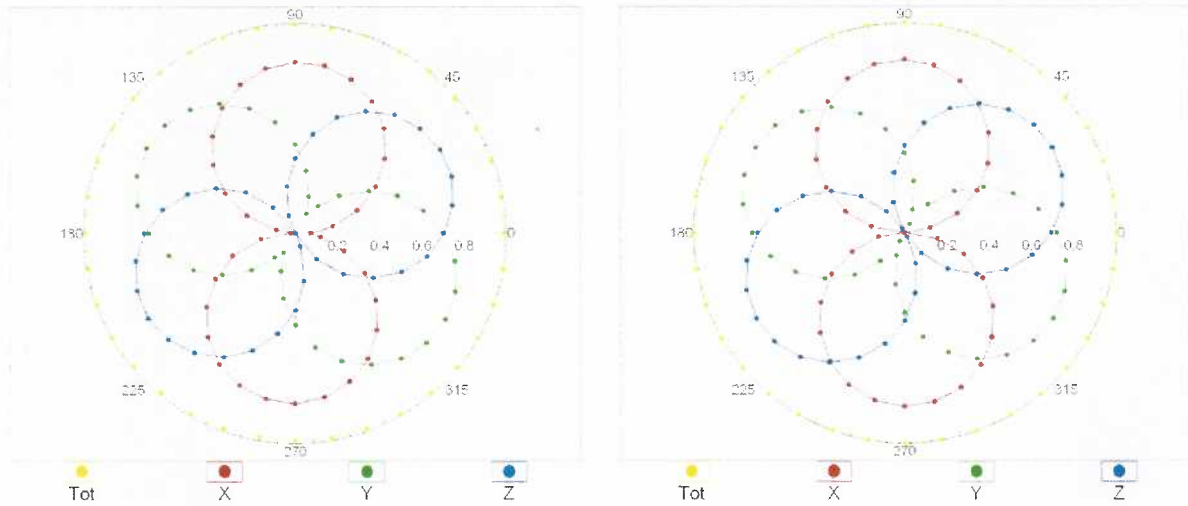

Uncertainty of Axial Isotropy Assessment: $\pm 0.5\%$ ($k=2$)

Dynamic Range $f(SAR_{head})$ (TEM cell , $f_{eval} = 1900$ MHz)

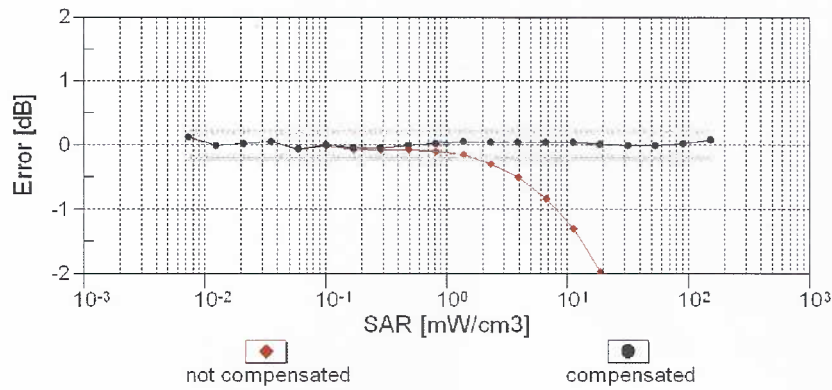
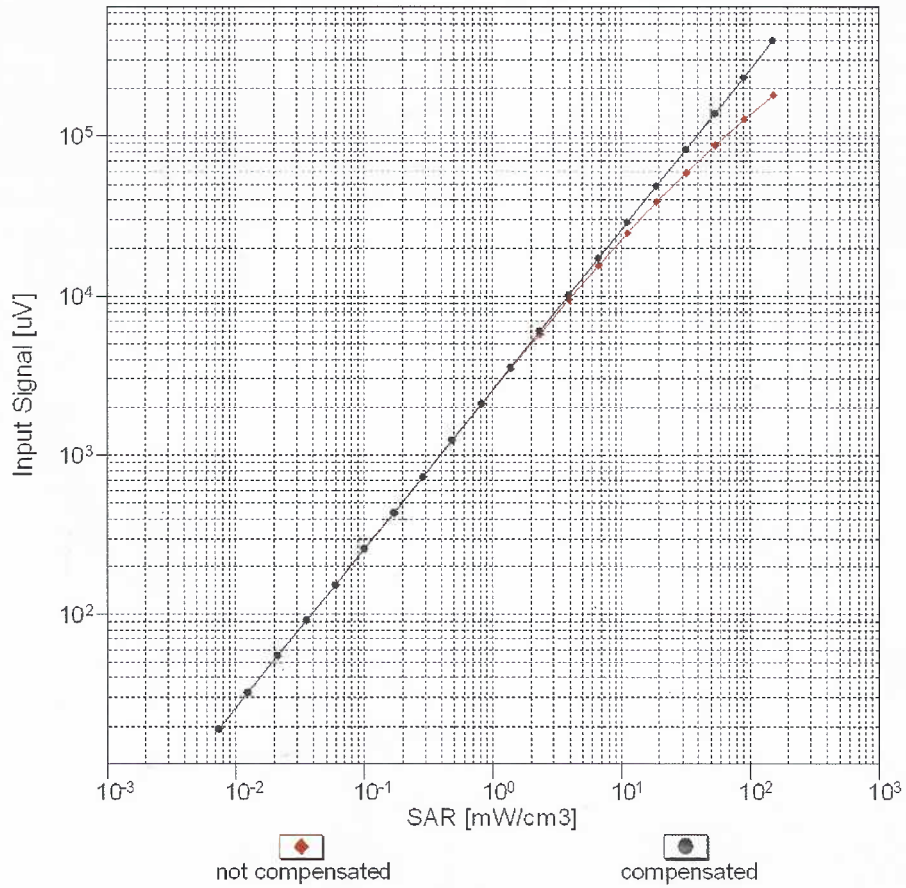

Uncertainty of Linearity Assessment: $\pm 0.6\%$ (k=2)

Conversion Factor Assessment

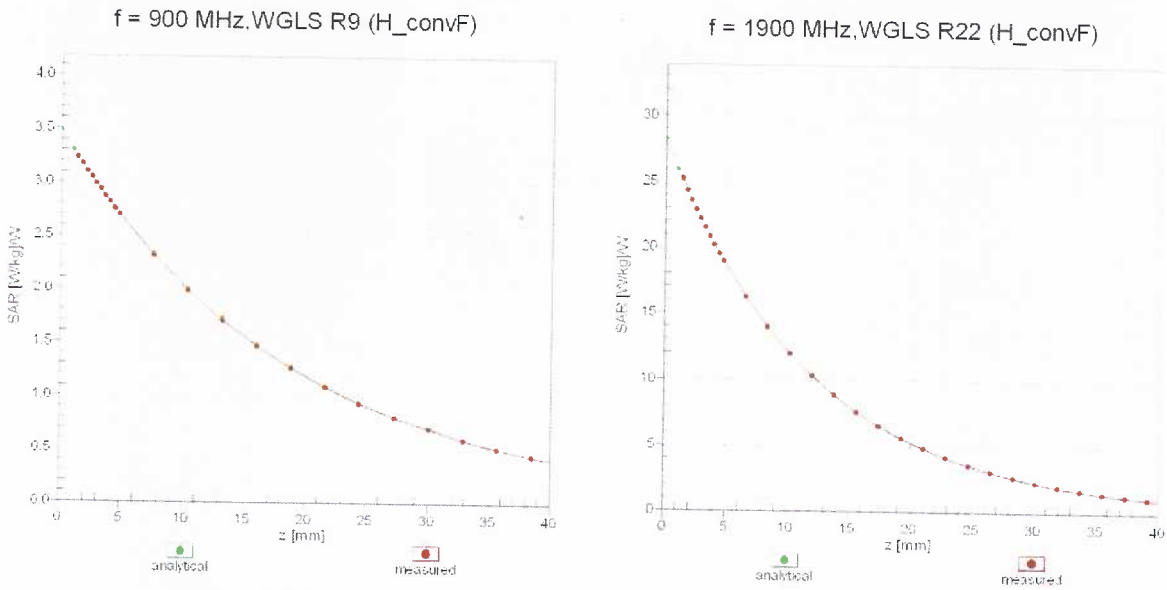

Deviation from Isotropy in Liquid Error (ϕ, θ), f = 900 MHz

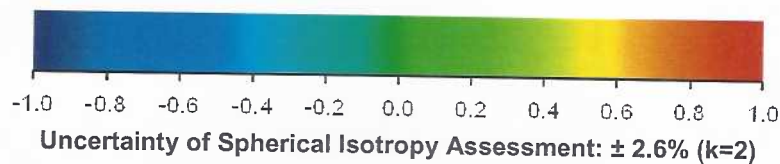
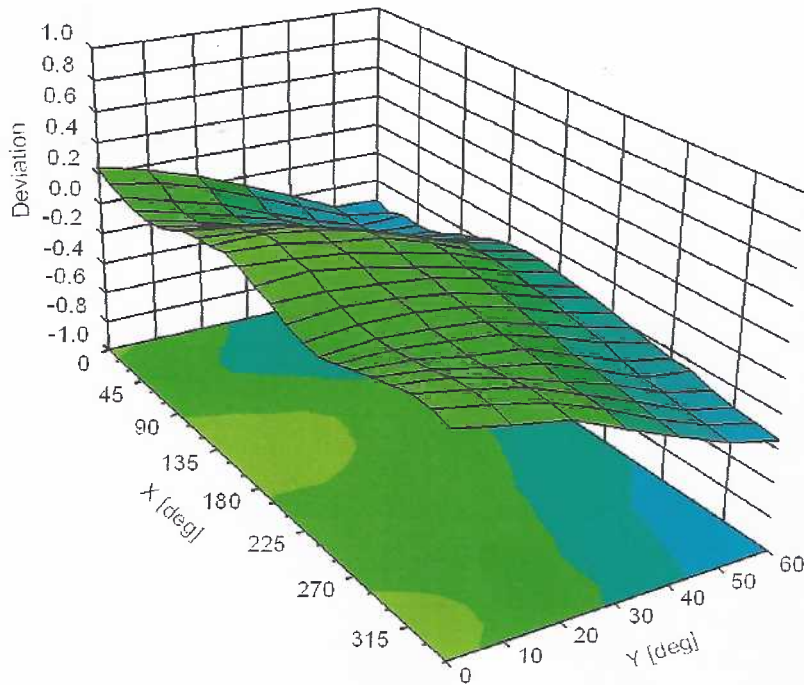

Appendix E – Dipole Calibration Data Sheets



Accredited by the Swiss Accreditation Service (SAS)
The Swiss Accreditation Service is one of the signatories to the EA
Multilateral Agreement for the recognition of calibration certificates

Accreditation No.: **SCS 0108**

Client **RF Exposure Lab**

Certificate No: **D750V3-1016_Jul18**

CALIBRATION CERTIFICATE

Object **D750V3 - SN:1016**

Calibration procedure(s) **QA CAL-05.v10
Calibration procedure for dipole validation kits above 700 MHz**

Calibration date: **July 13, 2018**

This calibration certificate documents the traceability to national standards, which realize the physical units of measurements (SI).
The measurements and the uncertainties with confidence probability are given on the following pages and are part of the certificate.

All calibrations have been conducted in the closed laboratory facility: environment temperature (22 ± 3)°C and humidity < 70%.

Calibration Equipment used (M&TE critical for calibration)

Primary Standards	ID #	Cal Date (Certificate No.)	Scheduled Calibration
Power meter NRP	SN: 104778	04-Apr-18 (No. 217-02672/02673)	Apr-19
Power sensor NRP-Z91	SN: 103244	04-Apr-18 (No. 217-02672)	Apr-19
Power sensor NRP-Z91	SN: 103245	04-Apr-18 (No. 217-02673)	Apr-19
Reference 20 dB Attenuator	SN: 5058 (20k)	04-Apr-18 (No. 217-02682)	Apr-19
Type-N mismatch combination	SN: 5047.2 / 06327	04-Apr-18 (No. 217-02683)	Apr-19
Reference Probe EX3DV4	SN: 7349	30-Dec-17 (No. EX3-7349_Dec17)	Dec-18
DAE4	SN: 601	26-Oct-17 (No. DAE4-601_Oct17)	Oct-18

Secondary Standards	ID #	Check Date (in house)	Scheduled Check
Power meter EPM-442A	SN: GB37480704	07-Oct-15 (in house check Oct-16)	In house check: Oct-18
Power sensor HP 8481A	SN: US37292783	07-Oct-15 (in house check Oct-16)	In house check: Oct-18
Power sensor HP 8481A	SN: MY41092317	07-Oct-15 (in house check Oct-16)	In house check: Oct-18
RF generator R&S SMT-06	SN: 100972	15-Jun-15 (in house check Oct-16)	In house check: Oct-18
Network Analyzer Agilent E8358A	SN: US41080477	31-Mar-14 (in house check Oct-17)	In house check: Oct-18

Calibrated by:	Name Manu Seitz	Function Laboratory Technician	Signature
Approved by:	Name Katja Pokovic	Technical Manager	

Issued: July 16, 2018

This calibration certificate shall not be reproduced except in full without written approval of the laboratory.



Accredited by the Swiss Accreditation Service (SAS)

The Swiss Accreditation Service is one of the signatories to the EA
Multilateral Agreement for the recognition of calibration certificates

Accreditation No.: **SCS 0108**

Glossary:

TSL	tissue simulating liquid
ConvF	sensitivity in TSL / NORM x,y,z
N/A	not applicable or not measured

Calibration is Performed According to the Following Standards:

- IEEE Std 1528-2013, "IEEE Recommended Practice for Determining the Peak Spatial-Averaged Specific Absorption Rate (SAR) in the Human Head from Wireless Communications Devices: Measurement Techniques", June 2013
- IEC 62209-1, "Measurement procedure for the assessment of Specific Absorption Rate (SAR) from hand-held and body-mounted devices used next to the ear (frequency range of 300 MHz to 6 GHz)", July 2016
- IEC 62209-2, "Procedure to determine the Specific Absorption Rate (SAR) for wireless communication devices used in close proximity to the human body (frequency range of 30 MHz to 6 GHz)", March 2010
- KDB 865664, "SAR Measurement Requirements for 100 MHz to 6 GHz"

Additional Documentation:

- DASY4/5 System Handbook

Methods Applied and Interpretation of Parameters:

- Measurement Conditions:** Further details are available from the Validation Report at the end of the certificate. All figures stated in the certificate are valid at the frequency indicated.
- Antenna Parameters with TSL:** The dipole is mounted with the spacer to position its feed point exactly below the center marking of the flat phantom section, with the arms oriented parallel to the body axis.
- Feed Point Impedance and Return Loss:** These parameters are measured with the dipole positioned under the liquid filled phantom. The impedance stated is transformed from the measurement at the SMA connector to the feed point. The Return Loss ensures low reflected power. No uncertainty required.
- Electrical Delay:** One-way delay between the SMA connector and the antenna feed point. No uncertainty required.
- SAR measured:** SAR measured at the stated antenna input power.
- SAR normalized:** SAR as measured, normalized to an input power of 1 W at the antenna connector.
- SAR for nominal TSL parameters:** The measured TSL parameters are used to calculate the nominal SAR result.

The reported uncertainty of measurement is stated as the standard uncertainty of measurement multiplied by the coverage factor $k=2$, which for a normal distribution corresponds to a coverage probability of approximately 95%.

Measurement Conditions

DASY system configuration, as far as not given on page 1.

DASY Version	DASY5	V52.10.1
Extrapolation	Advanced Extrapolation	
Phantom	Modular Flat Phantom	
Distance Dipole Center - TSL	15 mm	with Spacer
Zoom Scan Resolution	dx, dy, dz = 5 mm	
Frequency	750 MHz \pm 1 MHz	

Head TSL parameters

The following parameters and calculations were applied.

	Temperature	Permittivity	Conductivity
Nominal Head TSL parameters	22.0 °C	41.9	0.89 mho/m
Measured Head TSL parameters	(22.0 \pm 0.2) °C	40.9 \pm 6 %	0.89 mho/m \pm 6 %
Head TSL temperature change during test	< 0.5 °C	----	----

SAR result with Head TSL

SAR averaged over 1 cm³ (1 g) of Head TSL	Condition	
SAR measured	250 mW input power	2.07 W/kg
SAR for nominal Head TSL parameters	normalized to 1W	8.23 W/kg \pm 17.0 % (k=2)

SAR averaged over 10 cm³ (10 g) of Head TSL	condition	
SAR measured	250 mW input power	1.35 W/kg
SAR for nominal Head TSL parameters	normalized to 1W	5.38 W/kg \pm 16.5 % (k=2)

Body TSL parameters

The following parameters and calculations were applied.

	Temperature	Permittivity	Conductivity
Nominal Body TSL parameters	22.0 °C	55.5	0.96 mho/m
Measured Body TSL parameters	(22.0 \pm 0.2) °C	55.3 \pm 6 %	0.96 mho/m \pm 6 %
Body TSL temperature change during test	< 0.5 °C	----	----

SAR result with Body TSL

SAR averaged over 1 cm³ (1 g) of Body TSL	Condition	
SAR measured	250 mW input power	2.14 W/kg
SAR for nominal Body TSL parameters	normalized to 1W	8.55 W/kg \pm 17.0 % (k=2)

SAR averaged over 10 cm³ (10 g) of Body TSL	condition	
SAR measured	250 mW input power	1.41 W/kg
SAR for nominal Body TSL parameters	normalized to 1W	5.64 W/kg \pm 16.5 % (k=2)

Appendix (Additional assessments outside the scope of SCS 0108)

Antenna Parameters with Head TSL

Impedance, transformed to feed point	53.4 Ω + 0.0 $j\Omega$
Return Loss	- 29.6 dB

Antenna Parameters with Body TSL

Impedance, transformed to feed point	48.8 Ω - 2.6 $j\Omega$
Return Loss	- 30.7 dB

General Antenna Parameters and Design

Electrical Delay (one direction)	1.038 ns
----------------------------------	----------

After long term use with 100W radiated power, only a slight warming of the dipole near the feedpoint can be measured.

The dipole is made of standard semirigid coaxial cable. The center conductor of the feeding line is directly connected to the second arm of the dipole. The antenna is therefore short-circuited for DC-signals. On some of the dipoles, small end caps are added to the dipole arms in order to improve matching when loaded according to the position as explained in the "Measurement Conditions" paragraph. The SAR data are not affected by this change. The overall dipole length is still according to the Standard.

No excessive force must be applied to the dipole arms, because they might bend or the soldered connections near the feedpoint may be damaged.

Additional EUT Data

Manufactured by	SPEAG
Manufactured on	March 22, 2010

Extended Calibration

Usage of SAR dipoles calibrated less than 3 years ago but more than 1 year ago were confirmed in maintaining return loss (<-20 dB, within 20% of prior calibration) and impedance (within 5 ohm from prior calibration) requirements per extended calibrations in KDB Publication 865664 D01 v01r04.

D750V3 SN: 1016 - Head						
Date of Measurement	Return Loss (dB)	$\Delta\%$	Impedance Real (Ω)	$\Delta\Omega$	Impedance Imaginary ($j\Omega$)	$\Delta\Omega$
7/13/2018	-29.6		53.4		0.0	
7/13/2019	-28.2	-4.7	54.9	1.5	-0.2	-0.2
7/13/2020	-30.1	1.7	52.8	-0.6	0.1	0.1
D750V3 SN: 1016 - Body						
Date of Measurement	Return Loss (dB)	$\Delta\%$	Impedance Real (Ω)	$\Delta\Omega$	Impedance Imaginary ($j\Omega$)	$\Delta\Omega$
7/13/2018	-30.7		48.8		-2.6	
7/13/2019	-29.8	-2.9	49.2	0.4	-2.7	-0.1
7/13/2020	-31.1	1.1	47.6	-1.2	-2.5	0.1

DASY5 Validation Report for Head TSL

Date: 13.07.2018

Test Laboratory: SPEAG, Zurich, Switzerland

DUT: Dipole 750 MHz; Type: D750V3; Serial: D750V3 - SN:1016

Communication System: UID 0 - CW; Frequency: 750 MHz

Medium parameters used: $f = 750$ MHz; $\sigma = 0.89$ S/m; $\epsilon_r = 40.9$; $\rho = 1000$ kg/m³

Phantom section: Flat Section

Measurement Standard: DASY5 (IEEE/IEC/ANSI C63.19-2011)

DASY52 Configuration:

- Probe: EX3DV4 - SN7349; ConvF(10.22, 10.22, 10.22) @ 750 MHz; Calibrated: 30.12.2017
- Sensor-Surface: 1.4mm (Mechanical Surface Detection)
- Electronics: DAE4 Sn601; Calibrated: 26.10.2017
- Phantom: Flat Phantom 4.9 (front); Type: QD 00L P49 AA; Serial: 1001
- DASY52 52.10.1(1476); SEMCAD X 14.6.11(7439)

Dipole Calibration for Head Tissue/Pin=250 mW, d=15mm/Zoom Scan (7x7x7)/Cube 0:

Measurement grid: dx=5mm, dy=5mm, dz=5mm

Reference Value = 59.03 V/m; Power Drift = -0.03 dB

Peak SAR (extrapolated) = 3.10 W/kg

SAR(1 g) = 2.07 W/kg; SAR(10 g) = 1.35 W/kg

Maximum value of SAR (measured) = 2.76 W/kg

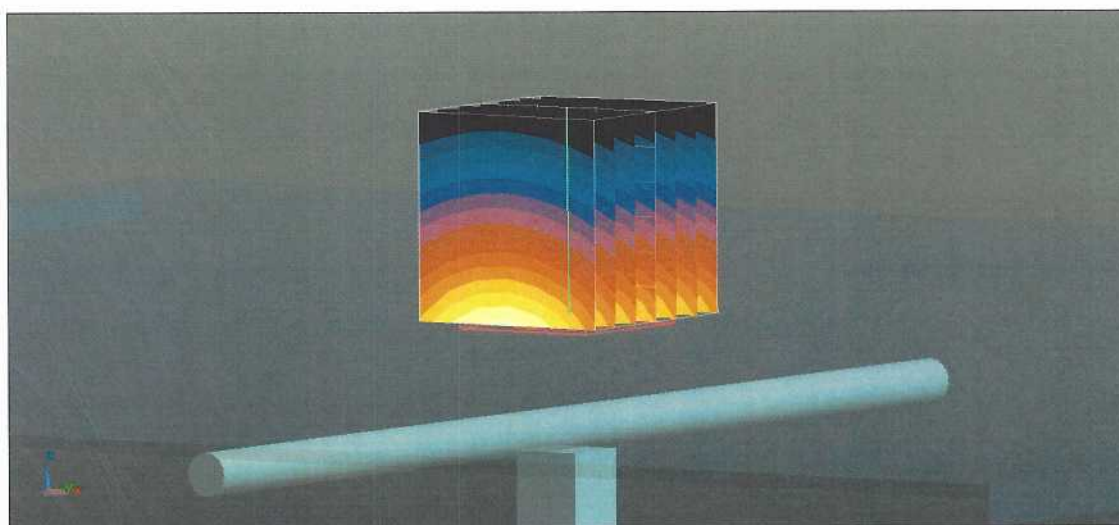
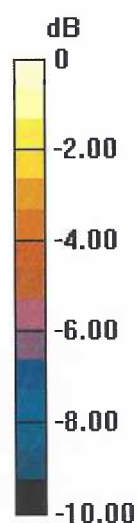

0 dB = 2.76 W/kg = 4.41 dBW/kg

Impedance Measurement Plot for Head TSL

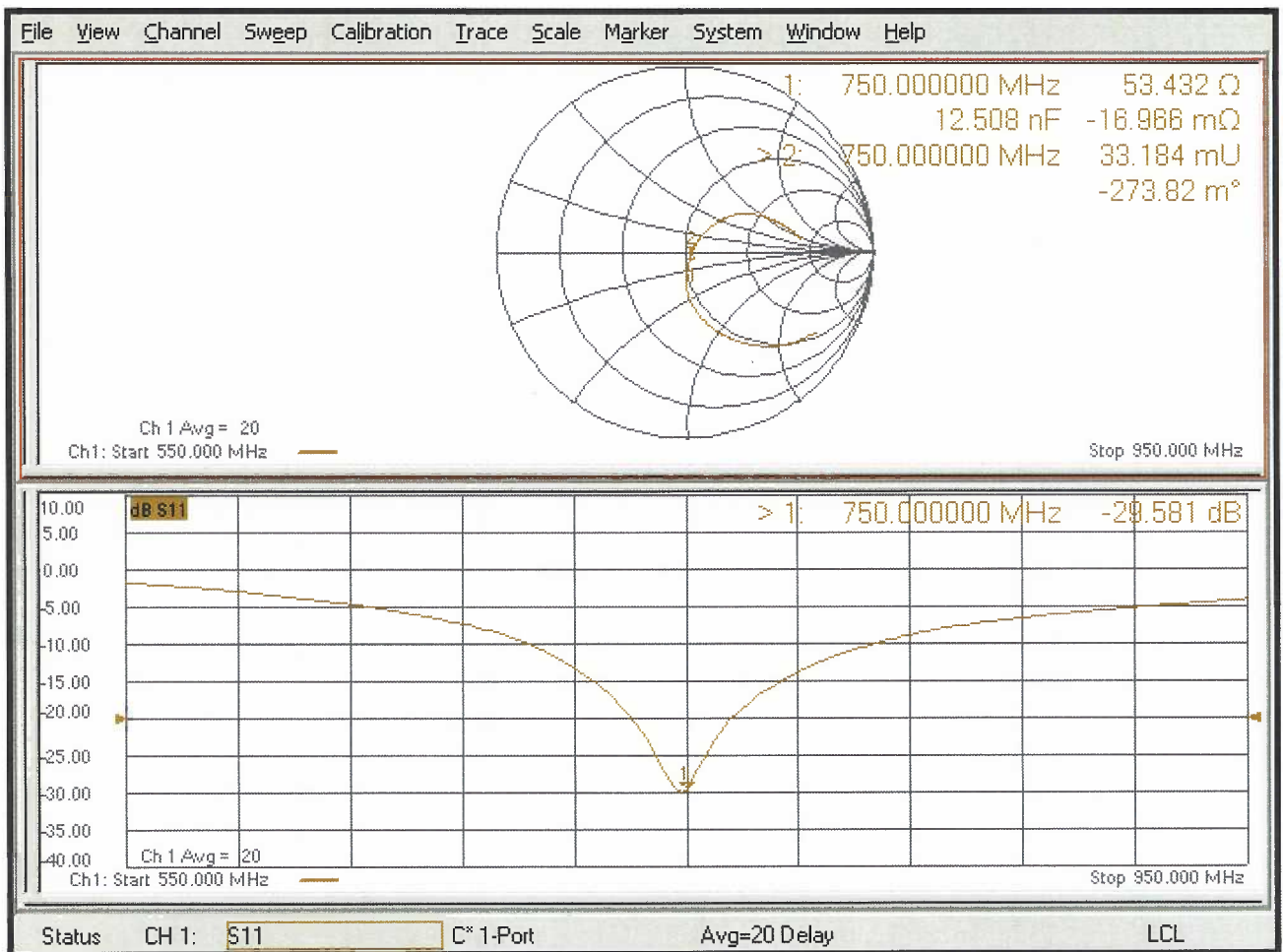

DASY5 Validation Report for Body TSL

Date: 13.07.2018

Test Laboratory: SPEAG, Zurich, Switzerland

DUT: Dipole 750 MHz; Type: D750V3; Serial: D750V3 - SN:1016

Communication System: UID 0 - CW; Frequency: 750 MHz

Medium parameters used: $f = 750$ MHz; $\sigma = 0.96$ S/m; $\epsilon_r = 55.3$; $\rho = 1000$ kg/m³

Phantom section: Flat Section

Measurement Standard: DASY5 (IEEE/IEC/ANSI C63.19-2011)

DASY52 Configuration:

- Probe: EX3DV4 - SN7349; ConvF(10.19, 10.19, 10.19) @ 750 MHz; Calibrated: 30.12.2017
- Sensor-Surface: 1.4mm (Mechanical Surface Detection)
- Electronics: DAE4 Sn601; Calibrated: 26.10.2017
- Phantom: Flat Phantom 4.9 (Back); Type: QD 00R P49 AA; Serial: 1005
- DASY52 52.10.1(1476); SEMCAD X 14.6.11(7439)

Dipole Calibration for Body Tissue/Pin=250 mW, d=15mm/Zoom Scan (7x7x7)/Cube 0:

Measurement grid: dx=5mm, dy=5mm, dz=5mm

Reference Value = 57.68 V/m; Power Drift = -0.03 dB

Peak SAR (extrapolated) = 3.18 W/kg

SAR(1 g) = 2.14 W/kg; SAR(10 g) = 1.41 W/kg

Maximum value of SAR (measured) = 2.84 W/kg

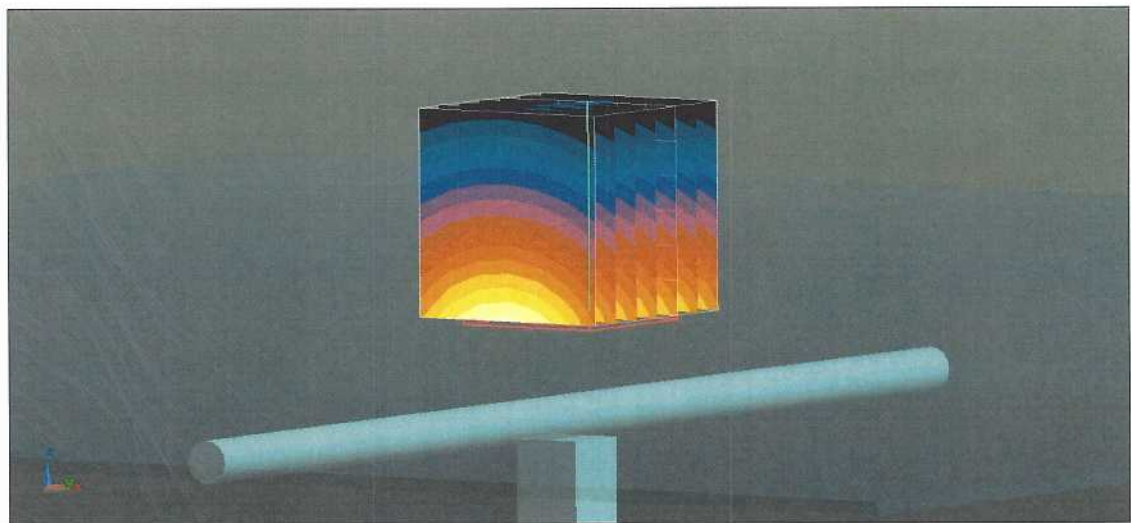
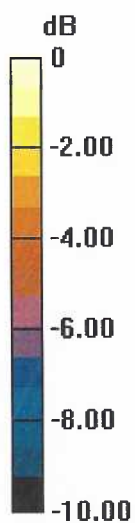

0 dB = 2.84 W/kg = 4.53 dBW/kg

Impedance Measurement Plot for Body TSL

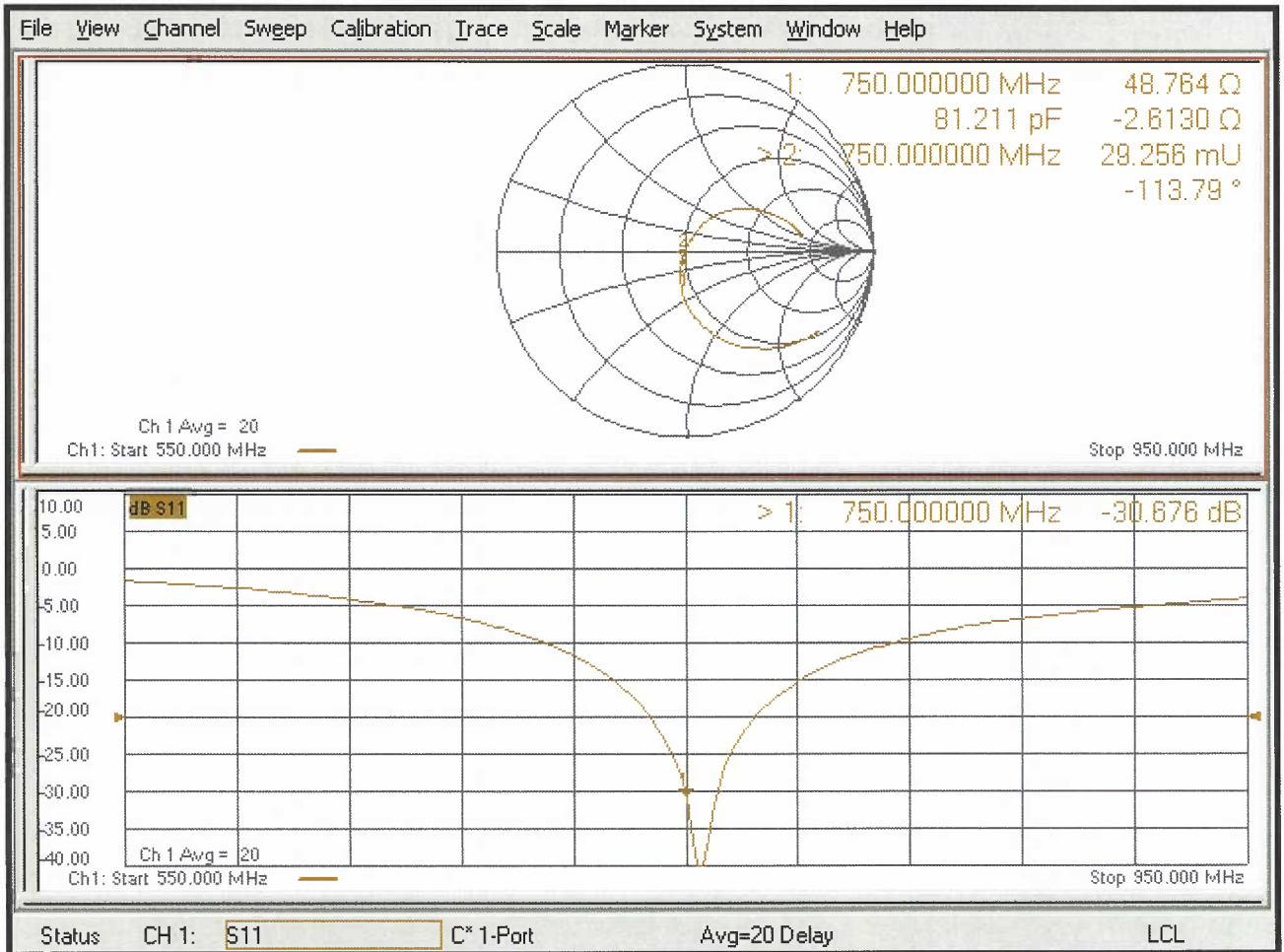



Accredited by the Swiss Accreditation Service (SAS)

Accreditation No.: **SCS 0108**

The Swiss Accreditation Service is one of the signatories to the EA
Multilateral Agreement for the recognition of calibration certificates

Client **RF Exposure Lab**

Certificate No: **D835V2-4d089_Jul18**

CALIBRATION CERTIFICATE

Object **D835V2 - SN:4d089**

Calibration procedure(s) **QA CAL-05.v10
Calibration procedure for dipole validation kits above 700 MHz**

Calibration date: **July 13, 2018**

This calibration certificate documents the traceability to national standards, which realize the physical units of measurements (SI).
The measurements and the uncertainties with confidence probability are given on the following pages and are part of the certificate.

All calibrations have been conducted in the closed laboratory facility: environment temperature (22 ± 3)°C and humidity < 70%.

Calibration Equipment used (M&TE critical for calibration)

Primary Standards	ID #	Cal Date (Certificate No.)	Scheduled Calibration
Power meter NRP	SN: 104778	04-Apr-18 (No. 217-02672/02673)	Apr-19
Power sensor NRP-Z91	SN: 103244	04-Apr-18 (No. 217-02672)	Apr-19
Power sensor NRP-Z91	SN: 103245	04-Apr-18 (No. 217-02673)	Apr-19
Reference 20 dB Attenuator	SN: 5058 (20k)	04-Apr-18 (No. 217-02682)	Apr-19
Type-N mismatch combination	SN: 5047.2 / 06327	04-Apr-18 (No. 217-02683)	Apr-19
Reference Probe EX3DV4	SN: 7349	30-Dec-17 (No. EX3-7349_Dec17)	Dec-18
DAE4	SN: 601	26-Oct-17 (No. DAE4-601_Oct17)	Oct-18

Secondary Standards	ID #	Check Date (in house)	Scheduled Check
Power meter EPM-442A	SN: GB37480704	07-Oct-15 (in house check Oct-16)	In house check: Oct-18
Power sensor HP 8481A	SN: US37292783	07-Oct-15 (in house check Oct-16)	In house check: Oct-18
Power sensor HP 8481A	SN: MY41092317	07-Oct-15 (in house check Oct-16)	In house check: Oct-18
RF generator R&S SMT-06	SN: 100972	15-Jun-15 (in house check Oct-16)	In house check: Oct-18
Network Analyzer Agilent E8358A	SN: US41080477	31-Mar-14 (in house check Oct-17)	In house check: Oct-18

	Name	Function	Signature
Calibrated by:	Manu Seitz	Laboratory Technician	
Approved by:	Katja Pokovic	Technical Manager	

Issued: July 17, 2018

This calibration certificate shall not be reproduced except in full without written approval of the laboratory.



Accredited by the Swiss Accreditation Service (SAS)
The Swiss Accreditation Service is one of the signatories to the EA
Multilateral Agreement for the recognition of calibration certificates

Accreditation No.: **SCS 0108**

Glossary:

TSL	tissue simulating liquid
ConvF	sensitivity in TSL / NORM x,y,z
N/A	not applicable or not measured

Calibration is Performed According to the Following Standards:

- a) IEEE Std 1528-2013, "IEEE Recommended Practice for Determining the Peak Spatial-Averaged Specific Absorption Rate (SAR) in the Human Head from Wireless Communications Devices: Measurement Techniques", June 2013
- b) IEC 62209-1, "Measurement procedure for the assessment of Specific Absorption Rate (SAR) from hand-held and body-mounted devices used next to the ear (frequency range of 300 MHz to 6 GHz)", July 2016
- c) IEC 62209-2, "Procedure to determine the Specific Absorption Rate (SAR) for wireless communication devices used in close proximity to the human body (frequency range of 30 MHz to 6 GHz)", March 2010
- d) KDB 865664, "SAR Measurement Requirements for 100 MHz to 6 GHz"

Additional Documentation:

- e) DASY4/5 System Handbook

Methods Applied and Interpretation of Parameters:

- *Measurement Conditions:* Further details are available from the Validation Report at the end of the certificate. All figures stated in the certificate are valid at the frequency indicated.
- *Antenna Parameters with TSL:* The dipole is mounted with the spacer to position its feed point exactly below the center marking of the flat phantom section, with the arms oriented parallel to the body axis.
- *Feed Point Impedance and Return Loss:* These parameters are measured with the dipole positioned under the liquid filled phantom. The impedance stated is transformed from the measurement at the SMA connector to the feed point. The Return Loss ensures low reflected power. No uncertainty required.
- *Electrical Delay:* One-way delay between the SMA connector and the antenna feed point. No uncertainty required.
- *SAR measured:* SAR measured at the stated antenna input power.
- *SAR normalized:* SAR as measured, normalized to an input power of 1 W at the antenna connector.
- *SAR for nominal TSL parameters:* The measured TSL parameters are used to calculate the nominal SAR result.

The reported uncertainty of measurement is stated as the standard uncertainty of measurement multiplied by the coverage factor $k=2$, which for a normal distribution corresponds to a coverage probability of approximately 95%.

Measurement Conditions

DASY system configuration, as far as not given on page 1.

DASY Version	DASY5	V52.10.1
Extrapolation	Advanced Extrapolation	
Phantom	Modular Flat Phantom	
Distance Dipole Center - TSL	15 mm	with Spacer
Zoom Scan Resolution	dx, dy, dz = 5 mm	
Frequency	835 MHz ± 1 MHz	

Head TSL parameters

The following parameters and calculations were applied.

	Temperature	Permittivity	Conductivity
Nominal Head TSL parameters	22.0 °C	41.5	0.90 mho/m
Measured Head TSL parameters	(22.0 ± 0.2) °C	40.7 ± 6 %	0.92 mho/m ± 6 %
Head TSL temperature change during test	< 0.5 °C	----	----

SAR result with Head TSL

SAR averaged over 1 cm³ (1 g) of Head TSL	Condition	
SAR measured	250 mW input power	2.41 W/kg
SAR for nominal Head TSL parameters	normalized to 1W	9.44 W/kg ± 17.0 % (k=2)

SAR averaged over 10 cm³ (10 g) of Head TSL	condition	
SAR measured	250 mW input power	1.55 W/kg
SAR for nominal Head TSL parameters	normalized to 1W	6.10 W/kg ± 16.5 % (k=2)

Body TSL parameters

The following parameters and calculations were applied.

	Temperature	Permittivity	Conductivity
Nominal Body TSL parameters	22.0 °C	55.2	0.97 mho/m
Measured Body TSL parameters	(22.0 ± 0.2) °C	55.2 ± 6 %	0.99 mho/m ± 6 %
Body TSL temperature change during test	< 0.5 °C	----	----

SAR result with Body TSL

SAR averaged over 1 cm³ (1 g) of Body TSL	Condition	
SAR measured	250 mW input power	2.43 W/kg
SAR for nominal Body TSL parameters	normalized to 1W	9.57 W/kg ± 17.0 % (k=2)

SAR averaged over 10 cm³ (10 g) of Body TSL	condition	
SAR measured	250 mW input power	1.58 W/kg
SAR for nominal Body TSL parameters	normalized to 1W	6.24 W/kg ± 16.5 % (k=2)

Appendix (Additional assessments outside the scope of SCS 0108)

Antenna Parameters with Head TSL

Impedance, transformed to feed point	51.6 Ω - 3.3 j Ω
Return Loss	- 28.9 dB

Antenna Parameters with Body TSL

Impedance, transformed to feed point	47.3 Ω - 5.3 j Ω
Return Loss	- 24.3 dB

General Antenna Parameters and Design

Electrical Delay (one direction)	1.391 ns
----------------------------------	----------

After long term use with 100W radiated power, only a slight warming of the dipole near the feedpoint can be measured.

The dipole is made of standard semirigid coaxial cable. The center conductor of the feeding line is directly connected to the second arm of the dipole. The antenna is therefore short-circuited for DC-signals. On some of the dipoles, small end caps are added to the dipole arms in order to improve matching when loaded according to the position as explained in the "Measurement Conditions" paragraph. The SAR data are not affected by this change. The overall dipole length is still according to the Standard.

No excessive force must be applied to the dipole arms, because they might bend or the soldered connections near the feedpoint may be damaged.

Additional EUT Data

Manufactured by	SPEAG
Manufactured on	October 17, 2008

Extended Calibration

Usage of SAR dipoles calibrated less than 3 years ago but more than 1 year ago were confirmed in maintaining return loss (<-20 dB, within 20% of prior calibration) and impedance (within 5 ohm from prior calibration) requirements per extended calibrations in KDB Publication 865664 D01 v01r04.

D835V2 SN: 4d089 - Head						
Date of Measurement	Return Loss (dB)	$\Delta\%$	Impedance Real (Ω)	$\Delta\Omega$	Impedance Imaginary (j Ω)	$\Delta\Omega$
7/13/2018	-28.9		51.6		-3.3	
7/13/2019	-30.2	4.5	52.5	0.9	-2.9	0.4
7/13/2020	-29.4	1.7	50.9	-0.7	-3.7	-0.4
D835V2 SN: 4d089 - Body						
Date of Measurement	Return Loss (dB)	$\Delta\%$	Impedance Real (Ω)	$\Delta\Omega$	Impedance Imaginary (j Ω)	$\Delta\Omega$
7/13/2018	-24.3		47.3		-5.3	
7/13/2019	-25.6	5.3	48.3	1.0	-5.2	0.1
7/13/2020	-23.7	-2.5	46.9	-0.4	-5.6	-0.3

DASY5 Validation Report for Head TSL

Date: 13.07.2018

Test Laboratory: SPEAG, Zurich, Switzerland

DUT: Dipole 835 MHz; Type: D835V2; Serial: D835V2 - SN:4d089

Communication System: UID 0 - CW; Frequency: 835 MHz

Medium parameters used: $f = 835 \text{ MHz}$; $\sigma = 0.92 \text{ S/m}$; $\epsilon_r = 40.7$; $\rho = 1000 \text{ kg/m}^3$

Phantom section: Flat Section

Measurement Standard: DASY5 (IEEE/IEC/ANSI C63.19-2011)

DASY52 Configuration:

- Probe: EX3DV4 - SN7349; ConvF(9.9, 9.9, 9.9) @ 835 MHz; Calibrated: 30.12.2017
- Sensor-Surface: 1.4mm (Mechanical Surface Detection)
- Electronics: DAE4 Sn601; Calibrated: 26.10.2017
- Phantom: Flat Phantom 4.9 (front); Type: QD 00L P49 AA; Serial: 1001
- DASY52 52.10.1(1476); SEMCAD X 14.6.11(7439)

Dipole Calibration for Head Tissue/Pin=250 mW, d=15mm/Zoom Scan (7x7x7)/Cube 0:

Measurement grid: $dx=5\text{mm}$, $dy=5\text{mm}$, $dz=5\text{mm}$

Reference Value = 62.80 V/m; Power Drift = -0.03 dB

Peak SAR (extrapolated) = 3.70 W/kg

SAR(1 g) = 2.41 W/kg; SAR(10 g) = 1.55 W/kg

Maximum value of SAR (measured) = 3.26 W/kg

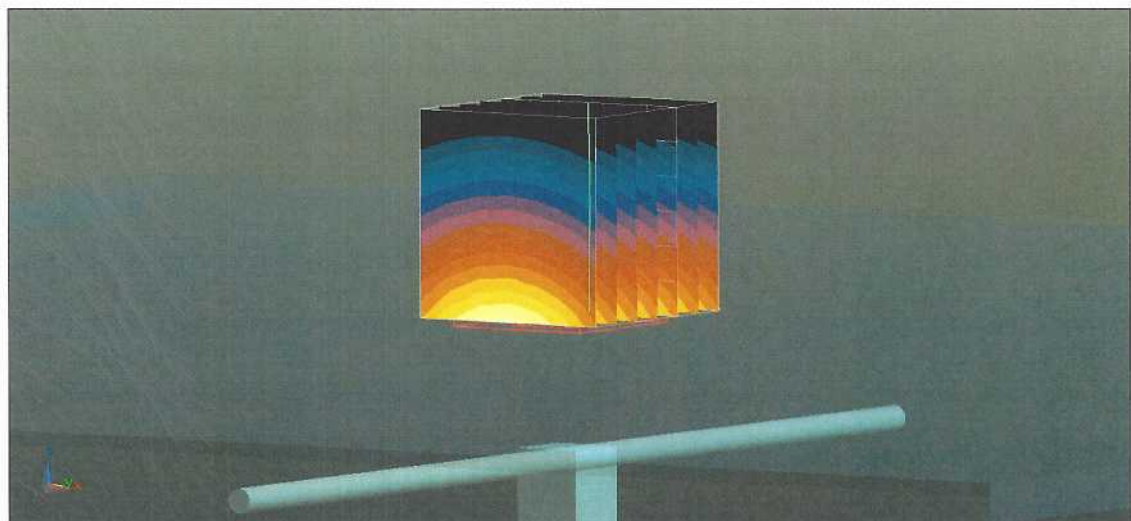
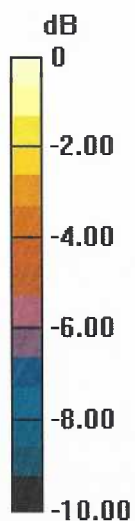

0 dB = 3.26 W/kg = 5.13 dBW/kg

Impedance Measurement Plot for Head TSL

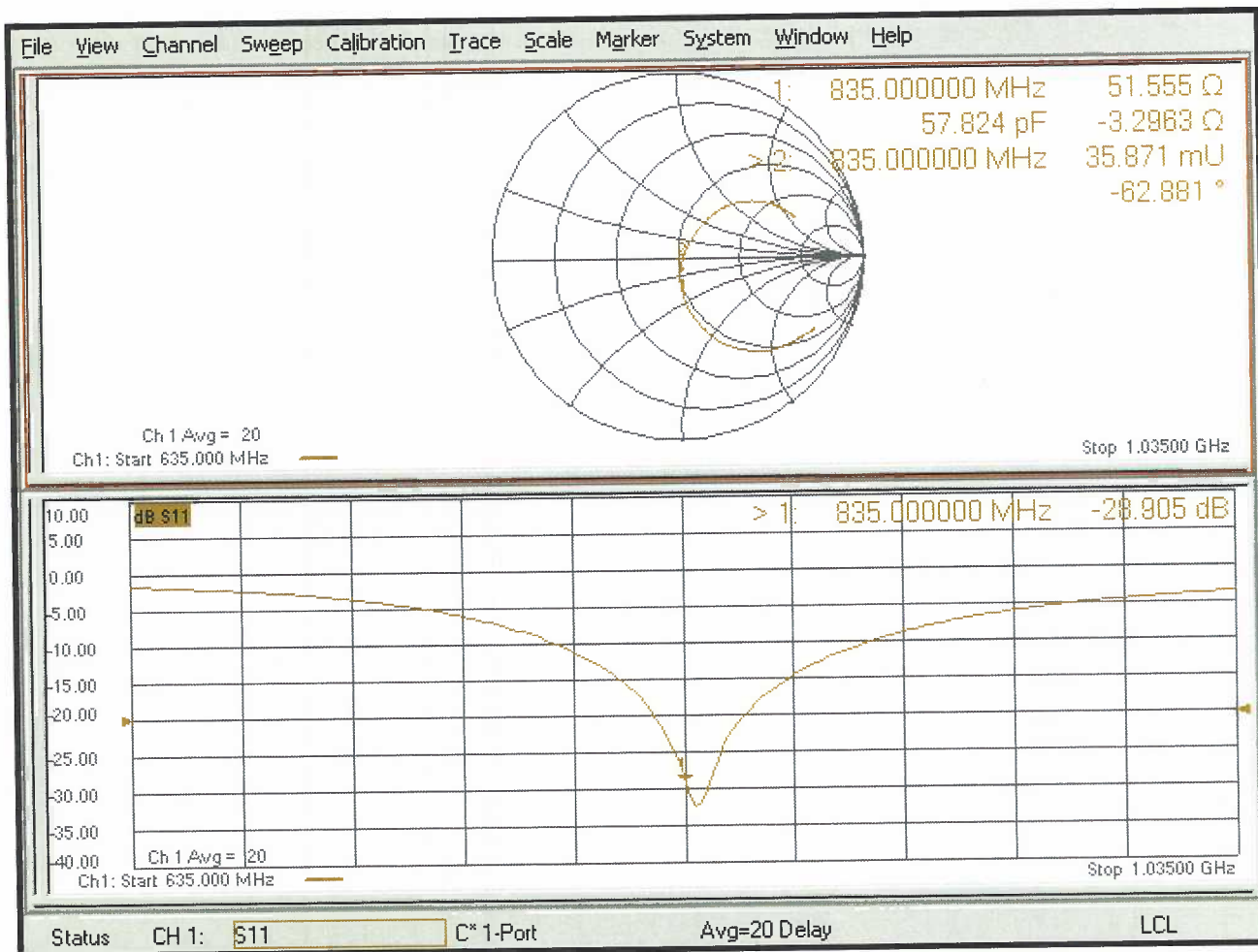

DASY5 Validation Report for Body TSL

Date: 13.07.2018

Test Laboratory: SPEAG, Zurich, Switzerland

DUT: Dipole 835 MHz; Type: D835V2; Serial: D835V2 - SN:4d089

Communication System: UID 0 - CW; Frequency: 835 MHz

Medium parameters used: $f = 835 \text{ MHz}$; $\sigma = 0.99 \text{ S/m}$; $\epsilon_r = 55.2$; $\rho = 1000 \text{ kg/m}^3$

Phantom section: Flat Section

Measurement Standard: DASY5 (IEEE/IEC/ANSI C63.19-2011)

DASY52 Configuration:

- Probe: EX3DV4 - SN7349; ConvF(10.05, 10.05, 10.05) @ 835 MHz; Calibrated: 30.12.2017
- Sensor-Surface: 1.4mm (Mechanical Surface Detection)
- Electronics: DAE4 Sn601; Calibrated: 26.10.2017
- Phantom: Flat Phantom 4.9 (Back); Type: QD 00R P49 AA; Serial: 1005
- DASY52 52.10.1(1476); SEMCAD X 14.6.11(7439)

Dipole Calibration for Body Tissue/Pin=250 mW, d=15mm/Zoom Scan (7x7x7)/Cube 0:

Measurement grid: $dx=5\text{mm}$, $dy=5\text{mm}$, $dz=5\text{mm}$

Reference Value = 60.59 V/m; Power Drift = -0.03 dB

Peak SAR (extrapolated) = 3.60 W/kg

SAR(1 g) = 2.43 W/kg; SAR(10 g) = 1.58 W/kg

Maximum value of SAR (measured) = 3.22 W/kg

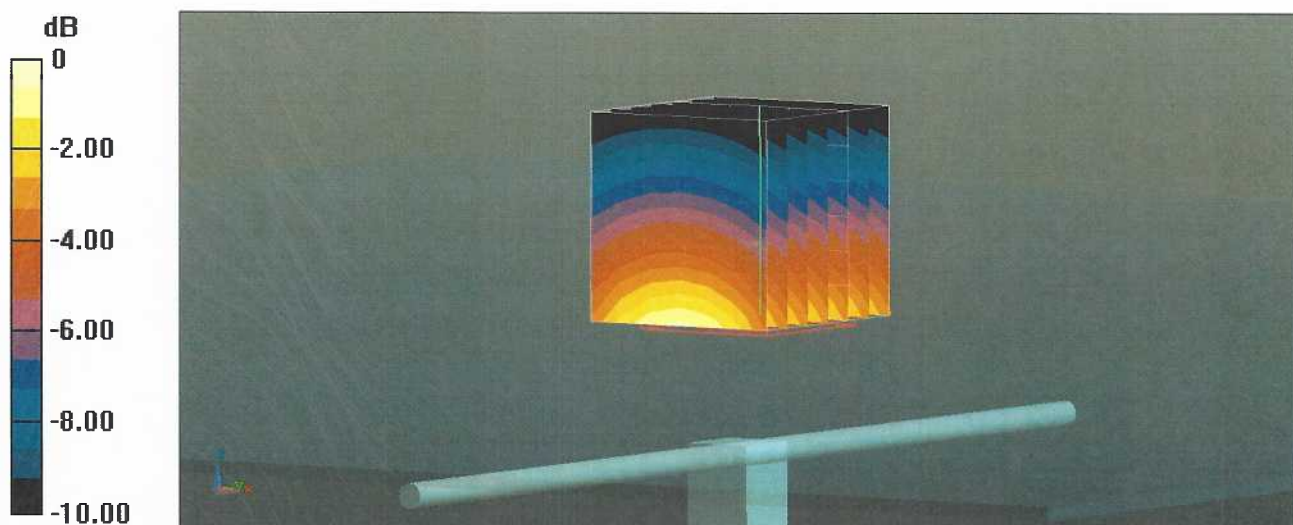

0 dB = 3.22 W/kg = 5.08 dBW/kg

Impedance Measurement Plot for Body TSL

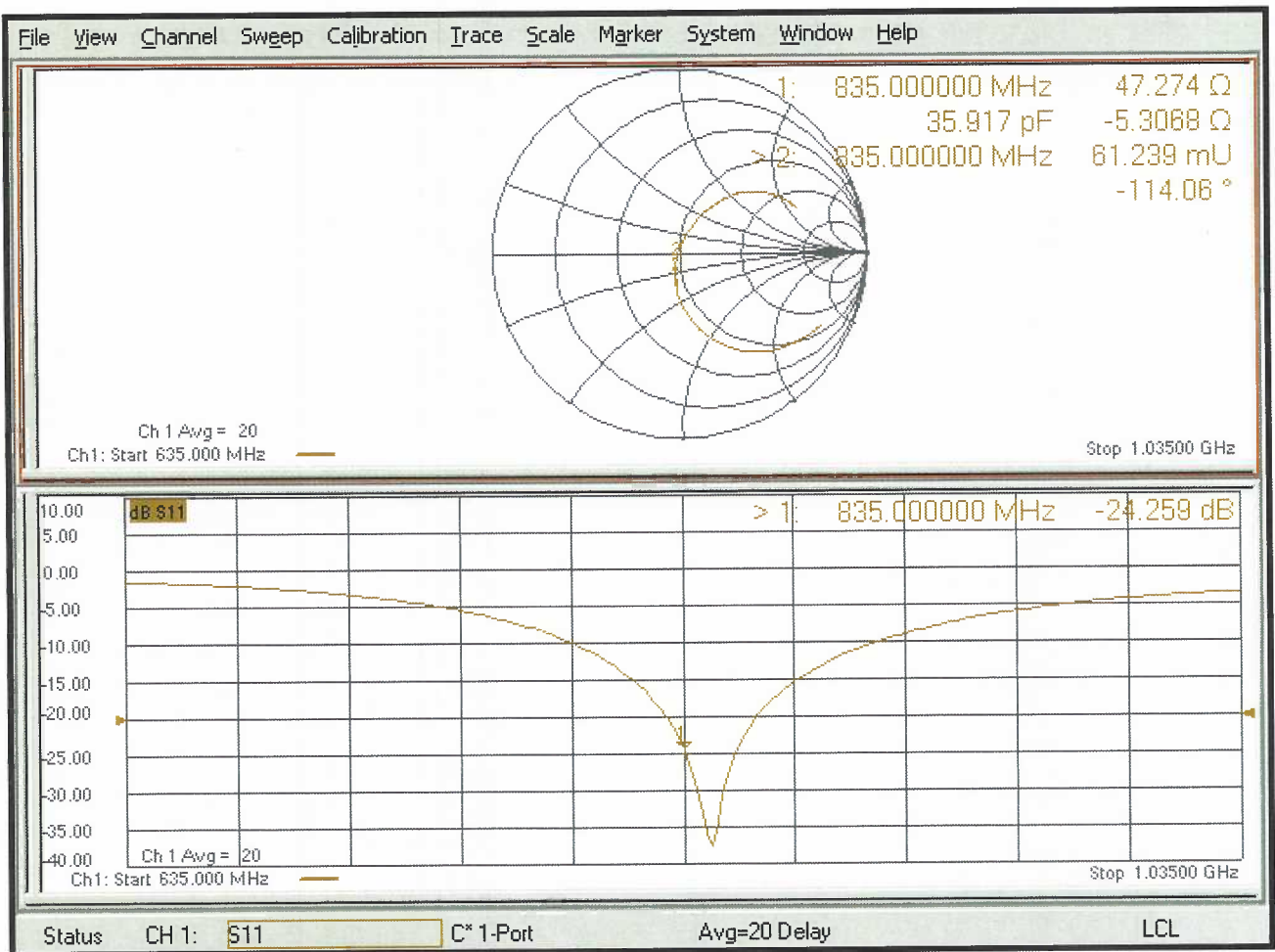



Accredited by the Swiss Accreditation Service (SAS)
The Swiss Accreditation Service is one of the signatories to the EA
Multilateral Agreement for the recognition of calibration certificates

Accreditation No.: **SCS 0108**

Client **RF Exposure Lab**

Certificate No: **D1750V2-1018_Jul18**

CALIBRATION CERTIFICATE

Object **D1750V2 - SN:1018**

Calibration procedure(s) **QA CAL-05.v10
Calibration procedure for dipole validation kits above 700 MHz**

Calibration date: **July 20, 2018**

This calibration certificate documents the traceability to national standards, which realize the physical units of measurements (SI).
The measurements and the uncertainties with confidence probability are given on the following pages and are part of the certificate.

All calibrations have been conducted in the closed laboratory facility: environment temperature (22 ± 3)°C and humidity < 70%.

Calibration Equipment used (M&TE critical for calibration)

Primary Standards	ID #	Cal Date (Certificate No.)	Scheduled Calibration
Power meter NRP	SN: 104778	04-Apr-18 (No. 217-02672/02673)	Apr-19
Power sensor NRP-Z91	SN: 103244	04-Apr-18 (No. 217-02672)	Apr-19
Power sensor NRP-Z91	SN: 103245	04-Apr-18 (No. 217-02673)	Apr-19
Reference 20 dB Attenuator	SN: 5058 (20k)	04-Apr-18 (No. 217-02682)	Apr-19
Type-N mismatch combination	SN: 5047.2 / 06327	04-Apr-18 (No. 217-02683)	Apr-19
Reference Probe EX3DV4	SN: 7349	30-Dec-17 (No. EX3-7349_Dec17)	Dec-18
DAE4	SN: 601	26-Oct-17 (No. DAE4-601_Oct17)	Oct-18

Secondary Standards	ID #	Check Date (in house)	Scheduled Check
Power meter EPM-442A	SN: GB37480704	07-Oct-15 (in house check Oct-16)	In house check: Oct-18
Power sensor HP 8481A	SN: US37292783	07-Oct-15 (in house check Oct-16)	In house check: Oct-18
Power sensor HP 8481A	SN: MY41092317	07-Oct-15 (in house check Oct-16)	In house check: Oct-18
RF generator R&S SMT-06	SN: 100972	15-Jun-15 (in house check Oct-16)	In house check: Oct-18
Network Analyzer Agilent E8358A	SN: US41080477	31-Mar-14 (in house check Oct-17)	In house check: Oct-18

Calibrated by: **Manu Seitz** Name: **Manu Seitz** Function: **Laboratory Technician**

Approved by: **Katja Pokovic** Name: **Katja Pokovic** Function: **Technical Manager**

Signature

Issued: July 20, 2018

This calibration certificate shall not be reproduced except in full without written approval of the laboratory.



Accredited by the Swiss Accreditation Service (SAS)
The Swiss Accreditation Service is one of the signatories to the EA
Multilateral Agreement for the recognition of calibration certificates

Accreditation No.: **SCS 0108**

Glossary:

TSL	tissue simulating liquid
ConvF	sensitivity in TSL / NORM x,y,z
N/A	not applicable or not measured

Calibration is Performed According to the Following Standards:

- IEEE Std 1528-2013, "IEEE Recommended Practice for Determining the Peak Spatial-Averaged Specific Absorption Rate (SAR) in the Human Head from Wireless Communications Devices: Measurement Techniques", June 2013
- IEC 62209-1, "Measurement procedure for the assessment of Specific Absorption Rate (SAR) from hand-held and body-mounted devices used next to the ear (frequency range of 300 MHz to 6 GHz)", July 2016
- IEC 62209-2, "Procedure to determine the Specific Absorption Rate (SAR) for wireless communication devices used in close proximity to the human body (frequency range of 30 MHz to 6 GHz)", March 2010
- KDB 865664, "SAR Measurement Requirements for 100 MHz to 6 GHz"

Additional Documentation:

- DASY4/5 System Handbook

Methods Applied and Interpretation of Parameters:

- Measurement Conditions:** Further details are available from the Validation Report at the end of the certificate. All figures stated in the certificate are valid at the frequency indicated.
- Antenna Parameters with TSL:** The dipole is mounted with the spacer to position its feed point exactly below the center marking of the flat phantom section, with the arms oriented parallel to the body axis.
- Feed Point Impedance and Return Loss:** These parameters are measured with the dipole positioned under the liquid filled phantom. The impedance stated is transformed from the measurement at the SMA connector to the feed point. The Return Loss ensures low reflected power. No uncertainty required.
- Electrical Delay:** One-way delay between the SMA connector and the antenna feed point. No uncertainty required.
- SAR measured:** SAR measured at the stated antenna input power.
- SAR normalized:** SAR as measured, normalized to an input power of 1 W at the antenna connector.
- SAR for nominal TSL parameters:** The measured TSL parameters are used to calculate the nominal SAR result.

The reported uncertainty of measurement is stated as the standard uncertainty of measurement multiplied by the coverage factor $k=2$, which for a normal distribution corresponds to a coverage probability of approximately 95%.

Measurement Conditions

DASY system configuration, as far as not given on page 1.

DASY Version	DASY5	V52.10.1
Extrapolation	Advanced Extrapolation	
Phantom	Modular Flat Phantom	
Distance Dipole Center - TSL	10 mm	with Spacer
Zoom Scan Resolution	dx, dy, dz = 5 mm	
Frequency	1750 MHz ± 1 MHz	

Head TSL parameters

The following parameters and calculations were applied.

	Temperature	Permittivity	Conductivity
Nominal Head TSL parameters	22.0 °C	40.1	1.37 mho/m
Measured Head TSL parameters	(22.0 ± 0.2) °C	39.0 ± 6 %	1.34 mho/m ± 6 %
Head TSL temperature change during test	< 0.5 °C	----	----

SAR result with Head TSL

SAR averaged over 1 cm³ (1 g) of Head TSL	Condition	
SAR measured	250 mW input power	8.95 W/kg
SAR for nominal Head TSL parameters	normalized to 1W	36.1 W/kg ± 17.0 % (k=2)

SAR averaged over 10 cm³ (10 g) of Head TSL	condition	
SAR measured	250 mW input power	4.73 W/kg
SAR for nominal Head TSL parameters	normalized to 1W	19.0 W/kg ± 16.5 % (k=2)

Body TSL parameters

The following parameters and calculations were applied.

	Temperature	Permittivity	Conductivity
Nominal Body TSL parameters	22.0 °C	53.4	1.49 mho/m
Measured Body TSL parameters	(22.0 ± 0.2) °C	53.7 ± 6 %	1.46 mho/m ± 6 %
Body TSL temperature change during test	< 0.5 °C	----	----

SAR result with Body TSL

SAR averaged over 1 cm³ (1 g) of Body TSL	Condition	
SAR measured	250 mW input power	9.00 W/kg
SAR for nominal Body TSL parameters	normalized to 1W	36.5 W/kg ± 17.0 % (k=2)

SAR averaged over 10 cm³ (10 g) of Body TSL	condition	
SAR measured	250 mW input power	4.80 W/kg
SAR for nominal Body TSL parameters	normalized to 1W	19.4 W/kg ± 16.5 % (k=2)

Appendix (Additional assessments outside the scope of SCS 0108)

Antenna Parameters with Head TSL

Impedance, transformed to feed point	49.4 Ω - 1.3 j Ω
Return Loss	- 36.8 dB

Antenna Parameters with Body TSL

Impedance, transformed to feed point	45.2 Ω - 0.1 j Ω
Return Loss	- 25.9 dB

General Antenna Parameters and Design

Electrical Delay (one direction)	1.221 ns
----------------------------------	----------

After long term use with 100W radiated power, only a slight warming of the dipole near the feedpoint can be measured.

The dipole is made of standard semirigid coaxial cable. The center conductor of the feeding line is directly connected to the second arm of the dipole. The antenna is therefore short-circuited for DC-signals. On some of the dipoles, small end caps are added to the dipole arms in order to improve matching when loaded according to the position as explained in the "Measurement Conditions" paragraph. The SAR data are not affected by this change. The overall dipole length is still according to the Standard.

No excessive force must be applied to the dipole arms, because they might bend or the soldered connections near the feedpoint may be damaged.

Additional EUT Data

Manufactured by	SPEAG
Manufactured on	February 11, 2009

Extended Calibration

Usage of SAR dipoles calibrated less than 3 years ago but more than 1 year ago were confirmed in maintaining return loss (<-20 dB, within 20% of prior calibration) and impedance (within 5 ohm from prior calibration) requirements per extended calibrations in KDB Publication 865664 D01 v01r04.

D1750V2 SN: 1018 - Head						
Date of Measurement	Return Loss (dB)	$\Delta\%$	Impedance Real (Ω)	$\Delta\Omega$	Impedance Imaginary (j Ω)	$\Delta\Omega$
7/20/2018	-36.8		49.4		-1.3	
7/13/2019	-37.2	1.1	48.9	-0.5	-1.6	-0.3
7/20/2020	-36.1	-1.9	48.4	-1.0	-1.4	-0.1
D1750V2 SN: 1018 - Body						
Date of Measurement	Return Loss (dB)	$\Delta\%$	Impedance Real (Ω)	$\Delta\Omega$	Impedance Imaginary (j Ω)	$\Delta\Omega$
7/20/2018	-25.9		45.2		-0.1	
7/13/2019	-26.5	2.3	45.8	0.6	-0.2	-0.1
7/20/2020	-26.1	0.8	44.9	-0.3	-0.1	0.0

DASY5 Validation Report for Head TSL

Date: 20.07.2018

Test Laboratory: SPEAG, Zurich, Switzerland

DUT: Dipole 1750 MHz; Type: D1750V2; Serial: D1750V2 - SN:1018

Communication System: UID 0 - CW; Frequency: 1750 MHz

Medium parameters used: $f = 1750$ MHz; $\sigma = 1.34$ S/m; $\epsilon_r = 39$; $\rho = 1000$ kg/m³

Phantom section: Flat Section

Measurement Standard: DASY5 (IEEE/IEC/ANSI C63.19-2011)

DASY52 Configuration:

- Probe: EX3DV4 - SN7349; ConvF(8.5, 8.5, 8.5) @ 1750 MHz; Calibrated: 30.12.2017
- Sensor-Surface: 1.4mm (Mechanical Surface Detection)
- Electronics: DAE4 Sn601; Calibrated: 26.10.2017
- Phantom: Flat Phantom 5.0 (front); Type: QD 000 P50 AA; Serial: 1001
- DASY52 52.10.1(1476); SEMCAD X 14.6.11(7439)

Dipole Calibration for Head Tissue/Pin=250 mW, d=10mm/Zoom Scan (7x7x7)/Cube 0:

Measurement grid: dx=5mm, dy=5mm, dz=5mm

Reference Value = 106.7 V/m; Power Drift = -0.04 dB

Peak SAR (extrapolated) = 16.4 W/kg

SAR(1 g) = 8.95 W/kg; SAR(10 g) = 4.73 W/kg

Maximum value of SAR (measured) = 13.9 W/kg

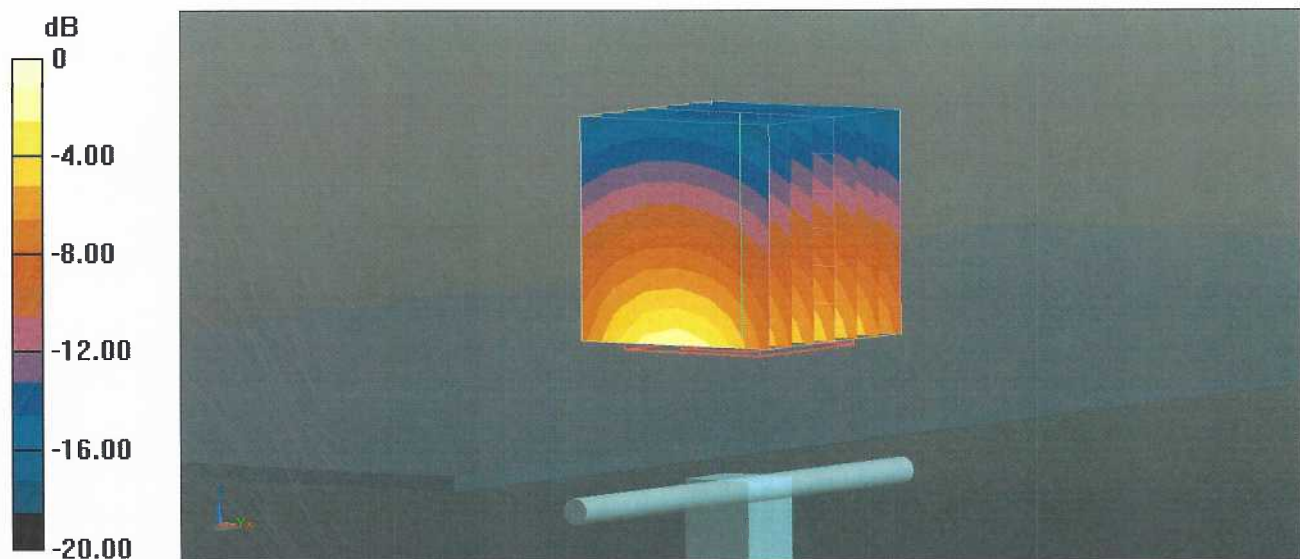

Impedance Measurement Plot for Head TSL

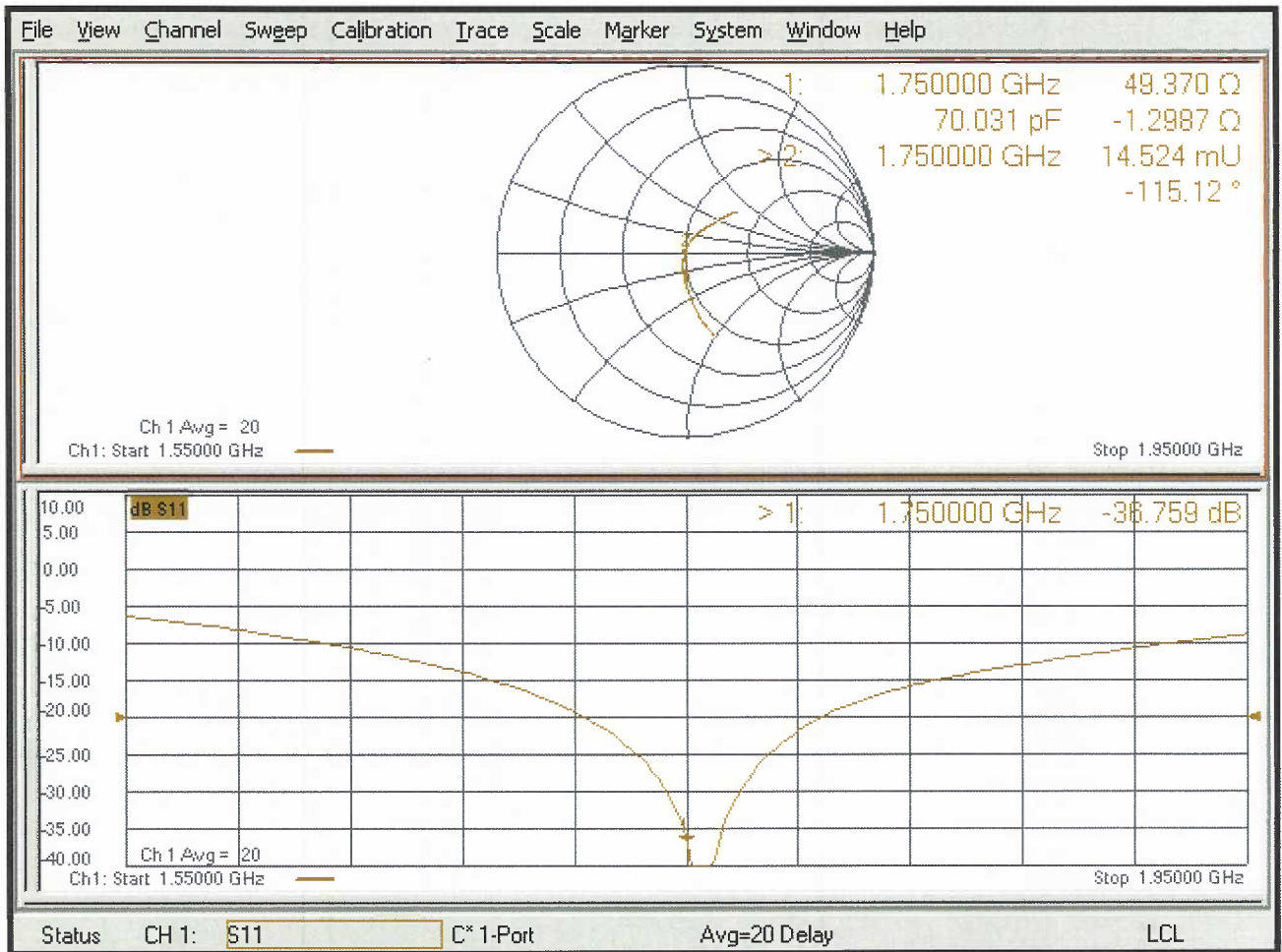

DASY5 Validation Report for Body TSL

Date: 20.07.2018

Test Laboratory: SPEAG, Zurich, Switzerland

DUT: Dipole 1750 MHz; Type: D1750V2; Serial: D1750V2 - SN:1018

Communication System: UID 0 - CW; Frequency: 1750 MHz

Medium parameters used: $f = 1750$ MHz; $\sigma = 1.46$ S/m; $\epsilon_r = 53.7$; $\rho = 1000$ kg/m³

Phantom section: Flat Section

Measurement Standard: DASY5 (IEEE/IEC/ANSI C63.19-2011)

DASY52 Configuration:

- Probe: EX3DV4 - SN7349; ConvF(8.35, 8.35, 8.35) @ 1750 MHz; Calibrated: 30.12.2017
- Sensor-Surface: 1.4mm (Mechanical Surface Detection)
- Electronics: DAE4 Sn601; Calibrated: 26.10.2017
- Phantom: Flat Phantom 5.0 (back); Type: QD 000 P50 AA; Serial: 1002
- DASY52 52.10.1(1476); SEMCAD X 14.6.11(7439)

Dipole Calibration for Body Tissue/Pin=250 mW, d=10mm/Zoom Scan (7x7x7)/Cube 0:

Measurement grid: dx=5mm, dy=5mm, dz=5mm

Reference Value = 101.9 V/m; Power Drift = -0.09 dB

Peak SAR (extrapolated) = 15.8 W/kg

SAR(1 g) = 9 W/kg; SAR(10 g) = 4.8 W/kg

Maximum value of SAR (measured) = 13.4 W/kg

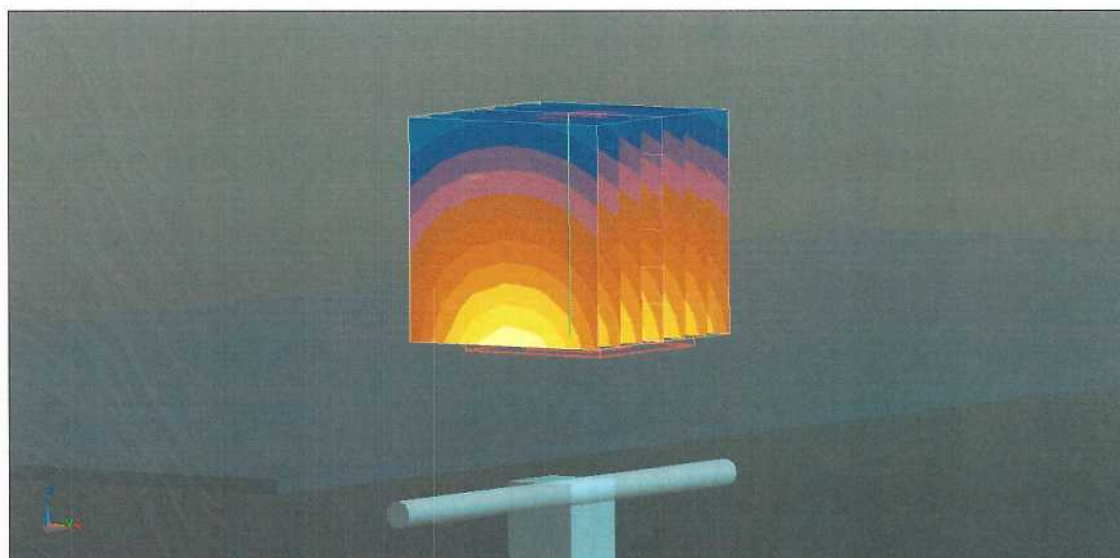
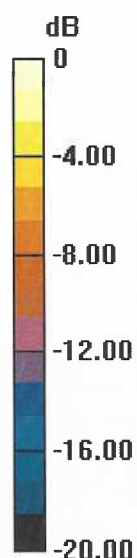

0 dB = 13.4 W/kg = 11.27 dBW/kg

Impedance Measurement Plot for Body TSL

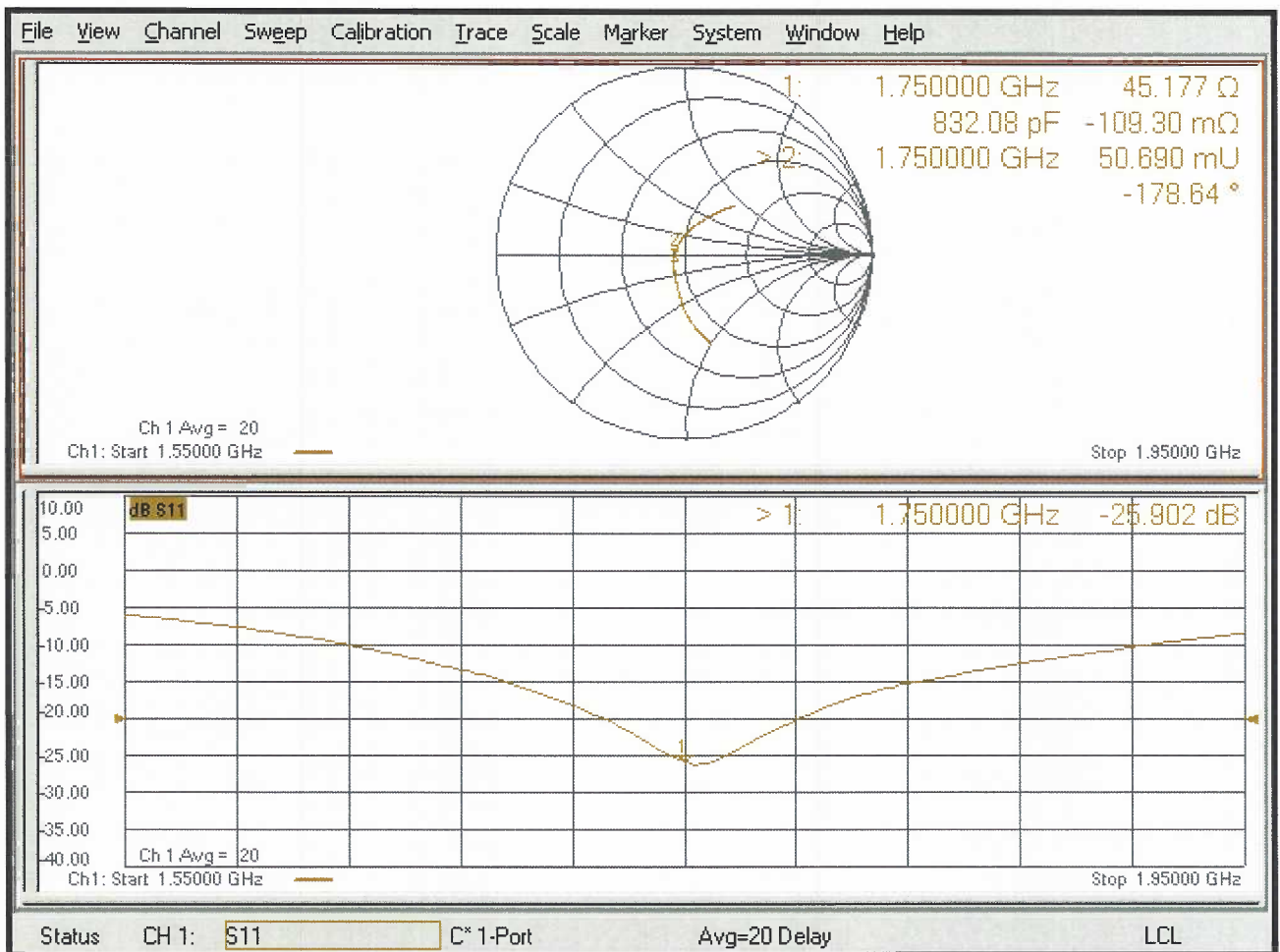



Accredited by the Swiss Accreditation Service (SAS)
The Swiss Accreditation Service is one of the signatories to the EA
Multilateral Agreement for the recognition of calibration certificates

Accreditation No.: **SCS 0108**

Client **RF Exposure Lab**

Certificate No: **D1900V2-5d116_Jul18**

CALIBRATION CERTIFICATE

Object **D1900V2 - SN:5d116**

Calibration procedure(s) **QA CAL-05.v10
Calibration procedure for dipole validation kits above 700 MHz**

Calibration date: **July 13, 2018**

This calibration certificate documents the traceability to national standards, which realize the physical units of measurements (SI).
The measurements and the uncertainties with confidence probability are given on the following pages and are part of the certificate.

All calibrations have been conducted in the closed laboratory facility: environment temperature (22 ± 3)°C and humidity < 70%.

Calibration Equipment used (M&TE critical for calibration)

Primary Standards	ID #	Cal Date (Certificate No.)	Scheduled Calibration
Power meter NRP	SN: 104778	04-Apr-18 (No. 217-02672/02673)	Apr-19
Power sensor NRP-Z91	SN: 103244	04-Apr-18 (No. 217-02672)	Apr-19
Power sensor NRP-Z91	SN: 103245	04-Apr-18 (No. 217-02673)	Apr-19
Reference 20 dB Attenuator	SN: 5058 (20k)	04-Apr-18 (No. 217-02682)	Apr-19
Type-N mismatch combination	SN: 5047.2 / 06327	04-Apr-18 (No. 217-02683)	Apr-19
Reference Probe EX3DV4	SN: 7349	30-Dec-17 (No. EX3-7349_Dec17)	Dec-18
DAE4	SN: 601	26-Oct-17 (No. DAE4-601_Oct17)	Oct-18
Secondary Standards	ID #	Check Date (in house)	Scheduled Check
Power meter EPM-442A	SN: GB37480704	07-Oct-15 (in house check Oct-16)	In house check: Oct-18
Power sensor HP 8481A	SN: US37292783	07-Oct-15 (in house check Oct-16)	In house check: Oct-18
Power sensor HP 8481A	SN: MY41092317	07-Oct-15 (in house check Oct-16)	In house check: Oct-18
RF generator R&S SMT-06	SN: 100972	15-Jun-15 (in house check Oct-16)	In house check: Oct-18
Network Analyzer Agilent E8358A	SN: US41080477	31-Mar-14 (in house check Oct-17)	In house check: Oct-18

Calibrated by: **Manu Seitz** Name: **Manu Seitz** Function: **Laboratory Technician**

Approved by: **Katja Pokovic** Name: **Katja Pokovic** Function: **Technical Manager**

Signature

Issued: July 16, 2018

This calibration certificate shall not be reproduced except in full without written approval of the laboratory.



Accredited by the Swiss Accreditation Service (SAS)

The Swiss Accreditation Service is one of the signatories to the EA Multilateral Agreement for the recognition of calibration certificates

Accreditation No.: **SCS 0108**

Glossary:

TSL	tissue simulating liquid
ConvF	sensitivity in TSL / NORM x,y,z
N/A	not applicable or not measured

Calibration is Performed According to the Following Standards:

- a) IEEE Std 1528-2013, "IEEE Recommended Practice for Determining the Peak Spatial-Averaged Specific Absorption Rate (SAR) in the Human Head from Wireless Communications Devices: Measurement Techniques", June 2013
- b) IEC 62209-1, "Measurement procedure for the assessment of Specific Absorption Rate (SAR) from hand-held and body-mounted devices used next to the ear (frequency range of 300 MHz to 6 GHz)", July 2016
- c) IEC 62209-2, "Procedure to determine the Specific Absorption Rate (SAR) for wireless communication devices used in close proximity to the human body (frequency range of 30 MHz to 6 GHz)", March 2010
- d) KDB 865664, "SAR Measurement Requirements for 100 MHz to 6 GHz"

Additional Documentation:

- e) DASY4/5 System Handbook

Methods Applied and Interpretation of Parameters:

- *Measurement Conditions:* Further details are available from the Validation Report at the end of the certificate. All figures stated in the certificate are valid at the frequency indicated.
- *Antenna Parameters with TSL:* The dipole is mounted with the spacer to position its feed point exactly below the center marking of the flat phantom section, with the arms oriented parallel to the body axis.
- *Feed Point Impedance and Return Loss:* These parameters are measured with the dipole positioned under the liquid filled phantom. The impedance stated is transformed from the measurement at the SMA connector to the feed point. The Return Loss ensures low reflected power. No uncertainty required.
- *Electrical Delay:* One-way delay between the SMA connector and the antenna feed point. No uncertainty required.
- *SAR measured:* SAR measured at the stated antenna input power.
- *SAR normalized:* SAR as measured, normalized to an input power of 1 W at the antenna connector.
- *SAR for nominal TSL parameters:* The measured TSL parameters are used to calculate the nominal SAR result.

The reported uncertainty of measurement is stated as the standard uncertainty of measurement multiplied by the coverage factor $k=2$, which for a normal distribution corresponds to a coverage probability of approximately 95%.

Measurement Conditions

DASY system configuration, as far as not given on page 1.

DASY Version	DASY5	V52.10.1
Extrapolation	Advanced Extrapolation	
Phantom	Modular Flat Phantom	
Distance Dipole Center - TSL	10 mm	with Spacer
Zoom Scan Resolution	dx, dy, dz = 5 mm	
Frequency	1900 MHz ± 1 MHz	

Head TSL parameters

The following parameters and calculations were applied.

	Temperature	Permittivity	Conductivity
Nominal Head TSL parameters	22.0 °C	40.0	1.40 mho/m
Measured Head TSL parameters	(22.0 ± 0.2) °C	39.9 ± 6 %	1.34 mho/m ± 6 %
Head TSL temperature change during test	< 0.5 °C	----	----

SAR result with Head TSL

SAR averaged over 1 cm³ (1 g) of Head TSL	Condition	
SAR measured	250 mW input power	9.90 W/kg
SAR for nominal Head TSL parameters	normalized to 1W	40.6 W/kg ± 17.0 % (k=2)

SAR averaged over 10 cm³ (10 g) of Head TSL	condition	
SAR measured	250 mW input power	5.27 W/kg
SAR for nominal Head TSL parameters	normalized to 1W	21.4 W/kg ± 16.5 % (k=2)

Body TSL parameters

The following parameters and calculations were applied.

	Temperature	Permittivity	Conductivity
Nominal Body TSL parameters	22.0 °C	53.3	1.52 mho/m
Measured Body TSL parameters	(22.0 ± 0.2) °C	54.3 ± 6 %	1.46 mho/m ± 6 %
Body TSL temperature change during test	< 0.5 °C	----	----

SAR result with Body TSL

SAR averaged over 1 cm³ (1 g) of Body TSL	Condition	
SAR measured	250 mW input power	9.70 W/kg
SAR for nominal Body TSL parameters	normalized to 1W	39.9 W/kg ± 17.0 % (k=2)

SAR averaged over 10 cm³ (10 g) of Body TSL	condition	
SAR measured	250 mW input power	5.23 W/kg
SAR for nominal Body TSL parameters	normalized to 1W	21.3 W/kg ± 16.5 % (k=2)

Appendix (Additional assessments outside the scope of SCS 0108)

Antenna Parameters with Head TSL

Impedance, transformed to feed point	54.5 Ω + 5.0 j Ω
Return Loss	- 23.9 dB

Antenna Parameters with Body TSL

Impedance, transformed to feed point	50.2 Ω + 8.3 j Ω
Return Loss	- 21.7 dB

General Antenna Parameters and Design

Electrical Delay (one direction)	1.202 ns
----------------------------------	----------

After long term use with 100W radiated power, only a slight warming of the dipole near the feedpoint can be measured.

The dipole is made of standard semirigid coaxial cable. The center conductor of the feeding line is directly connected to the second arm of the dipole. The antenna is therefore short-circuited for DC-signals. On some of the dipoles, small end caps are added to the dipole arms in order to improve matching when loaded according to the position as explained in the "Measurement Conditions" paragraph. The SAR data are not affected by this change. The overall dipole length is still according to the Standard.

No excessive force must be applied to the dipole arms, because they might bend or the soldered connections near the feedpoint may be damaged.

Additional EUT Data

Manufactured by	SPEAG
Manufactured on	August 21, 2009

Extended Calibration

Usage of SAR dipoles calibrated less than 3 years ago but more than 1 year ago were confirmed in maintaining return loss (<-20 dB, within 20% of prior calibration) and impedance (within 5 ohm from prior calibration) requirements per extended calibrations in KDB Publication 865664 D01 v01r04.

D1900V2 SN: 5d116 - Head						
Date of Measurement	Return Loss (dB)	$\Delta\%$	Impedance Real (Ω)	$\Delta\Omega$	Impedance Imaginary (j Ω)	$\Delta\Omega$
7/13/2018	-23.9		54.5		5.0	
7/13/2019	-24.2	1.3	54.6	0.1	5.2	0.2
7/13/2020	-24.5	2.5	53.8	-0.7	4.8	-0.2
D1900V2 SN: 5d116 - Body						
Date of Measurement	Return Loss (dB)	$\Delta\%$	Impedance Real (Ω)	$\Delta\Omega$	Impedance Imaginary (j Ω)	$\Delta\Omega$
7/13/2018	-21.7		50.2		8.3	
7/13/2019	-22.3	2.8	49.6	-0.6	8.1	-0.2
7/13/2020	-21.9	0.9	51.4	1.2	8.6	0.3

DASY5 Validation Report for Head TSL

Date: 13.07.2018

Test Laboratory: SPEAG, Zurich, Switzerland

DUT: Dipole 1900 MHz; Type: D1900V2; Serial: D1900V2 - SN:5d116

Communication System: UID 0 - CW; Frequency: 1900 MHz

Medium parameters used: $f = 1900$ MHz; $\sigma = 1.34$ S/m; $\epsilon_r = 39.9$; $\rho = 1000$ kg/m³

Phantom section: Flat Section

Measurement Standard: DASY5 (IEEE/IEC/ANSI C63.19-2011)

DASY52 Configuration:

- Probe: EX3DV4 - SN7349; ConvF(8.18, 8.18, 8.18) @ 1900 MHz; Calibrated: 30.12.2017
- Sensor-Surface: 1.4mm (Mechanical Surface Detection)
- Electronics: DAE4 Sn601; Calibrated: 26.10.2017
- Phantom: Flat Phantom 5.0 (front); Type: QD 000 P50 AA; Serial: 1001
- DASY52 52.10.1(1476); SEMCAD X 14.6.11(7439)

Dipole Calibration for Head Tissue/Pin=250 mW, d=10mm/Zoom Scan (7x7x7)/Cube 0:

Measurement grid: dx=5mm, dy=5mm, dz=5mm

Reference Value = 111.3 V/m; Power Drift = -0.07 dB

Peak SAR (extrapolated) = 18.0 W/kg

SAR(1 g) = 9.9 W/kg; SAR(10 g) = 5.27 W/kg

Maximum value of SAR (measured) = 15.3 W/kg

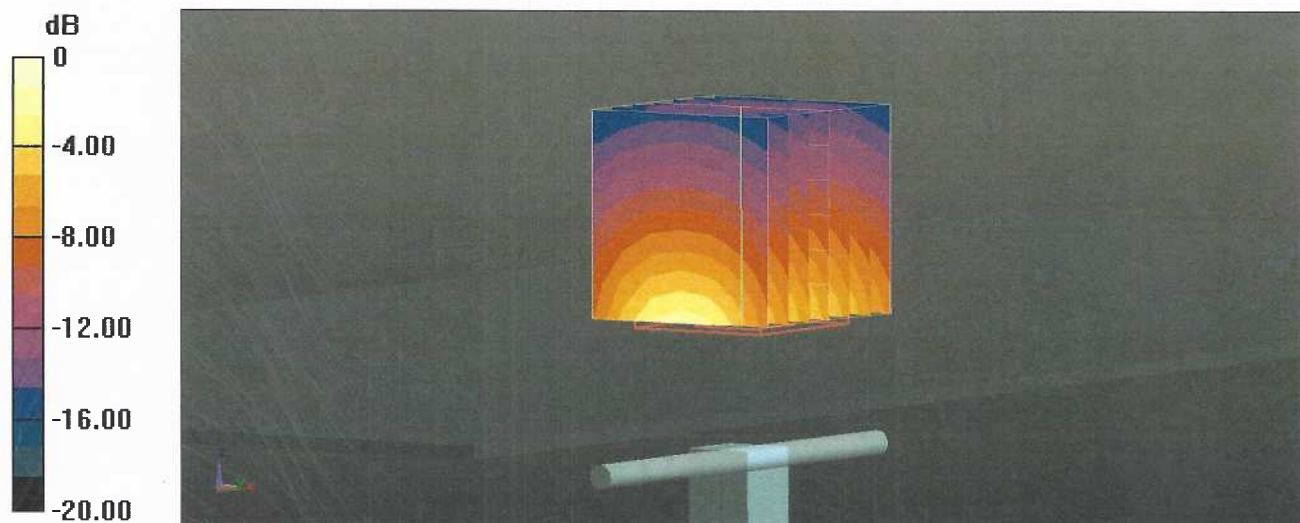

0 dB = 15.3 W/kg = 11.85 dBW/kg

Impedance Measurement Plot for Head TSL

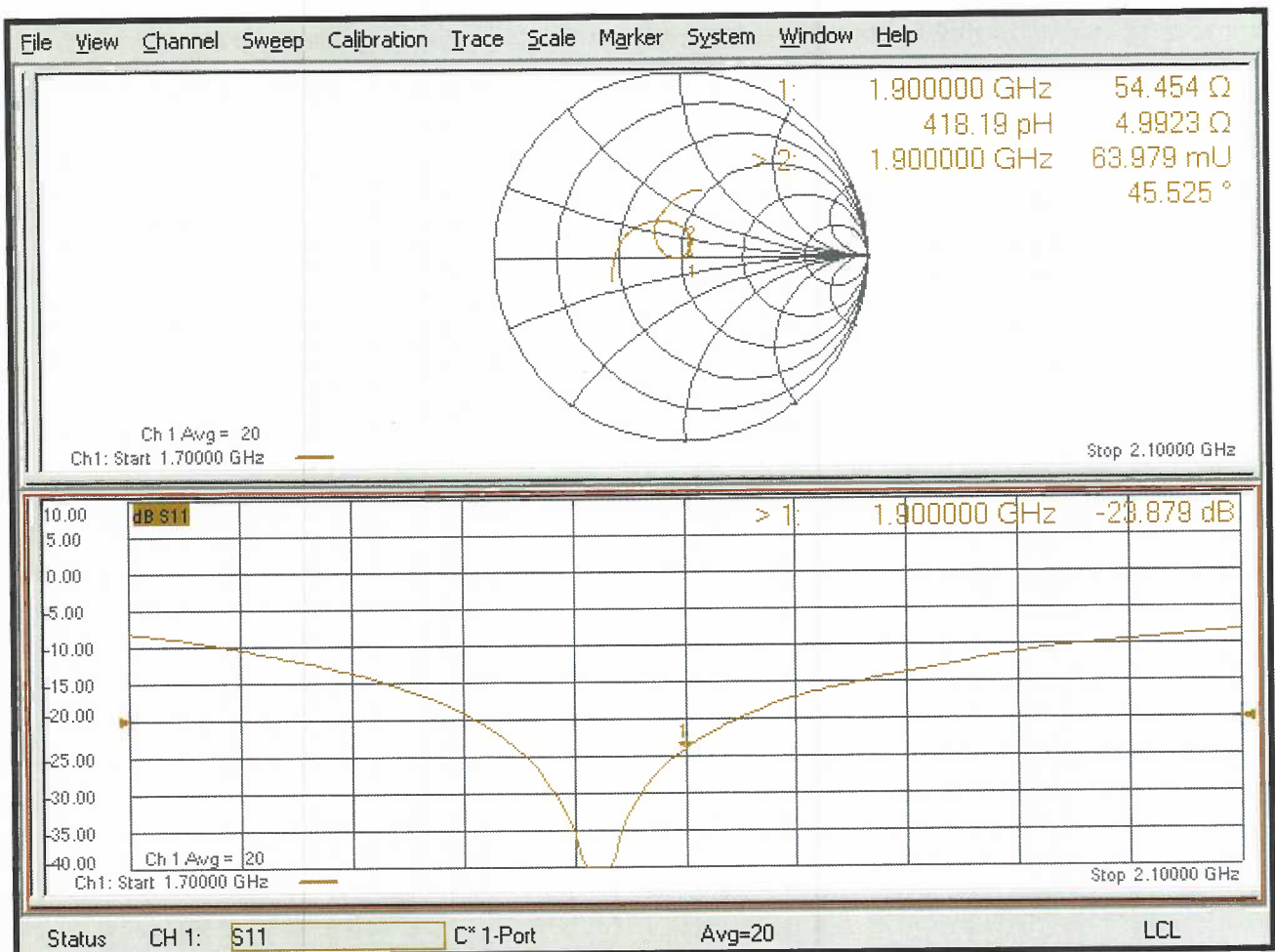

DASY5 Validation Report for Body TSL

Date: 13.07.2018

Test Laboratory: SPEAG, Zurich, Switzerland

DUT: Dipole 1900 MHz; Type: D1900V2; Serial: D1900V2 - SN:5d116

Communication System: UID 0 - CW; Frequency: 1900 MHz

Medium parameters used: $f = 1900$ MHz; $\sigma = 1.46$ S/m; $\epsilon_r = 54.3$; $\rho = 1000$ kg/m³

Phantom section: Flat Section

Measurement Standard: DASY5 (IEEE/IEC/ANSI C63.19-2011)

DASY52 Configuration:

- Probe: EX3DV4 - SN7349; ConvF(8.15, 8.15, 8.15) @ 1900 MHz; Calibrated: 30.12.2017
- Sensor-Surface: 1.4mm (Mechanical Surface Detection)
- Electronics: DAE4 Sn601; Calibrated: 26.10.2017
- Phantom: Flat Phantom 5.0 (back); Type: QD 000 P50 AA; Serial: 1002
- DASY52 52.10.1(1476); SEMCAD X 14.6.11(7439)

Dipole Calibration for Body Tissue/Pin=250 mW, d=10mm/Zoom Scan (7x7x7)/Cube 0:

Measurement grid: dx=5mm, dy=5mm, dz=5mm

Reference Value = 104.5 V/m; Power Drift = -0.08 dB

Peak SAR (extrapolated) = 16.8 W/kg

SAR(1 g) = 9.7 W/kg; SAR(10 g) = 5.23 W/kg

Maximum value of SAR (measured) = 14.4 W/kg

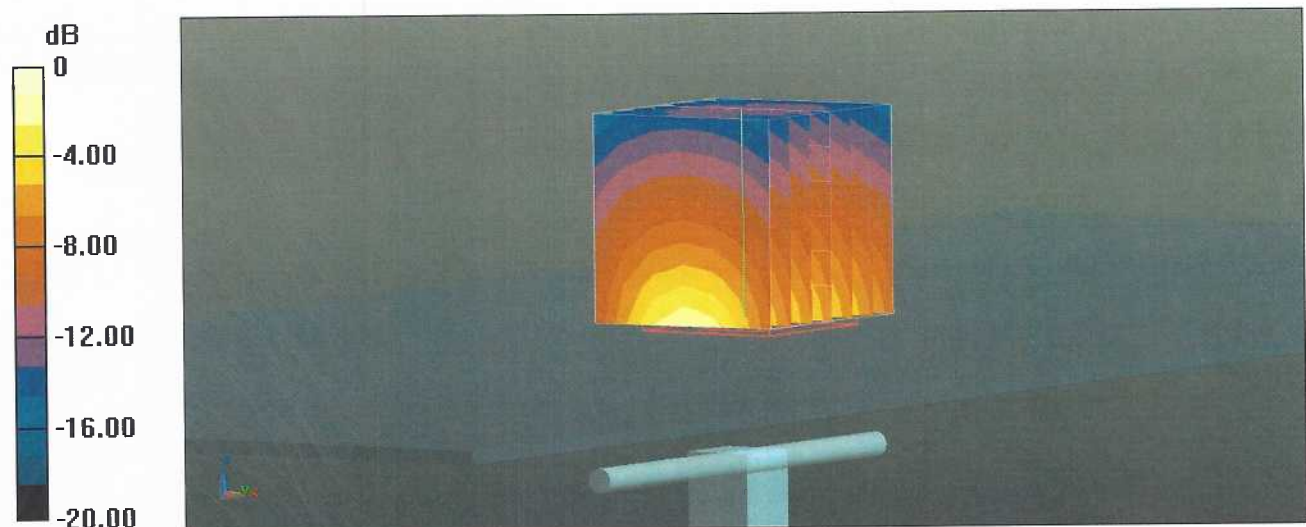

0 dB = 14.4 W/kg = 11.58 dBW/kg

Impedance Measurement Plot for Body TSL

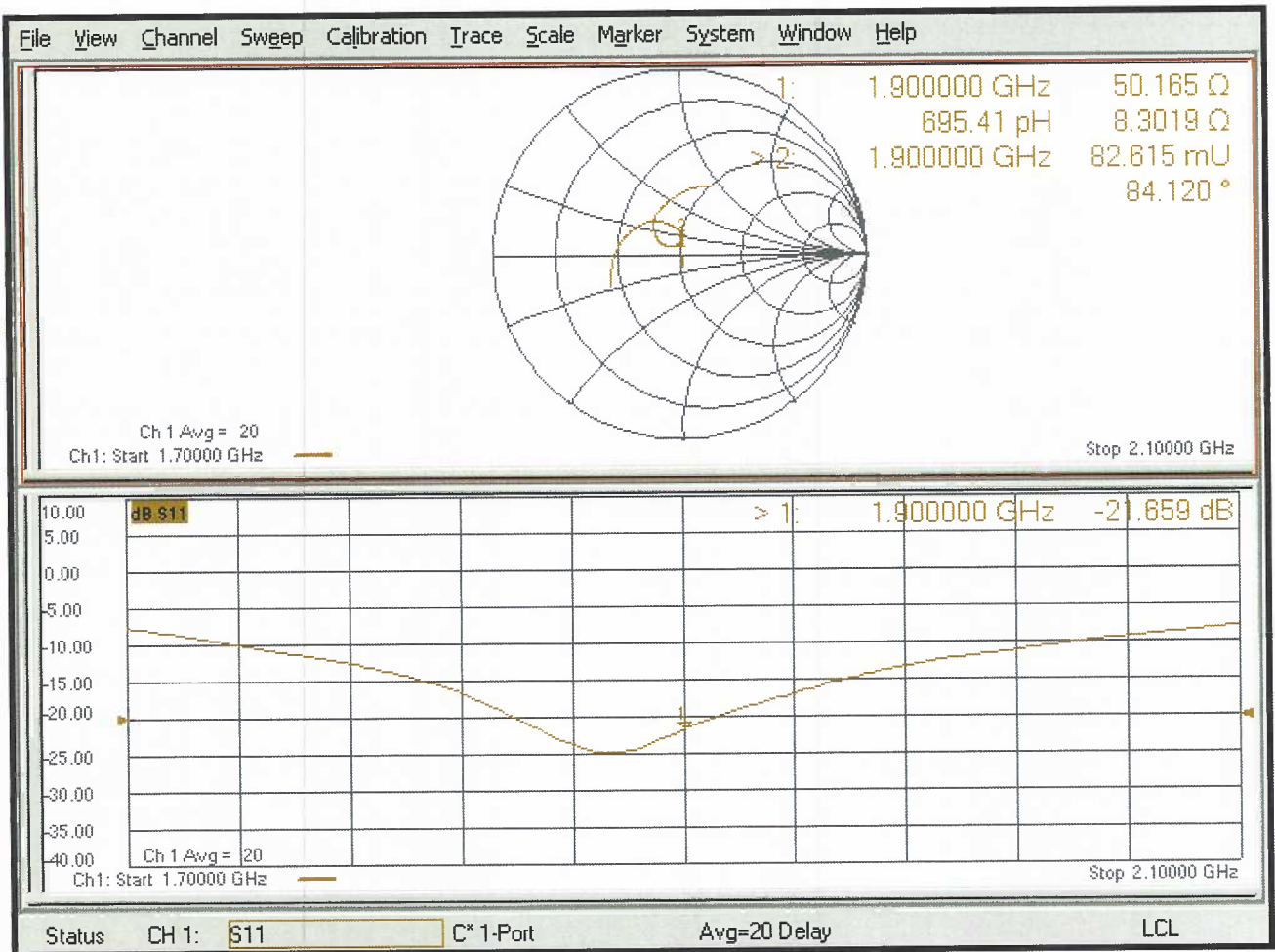



Accredited by the Swiss Accreditation Service (SAS)
The Swiss Accreditation Service is one of the signatories to the EA
Multilateral Agreement for the recognition of calibration certificates

Accreditation No.: **SCS 0108**

Client **RF Exposure Lab**

Certificate No: **D2450V2-829_Jul18**

CALIBRATION CERTIFICATE

Object **D2450V2 - SN:829**

Calibration procedure(s) **QA CAL-05.v10
Calibration procedure for dipole validation kits above 700 MHz**

Calibration date: **July 12, 2018**

This calibration certificate documents the traceability to national standards, which realize the physical units of measurements (SI).
The measurements and the uncertainties with confidence probability are given on the following pages and are part of the certificate.

All calibrations have been conducted in the closed laboratory facility: environment temperature (22 ± 3)°C and humidity < 70%.

Calibration Equipment used (M&TE critical for calibration)

Primary Standards	ID #	Cal Date (Certificate No.)	Scheduled Calibration
Power meter NRP	SN: 104778	04-Apr-18 (No. 217-02672/02673)	Apr-19
Power sensor NRP-Z91	SN: 103244	04-Apr-18 (No. 217-02672)	Apr-19
Power sensor NRP-Z91	SN: 103245	04-Apr-18 (No. 217-02673)	Apr-19
Reference 20 dB Attenuator	SN: 5058 (20k)	04-Apr-18 (No. 217-02682)	Apr-19
Type-N mismatch combination	SN: 5047.2 / 06327	04-Apr-18 (No. 217-02683)	Apr-19
Reference Probe EX3DV4	SN: 7349	30-Dec-17 (No. EX3-7349_Dec17)	Dec-18
DAE4	SN: 601	26-Oct-17 (No. DAE4-601_Oct17)	Oct-18
Secondary Standards	ID #	Check Date (in house)	Scheduled Check
Power meter EPM-442A	SN: GB37480704	07-Oct-15 (in house check Oct-16)	In house check: Oct-18
Power sensor HP 8481A	SN: US37292783	07-Oct-15 (in house check Oct-16)	In house check: Oct-18
Power sensor HP 8481A	SN: MY41092317	07-Oct-15 (in house check Oct-16)	In house check: Oct-18
RF generator R&S SMT-06	SN: 100972	15-Jun-15 (in house check Oct-16)	In house check: Oct-18
Network Analyzer Agilent E8358A	SN: US41080477	31-Mar-14 (in house check Oct-17)	In house check: Oct-18

Calibrated by: **Manu Seitz** (Name) **Laboratory Technician** (Function)  (Signature)

Approved by: **Katja Pokovic** (Name) **Technical Manager** (Function)  (Signature)

Issued: July 16, 2018

This calibration certificate shall not be reproduced except in full without written approval of the laboratory.



Accredited by the Swiss Accreditation Service (SAS)
**The Swiss Accreditation Service is one of the signatories to the EA
Multilateral Agreement for the recognition of calibration certificates**

Accreditation No.: SCS 0108

Glossary:

TSL	tissue simulating liquid
ConvF	sensitivity in TSL / NORM x,y,z
N/A	not applicable or not measured

Calibration is Performed According to the Following Standards:

- a) IEEE Std 1528-2013, "IEEE Recommended Practice for Determining the Peak Spatial-Averaged Specific Absorption Rate (SAR) in the Human Head from Wireless Communications Devices: Measurement Techniques", June 2013
- b) IEC 62209-1, "Measurement procedure for the assessment of Specific Absorption Rate (SAR) from hand-held and body-mounted devices used next to the ear (frequency range of 300 MHz to 6 GHz)", July 2016
- c) IEC 62209-2, "Procedure to determine the Specific Absorption Rate (SAR) for wireless communication devices used in close proximity to the human body (frequency range of 30 MHz to 6 GHz)", March 2010
- d) KDB 865664, "SAR Measurement Requirements for 100 MHz to 6 GHz"

Additional Documentation:

- e) DAS4/5 System Handbook

Methods Applied and Interpretation of Parameters:

- *Measurement Conditions:* Further details are available from the Validation Report at the end of the certificate. All figures stated in the certificate are valid at the frequency indicated.
- *Antenna Parameters with TSL:* The dipole is mounted with the spacer to position its feed point exactly below the center marking of the flat phantom section, with the arms oriented parallel to the body axis.
- *Feed Point Impedance and Return Loss:* These parameters are measured with the dipole positioned under the liquid filled phantom. The impedance stated is transformed from the measurement at the SMA connector to the feed point. The Return Loss ensures low reflected power. No uncertainty required.
- *Electrical Delay:* One-way delay between the SMA connector and the antenna feed point. No uncertainty required.
- *SAR measured:* SAR measured at the stated antenna input power.
- *SAR normalized:* SAR as measured, normalized to an input power of 1 W at the antenna connector.
- *SAR for nominal TSL parameters:* The measured TSL parameters are used to calculate the nominal SAR result.

The reported uncertainty of measurement is stated as the standard uncertainty of measurement multiplied by the coverage factor $k=2$, which for a normal distribution corresponds to a coverage probability of approximately 95%.

Measurement Conditions

DASY system configuration, as far as not given on page 1.

DASY Version	DASY5	V52.10.1
Extrapolation	Advanced Extrapolation	
Phantom	Modular Flat Phantom	
Distance Dipole Center - TSL	10 mm	with Spacer
Zoom Scan Resolution	dx, dy, dz = 5 mm	
Frequency	2450 MHz ± 1 MHz	

Head TSL parameters

The following parameters and calculations were applied.

	Temperature	Permittivity	Conductivity
Nominal Head TSL parameters	22.0 °C	39.2	1.80 mho/m
Measured Head TSL parameters	(22.0 ± 0.2) °C	37.8 ± 6 %	1.85 mho/m ± 6 %
Head TSL temperature change during test	< 0.5 °C	----	----

SAR result with Head TSL

SAR averaged over 1 cm³ (1 g) of Head TSL	Condition	
SAR measured	250 mW input power	13.2 W/kg
SAR for nominal Head TSL parameters	normalized to 1W	51.7 W/kg ± 17.0 % (k=2)

SAR averaged over 10 cm³ (10 g) of Head TSL	condition	
SAR measured	250 mW input power	6.15 W/kg
SAR for nominal Head TSL parameters	normalized to 1W	24.3 W/kg ± 16.5 % (k=2)

Body TSL parameters

The following parameters and calculations were applied.

	Temperature	Permittivity	Conductivity
Nominal Body TSL parameters	22.0 °C	52.7	1.95 mho/m
Measured Body TSL parameters	(22.0 ± 0.2) °C	51.9 ± 6 %	2.02 mho/m ± 6 %
Body TSL temperature change during test	< 0.5 °C	----	----

SAR result with Body TSL

SAR averaged over 1 cm³ (1 g) of Body TSL	Condition	
SAR measured	250 mW input power	13.0 W/kg
SAR for nominal Body TSL parameters	normalized to 1W	51.0 W/kg ± 17.0 % (k=2)

SAR averaged over 10 cm³ (10 g) of Body TSL	condition	
SAR measured	250 mW input power	6.06 W/kg
SAR for nominal Body TSL parameters	normalized to 1W	24.0 W/kg ± 16.5 % (k=2)

Appendix (Additional assessments outside the scope of SCS 0108)

Antenna Parameters with Head TSL

Impedance, transformed to feed point	52.9 Ω + 3.3 j Ω
Return Loss	- 27.4 dB

Antenna Parameters with Body TSL

Impedance, transformed to feed point	50.9 Ω + 5.9 j Ω
Return Loss	- 24.5 dB

General Antenna Parameters and Design

Electrical Delay (one direction)	1.156 ns
----------------------------------	----------

After long term use with 100W radiated power, only a slight warming of the dipole near the feedpoint can be measured.

The dipole is made of standard semirigid coaxial cable. The center conductor of the feeding line is directly connected to the second arm of the dipole. The antenna is therefore short-circuited for DC-signals. On some of the dipoles, small end caps are added to the dipole arms in order to improve matching when loaded according to the position as explained in the "Measurement Conditions" paragraph. The SAR data are not affected by this change. The overall dipole length is still according to the Standard.

No excessive force must be applied to the dipole arms, because they might bend or the soldered connections near the feedpoint may be damaged.

Additional EUT Data

Manufactured by	SPEAG
Manufactured on	December 11, 2008

Extended Calibration

Usage of SAR dipoles calibrated less than 3 years ago but more than 1 year ago were confirmed in maintaining return loss (<-20 dB, within 20% of prior calibration) and impedance (within 5 ohm from prior calibration) requirements per extended calibrations in KDB Publication 865664 D01 v01r04.

D2450V2 SN: 829 - Head						
Date of Measurement	Return Loss (dB)	$\Delta\%$	Impedance Real (Ω)	$\Delta\Omega$	Impedance Imaginary (j Ω)	$\Delta\Omega$
7/12/2018	-27.4		52.9		3.3	
7/13/2019	-27.9	1.8	53.4	0.5	3.7	0.4
7/13/2020	-26.9	-1.8	51.4	-1.5	3.0	-0.3
D2450V2 SN: 829 - Body						
Date of Measurement	Return Loss (dB)	$\Delta\%$	Impedance Real (Ω)	$\Delta\Omega$	Impedance Imaginary (j Ω)	$\Delta\Omega$
7/12/2018	-24.5		50.9		5.9	
7/13/2019	-25.3	3.3	51.2	0.3	5.7	-0.2
7/13/2020	-24.1	-1.6	49.5	-1.4	5.8	-0.1

DASY5 Validation Report for Head TSL

Date: 12.07.2018

Test Laboratory: SPEAG, Zurich, Switzerland

DUT: Dipole 2450 MHz; Type: D2450V2; Serial: D2450V2 - SN:829

Communication System: UID 0 - CW; Frequency: 2450 MHz

Medium parameters used: $f = 2450$ MHz; $\sigma = 1.85$ S/m; $\epsilon_r = 37.8$; $\rho = 1000$ kg/m³

Phantom section: Flat Section

Measurement Standard: DASY5 (IEEE/IEC/ANSI C63.19-2011)

DASY52 Configuration:

- Probe: EX3DV4 - SN7349; ConvF(7.88, 7.88, 7.88) @ 2450 MHz; Calibrated: 30.12.2017
- Sensor-Surface: 1.4mm (Mechanical Surface Detection)
- Electronics: DAE4 Sn601; Calibrated: 26.10.2017
- Phantom: Flat Phantom 5.0 (front); Type: QD 000 P50 AA; Serial: 1001
- DASY52 52.10.1(1476); SEMCAD X 14.6.11(7439)

Dipole Calibration for Head Tissue/Pin=250 mW, d=10mm/Zoom Scan (7x7x7)/Cube 0:

Measurement grid: dx=5mm, dy=5mm, dz=5mm

Reference Value = 116.7 V/m; Power Drift = -0.07 dB

Peak SAR (extrapolated) = 26.4 W/kg

SAR(1 g) = 13.2 W/kg; SAR(10 g) = 6.15 W/kg

Maximum value of SAR (measured) = 21.9 W/kg

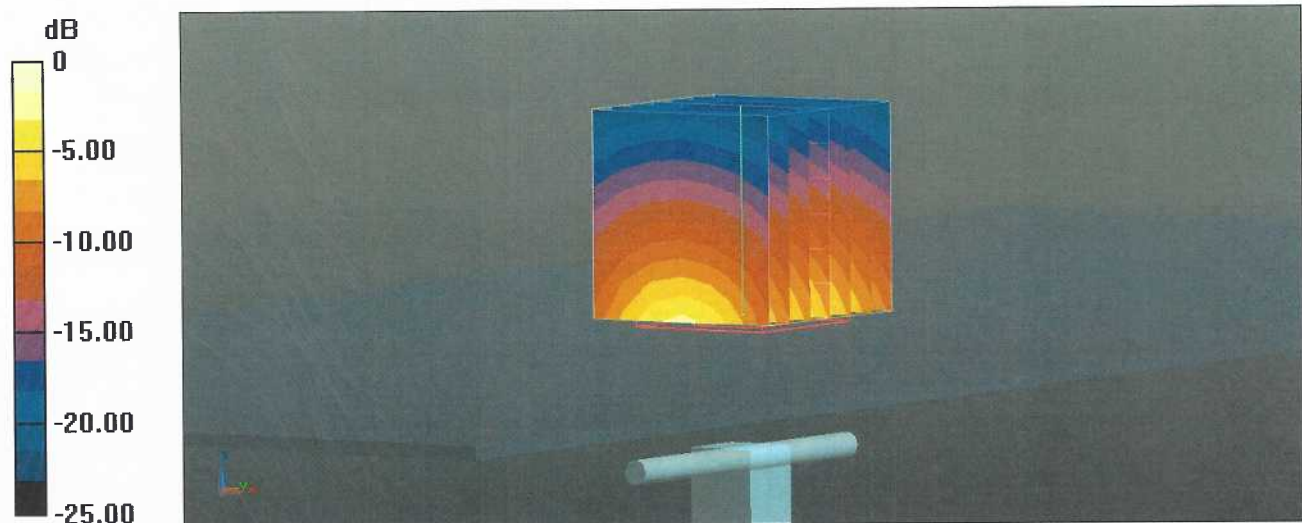

0 dB = 21.9 W/kg = 13.40 dBW/kg

Impedance Measurement Plot for Head TSL

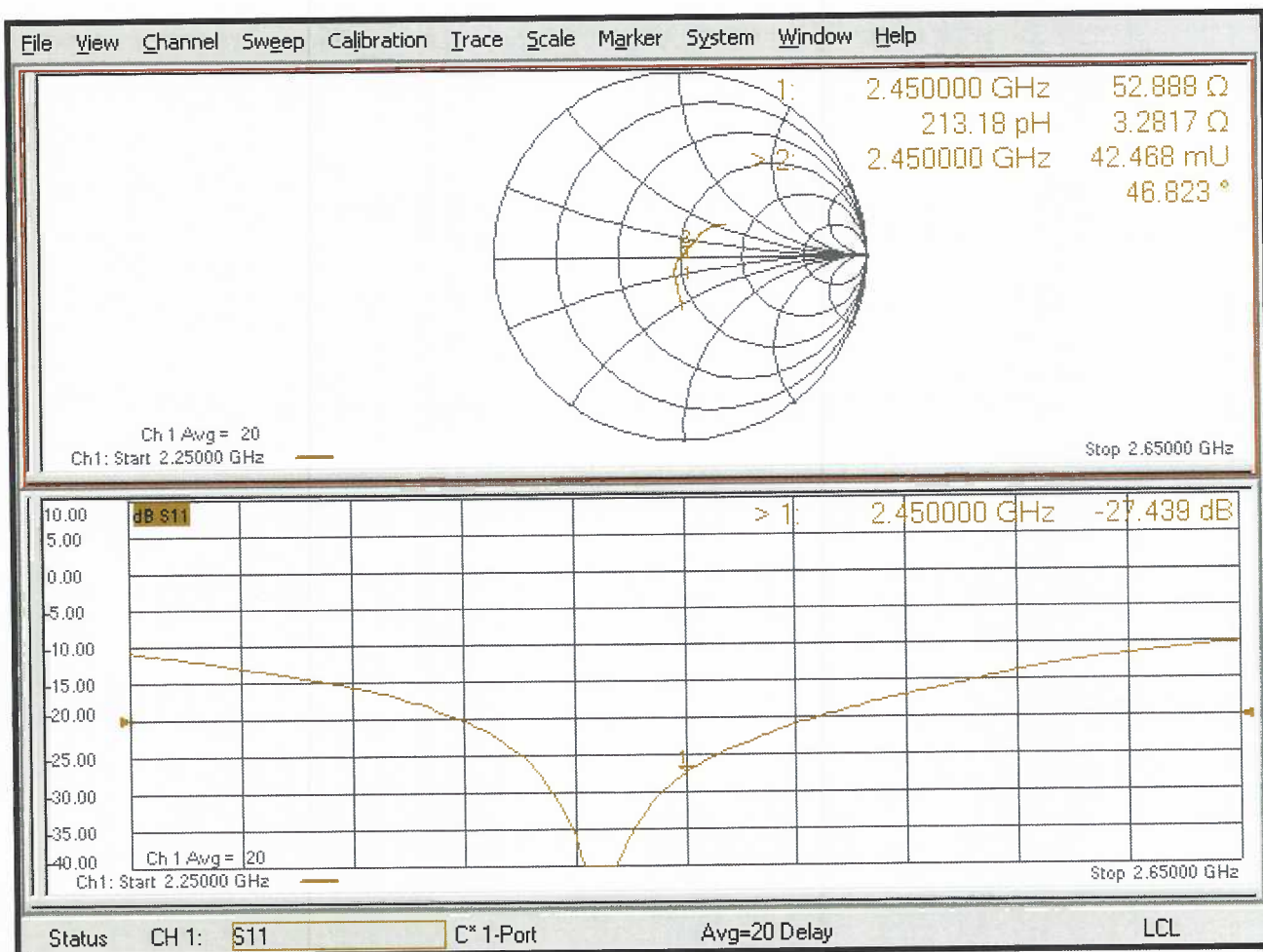

DASY5 Validation Report for Body TSL

Date: 12.07.2018

Test Laboratory: SPEAG, Zurich, Switzerland

DUT: Dipole 2450 MHz; Type: D2450V2; Serial: D2450V2 - SN:829

Communication System: UID 0 - CW; Frequency: 2450 MHz

Medium parameters used: $f = 2450$ MHz; $\sigma = 2.02$ S/m; $\epsilon_r = 51.9$; $\rho = 1000$ kg/m³

Phantom section: Flat Section

Measurement Standard: DASY5 (IEEE/IEC/ANSI C63.19-2011)

DASY52 Configuration:

- Probe: EX3DV4 - SN7349; ConvF(8.01, 8.01, 8.01) @ 2450 MHz; Calibrated: 30.12.2017
- Sensor-Surface: 1.4mm (Mechanical Surface Detection)
- Electronics: DAE4 Sn601; Calibrated: 26.10.2017
- Phantom: Flat Phantom 5.0 (back); Type: QD 000 P50 AA; Serial: 1002
- DASY52 52.10.1(1476); SEMCAD X 14.6.11(7439)

Dipole Calibration for Body Tissue/Pin=250 mW, d=10mm/Zoom Scan (7x7x7)/Cube 0:

Measurement grid: dx=5mm, dy=5mm, dz=5mm

Reference Value = 107.9 V/m; Power Drift = -0.09 dB

Peak SAR (extrapolated) = 25.6 W/kg

SAR(1 g) = 13 W/kg; SAR(10 g) = 6.06 W/kg

Maximum value of SAR (measured) = 21.1 W/kg

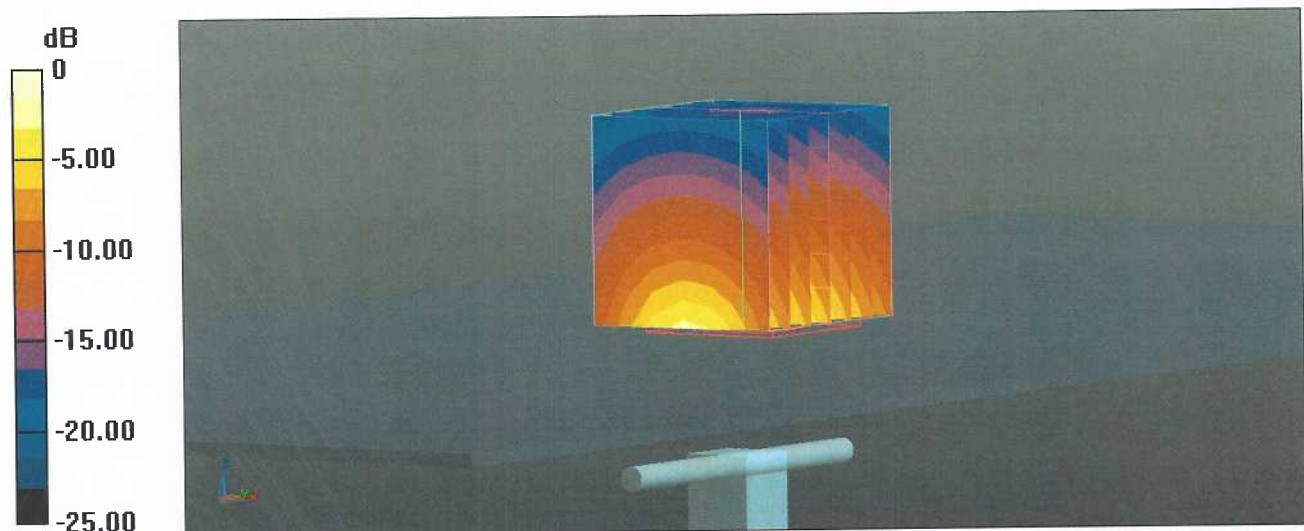

Impedance Measurement Plot for Body TSL

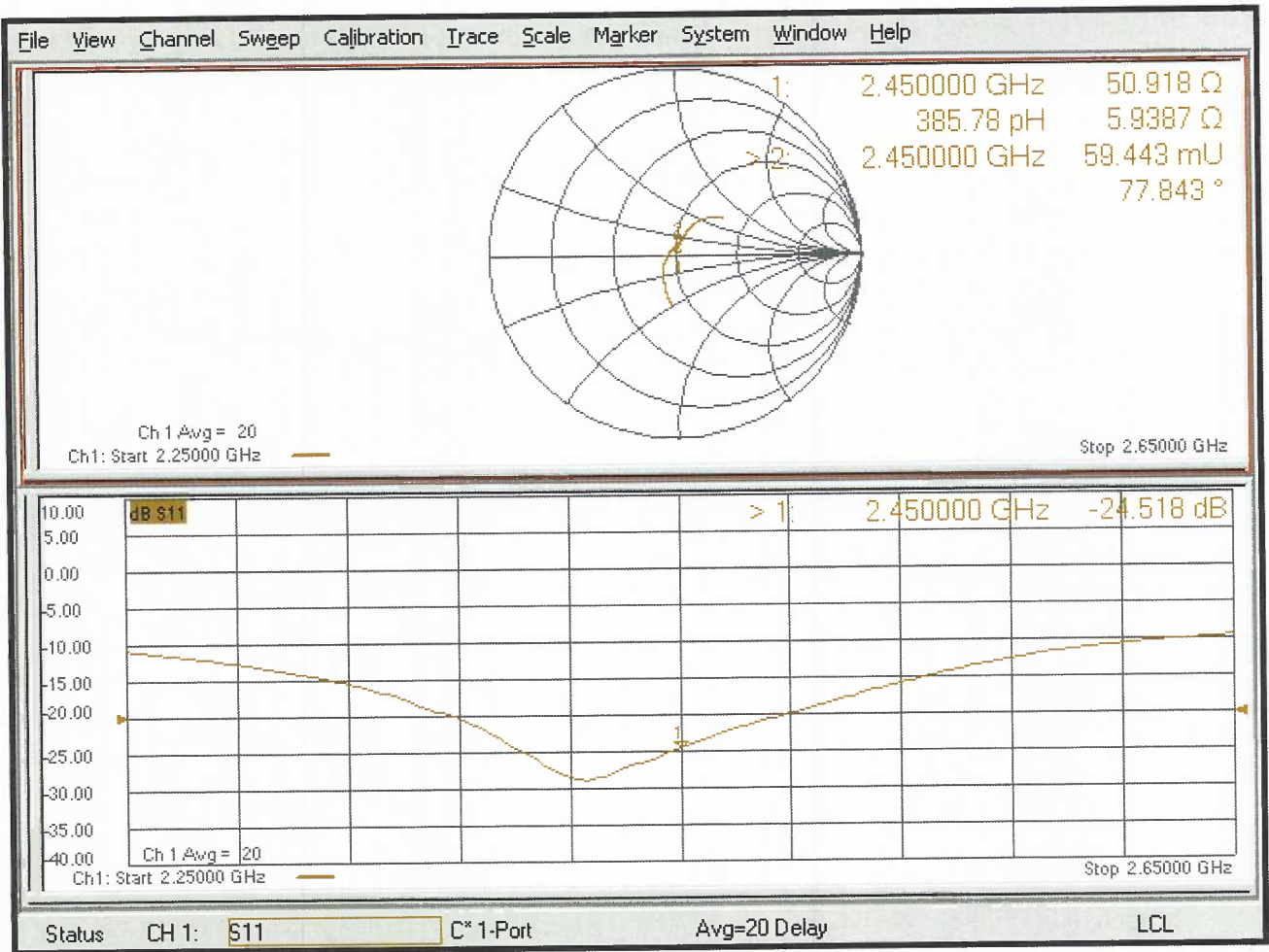

Appendix F – Phantom Calibration Data Sheets

Certificate of Conformity / First Article Inspection

Item	Oval Flat Phantom ELI 4.0
Type No	QD OVA 001 B
Series No	1003 and higher
Manufacturer	Untersee Composites Knebelstrasse 8 CH-8268 Mannenbach, Switzerland

Tests

Complete tests were made on the prototype units QD OVA 001 AA 1001, QD OVA 001 AB 1002, pre-series units QD OVA 001 BA 1003-1005 as well as on the series units QD OVA 001 BB, 1006 ff.

Test	Requirement	Details	Units tested
Material thickness	Compliant with the standard requirements	Bottom plate: 2.0mm +/- 0.2mm	all
Material parameters	Dielectric parameters for required frequencies	< 6 GHz: Rel. permittivity = 4 +/-1, Loss tangent ≤ 0.05	Material sample
Material resistivity	The material has been tested to be compatible with the liquids defined in the standards if handled and cleaned according to the instructions.	DGBE based simulating liquids. Observe Technical Note for material compatibility.	Equivalent phantoms, Material sample
Shape	Thickness of bottom material, Internal dimensions, Sagging compatible with standards from minimum frequency	Bottom elliptical 600 x 400 mm Depth 190 mm, Shape is within tolerance for filling height up to 155 mm, Eventual sagging is reduced or eliminated by support via DUT	Prototypes, Sample testing

Standards

- [1] CENELEC EN 50361-2001, « Basic standard for the measurement of the Specific Absorption Rate related to human exposure to electromagnetic fields from mobile phones (300 MHz – 3 GHz) », July 2001
- [2] IEEE 1528-2003, "Recommended Practice for Determining the Peak Spatial-Average Specific Absorption Rate (SAR) in the Human Head from Wireless Communications Devices: Measurement Techniques, December 2003
- [3] IEC 62209 – 1, "Specific Absorption Rate (SAR) in the frequency range of 300 MHz to 3 GHz – Measurement Procedure, Part 1: Hand-held mobile wireless communication devices", February 2005
- [4] IEC 62209 – 2, Draft, "Human Exposure to Radio Frequency Fields from Handheld and Body-Mounted Wireless Communication Devices – Human models, Instrumentation and Procedures – Part 2: Procedure to determine the Specific Absorption Rate (SAR) in the head and body for 30 MHz to 6 GHz Handheld and Body-Mounted Devices used in close proximity to the Body.", February 2005
- [5] OET Bulletin 65, Supplement C, "Evaluating Compliance with FCC Guidelines for Human Exposure to Radiofrequency Electromagnetic Fields", Edition January 2001

Based on the tests above, we certify that this item is in compliance with the standards [1] to [5] if operated according to the specific requirements and considering the thickness. The dimensions are fully compliant with [4] from 30 MHz to 6 GHz. For the other standards, the minimum lower frequency limit is limited due to the dimensional requirements ([1]: 450 MHz, [2]: 300 MHz, [3]: 800 MHz, [5]: 375 MHz) and possibly further by the dimensions of the DUT.

Date 28.4.2008 Signature / Stamp

s p e a g
Schmid & Partner Engineering AG
Zeughausstrasse 43, 8004 Zurich, Switzerland
Phone +41 44 245 9700, Fax +41 44 245 9779
info@speag.com; http://www.speag.com

Appendix G – Validation Summary

Per FCC KDB 865664 D02 v01r02, SAR system validation status should be documented to confirm measurement accuracy. The SAR systems (including SAR probes, system components and software versions) used for this device were validated against its performance specifications prior to the SAR measurements. Reference dipoles were used with the required tissue equivalent media for system validation according to the procedures outlined in FCC KDB 865664 D01 v01r04 and IEEE 1528-2013. Since SAR probe calibrations are frequency dependent, each probe calibration point was validated at a frequency within the valid frequency range of the probe calibration point using the system that normally operates with the probe for routine SAR measurements and according to the required tissue equivalent media.

A tabulated summary of the system validation status including the validation date(s), measurement frequencies, SAR probes and tissue dielectric parameters has been included.

**Table G-1
SAR System Validation Summary**

SAR System #	Freq. (MHz)	Date	Probe S/N	Probe Type	Probe Cal. Point	Cond. (σ)	Perm. (ϵ_r)	CW Validation			Modulation Validation			
								Sensitivity	Probe Linearity	Probe Isotropy	Modulation Type	Duty Factor	PAR	
1	750	8/25/2020	3693	EX3DV4	750	Head	0.91	41.55	Pass	Pass	Pass	QPSK	Pass	Pass
1	835	8/24/2020	3693	EX3DV4	835	Head	0.95	41.24	Pass	Pass	Pass	WCDMA	Pass	Pass
1	835	8/24/2020	3693	EX3DV4	835	Head	0.95	41.24	Pass	Pass	Pass	QPSK	Pass	Pass
1	1750	8/24/2020	3693	EX3DV4	1750	Head	1.42	39.63	Pass	Pass	Pass	QPSK	Pass	Pass
1	1900	8/24/2020	3693	EX3DV4	1900	Head	1.46	39.46	Pass	Pass	Pass	WCDMA	Pass	Pass
1	1900	8/24/2020	3693	EX3DV4	1900	Head	1.46	39.46	Pass	Pass	Pass	QPSK	Pass	Pass
1	2450	9/3/2020	3693	EX3DV4	2450	Head	1.83	38.60	Pass	Pass	Pass	OFDM/TDD	Pass	Pass