

FCC Test Report

APPLICANT : SIMCom
EQUIPMENT : WCDMA/HSDPA/HSUPA (2100MHz+1900MHz+850MHz)
/EDGE/GPRS/GSM (850MHz+900MHz+1800MHz+1900MHz)
GPS Module
BRAND NAME : SIMCom
MODEL NAME : SIM5218A
FCC ID : UDV-0200901181057
STANDARD : 47 CFR Part 2, 22(H), 24(E)
CLASSIFICATION : PCS Licensed Transmitter (PCB)
Tx/Rx FREQUENCY RANGE : GSM850 : 824.2 ~ 848.8 MHz /
869.2 ~ 893.8 MHz
GSM1900 : 1850.2 ~ 1909.8 MHz /
1930.2 ~ 1989.8 MHz
WCDMA Band V : 826.4 ~ 846.6 MHz /
871.4 ~ 891.6 MHz
WCDMA Band II : 1852.4 ~ 1907.6 MHz /
1932.4 ~ 1987.6 MHz
MAX. ERP/EIRP POWER : GSM850 (GPRS 8) : 0.27 W
GSM850 (EDGE 8) : 0.09 W
GSM1900 (GPRS 8) : 0.41 W
GSM1900 (EDGE 8) : 0.20 W
WCDMA Band V (WCDMA) : 0.03 W
WCDMA Band II (WCDMA) : 0.04 W
EMISSION DESIGNATOR : GSM : 248KGXW
EDGE : 246KG7W
WCDMA : 4M18F9W

The product sample received on May 16, 2009 and completely tested on May 19, 2009. We, SPORTON INTERNATIONAL (KUNSHAN) INC., would like to declare that the tested sample has been evaluated in accordance with the procedures given in ANSI C63.4-2003 and shown compliance with the applicable technical standards.

The test results in this report apply exclusively to the tested model / sample. Without written approval of SPORTON INTERNATIONAL (KUNSHAN) INC., the test report shall not be reproduced except in full.

Reviewed by:



Roy Wu / Manager



SPORTON INTERNATIONAL (KUNSHAN) INC.
No. 3-2, PingXiang Road, Kunshan, Jiangsu Province, P.R.C.



TABLE OF CONTENTS

REVISION HISTORY..... 3

SUMMARY OF TEST RESULT 4

1 GENERAL DESCRIPTION 5

 1.1 Applicant..... 5

 1.2 Manufacturer 5

 1.3 Feature of Equipment Under Test..... 6

 1.4 Testing Site 7

 1.5 Applied Standards 7

 1.6 Ancillary Equipment List..... 7

2 TEST CONFIGURATION OF EQUIPMENT UNDER TEST 8

 2.1 Test Mode..... 8

 2.2 Connection Diagram of Test System 9

3 TEST RESULT..... 10

 3.1 Conducted Output Power Measurement..... 10

 3.2 Effective Radiated Power and Effective Isotropic Radiated Power Measurement 13

 3.3 Occupied Bandwidth Measurement 19

 3.4 Band Edge Measurement..... 26

 3.5 Conducted Emission Measurement 33

 3.6 Field Strength of Spurious Radiation Measurement 49

 3.7 Frequency Stability Measurement..... 63

4 LIST OF MEASURING EQUIPMENT 67

5 UNCERTAINTY OF EVALUATION 68

6 CERTIFICATION OF TAF ACCREDITATION 69

APPENDIX A. PHOTOGRAPHS OF EUT

APPENDIX B. SETUP PHOTOGRAPHS

SUMMARY OF TEST RESULT

Report Section	FCC Rule	IC Rule	Description	Limit	Result
3.1	§2.1046	N/A	Conducted Output Power	N/A	PASS
3.2	§22.913(a)(2)	RSS-132(4.4) SRSP-503(5.1.3)	Effective Radiated Power	< 7 Watts for FCC (<6.3 Watts for IC)	PASS
3.2	§24.232(c)	RSS-133 (6.4) SRSP-510(5.1.2)	Equivalent Isotropic Radiated Power	< 2 Watts	PASS
3.3	§2.1049 §22.917(a) §24.238(a)	N/A	Occupied Bandwidth	N/A	PASS
3.4	§2.1051 §22.917(a) §24.238(a)	RSS-132 (4.5.1) RSS-133 (6.5.1)	Band Edge Measurement	< 43+10log ₁₀ (P[Watts])	PASS
3.5	§2.1051 §22.917(a) §24.238(a)	RSS-132 (4.5.1) RSS-133 (6.5.1)	Conducted Emission	< 43+10log ₁₀ (P[Watts])	PASS
3.6	§2.1053 §22.917(a) §24.238(a)	RSS-132 (4.5.1) RSS-133 (6.5.1)	Field Strength of Spurious Radiation	< 43+10log ₁₀ (P[Watts])	PASS
3.7	§2.1055 §22.355 §24.235	RSS-132(4.3) RSS-133(6.3)	Frequency Stability for Temperature & Voltage	< 2.5 ppm	PASS



1 General Description

1.1 Applicant

SIMCom

Building A, SIM Technology Building, No. 633, Jinzhong Road, Changning Disdriect, Shanghai P.R.
China 200335

1.2 Manufacturer

SIMCom

Building A, SIM Technology Building, No. 633, Jinzhong Road, Changning Disdriect, Shanghai P.R.
China 200335

1.3 Feature of Equipment Under Test

Product Feature & Specification	
Equipment	WCDMA/HSDPA/HSUPA (2100MHz+1900MHz+850MHz) /EDGE/GPRS/GSM (850MHz+900MHz+1800MHz+1900MHz) GPS Module
Brand Name	SIMCom
Model Name	SIM5218A
FCC ID	UDV-0200901181057
Tx Frequency	GSM850 : 824 MHz ~ 849 MHz GSM1900 : 1850 MHz ~ 1910 MHz WCDMA Band V : 824 MHz ~ 849 MHz WCDMA Band II : 1850 MHz ~ 1910 MHz
Rx Frequency	GSM850 : 869 MHz ~ 894 MHz GSM1900 : 1930 MHz ~ 1990 MHz WCDMA Band V : 869 MHz ~ 894 MHz WCDMA Band II : 1930 MHz ~ 1990 MHz
Maximum Output Power to Antenna	GSM850 : 32.43 dBm GSM1900 : 30.41 dBm WCDMA Band V : 22.68 dBm WCDMA Band II : 22.64 dBm
Maximum ERP/EIRP	GSM850 (GPRS 8) : 0.27 W (24.37 dBm) GSM850 (EDGE 8) : 0.09 W (19.42 dBm) GSM1900 (GPRS 8) : 0.41 W (26.12 dBm) GSM1900 (EDGE 8) : 0.20 W (23.05 dBm) WCDMA Band V (WCDMA) : 0.03 W (14.83 dBm) WCDMA Band II (WCDMA) : 0.04 W (16.43 dBm)
Antenna Type	Dipole Antenna
HW Version	V1.03
SW Version	MSM6290
Type of Modulation	GSM / GPRS : GMSK EDGE : 8PSK WCDMA : QPSK HSDPA : QPSK / 16QAM HSUPA : BPSK
Type of Emission	GSM : 248KGXW EDGE : 246KG7W WCDMA : 4M18F9W
EUT Stage	Identical Prototype

Remark:

1. This test report recorded only product characteristics and test results of PCS Licensed Transmitter (PCB).
2. The above EUT's information was declared by manufacturer. Please refer to the specifications or user's manual for more detailed description.

1.4 Testing Site

Test Site	SPORTON INTERNATIONAL (KUNSHAN) INC.	
Test Site Location	No. 3-2, PingXiang Road Kunshan, Jiangsu Province, P.R.C. TEL: +86-0512-5790-0158 FAX: +86-0512-5790-0958	
Test Site No.	Sporton Site No.	
	TH01-KS	03CH01-KS

1.5 Applied Standards

According to the specifications of the manufacturer, the EUT must comply with the requirements of the following standards:

- Preliminary Guidance for Receiving Applications for Certification of 3G Device. May 9, 2006.
- 47 CFR Part 2, 22(H), 24(E)
- ANSI C63.4-2003
- ANSI / TIA / EIA-603-C-2004
- IC RSS-132 Issue 2
- IC RSS-133 Issue 5

Remark:

1. All test items were verified and recorded according to the standards and without any deviation during the test.
2. This EUT has also been tested and complied with the requirements of FCC Part 15, Subpart B (DoC), recorded in a separate test report.

1.6 Ancillary Equipment List

Item	Equipment	Trade Name	Model No.	FCC ID	Data Cable	Power Cord
1.	System Simulator	R&S	CMU200	N/A	N/A	Unshielded, 1.8 m
2.	DC Power Supply	GW	GPC-60300	N/A	N/A	Unshielded, 1.8 m

2 Test Configuration of Equipment Under Test

2.1 Test Mode

During all testing, EUT is in link mode with base station emulator at maximum power level. The spurious emission measurements were carried out in semi-anechoic chamber with 3-meter test range.

Frequency range investigated for radiated emission is as follows:

1. 30 MHz to 9000 MHz for GSM850 and WCDMA Band V.
2. 30MHz to 19000 MHz for GSM1900 and WCDMA Band II.

Test Modes		
Band	Radiated TCs	Conducted TCs
GSM 850	<ul style="list-style-type: none"> ■ GPRS 8 Link ■ EDGE 8 Link 	<ul style="list-style-type: none"> ■ GPRS Link ■ EDGE Link
GSM 1900	<ul style="list-style-type: none"> ■ GPRS 8 Link ■ EDGE 8 Link 	<ul style="list-style-type: none"> ■ GPRS Link ■ EDGE Link
WCDMA Band V	<ul style="list-style-type: none"> ■ WCDMA Link 	<ul style="list-style-type: none"> ■ WCDMA Link
WCDMA Band II	<ul style="list-style-type: none"> ■ WCDMA Link 	<ul style="list-style-type: none"> ■ WCDMA Link

Note: The maximum power levels are GPRS multi-slot class 8 mode for GMSK link, EDGE multi-slot class 8 mode for 8PSK link, and RMC 12.2K mode for WCDMA link, only these modes were used for all tests. The power tables are listed as follows:

Conducted Power						
Band	GSM850			GSM1900		
Channel	128	189	251	512	661	810
Frequency	824.2	836.4	848.8	1850.2	1880.0	1909.8
GPRS 8	32.32	32.39	32.43	30.03	30.26	30.41
GPRS 10	30.63	30.74	30.81	29.96	29.62	29.14
GPRS 12	27.48	27.56	27.58	28.39	27.31	25.86
EGPRS 8	26.93	27.01	27.06	28.68	28.05	27.21
EGPRS 10	25.86	25.94	25.99	28.17	27.29	26.15
EGPRS 12	24.03	24.11	24.17	26.56	25.51	24.16

(*Unit: dBm)

Conducted Power						
Band	WCDMA Band V			WCDMA Band II		
Tx Channel	4132	4182	4233	9262	9400	9538
Frequency	826.4	836.4	846.6	1852.4	1880	1907.6
RMC 12.2K	22.55	22.68	22.40	22.14	22.64	21.80
HSDPA Subtest-1	22.48	22.62	22.41	21.41	22.06	21.06
HSDPA Subtest-2	22.30	22.33	22.20	21.64	22.11	21.17
HSDPA Subtest-3	21.77	22.04	21.85	20.98	21.60	20.60
HSDPA Subtest-4	21.78	21.87	21.68	20.97	21.68	20.72
HSUPA Subtest-1	21.56	21.94	21.53	20.89	21.48	20.82
HSUPA Subtest-2	20.25	20.56	20.15	19.34	20.14	19.35
HSUPA Subtest-3	20.67	20.96	20.74	20.03	20.62	19.77
HSUPA Subtest-4	20.55	20.95	20.50	20.54	20.69	19.61
HSUPA Subtest-5	21.49	21.89	22.09	21.08	21.64	20.65

(*Unit: dBm)

2.2 Connection Diagram of Test System

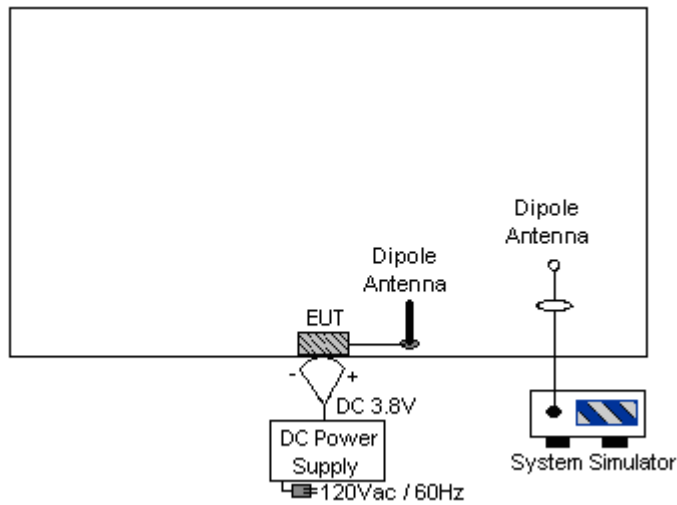

3 Test Result

3.1 Conducted Output Power Measurement

3.1.1 Description of the Conducted Output Power Measurement

A base station simulator was used to establish communication with the EUT. Its parameters were set to transmit the maximum power on the EUT. The measured power in the radio frequency on the transmitter output terminals shall be reported.

3.1.2 Measuring Instruments

See list of measuring instruments of this test report.

3.1.3 Test Procedures

1. The transmitter output port was connected to base station.
2. Set EUT at maximum power through base station.
3. Select lowest, middle, and highest channels for each band and different modulation.

3.1.4 Test Setup

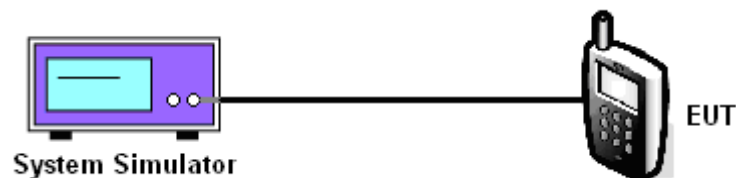

3.1.5 Test Result of Conducted Output Power

Cellular Band			
Modes	Channel	Frequency (MHz)	Conducted Power (dBm)
GPRS 8	128 (Low)	824.2	32.32
	189 (Mid)	836.4	32.39
	251 (High)	848.8	32.43
EDGE 8	128 (Low)	824.2	26.93
	189 (Mid)	836.4	27.01
	251 (High)	848.8	27.06
WCDMA Band V	12.2k bps	4132 (Low)	22.55
		4182 (Mid)	22.68
		4233 (High)	22.40
	HSDPA Subtest-1	4132 (Low)	22.48
		4182 (Mid)	22.62
		4233 (High)	22.41
	HSDPA Subtest-2	4132 (Low)	22.30
		4182 (Mid)	22.33
		4233 (High)	22.20
	HSDPA Subtest-3	4132 (Low)	21.77
		4182 (Mid)	22.04
		4233 (High)	21.85
	HSDPA Subtest-4	4132 (Low)	21.78
		4182 (Mid)	21.87
		4233 (High)	21.68
	HSUPA Subtest-1	4132 (Low)	21.56
		4182 (Mid)	21.94
		4233 (High)	21.53
	HSUPA Subtest-2	4132 (Low)	20.25
		4182 (Mid)	20.56
		4233 (High)	20.15
	HSUPA Subtest-3	4132 (Low)	20.67
		4182 (Mid)	20.96
		4233 (High)	20.74
	HSUPA Subtest-4	4132 (Low)	20.55
		4182 (Mid)	20.95
		4233 (High)	20.50
	HSUPA Subtest-5	4132 (Low)	21.49
		4182 (Mid)	21.89
		4233 (High)	22.09



PCS Band				
Modes	Channel	Frequency (MHz)	Conducted Power (dBm)	
GPRS 8	512 (Low)	1850.2	30.03	
	661 (Mid)	1880.0	30.26	
	810 (High)	1909.8	30.41	
EDGE 8	512 (Low)	1850.2	28.68	
	661 (Mid)	1880.0	28.05	
	810 (High)	1909.8	27.21	
WCDMA Band II	12.2k bps	9262 (Low)	1852.4	22.14
		9400 (Mid)	1880.0	22.64
		9538 (High)	1907.6	21.80
	HSDPA Subtest-1	9262 (Low)	1852.4	21.41
		9400 (Mid)	1880.0	22.06
		9538 (High)	1907.6	21.06
	HSDPA Subtest-2	9262 (Low)	1852.4	21.64
		9400 (Mid)	1880.0	22.11
		9538 (High)	1907.6	21.17
	HSDPA Subtest-3	9262 (Low)	1852.4	20.98
		9400 (Mid)	1880.0	21.60
		9538 (High)	1907.6	20.60
	HSDPA Subtest-4	9262 (Low)	1852.4	20.97
		9400 (Mid)	1880.0	21.68
		9538 (High)	1907.6	20.72
	HSUPA Subtest-1	9262 (Low)	1852.4	20.89
		9400 (Mid)	1880.0	21.48
		9538 (High)	1907.6	20.82
	HSUPA Subtest-2	9262 (Low)	1852.4	19.34
		9400 (Mid)	1880.0	20.14
		9538 (High)	1907.6	19.35
	HSUPA Subtest-3	9262 (Low)	1852.4	20.03
		9400 (Mid)	1880.0	20.62
		9538 (High)	1907.6	19.77
	HSUPA Subtest-4	9262 (Low)	1852.4	20.54
		9400 (Mid)	1880.0	20.69
		9538 (High)	1907.6	19.61
	HSUPA Subtest-5	9262 (Low)	1852.4	21.08
		9400 (Mid)	1880.0	21.64
		9538 (High)	1907.6	20.65

3.2 Effective Radiated Power and Effective Isotropic Radiated Power Measurement

3.2.1 Description of the ERP/EIRP Measurement

ERP/EIRP is measured by substitution method according to ANSI / TIA / EIA-603-C-2004. The ERP of mobile transmitters must not exceed 7 Watts and the EIRP of mobile transmitters are limited to 2 Watts.

3.2.2 Measuring Instruments

See list of measuring instruments of this test report.

3.2.3 Test Procedures

1. The EUT was placed on a turntable with 1.0 meter height in a fully anechoic chamber.
2. The EUT was set at 1.2 meters from the receiving antenna, which was mounted on the antenna tower.
3. The table was rotated 360 degrees to determine the position of the highest radiated power.
4. The height of the receiving antenna is adjusted to look for the maximum ERP/EIRP.
5. Taking the record of maximum ERP/EIRP.
6. A dipole antenna was substituted in place of the EUT and was driven by a signal generator.
7. The conducted power at the terminal of the dipole antenna is measured.
8. Repeat step 3 to step 5 to get the maximum ERP/EIRP of the substitution antenna.
9. $ERP/EIRP = P_s + E_t - E_s + G_s = P_s + R_t - R_s + G_s$
Ps (dBm) : Input power to substitution antenna.
Gs (dBi or dBd) : Substitution antenna Gain.
 $E_t = R_t + AF$
 $E_s = R_s + AF$
AF (dB/m) : Receive antenna factor
Rt : The highest received signal in spectrum analyzer for EUT.
Rs : The highest received signal in spectrum analyzer for substitution antenna.

3.2.4 Test Setup

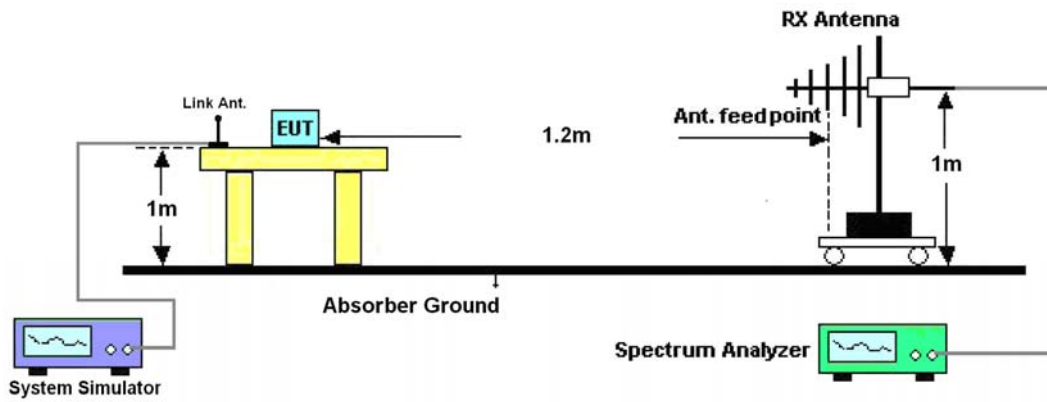

3.2.5 Test Result of ERP

GSM850 (GPRS 8) Radiated Power ERP						
Horizontal Polarization						
Frequency (MHz)	Rt (dBm)	Rs (dBm)	Ps (dBm)	Gs (dBd)	ERP (dBm)	ERP (W)
824.20	-25.09	-48.12	0.00	-1.08	21.95	0.16
836.40	-24.52	-48.28	0.00	-0.93	22.83	0.19
848.80	-26.72	-48.35	0.00	-0.76	20.87	0.12
Vertical Polarization						
Frequency (MHz)	Rt (dBm)	Rs (dBm)	Ps (dBm)	Gs (dBd)	ERP (dBm)	ERP (W)
824.20	-22.52	-47.97	0.00	-1.08	24.37	0.27
836.40	-25.40	-48.01	0.00	-0.93	21.68	0.15
848.80	-25.84	-48.05	0.00	-0.76	21.45	0.14

GSM850 (EDGE 8) Radiated Power ERP						
Horizontal Polarization						
Frequency (MHz)	Rt (dBm)	Rs (dBm)	Ps (dBm)	Gs (dBd)	ERP (dBm)	ERP (W)
824.20	-30.32	-48.12	0.00	-1.08	16.72	0.05
836.40	-29.55	-48.28	0.00	-0.93	17.80	0.06
848.80	-31.59	-48.35	0.00	-0.76	16.00	0.04
Vertical Polarization						
Frequency (MHz)	Rt (dBm)	Rs (dBm)	Ps (dBm)	Gs (dBd)	ERP (dBm)	ERP (W)
824.20	-27.47	-47.97	0.00	-1.08	19.42	0.09
836.40	-28.26	-48.01	0.00	-0.93	18.82	0.08
848.80	-30.70	-48.05	0.00	-0.76	16.59	0.05



WCDMA Band V (WCDMA) Radiated Power ERP						
Horizontal Polarization						
Frequency (MHz)	Rt (dBm)	Rs (dBm)	Ps (dBm)	Gs (dBd)	ERP (dBm)	ERP (W)
826.40	-32.25	-48.12	0.00	-1.08	14.79	0.03
836.40	-32.71	-48.28	0.00	-0.93	14.64	0.03
846.60	-32.76	-48.35	0.00	-0.76	14.83	0.03
Vertical Polarization						
Frequency (MHz)	Rt (dBm)	Rs (dBm)	Ps (dBm)	Gs (dBd)	ERP (dBm)	ERP (W)
826.40	-34.08	-47.97	0.00	-1.08	12.81	0.02
836.40	-36.25	-48.01	0.00	-0.93	10.83	0.01
846.60	-35.17	-48.05	0.00	-0.76	12.12	0.02

3.2.6 Test Result of EIRP

GSM1900 (GPRS 8) Radiated Power EIRP						
Horizontal Polarization						
Frequency (MHz)	Rt (dBm)	Rs (dBm)	Ps (dBm)	Gs (dBi)	EIRP (dBm)	EIRP (W)
1850.20	-37.83	-51.88	0.00	1.96	16.01	0.04
1880.00	-34.79	-52.99	0.00	2.00	20.20	0.10
1909.80	-34.38	-54.28	0.00	1.98	21.88	0.15
Vertical Polarization						
Frequency (MHz)	Rt (dBm)	Rs (dBm)	Ps (dBm)	Gs (dBi)	EIRP (dBm)	EIRP (W)
1850.20	-31.61	-52.13	0.00	1.96	22.48	0.18
1880.00	-30.07	-53.17	0.00	2.00	25.10	0.32
1909.80	-29.99	-54.13	0.00	1.98	26.12	0.41

GSM1900 (EDGE 8) Radiated Power EIRP						
Horizontal Polarization						
Frequency (MHz)	Rt (dBm)	Rs (dBm)	Ps (dBm)	Gs (dBi)	EIRP (dBm)	EIRP (W)
1850.20	-32.75	-51.88	0.00	1.96	21.09	0.13
1880.00	-34.96	-52.99	0.00	2.00	20.03	0.10
1909.80	-37.99	-54.28	0.00	1.98	18.27	0.07
Vertical Polarization						
Frequency (MHz)	Rt (dBm)	Rs (dBm)	Ps (dBm)	Gs (dBi)	EIRP (dBm)	EIRP (W)
1850.20	-31.04	-52.13	0.00	1.96	23.05	0.20
1880.00	-36.60	-53.17	0.00	2.00	18.57	0.07
1909.80	-34.42	-54.13	0.00	1.98	21.69	0.15



WCDMA Band II (WCDMA) Radiated Power EIRP						
Horizontal Polarization						
Frequency (MHz)	Rt (dBm)	Rs (dBm)	Ps (dBm)	Gs (dBi)	EIRP (dBm)	EIRP (W)
1852.40	-42.41	-51.88	0.00	1.96	11.43	0.01
1880.00	-40.87	-52.99	0.00	2.00	14.12	0.03
1907.60	-42.14	-54.28	0.00	1.98	14.12	0.03
Vertical Polarization						
Frequency (MHz)	Rt (dBm)	Rs (dBm)	Ps (dBm)	Gs (dBi)	EIRP (dBm)	EIRP (W)
1852.40	-37.66	-52.13	0.00	1.96	16.43	0.04
1880.00	-40.23	-53.17	0.00	2.00	14.94	0.03
1907.60	-39.81	-54.13	0.00	1.98	16.30	0.04

3.3 Occupied Bandwidth Measurement

3.3.1 Description of Occupied Bandwidth Measurement

The emission bandwidth is defined as the width of the signal between two points, located at the 2 sides of the carrier frequency, outside of which all emissions are attenuated at least 26 dB below the transmitter power.

3.3.2 Measuring Instruments

See list of measuring instruments of this test report.

3.3.3 Test Procedures

1. The EUT was connected to Spectrum Analyzer and Base Station via power divider.
2. The 99% and 26 dB occupied bandwidth (BW) of the middle channel for the highest RF powers were measured.
3. The RBW was replaced by 10 kHz, due to the spectrum analyzer IF-Filter including an excess of the limit. A worst case correction factor of $10 \log (1\% \text{ BW}/\text{measurement RBW})$ was implemented.

3.3.4 Test Setup

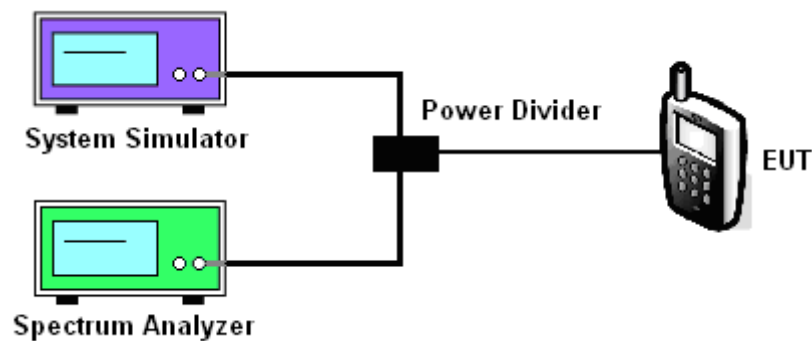



3.3.5 Test Result (Plots) of Occupied Bandwidth

Band :	GSM 850	Power Stage :	High
Test Mode :	GPRS 8 Link		

99% Occupied Bandwidth Plot on Channel 189

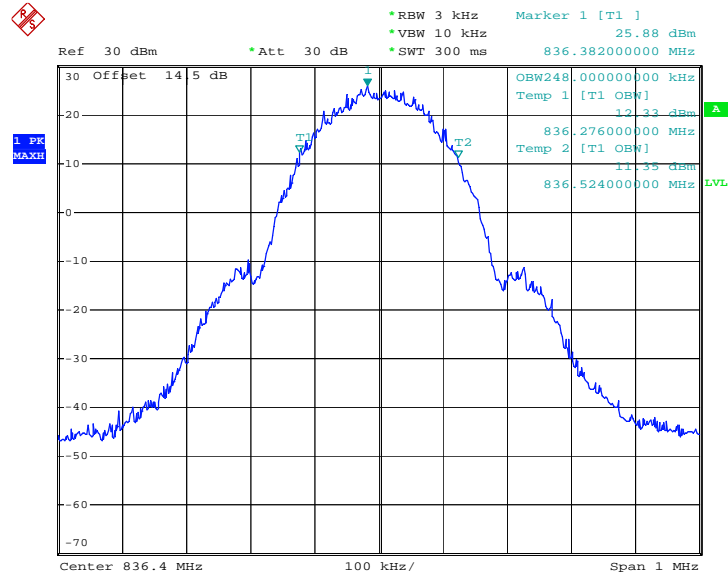

Date: 14.MAY.2009 13:02:50

26dB Bandwidth Plot on Channel 189

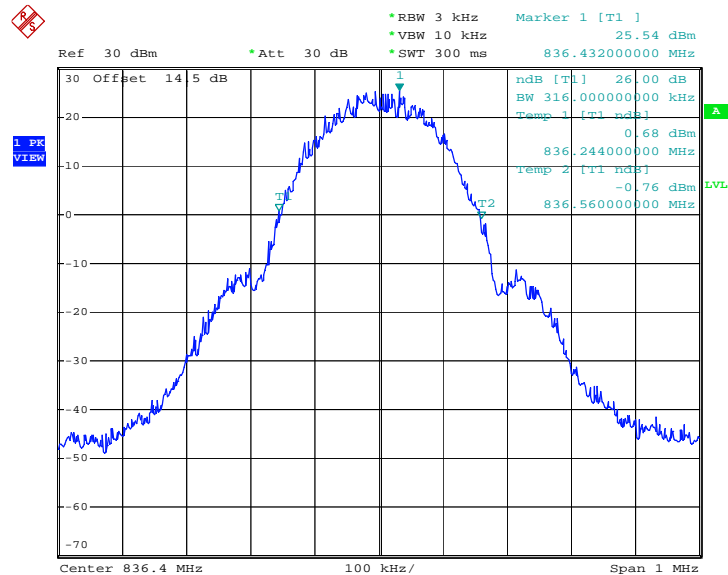

Date: 14.MAY.2009 12:48:36



Band :	GSM 850	Power Stage :	High
Test Mode :	EDGE 8 Link		

99% Occupied Bandwidth Plot on Channel 189

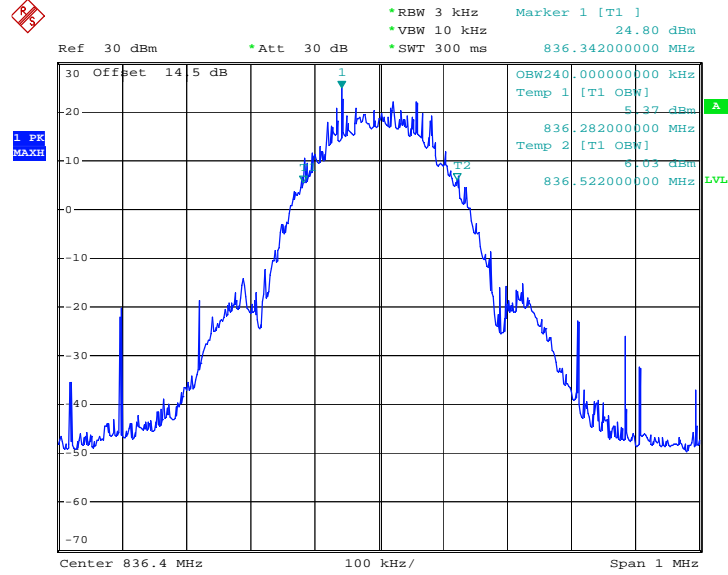

Date: 14.MAY.2009 14:38:06

26dB Bandwidth Plot on Channel 189

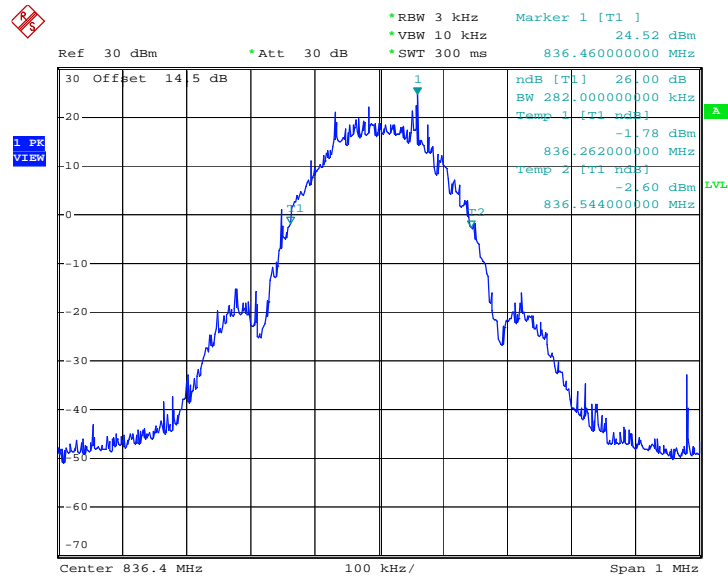

Date: 14.MAY.2009 13:31:35



Band :	GSM 1900	Power Stage :	High
Test Mode :	GPRS 8 Link		

99% Occupied Bandwidth Plot on Channel 661

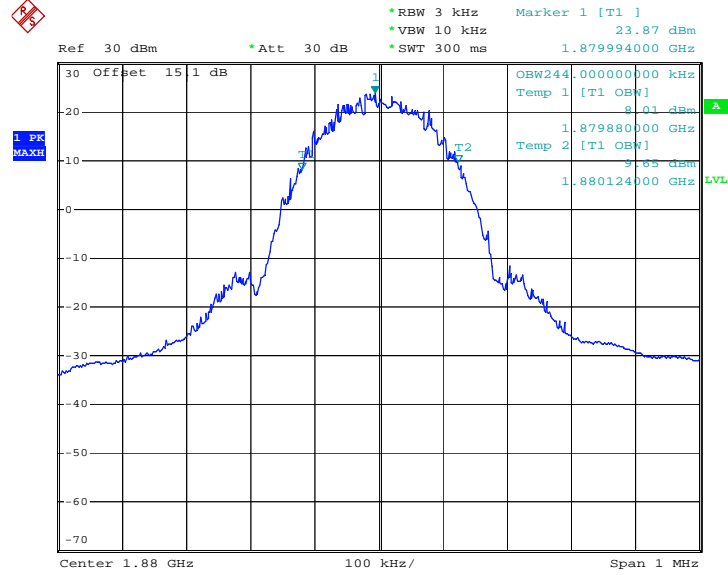

Date: 14.MAY.2009 15:33:03

26dB Bandwidth Plot on Channel 661

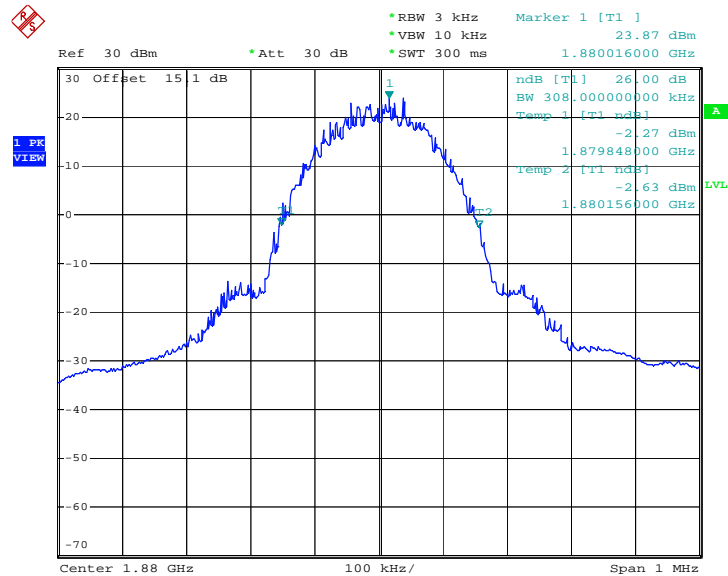

Date: 14.MAY.2009 15:22:46



Band :	GSM 1900	Power Stage :	High
Test Mode :	EDGE 8 Link		

99% Occupied Bandwidth Plot on Channel 661

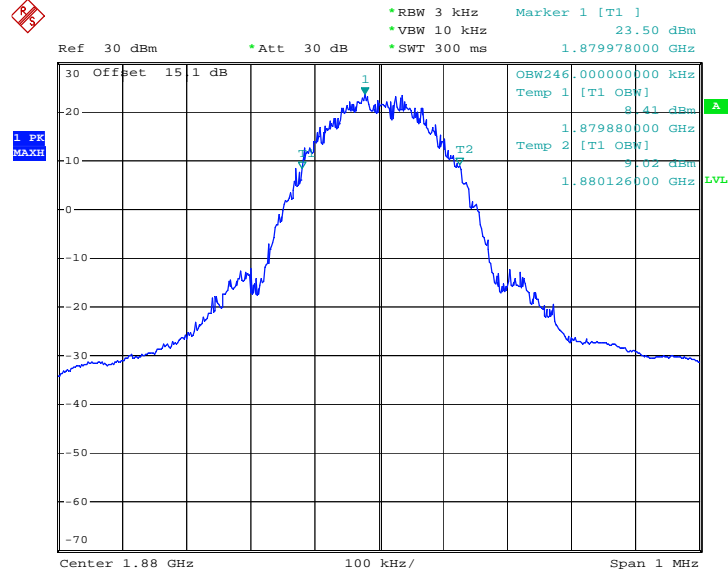

Date: 14.MAY.2009 05:01:20

26dB Bandwidth Plot on Channel 661

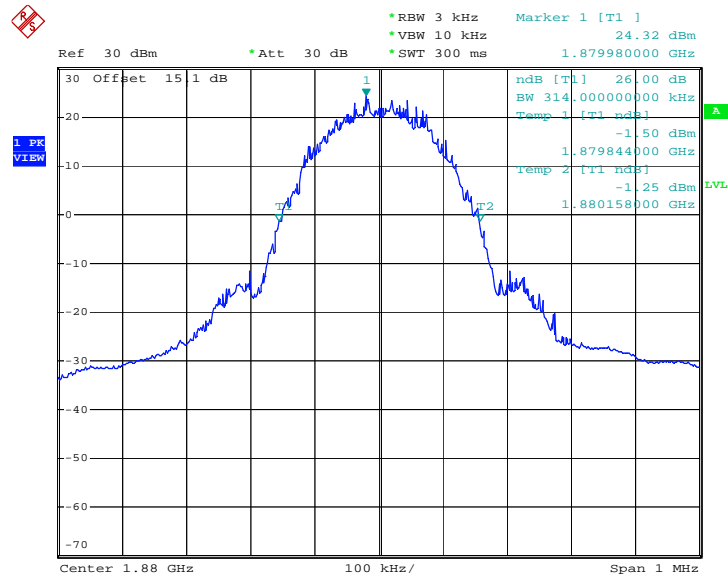

Date: 14.MAY.2009 04:50:57



Band :	WCDMA Band V	Power Stage :	High
Test Mode :	WCDMA Link		

99% Occupied Bandwidth Plot on Channel 4182

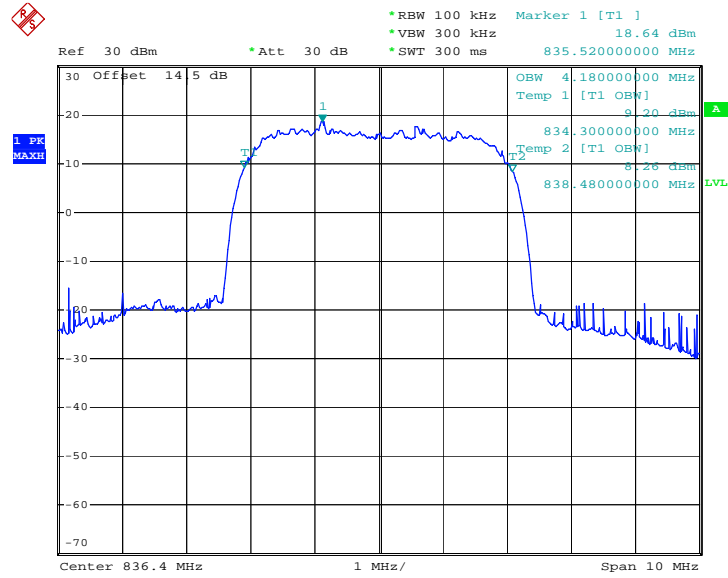

Date: 14.MAY.2009 08:20:01

26dB Bandwidth Plot on Channel 4182

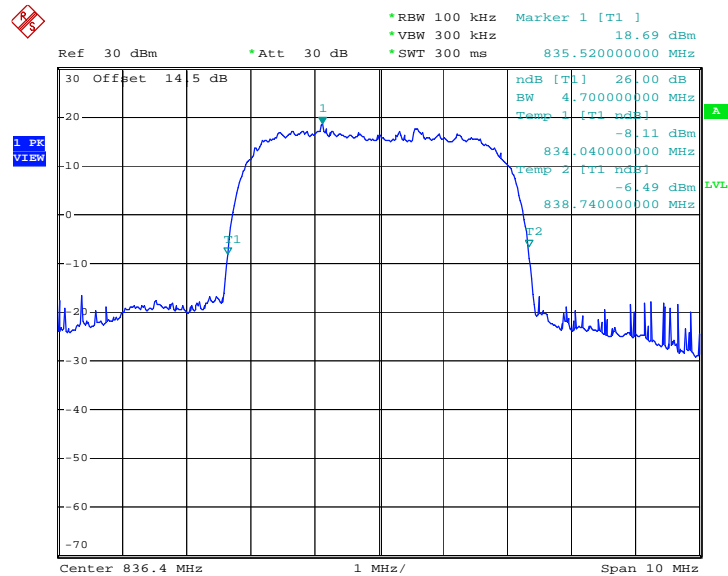

Date: 14.MAY.2009 08:12:02



Band :	WCDMA Band II	Power Stage :	High
Test Mode :	WCDMA Link		

99% Occupied Bandwidth Plot on Channel 9400

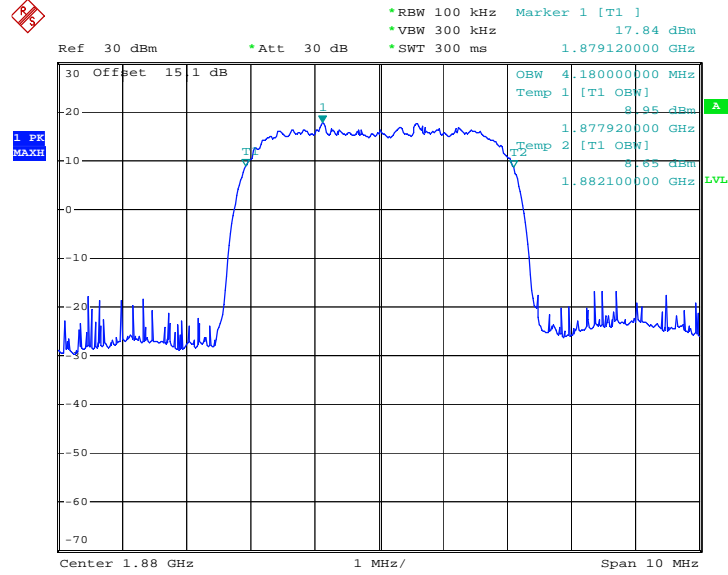

Date: 14.MAY.2009 05:59:00

26dB Bandwidth Plot on Channel 9400

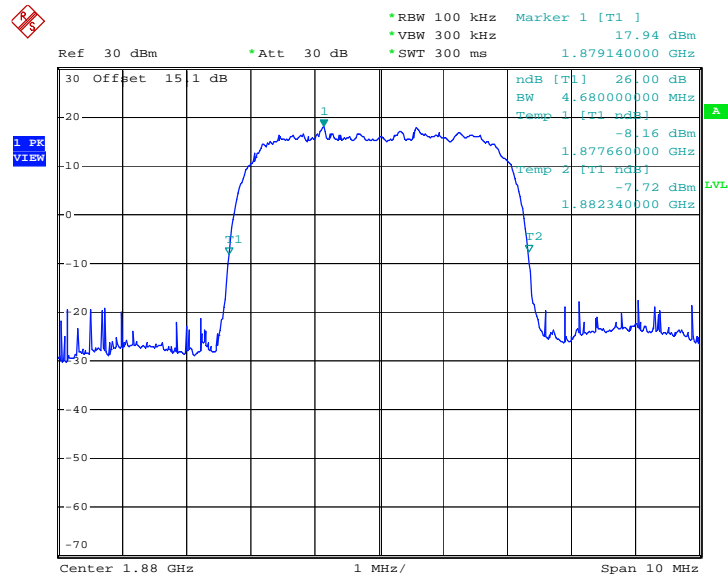

Date: 14.MAY.2009 05:44:40

3.4 Band Edge Measurement

3.4.1 Description of Band Edge Measurement

The power of any emission outside of the authorized operating frequency ranges must be lower than the transmitter power (P) by a factor of at least $43 + 10 \log (P)$ dB.

3.4.2 Measuring Instruments

See list of measuring instruments of this test report.

3.4.3 Test Procedures

1. The EUT was connected to Spectrum Analyzer and Base Station via power divider.
2. The band edges of low and high channels for the highest RF powers were measured. Setting RBW as roughly $BW/100$.

3.4.4 Test Setup

<Conducted Band Edge >

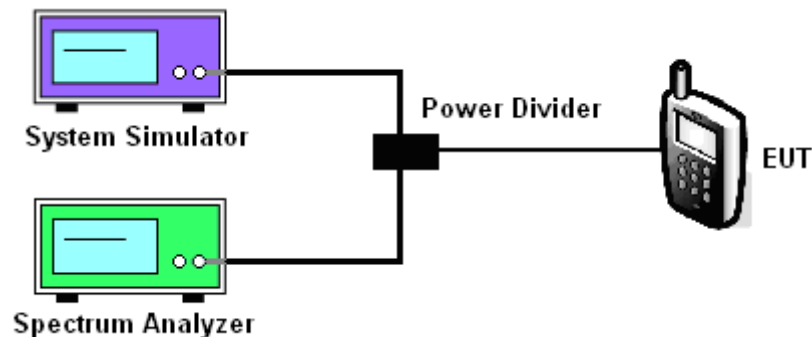



3.4.5 Test Result (Plots) of Conducted Band Edge

Band :	GSM850	Power Stage :	High
Test Mode :	GPRS 8 Link		

Lower Band Edge Plot on Channel 128

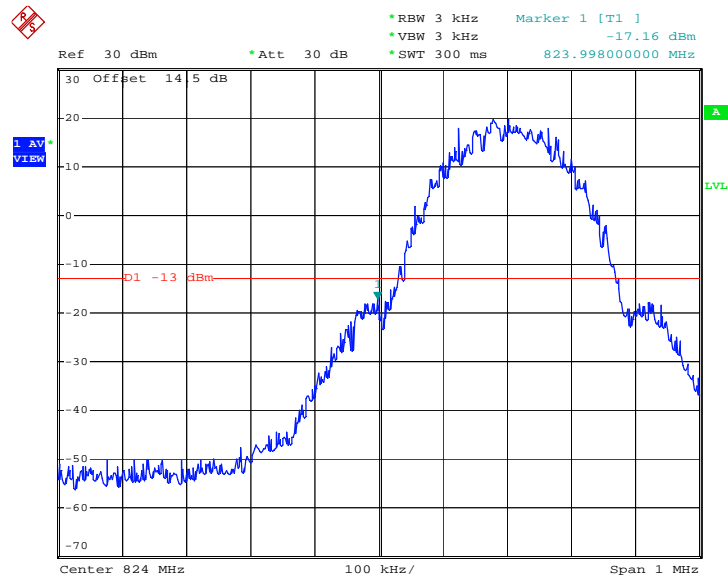

Date: 14.MAY.2009 12:53:05

Higher Band Edge Plot on Channel 251

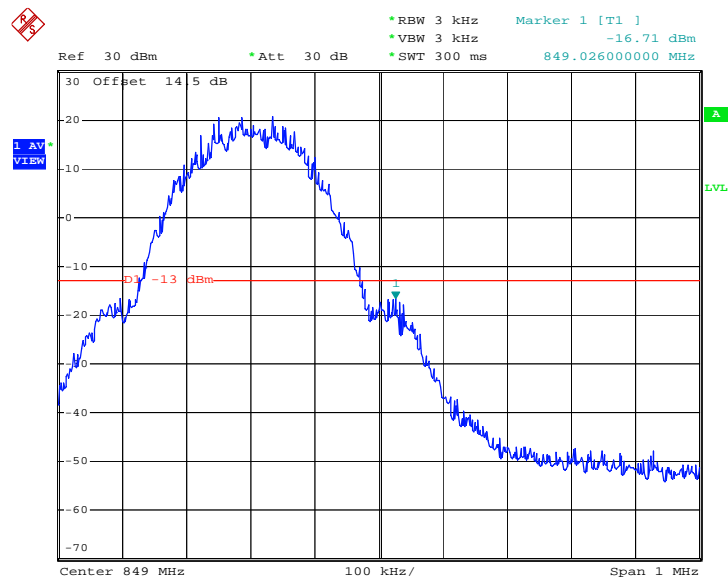

Date: 14.MAY.2009 12:54:54



Band :	GSM850	Power Stage :	High
Test Mode :	EDGE 8 Link		

Lower Band Edge Plot on Channel 128

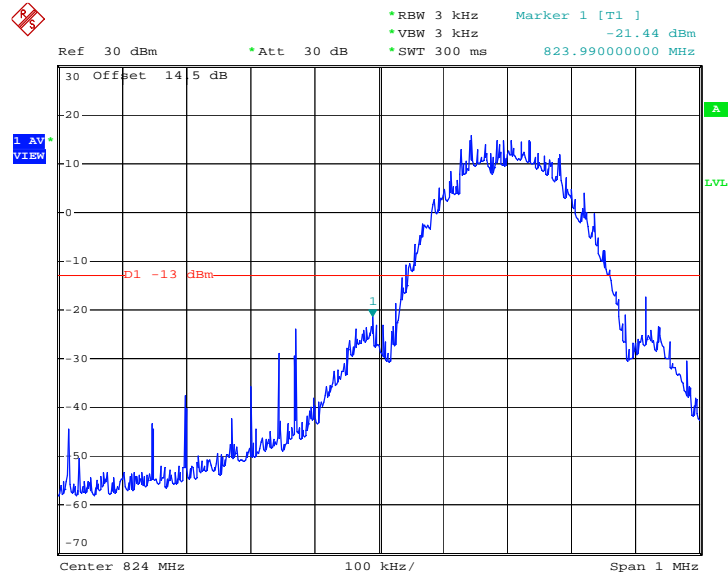

Date: 14.MAY.2009 13:35:09

Higher Band Edge Plot on Channel 251

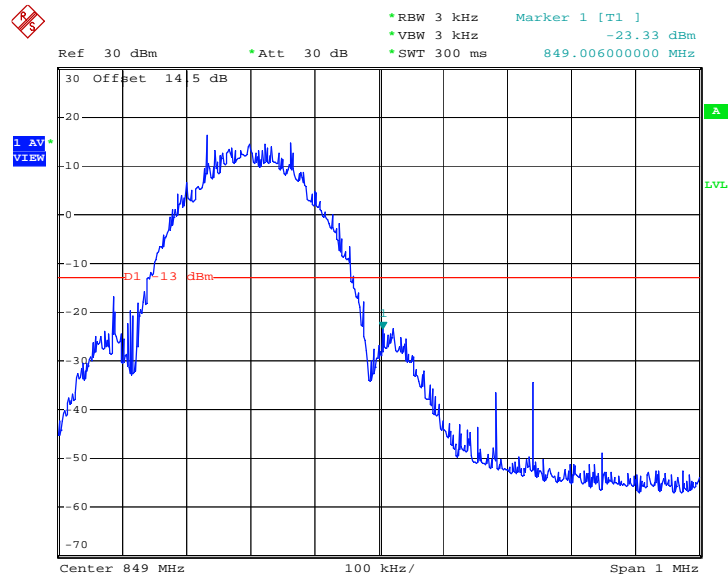

Date: 14.MAY.2009 13:37:04



Band :	GSM1900	Power Stage :	High
Test Mode :	GPRS 8 Link		

Lower Band Edge Plot on Channel 512

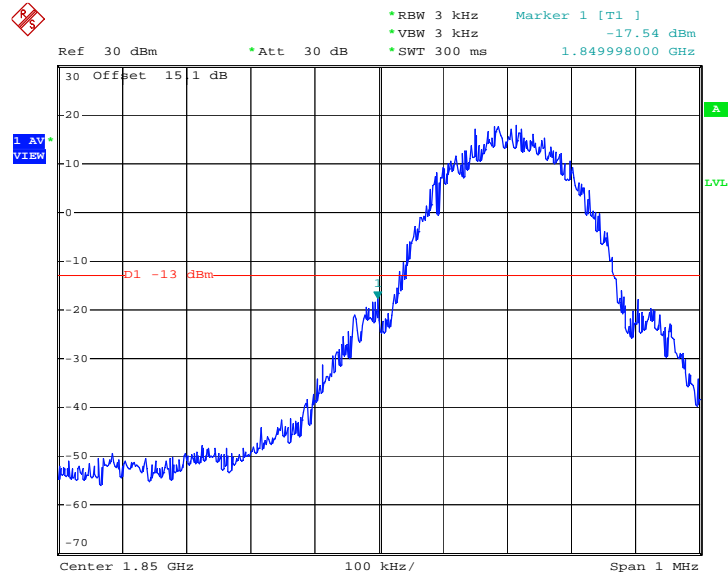

Date: 14.MAY.2009 15:25:07

Higher Band Edge Plot on Channel 810

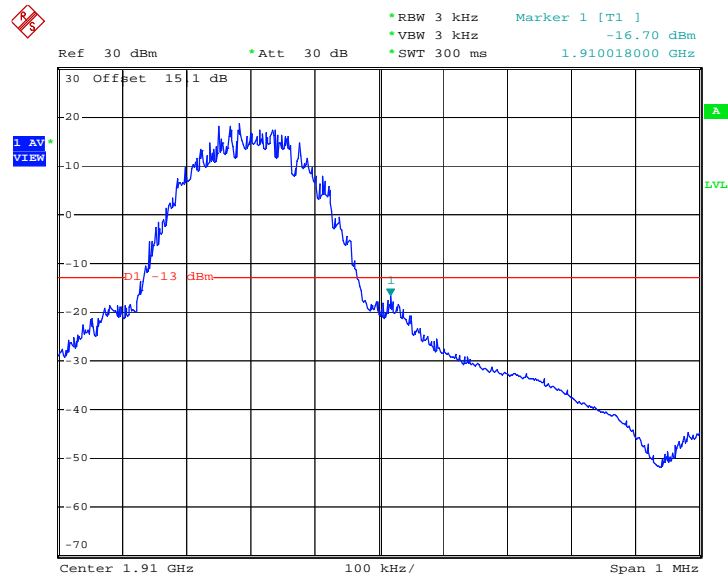

Date: 14.MAY.2009 15:26:23



Band :	GSM1900	Power Stage :	High
Test Mode :	EDGE 8 Link		

Lower Band Edge Plot on Channel 512

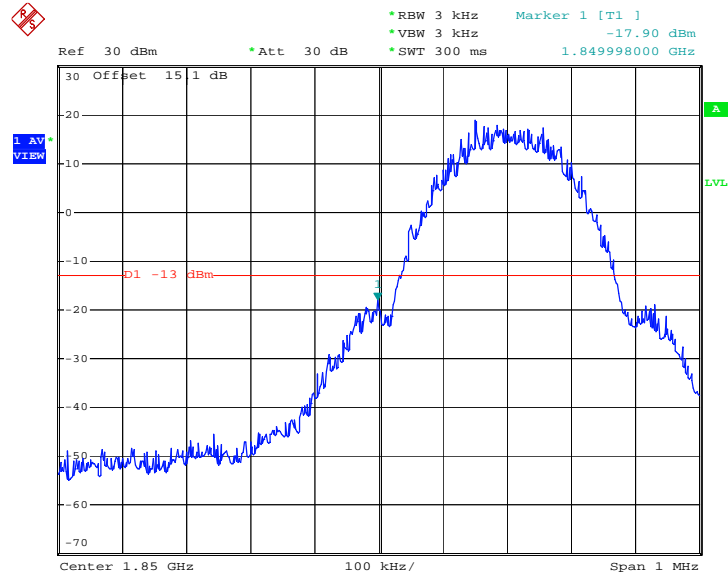

Date: 14.MAY.2009 04:53:51

Higher Band Edge Plot on Channel 810

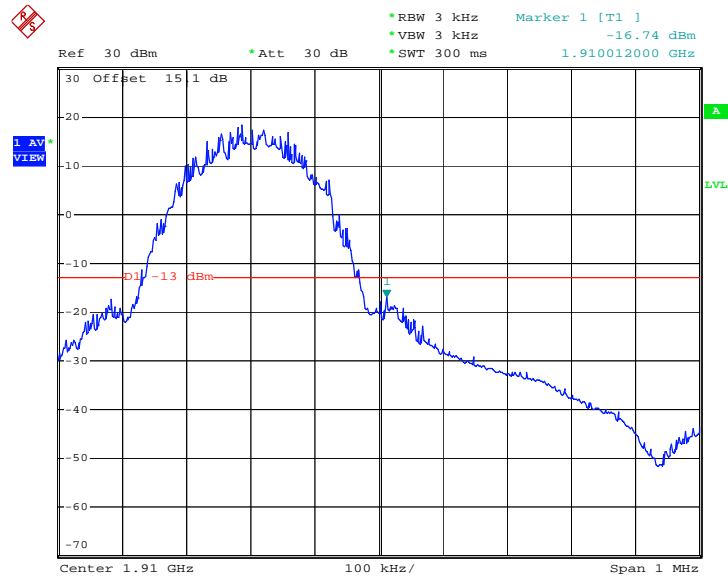

Date: 14.MAY.2009 04:54:57



Band :	WCDMA Band V	Power Stage :	High
Test Mode :	WCDMA Link		

Lower Band Edge Plot on Channel 4132

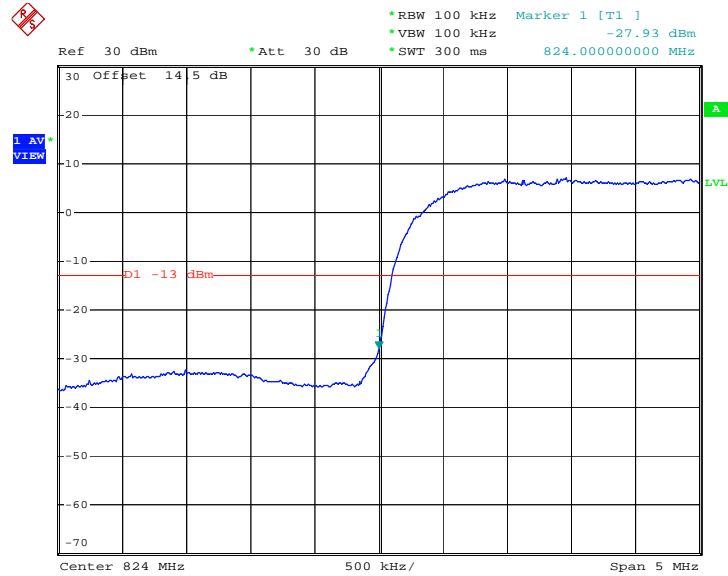

Date: 14.MAY.2009 08:22:33

Higher Band Edge Plot on Channel 4233

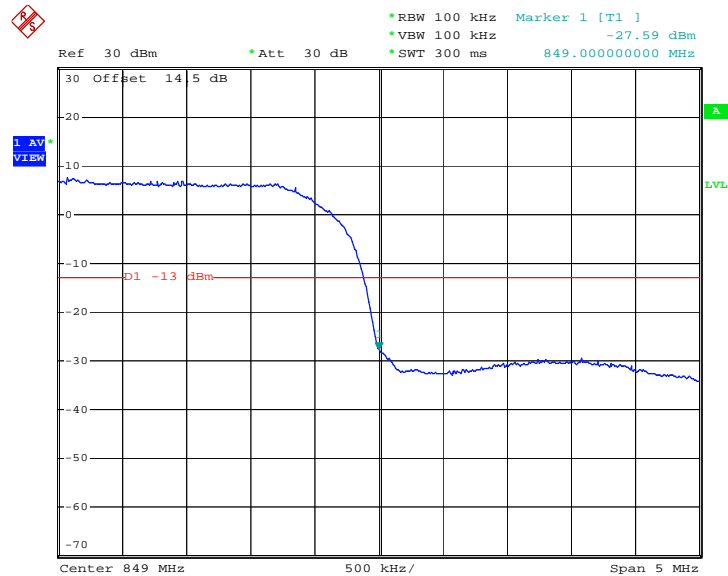

Date: 14.MAY.2009 08:30:50



Band :	WCDMA Band II	Power Stage :	High
Test Mode :	WCDMA Link		

Lower Band Edge Plot on Channel 9262

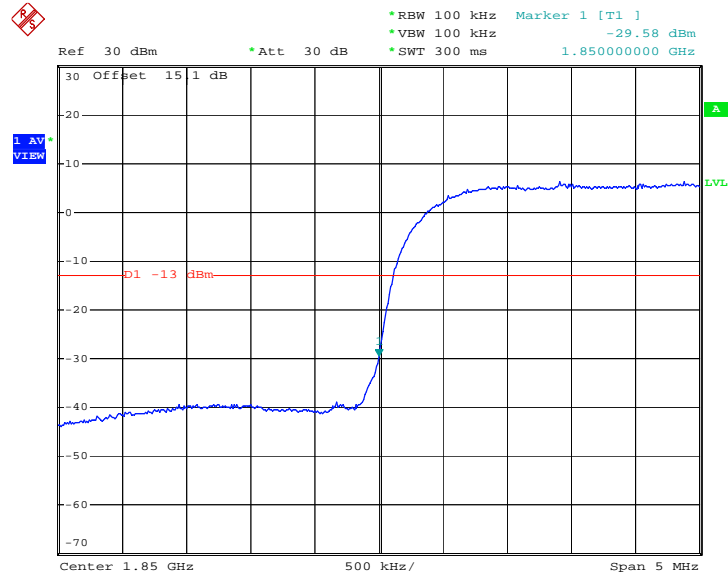

Date: 14.MAY.2009 05:48:49

Higher Band Edge Plot on Channel 9538

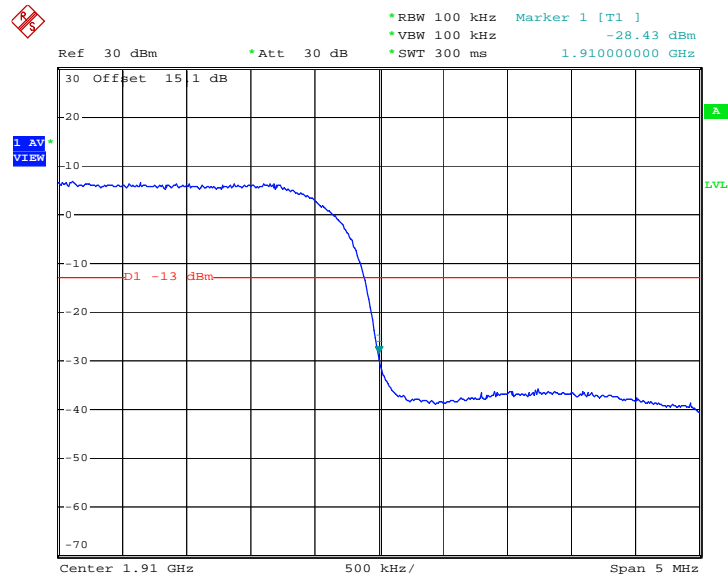

Date: 14.MAY.2009 05:49:42

3.5 Conducted Emission Measurement

3.5.1 Description of Conducted Emission Measurement

The power of any emission outside of the authorized operating frequency ranges must be lower than the transmitter power (P) by a factor of at least $43 + 10 \log (P)$ dB.

It is measured by means of a calibrated spectrum analyzer and scanned from 30 MHz up to a frequency including its 10th harmonic.

3.5.2 Measuring Instruments

See list of measuring instruments of this test report.

3.5.3 Test Procedures

1. The EUT was connected to spectrum analyzer and base station via power divider.
2. The middle channel for the highest RF power within the transmitting frequency was measured.
3. The conducted spurious emission for the whole frequency range was taken.

3.5.4 Test Setup

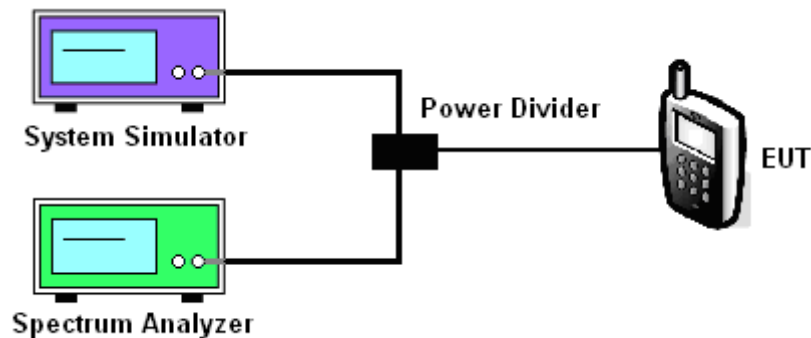

3.5.5 Test Result (Plots) of Conducted Emission

Band :	GSM850	Channel :	CH189
Test Mode :	GPRS 8 Link		

Conducted Emission Plot between 30MHz ~ 1GHz

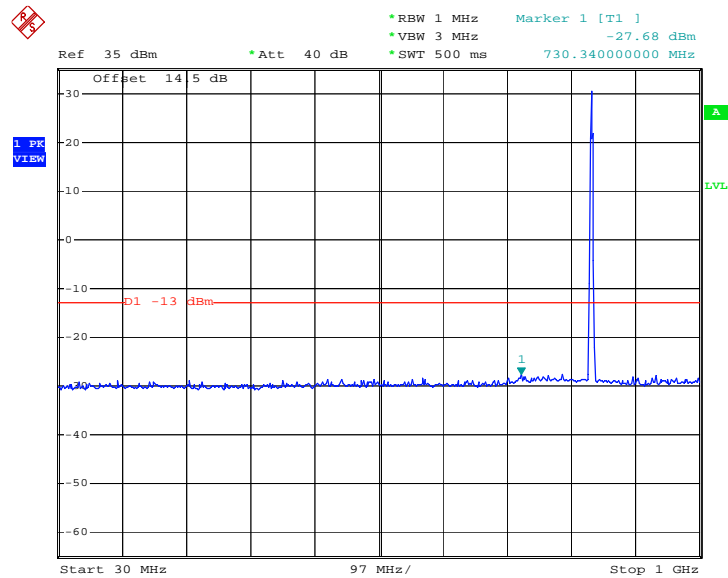

Date: 14.MAY.2009 04:41:37

Conducted Emission Plot between 1GHz ~ 3GHz

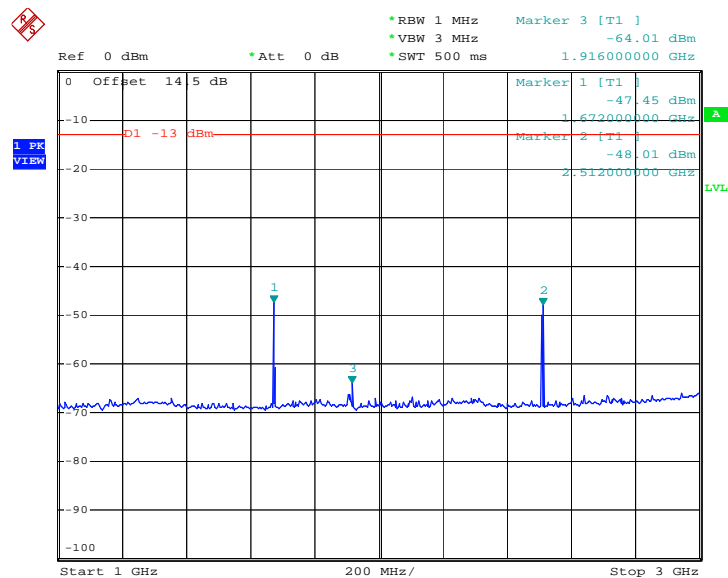

Date: 14.MAY.2009 04:34:26



Conducted Emission Plot between 3GHz ~ 7GHz

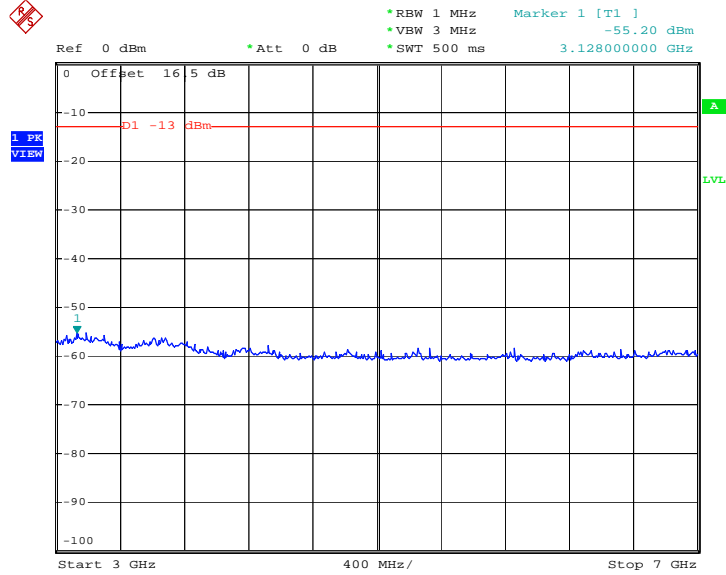

Date: 14.MAY.2009 04:36:21

Conducted Emission Plot between 7GHz ~ 9GHz

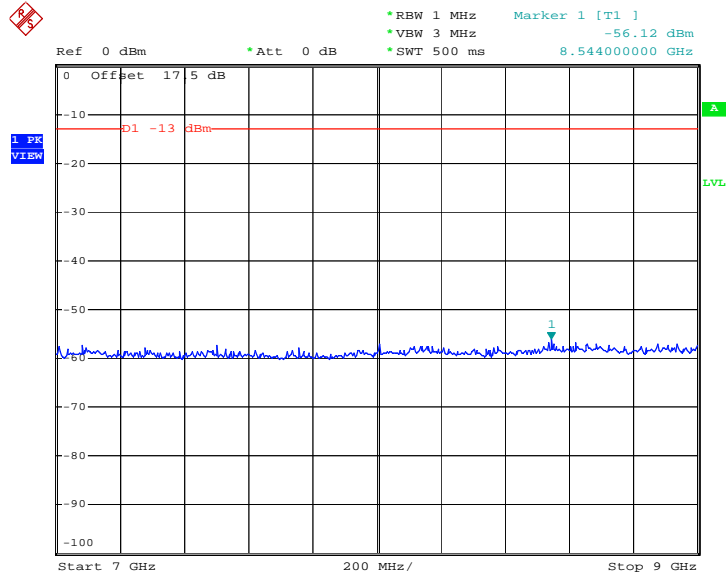

Date: 18.MAY.2009 23:38:21



Band :	GSM850	Channel :	CH189
Test Mode :	EDGE 8 Link		

Conducted Emission Plot between 30MHz ~ 1GHz

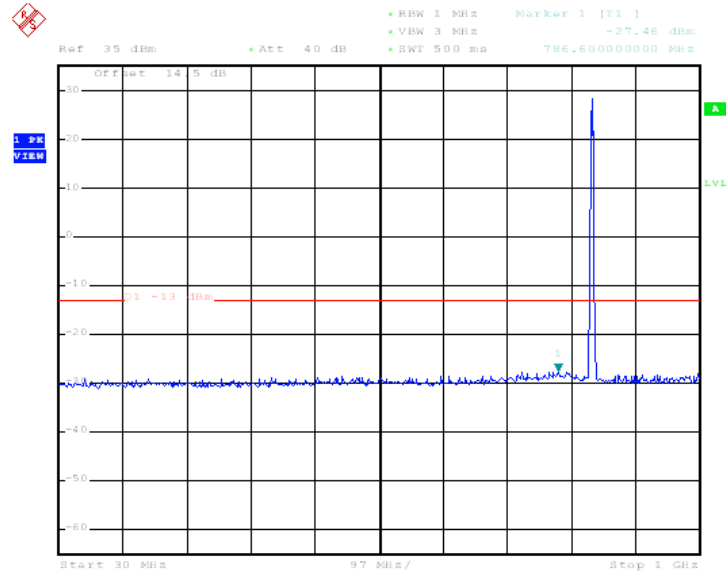

Date: 14.MAY.2009 04:25:24

Conducted Emission Plot between 1GHz ~ 3GHz

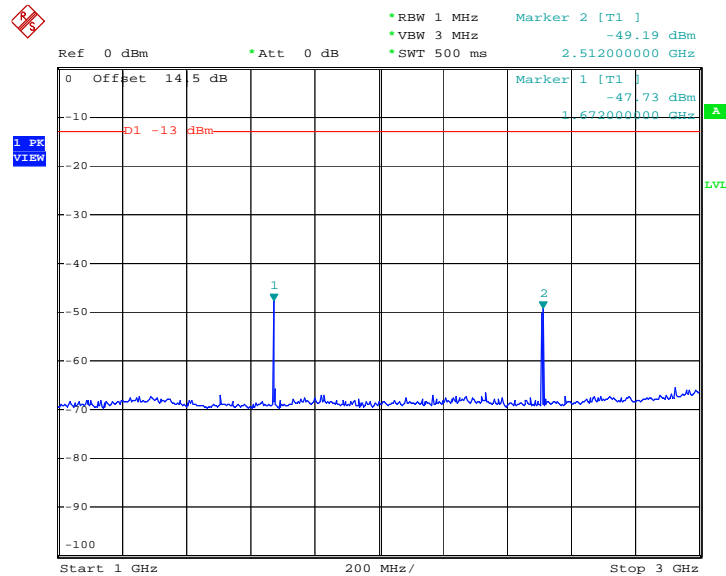

Date: 14.MAY.2009 04:28:22



Conducted Emission Plot between 3GHz ~ 7GHz

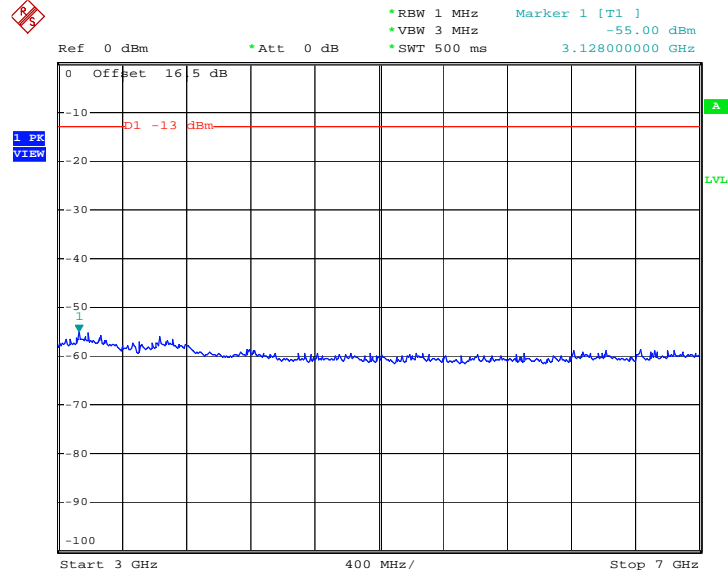

Date: 14.MAY.2009 04:30:11

Conducted Emission Plot between 7GHz ~ 9GHz

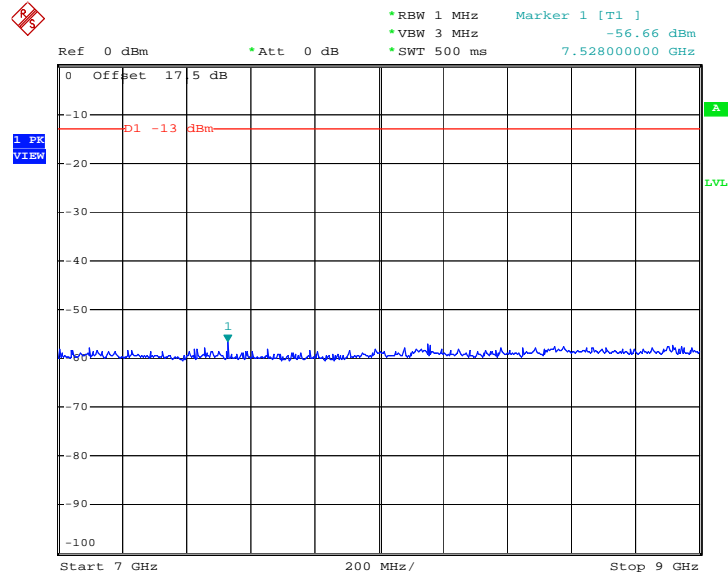

Date: 14.MAY.2009 04:31:26



Band :	GSM1900	Channel :	CH661
Test Mode :	GPRS 8 Link		

Conducted Emission Plot between 30MHz ~ 1GHz

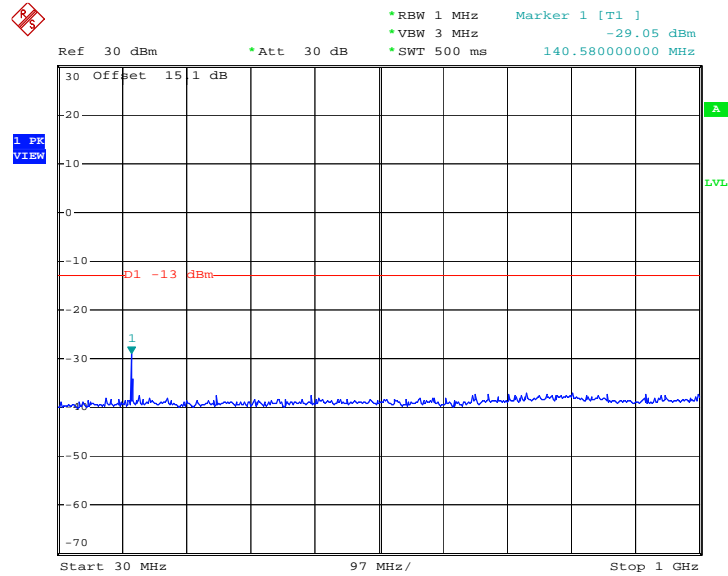

Date: 14.MAY.2009 03:54:25

Conducted Emission Plot between 1GHz ~ 3GHz

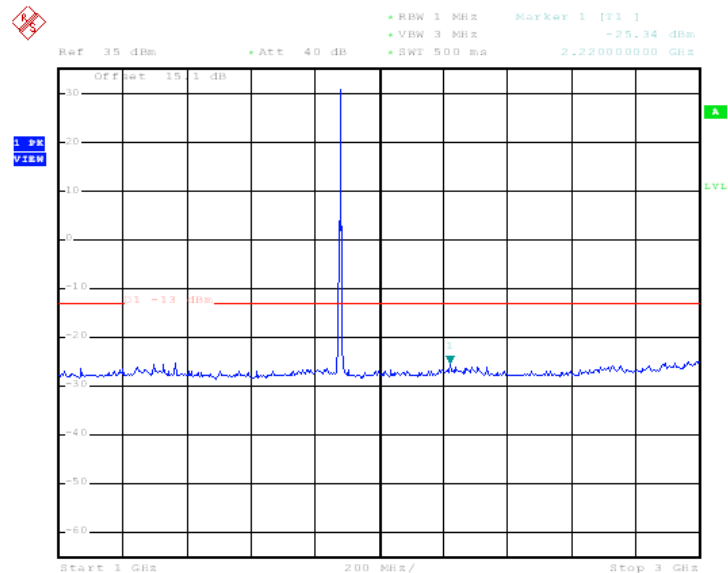

Date: 14.MAY.2009 03:56:48



Conducted Emission Plot between 3GHz ~ 7GHz

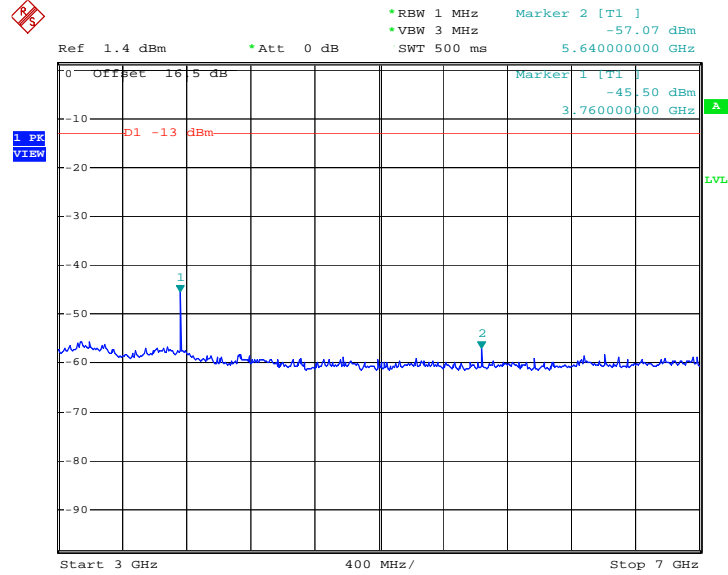

Date: 14.MAY.2009 04:00:17

Conducted Emission Plot between 7GHz ~ 13.6G

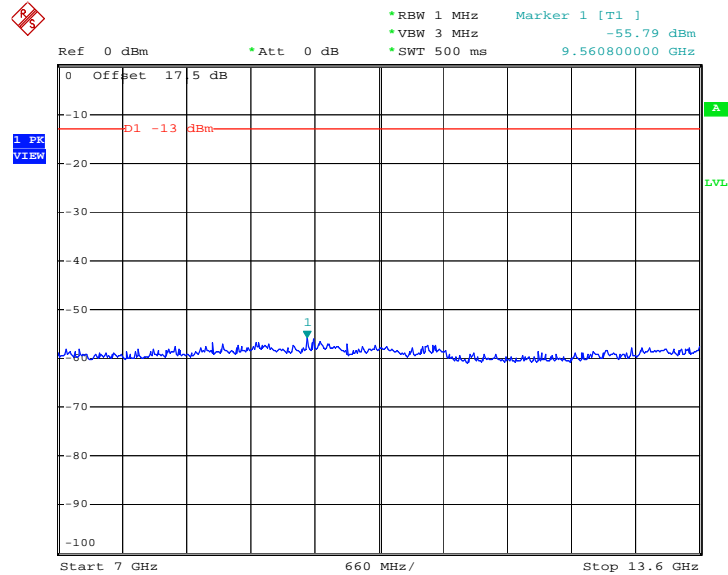

Date: 18.MAY.2009 23:53:34



Conducted Emission Plot between 13.6GHz ~ 19.1GHz

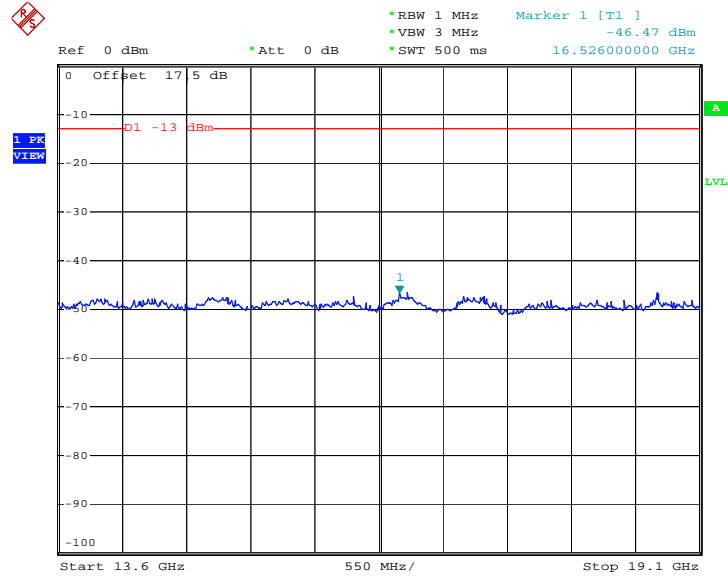

Date: 14.MAY.2009 04:04:12



Band :	GSM1900	Channel :	CH661
Test Mode :	EDGE 8 Link		

Conducted Emission Plot between 30MHz ~ 1GHz

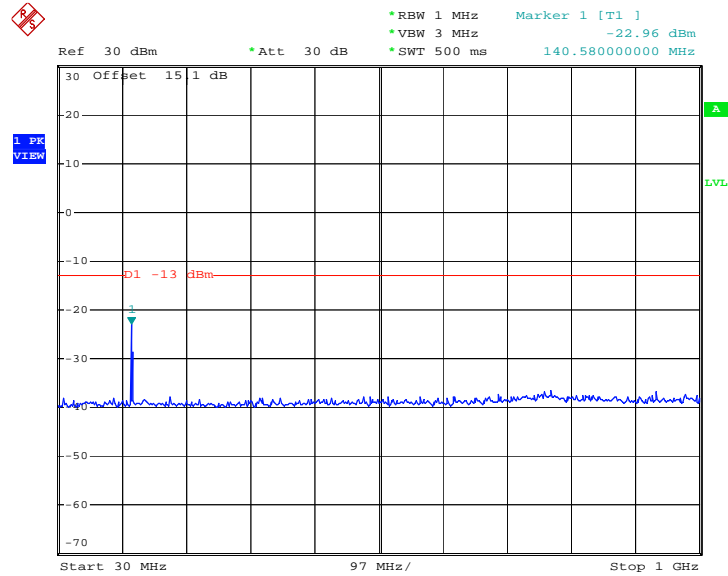

Date: 14.MAY.2009 04:08:45

Conducted Emission Plot between 1GHz ~ 3GHz

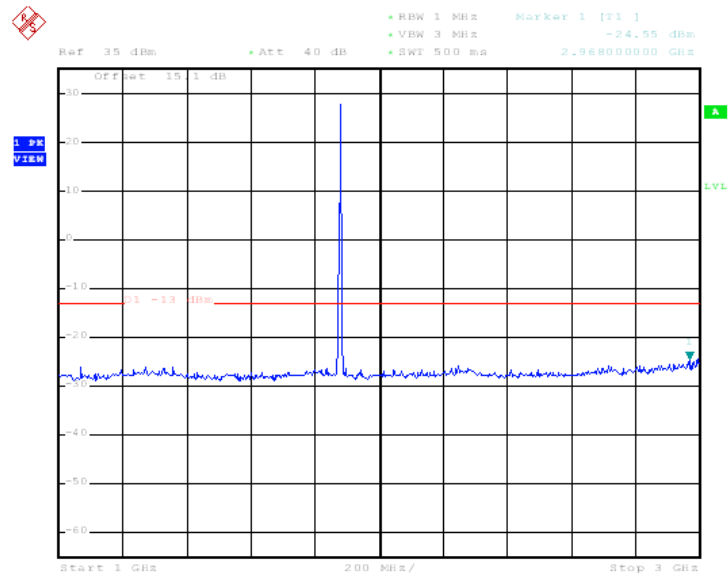

Date: 14.MAY.2009 04:10:23



Conducted Emission Plot between 3GHz ~ 7GHz

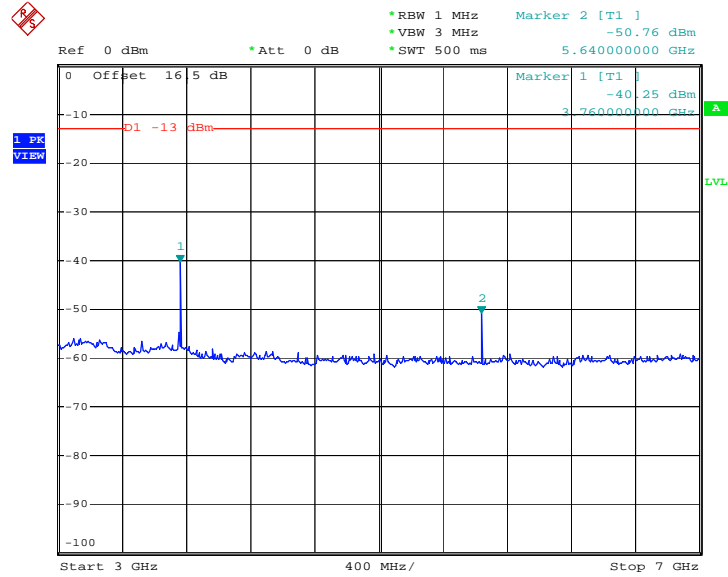

Date: 14.MAY.2009 04:13:27

Conducted Emission Plot between 7GHz ~ 13.6GHz

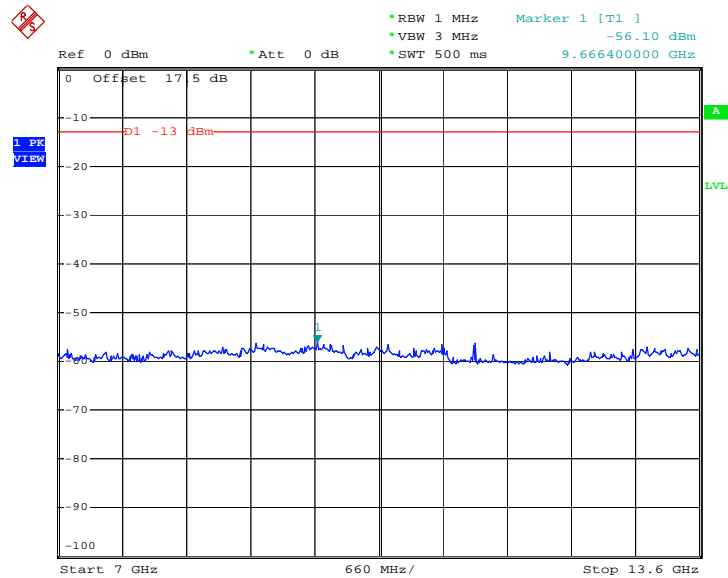

Date: 14.MAY.2009 04:15:55



Conducted Emission Plot between 13.6GHz ~ 19.1GHz

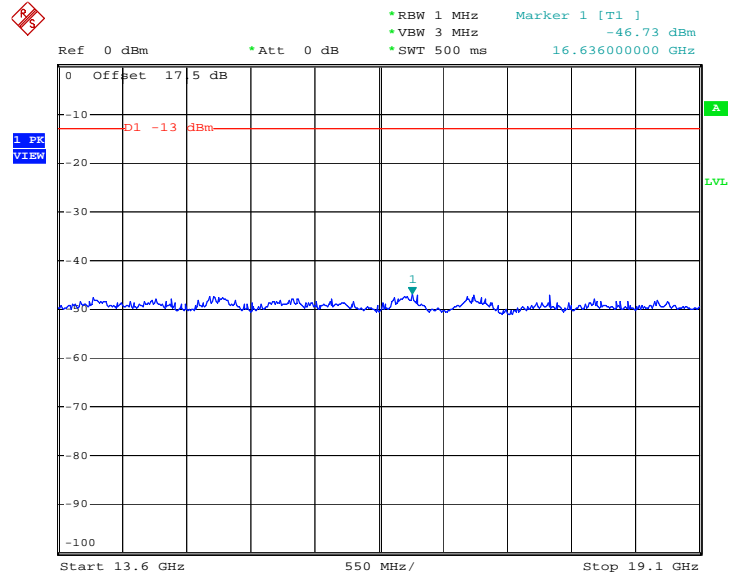

Date: 14.MAY.2009 04:17:09



Band :	WCDMA Band V	Channel :	CH4182
Test Mode :	WCDMA Link		

Conducted Emission Plot between 30MHz ~ 1GHz

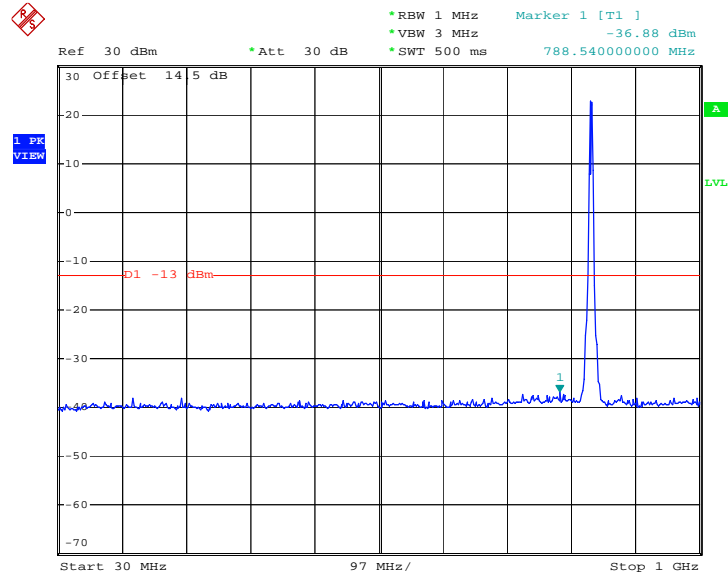

Date: 14.MAY.2009 09:06:18

Conducted Emission Plot between 1GHz ~ 3GHz

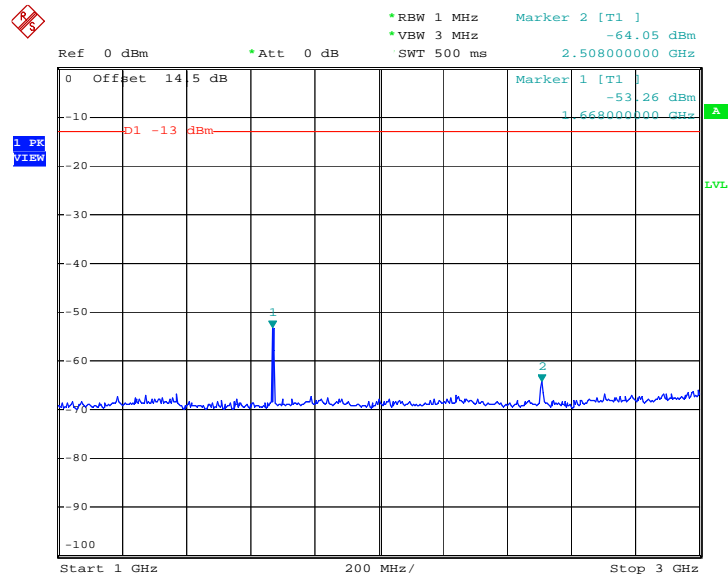

Date: 14.MAY.2009 09:08:03



Conducted Emission Plot between 3GHz ~ 7GHz

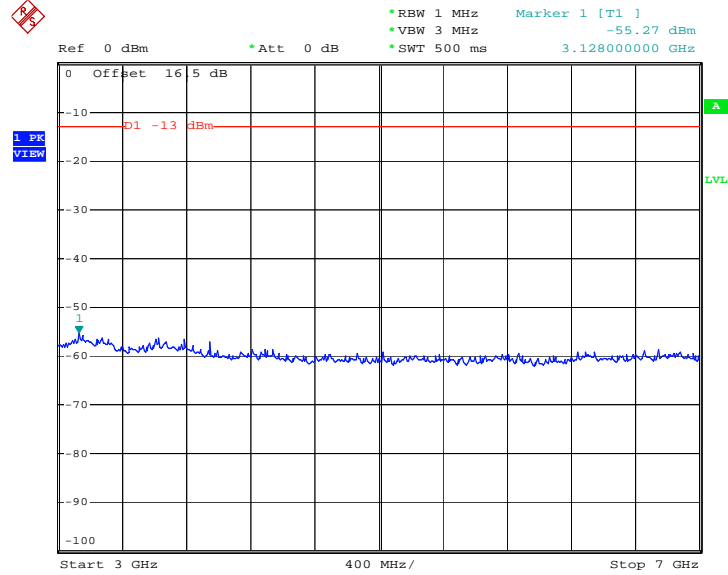

Date: 14.MAY.2009 09:09:09

Conducted Emission Plot between 7GHz ~ 9GHz

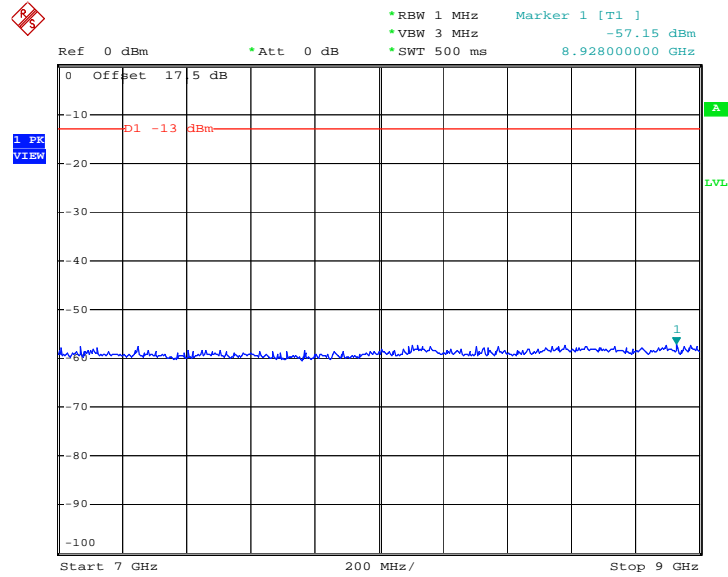

Date: 18.MAY.2009 23:33:19



Band :	WCDMA Band II	Channel :	CH9400
Test Mode :	WCDMA Link		

Conducted Emission Plot between 30MHz ~ 1GHz

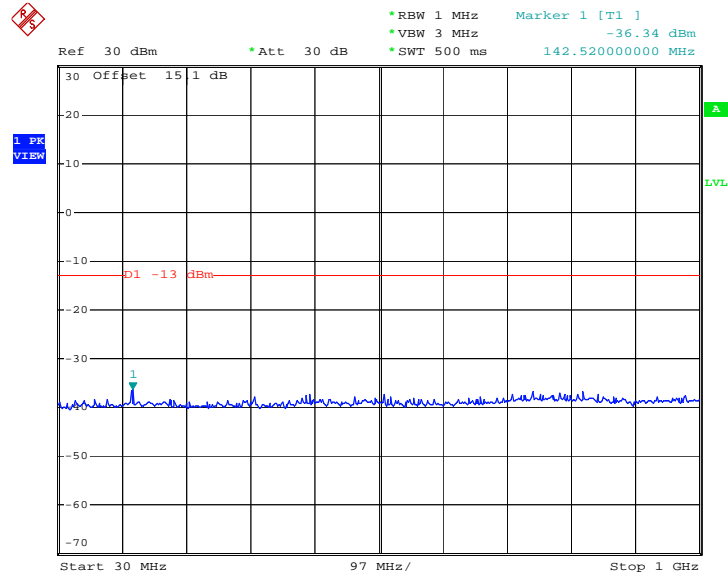

Date: 14.MAY.2009 06:58:12

Conducted Emission Plot between 1GHz ~ 3GHz

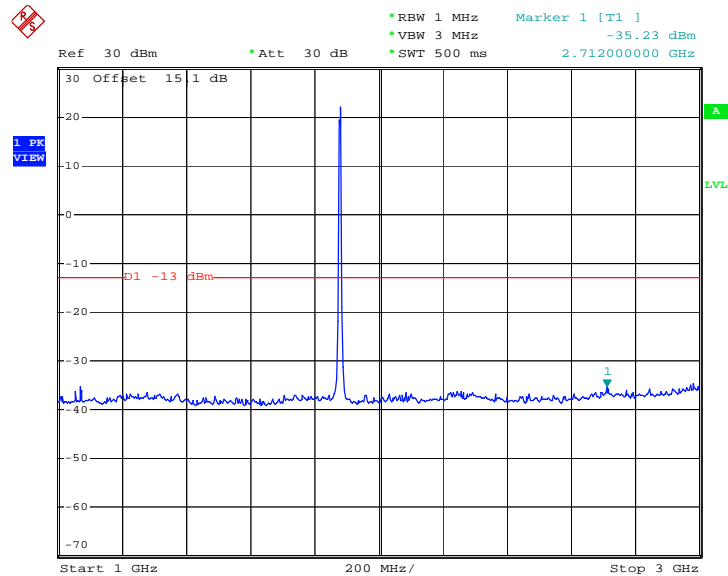

Date: 14.MAY.2009 07:00:07



Conducted Emission Plot between 3GHz ~ 7GHz

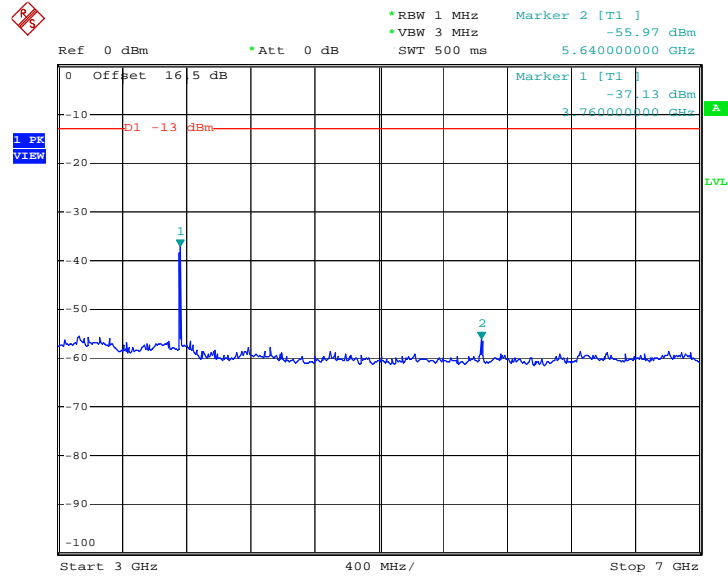

Date: 14.MAY.2009 07:02:45

Conducted Emission Plot between 7GHz ~ 13.6GHz

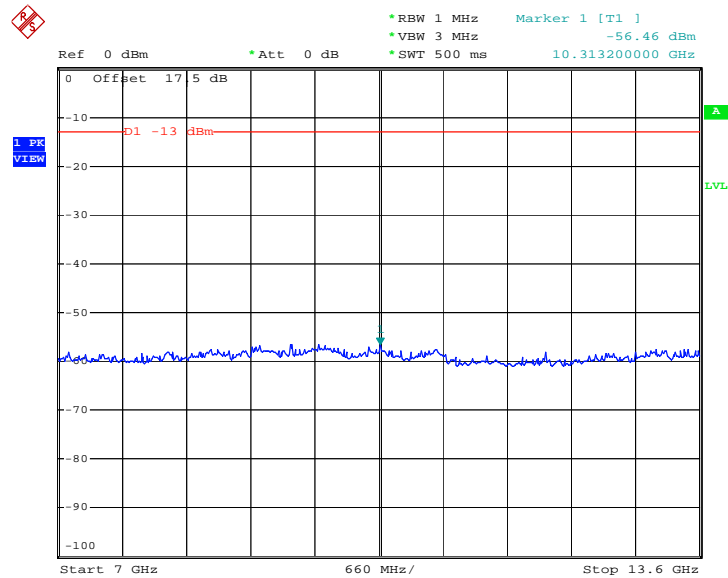

Date: 14.MAY.2009 07:04:42



Conducted Emission Plot between 13.6GHz ~ 19.1GHz

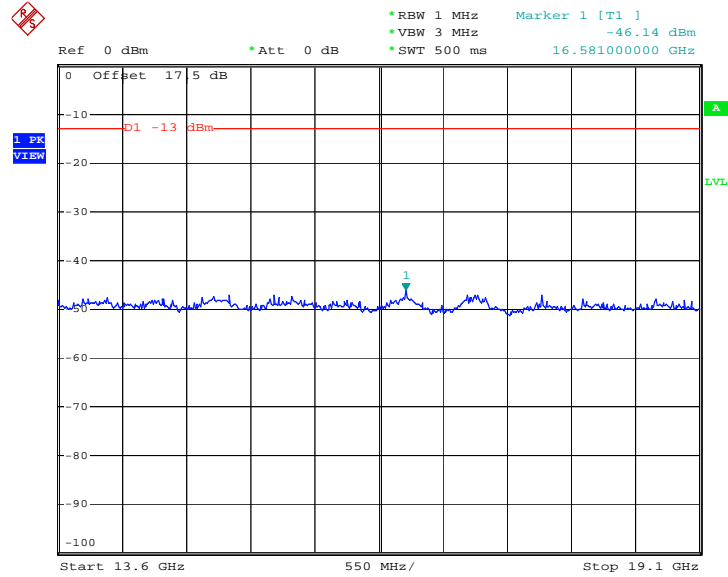

Date: 14.MAY.2009 07:15:12

3.6 Field Strength of Spurious Radiation Measurement

3.6.1 Description of Field Strength of Spurious Radiated Measurement

The radiated spurious emission was measured by substitution method according to ANSI / TIA / EIA-603-C-2004. The power of any emission outside of the authorized operating frequency ranges must be attenuated below the transmitter power (P) by a factor of at least $43 + 10 \log (P)$ dB. The spectrum is scanned from 30 MHz up to a frequency including its 10th harmonic.

3.6.2 Measuring Instruments

See list of measuring instruments of this test report.

3.6.3 Test Procedures

1. The EUT was placed on a rotatable wooden table with 0.8 meter about ground.
2. The EUT was set 3 meters from the receiving antenna, which was mounted on the antenna tower.
3. The table was rotated 360 degrees to determine the position of the highest spurious emission.
4. The height of the receiving antenna is varied between one meter and four meters to search the maximum spurious emission for both horizontal and vertical polarizations.
5. Taking the record of maximum spurious emission.
6. A horn antenna was substituted in place of the EUT and was driven by a signal generator.
7. Tune the output power of signal generator to the same emission level with EUT maximum spurious emission.
8. Taking the record of output power at antenna port.
9. Repeat step 7 to step 8 for another polarization.
10. Emission level (dBm) = output power + substitution Gain.

3.6.4 Test Setup

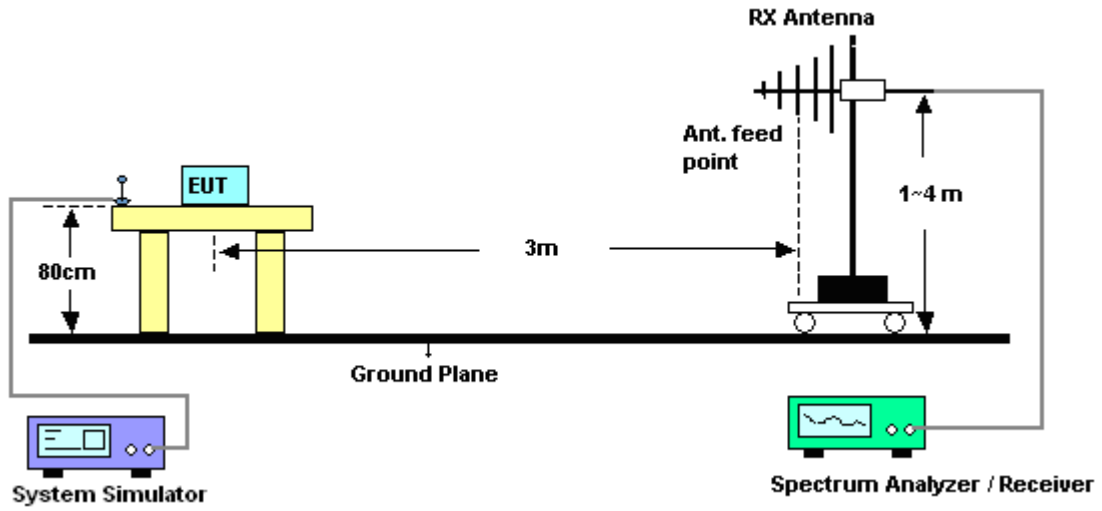



3.6.5 Test Result of Field Strength of Spurious Radiated

Band :	GSM850	Temperature :	22~24°C
Test Mode :	GPRS 8 Link	Relative Humidity :	45~49%
Test Engineer :	Rain Zhou	Polarization :	Horizontal
Remark :	Spurious emissions within 30-1000MHz were found more than 20dB below limit line.		

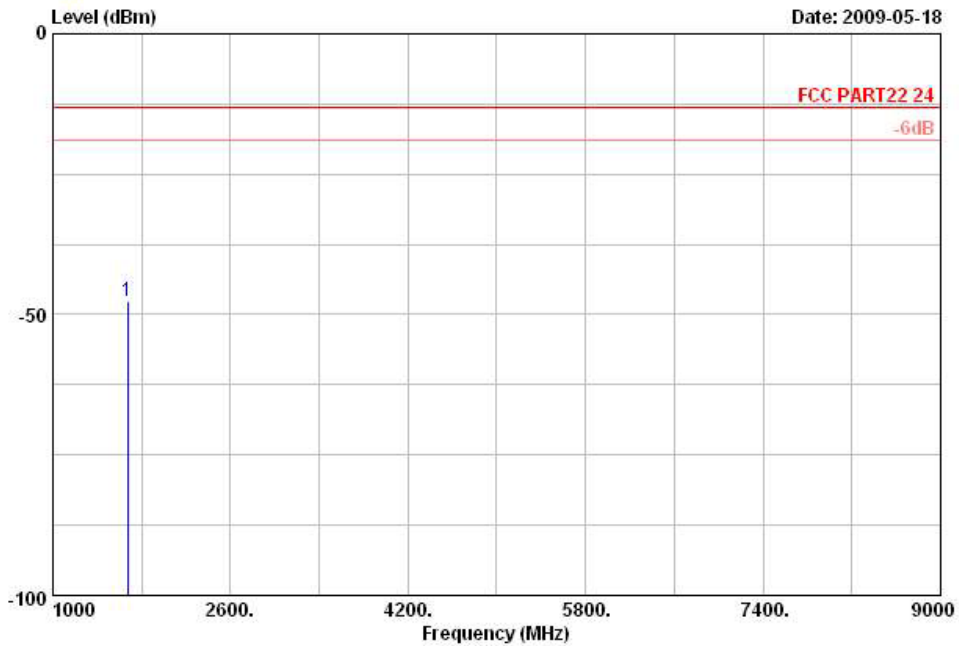

Site : 03CH01-KS
 Condition: FCC PART22 24 HF EIRP FACTOR-09020 HORIZONTAL
 Power : 3.8Vdc
 Mode : Mode 1

Frequency (MHz)	ERP (dBm)	Limit (dBm)	Over Limit (dB)	SPA Reading (dBm)	S.G. Power (dBm)	TX Cable loss (dB)	TX Antenna Gain (dBi)	Polarization (H/V)	Result
1674	-47.54	-13	-34.54	-55.34	-50.75	0.69	6.05	H	Pass



Band :	GSM850	Temperature :	22~24°C
Test Mode :	GPRS 8 Link	Relative Humidity :	45~49%
Test Engineer :	Rain Zhou	Polarization :	Vertical
Remark :	Spurious emissions within 30-1000MHz were found more than 20dB below limit line.		

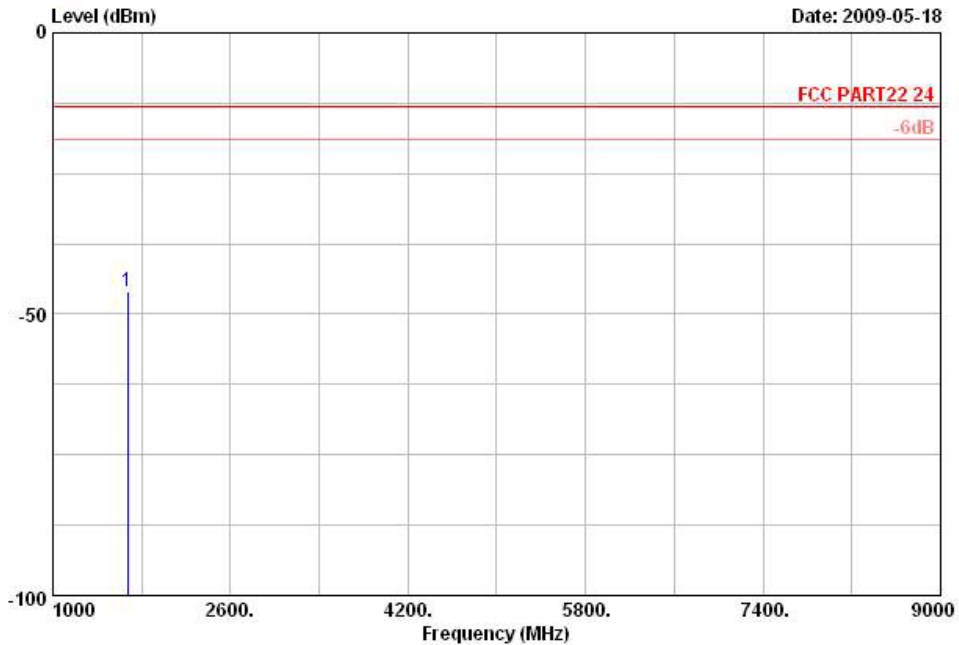

Site : 03CH01-KS
 Condition: FCC PART22 24 HF EIRP FACTOR-09020 VERTICAL
 Power : 3.8Wdc
 Mode : Mode 1

Frequency (MHz)	ERP (dBm)	Limit (dBm)	Over Limit (dB)	SPA Reading (dBm)	S.G. Power (dBm)	TX Cable loss (dB)	TX Antenna Gain (dBi)	Polarization (H/V)	Result
1674	-45.92	-13	-32.92	-53.72	-49.13	0.69	6.05	V	Pass



Band :	GSM850	Temperature :	22~24°C
Test Mode :	EDGE 8 Link	Relative Humidity :	45~49%
Test Engineer :	Rain Zhou	Polarization :	Horizontal
Remark :	Spurious emissions within 30-1000MHz were found more than 20dB below limit line.		

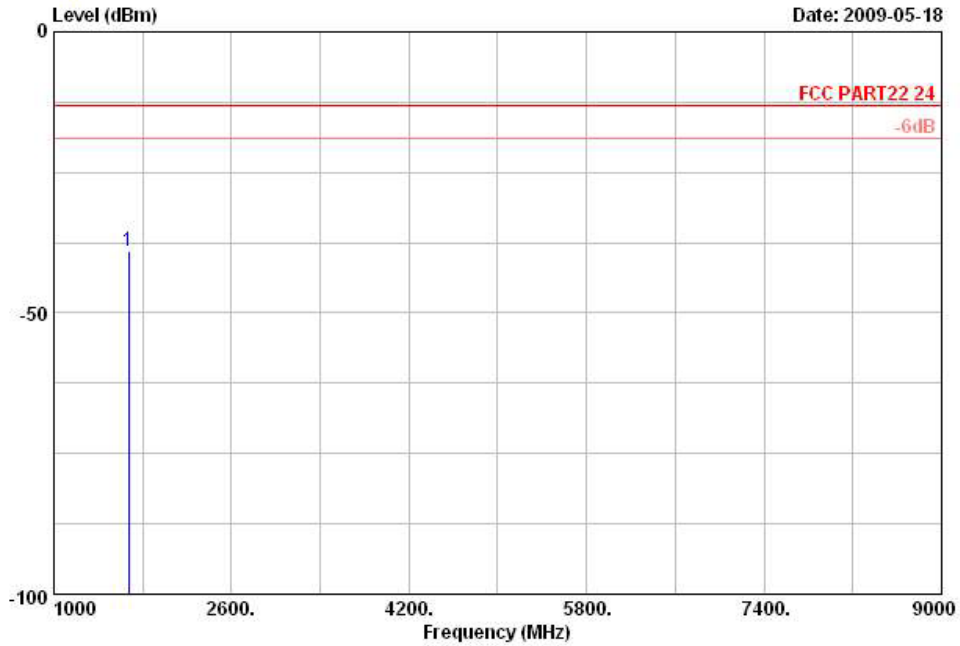

Site : 03CH01-K5
 Condition: FCC PART22 24 HF EIRP FACTOR-09020 HORIZONTAL
 Power : 3.8Wdc
 Mode : Mode 2

Frequency (MHz)	ERP (dBm)	Limit (dBm)	Over Limit (dB)	SPA Reading (dBm)	S.G. Power (dBm)	TX Cable loss (dB)	TX Antenna Gain (dBi)	Polarization (H/V)	Result
1674	-38.95	-13	-25.95	-46.75	-42.16	0.69	6.05	H	Pass



Band :	GSM850	Temperature :	22~24°C
Test Mode :	EDGE 8 Link	Relative Humidity :	45~49%
Test Engineer :	Rain Zhou	Polarization :	Vertical
Remark :	Spurious emissions within 30-1000MHz were found more than 20dB below limit line.		

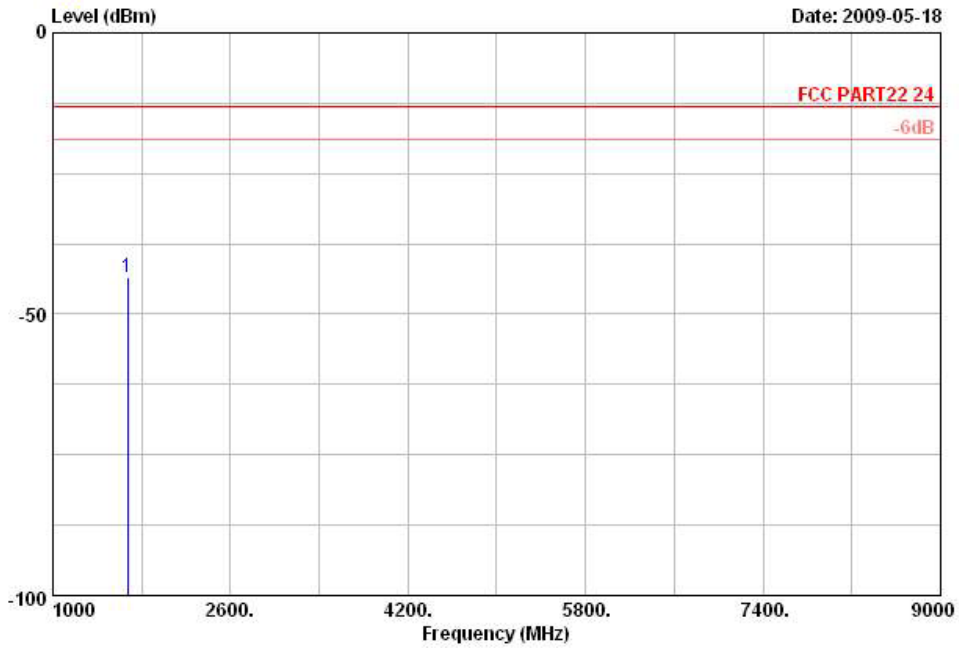

Site : 03CH01-KS
 Condition: FCC PART22 24 HF EIRP FACTOR-09020 VERTICAL
 Power : 3.8Wdc
 Mode : Mode 2

Frequency (MHz)	ERP (dBm)	Limit (dBm)	Over Limit (dB)	SPA Reading (dBm)	S.G. Power (dBm)	TX Cable loss (dB)	TX Antenna Gain (dBi)	Polarization (H/V)	Result
1672	-43.40	-13	-30.40	-51.20	-46.61	0.69	6.05	V	Pass



Band :	GSM1900	Temperature :	22~24°C
Test Mode :	GPRS 8 Link	Relative Humidity :	45~49%
Test Engineer :	Rain Zhou	Polarization :	Horizontal
Remark :	Spurious emissions within 30-1000MHz were found more than 20dB below limit line.		

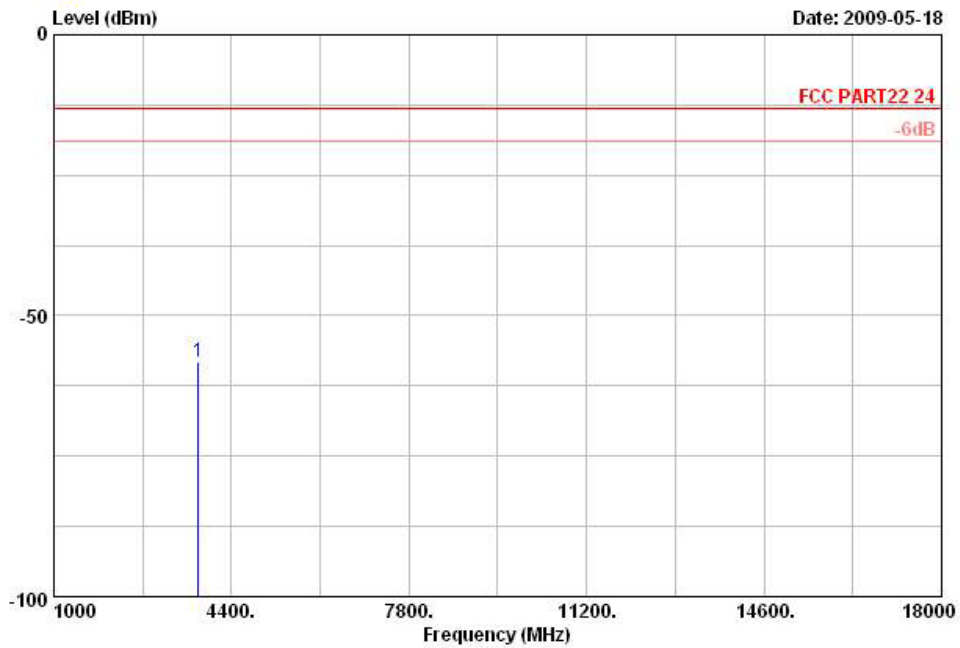

Site : 03CH01-KS
 Condition: FCC PART22 24 HF EIRP FACTOR-09020 HORIZONTAL
 Power : 3.8Vdc
 Mode : Mode 1

Frequency (MHz)	EIRP (dBm)	Limit (dBm)	Over Limit (dB)	SPA Reading (dBm)	S.G. Power (dBm)	TX Cable loss (dB)	TX Antenna Gain (dBi)	Polarization (H/V)	Result
3760	-58.11	-13	-45.11	-71.82	-66.04	0.11	8.04	H	Pass



Band :	GSM1900	Temperature :	22~24°C
Test Mode :	GPRS 8 Link	Relative Humidity :	45~49%
Test Engineer :	Rain Zhou	Polarization :	Vertical
Remark :	Spurious emissions within 30-1000MHz were found more than 20dB below limit line.		

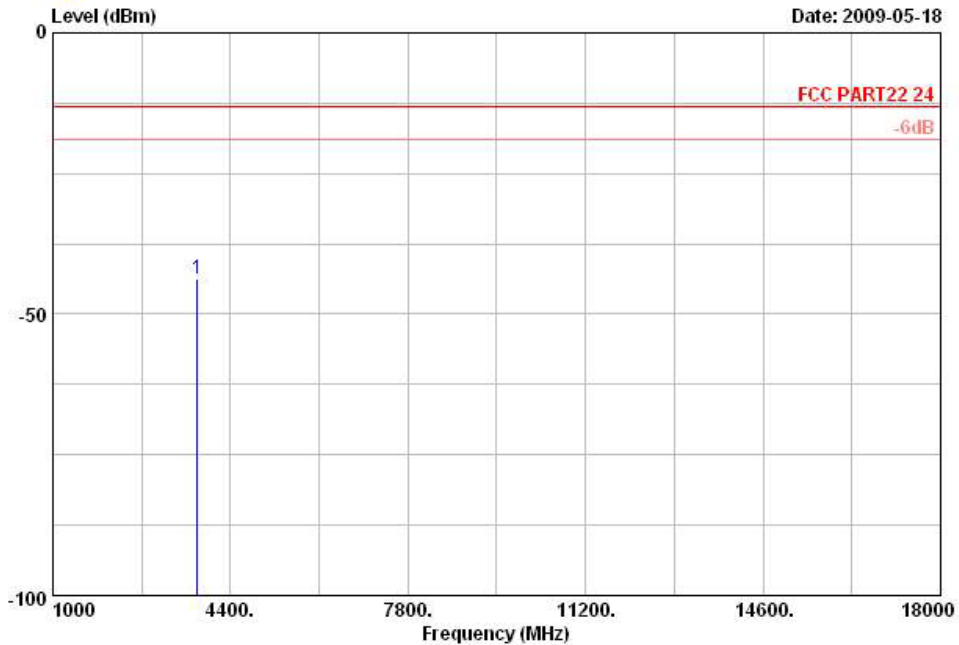

Site : 03CH01-KS
 Condition: FCC PART22 24 HF EIRP FACTOR-09020 VERTICAL
 Power : 3.8Wdc
 Mode : Mode 1

Frequency (MHz)	EIRP (dBm)	Limit (dBm)	Over Limit (dB)	SPA Reading (dBm)	S.G. Power (dBm)	TX Cable loss (dB)	TX Antenna Gain (dBi)	Polarization (H/V)	Result
3760	-43.67	-13	-30.67	-57.38	-51.60	0.11	8.04	V	Pass



Band :	GSM1900	Temperature :	22~24°C
Test Mode :	EDGE 8 Link	Relative Humidity :	45~49%
Test Engineer :	Rain Zhou	Polarization :	Horizontal
Remark :	Spurious emissions within 30-1000MHz were found more than 20dB below limit line.		

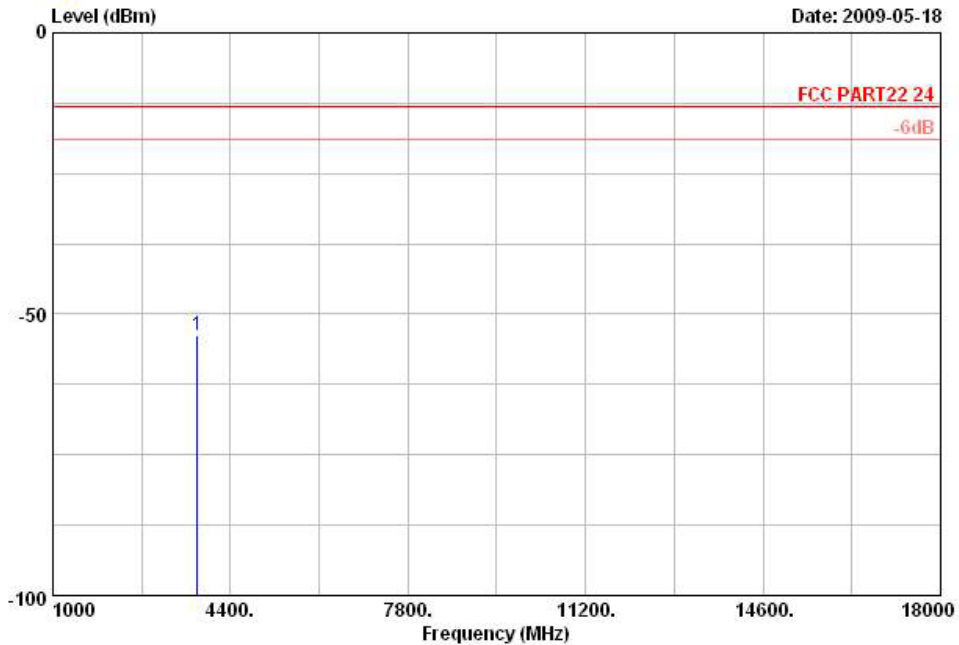

Site : 03CH01-KS
 Condition: FCC PART22 24 HF EIRP FACTOR-09020 HORIZONTAL
 Power : 3.8Wdc
 Mode : Mode 2

Frequency (MHz)	EIRP (dBm)	Limit (dBm)	Over Limit (dB)	SPA Reading (dBm)	S.G. Power (dBm)	TX Cable loss (dB)	TX Antenna Gain (dBi)	Polarization (H/V)	Result
3760	-53.67	-13	-40.67	-67.38	-61.60	0.11	8.04	H	Pass



Band :	GSM1900	Temperature :	22~24°C
Test Mode :	EDGE 8 Link	Relative Humidity :	45~49%
Test Engineer :	Rain Zhou	Polarization :	Vertical
Remark :	Spurious emissions within 30-1000MHz were found more than 20dB below limit line.		

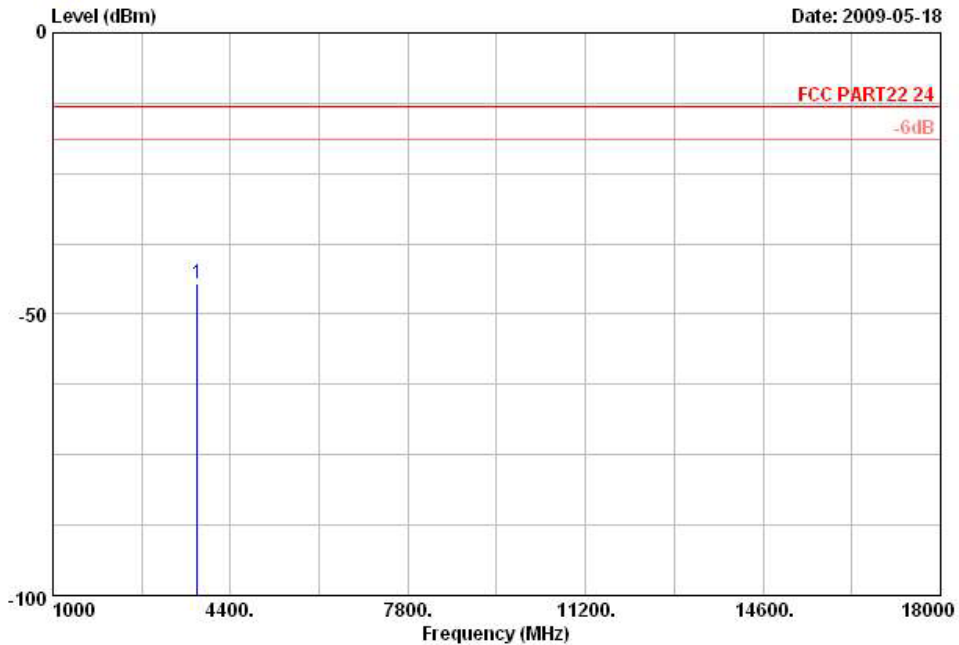

Site : 03CH01-KS
 Condition: FCC PART22 24 HF EIRP FACTOR-09020 VERTICAL
 Power : 3.8Wdc
 Mode : Mode 2

Frequency (MHz)	EIRP (dBm)	Limit (dBm)	Over Limit (dB)	SPA Reading (dBm)	S.G. Power (dBm)	TX Cable loss (dB)	TX Antenna Gain (dBi)	Polarization (H/V)	Result
3760	-44.48	-13	-31.48	-58.19	-52.41	0.11	8.04	V	Pass



Band :	WCDMA Band V	Temperature :	22~24°C
Test Mode :	WCDMA Link	Relative Humidity :	45~49%
Test Engineer :	Rain Zhou	Polarization :	Horizontal
Remark :	Spurious emissions within 30-1000MHz were found more than 20dB below limit line.		

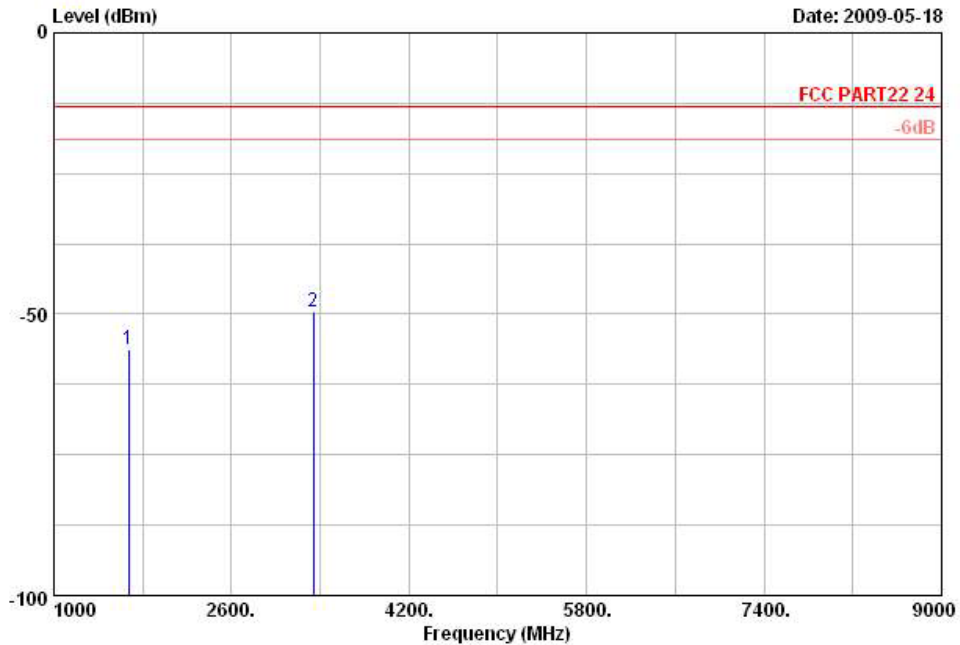

Site : 03CH01-KS
 Condition: FCC PART22 24 HF EIRP FACTOR-09020 HORIZONTAL
 Power : 3.8Wdc
 Mode : Mode 3

Frequency (MHz)	ERP (dBm)	Limit (dBm)	Over Limit (dB)	SPA Reading (dBm)	S.G. Power (dBm)	TX Cable loss (dB)	TX Antenna Gain (dBi)	Polarization (H/V)	Result
1672	-56.24	-13	-43.24	-64.04	-59.45	0.69	6.05	H	Pass
3340	-49.52	-13	-36.52	-60.46	-54.18	0.99	7.80	H	Pass



Band :	WCDMA Band V	Temperature :	22~24°C
Test Mode :	WCDMA Link	Relative Humidity :	45~49%
Test Engineer :	Rain Zhou	Polarization :	Vertical
Remark :	Spurious emissions within 30-1000MHz were found more than 20dB below limit line.		

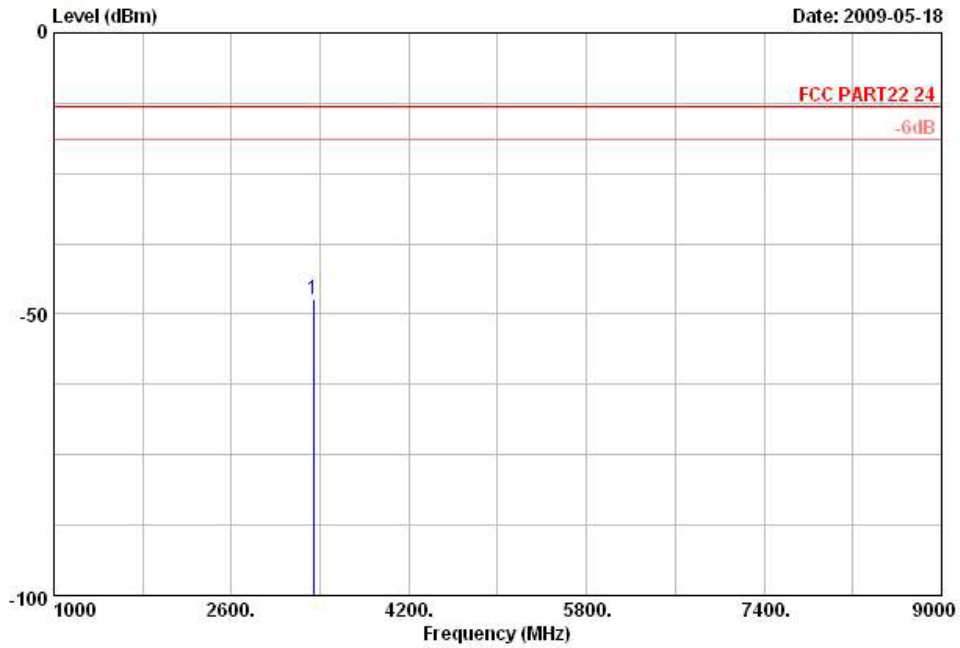

Site : 03CH01-KS
 Condition: FCC PART22 24 HF EIRP FACTOR-09020 VERTICAL
 Power : 3.8Wdc
 Mode : Mode 3

Frequency (MHz)	ERP (dBm)	Limit (dBm)	Over Limit (dB)	SPA Reading (dBm)	S.G. Power (dBm)	TX Cable loss (dB)	TX Antenna Gain (dBi)	Polarization (H/V)	Result
3342	-47.40	-13	-34.40	-58.34	-52.06	0.99	7.80	V	Pass



Band :	WCDMA Band II	Temperature :	22~24°C
Test Mode :	WCDMA Link	Relative Humidity :	45~49%
Test Engineer :	Rain Zhou	Polarization :	Horizontal
Remark :	Spurious emissions within 30-1000MHz were found more than 20dB below limit line.		

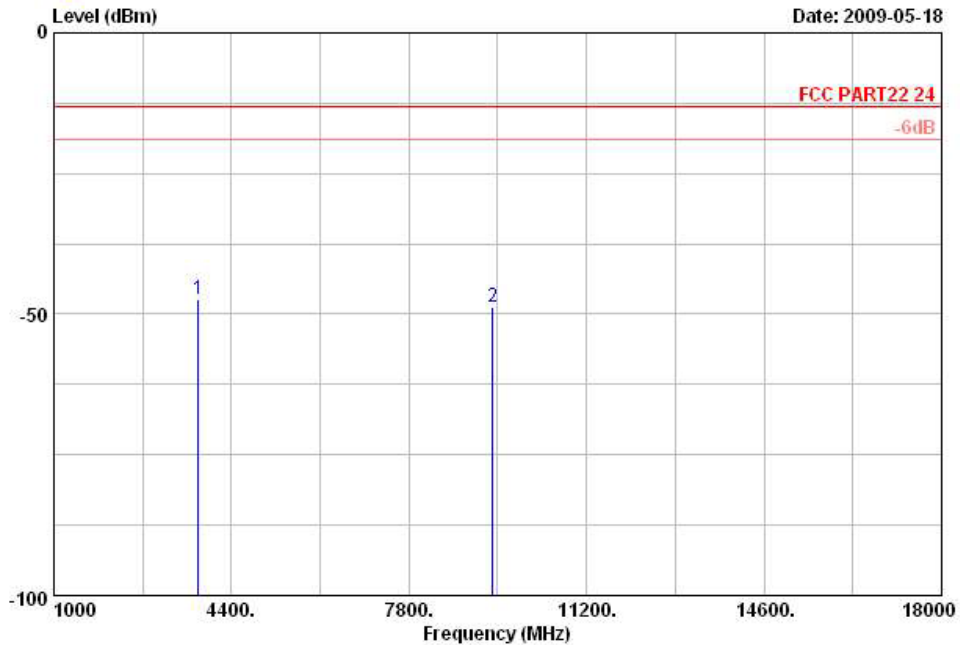

Site : 03CH01-KS
 Condition: FCC PART22 24 HF EIRP FACTOR-09020 HORIZONTAL
 Power : 3.8Wdc
 Mode : Mode 3

Frequency (MHz)	EIRP (dBm)	Limit (dBm)	Over Limit (dB)	SPA Reading (dBm)	S.G. Power (dBm)	TX Cable loss (dB)	TX Antenna Gain (dBi)	Polarization (H/V)	Result
3762	-47.35	-13	-34.35	-61.06	-55.28	0.11	8.04	H	Pass
9404	-48.77	-13	-35.77	-68.34	-60.18	1.55	12.96	H	Pass



Band :	WCDMA Band II	Temperature :	22~24°C
Test Mode :	WCDMA Link	Relative Humidity :	45~49%
Test Engineer :	Rain Zhou	Polarization :	Vertical
Remark :	Spurious emissions within 30-1000MHz were found more than 20dB below limit line.		

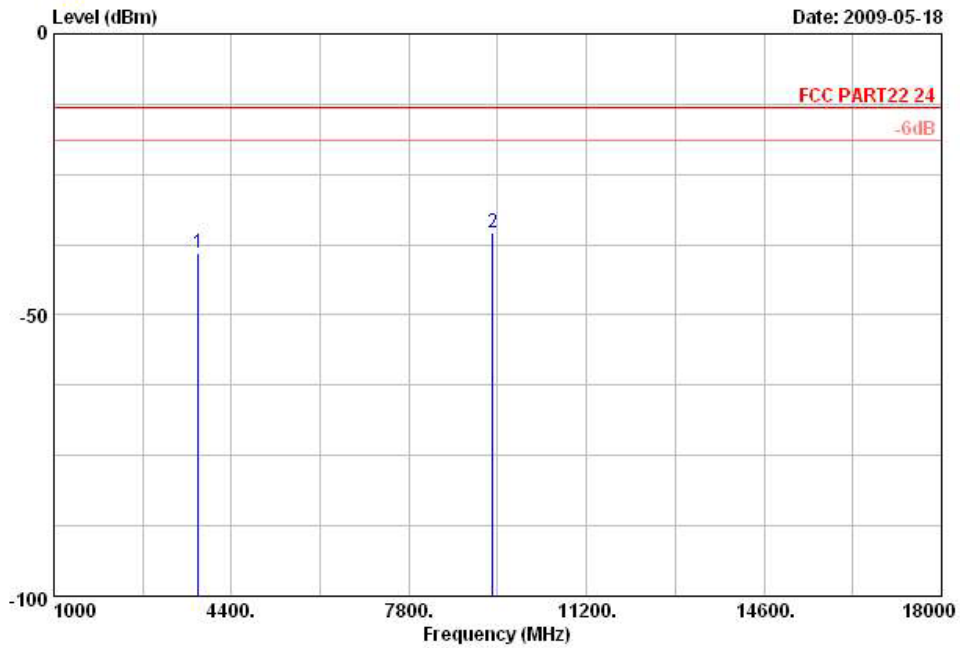

Site : 03CH01-K5
 Condition: FCC PART22 24 HF EIRP FACTOR-09020 VERTICAL
 Power : 3.8Wdc
 Mode : Mode 3

Frequency (MHz)	EIRP (dBm)	Limit (dBm)	Over Limit (dB)	SPA Reading (dBm)	S.G. Power (dBm)	TX Cable loss (dB)	TX Antenna Gain (dBi)	Polarization (H/V)	Result
3760	-39.07	-13	-26.07	-52.78	-47.00	0.11	8.04	V	Pass
9398	-35.44	-13	-22.44	-55.01	-46.85	1.55	12.96	V	Pass

3.7 Frequency Stability Measurement

3.7.1 Description of Frequency Stability Measurement

The frequency stability shall be measured by variation of ambient temperature and variation of primary supply voltage to ensure that the fundamental emission stays within the authorized frequency block. The frequency stability of the transmitter shall be maintained within $\pm 0.00025\%$ ($\pm 2.5\text{ppm}$) of the center frequency.

3.7.2 Measuring Instruments

See list of measuring instruments of this test report.

3.7.3 Test Procedures for Temperature Variation

1. The EUT was set up in the thermal chamber and connected with the base station.
2. With power OFF, the temperature was decreased to -30°C and the EUT was stabilized for three hours. Power was applied and the maximum change in frequency was recorded within one minute.
3. With power OFF, the temperature was raised in 10°C step up to 50°C . The EUT was stabilized at each step for at least half an hour. Power was applied and the maximum frequency change was recorded within one minute.
4. If the EUT can not be turned on at -30°C , the testing lowest temperature will be raised in 10°C step until the EUT can be turned on.

3.7.4 Test Procedures for Voltage Variation

1. The EUT was placed in a temperature chamber at $25\pm 5^{\circ}\text{C}$ and connected with the base station.
2. The power supply voltage to the EUT was varied from BEP to 115% of the nominal value measured at the input to the EUT.
3. The variation in frequency was measured for the worst case.

3.7.5 Test Setup

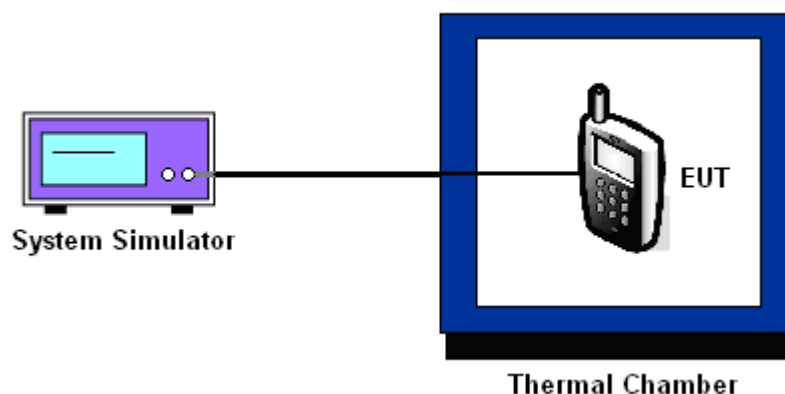



3.7.6 Test Result of Temperature Variation

Band :	GSM 850	Channel :	189
Limit (ppm) :	2.5		

Temperature (°C)	GPRS 8		EDGE 8		Result
	Freq. Dev. (Hz)	Deviation (ppm)	Freq. Dev. (Hz)	Deviation (ppm)	
-30	47	0.06	45	0.05	PASS
-20	-54	-0.06	-60	-0.07	
-10	25	0.03	31	0.04	
0	-54	-0.06	-58	-0.07	
10	32	0.04	41	0.05	
20	33	0.04	37	0.04	
30	-28	-0.03	25	0.03	
40	-64	-0.08	-65	-0.08	
50	-67	-0.08	-69	-0.08	

Band :	GSM 1900	Channel :	661
Limit (ppm) :	2.5		

Temperature (°C)	GPRS 8		EDGE 8		Result
	Freq. Dev. (Hz)	Deviation (ppm)	Freq. Dev. (Hz)	Deviation (ppm)	
-30	-30	-0.02	-48	-0.03	PASS
-20	41	0.02	58	0.03	
-10	-66	-0.03	-80	-0.04	
0	37	0.02	51	0.03	
10	34	0.02	50	0.03	
20	-47	-0.02	49	0.03	
30	-87	-0.05	-96	-0.05	
40	-88	-0.05	-93	-0.05	
50	-82	-0.04	-96	-0.05	



Band :	WCDMA Band V	Channel :	4182
Limit (ppm) :	2.5		

Temperature (°C)	WCDMA		Result
	Freq. Dev. (Hz)	Deviation (ppm)	
-30	16	0.02	PASS
-20	-14	-0.02	
-10	-25	-0.03	
0	21	0.02	
10	18	0.02	
20	-19	-0.02	
30	-17	-0.02	
40	-18	-0.02	
50	-21	-0.02	

Band :	WCDMA Band II	Channel :	9400
Limit (ppm) :	2.5		

Temperature (°C)	WCDMA		Result
	Freq. Dev. (Hz)	Deviation (ppm)	
-30	-37	-0.02	PASS
-20	36	0.02	
-10	26	0.01	
0	38	0.02	
10	-30	-0.02	
20	-35	-0.02	
30	-39	-0.02	
40	38	0.02	
50	37	0.02	



3.7.7 Test Result of Voltage Variation

Band & Channel	Mode	Voltage (Volt)	Freq. Dev. (Hz)	Deviation (ppm)	Limit (ppm)	Result
GSM 850 CH189	GPRS 8	3.8	-50	-0.06	2.5	PASS
		3.2	-34	-0.04		
		4.4	-55	-0.06		
	EDGE 8	3.8	-52	-0.06		
		3.2	-40	-0.05		
		4.4	-57	-0.07		
GSM 1900 CH661	GPRS 8	3.8	-73	-0.04		
		3.2	-83	-0.04		
		4.4	-87	-0.05		
	EDGE 8	3.8	-90	-0.05		
		3.2	-88	-0.05		
		4.4	-96	-0.05		
WCDMA Band V CH4182	WCDMA	3.8	-18	-0.02		
		3.2	-15	-0.02		
		4.4	14	0.02		
WCDMA Band II CH9400	WCDMA	3.8	-34	-0.02		
		3.2	33	0.02		
		4.4	-38	-0.02		

Note: Normal Voltage = 3.8V.



4 List of Measuring Equipment

Instrument	Manufacturer	Model No.	Serial No.	Characteristics	Calibration Date	Due Date	Remark
Spectrum Analyzer	R&S	FSP40	100319	9kHz~40GHz	Dec. 08, 2008	Dec. 07, 2009	Conducted (TH01-KS)
Thermal Chamber	Ten Billion	TTC-B3S	TBN-930701	N/A	Dec. 15, 2008	Dec. 14, 2009	Conducted (TH01-KS)
Spectrum Analyzer	R&S	ESCI	100534	9kHz – 2.75GHz	Dec. 08, 2008	Dec. 07, 2009	Radiation (03CH01-KS)
Spectrum Analyzer	R&S	FSP40	100319	9kHz~40GHz	Dec. 08, 2008	Dec. 07, 2009	Radiation (03CH01-KS)
Bilog Antenna	SCHAFFNER	CBL6112D	23182	25MHz~2GHz	Dec. 17, 2008	Dec. 16, 2009	Radiation (03CH01-KS)
Double Ridge Horn Antenna	EMCO	3117	75959	1GHz~18GHz	Dec. 17, 2008	Dec. 16, 2009	Radiation (03CH01-KS)
Amplifier	Wireless	FPA6592G	600006	30MHz~2GHz	Dec. 17, 2008	Dec. 16, 2009	Radiation (03CH01-KS)
Amplifier	Agilent	8449B	3008A02370	1GHz~26.5GHz	Dec. 17, 2008	Dec. 16, 2009	Radiation (03CH01-KS)
Signal Generator	R&S	SMR40	100455	10MHz~40GHz	Aug. 29, 2007	Aug. 28, 2009	Radiation (03CH01-KS)
System Simulator	R&S	CMU200	837587/066	Full-Band/BT	Jan. 08, 2009	Jan. 07, 2011	Radiation (03CH01-KS)

5 Uncertainty of Evaluation

Uncertainty of Radiated Emission Measurement (30 MHz ~ 1000 MHz)

Contribution	Uncertainty of x_i		$u(x_i)$
	dB	Probability Distribution	
Receiver reading	0.41	Normal(k=2)	0.21
Antenna factor calibration	0.83	Normal(k=2)	0.42
Cable loss calibration	0.25	Normal(k=2)	0.13
Pre Amplifier Gain calibration	0.27	Normal(k=2)	0.14
RCV/SPA specification	2.50	Rectangular	0.72
Antenna Factor Interpolation for Frequency	1.00	Rectangular	0.29
Site imperfection	1.43	Rectangular	0.83
Mismatch	+0.39/-0.41	U-shaped	0.28
Combined standard uncertainty Uc(y)	1.27		
Measuring uncertainty for a level of confidence of 95% U=2Uc(y)	2.54		

Uncertainty of Radiated Emission Measurement (1 GHz ~ 40 GHz)

Contribution	Uncertainty of x_i		$u(x_i)$	C_i	$C_i * u(x_i)$
	dB	Probability Distribution			
Receiver reading	±0.10	Normal(k=1)	0.10	1	0.10
Antenna factor calibration	±1.70	Normal(k=2)	0.85	1	0.85
Cable loss calibration	±0.50	Normal(k=2)	0.25	1	0.25
Receiver Correction	±2.00	Rectangular	1.15	1	1.15
Antenna Factor Directional	±1.50	Rectangular	0.87	1	0.87
Site imperfection	±2.80	Triangular	1.14	1	1.14
Mismatch Receiver VSWR $\Gamma_1 = 0.197$ Antenna VSWR $\Gamma_2 = 0.194$ Uncertainty = $20 \log(1 - \Gamma_1 * \Gamma_2)$	+0.34/-0.35	U-shaped	0.244	1	0.244
Combined standard uncertainty Uc(y)	2.36				
Measuring uncertainty for a level of confidence of 95% U=2Uc(y)	4.72				

6 Certification of TAF Accreditation



Certificate No. : L1190-090417

財團法人全國認證基金會
Taiwan Accreditation Foundation

Certificate of Accreditation

This is to certify that

Sporton International Inc.
EMC & Wireless Communications Laboratory
No.52, Hwa Ya 1st Rd., Hwa Ya Technology Park, Kwei-Shan Hsiang, Tao Yuan Hsien,
Taiwan, R.O.C.

is accredited in respect of laboratory

Accreditation Criteria	: ISO/IEC 17025:2005
Accreditation Number	: 1190
Originally Accredited	: December 15, 2003
Effective Period	: January 10, 2007 to January 09, 2010
Accredited Scope	: Testing Field, see described in the Appendix
Specific Accreditation Program	: Accreditation Program for Designated Testing Laboratory for Commodities Inspection Accreditation Program for Telecommunication Equipment Testing Laboratory Accreditation Program for BSMI Mutual Recognition Arrangement with Foreign Authorities

Jay-San Chen
President, Taiwan Accreditation Foundation
Date : April 17, 2009

P1, total 20 pages

The Appendix forms an integral part of this Certificate, which shall be invalid when use without the Appendix



Appendix A. Photographs of EUT

Please refer to Sporton report number EP951602 as below.