

FCC TEST REPORT

REPORT NO.: RF970707H01

MODEL NO.: 8520-00145

RECEIVED: July 07, 2008

TESTED: July 07 to 29, 2008

ISSUED: Aug. 18, 2008

APPLICANT: Socket Mobile, Inc.

ADDRESS: 39700 Eureka Drive Newark, CA 94560-4808
USA

ISSUED BY: Advance Data Technology Corporation

LAB LOCATION: No. 81-1, Lu Liao Keng, 9 Ling, Wu Lung Tsuen,
Chiung Lin Hsiang, Hsin Chu Hsien,
Taiwan, R.O.C.

This test report consists of 67 pages in total. It may be duplicated completely for legal use with the approval of the applicant. It should not be reproduced except in full, without the written approval of our laboratory. The client should not use it to claim product endorsement by TAF or any government agencies. The test results in the report only apply to the tested sample.



TABLE OF CONTENTS

1	CERTIFICATION	4
2	SUMMARY OF TEST RESULTS.....	5
2.1	MEASUREMENT UNCERTAINTY	6
3	GENERAL INFORMATION	7
3.1	GENERAL DESCRIPTION OF EUT.....	7
3.2	DESCRIPTION OF TEST MODES.....	8
3.3	TEST MODE APPLICABILITY AND TESTED CHANNEL DETAIL:	9
3.4	GENERAL DESCRIPTION OF APPLIED STANDARDS	11
3.5	DESCRIPTION OF SUPPORT UNITS	12
3.6	CONFIGURATION OF SYSTEM UNDER TEST.....	12
4	TEST PROCEDURES AND RESULTS	13
4.1	CONDUCTED EMISSION MEASUREMENT	13
4.1.1	LIMITS OF CONDUCTED EMISSION MEASUREMENT.....	13
4.1.2	TEST INSTRUMENTS.....	13
4.1.3	TEST PROCEDURES	14
4.1.4	TEST SETUP	14
4.1.5	EUT OPERATING CONDITIONS.....	15
4.1.6	TEST RESULTS	16
4.2	NUMBER OF HOPPING FREQUENCY USED	18
4.2.1	LIMIT OF HOPPING FREQUENCY USED.....	18
4.2.2	TEST INSTRUMENTS.....	18
4.2.3	TEST PROCEDURES	19
4.2.4	DEVIATION FROM TEST STANDARD	19
4.2.5	TEST SETUP	20
4.2.6	TEST RESULTS	20
4.3	DWELL TIME ON EACH CHANNEL	22
4.3.1	LIMIT OF DWELL TIME USED	22
4.3.2	TEST INSTRUMENTS.....	22
4.3.3	TEST PROCEDURES	23
4.3.4	DEVIATION FROM TEST STANDARD	23
4.3.5	TEST SETUP	23
4.3.6	TEST RESULTS	24
4.4	CHANNEL BANDWIDTH	28
4.4.1	TEST INSTRUMENTS.....	28
4.4.2	TEST PROCEDURE.....	29
4.4.3	DEVIATION FROM TEST STANDARD	29
4.4.4	TEST SETUP	29
4.4.5	EUT OPERATING CONDITION.....	29
4.4.6	TEST RESULTS	30
4.5	HOPPING CHANNEL SEPARATION	34
4.5.1	LIMIT OF HOPPING CHANNEL SEPARATION.....	34
4.5.2	TEST INSTRUMENTS.....	34
4.5.3	TEST PROCEDURES	35
4.5.4	DEVIATION FROM TEST STANDARD	35
4.5.5	TEST SETUP	35

4.5.6	TEST RESULTS	36
4.6	MAXIMUM PEAK OUTPUT POWER	40
4.6.1	LIMITS OF MAXIMUM PEAK OUTPUT POWER MEASUREMENT	40
4.6.2	INSTRUMENTS	40
4.6.3	TEST PROCEDURES	41
4.6.4	DEVIATION FROM TEST STANDARD	41
4.6.5	TEST SETUP	42
4.6.6	EUT OPERATING CONDITION	42
4.6.7	TEST RESULTS	43
4.7	RADIATED EMISSION MEASUREMENT	47
4.7.1	LIMITS OF RADIATED EMISSION MEASUREMENT	47
4.7.2	TEST INSTRUMENTS	48
4.7.3	TEST PROCEDURES	49
4.7.4	DEVIATION FROM TEST STANDARD	49
4.7.5	TEST SETUP	50
4.7.6	TEST RESULTS	51
4.8	BAND EDGES MEASUREMENT	58
4.8.1	LIMITS OF BAND EDGES MEASUREMENT	58
4.8.2	TEST INSTRUMENTS	58
4.8.3	TEST PROCEDURE	58
4.8.4	DEVIATION FROM TEST STANDARD	58
4.8.5	EUT OPERATING CONDITION	58
4.8.6	TEST RESULTS	59
4.9	ANTENNA REQUIREMENT	65
4.9.1	STANDARD APPLICABLE	65
4.9.2	ANTENNA CONNECTED CONSTRUCTION	65
5	INFORMATION ON THE TESTING LABORATORIES	66
6	APPENDIX A - MODIFICATIONS RECORDERS FOR ENGINEERING CHANGES TO THE EUT BY THE LAB	67



1 CERTIFICATION

PRODUCT : KwikBlue4c Class 1 BC04 Bluetooth Module with 20-pin connector
BRAND NAME : Socket Mobile, Inc.
MODEL NO. : 8520-00145
APPLICANT : Socket Mobile, Inc.
TESTED DATE: July 07 to 29, 2008
TEST SAMPLE : ENGINEERING SAMPLE
STANDARDS : 47 CFR Part 15, Subpart C (Section 15.247), ANSI C63.4-2003

The above equipment (Model: 8520-00145) has been tested by **Advance Data Technology Corporation**, and found compliance with the requirement of the above standards. The test record, data evaluation & Equipment Under Test (EUT) configurations represented herein are true and accurate accounts of the measurements of the sample's EMC characteristics under the conditions specified in this report.

PREPARED BY : Midoli Peng , **DATE:** Aug. 18, 2008
(Midoli Peng, Specialist)

TECHNICAL ACCEPTANCE : Hank Chung , **DATE:** Aug. 18, 2008
Responsible for RF (Hank Chung, Deputy Manager)

APPROVED BY : May Chen , **DATE:** Aug. 18, 2008
(May Chen, Deputy Manager)

2 SUMMARY OF TEST RESULTS

The EUT has been tested according to the following specifications:

APPLIED STANDARD: 47 CFR Part 15, Subpart C			
Standard Section	Test Type and Limit	Result	REMARK
15.207	AC Power Conducted Emission	PASS	Meet the requirement of limit Minimum passing margin is -14.86dB at 0.469MHz
15.247(a)(1)(I)-(ii)	Number of Hopping Frequency Used Spec.: At least 15 channels	PASS	Meet the requirement of limit
15.247(a)(1)(ii)	Dwell Time on Each Channel Spec.: Max. 0.4 second within 31.6 second	PASS	Meet the requirement of limit
15.247(a)(1)(I)-(ii)	Hopping Channel Separation Spec. : Min. 25 kHz or two-thirds of 20 dB bandwidth, which ever is greater	PASS	Meet the requirement of limit
15.247(a)(2)	Spectrum Bandwidth of a Frequency Hopping Sequence Spread Spectrum System	PASS	Report reference
15.247(b)	Maximum Peak Output Power Spec.: max. 125mW	PASS	Meet the requirement of limit
15.247(c)	Transmitter Radiated Emissions Spec.: Table 15.209	PASS	Meet the requirement of limit Minimum passing margin is -1.08dB at 2483.50MHz
15.247(c)	Band Edge Measurement	PASS	Meet the requirement of limit

2.1 MEASUREMENT UNCERTAINTY

Where relevant, the following measurement uncertainty levels have been estimated for tests performed on the EUT as specified in CISPR 16-4:

This uncertainty represents an expanded uncertainty expressed at approximately the 95% confidence level using a coverage factor of $k=2$.

Measurement	Value
Conducted emissions	2.44 dB
Radiated emissions (30MHz-1GHz)	3.94 dB
Radiated emissions (1GHz ~18GHz)	2.33 dB
Radiated emissions (18GHz ~20GHz)	2.55 dB

3 GENERAL INFORMATION

3.1 GENERAL DESCRIPTION OF EUT

PRODUCT	KwikBlue4c Class 1 BC04 Bluetooth Module with 20-pin connector
MODEL NO.	8520-00145
FCC ID	LUBBTM-4C
POWER SUPPLY	DC 3.3V to 3.6V from host equipment
MODULATION TYPE	GFSK, 8DPSK, $\pi/4$ -DQPSK
MODULATION TECHNOLOGY	FHSS
FREQUENCY RANGE	2402MHz ~ 2480MHz
NUMBER OF CHANNEL	79
OUTPUT POWER	14.028mW
ANTENNA TYPE	Built-in printing antenna with 0dBi antenna gain
DATA CABLE	NA
ASSOCIATED DEVICES	NA

NOTE:

1. The EUT was pre-tested under the following modes:

Test Mode	Description
Mode A	X-Y plane
Mode B	X-Z plane
Mode C	Y-Z plane

From the above modes, the worst emission level was found in **Mode A**. Therefore only the test data of the modes were recorded in this report individually.

2. The above EUT information was declared by the manufacturer and for more detailed features description, please refer to the manufacturer's specifications or User's Manual.

3.2 DESCRIPTION OF TEST MODES

Seventy-nine channels are provided to this EUT.

Channel	Freq. (MHz)	Channel	Freq. (MHz)	Channel	Freq. (MHz)	Channel	Freq. (MHz)
0	2402	20	2422	40	2442	60	2462
1	2403	21	2423	41	2443	61	2463
2	2404	22	2424	42	2444	62	2464
3	2405	23	2425	43	2445	63	2465
4	2406	24	2426	44	2446	64	2466
5	2407	25	2427	45	2447	65	2467
6	2408	26	2428	46	2448	66	2468
7	2409	27	2429	47	2449	67	2469
8	2410	28	2430	48	2450	68	2470
9	2411	29	2431	49	2451	69	2471
10	2412	30	2432	50	2452	70	2472
11	2413	31	2433	51	2453	71	2473
12	2414	32	2434	52	2454	72	2474
13	2415	33	2435	53	2455	73	2475
14	2416	34	2436	54	2456	74	2476
15	2417	35	2437	55	2457	75	2477
16	2418	36	2438	56	2458	76	2478
17	2419	37	2439	57	2459	77	2479
18	2420	38	2440	58	2460	78	2480
19	2421	39	2441	59	2461		

3.3 TEST MODE APPLICABILITY AND TESTED CHANNEL DETAIL:

EUT configure mode	Applicable to				Description
	PLC	RE<1G	RE≥1G	APCM	
-	√	√	√	√	Modulation Type: GFSK, 8DPSK, $\pi/4$ -DQPSK

Where PLC: Power Line Conducted Emission RE<1G RE: Radiated Emission below 1GHz
 RE≥1G: Radiated Emission above 1GHz APCM: Antenna Port Conducted Measurement

Power Line Conducted Emission Test:

- Pre-Scan has been conducted to determine the worst-case mode from all possible combinations between available modulations, data rates and antenna ports (if EUT with antenna diversity architecture).
- Following channel(s) was (were) selected for the final test as listed below.

Available Channel	Tested Channel	Modulation Technology	Modulation Type	Packet Type
0 to 78	78	FHSS	GFSK	DH5

Radiated Emission Test (Below 1 GHz):

- Pre-Scan has been conducted to determine the worst-case mode from all possible combinations between available modulations, data rates and antenna ports (if EUT with antenna diversity architecture).
- Following channel(s) was (were) selected for the final test as listed below.

Available Channel	Tested Channel	Modulation Technology	Modulation Type	Packet Type
0 to 78	78	FHSS	GFSK	DH5

Radiated Emission Test (Above 1 GHz):

- Pre-Scan has been conducted to determine the worst-case mode from all possible combinations between available modulations, data rates and antenna ports (if EUT with antenna diversity architecture).
- Following channel(s) was (were) selected for the final test as listed below.

Available Channel	Tested Channel	Modulation Technology	Modulation Type	Packet Type
0 to 78	0, 39, 78	FHSS	GFSK	DH5
0 to 78	0, 39, 78	FHSS	8DPSK	DH5

Bandedge Measurement:

- Pre-Scan has been conducted to determine the worst-case mode from all possible combinations between available modulations, data rates and antenna ports (if EUT with antenna diversity architecture).
- Following channel(s) was (were) selected for the final test as listed below.

Available Channel	Tested Channel	Modulation Technology	Modulation Type	Packet Type
0 to 78	0, 78	FHSS	GFSK	DH5
0 to 78	0, 78	FHSS	8DPSK	DH5

Antenna Port Conducted Measurement:

- Pre-Scan has been conducted to determine the worst-case mode from all possible combinations between available modulations, data rates and antenna ports (if EUT with antenna diversity architecture).
- Following channel(s) was (were) selected for the final test as listed below.

Available Channel	Tested Channel	Modulation Technology	Modulation Type	Packet Type
0 to 78	0, 39, 78	FHSS	GFSK	DH5
0 to 78	0, 39, 78	FHSS	8DPSK	DH5

3.4 GENERAL DESCRIPTION OF APPLIED STANDARDS

The EUT is a KwikBlue4c Class 1 BC04 Bluetooth Module with 20-pin connector. According to the specifications of the manufacturer, it must comply with the requirements of the following standards:

FCC Part 15, Subpart C. (15.247)

ANSI C63.4 : 2003

All test items have been performed and recorded as per the above standards.

3.5 DESCRIPTION OF SUPPORT UNITS

The EUT has been tested as an independent unit together with other necessary accessories or support units. The following support units or accessories were used to form a representative test configuration during the tests.

No.	Product	Brand	Model No.	Serial No.	FCC ID
1	NOTEBOOK COMPUTER	DELL	PP18L	6976685584	FCC DoC
2	TEST TOOL	Socket Mobile, Inc.	NA	NA	NA
3	ADAPTER	JENTEC	JTA0302E	NA	NA

No.	Signal cable description
1	NA
2	NA
3	NA

Note: 1. All power cords of the above support units are unshielded (1.8m).

3.6 CONFIGURATION OF SYSTEM UNDER TEST

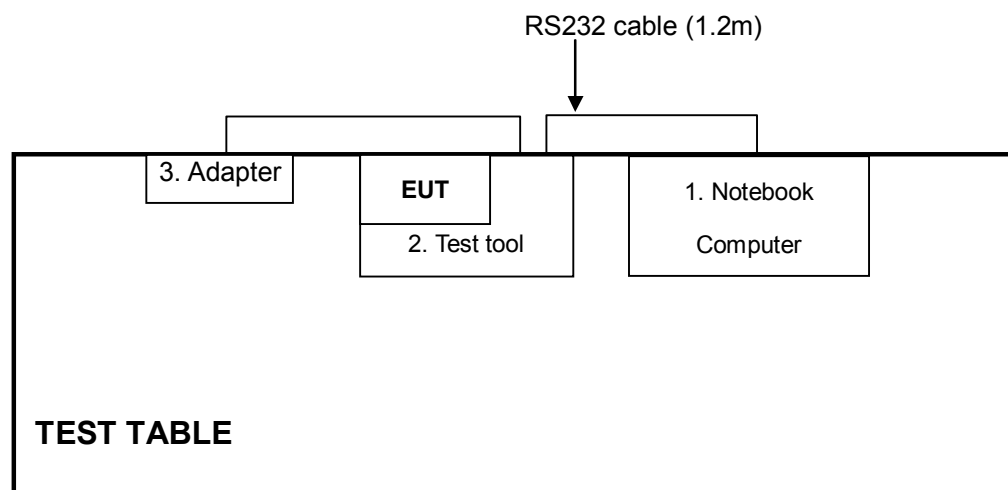

4 TEST PROCEDURES AND RESULTS

4.1 CONDUCTED EMISSION MEASUREMENT

4.1.1 LIMITS OF CONDUCTED EMISSION MEASUREMENT

FREQUENCY OF EMISSION (MHz)	CONDUCTED LIMIT (dB μ V)	
	Quasi-peak	Average
0.15-0.5	66 to 56	56 to 46
0.5-5	56	46
5-30	60	50

NOTE:

1. The lower limit shall apply at the transition frequencies.
2. All emanations from a class B digital device or system, including any network of conductors and apparatus connected thereto, shall not exceed the level of field strengths specified above.

4.1.2 TEST INSTRUMENTS

DESCRIPTION & MANUFACTURER	MODEL NO.	SERIAL NO.	CALIBRATED UNTIL
Test Receiver	ESCS 30	847124/029	Feb. 28, 2009
Line-Impedance Stabilization Network(for EUT)	ENV-216	100071	Nov. 26, 2008
Line-Impedance Stabilization Network(for Peripheral)	ESH3-Z5	848773/004	Nov. 08, 2008
RF Cable (JYEBAO)	5DFB	COBCAB-001	Jul. 23, 2009
50 ohms Terminator	50	3	Nov. 15, 2008
Software	ADT_Cond_V7.3.2	NA	NA

Note:

1. The calibration interval of the above test instruments is 12 months and the calibrations are traceable to NML/ROC and NIST/USA.
2. The test was performed in ADT Shielded Room No. B.
3. The VCCI Con B Registration No. is C-2193.

4.1.3 TEST PROCEDURES

- The EUT/HOST was placed 0.4 meters from the conducting wall of the shielded room with EUT/HOST being connected to the power mains through a line impedance stabilization network (LISN). Other support units were connected to the power mains through another LISN. The two LISNs provide 50 ohm/ 50uH of coupling impedance for the measuring instrument.
- Both lines of the power mains connected to the EUT/HOST were checked for maximum conducted interference.
- The frequency range from 150 kHz to 30 MHz was searched. Emission levels over 10dB under the prescribed limits could not be reported

4.1.4 TEST SETUP

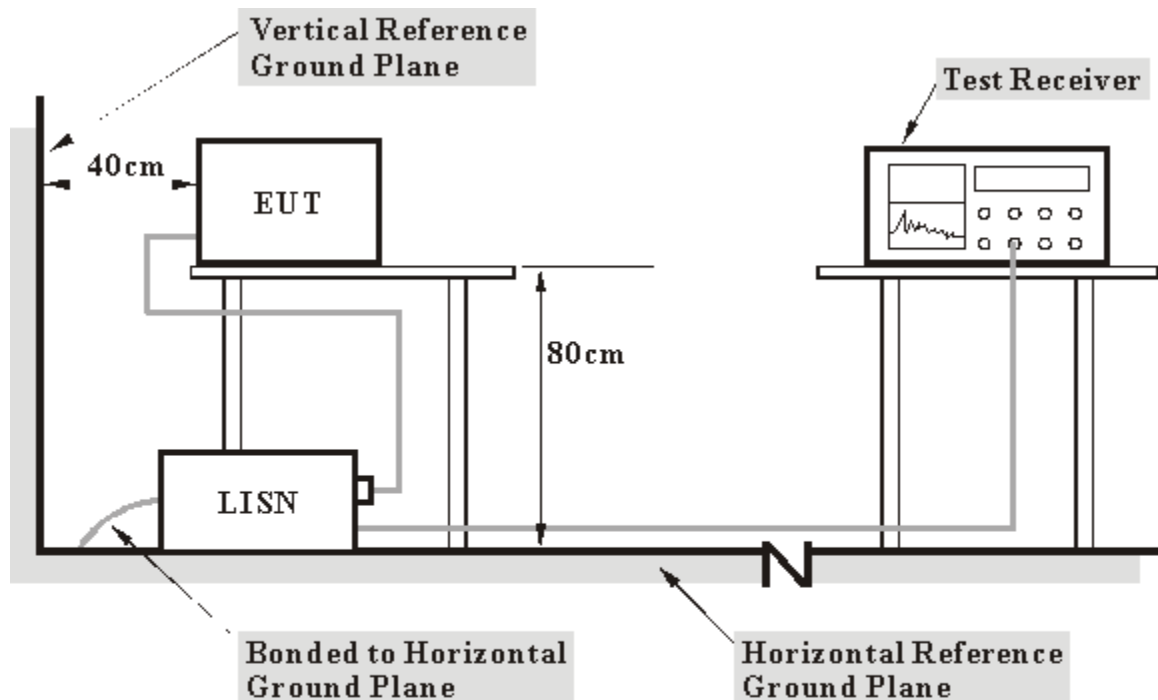

- Note:**
- Support units were connected to second LISN.
 - Both of LISNs (AMN) 80 cm from EUT and at the least 80 cm from other units and other metal planes support units.

For the actual test configuration, please refer to the related item – Photographs of the Test Configuration.

4.1.5 EUT OPERATING CONDITIONS

- a. Connect the EUT with the support unit 1 (Notebook computer) which placed on a testing table.
- b. The support unit 1 (Notebook computer) ran a test program “CSR Blue test.exe” to enable EUT under transmission condition continuously.

4.1.6 TEST RESULTS

INPUT POWER (SYSTEM)	120Vac, 60 Hz	6DB BANDWIDTH	9 kHz
ENVIRONMENTAL CONDITIONS	25 deg. C, 66%RH, 972 hPa	PHASE	Line (L)
TESTED BY	Phoenix Huang		

No	Freq. [MHz]	Corr. Factor (dB)	Reading Value		Emission Level		Limit		Margin	
			[dB (uV)]		[dB (uV)]		[dB (uV)]		(dB)	
			Q.P.	AV.	Q.P.	AV.	Q.P.	AV.	Q.P.	AV.
1	0.177	9.65	34.34	-	43.99	-	64.61	54.61	-20.62	-
2	0.232	9.65	30.61	-	40.26	-	62.38	52.38	-22.12	-
3	0.469	9.67	32.01	-	41.68	-	56.54	46.54	-14.86	-
4	0.529	9.68	28.16	-	37.84	-	56.00	46.00	-18.16	-
5	2.871	9.83	24.26	-	34.09	-	56.00	46.00	-21.91	-
6	19.996	10.24	20.13	-	30.37	-	60.00	50.00	-29.63	-

- REMARKS:**
1. Q.P. and AV. are abbreviations of quasi-peak and average individually.
 2. "-": The Quasi-peak reading value also meets average limit and measurement with the average detector is unnecessary.
 3. The emission levels of other frequencies were very low against the limit.
 4. Margin value = Emission level - Limit value
 5. Correction factor = Insertion loss + Cable loss
 6. Emission Level = Correction Factor + Reading Value.

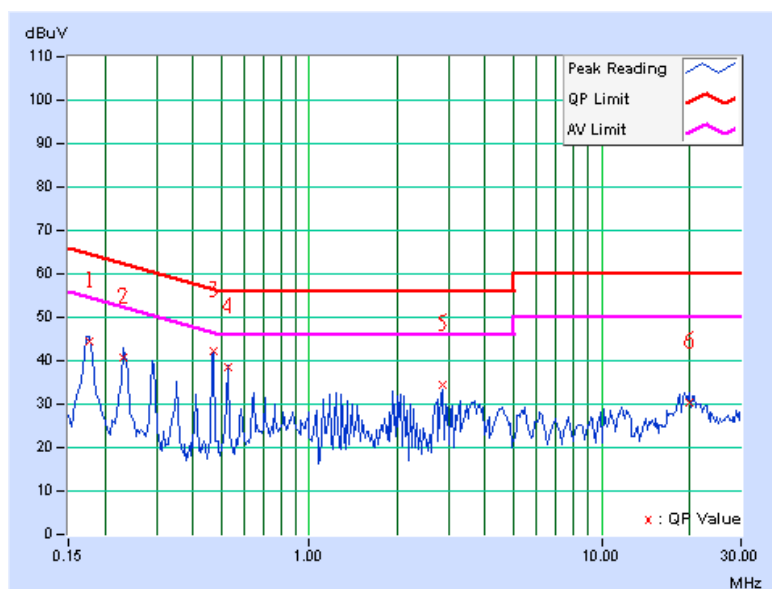

INPUT POWER (SYSTEM)	120Vac, 60 Hz	6dB BANDWIDTH	9 kHz
ENVIRONMENTAL CONDITIONS	25 deg. C, 66%RH, 972 hPa	PHASE	Neutral (N)
TESTED BY	Phoenix Huang		

No	Freq. [MHz]	Corr. Factor (dB)	Reading Value		Emission Level		Limit		Margin	
			[dB (uV)]		[dB (uV)]		[dB (uV)]		(dB)	
			Q.P.	AV.	Q.P.	AV.	Q.P.	AV.	Q.P.	AV.
1	0.173	9.65	28.35	-	38.00	-	64.79	54.79	-26.80	-
2	0.232	9.65	24.16	-	33.81	-	62.38	52.38	-28.57	-
3	0.470	9.66	30.68	-	40.34	-	56.51	46.51	-16.17	-
4	0.529	9.67	27.54	-	37.21	-	56.00	46.00	-18.79	-
5	2.816	9.83	24.70	-	34.53	-	56.00	46.00	-21.47	-
6	19.374	10.36	19.78	-	30.14	-	60.00	50.00	-29.86	-

- REMARKS:**
1. Q.P. and AV. are abbreviations of quasi-peak and average individually.
 2. "-": The Quasi-peak reading value also meets average limit and measurement with the average detector is unnecessary.
 3. The emission levels of other frequencies were very low against the limit.
 4. Margin value = Emission level - Limit value
 5. Correction factor = Insertion loss + Cable loss
 6. Emission Level = Correction Factor + Reading Value.

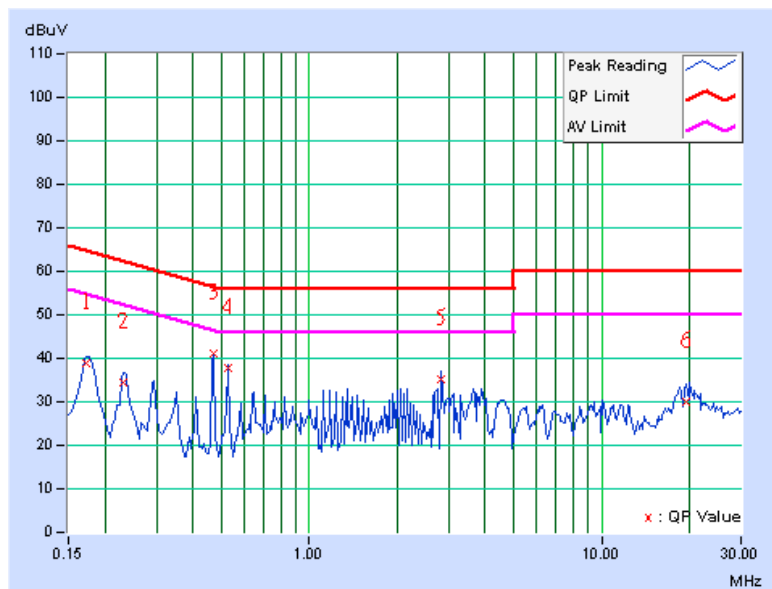

4.2 NUMBER OF HOPPING FREQUENCY USED

4.2.1 LIMIT OF HOPPING FREQUENCY USED

At least 15 hopping frequencies, and should be equally spaced.

4.2.2 TEST INSTRUMENTS

Description & Manufacturer	Model No.	Serial No.	Calibrated Until
R&S SPECTRUM ANALYZER	FSP40	100036	Dec. 17, 2008

Note:

1. The measurement uncertainty is less than +/- 2.6dB, which is calculated as per the NAMAS document NIS81. This uncertainty represents an expanded uncertainty expressed at approximately the 95% confidence level using a coverage factor of k=2.
2. The calibration interval of the above test instruments is 12 months and the calibrations are traceable to NML/ROC and NIST/USA.

4.2.3 TEST PROCEDURES

1. Check the calibration of the measuring instrument (SA) using either an internal calibrator or a known signal from an external generator.
2. Turn on the EUT and connect its antenna terminal to measurement via a low loss cable. Then set it to any one measured frequency within its operating range and make sure the instrument is operated in its linear range.
3. Set the SA on MaxHold Mode, and then keep the EUT in hopping mode. Record all the signals from each channel until each one has been recorded.
4. Set the SA on View mode and then plot the result on SA screen.
5. Repeat above procedures until all frequencies measured were complete.

4.2.4 DEVIATION FROM TEST STANDARD

No deviation

4.2.5 TEST SETUP

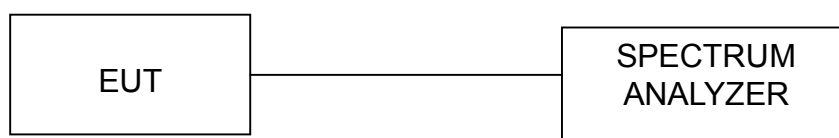

4.2.6 TEST RESULTS

There are 79 hopping frequencies in the hopping mode. Please refer to next pages for the test result. On the plots, it shows that the hopping frequencies are equally spaced.

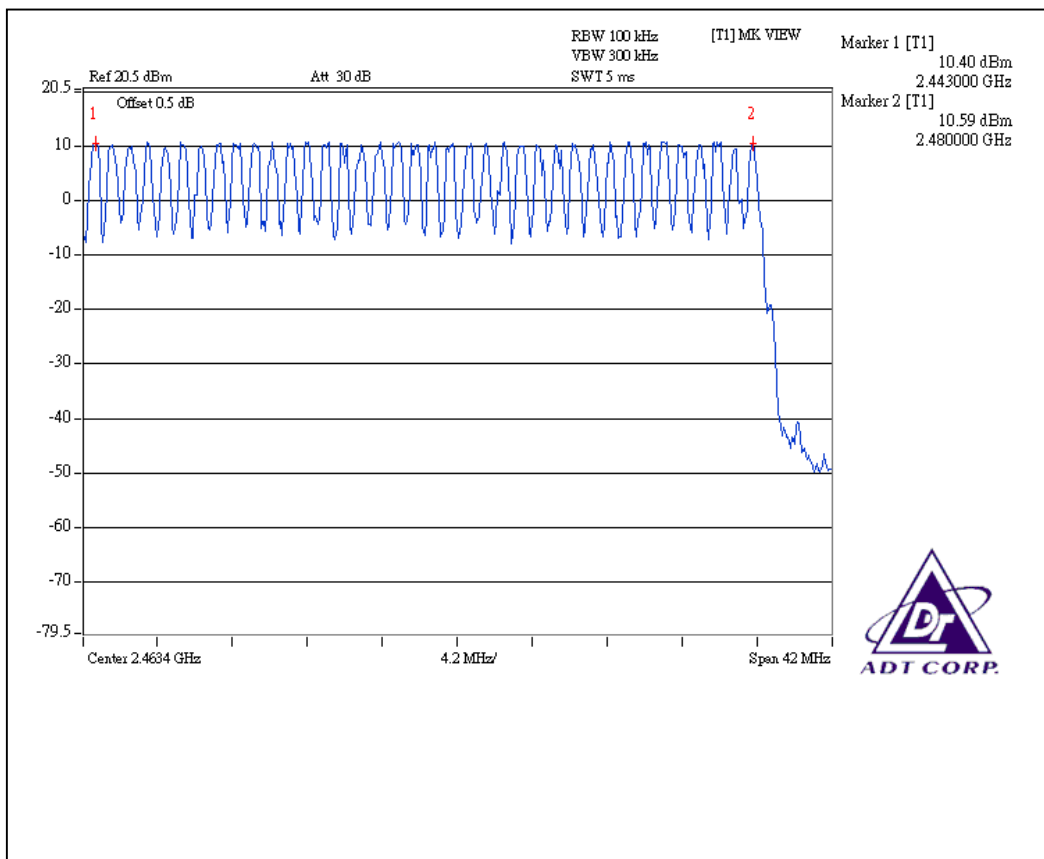
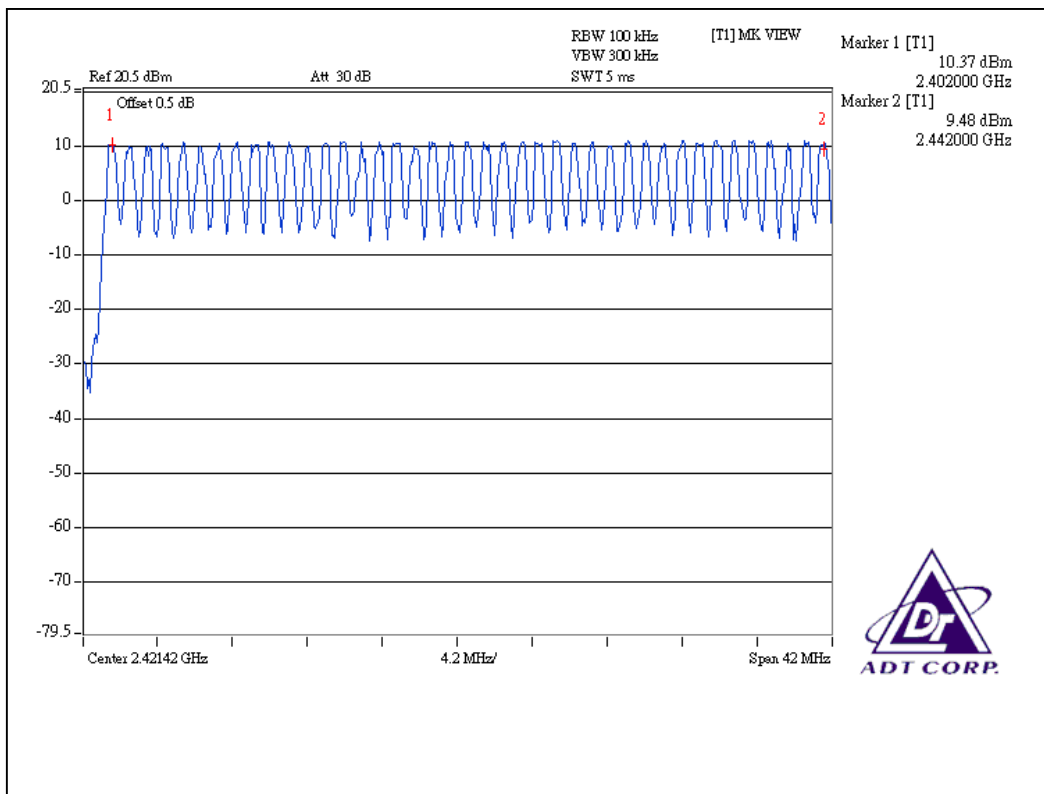

4.3 DWELL TIME ON EACH CHANNEL

4.3.1 LIMIT OF DWELL TIME USED

For FHSS, the average time of occupancy on any frequency shall not be greater than 0.4 seconds within a 31.6 second period. For hybrid systems, the average time of occupancy on any frequency should not exceed 0.4 seconds within a time period in seconds equal to the number of hopping frequencies employed multiplied by 0.4.

4.3.2 TEST INSTRUMENTS

Description & Manufacturer	Model No.	Serial No.	Calibrated Until
R&S SPECTRUM ANALYZER	FSP40	100036	Dec. 17, 2008

Note:

1. The measurement uncertainty is less than +/- 2.6dB, which is calculated as per the NAMAS document NIS81. This uncertainty represents an expanded uncertainty expressed at approximately the 95% confidence level using a coverage factor of k=2.
2. The calibration interval of the above test instruments is 12 months and the calibrations are traceable to NML/ROC and NIST/USA.

4.3.3 TEST PROCEDURES

1. Check the calibration of the measuring instrument (SA) using either an internal calibrator or a known signal from an external generator.
2. Turn on the EUT and connect its antenna terminal to measurement via a low loss cable. Then set it to any one measured frequency within its operating range and make sure the instrument is operated in its linear range.
3. Adjust the center frequency of SA on any frequency be measured and set SA to zero span mode. And then, set RBW and VBW of spectrum analyzer to proper value.
4. Measure the time duration of one transmission on the measured frequency. And then plot the result with time difference of this time duration.
5. Repeat above procedures until all frequencies measured were complete.

4.3.4 DEVIATION FROM TEST STANDARD

No deviation

4.3.5 TEST SETUP



4.3.6 TEST RESULTS

Mode	Number of transmission in a 31.6 (79Hopping*0.4)	Length of transmission time (msec)	Result (msec)	Limit (msec)
DH1	51 (times / 5 sec) *6.32=322.32 times	0.444	143.110	400
DH3	25 (times / 5 sec) *6.32=158.00 times	1.722	272.076	400
DH5	16 (times / 5 sec) *6.32=101.12 times	3.020	305.38	400

Test plots of the transmitting time slot are shown on next three pages.

DH5

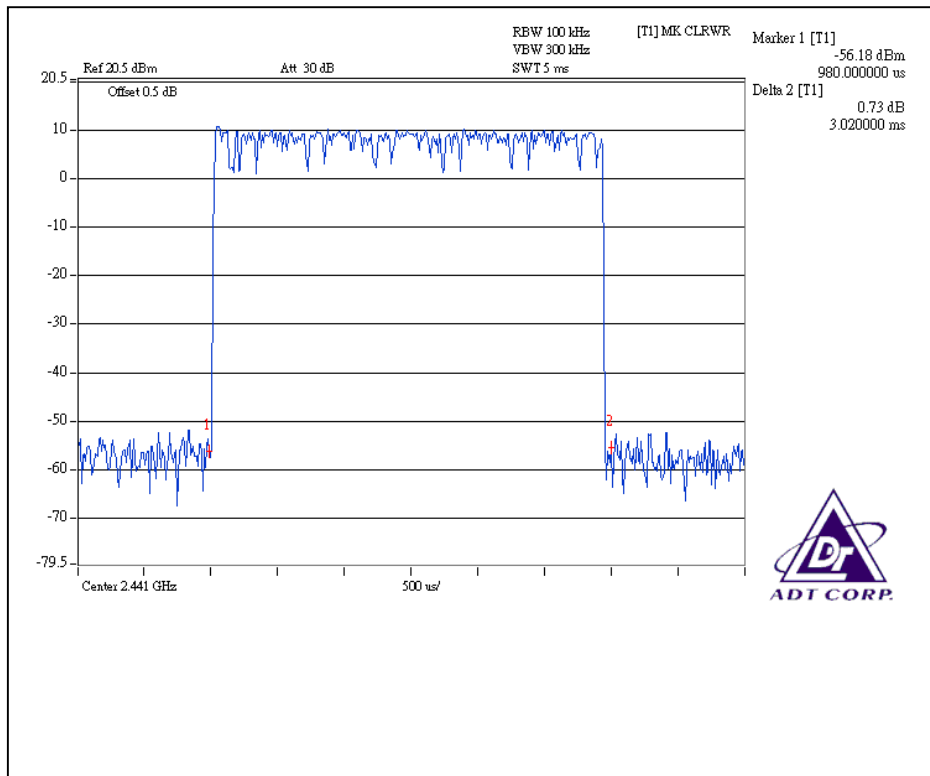
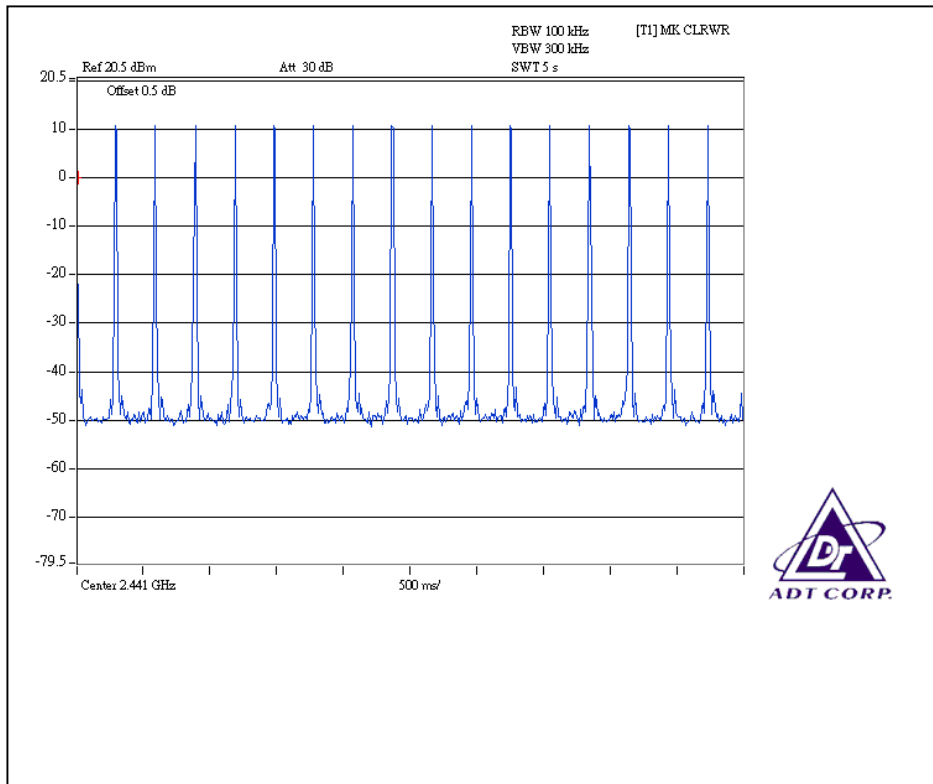

4.4 CHANNEL BANDWIDTH

4.4.1 TEST INSTRUMENTS

Description & Manufacturer	Model No.	Serial No.	Calibrated Until
R&S SPECTRUM ANALYZER	FSP40	100036	Dec. 17, 2008

Note:

1. The measurement uncertainty is less than +/- 2.6dB, which is calculated as per the NAMAS document NIS81. This uncertainty represents an expanded uncertainty expressed at approximately the 95% confidence level using a coverage factor of k=2.
2. The calibration interval of the above test instruments is 12 months and the calibrations are traceable to NML/ROC and NIST/USA.

4.4.2 TEST PROCEDURE

1. Check the calibration of the measuring instrument using either an internal calibrator or a known signal from an external generator.
2. Turn on the EUT and connect it to measurement instrument. Then set it to any one convenient frequency within its operating range. Set a reference level on the measuring instrument equal to the highest peak value.
3. Measure the frequency difference of two frequencies that were attenuated 20dB from the reference level. Record the frequency difference as the emission bandwidth.
4. Repeat above procedures until all frequencies measured were complete.

4.4.3 DEVIATION FROM TEST STANDARD

No deviation

4.4.4 TEST SETUP



4.4.5 EUT OPERATING CONDITION

The software provided by client enabled the EUT to transmit and receive data at lowest, middle and highest channel frequencies individually.

4.4.6 TEST RESULTS

MODULATION TYPE	GFSK	INPUT POWER (SYSTEM)	120Vac, 60 Hz
ENVIRONMENTAL CONDITIONS	25deg. C, 68%RH, 972 hPa	TESTED BY	Phoenix Huang

CHANNEL	CHANNEL FREQUENCY (MHz)	20dB BANDWIDTH (kHz)
0	2402	838.09
39	2441	837.02
78	2480	837.11

Channel 0

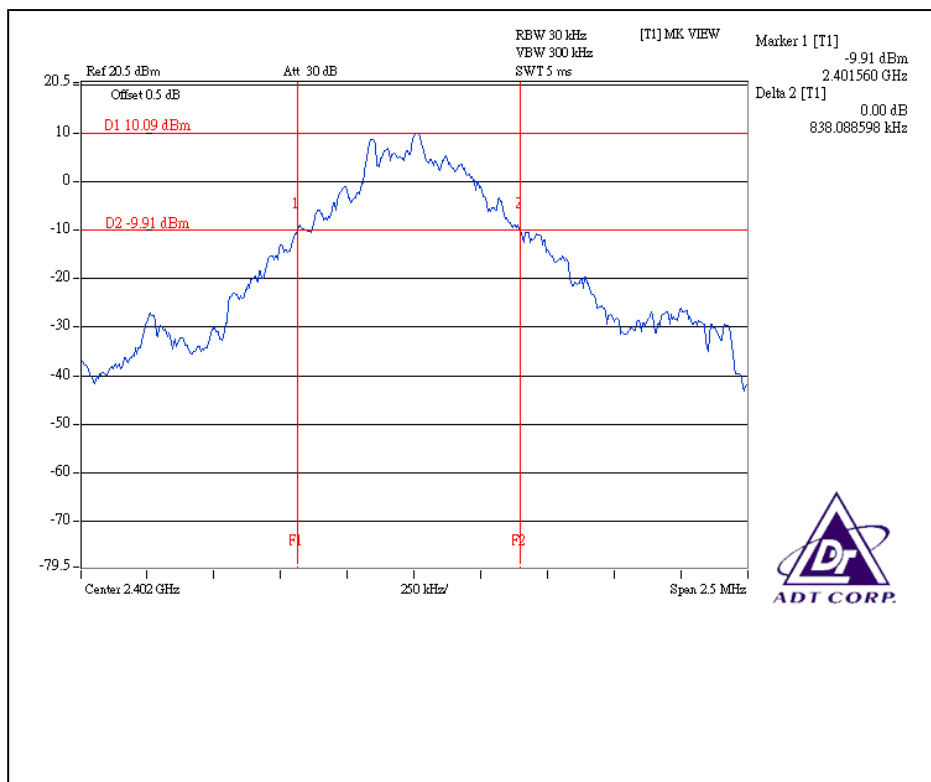

Channel 39

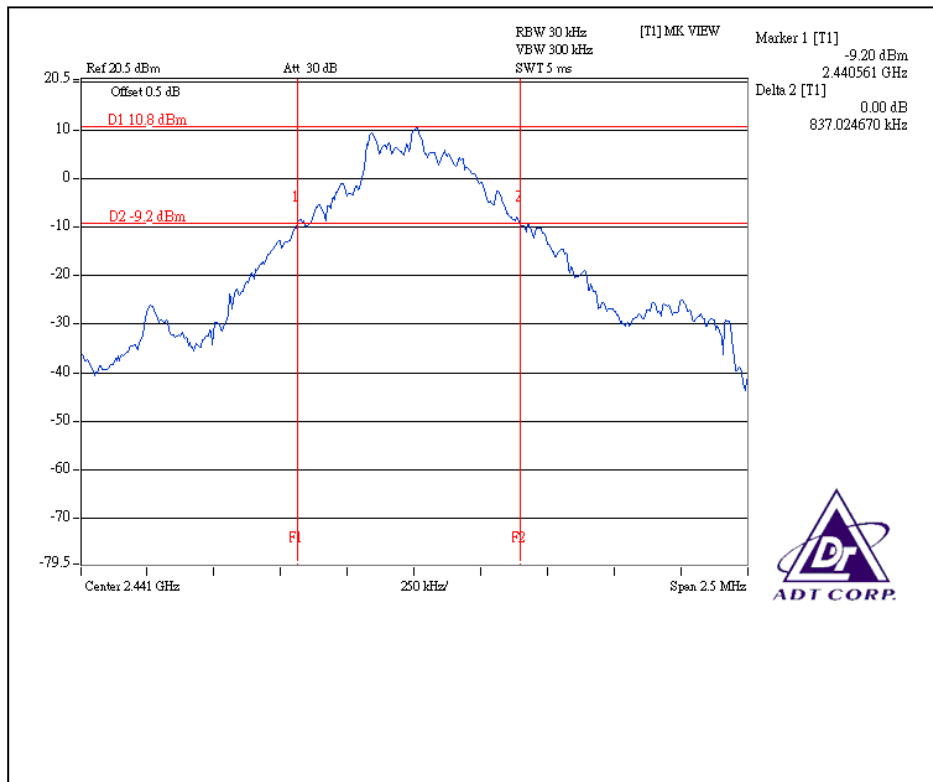

Channel 78

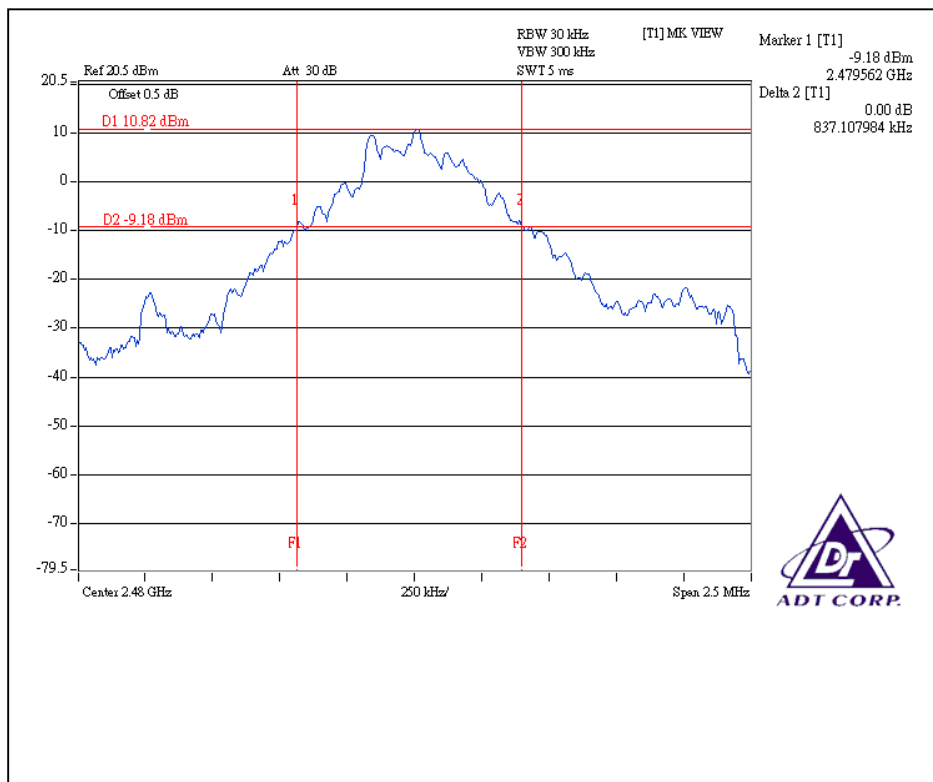

Channel 39

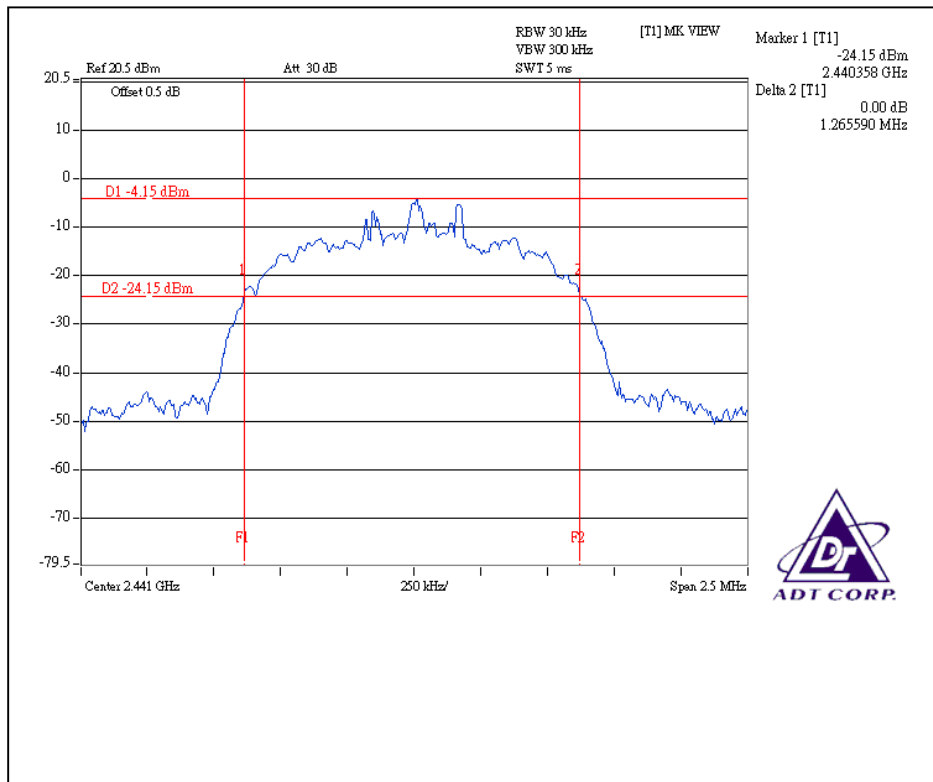

Channel 78

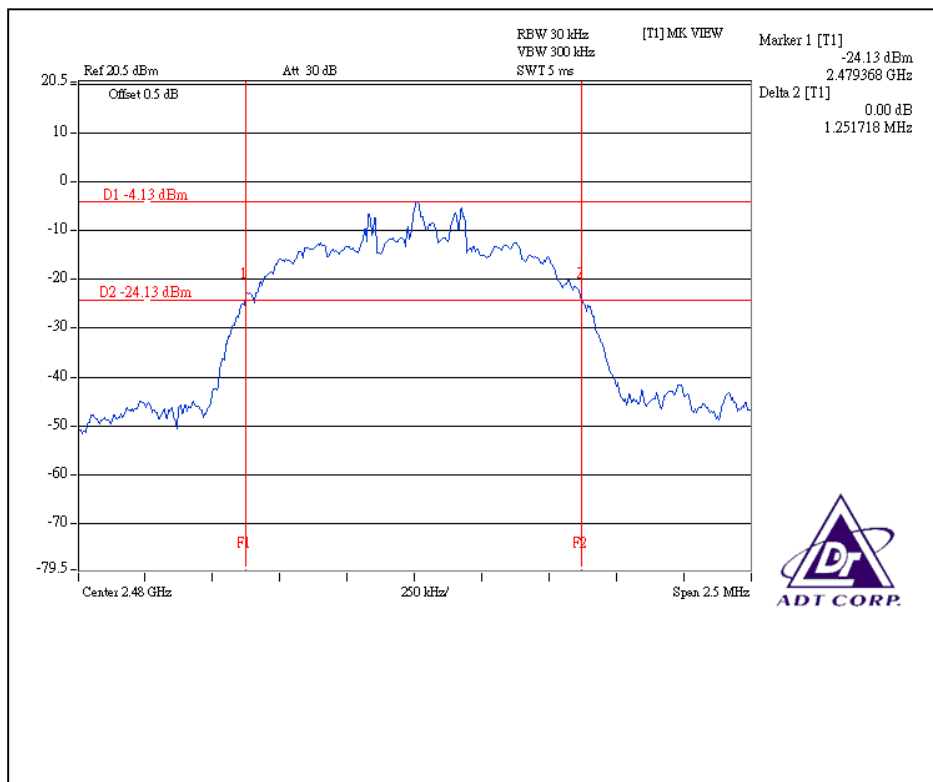

4.5 HOPPING CHANNEL SEPARATION

4.5.1 LIMIT OF HOPPING CHANNEL SEPARATION

At least 25 kHz or two-thirds of 20dB hopping channel bandwidth (whichever is greater).

4.5.2 TEST INSTRUMENTS

Description & Manufacturer	Model No.	Serial No.	Calibrated Until
R&S SPECTRUM ANALYZER	FSP40	100036	Dec. 17, 2008

Note:

1. The measurement uncertainty is less than +/- 2.6dB, which is calculated as per the NAMAS document NIS81. This uncertainty represents an expanded uncertainty expressed at approximately the 95% confidence level using a coverage factor of k=2.
2. The calibration interval of the above test instruments is 12 months and the calibrations are traceable to NML/ROC and NIST/USA.

4.5.3 TEST PROCEDURES

1. Check the calibration of the measuring instrument using either an internal calibrator or a known signal from an external generator.
2. Turn on the EUT and connect it to measurement instrument. Then set it to any one convenient frequency within its operating range.
3. By using the MaxHold function record the separation of two adjacent channels.
4. Measure the frequency difference of these two adjacent channels by SA MARK function. And then plot the result on SA screen.
5. Repeat above procedures until all frequencies measured were complete.

4.5.4 DEVIATION FROM TEST STANDARD

No deviation

4.5.5 TEST SETUP

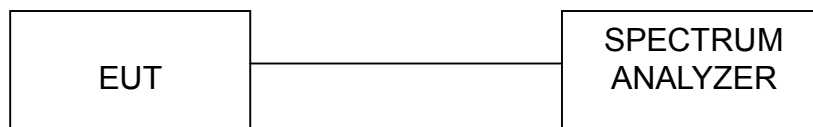

4.5.6 TEST RESULTS

MODULATION TYPE	GFSK	INPUT POWER (SYSTEM)	120Vac, 60 Hz
ENVIRONMENTAL CONDITIONS	20deg. C, 68%RH, 963 hPa	TESTED BY	Phoenix Huang

Channel	Frequency (MHz)	Adjacent Channel Separation	Minimum Limit (kHz)	Pass / Fail
0	2402	1.003MHz	558.73	PASS
39	2441	1.002MHz	558.01	PASS
78	2480	1.008MHz	558.07	PASS

The minimum limit is two-thirds of 20dB bandwidth. Test results please refer to next two pages.

Channel 0

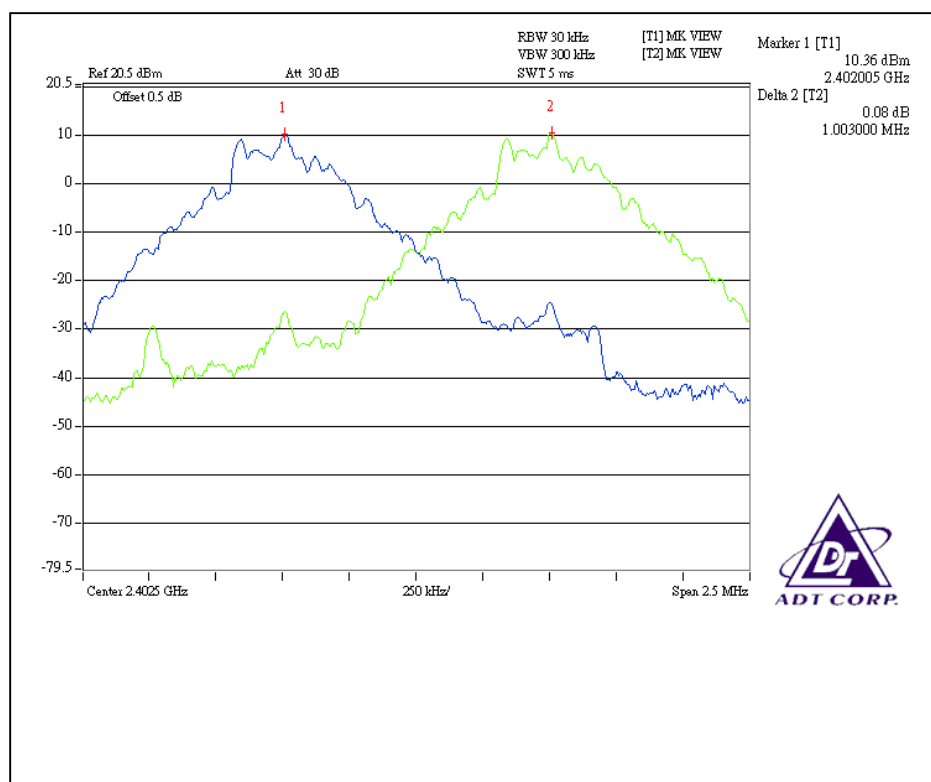

Channel 39

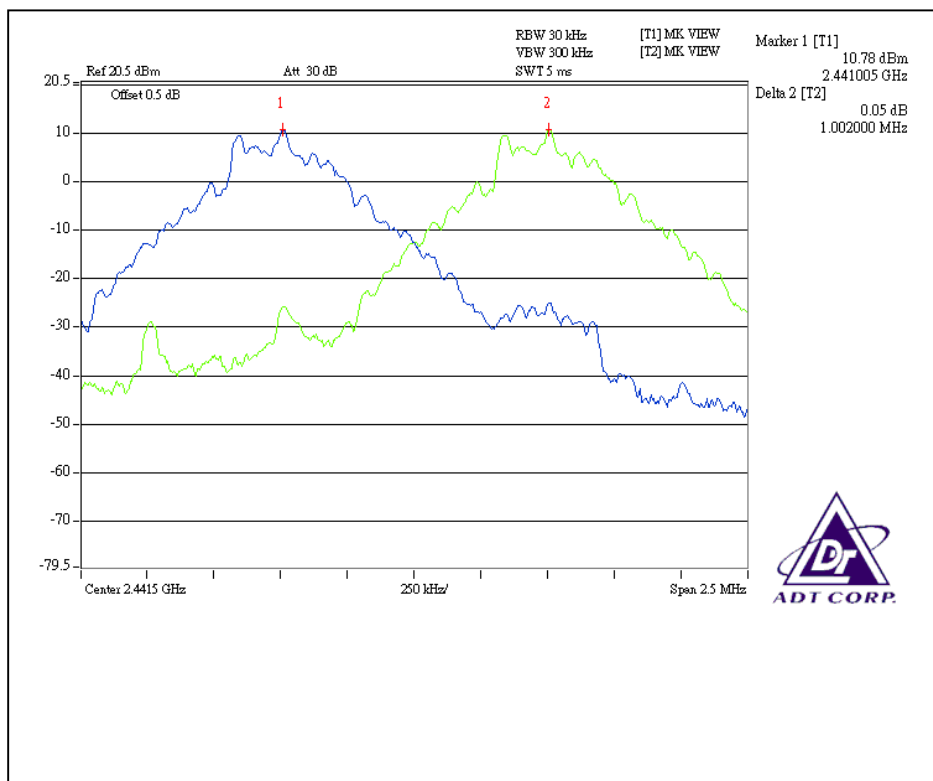

Channel 78

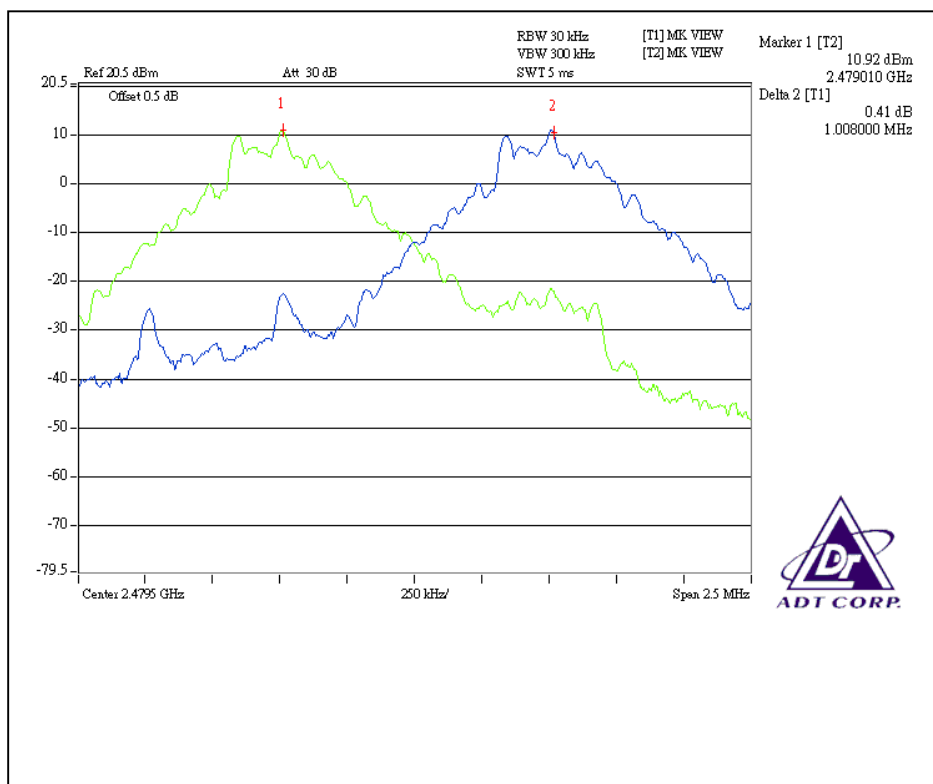

MODULATION TYPE	8DPSK	INPUT POWER (SYSTEM)	120Vac, 60 Hz
ENVIRONMENTAL CONDITIONS	25deg. C, 68%RH, 972 hPa	TESTED BY	Phoenix Huang

Channel	Frequency (MHz)	Adjacent Channel Separation	Minimum Limit (kHz)	Pass / Fail
0	2402	1.002MHz	845.00	PASS
39	2441	1.007MHz	843.73	PASS
78	2480	1.004MHz	834.47	PASS

The minimum limit is two-thirds of 20dB bandwidth. Test results please refer to next two pages.

Channel 0

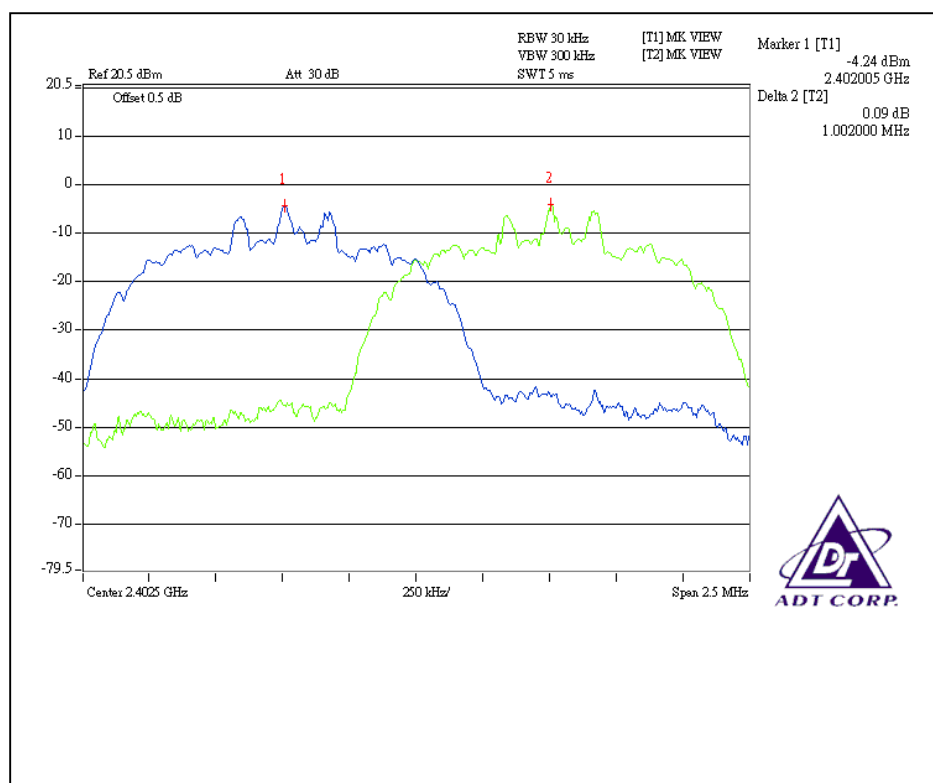



Channel 39

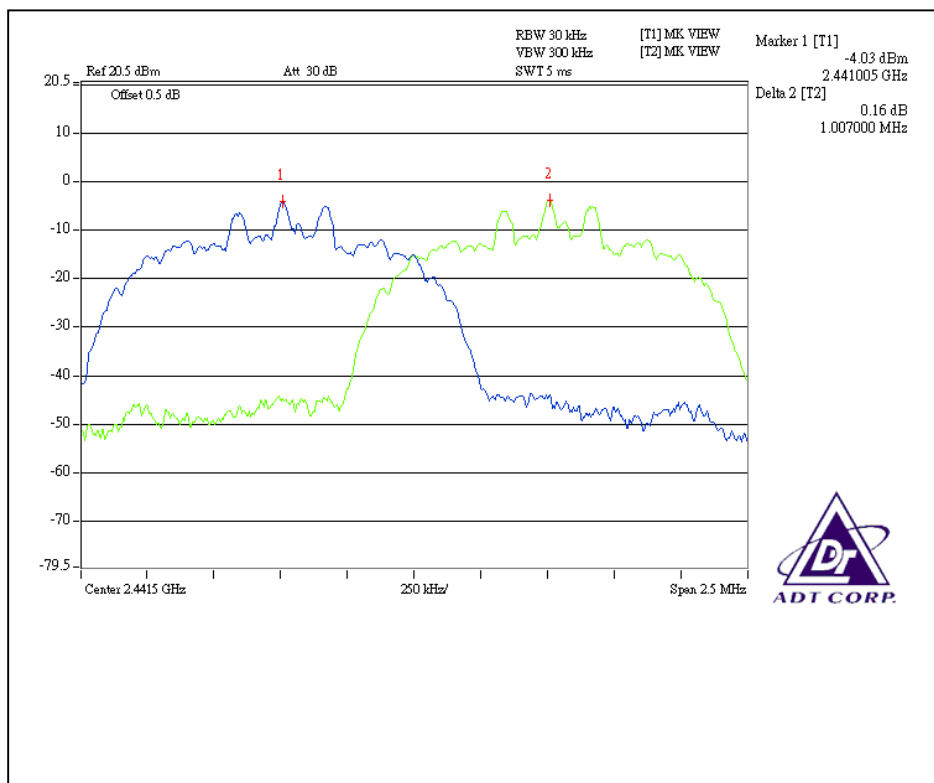

Channel 78

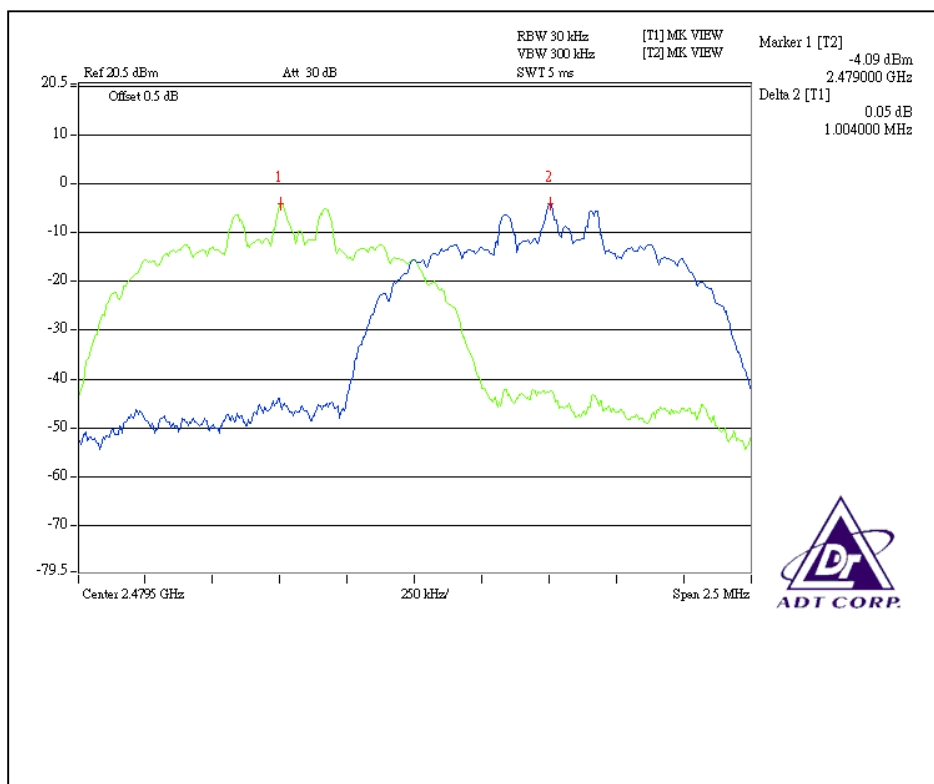

4.6 MAXIMUM PEAK OUTPUT POWER

4.6.1 LIMITS OF MAXIMUM PEAK OUTPUT POWER MEASUREMENT

The Maximum Peak Output Power Measurement is 125mW.

4.6.2 INSTRUMENTS

Description & Manufacturer	Model No.	Serial No.	Calibrated Until
R&S SPECTRUM ANALYZER	FSP40	100036	Dec. 17, 2008

Note:

1. The measurement uncertainty is less than +/- 2.6dB, which is calculated as per the NAMAS document NIS81. This uncertainty represents an expanded uncertainty expressed at approximately the 95% confidence level using a coverage factor of k=2.
2. The calibration interval of the above test instruments is 12 months and the calibrations are traceable to NML/ROC and NIST/USA.

4.6.3 TEST PROCEDURES

1. Check the calibration of the measuring instrument using either an internal calibrator or a known signal from an external generator.
2. Turn on the EUT and connect it to measurement instrument. Then set it to any one convenient frequency within its operating range. Set a reference level on the measuring instrument equal to the highest peak value.
3. The center frequency of the spectrum analyzer is set to the fundamental frequency and using 3 MHz RBW and 3 MHz VBW.
4. Measure the frequency difference of two frequencies that were attenuated 20dB from the reference level. Record the frequency difference as the emission bandwidth.
5. Repeat above procedures until all frequencies measured were complete.

4.6.4 DEVIATION FROM TEST STANDARD

No deviation

4.6.5 TEST SETUP

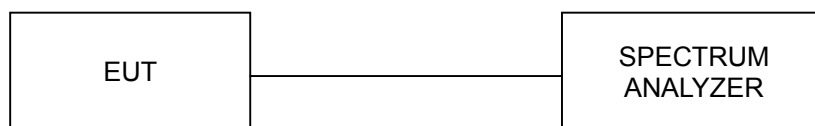

For the actual test configuration, please refer to the related Item – Photographs of the Test Configuration.

4.6.6 EUT OPERATING CONDITION

The software provided by client enabled the EUT to transmit and receive data at lowest, middle and highest channel frequencies individually.

4.6.7 TEST RESULTS

MODULATION TYPE	GFSK	INPUT POWER (SYSTEM)	120Vac, 60 Hz
ENVIRONMENTAL CONDITIONS	25deg. C, 68%RH, 972 hPa	TESTED BY	Phoenix Huang

CHANNEL	CHANNEL FREQUENCY (MHz)	PEAK POWER OUTPUT (mW)	PEAK POWER OUTPUT (dBm)	PEAK POWER LIMIT (mW)	PASS/FAIL
0	2402	12.274	10.89	125	PASS
39	2441	13.428	11.28	125	PASS
78	2480	14.028	11.47	125	PASS

Channel 0

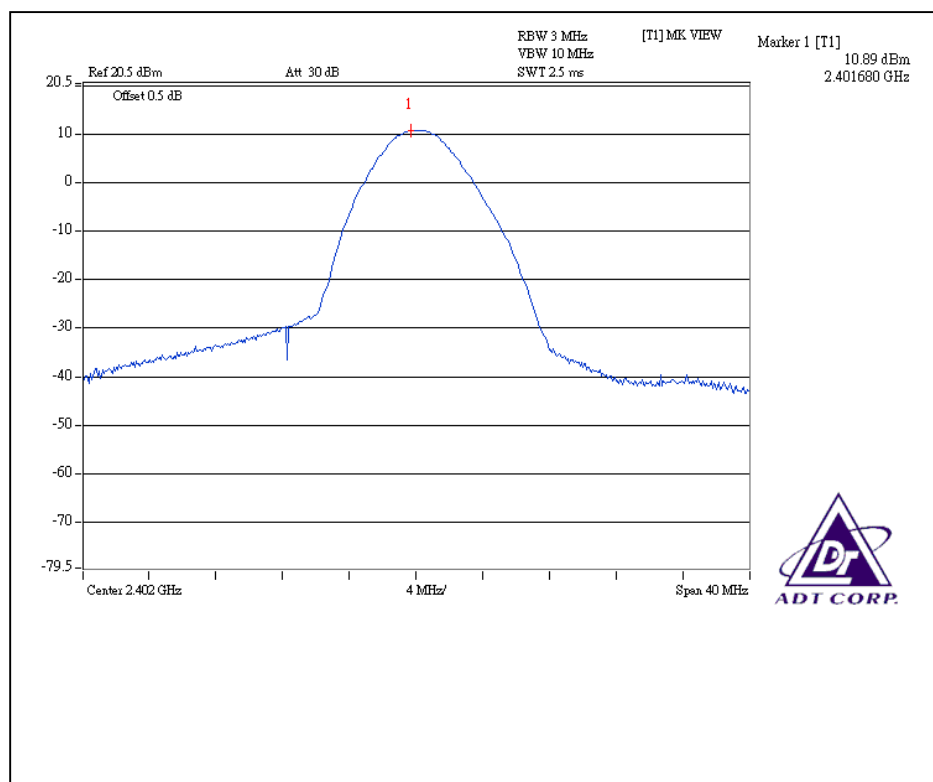

Channel 39

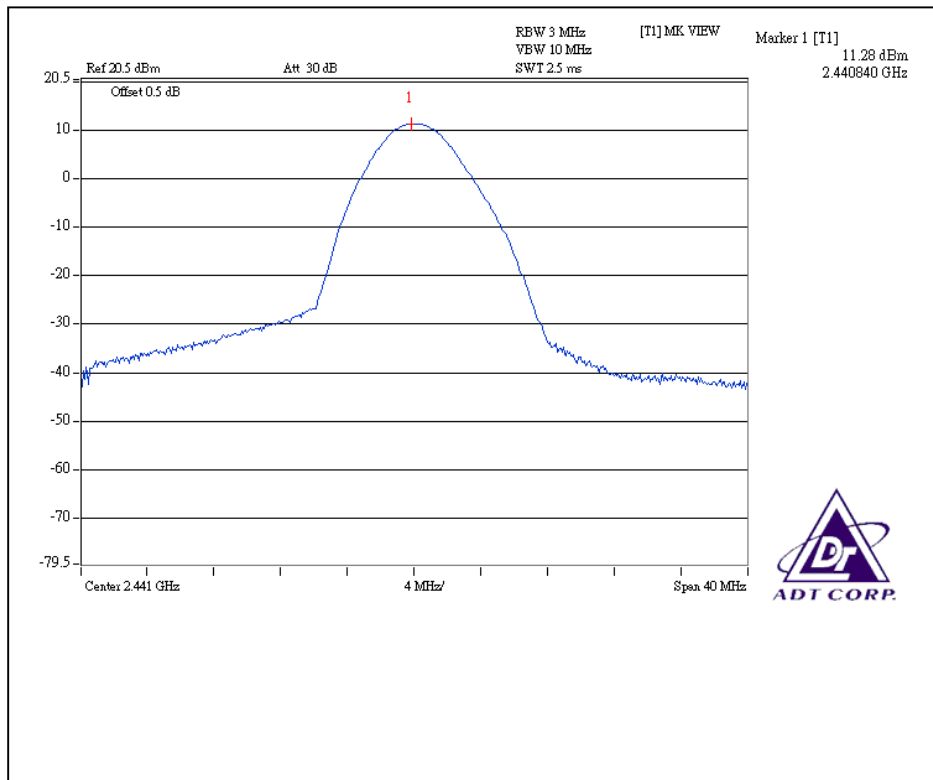

Channel 78

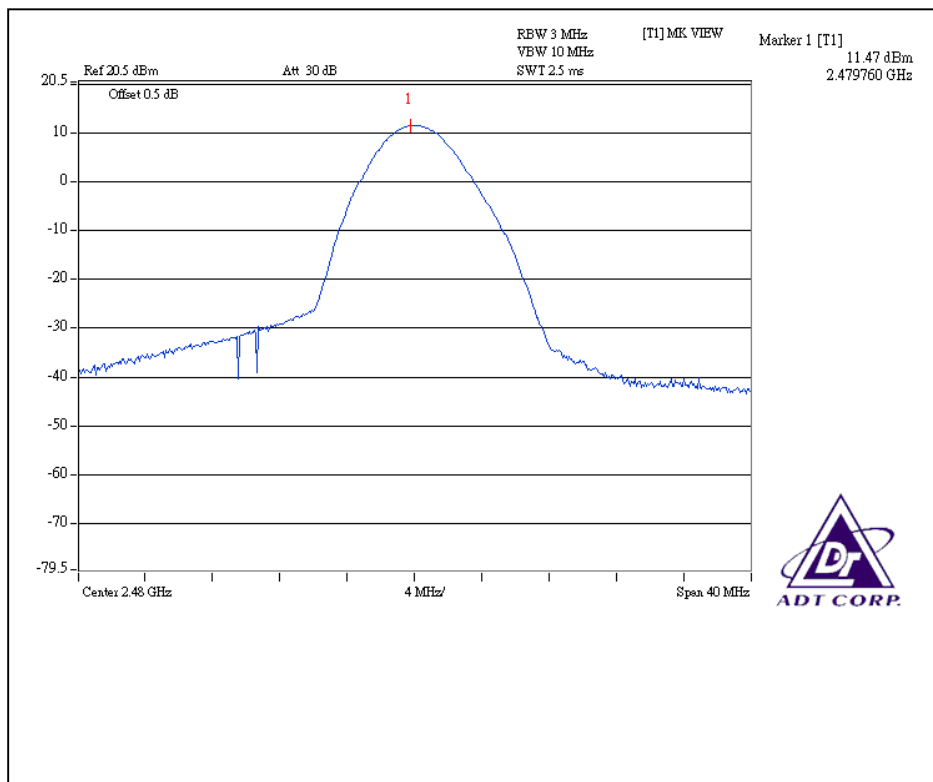

MODULATION TYPE	8DPSK	INPUT POWER (SYSTEM)	120Vac, 60 Hz
ENVIRONMENTAL CONDITIONS	25deg. C, 68%RH, 972 hPa	TESTED BY	Phoenix Huang

CHANNEL	CHANNEL FREQUENCY (MHz)	PEAK POWER OUTPUT (mW)	PEAK POWER OUTPUT (dBm)	PEAK POWER LIMIT (mW)	PASS/FAIL
0	2402	0.537	-2.70	125	PASS
39	2441	0.605	-2.18	125	PASS
78	2480	0.573	-2.42	125	PASS

Channel 0

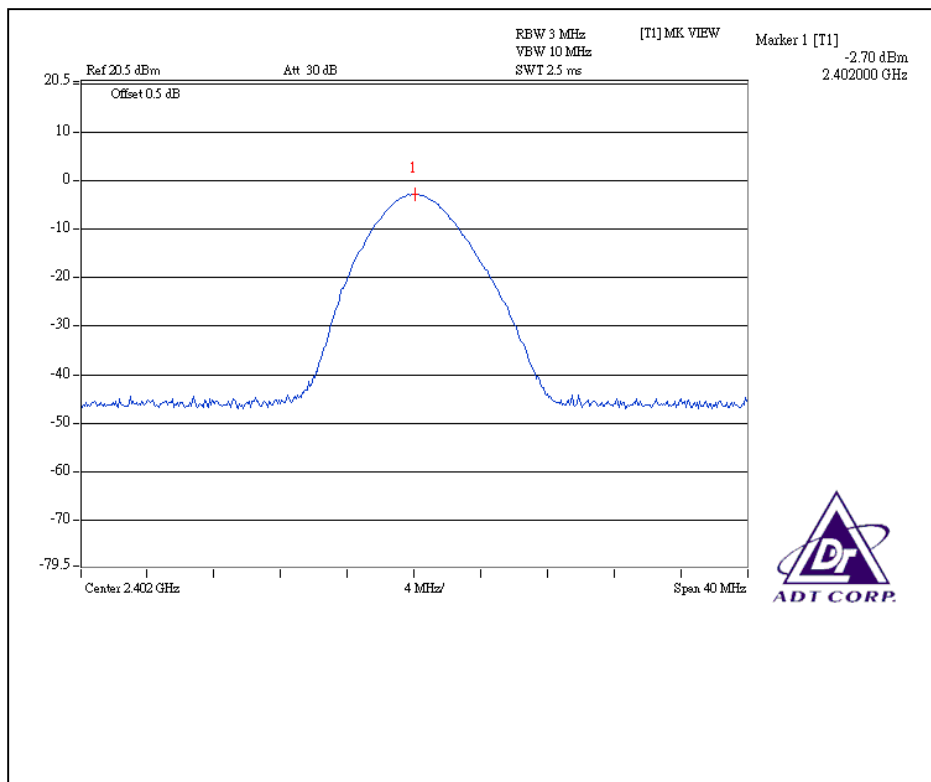

Channel 39

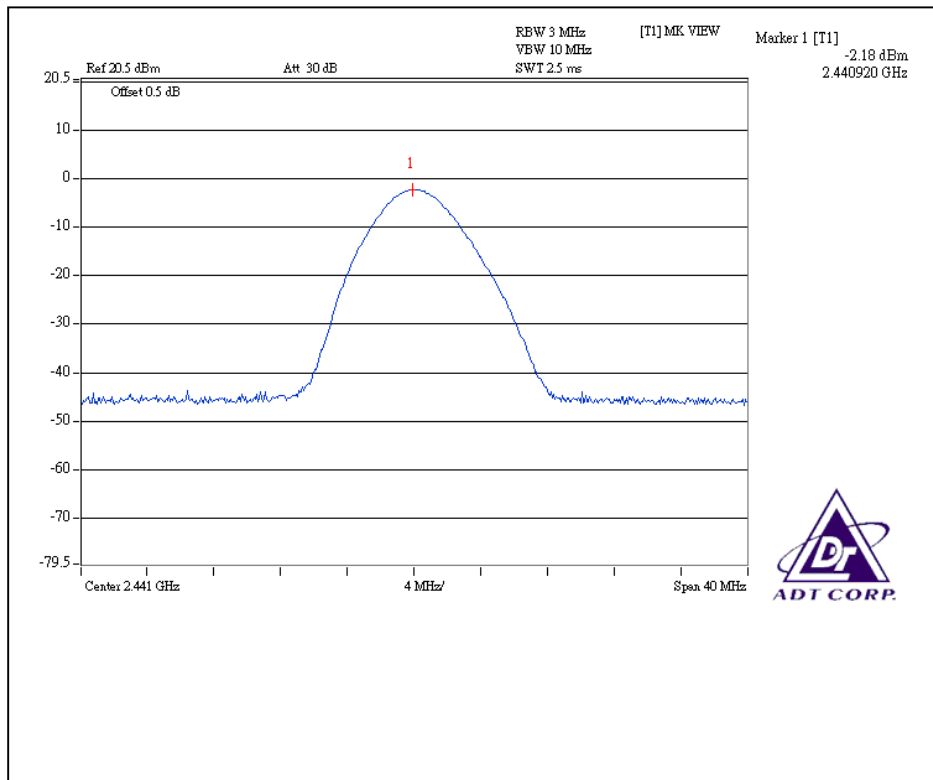

Channel 78

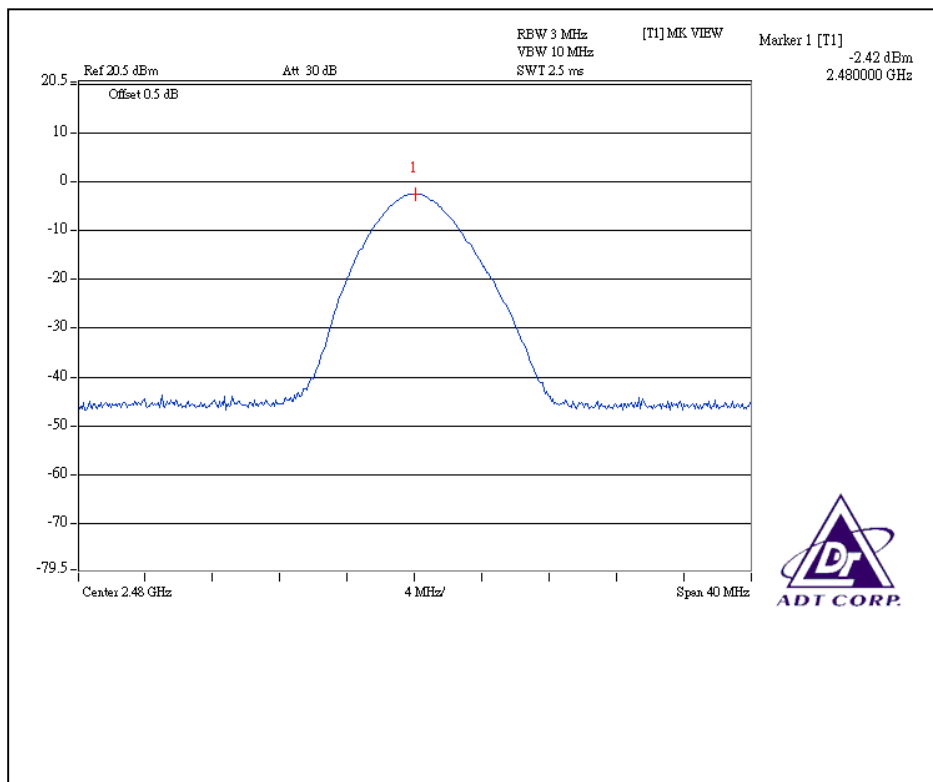

4.7 RADIATED EMISSION MEASUREMENT

4.7.1 LIMITS OF RADIATED EMISSION MEASUREMENT

Emissions radiated outside of the specified bands, shall be according to the general radiated limits in 15.209 as following:

Frequencies (MHz)	Field strength (microvolts/meter)	Measurement distance (meters)
0.009-0.490	2400/F(kHz)	300
0.490-1.705	24000/F(kHz)	30
1.705-30.0	30	30
30-88	100	3
88-216	150	3
216-960	200	3
Above 960	500	3

As shown in 15.35(b), for frequencies above 1000MHz, the field strength limits are based on average detector, however, the peak field strength of any emission shall not exceed the maximum permitted average limits, specified above by more than 20dB under any condition of modulation.

4.7.2 TEST INSTRUMENTS

DESCRIPTION & MANUFACTURER	MODEL NO.	SERIAL NO.	CALIBRATED UNTIL
ADVANTEST Spectrum Analyzer	R3271A	85060311	July 21, 2009
HP Pre_Amplifier	8449B	3008A01922	Oct. 04, 2008
ROHDE & SCHWARZ Test Receiver	ESCS30	100375	Mar. 31, 2009
SCHWARZBECK TRILOG Broadband Antenna	VULB 9168	138	April 29, 2009
Schwarzbeck Horn_Antenna	BBHA9120	D124	Dec. 16, 2008
Schwarzbeck Horn_Antenna	BBHA 9170	BBHA9170153	Jan. 27, 2009
RF Switches (ARNITSU)	CS-201	1565157	Aug. 13, 2008
RF CABLE (Chaintek)	SF102	22054-2	Dec. 06. 2008
RF Cable(RICHTEC)	9913-30M N-N Cable	STCCAB-30M-1 GHz	Aug. 13, 2008
Software	ADT_Radiated_V 7.6.15.8	NA	NA
CHANCE MOST Antenna Tower	AT-100	0203	NA
CHANCE MOST Turn Table	TT-100	0203	NA

- Note: 1. The calibration interval of the above test instruments is 12 months and the calibrations are traceable to NML/ROC and NIST/USA.
 2. The horn antenna, HP preamplifier (model: 8449B) and Spectrum Analyzer (model: R3271A) are used only for the measurement of emission frequency above 1GHz if tested.
 3. The test was performed in ADT Open Site No. C.
 4. The FCC Site Registration No. is 656396.
 5. The VCCI Site Registration No. is R-1626.
 6. The CANADA Site Registration No. is IC 3789C-3.

4.7.3 TEST PROCEDURES

- a. The EUT was placed on the top of a rotating table 0.8 meters above the ground at a 10 meter semi-anechoic chamber. The table was rotated 360 degrees to determine the position of the highest radiation.
- b. The EUT was set 3 meters away from the interference-receiving antenna, which was mounted on the top of a variable-height antenna tower.
- c. The antenna is a broadband antenna, and its height is varied from one meter to four meters above the ground to determine the maximum value of the field strength. Both horizontal and vertical polarizations of the antenna are set to make the measurement.
- d. For each suspected emission, the EUT was arranged to its worst case and then the antenna was tuned to heights from 1 meter to 4 meters and the rotatable table was turned from 0 degrees to 360 degrees to find the maximum reading.
- e. The test-receiver system was set to Peak Detect Function and Specified Bandwidth with Maximum Hold Mode.
- f. If the emission level of the EUT in peak mode was 10 dB lower than the limit specified, then testing could be stopped and the peak values of the EUT would be reported. Otherwise the emissions that did not have 10 dB margin would be re-tested one by one using peak, quasi-peak or average method as specified and then reported in a data sheet.

NOTE:

1. The resolution bandwidth and video bandwidth of test receiver/spectrum analyzer is 120kHz for Peak detection (PK) and Quasi-peak detection (QP) at frequency below 1GHz.
2. The resolution bandwidth is 1MHz and video bandwidth of test receiver/spectrum analyzer is 3MHz for Peak detection at frequency above 1GHz.
3. The resolution bandwidth of test receiver/spectrum analyzer is 1 MHz and the video bandwidth is 10 Hz for Average detection (AV) at frequency above 1GHz.

4.7.4 DEVIATION FROM TEST STANDARD

No deviation

4.7.5 TEST SETUP

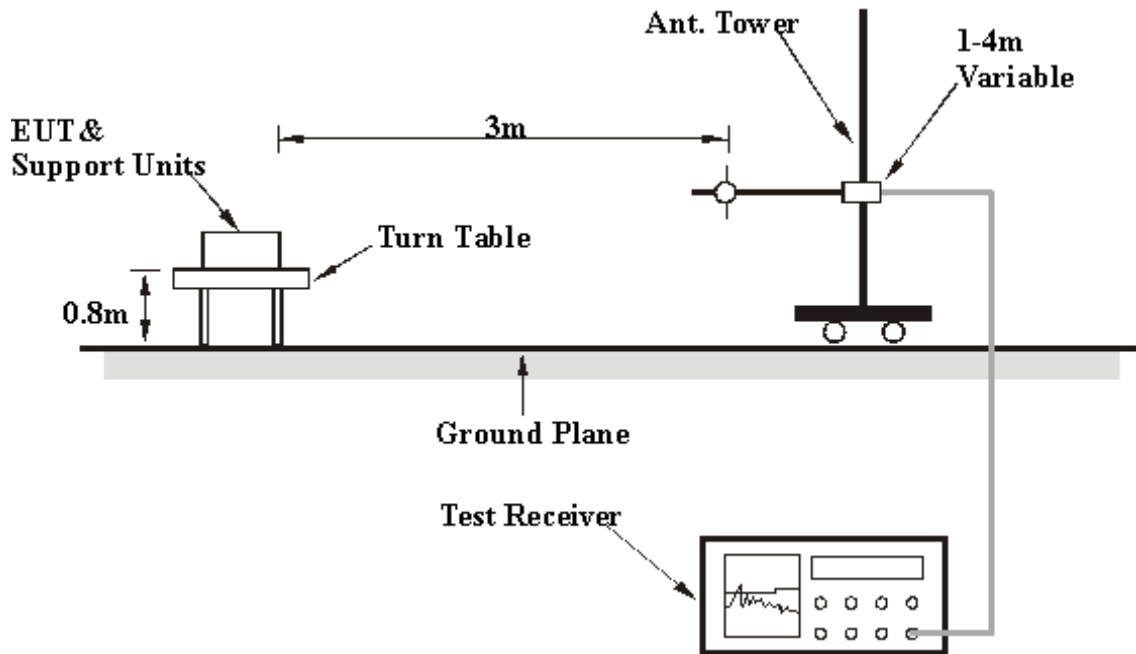

For the actual test configuration, please refer to the related item – Photographs of the Test Configuration.

4.7.6 TEST RESULTS

BELOW 1GHz WORST-CASE DATA : GFSK MODULATION

EUT TEST CONDITION		MEASUREMENT DETAIL	
CHANNEL	Channel 78	FREQUENCY RANGE	Below 1000MHz
INPUT POWER (SYSTEM)	120Vac, 60 Hz	DETECTOR FUNCTION	Quasi-Peak
ENVIRONMENTAL CONDITIONS	24deg. C, 66%RH 972hPa	TESTED BY	Frank Liu

ANTENNA POLARITY & TEST DISTANCE: HORIZONTAL AT 3 M								
NO.	FREQ. (MHz)	EMISSION LEVEL (dBuV/m)	LIMIT (dBuV/m)	MARGIN (dB)	ANTENNA HEIGHT (m)	TABLE ANGLE (Degree)	RAW VALUE (dBuV)	CORRECTION FACTOR (dB/m)
1	240.00	23.52 QP	46.00	-22.48	1.37 H	63	9.49	14.03
2	360.00	22.31 QP	46.00	-23.69	1.52 H	120	3.74	18.57
3	400.00	29.71 QP	46.00	-16.29	1.44 H	179	9.58	20.13
4	480.00	26.53 QP	46.00	-19.47	1.37 H	246	5.46	21.07
5	600.00	29.81 QP	46.00	-16.19	1.22 H	287	6.51	23.30
6	640.03	28.73 QP	46.00	-17.27	1.35 H	346	4.45	24.28
7	720.00	26.54 QP	46.00	-19.46	1.10 H	98	0.36	26.18
8	800.03	24.32 QP	46.00	-21.68	1.09 H	351	-4.13	28.45
9	1000.00	29.43 QP	54.00	-24.57	1.00 H	63	-1.86	31.29
ANTENNA POLARITY & TEST DISTANCE: VERTICAL AT 3 M								
NO.	FREQ. (MHz)	EMISSION LEVEL (dBuV/m)	LIMIT (dBuV/m)	MARGIN (dB)	ANTENNA HEIGHT (m)	TABLE ANGLE (Degree)	RAW VALUE (dBuV)	CORRECTION FACTOR (dB/m)
1	200.00	28.14 QP	43.50	-15.36	1.49 V	80	15.97	12.17
2	360.00	25.31 QP	46.00	-20.69	1.00 V	21	6.74	18.57
3	400.00	32.57 QP	46.00	-13.43	1.00 V	152	12.44	20.13
4	480.00	29.60 QP	46.00	-16.40	1.49 V	1	8.53	21.07
5	600.00	32.01 QP	46.00	-13.99	1.00 V	295	8.71	23.30
6	640.03	33.17 QP	46.00	-12.83	1.00 V	336	8.89	24.28
7	720.00	30.11 QP	46.00	-15.89	1.49 V	1	3.93	26.18
8	800.03	35.73 QP	46.00	-10.27	1.49 V	241	7.28	28.45

- REMARKS:**
1. Emission level (dBuV/m) = Raw Value (dBuV) + Correction Factor (dB/m).
 2. Correction Factor (dB/m) = Antenna Factor (dB/m) + Cable Factor (dB).
 3. The other emission levels were very low against the limit.
 4. Margin value = Emission level – Limit value.

GFSK MODULATION

EUT TEST CONDITION		MEASUREMENT DETAIL	
CHANNEL	Channel 0	FREQUENCY RANGE	1 ~ 25GHz
INPUT POWER (SYSTEM)	120Vac, 60 Hz	DETECTOR FUNCTION	Peak (PK) Average (AV)
ENVIRONMENTAL CONDITIONS	28deg. C, 82%RH 972hPa	TESTED BY	Phoenix Huang

ANTENNA POLARITY & TEST DISTANCE: HORIZONTAL AT 3 M								
NO.	FREQ. (MHz)	EMISSION LEVEL (dBuV/m)	LIMIT (dBuV/m)	MARGIN (dB)	ANTENNA HEIGHT (m)	TABLE ANGLE (Degree)	RAW VALUE (dBuV)	CORRECTION FACTOR (dB/m)
1	2386.16	56.61 PK	74.00	-17.39	1.60 H	6	26.59	30.02
2	2386.16	44.18 AV	54.00	-9.82	1.60 H	6	14.16	30.02
3	*2402.00	106.65 PK			1.55 H	8	76.56	30.09
4	*2402.00	76.65 AV			1.55 H	8	46.56	30.09
5	4804.00	53.54 PK	74.00	-20.46	1.34 H	317	18.13	35.41
6	4804.00	23.54 AV	54.00	-30.46	1.34 H	317	-11.87	35.41
7	7206.00	53.60 PK	74.00	-20.40	1.40 H	56	11.84	41.76
8	7206.00	23.60 AV	54.00	-30.40	1.40 H	56	-18.16	41.76
ANTENNA POLARITY & TEST DISTANCE: VERTICAL AT 3 M								
NO.	FREQ. (MHz)	EMISSION LEVEL (dBuV/m)	LIMIT (dBuV/m)	MARGIN (dB)	ANTENNA HEIGHT (m)	TABLE ANGLE (Degree)	RAW VALUE (dBuV)	CORRECTION FACTOR (dB/m)
1	2388.40	54.23 PK	74.00	-19.77	1.37 V	22	24.20	30.03
2	2388.40	43.04 AV	54.00	-10.96	1.37 V	22	13.01	30.03
3	*2402.00	96.10 PK			1.37 V	21	66.01	30.09
4	*2402.00	66.10 AV			1.37 V	21	36.01	30.09
5	4804.00	53.60 PK	74.00	-20.40	1.47 V	124	18.19	35.41
6	4804.00	23.60 AV	54.00	-30.40	1.47 V	124	-11.81	35.41
7	7206.00	53.80 PK	74.00	-20.20	1.25 V	25	12.04	41.76
8	7206.00	23.80 AV	54.00	-30.20	1.25 V	25	-17.96	41.76

- REMARKS:**
- Emission level (dBuV/m) = Raw Value (dBuV) + Correction Factor (dB/m).
 - Correction Factor (dB/m) = Antenna Factor (dB/m) + Cable Factor (dB).
 - The other emission levels were very low against the limit.
 - Margin value = Emission level – Limit value.
 - * * *: Fundamental frequency.
 - The DH5 packet was the worse case duty cycle for a transmit dwell time on a channel, based upon bluetooth theory the transmitter is on 0.625 * 5 per 296.25 ms per channel. Therefore, the duty cycle correlation factor be equal to: $20\log(3.125 / 100) = -30.1$ dB.
 - Average value = peak reading + $20\log(\text{duty cycle})$.

EUT TEST CONDITION		MEASUREMENT DETAIL	
CHANNEL	Channel 39	FREQUENCY RANGE	1 ~ 25GHz
INPUT POWER (SYSTEM)	120Vac, 60 Hz	DETECTOR FUNCTION	Peak (PK) Average (AV)
ENVIRONMENTAL CONDITIONS	28deg. C, 82%RH 972hPa	TESTED BY	Phoenix Huang

ANTENNA POLARITY & TEST DISTANCE: HORIZONTAL AT 3 M								
NO.	FREQ. (MHz)	EMISSION LEVEL (dBuV/m)	LIMIT (dBuV/m)	MARGIN (dB)	ANTENNA HEIGHT (m)	TABLE ANGLE (Degree)	RAW VALUE (dBuV)	CORRECTION FACTOR (dB/m)
1	*2441.00	109.45 PK			1.55 H	7	79.20	30.25
2	*2441.00	79.45 AV			1.55 H	7	49.20	30.25
3	4882.00	53.34 PK	74.00	-20.66	1.37 H	323	17.79	35.55
4	4882.00	23.34 AV	54.00	-30.66	1.37 H	323	-12.21	35.55
5	7323.00	52.40 PK	74.00	-21.60	1.41 H	49	10.34	42.06
6	7323.00	22.40 AV	54.00	-31.60	1.41 H	49	-19.66	42.06
ANTENNA POLARITY & TEST DISTANCE: VERTICAL AT 3 M								
NO.	FREQ. (MHz)	EMISSION LEVEL (dBuV/m)	LIMIT (dBuV/m)	MARGIN (dB)	ANTENNA HEIGHT (m)	TABLE ANGLE (Degree)	RAW VALUE (dBuV)	CORRECTION FACTOR (dB/m)
1	*2441.00	98.06 PK			1.40 V	88	67.81	30.25
2	*2441.00	69.06 AV			1.40 V	88	38.81	30.25
3	4882.00	53.90 PK	74.00	-20.10	1.15 V	314	18.35	35.55
4	4882.00	23.90 AV	54.00	-30.10	1.15 V	314	-11.65	35.55
5	7323.00	52.50 PK	74.00	-21.50	1.05 V	29	10.44	42.06
6	7323.00	22.50 AV	54.00	-31.50	1.05 V	29	-19.56	42.06

- REMARKS:**
1. Emission level (dBuV/m) = Raw Value (dBuV) + Correction Factor (dB/m).
 2. Correction Factor (dB/m) = Antenna Factor (dB/m) + Cable Factor (dB).
 3. The other emission levels were very low against the limit.
 4. Margin value = Emission level – Limit value.
 5. “ * “: Fundamental frequency.
 6. The DH5 packet was the worse case duty cycle for a transmit dwell time on a channel, based upon bluetooth theory the transmitter is on 0.625 * 5 per 296.25 ms per channel. Therefore, the duty cycle correlation factor be equal to: $20\log(3.125 / 100) = -30.1$ dB.
 7. Average value = peak reading + $20\log(\text{duty cycle})$.

EUT TEST CONDITION		MEASUREMENT DETAIL	
CHANNEL	Channel 78	FREQUENCY RANGE	1 ~ 25GHz
INPUT POWER (SYSTEM)	120Vac, 60 Hz	DETECTOR FUNCTION	Peak (PK) Average (AV)
ENVIRONMENTAL CONDITIONS	28deg. C, 82%RH 972hPa	TESTED BY	Phoenix Huang

ANTENNA POLARITY & TEST DISTANCE: HORIZONTAL AT 3 M								
NO.	FREQ. (MHz)	EMISSION LEVEL (dBuV/m)	LIMIT (dBuV/m)	MARGIN (dB)	ANTENNA HEIGHT (m)	TABLE ANGLE (Degree)	RAW VALUE (dBuV)	CORRECTION FACTOR (dB/m)
1	*2480.00	110.78 PK			1.54 H	7	80.37	30.41
2	*2480.00	80.78 AV			1.54 H	7	50.37	30.41
3	2483.50	72.92 PK	74.00	-1.08	1.55 H	9	42.50	30.42
4	2483.50	51.74 AV	54.00	-2.26	1.55 H	9	21.32	30.42
5	4960.00	53.60 PK	74.00	-20.40	1.22 H	5	17.91	35.69
6	4960.00	23.60 AV	54.00	-30.40	1.22 H	5	-12.09	35.69
7	7440.00	52.70 PK	74.00	-21.30	1.33 H	19	10.34	42.36
8	7440.00	22.70 AV	54.00	-31.30	1.33 H	19	-19.66	42.36
ANTENNA POLARITY & TEST DISTANCE: VERTICAL AT 3 M								
NO.	FREQ. (MHz)	EMISSION LEVEL (dBuV/m)	LIMIT (dBuV/m)	MARGIN (dB)	ANTENNA HEIGHT (m)	TABLE ANGLE (Degree)	RAW VALUE (dBuV)	CORRECTION FACTOR (dB/m)
1	*2480.00	99.04 PK			1.31 V	113	68.63	30.41
2	*2480.00	69.04 AV			1.31 V	113	38.63	30.41
3	2483.50	62.37 PK	74.00	-11.63	1.28 V	99	31.95	30.42
4	2483.50	47.81 AV	54.00	-6.19	1.28 V	99	17.39	30.42
5	4960.00	54.03 PK	74.00	-19.97	1.15 V	297	18.34	35.69
6	4960.00	24.03 AV	54.00	-29.97	1.15 V	297	-11.66	35.69
7	7440.00	52.80 PK	74.00	-21.20	1.81 V	14	10.44	42.36
8	7440.00	22.80 AV	54.00	-31.20	1.81 V	14	-19.56	42.36

- REMARKS:**
1. Emission level (dBuV/m) = Raw Value (dBuV) + Correction Factor (dB/m).
 2. Correction Factor (dB/m) = Antenna Factor (dB/m) + Cable Factor (dB).
 3. The other emission levels were very low against the limit.
 4. Margin value = Emission level – Limit value.
 5. “ * “: Fundamental frequency.
 6. The DH5 packet was the worse case duty cycle for a transmit dwell time on a channel, based upon bluetooth theory the transmitter is on 0.625 * 5 per 296.25 ms per channel. Therefore, the duty cycle correlation factor be equal to: $20\log(3.125 / 100) = -30.1$ dB.
 7. Average value = peak reading + $20\log(\text{duty cycle})$.

8DPSK MODULATION

EUT TEST CONDITION		MEASUREMENT DETAIL	
CHANNEL	Channel 0	FREQUENCY RANGE	1 ~ 25GHz
INPUT POWER (SYSTEM)	120Vac, 60 Hz	DETECTOR FUNCTION	Peak (PK) Average (AV)
ENVIRONMENTAL CONDITIONS	28deg. C, 82%RH 972hPa	TESTED BY	Phoenix Huang

ANTENNA POLARITY & TEST DISTANCE: HORIZONTAL AT 3 M								
NO.	FREQ. (MHz)	EMISSION LEVEL (dBuV/m)	LIMIT (dBuV/m)	MARGIN (dB)	ANTENNA HEIGHT (m)	TABLE ANGLE (Degree)	RAW VALUE (dBuV)	CORRECTION FACTOR (dB/m)
1	2386.16	56.29 PK	74.00	-17.71	1.61 H	10	26.27	30.02
2	2386.16	44.06 AV	54.00	-9.94	1.61 H	10	14.04	30.02
3	*2402.00	96.05 PK			1.69 H	13	65.96	30.09
4	*2402.00	66.05 AV			1.69 H	13	35.96	30.09
5	4804.00	46.73 PK	74.00	-27.27	1.47 H	24	11.32	35.41
6	4804.00	16.73 AV	54.00	-37.27	1.47 H	24	-18.68	35.41
7	7206.00	52.12 PK	74.00	-21.88	1.18 H	156	10.36	41.76
8	7206.00	22.12 AV	54.00	-31.88	1.18 H	156	-19.64	41.76
ANTENNA POLARITY & TEST DISTANCE: VERTICAL AT 3 M								
NO.	FREQ. (MHz)	EMISSION LEVEL (dBuV/m)	LIMIT (dBuV/m)	MARGIN (dB)	ANTENNA HEIGHT (m)	TABLE ANGLE (Degree)	RAW VALUE (dBuV)	CORRECTION FACTOR (dB/m)
1	2386.32	55.65 PK	74.00	-18.35	1.36 V	94	25.62	30.03
2	2386.32	43.08 AV	54.00	-10.92	1.36 V	94	13.05	30.03
3	*2402.00	88.43 PK			1.36 V	94	58.34	30.09
4	*2402.00	58.43 AV			1.36 V	94	28.34	30.09
5	4804.00	46.87 PK	74.00	-27.13	1.40 V	217	11.46	35.41
6	4804.00	16.87 AV	54.00	-37.13	1.40 V	217	-18.54	35.41
7	7206.00	52.25 PK	74.00	-21.75	1.17 V	34	10.49	41.76
8	7206.00	22.25 AV	54.00	-31.75	1.17 V	34	-19.51	41.76

- REMARKS:**
1. Emission level (dBuV/m) = Raw Value (dBuV) + Correction Factor (dB/m).
 2. Correction Factor (dB/m) = Antenna Factor (dB/m) + Cable Factor (dB).
 3. The other emission levels were very low against the limit.
 4. Margin value = Emission level – Limit value.
 5. “ * ”: Fundamental frequency.
 6. The DH5 packet was the worse case duty cycle for a transmit dwell time on a channel, based upon bluetooth theory the transmitter is on 0.625 * 5 per 296.25 ms per channel. Therefore, the duty cycle correlation factor be equal to: $20\log(3.125 / 100) = -30.1$ dB.
 7. Average value = peak reading + $20\log(\text{duty cycle})$.

EUT TEST CONDITION		MEASUREMENT DETAIL	
CHANNEL	Channel 39	FREQUENCY RANGE	1 ~ 25GHz
INPUT POWER (SYSTEM)	120Vac, 60 Hz	DETECTOR FUNCTION	Peak (PK) Average (AV)
ENVIRONMENTAL CONDITIONS	28deg. C, 82%RH 972hPa	TESTED BY	Phoenix Huang

ANTENNA POLARITY & TEST DISTANCE: HORIZONTAL AT 3 M								
NO.	FREQ. (MHz)	EMISSION LEVEL (dBuV/m)	LIMIT (dBuV/m)	MARGIN (dB)	ANTENNA HEIGHT (m)	TABLE ANGLE (Degree)	RAW VALUE (dBuV)	CORRECTION FACTOR (dB/m)
1	*2441.00	85.63 PK			1.37 H	90	55.38	30.25
2	*2441.00	55.63 AV			1.37 H	90	25.38	30.25
3	4882.00	47.23 PK	74.00	-26.77	1.30 H	220	11.68	35.55
4	4882.00	17.23 AV	54.00	-36.77	1.30 H	220	-18.32	35.55
5	7323.00	52.14 PK	74.00	-21.86	1.21 H	17	10.08	42.06
6	7323.00	22.14 AV	54.00	-31.86	1.21 H	17	-19.92	42.06
ANTENNA POLARITY & TEST DISTANCE: VERTICAL AT 3 M								
NO.	FREQ. (MHz)	EMISSION LEVEL (dBuV/m)	LIMIT (dBuV/m)	MARGIN (dB)	ANTENNA HEIGHT (m)	TABLE ANGLE (Degree)	RAW VALUE (dBuV)	CORRECTION FACTOR (dB/m)
1	*2441.00	96.40 PK			1.55 V	5	66.15	30.25
2	*2441.00	66.40 AV			1.55 V	5	36.15	30.25
3	4882.00	47.14 PK	74.00	-26.86	1.55 V	22	11.59	35.55
4	4882.00	17.14 AV	54.00	-36.86	1.55 V	22	-18.41	35.55
5	7323.00	52.08 PK	74.00	-21.92	1.14 V	153	10.02	42.06
6	7323.00	22.08 AV	54.00	-31.92	1.14 V	153	-19.98	42.06

- REMARKS:**
1. Emission level (dBuV/m) = Raw Value (dBuV) + Correction Factor (dB/m).
 2. Correction Factor (dB/m) = Antenna Factor (dB/m) + Cable Factor (dB).
 3. The other emission levels were very low against the limit.
 4. Margin value = Emission level – Limit value.
 5. “ * “: Fundamental frequency.
 6. The DH5 packet was the worse case duty cycle for a transmit dwell time on a channel, based upon bluetooth theory the transmitter is on 0.625 * 5 per 296.25 ms per channel. Therefore, the duty cycle correlation factor be equal to: $20\log(3.125 / 100) = -30.1$ dB.
 7. Average value = peak reading + $20\log(\text{duty cycle})$.

EUT TEST CONDITION		MEASUREMENT DETAIL	
CHANNEL	Channel 78	FREQUENCY RANGE	1 ~ 25GHz
INPUT POWER (SYSTEM)	120Vac, 60 Hz	DETECTOR FUNCTION	Peak (PK) Average (AV)
ENVIRONMENTAL CONDITIONS	28deg. C, 82%RH 972hPa	TESTED BY	Phoenix Huang

ANTENNA POLARITY & TEST DISTANCE: HORIZONTAL AT 3 M								
NO.	FREQ. (MHz)	EMISSION LEVEL (dBuV/m)	LIMIT (dBuV/m)	MARGIN (dB)	ANTENNA HEIGHT (m)	TABLE ANGLE (Degree)	RAW VALUE (dBuV)	CORRECTION FACTOR (dB/m)
1	*2480.00	98.82 PK			1.55 H	8	68.41	30.41
2	*2480.00	68.82 AV			1.55 H	8	38.41	30.41
3	2483.50	62.87 PK	74.00	-11.13	1.55 H	12	32.45	30.42
4	2483.50	52.79 AV	54.00	-1.21	1.55 H	12	22.37	30.42
5	4960.00	46.20 PK	74.00	-27.80	1.57 H	26	10.51	35.69
6	4960.00	16.20 AV	54.00	-37.80	1.57 H	26	-19.49	35.69
7	7440.00	52.00 PK	74.00	-22.00	1.21 H	176	9.64	42.36
8	7440.00	22.00 AV	54.00	-32.00	1.21 H	176	-20.36	42.36
ANTENNA POLARITY & TEST DISTANCE: VERTICAL AT 3 M								
NO.	FREQ. (MHz)	EMISSION LEVEL (dBuV/m)	LIMIT (dBuV/m)	MARGIN (dB)	ANTENNA HEIGHT (m)	TABLE ANGLE (Degree)	RAW VALUE (dBuV)	CORRECTION FACTOR (dB/m)
1	*2480.00	85.16 PK			1.60 V	255	54.75	30.41
2	*2480.00	55.16 AV			1.60 V	255	24.75	30.41
3	2483.50	56.75 PK	74.00	-17.25	1.60 V	255	26.33	30.42
4	2483.50	44.28 AV	54.00	-9.72	1.60 V	255	13.86	30.42
5	4960.00	46.70 PK	74.00	-27.30	1.44 V	223	11.01	35.69
6	4960.00	16.70 AV	54.00	-37.30	1.44 V	223	-18.99	35.69
7	7440.00	52.30 PK	74.00	-21.70	1.18 V	14	9.94	42.36
8	7440.00	22.30 AV	54.00	-31.70	1.18 V	14	-20.06	42.36

- REMARKS:**
1. Emission level (dBuV/m) = Raw Value (dBuV) + Correction Factor (dB/m).
 2. Correction Factor (dB/m) = Antenna Factor (dB/m) + Cable Factor (dB).
 3. The other emission levels were very low against the limit.
 4. Margin value = Emission level – Limit value.
 5. “ * “: Fundamental frequency.
 6. The DH5 packet was the worse case duty cycle for a transmit dwell time on a channel, based upon bluetooth theory the transmitter is on 0.625 * 5 per 296.25 ms per channel. Therefore, the duty cycle correlation factor be equal to: $20\log(3.125 / 100) = -30.1$ dB.
 7. Average value = peak reading + $20\log(\text{duty cycle})$.

4.8 BAND EDGES MEASUREMENT

4.8.1 LIMITS OF BAND EDGES MEASUREMENT

Below -20dB of the highest emission level of operating band (in 100KHz RBW).

4.8.2 TEST INSTRUMENTS

Description & Manufacturer	Model No.	Serial No.	Calibrated Until
R&S SPECTRUM ANALYZER	FSP40	100036	Dec. 17, 2008

Note:

1. The measurement uncertainty is less than $\pm 2.6\text{dB}$, which is calculated as per the NAMAS document NIS81. This uncertainty represents an expanded uncertainty expressed at approximately the 95% confidence level using a coverage factor of $k=2$.
2. The calibration interval of the above test instruments is 12 months and the calibrations are traceable to NML/ROC and NIST/USA.

4.8.3 TEST PROCEDURE

The transmitter output was connected to the spectrum analyzer via a low lose cable. Set RBW a of spectrum analyzer to 100 kHz and VBW of spectrum analyzer to 300 kHz with suitable frequency span including 100 MHz bandwidth from band edge. The band edges was measured and recorded.

4.8.4 DEVIATION FROM TEST STANDARD

No deviation

4.8.5 EUT OPERATING CONDITION

The software provided by client enabled the EUT to transmit and receive data at lowest, middle and highest channel frequencies individually.

4.8.6 TEST RESULTS

The spectrum plots are attached on the following 2 pages. D2 line indicates the highest level, D1 line indicates the 20dB offset below D2. It shows compliance with the requirement in part 15.247(C).

Note - The delta method is only used up to 2 MHz away from the restricted bandage, The radiated emissions which located in other restricted frequency band, the result, please refer to 4.2.

For GFSK MODULATION TYPE:

NOTE (Peak):

The band edge emission plot on the following first page show 61.61dB delta between carrier maximum power and local maximum emission in restrict band (2.3900GHz). The emission of carrier strength list in the test result of channel 0 at the item 4.7 is 106.65dBuV/m, so the maximum field strength in restrict band is $106.65-61.61=45.04$ dBuV/m which is under 74 dBuV/m limit.

The band edge emission plot on the following first page shows 60.78dB delta between carrier maximum power and local maximum emission in restrict band (2.4835GHz). The emission of carrier strength list in the test result of channel 78 at the item 4.7 is 110.78dBuV/m, so the maximum field strength in restrict band is $110.78-60.78=50.00$ dBuV/m which is under 74 dBuV/m limit.

NOTE (Average):

Average value = $45.04-30.00=15.04$ dBuV/m, which is under 54dBuV/m limit.

*The DH5 packet was the worse case duty cycle for a transmit dwell time on a channel, based upon bluetooth theory the transmitter is on $0.625 * 5$ per 296.25 ms per channel. Therefore, the duty cycle be equal to: $20\log(3.125/100)=-30$ dB. Average value = peak reading - 30.00.

Average value = $50.00-30.00=20.00$ dBuV/m, which is under 54dBuV/m limit.

*The DH5 packet was the worse case duty cycle for a transmit dwell time on a channel, based upon bluetooth theory the transmitter is on $0.625 * 5$ per 296.25 ms per channel. Therefore, the duty cycle be equal to: $20\log(3.125/100)=-30$ dB. Average value = peak reading - 30.00.

For GFSK MODULATION TYPE:

CH0

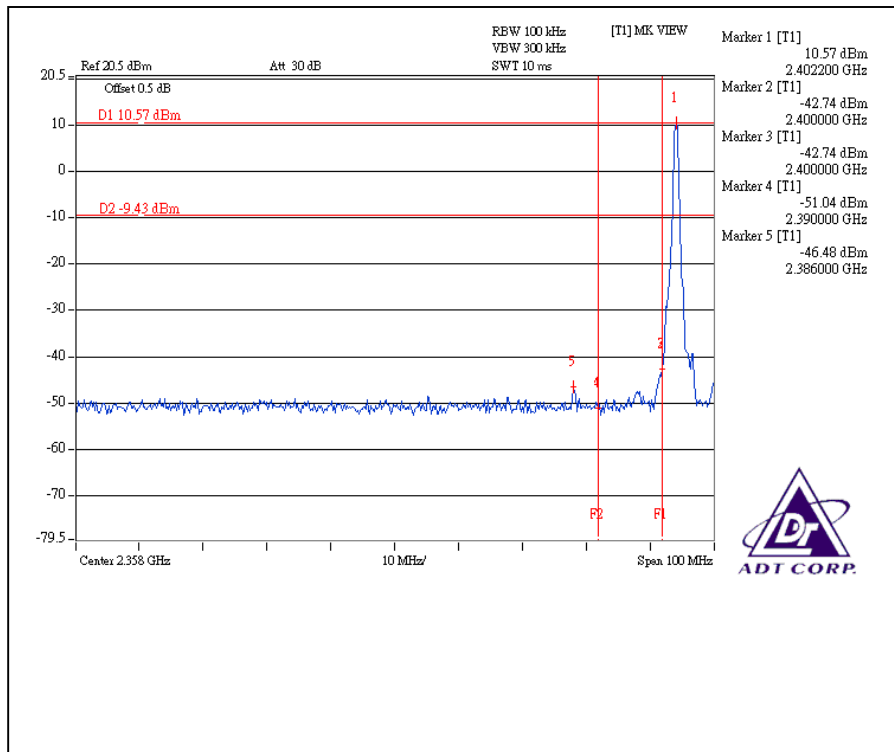

CH78

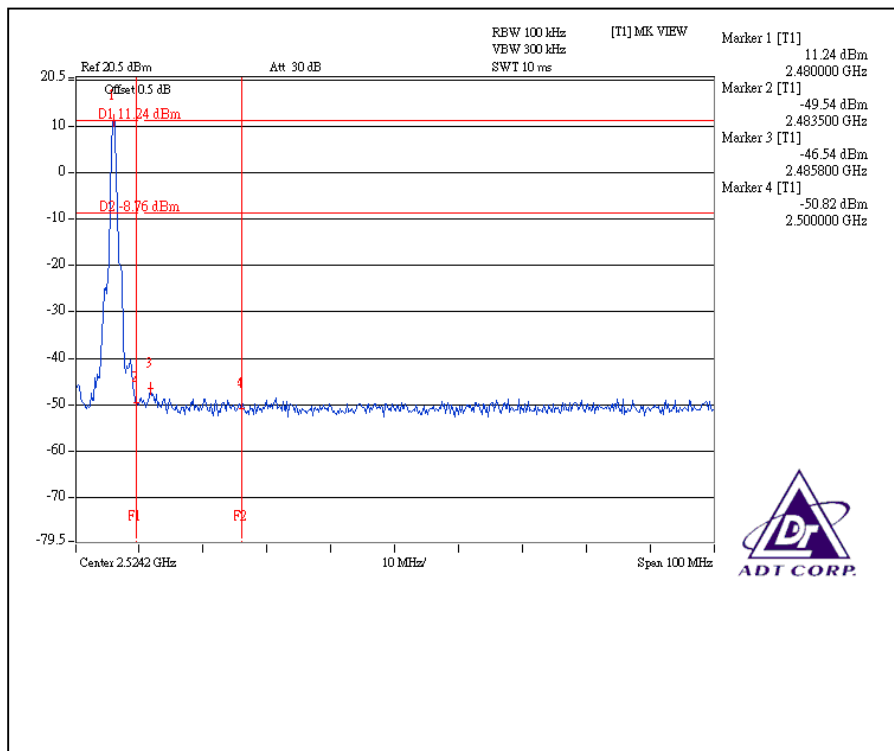

CH0

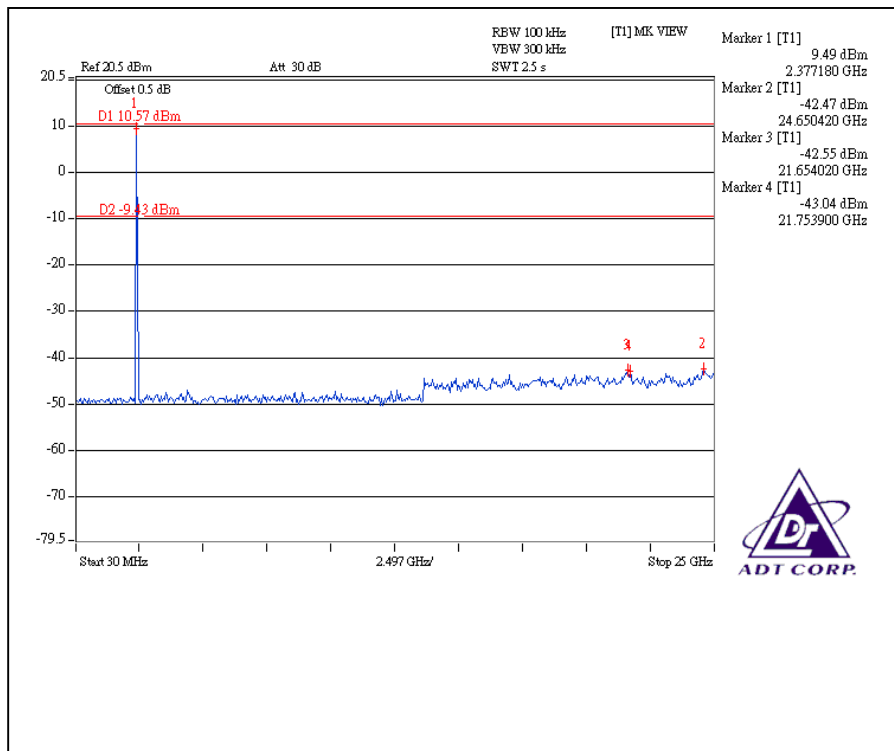

CH78

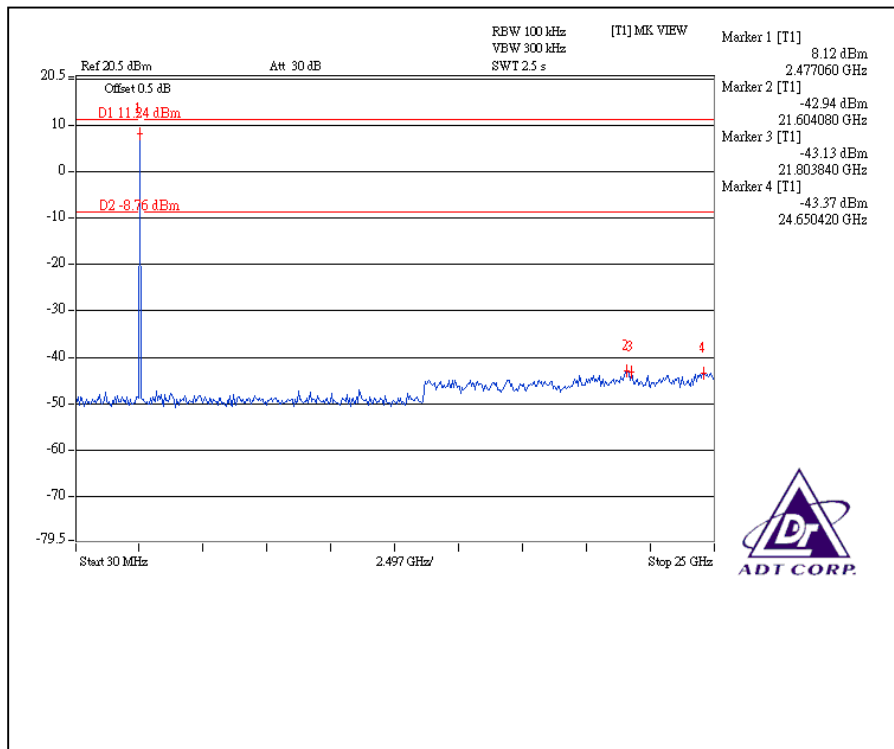

FOR 8DPSK MODULATION TYPE:

NOTE (Peak):

The band edge emission plot on the following first page show 43.57dB delta between carrier maximum power and local maximum emission in restrict band (2.3900GHz). The emission of carrier strength list in the test result of channel 0 at the item 4.2 is 96.05dBuV/m, so the maximum field strength in restrict band is $96.05-43.57=52.48$ dBuV/m which is under 74 dBuV/m limit.

The band edge emission plot on the following first page shows 46.37dB delta between carrier maximum power and local maximum emission in restrict band (2.4835GHz). The emission of carrier strength list in the test result of channel 78 at the item 4.2 is 98.82dBuV/m, so the maximum field strength in restrict band is $98.82-46.37=52.45$ dBuV/m which is under 74 dBuV/m limit.

NOTE (Average):

Average value = $52.48-30.00=22.48$ dBuV/m, which is under 54dBuV/m limit.

*The DH5 packet was the worse case duty cycle for a transmit dwell time on a channel, based upon bluetooth theory the transmitter is on $0.625 * 5$ per 296.25 ms per channel. Therefore, the duty cycle be equal to: $20\log(3.125/100)=-30$ dB. Average value = peak reading - 30.00.

Average value = $52.45-30.00=22.45$ dBuV/m, which is under 54dBuV/m limit.

*The DH5 packet was the worse case duty cycle for a transmit dwell time on a channel, based upon bluetooth theory the transmitter is on $0.625 * 5$ per 296.25 ms per channel. Therefore, the duty cycle be equal to: $20\log(3.125/100)=-30$ dB. Average value = peak reading - 30.00.

FOR 8DPSK MODULATION TYPE:

CH0

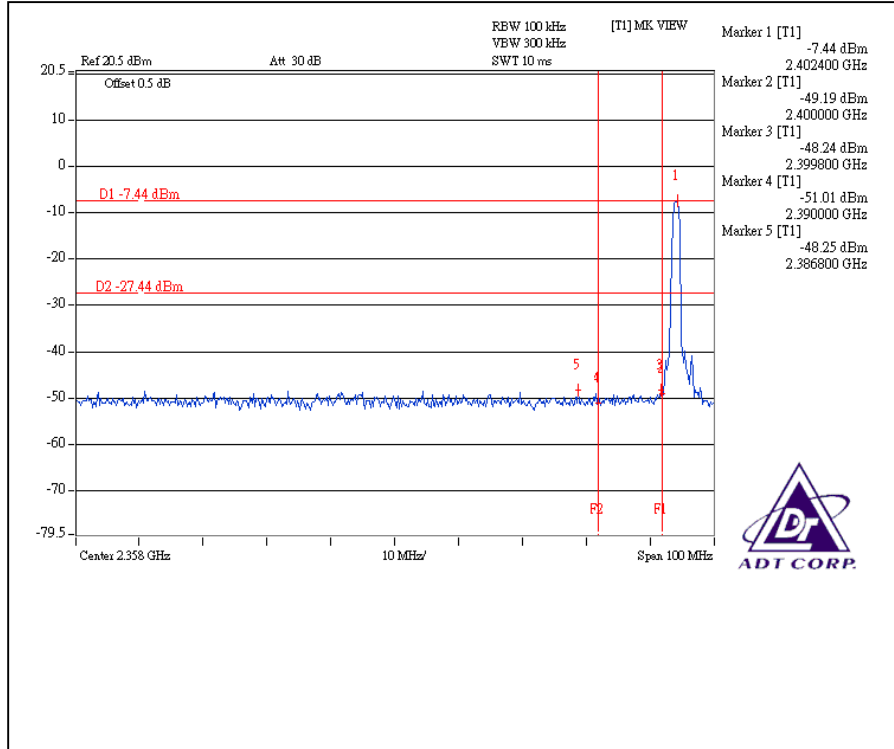

CH78

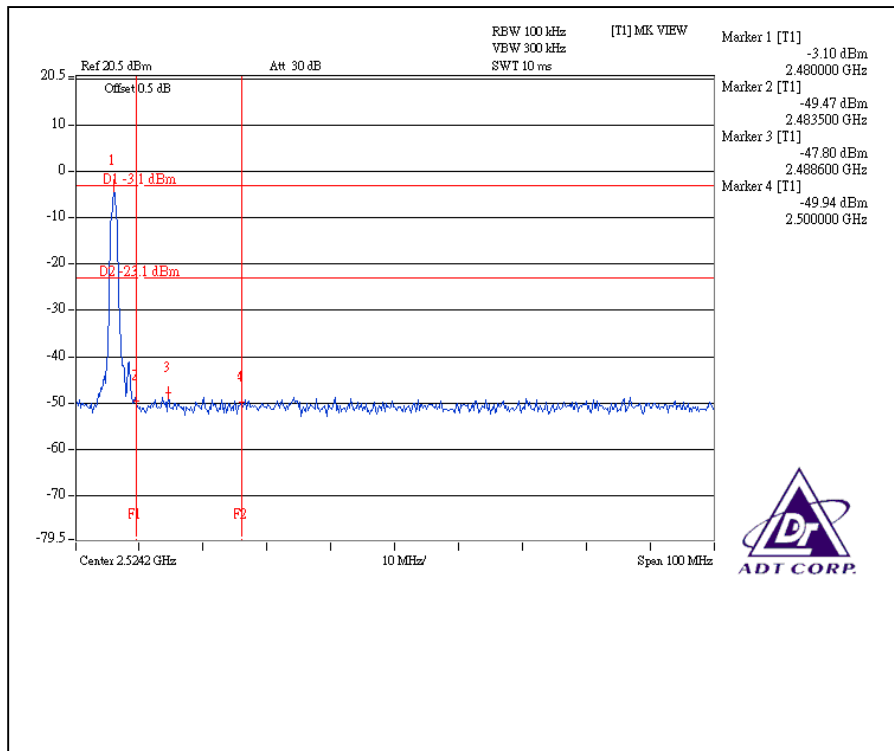

CH0

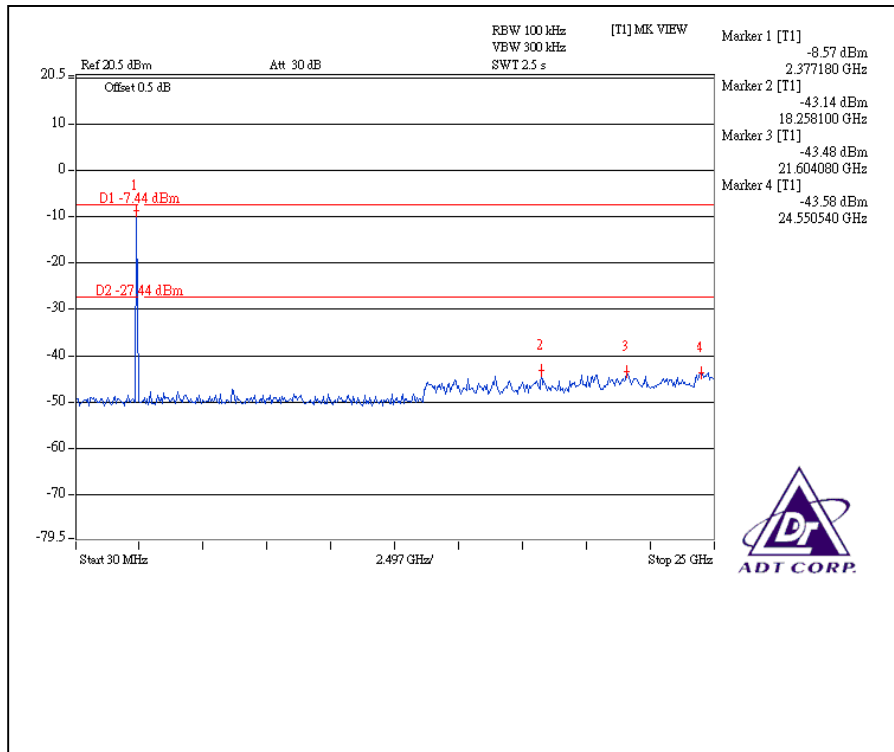

CH78

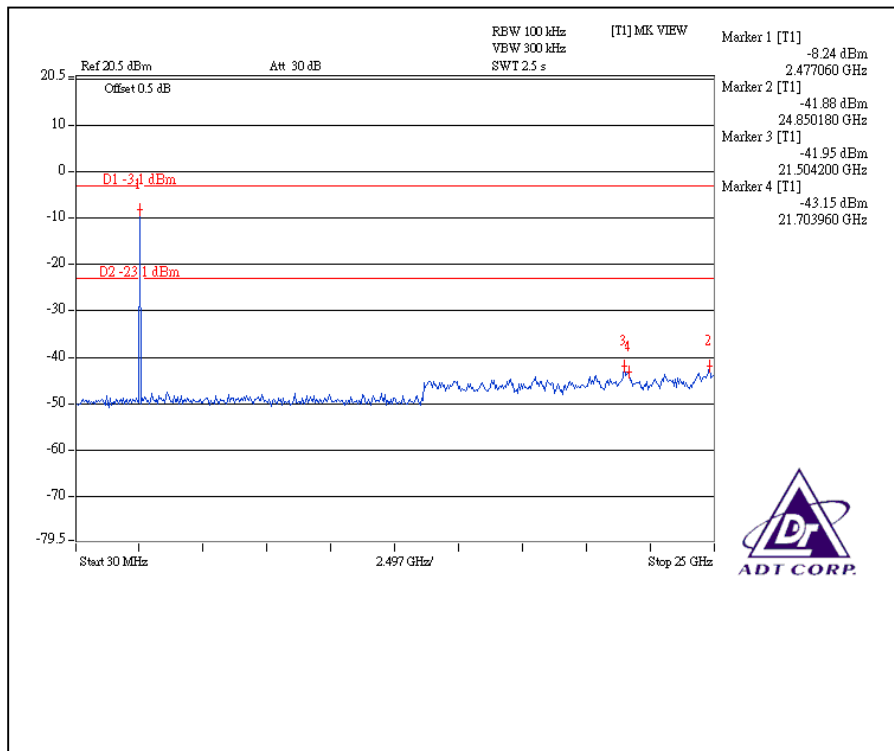

4.9 ANTENNA REQUIREMENT

4.9.1 STANDARD APPLICABLE

For intentional device, according to FCC 47 CFR Section 15.203, an intentional radiator shall be designed to ensure that no antenna other than that furnished by the responsible party shall be used with the device.

And according to FCC 47 CFR Section 15.247 (b), if transmitting antennas of directional gain greater than 6 dBi are used, the power shall be reduced by the amount in dB that the directional gain of the antenna exceeds 6 dBi.

4.9.2 ANTENNA CONNECTED CONSTRUCTION

The antenna used in this product is Built-in printing antenna without connector. The maximum Gain of the antenna is 0dBi.

5 INFORMATION ON THE TESTING LABORATORIES

We, ADT Corp., were founded in 1988 to provide our best service in EMC, Radio, Telecom and Safety consultation. Our laboratories are accredited and approved by the following approval agencies according to ISO/IEC 17025:

USA	FCC, UL
Germany	TUV Rheinland
Japan	VCCI
Norway	NEMKO
Canada	INDUSTRY CANADA, CSA
R.O.C.	TAF, BSMI, NCC
Netherlands	Telefication
Singapore	GOST-ASIA (MOU)
Russia	CERTIS (MOU)

Copies of accreditation certificates of our laboratories obtained from approval agencies can be downloaded from our web site: www.adt.com.tw/index.5/phtml.

If you have any comments, please feel free to contact us at the following:

Linko EMC/RF Lab:

Tel: 886-2-26052180

Fax: 886-2-26052943

Hsin Chu EMC/RF Lab:

Tel: 886-3-5935343

Fax: 886-3-5935342

Hwa Ya EMC/RF/Safety/Telecom Lab:

Tel: 886-3-3183232

Fax: 886-3-3185050

Email: service@adt.com.tw

Web Site: www.adt.com.tw

The address and road map of all our labs can be found in our web site also.

6 APPENDIX A - MODIFICATIONS RECORDERS FOR ENGINEERING CHANGES TO THE EUT BY THE LAB

No any modifications are made to the EUT by the lab during the test.

---END---