

Intentional Radiator Test Report

**Test Standards:
FCC Part 15 (Subpart C – Intentional Radiators)
Industry Canada RSS-210**

**Prepared For:
Socket Communications, Inc.
37400 Central Court
Newark, CA 94560**

**Equipment Under Test:
Compact Flash Wi-Fi Card**

**Model:
GO WI-FI! P500**

**M/N:
8510-00251**

Prepared by:



**44366 S. Grimmer Blvd.
Fremont, CA 94538
USA**

TABLE OF CONTENTS

1. CUSTOMER INFORMATION	3
2. EUT AND ACCESSORY INFORMATION	4
3. SUMMARY OF TEST RESULTS	5
4. STANDARDS AND MEASUREMENT METHODS	6
5. TEST SETUPS	7
6. TEST RESULTS	9
7. TEST EQUIPMENT	47

1.0 CUSTOMER INFORMATION

Test Laboratory:	EMCE Engineering 44366 S. Grimmer Blvd. Fremont, CA 94538 USA Tel: 510-490-4307 Fax: 510-490-3441 bob@universalcompliance.com
FCC registration number	0007-1981-20
Customer:	Socket Communications, Inc. 37400 Central Court Newark, CA Tel: 510-744-2700 Fax: 510-744-2701
Contact Person:	Bob Miller
Receipt of EUT:	3/20/06
Test plan reference:	FCC Part 2, 15 (15.247) / IC RSS-210
FCC ID:	LUB-80211GCF
IC #:	2529A-80211GCF
Date of testing:	3/25/06 – 6/25/06
Date of Report:	7/6/06

The tests listed in this report have been completed to demonstrate compliance to the CFR 47 Section 15.247, as well as Industry Canada Radio Standard RSS-210, Issue 5.

Contents approved:

Name: Bob Cole Title: President

2.0 EUT AND ACCESSORY INFORMATION

EUT description

The EUT is a Socket Communications, Inc. **Compact Flash WiFi Card, M/N: GO WI-FI! P500.**

EUT and accessories

The table below lists all EUTs and accessories used in the tests. Later in this report, only numbers in the last column are used to refer to the devices in each test.

Software

The computers were equipped with test software provided by the customer. The software was used to control the EUT in the tests.

	Name	Type	S/N	Number
EUT	CF Wi-Fi Card	GO WI-FI! P500	N/A	E0001
Accessories	Laptop Computer	Compaq Presario M/N: 1694	3882A744	S0001
Software	MediaTek	WLAN RF Test	N/A	N/A

EUT Information

Product Specification	Description
Model Name	GO WI-FI! P500
Type of Modulation	DSS
Number of Channels	13
Operating Frequency Range	2480 – 2483.5 MHz
Type of Equipment	Portable
Extreme Operating Temperature Range	-20 C – 55 C
Extreme Operating Voltage Range	108 – 132 VAC
Type of Antenna	Integral
Antenna Gain (dBi)	-3.0
Transmitter Method of Frequency Generation	Synthesized
Transmitter Aggregate Data Rate	>250kbps
Transmitter Duty Type	Intermittant
Transmitter Duty Cycle	
Continuous Operation for Testing Purposes?	Yes
Transmit Emissions Designator	

3.0 SUMMARY OF TEST RESULTS

	Section in CFR 47	Results
15.245 (b)(1)	Peak output power (Radiated Emissions)	PASSED
R&O 97-114	Power Density	PASSED
15.247 (a)(2)	6 dB Bandwidth	PASSED
15.247, c	Band-edge compliance of RF emissions	PASSED
15.247, (4)(c)	Restricted Band	PASSED
15.247,c	Spurious radiated emissions	PASSED

PASS The EUT passed that particular test.
FAIL The EUT failed that particular test.

4.0 STANDARDS AND MEASUREMENT METHODS

The tests were performed in guidance of CFR 47 section 15.247, FCC Public Notice DA 00-705 (March 30, 2000), FCC Report & Order 97-114 (April 10, 1997), and ANSI C63.4 (2003). Deviations, modifications or clarifications (if any) to above mentioned documents are written in each section under “Test method”. For the test equipment, see device list in the end of this test.

4.1 Selection of operation mode for tests

Before tests, several operation modes, and modulation patterns were tried. The worst case was selected for each test and those results reported.

5.0 TEST SETUPS

To fulfill all requirements for the testing, total of two different test setups were used. One EUT was used, unmodified for radiated tests.

SMA connector added in place of internal antenna for Antenna Conducted measurements.

Setup A (Antenna Conducted measurements)

Operational description

ANTENNA CONDUCTED EMISSIONS MEASUREMENTS

The EUT was connected to the Laptop Computer through the serial port (COM1), the antenna bypassed and the SMA Cable connected to the Spectrum Analyzer. This setup was used for the **PEAK POWER OUTPUT, POWER DENSITY, 6 dB BW, BAND-EDGE COMPLIANCE, and RESTRICTED BAND** measurements.

Block Diagram

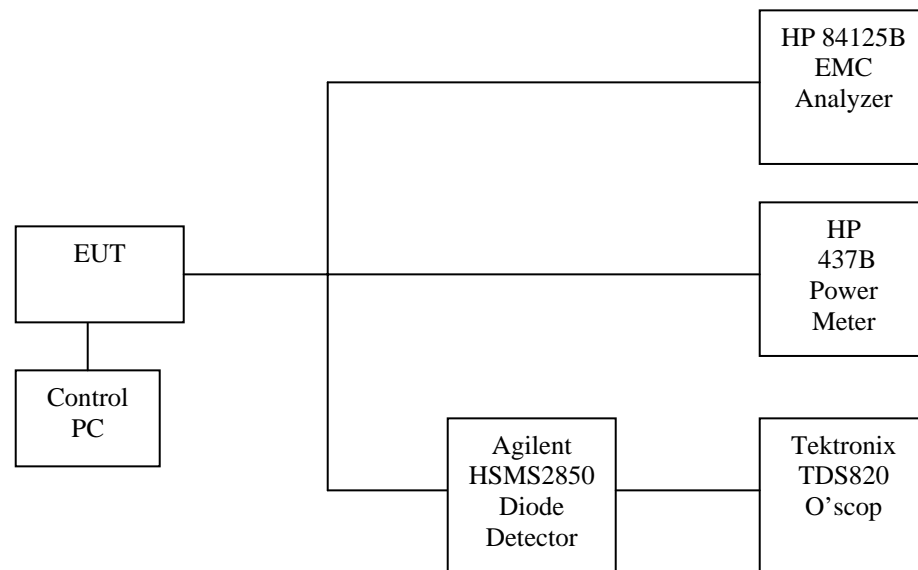

The solid lines are coaxial cables and the dashed lines are either EUT insertion to the test board or control cables between test setup devices. The measurement results were adjusted with the attenuation of the coaxial cable.

Setup B (Radiated measurements)

Operational description

RADIATED EMISSIONS MEASUREMENTS

This setup was used in radiated emissions measurements.

The EUT was tested in 3 orthogonal orientations.

Worst case data is presented.

THIS SETUP USED FOR *RADIATED SPURIOUS EMISSIONS*

Block diagram

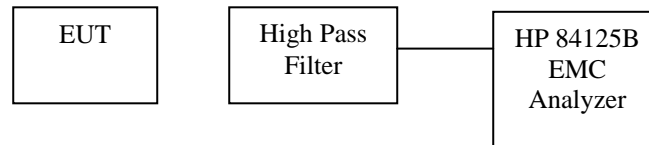

Note: The high –pass filter is used for the Radiated Spurious emissions above 2.4835 GHz. A pass-thru connector is used for Radiated Spurious emissions measurements from 30 MHz – 2.4 GHz.

The solid lines are coaxial cables and the dashed lines are either EUT insertion to the test board or control cables between test setup devices.

6.0 TEST RESULTS

The measurement results were adjusted for the attenuation of the cable between the EUT connector and receiver.

PEAK OUTPUT POWER

Peak Output Power [CFR 47, 15.247(b)(1) and RSS-210 6.2.2(o)]

EUT	GO WI-FI! P500
Test setup	A (conducted)
Temp, Humidity, Air Pressure	68° F, 30.28
Date of Measurement	6/23/06
Measured by	Bob Cole
Result	PASSED

Limits and results

PEAK OUTPUT POWER

EUT Channel	Limit (dBm)	Test results (dBm)
2412	30.0	18.86
2437	30.0	18.86
2467	30.0	17.85

Note: 0 dBm = 107 dBuV

Screen shots

Plot 1: Peak output power 2412 MHz / 6 Mbit Modulation

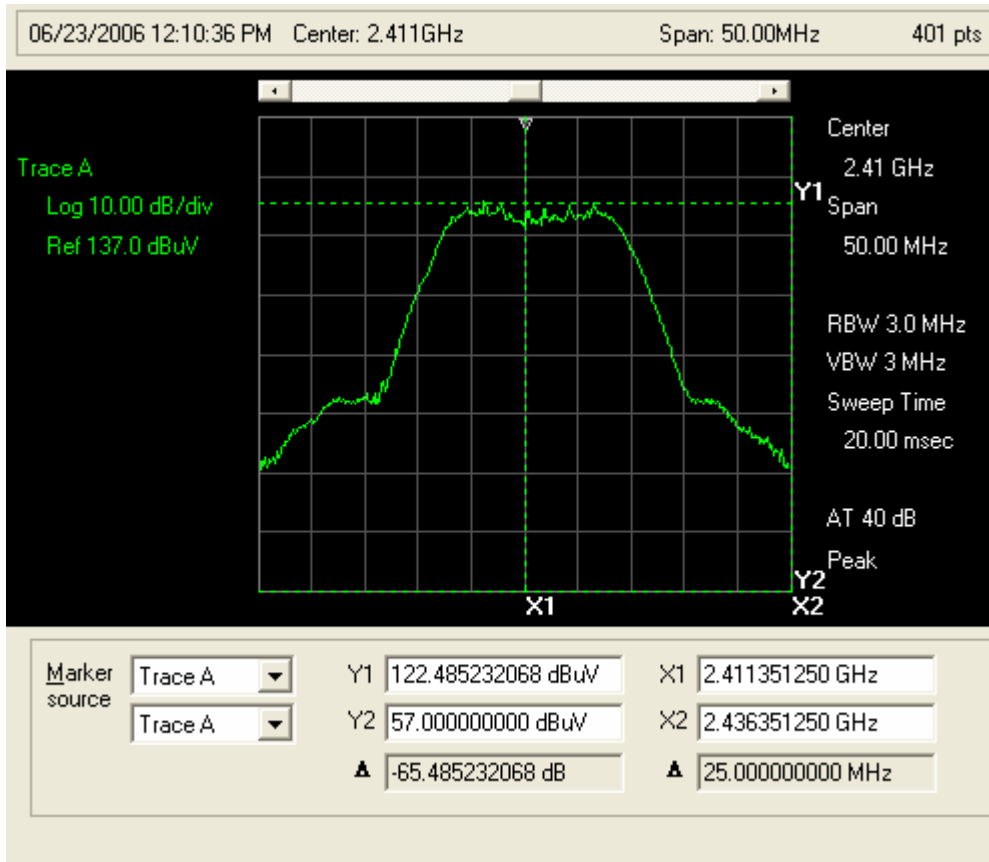

Plot 2: Peak output power 2412 MHz / 11 Mbit Modulation

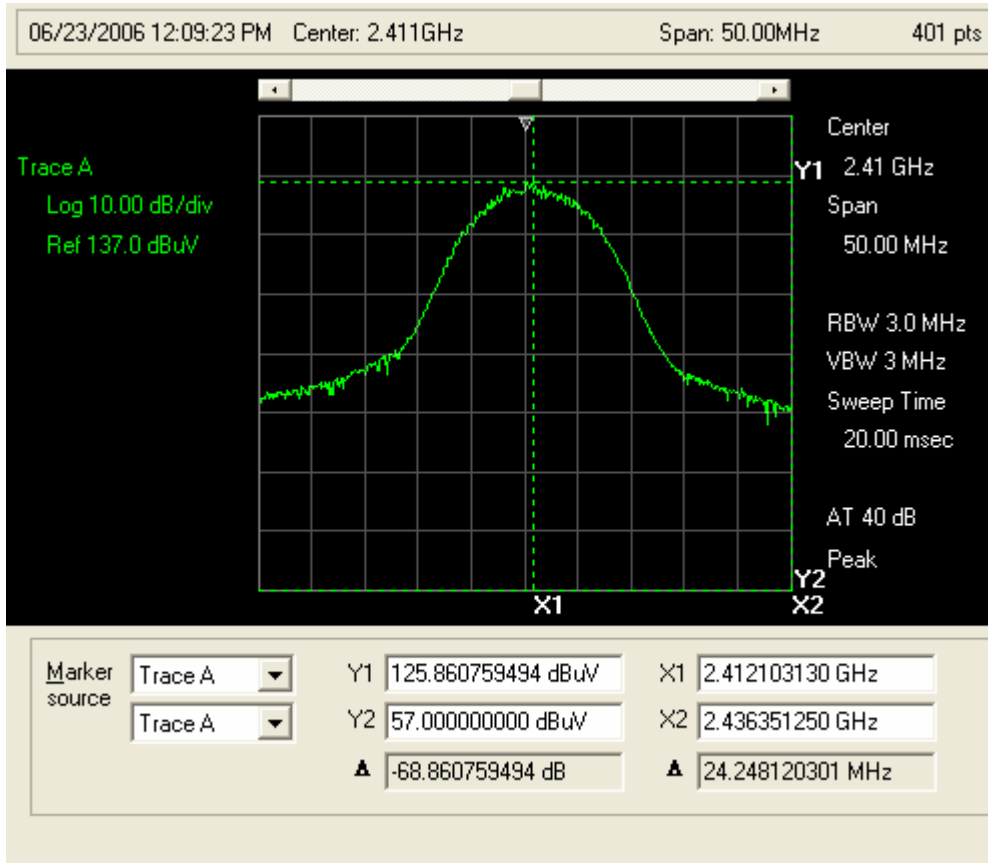

Plot 3: Peak output power 2437 MHz / 6 Mbit Modulation

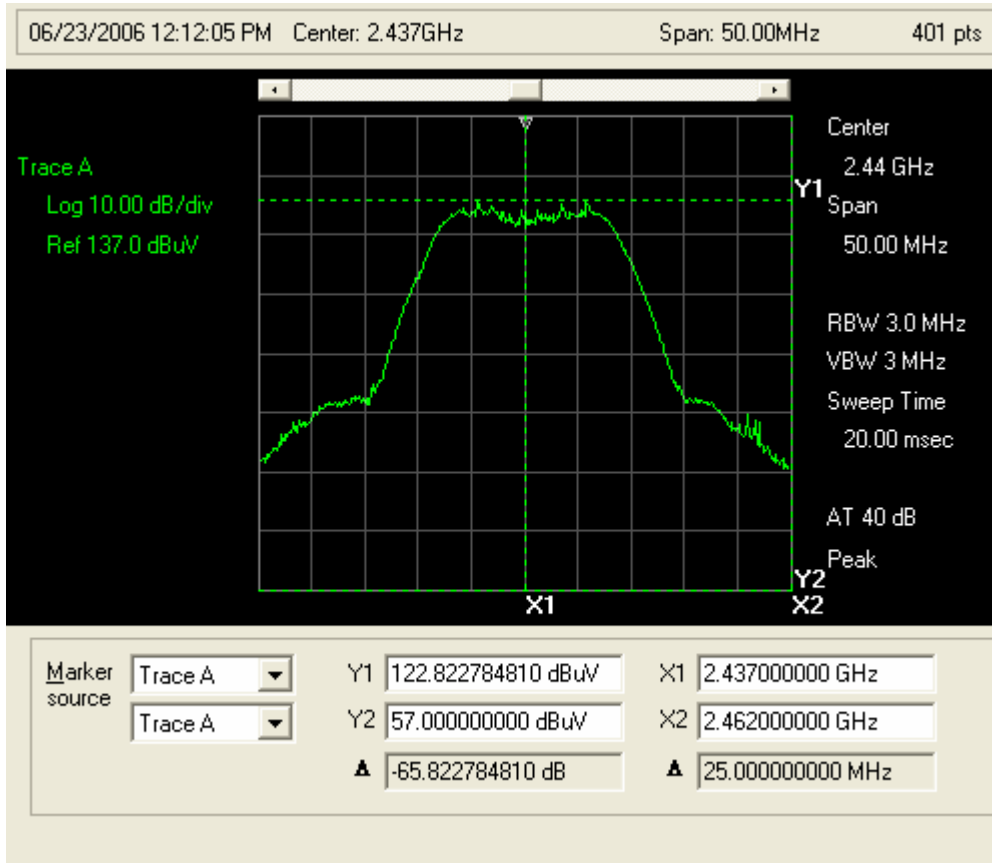

Plot 4: Peak output power 2437 MHz / 11 Mbit Modulation

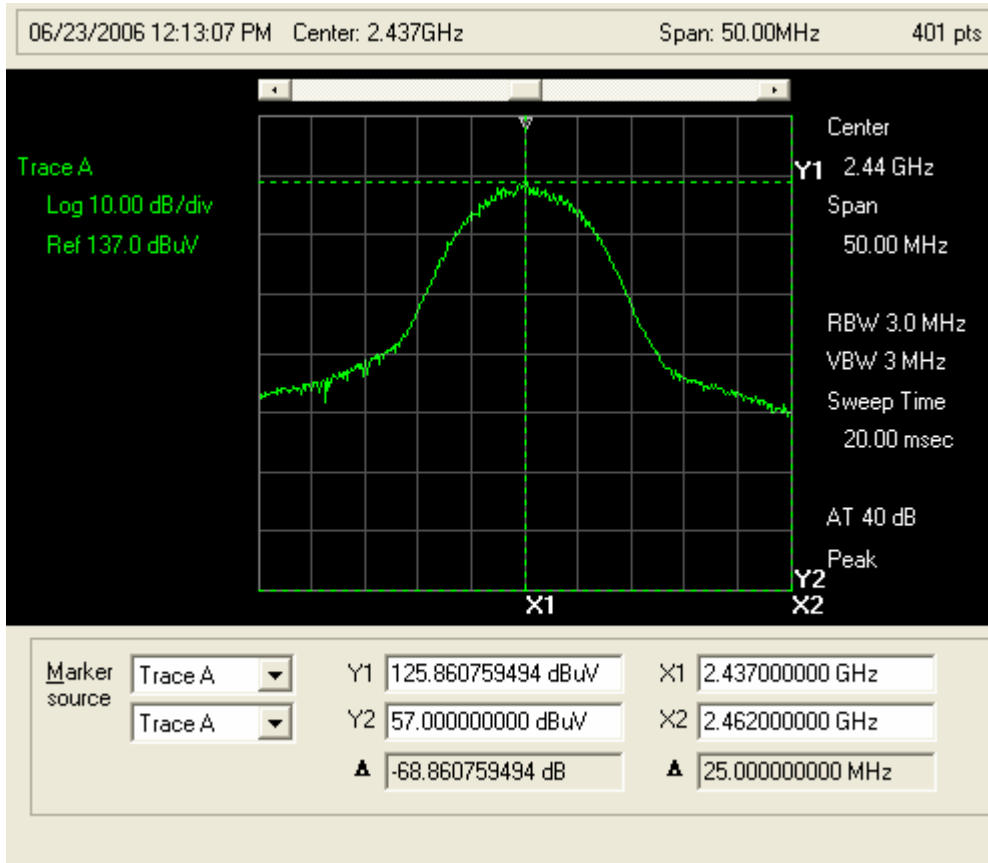

Plot 5: Peak output power 2467 MHz / 6 Mbit Modulation

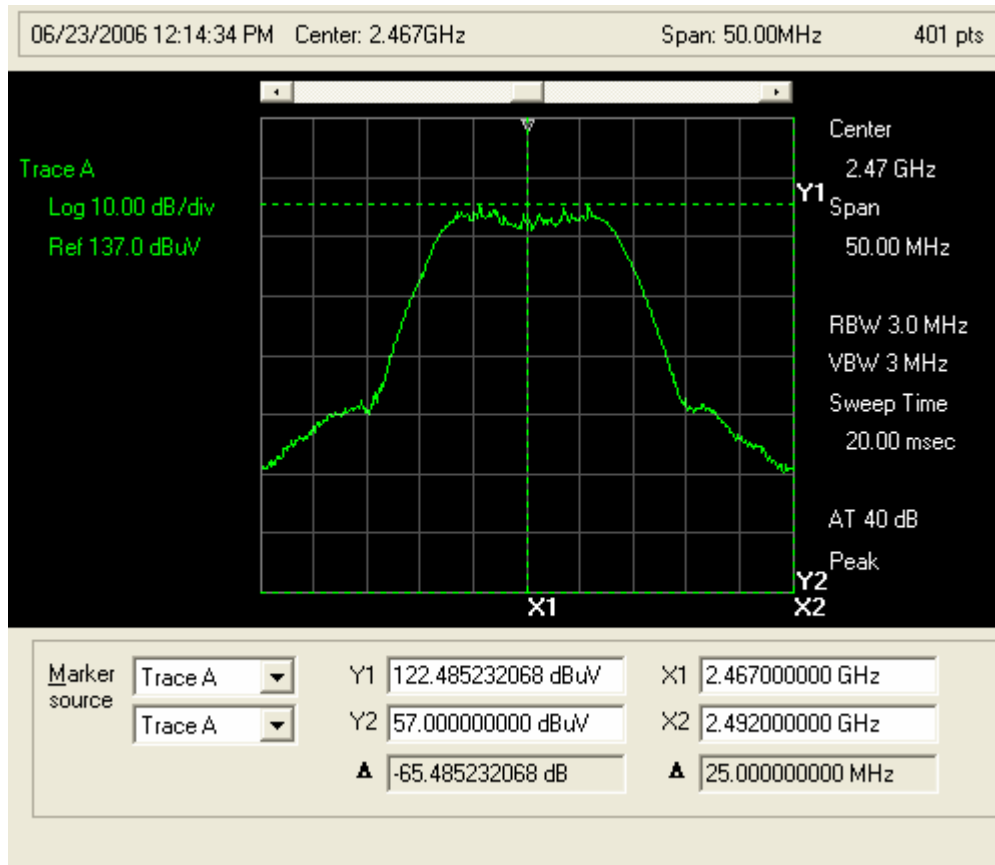

Plot 6: Peak output power 2467 MHz / 11 Mbit Modulation

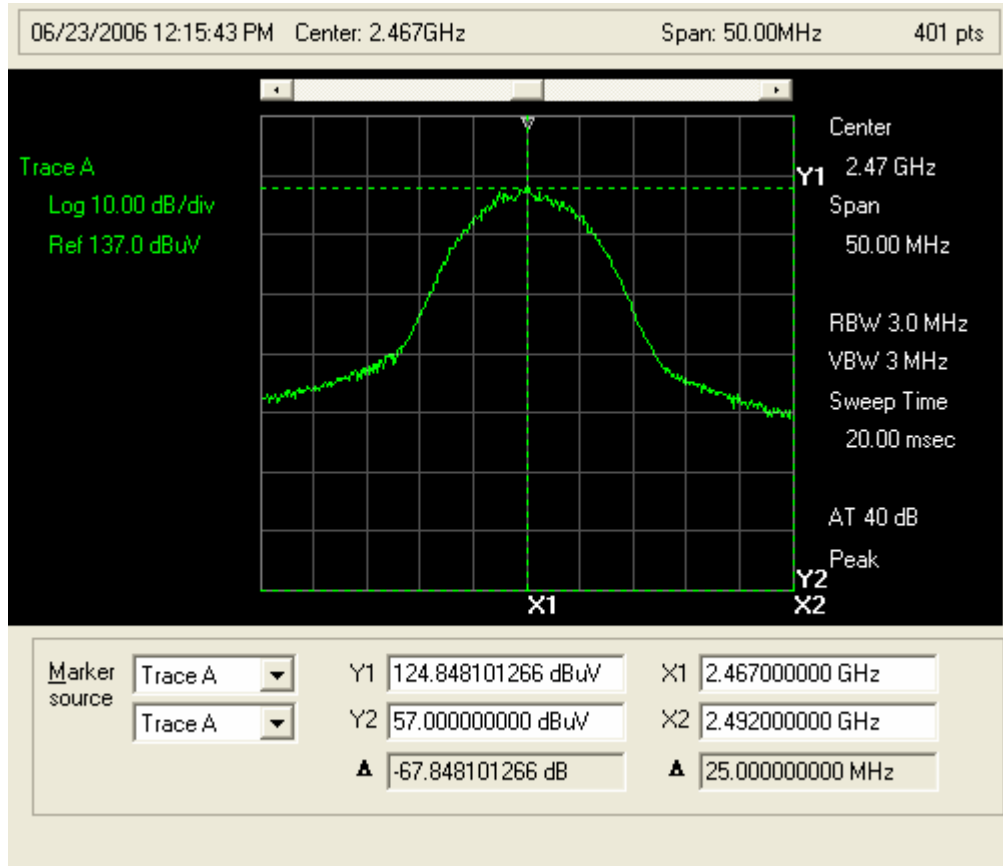

POWER DENSITY

Peak Output Power [R&O 97-114]

EUT	GO WI-FI! P500
Test setup	A (conducted)
Temp, Humidity, Air Pressure	68° F, 30.28
Date of Measurement	6/23/06
Measured by	Bob Cole
Result	PASSED

Limits and results

POWER DENSITY

EUT Channel	Limit (dBm)	Test results (dBm)
2	8.0	-6.54
40	8.0	-7.82
80	8.0	-7.22

Note: 0 dBm = 107 dBuV

Plot 7: Power Density 2412 MHz / 6 Mbit Modulation

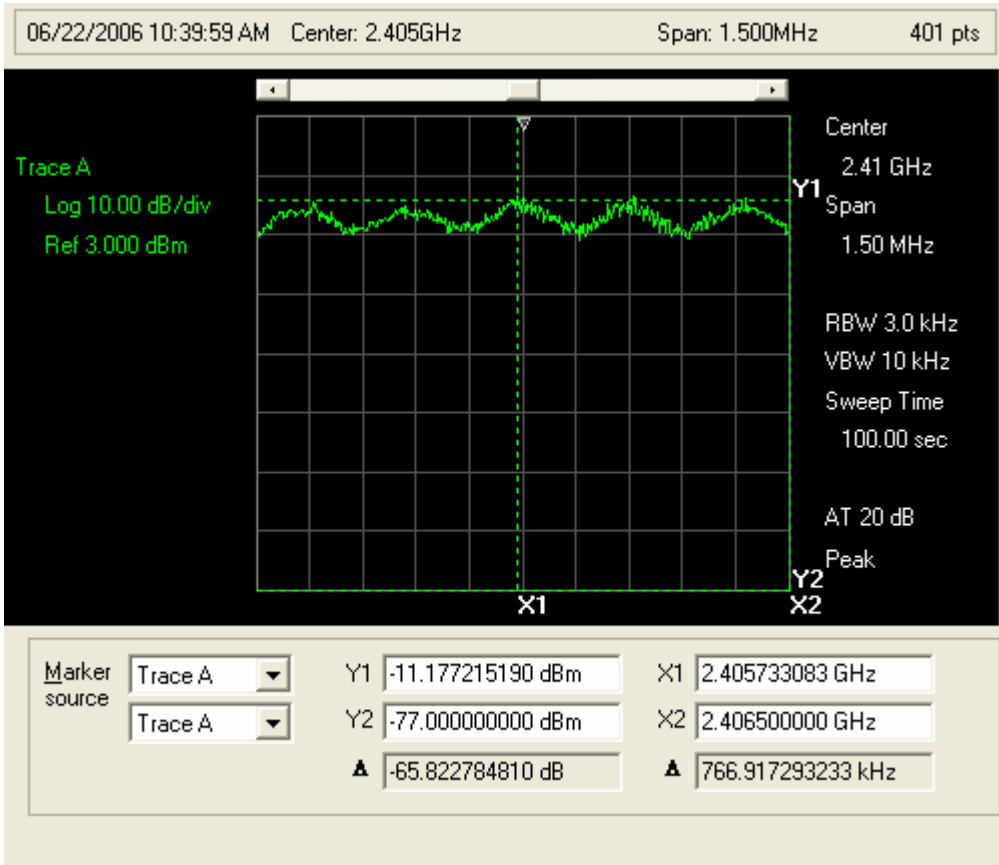

Plot 8: Power Density 2412 MHz / 11 Mbit Modulation

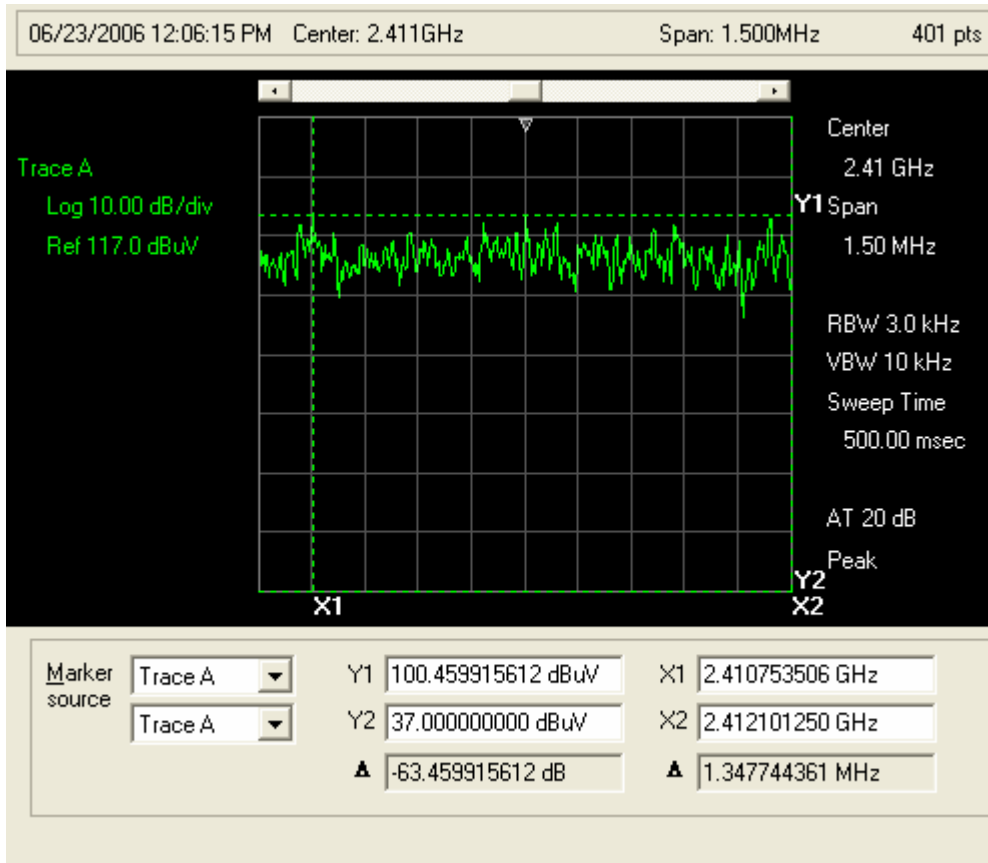

Plot 9: Power Density 2437 MHz / 6 Mbit Modulation

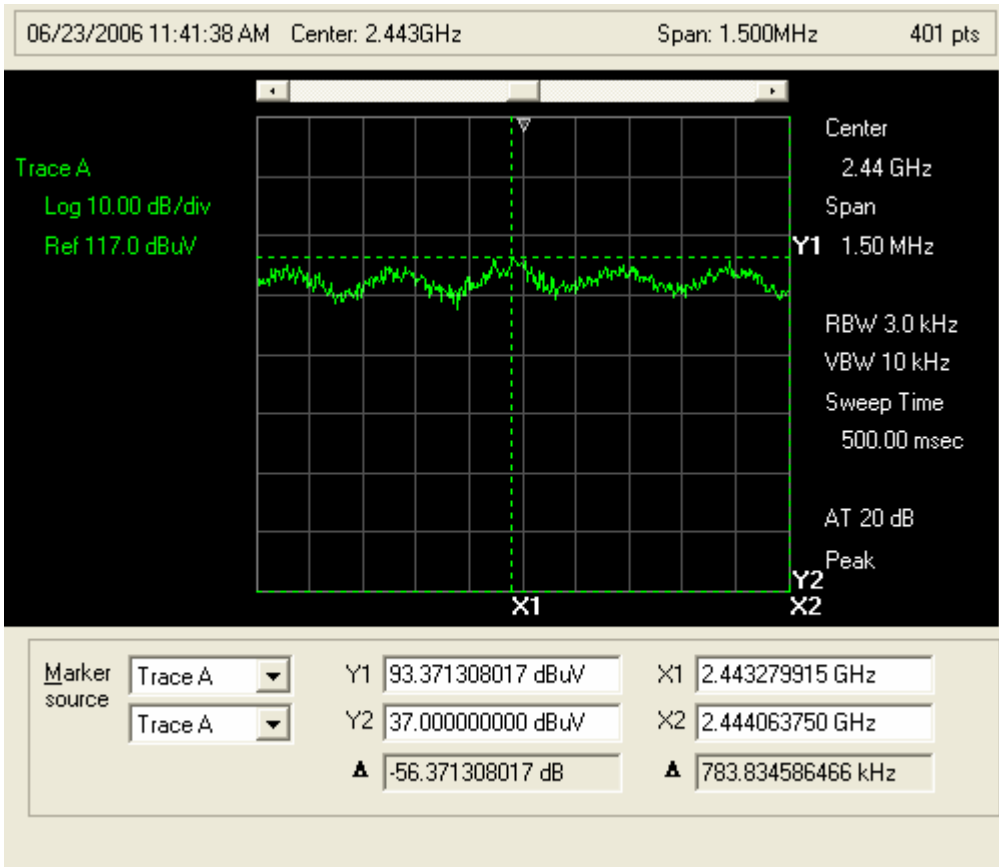

Plot 10: Power Density 2437 MHz / 11 Mbit Modulation

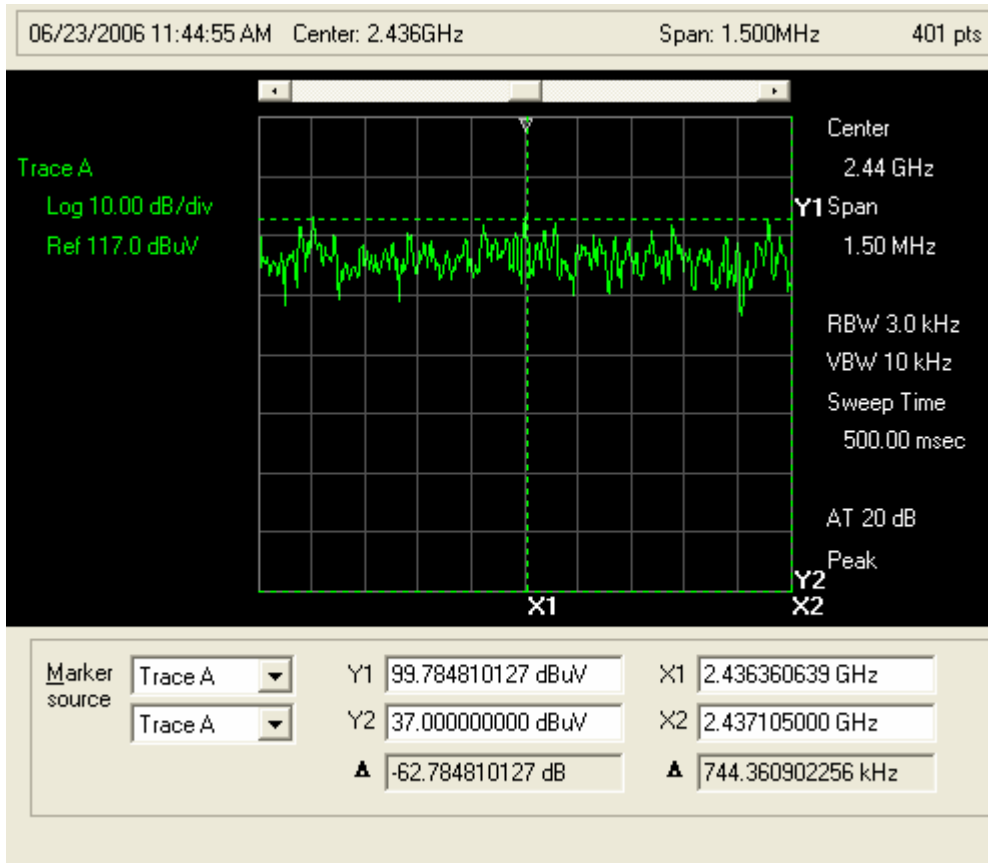

Plot 11: Power Density 2467 MHz / 6 Mbit Modulation

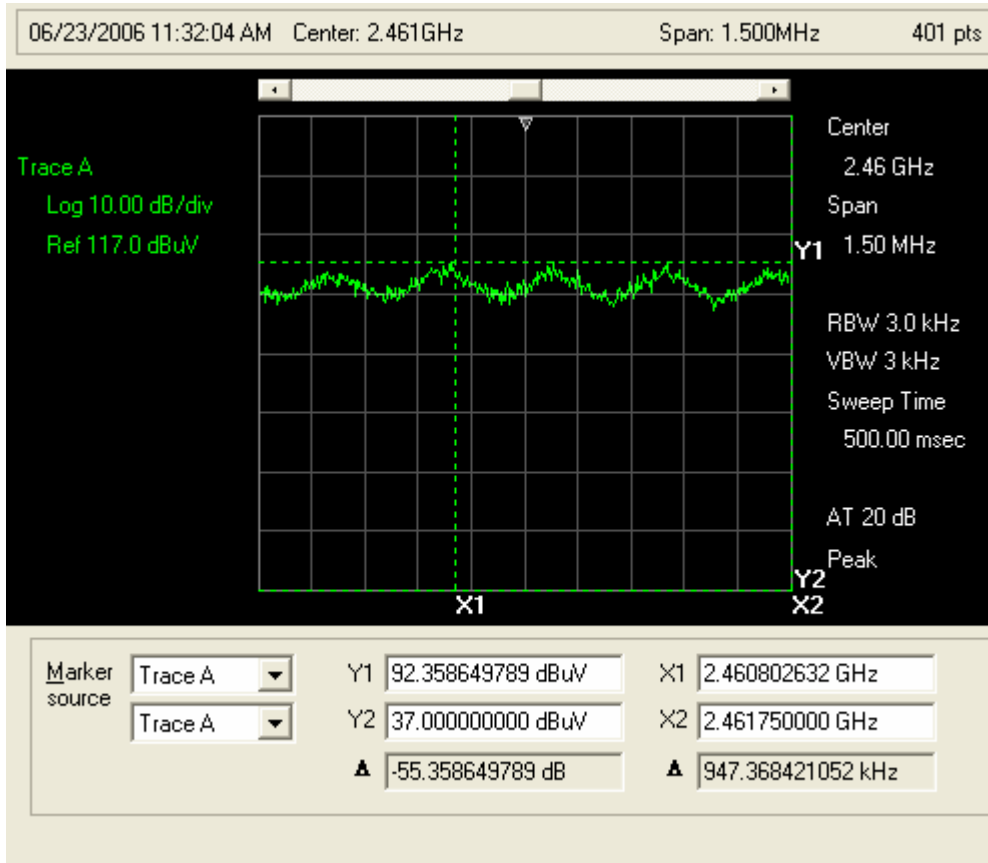

Plot 11: Power Density 2467 MHz / 11 Mbit Modulation

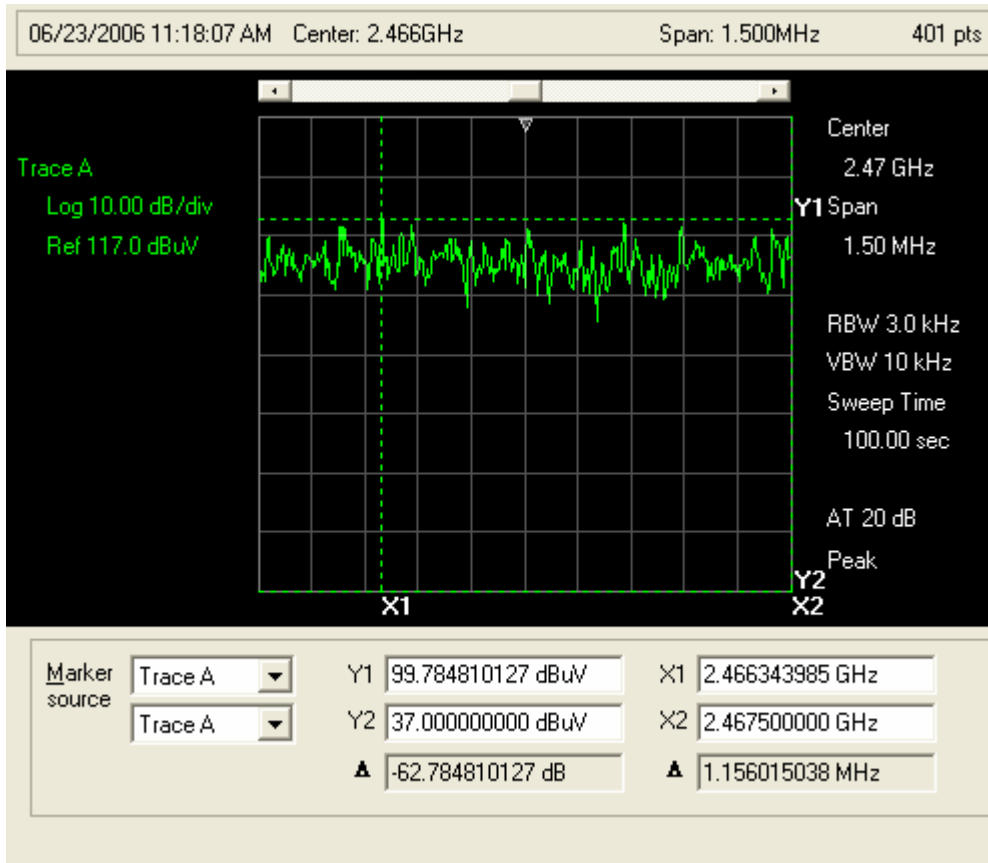

6 dB Bandwidth

20 dB Bandwidth [CFR 47 15.247 (a)(1)(ii) and RSS-210 6.2.2(o)]

EUT	GO WI-FI! P500
Test setup	A (conducted)
Temp, Humidity, Air Pressure	68° F, 30.47
Date of Measurement	3/20/06
Measured by	Bob Cole
Result	PASSED

Limits and Results

6 dB BANDWIDTH

EUT Channel	Limit (MHz)	Test results (MHz)
2	>/= .500	16.54
40	>/= .500	16.35
80	>/= .500	16.54

Screen Shots

Plot 12: 6 dB BW 2412 MHz / 6 Mbit Modulation

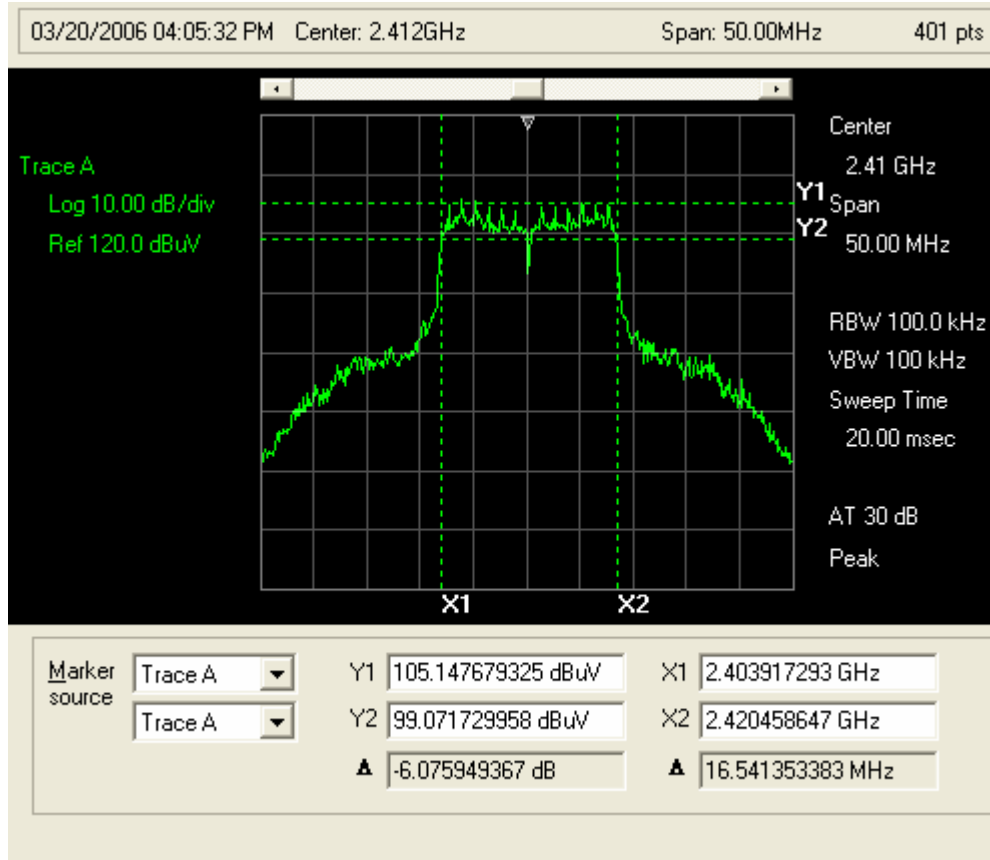

Plot 13: 6 dB BW 2412 MHz / 2 Mbit Modulation

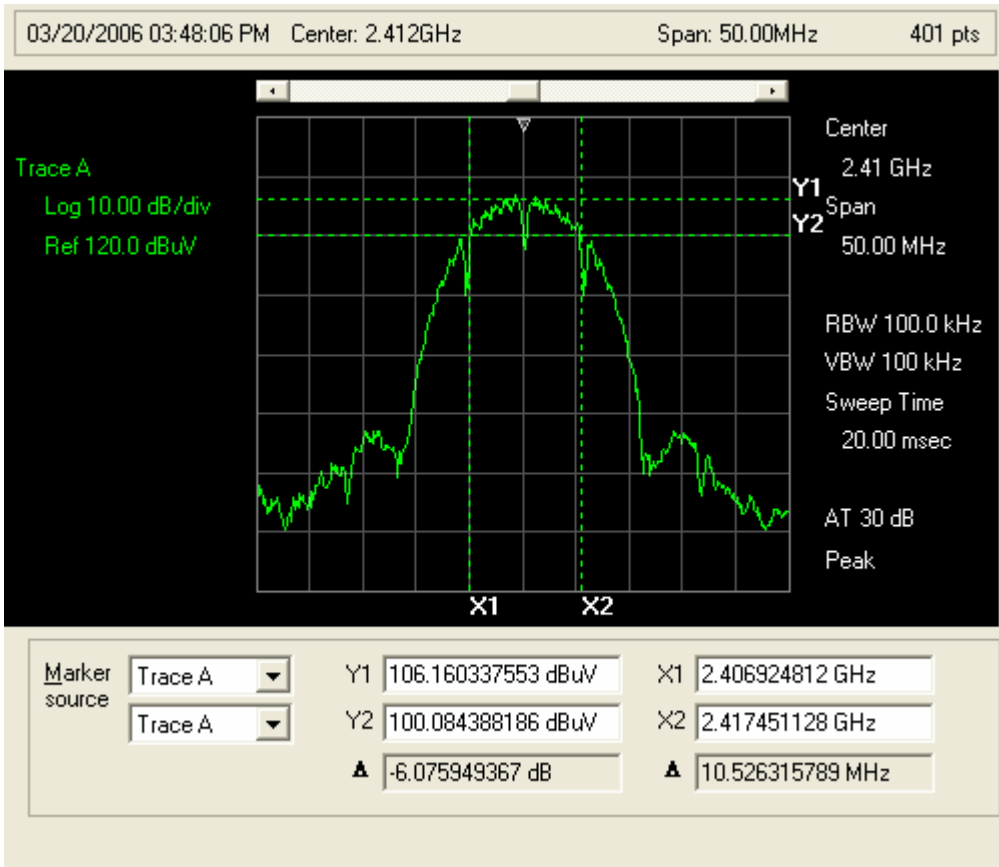

Plot 14: 6 dB BW 2437 MHz / 6 Mbit Modulation

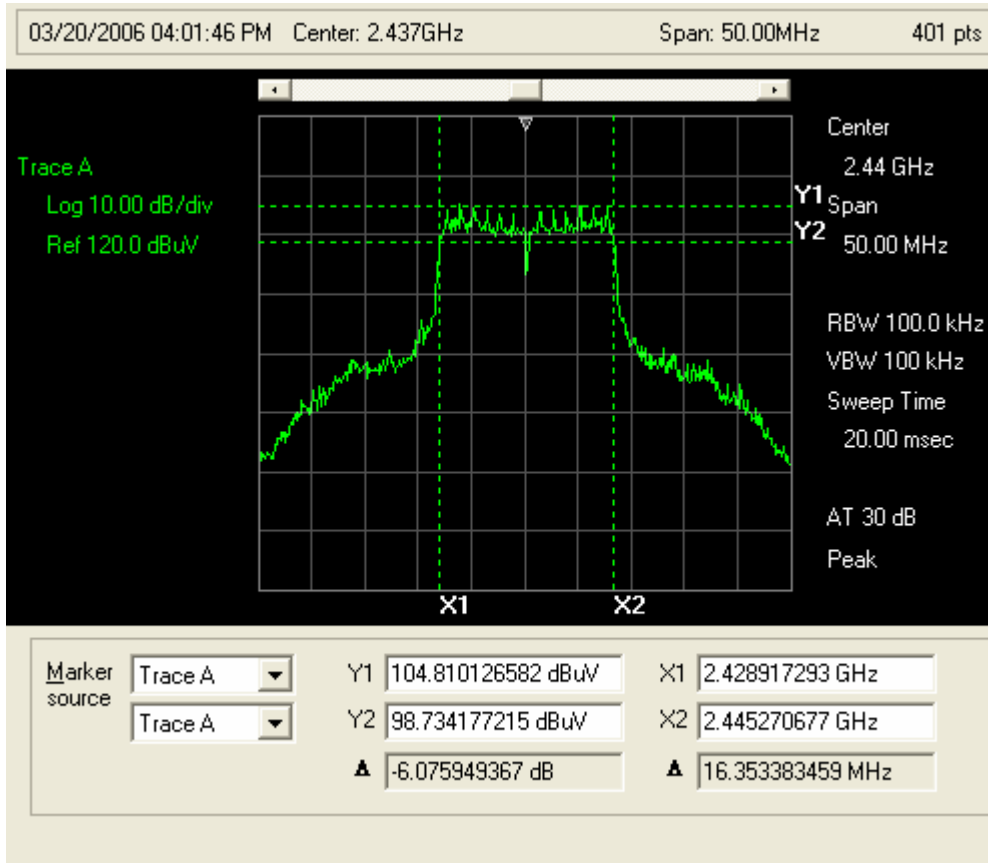

Plot 15: 6 dB BW 2437 MHz / 2 Mbit Modulation

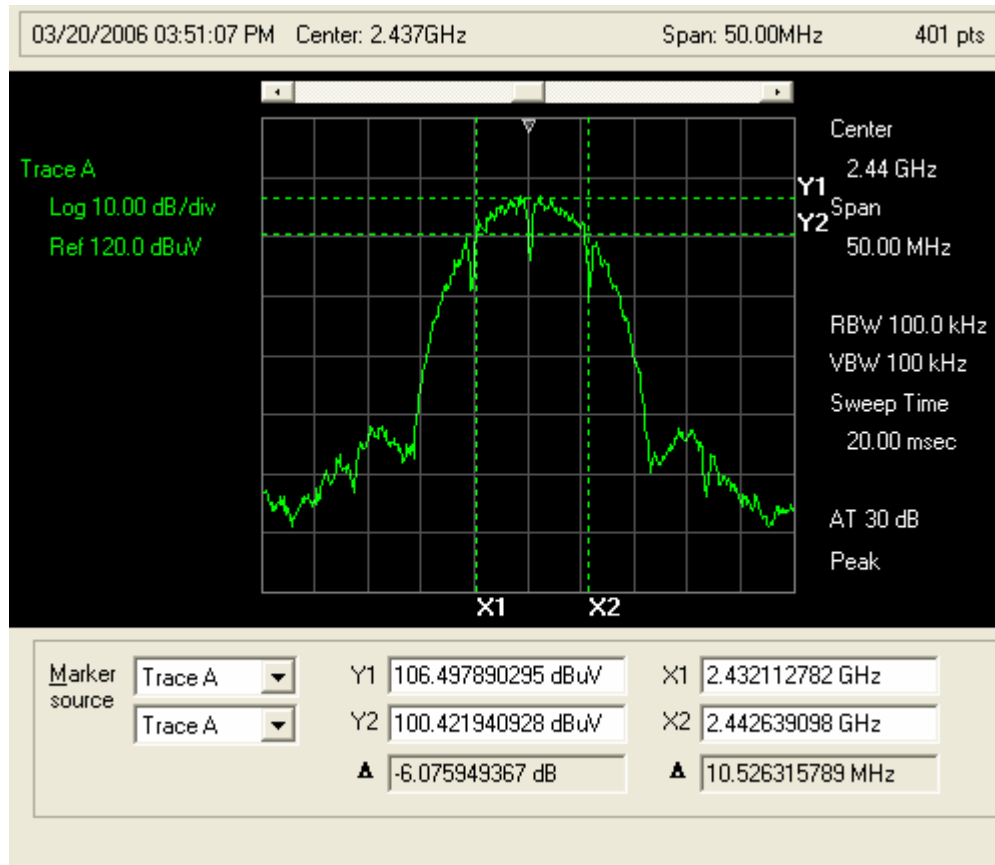

Plot 15: 6 dB BW 2462 MHz / 6 Mbit Modulation

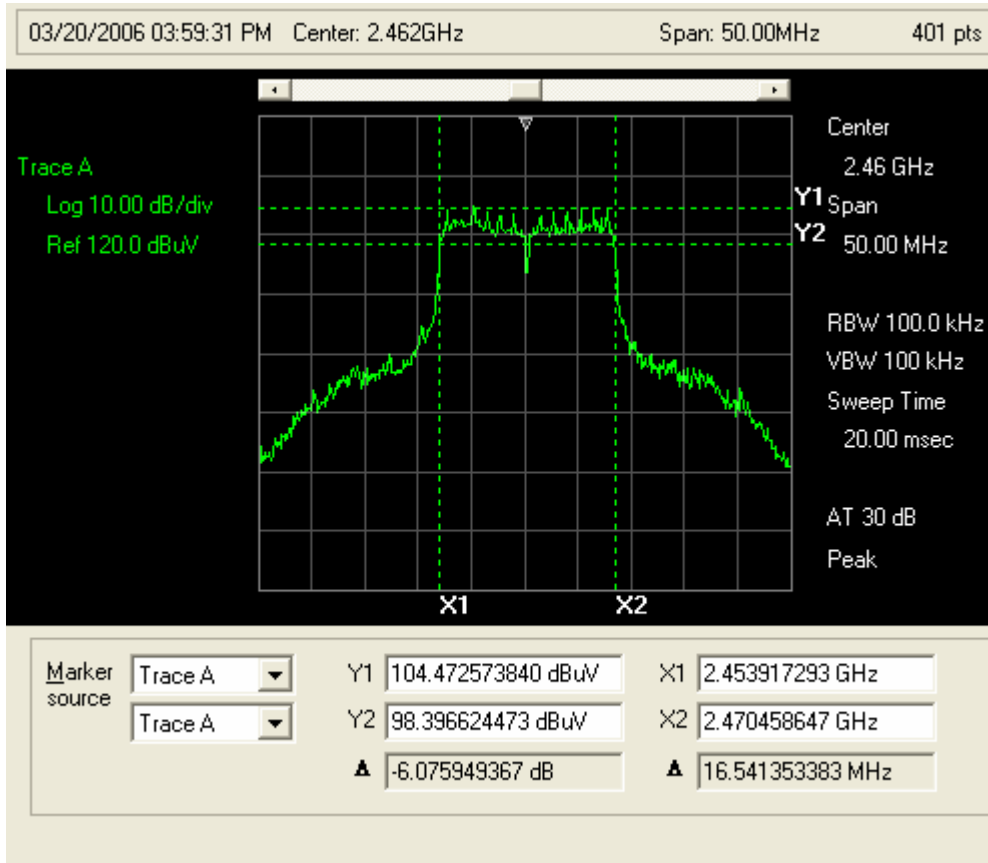

Plot 16: 6 dB BW 2462 MHz / 2 Mbit Modulation

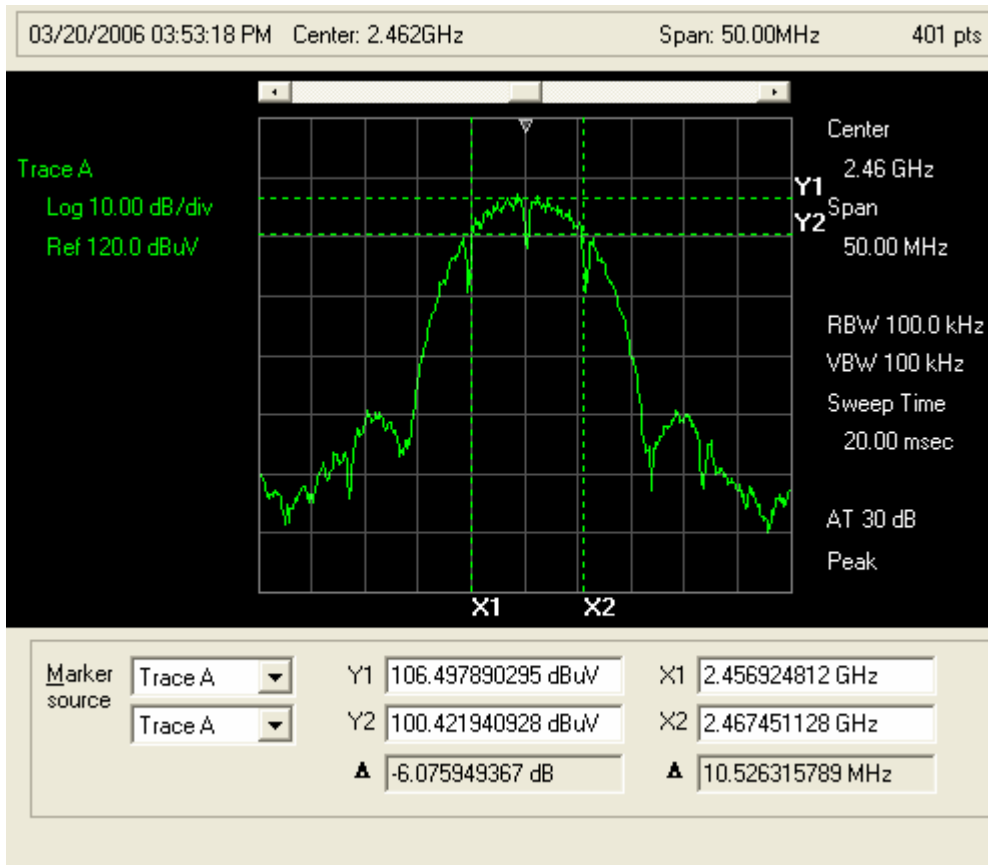

BAND-EDGE COMPLIANCE

Band-edge compliance of RF Radiated emissions [CFR 47, 15.247c(1) and RSS-210 6.2.2(o)]

EUT	GO WI-FI! P500
Test setup	A (conducted – 2412 and 2462 MHz)
Temp, Humidity, Air Pressure	69° F, 30.72
Date of Measurement	3/20/06
Measured by	Bob Cole
Result	PASSED

EUT operation mode

EUT operation mode	6 Mbit modulation – worst case
EUT channel	1, 13
EUT TX power level	Maximum

Limits and results

BAND-EDGE COMPLIANCE

Channel	Limit (dBuV)	Results (dBuV)
2	96.0	81.18
80	96.0	68.69

NOTE: 0 dBm = 107 dBuV

Screen shots:

Plot 17: Band-edge Compliance, Lower Band-edge / 6 Mbit Modulation

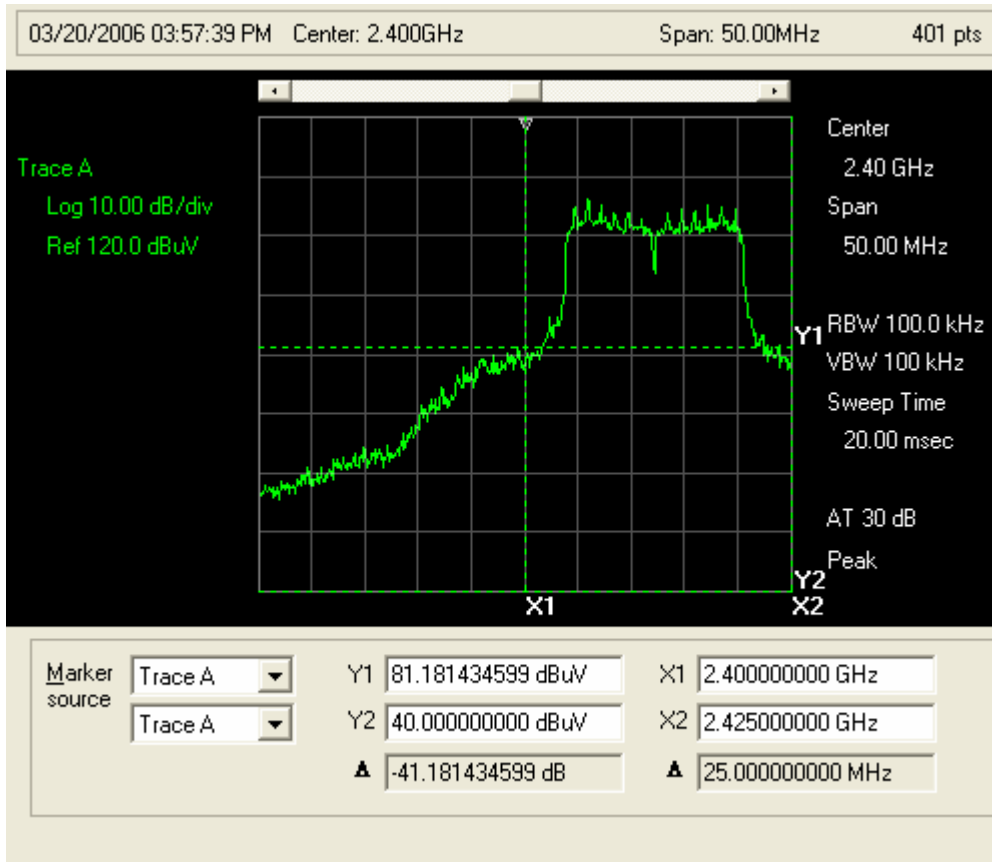

Plot 18: Band-edge Compliance, Lower Band-edge / 2 Mbit Modulation

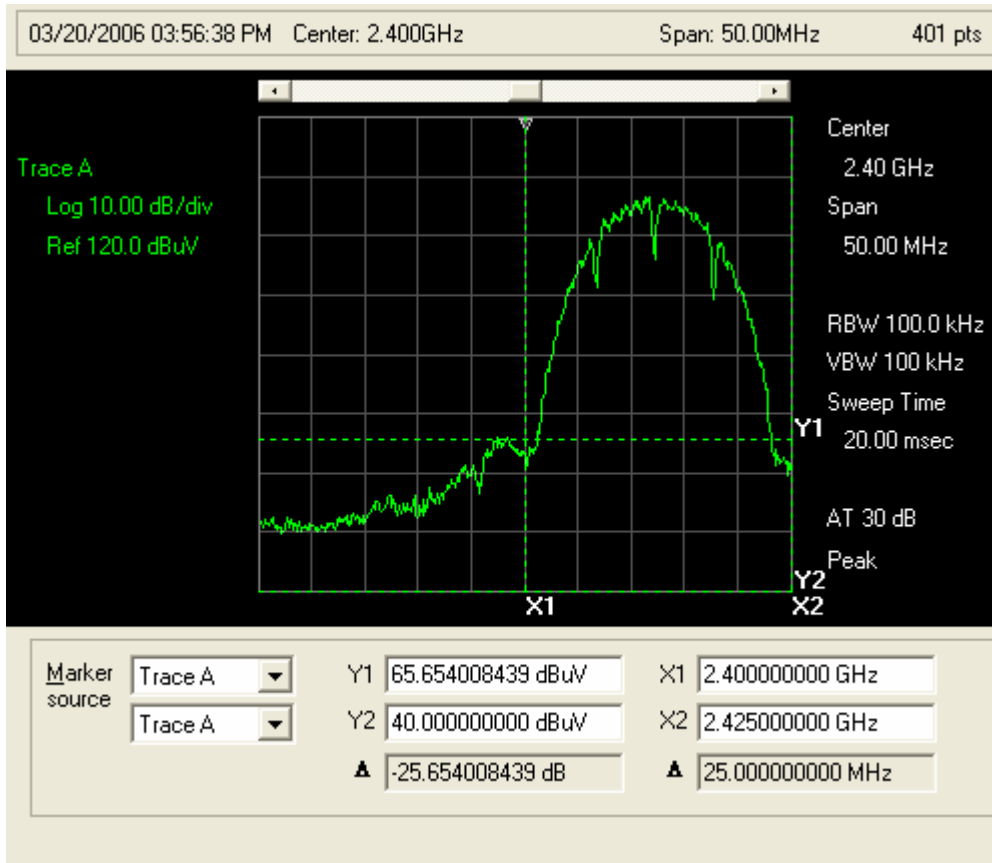

Plot 19: Band-edge compliance, Upper Band-edge / 6 Mbit Modulation

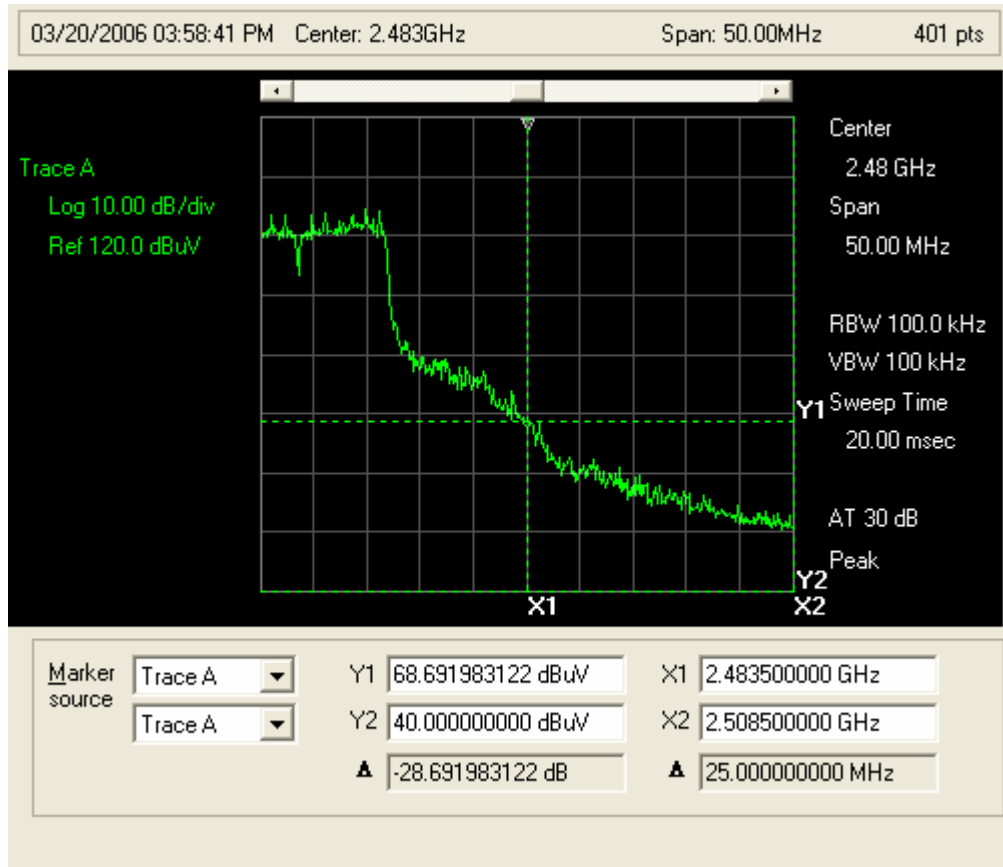

Plot 19: Band-edge Compliance, Upper Band-edge / 2 Mbit Modulation

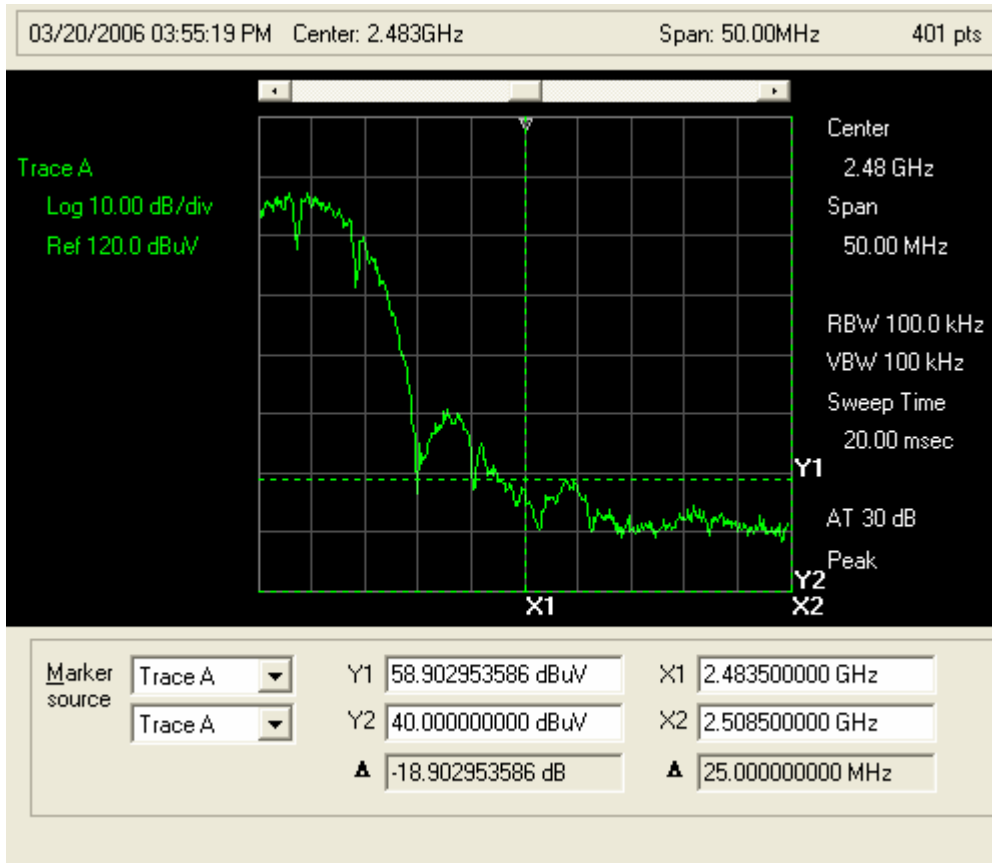

RESTRICTED BAND MEASUREMENTS

Restricted Band Measurements [CFR 47, 15.247(c) and RSS-210 6.2.2(o)]

EUT	GO WI-FI! P500
Test setup	A (conducted)
Temp, Humidity, Air Pressure	68° F, 30.02
Date of Measurement	3/20/06
Measured by	Bob Cole
Result	PASSED

Limits and results

RESTRICTED BANDS

Frequency (MHz)	Limit (dBuV)	Results (dBuV)
2310 - 2390	96.0	81.18
2483.5-2500	96.0	68.69

NOTE: 0 dBm = 107 dBuV

Note: All restricted Bands from 30 MHz to 12.75 GHz were examined.

SPURIOUS RF RADIATED EMISSIONS

Spurious RF Radiated Emissions [CFR 47, 15.247c1) and RSS-210 6.2.2(o)]

EUT	GO WI-FI! P500
Test setup	B (Radiated)
Temp, Humidity, Air Pressure	67° F, 30.38
Date of Measurement	4/25/06
Measured by	Bob Cole
Result	PASSED

CFR 47, 15.209 LIMIT (3M MEASURING DISTANCE)

Frequency Band (MHz)	Limit (dBμV/m)	Detector
30-88	40	Q-Peak
88-230	43.5	Q-Peak
230-960	46	Q-Peak
960-1000	54	Q-Peak

Emission measurement data, 30 MHz – 1GHz

The measurement results were obtained as described below.

$$E[\mu\text{V/m}] = U_{RX} + A_{CABLE} + AF - G_{PREAMP}$$

Where:

- U_{RX} receiver reading
- A_{CABLE} Attenuation of the cable
- AF Antenna Factor
- G_{PREAMP} Gain of the preamplifier

Radiated Spurious Emissions, 30 - 1000 MHz

Test Location: EMCE Engineering •44366 S. Grimmer Blvd • Fremont, CA 94538 • 510-490-4307

Customer: **Socket**
 Specification: **FCC Radiated 30--1000 MHz**
 Work Order #: _____ Date: 3/24/2006
 Test Type: **Radiated Scan** Time: 4:56:06 PM
 Equipment: **CF Wi-Fi Card** Sequence#: 1
 Manufacturer: Socket Communications Tested By: Bob Cole
 Model: 8510-00251
 S/N: _____

Test Equipment:

Function	S/N	Calibration Date	Cal Due Date	Asset #
----------	-----	------------------	--------------	---------

Equipment Under Test (* = EUT):

Function	Manufacturer	Model #	S/N
		8510-00251	

Support Devices:

Function	Manufacturer	Model #	S/N
----------	--------------	---------	-----

Test Conditions / Notes:

--

Transducer Legend:

--

Measurement Data: Reading listed by margin. Test Distance: 1 Meter

#	Freq MHz	Rdng dBµV	dB	dB	dB	dB	Dist Table	Corr dBµV/m	Spec dBµV/m	Margin dB	Polar Ant
---	-------------	--------------	----	----	----	----	---------------	----------------	----------------	--------------	--------------

No signals detected within 10 dB of the limit.

SPURIOUS RF RADIATED EMISSIONS
CFR 47, 15.247(d) limits

Radiated Spurious Emissions, 1000-2400 MHz

Test Location: EMCE Engineering •44366 S. Grimmer Blvd • Fremont, CA 94538 • 510-490-4307

Customer: **Socket**
 Specification: **FCC Radiated 1--2.4 GHz**
 Work Order #: Date: 4/24/2006
 Test Type: **Radiated Scan** Time: 2:20:24 PM
 Equipment: **CF Wifi Card** Sequence#: 2
 Manufacturer: Socket Communications Tested By: Bob Cole
 Model: 8510-00251
 S/N:

Test Equipment:

Function	S/N	Calibration Date	Cal Due Date	Asset #
----------	-----	------------------	--------------	---------

Equipment Under Test (* = EUT):

Function	Manufacturer	Model #	S/N
		8510-00251	

Support Devices:

Function	Manufacturer	Model #	S/N
----------	--------------	---------	-----

Test Conditions / Notes:

2 Mbit modulation

Transducer Legend:

--

Measurement Data: Reading listed by margin. Test Distance: 1 Meter

#	Freq MHz	Rdng dBµV	dB	dB	dB	dB	Dist Table	Corr dBµV/m	Spec dBµV/m	Margin dB	Polar Ant
1	2397.532M	61.0					+0.0	61.0	95.0	-34.0	Vert
2	2395.312M	58.7					+0.0	58.7	95.0	-36.3	Vert
3	2385.442M	54.3					+0.0	54.3	95.0	-40.7	Vert
4	2384.208M	52.0					+0.0	52.0	95.0	-43.0	Vert
5	2379.520M	50.6					+0.0	50.6	95.0	-44.4	Vert
6	2354.845M	49.3					+0.0	49.3	95.0	-45.7	Vert
7	2378.039M	48.9					+0.0	48.9	95.0	-46.1	Vert
8	2353.611M	47.8					+0.0	47.8	95.0	-47.2	Vert
9	2375.572M	47.0					+0.0	47.0	95.0	-48.0	Vert

10	2364.715M	44.3	+0.0	44.3	95.0	-50.7	Vert
----	-----------	------	------	------	------	-------	------

EMCE Engineering Date: 4/24/2006 Time: 2:20:24 PM Socket WO#:
BT FCC 95 dBuV Radiated 1--2.4 GHz Test Distance: 1 Meter Sequence#: 2

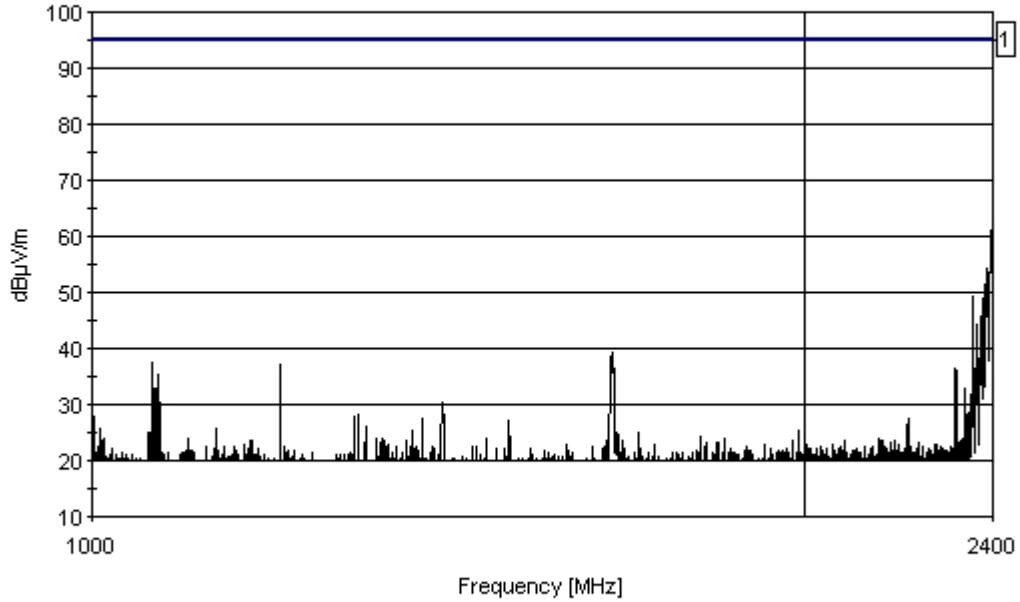

— Sweep Data — 1 - BT FCC 95 dBuV Radiated 1--2.4 GHz

Test Location: EMCE Engineering •44366 S. Grimmer Blvd • Fremont, CA 94538 • 510-490-4307

Customer: **Socket**
 Specification: **FCC Radiated 1--2.4 GHz**
 Work Order #:
 Test Type: **Radiated Scan**
 Equipment: **CF WiFi Card**
 Manufacturer: Socket
 Model: 8510-00251
 S/N:
 Date: 4/24/2006
 Time: 2:16:04 PM
 Sequence#: 1
 Tested By: Bob Cole

Test Equipment:

Function	S/N	Calibration Date	Cal Due Date	Asset #
----------	-----	------------------	--------------	---------

Equipment Under Test (* = EUT):

Function	Manufacturer	Model #	S/N
CF WiFi Card*	Socket	8510-00251	

Support Devices:

Function	Manufacturer	Model #	S/N
----------	--------------	---------	-----

Test Conditions / Notes:

6 Mbit modulation

Transducer Legend:

--

Measurement Data: Reading listed by margin. Test Distance: 1 Meter

#	Freq MHz	Rdng dB μ V	dB	dB	dB	dB	Dist Table	Corr dB μ V/m	Spec dB μ V/m	Margin dB	Polar Ant
1	2397.779M	63.0					+0.0	63.0	95.0	-32.0	Vert
2	1061.562M	38.9					+0.0	38.9	95.0	-56.1	Vert
3	2359.040M	38.7					+0.0	38.7	95.0	-56.3	Vert
4	1657.407M	38.2					+0.0	38.2	95.0	-56.8	Vert
5	1064.564M	36.5					+0.0	36.5	95.0	-58.5	Vert
6	1666.165M	36.1					+0.0	36.1	95.0	-58.9	Vert
7	1666.916M	35.8					+0.0	35.8	95.0	-59.2	Vert
8	1062.062M	35.5					+0.0	35.5	95.0	-59.5	Vert
9	1648.147M	35.4					+0.0	35.4	95.0	-59.6	Vert
10	1652.902M	35.4					+0.0	35.4	95.0	-59.6	Vert

EMCE Engineering Date: 4/24/2006 Time: 2:16:04 PM Socket WO#:
BT FCC 95 dBuV Radiated 1--2.4 GHz Test Distance: 1 Meter Sequence#: 1

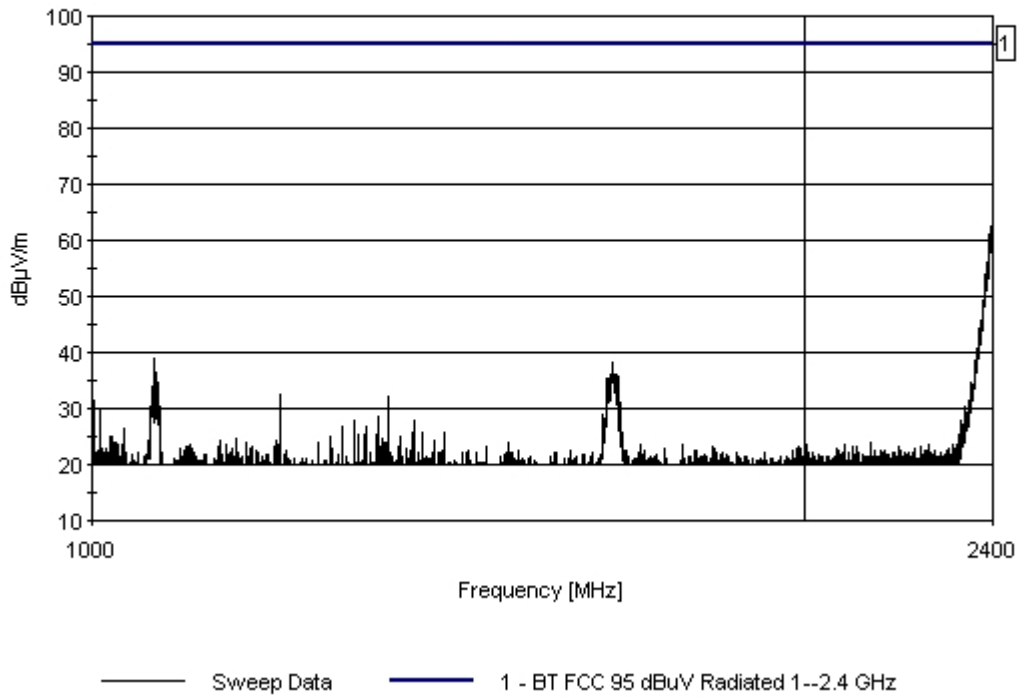

Radiated Spurious Emissions, 2483.5 - 12750 MHz

Test Location: EMCE Engineering •44366 S. Grimmer Blvd • Fremont, CA 94538 • 510-490-4307

Customer:	Socket	Date:	4/24/2006
Specification:	FCC-85 Restricted Band 2483.5 - 18000	Time:	2:56:37 PM
Work Order #:	2486	Sequence#:	6
Test Type:	Radiated Scan	Tested By:	Bob Cole
Equipment:	CF WiFi Card		
Manufacturer:	Socket		
Model:	8510-00251		
S/N:	Rev G		

Test Equipment:

Function	S/N	Calibration Date	Cal Due Date	Asset #
----------	-----	------------------	--------------	---------

Equipment Under Test (* = EUT):

Function	Manufacturer	Model #	S/N
CF WiFi Card*	Socket	8510-00251	Rev G

Support Devices:

Function	Manufacturer	Model #	S/N
----------	--------------	---------	-----

Test Conditions / Notes:

2 MBit Modulation

Transducer Legend:

--

Measurement Data: Reading listed by margin. Test Distance: 1 Meter

#	Freq MHz	Rdng dBµV	dB	dB	dB	dB	Dist Table	Corr dBµV/m	Spec dBµV/m	Margin dB	Polar Ant
1	4934.028M	61.5					-10.0	51.5	54.0	-2.5	Vert
2	4932.722M	51.2					-10.0	41.2	54.0	-12.8	Vert
3	4929.305M	49.6					-10.0	39.6	54.0	-14.4	Vert
4	11278.550M	48.4					-10.0	38.4	54.0	-15.6	Vert
5	4923.174M	47.4					-10.0	37.4	54.0	-16.6	Vert
6	11492.410M	47.4					-10.0	37.4	54.0	-16.6	Vert
7	11374.630M	47.3					-10.0	37.3	54.0	-16.7	Vert
8	11645.880M	47.3					-10.0	37.3	54.0	-16.7	Vert
9	11555.430M	47.2					-10.0	37.2	54.0	-16.8	Vert
10	11397.440M	46.9					-10.0	36.9	54.0	-17.1	Vert

EMCE Engineering Date: (4/24/06) Time: 2:56:37 PM Socket WO#: 2486
FCC-85 Restricted Band 2483.5 - 18000 Test Distance: 1 Meter Sequence#: 6

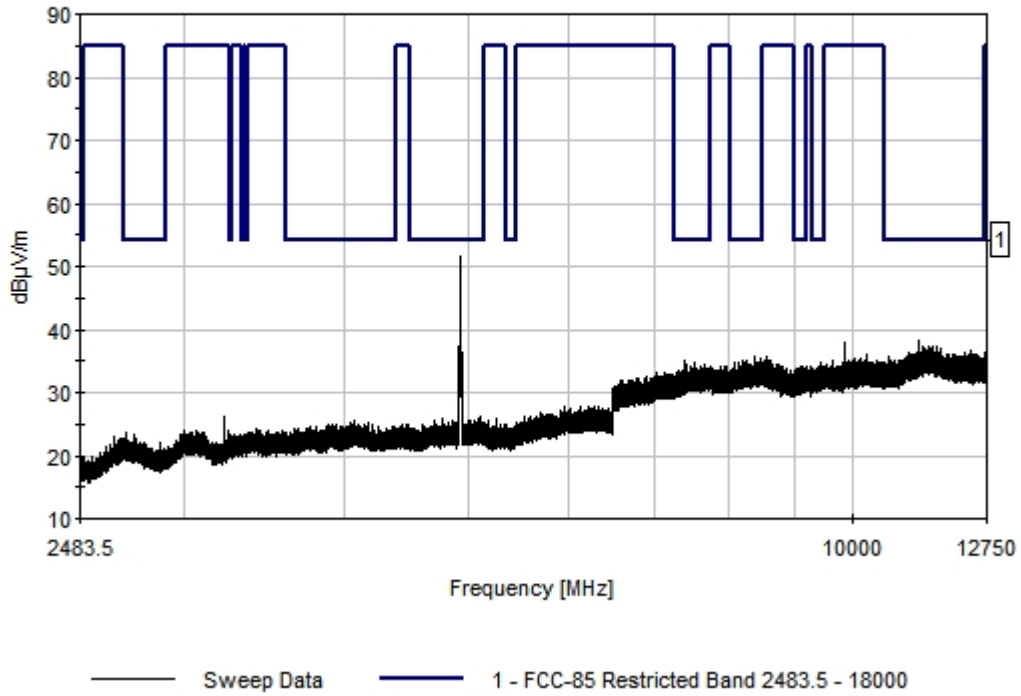

Test Location: EMCE Engineering •44366 S. Grimmer Blvd • Fremont, CA 94538 • 510-490-4307

Customer: **Socket**
 Specification: **FCC-85 Restricted Band 2483.5 - 18000**
 Work Order #: **2486** Date: 6/23/2006
 Test Type: **Radiated Scan** Time: 2:27:12 PM
 Equipment: **CF WiFi Card** Sequence#: 5
 Manufacturer: Socket Tested By: Bob Cole
 Model: 8510-00251
 S/N: Rev G

Test Equipment:

Function	S/N	Calibration Date	Cal Due Date	Asset #
----------	-----	------------------	--------------	---------

Equipment Under Test (* = EUT):

Function	Manufacturer	Model #	S/N
CF WiFi Card*	Socket	8510-00251	Rev G

Support Devices:

Function	Manufacturer	Model #	S/N
----------	--------------	---------	-----

Test Conditions / Notes:

6 MBit Modulation

Transducer Legend:

--

Measurement Data:

Reading listed by margin.

Test Distance: 1 Meter

#	Freq MHz	Rdng dB μ V	dB	dB	dB	dB	Dist Table	Corr dB μ V/m	Spec dB μ V/m	Margin dB	Polar Ant
1	4932.822M	48.4					-10.0	38.4	54.0	-15.6	Vert
2	4935.334M	47.6					-10.0	37.6	54.0	-16.4	Vert
3	4932.119M	47.0					-10.0	37.0	54.0	-17.0	Vert
4	11611.610M	46.9					-10.0	36.9	54.0	-17.1	Vert
5	4931.516M	46.8					-10.0	36.8	54.0	-17.2	Vert
6	11275.530M	46.8					-10.0	36.8	54.0	-17.2	Vert
7	12344.750M	46.8					-10.0	36.8	54.0	-17.2	Vert
8	11696.930M	46.7					-10.0	36.7	54.0	-17.3	Vert
9	11425.380M	46.6					-10.0	36.6	54.0	-17.4	Vert
10	11432.820M	46.6					-10.0	36.6	54.0	-17.4	Vert

EMCE Engineering Date: (4/24/06) Time: 2:27:12 PM Socket WO#: 2486
FCC-85 Restricted Band 2483.5 - 18000 Test Distance: 1 Meter Sequence#: 5

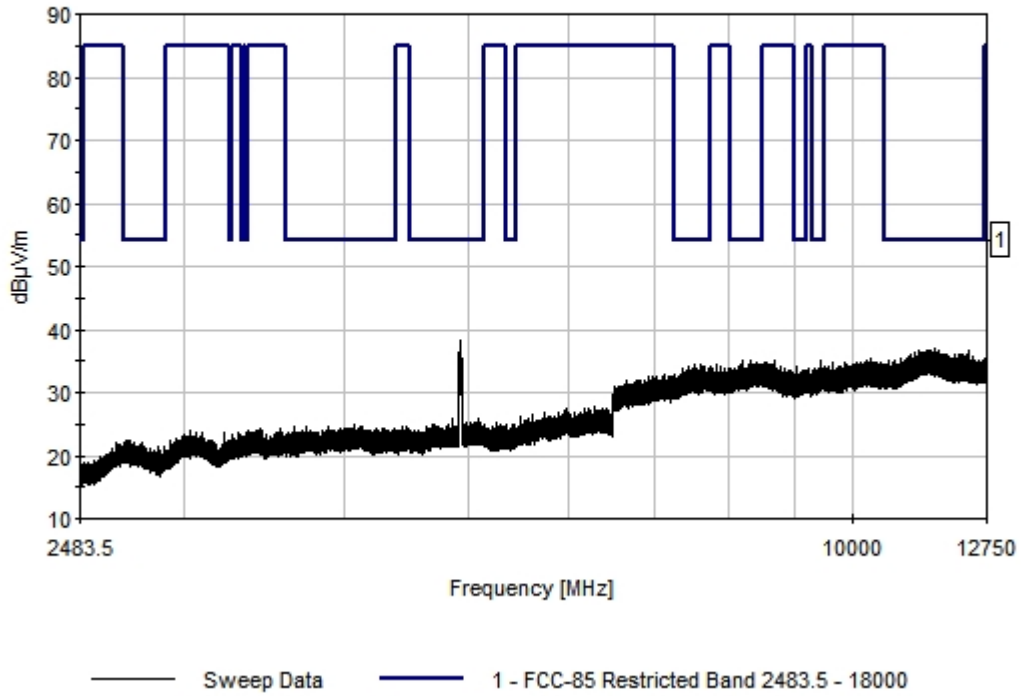

TRANSMITTER SPURIOUS CONDUCTED EMISSIONS

Spurious Conducted Emissions 30 12750 MHz – Worst Case Emission

Spurious Antenna Conducted Emissions 30 – 2400 MHz

Test Location: EMCE Engineering • 44366 S. Grimmer Blvd • Fremont, CA 94538 • 510-490-4307

Customer:	Socket	Date:	4/13/2006
Specification:	Spurious Cond. 1 - 2.4GHz	Time:	12:20:51 PM
Work Order #:	2486	Sequence#:	19
Test Type:	Conducted Emissions	Tested By:	Bob Cole
Equipment:	CF WiFi Card		120V 60Hz
Manufacturer:	Socket		
Model:	8510-00251		
S/N:			

Test Equipment:

Function	S/N	Calibration Date	Cal Due Date	Asset #
----------	-----	------------------	--------------	---------

Equipment Under Test (* = EUT):

Function	Manufacturer	Model #	S/N
CF WiFi Card*	Socket	8510-00251	

Support Devices:

Function	Manufacturer	Model #	S/N
----------	--------------	---------	-----

Test Conditions / Notes:

2 Mbit modulation

Transducer Legend:

--

Measurement Data: Reading listed by margin. Test Lead: Antenna Terminal

#	Freq MHz	Rdng dBµV	dB	dB	dB	dB	Dist Table	Corr dBµV	Spec dBµV	Margin dB	Polar Ant
1	2396.299M	82.1					+0.0	82.1	95.0	-12.9	Anten
2	2390.870M	76.4					+0.0	76.4	95.0	-18.6	Anten
3	1657.156M	64.7					+0.0	64.7	95.0	-30.3	Anten
4	451.622M	57.5					+0.0	57.5	95.0	-37.5	Anten
5	2339.546M	49.0					+0.0	49.0	95.0	-46.0	Anten
6	2333.871M	47.8					+0.0	47.8	95.0	-47.2	Anten
7	2298.547M	45.6					+0.0	45.6	95.0	-49.4	Anten
8	75.664M	44.3					+0.0	44.3	95.0	-50.7	Anten
9	2198.447M	44.3					+0.0	44.3	95.0	-50.7	Anten

10	2068.067M	43.3	+0.0	43.3	95.0	-51.7	Anten
----	-----------	------	------	------	------	-------	-------

EMCE Engineering Date: 4/13/2006 Time: 12:20:51 PM Socket W/O#: 2486
BT Spurious Cond. 1 - 2.4GHz Test Lead: Antenna Terminal 120V 60Hz Sequence#: 19

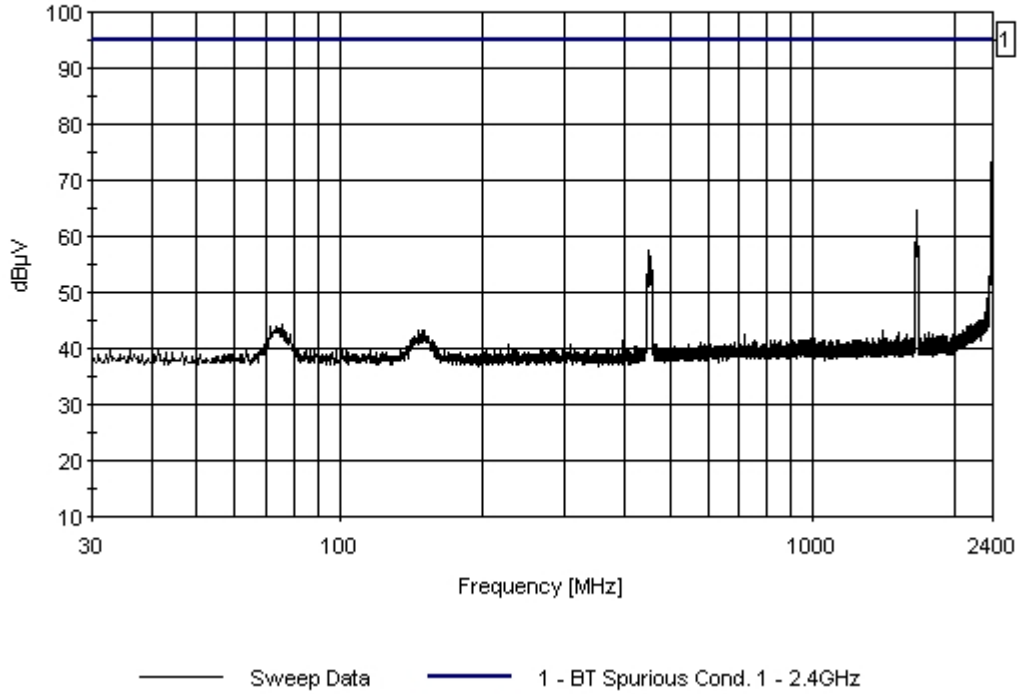

Test Location: EMCE Engineering •44366 S. Grimmer Blvd • Fremont, CA 94538 • 510-490-4307

Customer: **Socket**
 Specification: **Spurious Cond. 1 - 2.4GHz**
 Work Order #: **2486** Date: 4/11/2006
 Test Type: **Conducted Emissions** Time: 11:31:01 AM
 Equipment: **CF WiFi Card** Sequence#: 3
 Manufacturer: Socket Tested By: Bob Cole
 Model: 8510-00251 120V 60Hz
 S/N:

Test Equipment:

Function	S/N	Calibration Date	Cal Due Date	Asset #
----------	-----	------------------	--------------	---------

Equipment Under Test (* = EUT):

Function	Manufacturer	Model #	S/N
CF WiFi Card*	Socket	8510-00251	

Support Devices:

Function	Manufacturer	Model #	S/N
----------	--------------	---------	-----

Test Conditions / Notes:

6 Mbit modulation

Transducer Legend:

--

Measurement Data: Reading listed by margin. Test Lead: Black

#	Freq MHz	Rdng dB μ V	dB	dB	dB	dB	Dist Table	Corr dB μ V	Spec dB μ V	Margin dB	Polar Ant
1	2399.753M	84.9					+0.0	84.9	95.0	-10.1	Black
2	1660.660M	76.4					+0.0	76.4	95.0	-18.6	Black
3	1666.416M	72.3					+0.0	72.3	95.0	-22.7	Black
4	1666.916M	71.2					+0.0	71.2	95.0	-23.8	Black
5	1648.147M	70.8					+0.0	70.8	95.0	-24.2	Black
6	1648.648M	70.3					+0.0	70.3	95.0	-24.7	Black
7	1647.397M	68.0					+0.0	68.0	95.0	-27.0	Black
8	73.679M	64.8					+0.0	64.8	95.0	-30.2	Black
9	451.622M	63.5					+0.0	63.5	95.0	-31.5	Black
10	151.572M	63.1					+0.0	63.1	95.0	-31.9	Black

EMCE Engineering Date: 4/11/2006 Time: 11:31:01 AM Socket WO#: 2486
BT Spurious Cond. 1 - 2.4GHz Test Lead: Black 120V 60Hz Sequence#: 3

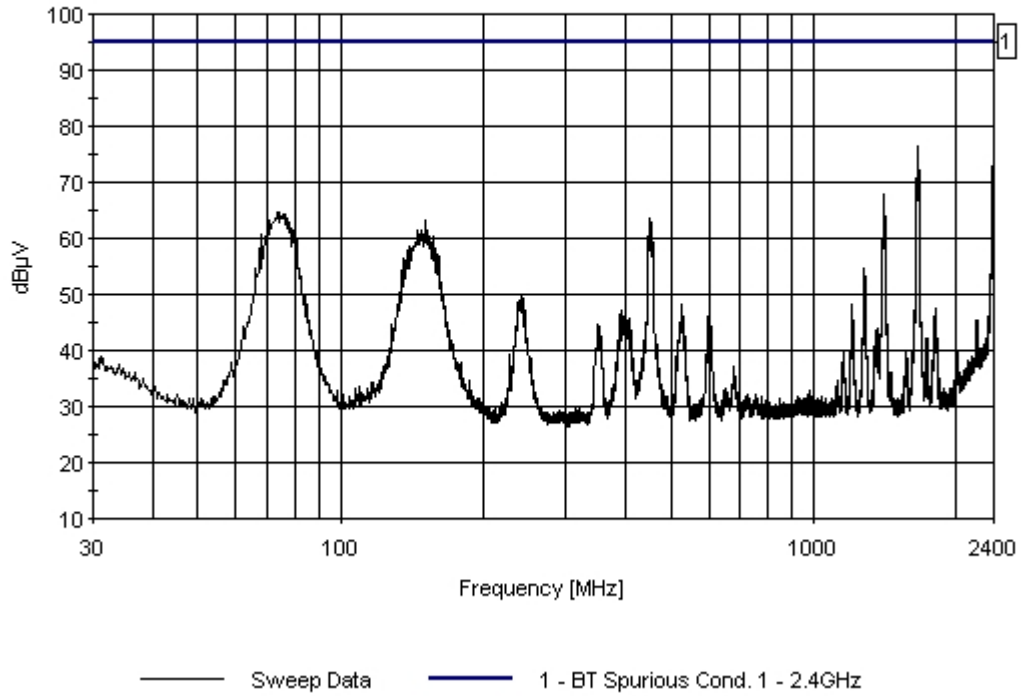

Spurious Antenna Conducted Emissions 2.4835-18 GHz

Test Location: EMCE Engineering •44366 S. Grimmer Blvd • Fremont, CA 94538 • 510-490-4307

Customer: **Socket**
 Specification: **Ant Spur Cond Upper**
 Work Order #: **2486** Date: 4/19/2006
 Test Type: **Conducted Emissions** Time: 10:46:24 AM
 Equipment: **CF WiFi Card** Sequence#: 20
 Manufacturer: **Socket** Tested By: **Bob Cole**
 Model: **8510-00251** 120V 60Hz
 S/N:

Test Equipment:

Function	S/N	Calibration Date	Cal Due Date	Asset #
----------	-----	------------------	--------------	---------

Equipment Under Test (* = EUT):

Function	Manufacturer	Model #	S/N
CF WiFi Card*	Socket	8510-00251	

Support Devices:

Function	Manufacturer	Model #	S/N
----------	--------------	---------	-----

Test Conditions / Notes:

2 Mbit modulation

Transducer Legend:

--

Measurement Data: Reading listed by margin. Test Lead: Antenna Terminal

#	Freq MHz	Rdng dBµV	dB	dB	dB	dB	Dist Table	Corr dBµV	Spec dBµV	Margin dB	Polar Ant
1	2484.751M	75.3					+0.0	75.3	95.0	-19.7	Anten
2	2488.255M	73.9					+0.0	73.9	95.0	-21.1	Anten
3	4944.210M	60.0					+0.0	60.0	95.0	-35.0	Anten
4	4936.953M	58.5					+0.0	58.5	95.0	-36.5	Anten
5	4932.949M	58.1					+0.0	58.1	95.0	-36.9	Anten
6	4955.472M	55.2					+0.0	55.2	95.0	-39.8	Anten
7	4956.723M	53.8					+0.0	53.8	95.0	-41.2	Anten
8	5160.427M	32.8					+0.0	32.8	95.0	-62.2	Anten
9	5289.056M	32.0					+0.0	32.0	95.0	-63.0	Anten
10	5276.293M	31.5					+0.0	31.5	95.0	-63.5	Anten

EMCE Engineering Date: 4/19/2006 Time: 10:46:24 AM Socket WVO#: 2486
BT Ant Spur Cond Upper Test Lead: Antenna Terminal 120V 60Hz Sequence#: 20

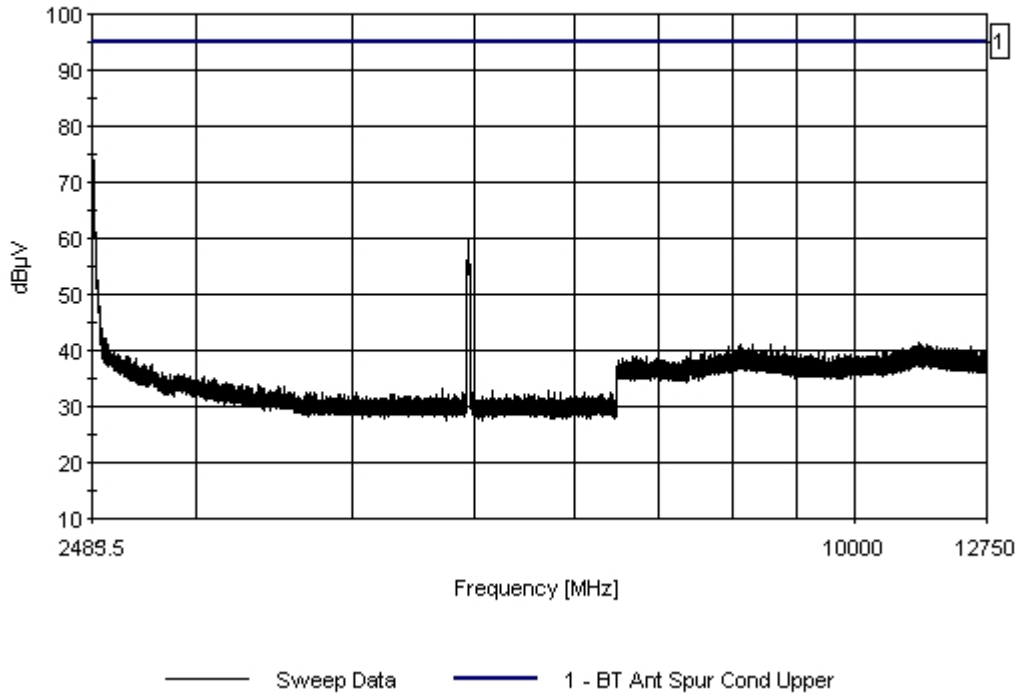

Test Location: EMCE Engineering •44366 S. Grimmer Blvd • Fremont, CA 94538 • 510-490-4307

Customer: **Socket**
 Specification: **Ant Spur Cond Upper**
 Work Order #: **2486**
 Test Type: **Conducted Emissions**
 Equipment: **CF WiFi Card**
 Manufacturer: Socket
 Model: 8510-00251
 S/N:

Date: 4/13/2006
 Time: 11:36:17 AM
 Sequence#: 15
 Tested By: Bob Cole
 120V 60Hz

Test Equipment:

Function	S/N	Calibration Date	Cal Due Date	Asset #
----------	-----	------------------	--------------	---------

Equipment Under Test (* = EUT):

Function	Manufacturer	Model #	S/N
CF WiFi Card*	Socket	8510-00251	

Support Devices:

Function	Manufacturer	Model #	S/N
----------	--------------	---------	-----

Test Conditions / Notes:

6 Mbit modulation

Transducer Legend:

--

Measurement Data:

Reading listed by margin.

Test Lead: Antenna Terminal

#	Freq MHz	Rdng dBµV	dB	dB	dB	dB	Dist Table	Corr dBµV	Spec dBµV	Margin dB	Polar Ant
1	2488.255M	72.3					+0.0	72.3	95.0	-22.7	Anten
2	2483.750M	71.5					+0.0	71.5	95.0	-23.5	Anten
3	2493.510M	63.2					+0.0	63.2	95.0	-31.8	Anten
4	4944.210M	59.4					+0.0	59.4	95.0	-35.6	Anten
5	4942.959M	58.2					+0.0	58.2	95.0	-36.8	Anten
6	4949.215M	57.6					+0.0	57.6	95.0	-37.4	Anten
7	4936.953M	57.5					+0.0	57.5	95.0	-37.5	Anten
8	4955.472M	54.4					+0.0	54.4	95.0	-40.6	Anten
9	4930.447M	52.5					+0.0	52.5	95.0	-42.5	Anten
10	5286.303M	31.9					+0.0	31.9	95.0	-63.1	Anten

EMCE Engineering Date: 4/13/2006 Time: 11:36:17 AM Socket WO#: 2486
BT Ant Spur Cond Upper Test Lead: Antenna Terminal 120V 60Hz Sequence#: 15

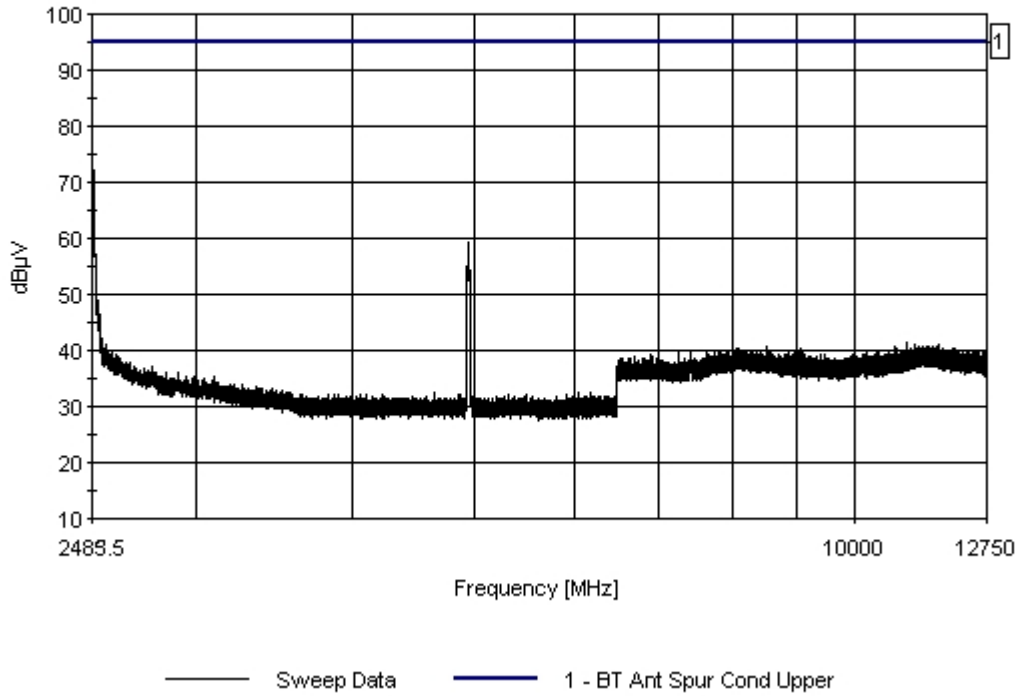

AC LINE CONDUCTED EMISSIONS MEASUREMENT

AC Line Conducted Emissions Measurement 150 kHz – 30 MHz

EUT	GO WI-FI! P500
Test setup	C (conducted)
Temp, Humidity, Air Pressure	68° F, 30.69
Date of Measurement	4/26/06
Measured by	Bob Cole
Result	PASSED

CLASS B LIMIT

Frequency Band (MHz)	EN 55022 B Limit (dB μ V/m)	Detector
0.15 – 0.5	66 to 56	QP
0.5 – 5.0	56	QP
5.0 – 30.0	60	QP

EUT operation mode

EUT operation mode	6 Mbit modulation
EUT channel	1
EUT TX power level	Maximum
EUT operation voltage	120 VAC

LINE CONDUCTED EMISSIONS, .15 - 30 MHz
EN 55022 Class B Limits

LINE 1

Test Location: EMCE Engineering •44366 S. Grimmer Blvd • Fremont, CA 94538 • 510-490-4307

Customer: **Socket**
 Specification: **EN55022 B COND [QP]**
 Work Order #: **2486** Date: 4/26/2006
 Test Type: **Conducted Emissions** Time: 3:18:08 PM
 Equipment: **CF WiFi Card** Sequence#: 6
 Manufacturer: **Socket** Tested By: **Bob Cole**
 Model: **8510-00251** 120V 60Hz
 S/N:

Test Equipment:

Function	S/N	Calibration Date	Cal Due Date	Asset #
----------	-----	------------------	--------------	---------

Equipment Under Test (* = EUT):

Function	Manufacturer	Model #	S/N
CF WiFi Card*	Socket	8510-00251	

Support Devices:

Function	Manufacturer	Model #	S/N
----------	--------------	---------	-----

Test Conditions / Notes:

6 Mbit modulation

Transducer Legend:

--

Measurement Data: Reading listed by margin. Test Lead: Black

#	Freq MHz	Rdng dB μ V	dB	dB	dB	dB	Dist Table	Corr dB μ V	Spec dB μ V	Margin dB	Polar Ant
1	150.000k	46.4					+0.0	46.4	66.0	-19.6	Black
2	3.769M	34.7					+0.0	34.7	56.0	-21.3	Black
3	206.722k	41.9					+0.0	41.9	63.3	-21.4	Black
4	209.630k	41.2					+0.0	41.2	63.2	-22.0	Black
5	211.085k	41.2					+0.0	41.2	63.2	-22.0	Black
6	3.688M	33.9					+0.0	33.9	56.0	-22.1	Black
7	3.854M	33.0					+0.0	33.0	56.0	-23.0	Black
8	3.603M	32.5					+0.0	32.5	56.0	-23.5	Black
9	3.186M	31.3					+0.0	31.3	56.0	-24.7	Black
10	3.437M	31.2					+0.0	31.2	56.0	-24.8	Black

EMCE Engineering Date: 4/26/2006 Time: 3:18:08 PM Socket W/O#: 2486
EN55022 B COND [QP] Test Lead: Black 120V 60Hz Sequence#: 6

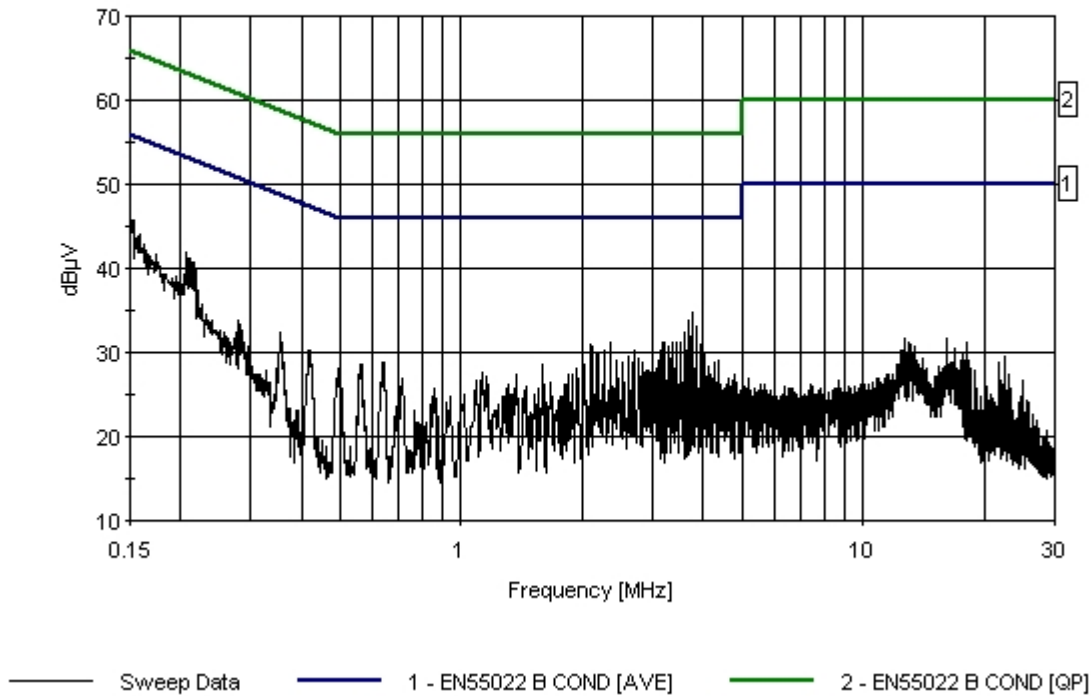

LINE CONDUCTED EMISSIONS, .15 - 30 MHz
EN 55022 Class B Limits

LINE 2 – Neutral

Test Location: EMCE Engineering •44366 S. Grimmer Blvd • Fremont, CA 94538 • 510-490-4307

Customer: **Socket**
 Specification: **EN55022 B COND [QP]**
 Work Order #: **2486**
 Test Type: **Conducted Emissions**
 Equipment: **CF WiFi Card**
 Manufacturer: **Socket**
 Model: **8510-00251**
 S/N:

Date: 4/26/2006
 Time: 3:31:59 PM
 Sequence#: 9
 Tested By: Bob Cole
 120V 60Hz

Test Equipment:

Function	S/N	Calibration Date	Cal Due Date	Asset #
----------	-----	------------------	--------------	---------

Equipment Under Test (* = EUT):

Function	Manufacturer	Model #	S/N
CF WiFi Card*	Socket	8510-00251	

Support Devices:

Function	Manufacturer	Model #	S/N
----------	--------------	---------	-----

Test Conditions / Notes:

6 Mbit modulation

Transducer Legend:

Measurement Data: Reading listed by margin. Test Lead: Black

#	Freq MHz	Rdng dB μ V					Dist Table	Corr dB μ V	Spec dB μ V	Margin dB	Polar Ant
1	3.684M	34.3					+0.0	34.3	56.0	-21.7	Black
2	3.765M	34.3					+0.0	34.3	56.0	-21.7	Black
3	3.603M	34.2					+0.0	34.2	56.0	-21.8	Black
4	150.000k	43.8					+0.0	43.8	66.0	-22.2	Black
5	3.850M	33.8					+0.0	33.8	56.0	-22.2	Black
6	3.935M	33.7					+0.0	33.7	56.0	-22.3	Black
7	2.276M	32.5					+0.0	32.5	56.0	-23.5	Black
8	3.518M	32.1					+0.0	32.1	56.0	-23.9	Black
9	1.145M	31.9					+0.0	31.9	56.0	-24.1	Black
10	3.271M	31.5					+0.0	31.5	56.0	-24.5	Black

EMCE Engineering Date: 4/26/2006 Time: 3:31:59 PM Socket WVO#: 2486
EN55022 B COND [QP] Test Lead: Black 120V 60Hz Sequence#: 9

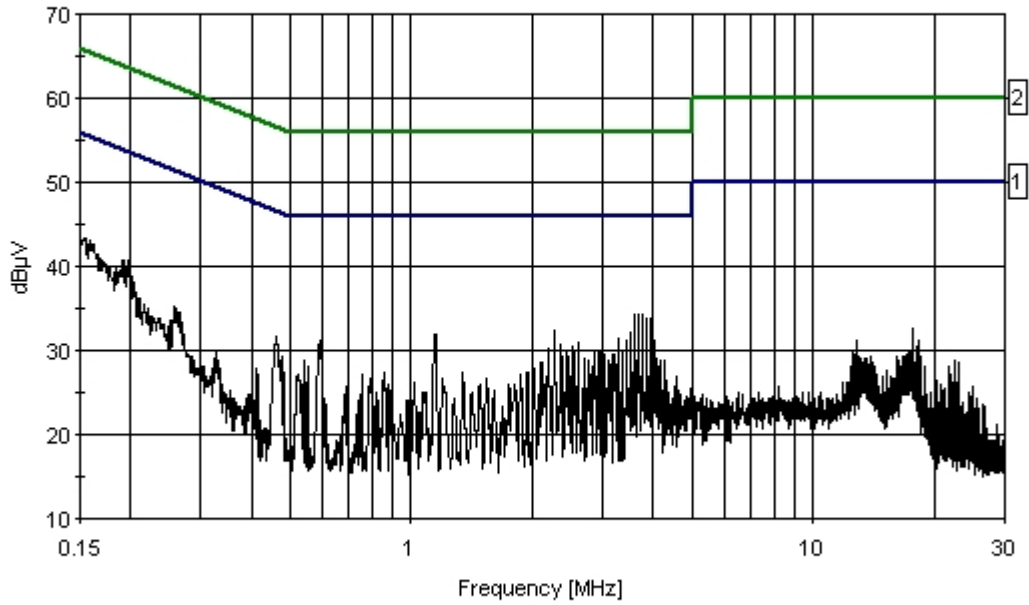

— Sweep Data — 1 - EN55022 B COND [AVE] — 2 - EN55022 B COND [QP]

7.0 TEST EQUIPMENT

Antenna Conducted Measurements:

Equipment	Type	Manufacturer	Calibration Due Date
Spectrum Analyzer	8593EM	Hewlett-Packard	2/1/07
Oscilloscope	TDS820	Tektronix	2/1/07
Coaxial cable	SMA Male – Reverse SMA Male (Length = 20 cm)	Own	10/1/06

Spurious RF radiated emissions:

Equipment	Type	Manufacturer	Calibration Due Date
EMI Analyzer System	84125B	Hewlett-Packard	2/1/07
Spectrum Analyzer	8593EM	Hewlett-Packard	2/1/07
Pre-Amp	83051A	Hewlett-Packard	2/1/07
Pre-Amp	83017A	Hewlett-Packard	2/1/07
High Pass Filter	9701	CMT	2/1/07
Horn Antenna	3115	EMCO	2/1/07
Cable		Hewlett Packard	2/1/07

Note: The HP 84125B EMC Analyzer System is calibrated as a system, including the analyzer, pre-amps, filters, and cable.

EN 55022 (AC powerline conducted emissions)

Equipment	Type	Manufacturer	Calibration Due Date
Spectrum analyzer	8568B	Hewlett-Packard	2/1/07
LISN	3810/2	EMCO	10/1/06
Coaxial cable	N Type – BNC (5 Meters)	Own	10/1/06