



Test Report No. 8812315253

For ElmoTech Ltd.

Equipment Under Test:

Ankle transceiver

Model: TRXS830

FCC ID: LSQ-TRXS-830

***From The Standards Institution
Of Israel
Industry Division
Electronics & Telematics Laboratory
EMC Section***



**Test Report No.:** 8812315253

Page 1 of 23 pages

Title: Test on Ankle transceiver**FCC ID:** LCQ-TRXS-830**Model:** TRXS830

Order placed by:	ElmoTech Ltd.
Address:	2 Habarzel Street, POB 13236, Tel-Aviv, Israel
Sample for test selected by:	The customer
The date of test:	January 2008

Description of Equipment Under Test (EUT):	Ankle transceiver.
Model:	TRXS830
Serial Number:	078FC57236
Manufactured by:	ElmoTech Ltd

Reference Documents:

- ❖ CFR 47 FCC: Rules and Regulations; Part 15. "Radio frequency devices";
Subpart B: "Unintentional radiators" (2007)
Subpart C: "Intentional radiators" (2007),
Section 15.205. "Restricted bands of operations",
Section 15.209. "Radiated emission limits, general requirements".
"Radiated Emission Limits, Additional Provisions";
Section 15.231. "Periodic operation in the bands 40.66 – 40.70 MHz,
and above 70 MHz".

This Test Report contains 23 pages and may be used only in full.	This Test Report applies only to the specimen tested and may not be applied to other specimens of the same product.
---	--



Test Report No.: 8812315253

Page 2 of 23 pages

Title: Test on Ankle transceiver

FCC ID: LCQ-TRXS-830

Model: TRXS830

Table of Contents

1. EUT Description and operation	3
1.1. General description:	3
2. Test summary	4
2.1. Potential emission sources:	7
2.2. EUT setup and operation:	7
3. Measurements, examinations and derived results	7
3.1. Location of the Test Site:	7
3.2. Test condition:	7
3.3. Initial visual check and functional test:	7
3.4. Radiated emission test.	8
3.5. Common conditions for operation in the band above 70MHz.	9
3.6. Test of field strength emission from intentional radiator.	10
3.7. Test of occupied bandwidth per 15.231(c)	19
4. Appendix 1. Test equipment used	20
5. Appendix 2: Antenna Factor and Cable Loss	21

1. EUT Description and operation

1.1. General description:

* Note: the customer supplied all information in clause below.

The TRXS830 is a portable transceiver 318 MHz carrier frequency attached to the client's wrist or ankle. The transceiver shall transmit the identification data with random interval 10 to 22 seconds with additional data regarding tamper attempts and battery status to the AMS network.

Declare maximum EIRP power:	-2 dBm @ 318 MHz
Type of modulation:	MSK
Antenna type:	Integrated on PCB

The EUT dimensions: 67 mm x 42 mm x 17 mm. Power source: 3.6 Volt Lithium battery.
The EUT's block diagram is shown in Figures 1

External and internal views are presented in Photo #1.

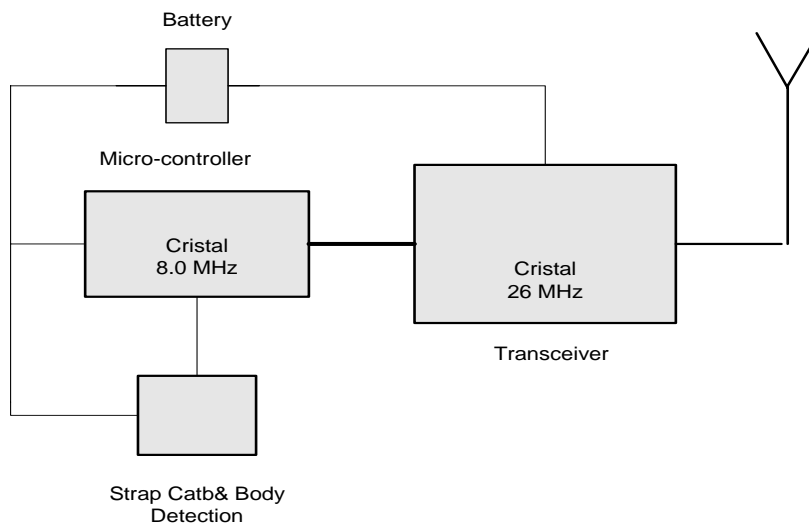

Figure 1. Transceiver block diagram.

**Test Report No.:** 8812315253

Page 4 of 23 pages

Title: Test on Ankle transceiver**FCC ID:** LCQ-TRXS-830**Model:** TRXS830

2. Test summary

Parameter	FCC Part 15 Reference paragraph	Comply/not comply with the requirements
Radiated emission test.	Subpart B Section 15.109	Comply
Test of field strength emission from intentional radiators	"Radiated Emission Limits, Additional Provisions"; Section 15.231.	Comply
Radiated emission from intentional radiators in restricted bands	Subpart C Section 15.205	Comply
Occupied bandwidth	Subpart C Section 15.231	Comply

Name: Eng. Yuri Rozenberg
Position: Head of EMC Branch

Telematics
Laboratory

February 2008

Name: Michael Feldman
Position: Test Technician

Test Report No.: 8812315253

Page 5 of 23 pages

Title: Test on Ankle transceiver

FCC ID: LCQ-TRXS-830

Model: TRXS830



Photo 1. EUT's external and internal view

Test Report No.: 8812315253

Page 6 of 23 pages

Title: Test on Ankle transceiver

FCC ID: LCQ-TRXS-830

Model: TRXS830



Photo 2. Spurious emissions test setup.



Photo 3. Spurious emissions test setup.

**Test Report No.:** 8812315253

Page 7 of 23 pages

Title: Test on Ankle transceiver**FCC ID:** LCQ-TRXS-830**Model:** TRXS830

2.1. Potential emission sources:

The potential emission sources are detailed in Table 1.

Table 1. Potential emission sources

Frequency	Location
8.0 MHz crystal	PCB RC oscillator
26.0 MHz crystal	PCB
318 MHz RF signal	Base unit

2.2. EUT setup and operation:

Respective tests were performed in Transmission (Tx) and Receiving (Rx) modes. Measurements of transceiver were performed in continue transmittion mode.

3. Measurements, examinations and derived results

3.1. Location of the Test Site:

Preliminary radiated test was conducted at the EMC laboratory of the Standards Institution of Israel in Tel-Aviv.

Final tests were conducted in an Open Area Test Site located at Kibbutz Native Halamed Hai in Emek HaEla, Israel.

3.2. Test condition:

Temperature: 21 °C. Humidity: 59 %. Atmospheric pressure: 1011 mbar.

3.3. Initial visual check and functional test:

Initial visual check and brief built- in- test of the EUT was performed before testing.

- No external damages were found.
- The test on the EUT passed successfully.

**Test Report No.:** 8812315253

Page 8 of 23 pages

Title: Test on Ankle transceiver**FCC ID:** LCQ-TRXS-830**Model:** TRXS830

3.4. Radiated emission test.

3.4.1. General:

Per FCC Part 15 Subpart B Section 15.109 and Subpart C Sections 15.209, 15.231.

- * Initial scans were made using a peak detector but still using the appropriate ANSI IF bandwidth.
- * A tolerance limit was set 10 dB below the specification limit. Levels above the tolerance limit were retested using the Peak detector.

3.4.2. Preliminary radiated emission tests:

Preliminary investigation was performed up to ten harmonic of carrier frequency. Test was conducted in a semi-anechoic chamber at distance 3 meters. The EUT was setup in its typical configuration and operated in its various modes. For each mode of operation the frequency spectrum was monitored. EUT configuration, cable configuration and mode of operation, which produced the maximum level of emission, were documented. A list of frequencies to be tested was prepared.

3.4.3. Final measurements:

The final radiated emission measurements were performed at the Open Area Test Site at the same (3 m) test distance. Test was started with a new fresh battery. Measured voltage was 3.6V The EUT was operated as described above. The EUT was installed on a turn - table. Biconilog and Double Ridged Guide antennas were used. The measurements were performed at each frequency that founded previously at which the signal level was 10 dB below the limit or less. The levels were maximized by rotating through three orthogonal axes, rotating turntable through 360° and changing antenna-to-EUT polarization from vertical to horizontal. The worse case result was noted in tables.

3.4.4. Radiated emission test results:

Test result in receive mode were found below SA noise floor and at least 15 dB under the section 15.109 specified limit. For plot result in receive mode refer to plots #10 and #11. Final result measurements in transmit mode are presented in tables and plots#1 - #9 in section 2.6.5.



Test Report No.: 8812315253

Page 9 of 23 pages

Title: Test on Ankle transceiver

FCC ID: LCQ-TRXS-830

Model: TRXS830

3.5. Common conditions for operation in the band above 70MHz.

3.5.1. General:

Per FCC Part 15 Subpart C clause 15.231 (a).

3.5.2. Requirements:

15.231(a) – Transmitter is defined as a part of alarm system.

15.231(a)(1) – Not applicable. Transmitter is not activated manually.

15.231(a)(2) – Transmission duration is limited by program and after activation is less than 5 second. (See plot # 12).

15.231(a)(3) – Transmitter not intended for regular predetermined interval transmissions.

15.231(a)(4) – Not applicable. Transmitter is not operates during the pendency of the alarm conditions.

15.231(a)(5) - Transmitter doesn't exceed the limits of this section.

3.5.3. Summary:

The EUT is complies with the requirements of clause 15.231(a).

**Test Report No.:** 8812315253

Page 10 of 23 pages

Title: Test on Ankle transceiver**FCC ID:** LCQ-TRXS-830**Model:** TRXS830

3.6. Test of field strength emission from intentional radiator.

3.6.1. General:

Per FCC Part 15 Subpart C clause 15.231 (b)

3.6.2. Requirements:

The EUT's operation frequency is 318 MHz.

The field strength emissions from intentional radiators operated on this frequency shall comply with the limit based on the average value.

Fundamental Frequency	Calculated Field Strength limit of Fundamental dB ($\mu\text{V/m}$)	Calculated Field Strength limit of Harmonics dB ($\mu\text{V/m}$)
318 MHz	75.8	55.8

Note: Peak field strength shall not exceed the maximum permitted specified limit by more than 20 dB.

Field strength limits are specified at a distance of 3 meters.

3.6.3. Test procedure:

The test was conducted according to clause 15.231.

3.6.4. Test summary:

The tested unit meets the standard requirement.

**Test Report No.:** 8812315253

Page 11 of 23 pages

Title: Test on Ankle transceiver**FCC ID:** LCQ-TRXS-830**Model:** TRXS830**3.6.5. Test results:**

Carrier frequency MHz	Peak Ampl. dB ($\mu\text{V}/\text{m}$)	Peak Limit dB ($\mu\text{V}/\text{m}$)	Margin dB	Avg Ampl.* dB ($\mu\text{V}/\text{m}$)	Specified @3m limit, dB ($\mu\text{V}/\text{m}$)	Margin dB
318.0	91.2	95.8	4.6	57.2	75.8	18.6

*Average amplitude result was calculated from measured Peak value – Average factor.

For recorded Fundamental frequencies result see plots #1.

All received spurious emissions were found below the specified limit.

Founded spurious emissions results presented in tables below.

Spurious emissions test result.

Freq. MHz	Peak Ampl dB ($\mu\text{V}/\text{m}$)	Peak limit dB ($\mu\text{V}/\text{m}$)	Margin dB	Avg Ampl** dB ($\mu\text{V}/\text{m}$)	Specified @3m limit, dB ($\mu\text{V}/\text{m}$)	Margin dB	Reference Plot
635.94	57.6	75.8	18.2	23.6	55.8	32.2	Plot #4
954.1	75.5	75.8	0.3	41.5	55.8	14.3	Plot #5
1590.0	51.8	74.0*	22.2	17.8	54.0*	36.2	Plot #6
2226.0	52.4	74.0*	21.6	18.4	54.0*	35.6	Plot #7
2862.0	59.0	74.0*	15.0	25.0	54.0*	29.0	Plot #8
3180.0	49.8	75.8	26.0	15.8	55.8	40.0	Plot #9

*Limit 15.205 restricted bands.

**Average amplitude result was calculated from measured Peak value – Average factor.

Average factor = $20 \text{ Log Tx on}/100\text{msec} = 20 \text{ Log } [2 \text{ ms}/100] = -34 \text{ dB}$

For transmitter average factor calculation see plots ## 12, 13.



Test Report No.: 8812315253

Page 12 of 23 pages

Title: Test on Ankle transceiver

FCC ID: LCQ-TRXS-830

Model: TRXS830

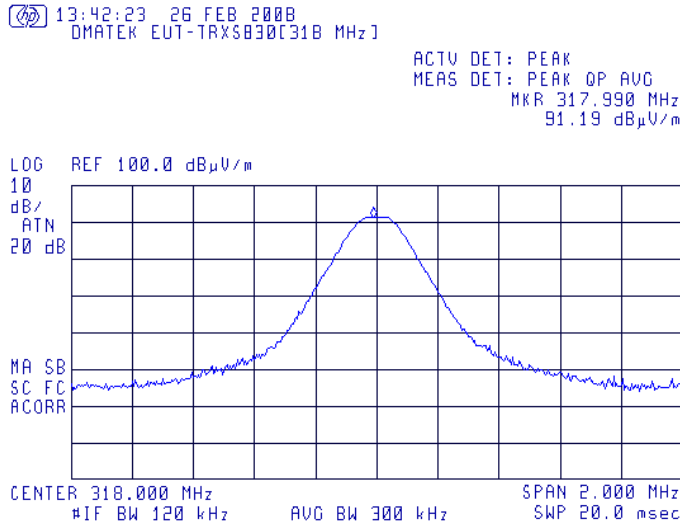

Plot # 1. Field strength of fundamental frequency 318 MHz.

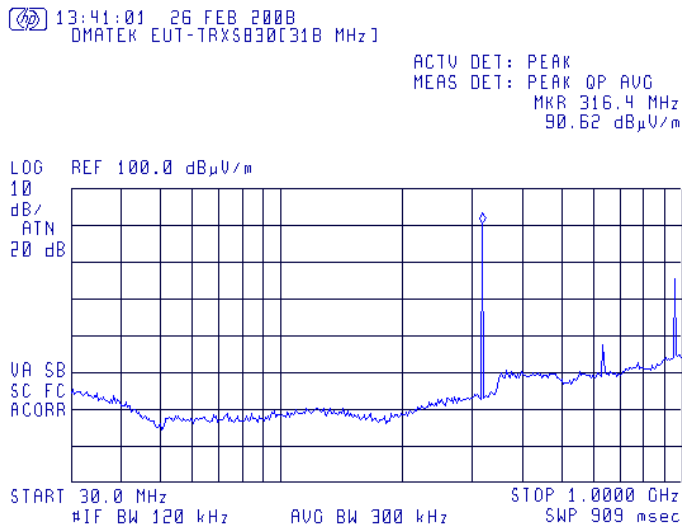

Plot # 2. Spurious emissions scan 30 – 1000 MHz. Test distance =3m.



Test Report No.: 8812315253

Page 13 of 23 pages

Title: Test on Ankle transceiver

FCC ID: LCQ-TRXS-830

Model: TRXS830

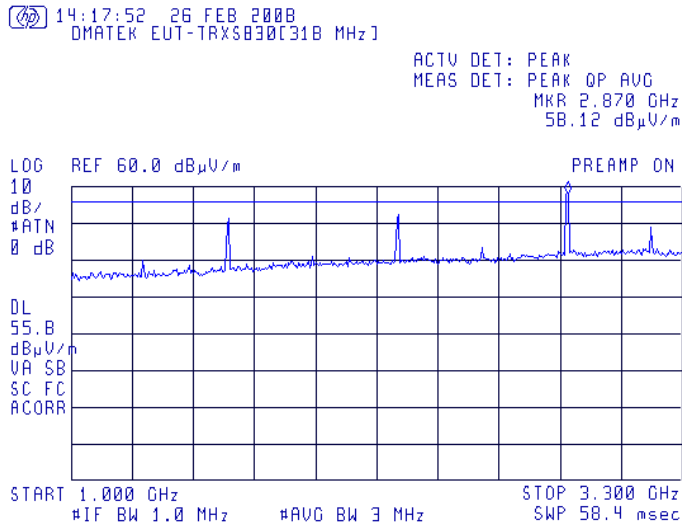

Plot # 3. Spurious emissions scan at 1 GHz – 3.3 GHz frequency range.

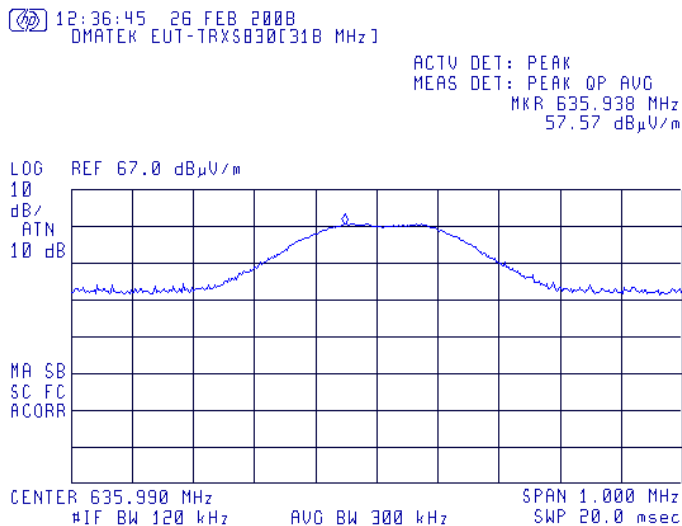

Plot # 4. The carrier frequency second harmonic. Detector peak.



Test Report No.: 8812315253

Page 14 of 23 pages

Title: Test on Ankle transceiver

FCC ID: LCQ-TRXS-830

Model: TRXS830

12:41:41 26 FEB 2008
DMATEK EUT-TRXS830[31B MHz]

ACTV DET: PEAK
MEAS DET: PEAK OP AVG
MKR 954.098 MHz
75.53 dBμV/m

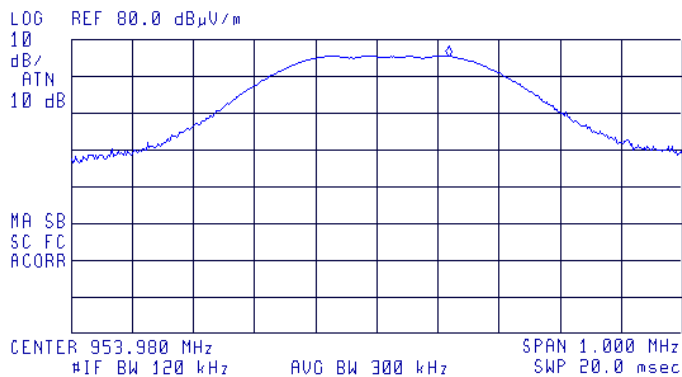

Plot # 5. The carrier frequency third harmonic. Detector peak.

13:58:22 26 FEB 2008
DMATEK EUT-TRXS830[31B MHz]

ACTV DET: PEAK
MEAS DET: PEAK OP AVG
MKR 1.590000 GHz
51.76 dBμV/m

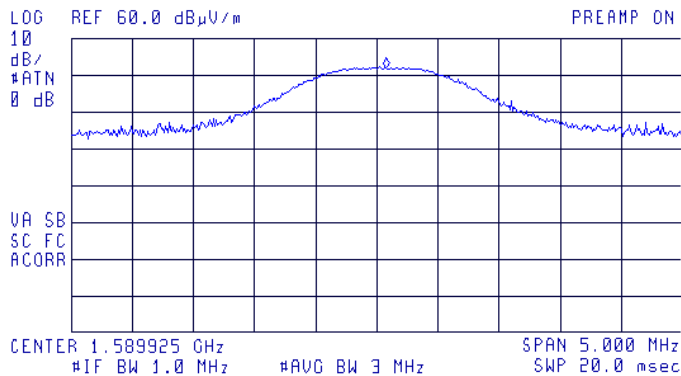

Plot # 6. The carrier frequency 5 th harmonic. Detector peak.



Test Report No.: 8812315253

Page 15 of 23 pages

Title: Test on Ankle transceiver

FCC ID: LCQ-TRXS-830

Model: TRXS830

14:00:34 26 FEB 2008
DMATEK EUT-TRXS830(31B MHz)

ACTV DET: PEAK
MEAS DET: PEAK QP AVG
MKR 2.225980 GHz
52.42 dBμV/m

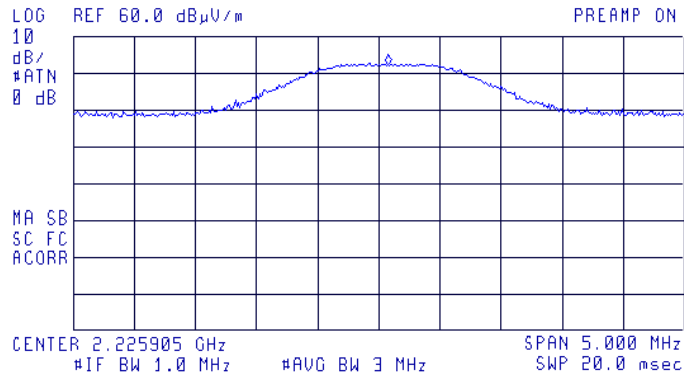

Plot # 7. The carrier frequency 7 th harmonic. Detector peak.

14:02:44 26 FEB 2008
DMATEK EUT-TRXS830(31B MHz)

ACTV DET: PEAK
MEAS DET: PEAK QP AVG
MKR 2.861998 GHz
59.00 dBμV/m

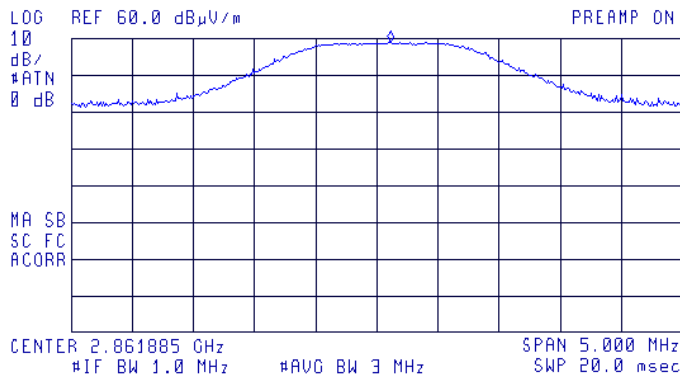

Plot # 8. The carrier frequency 9 th harmonic. Detector peak.



Test Report No.: 8812315253

Page 16 of 23 pages

Title: Test on Ankle transceiver

FCC ID: LCQ-TRXS-830

Model: TRXS830

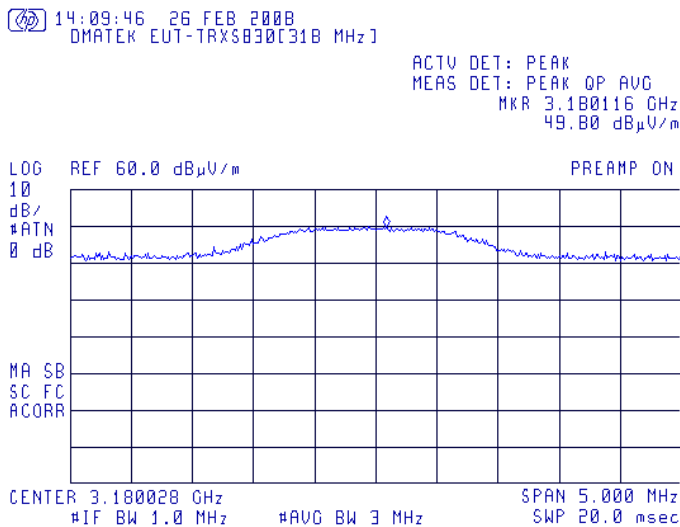

Plot # 9. The carrier frequency 10 th harmonic. Detector peak.

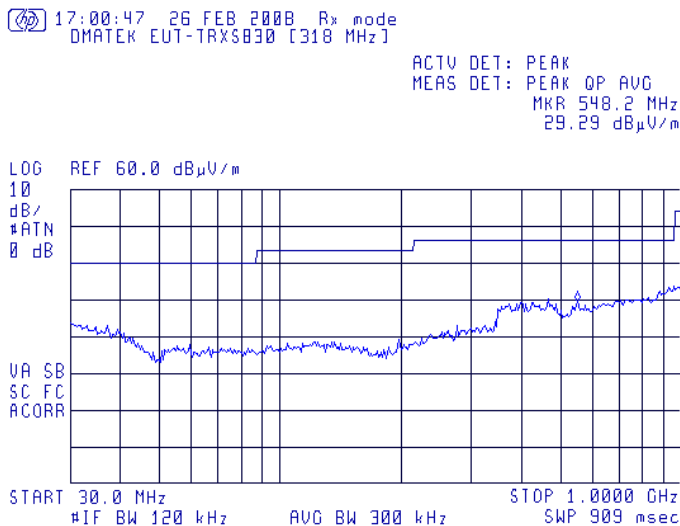

Plot # 10. Rx mode. Scan of spurious emissions
Frequency range from 30 MHz to 1000 MHz. Test distance =3m.



Test Report No.: 8812315253

Page 17 of 23 pages

Title: Test on Ankle transceiver

FCC ID: LCQ-TRXS-830

Model: TRXS830

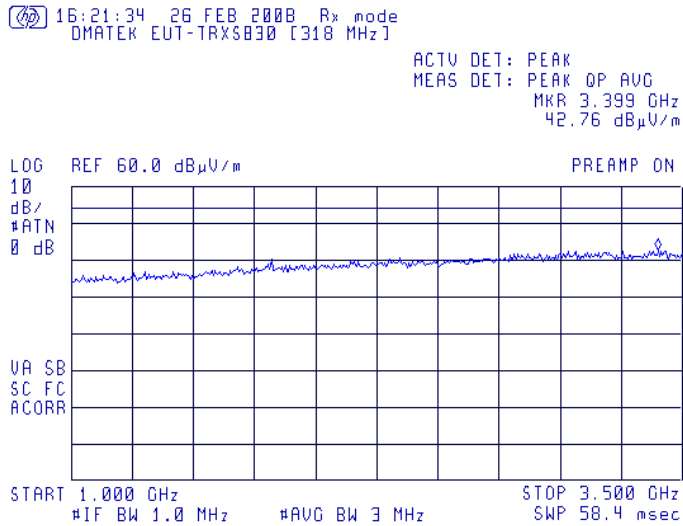

**Plot # 11. Rx mode. Scan of spurious emissions.
Frequency range from 1 GHz to 3.5 GHz. Test distance =3m**



Test Report No.: 8812315253

Page 18 of 23 pages

Title: Test on Ankle transceiver

FCC ID: LCQ-TRXS-830

Model: TRXS830

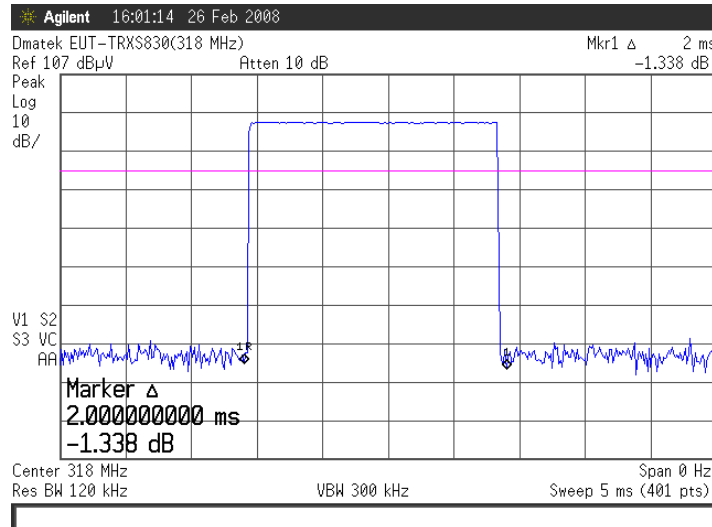

Plot # 12. Transmission duration - Tx on.

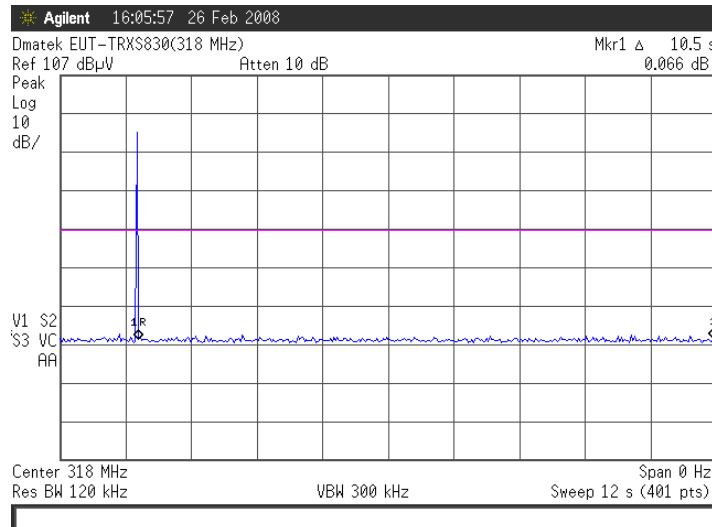

Plot # 13. Transmission duration - Tx off

AVG factor was calculated as $20 \text{ Log (Tx on/100 msec)} = 20 \text{ Log } [(2 \text{ ms})/100] = -34 \text{ dB}$



Test Report No.: 8812315253

Page 19 of 23 pages

Title: Test on Ankle transceiver

FCC ID: LCQ-TRXS-830

Model: TRXS830

3.7. Test of occupied bandwidth per 15.231(c)

3.7.1. Requirements:

The bandwidth of the emissions shall be no wider than 0.25% of the center frequency for devices operating above 70 MHz and below 900 MHz. Bandwidth is determined at the points 20 dB down from the centre of modulated carrier.

For 318 MHz centre frequency allowed occupied bandwidth shall be less than $(318/100) \cdot 0.25 = 0.795$ MHz.

3.7.2. Test results:

Test result is presented in plot # 14 below.

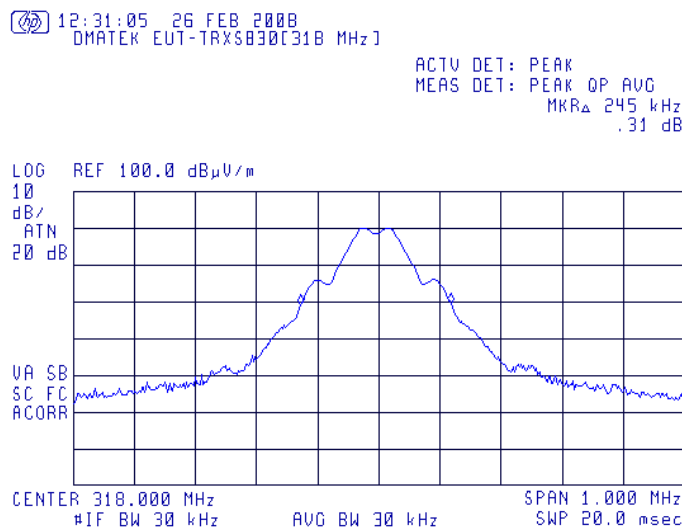

Plot # 14. Occupied bandwidth test result

3.7.3. Test summary:

20 dB occupied bandwidth is 245 kHz.

The tested unit meets the standards requirements.

**Test Report No.:** 8812315253

Page 20 of 23 pages

Title: Test on Ankle transceiver**FCC ID:** LCQ-TRXS-830**Model:** TRXS830

4. Appendix 1. Test equipment used

All measurements equipment is on SII calibration schedule with a recalibration interval not exceeding one year.

Instrument	MFR	Model	Serial No.	Due calibration date
EMI Receiver 9 kHz – 6.5 GHz	HP	8546A+85460 A	SII 4068	March 2008
Biconilog Antenna 30 – 2000 MHz	Teseq GmbH	CBL 6112D	S/N 23181	May 2008
EMI Analyser 9 kHz - 26.5 GHz	HP	E7405A	SII 4944	October 2008
Antenna Double Ridged Guide, 1-18 GHz	EMCO	3115	SII4873	March 2008
Oscilloscope	HP	54610B	US37340682	May 2008
RF cable, 3m	Sucoflex	104PE	21328/4PE	Oct 2008
Antenna Mast	R&S	HCM	100002	N/A
Metallic turntable	R&S	HCT12	100001	N/A
Positioning controller	R&S	HCC	100002	N/A

**Test Report No.:** 8812315253

Page 21 of 23 pages

Title: Test on Ankle transceiver**FCC ID:** LCQ-TRXS-830**Model:** TRXS830

5. Appendix 2: Antenna Factor and Cable Loss

Cable Loss (10m cable + Mast)

Point	Frequency (MHz)	Cable Loss (dB)	Point	Frequency (MHz)	Cable Loss (dB)
1	30	0.53	21	1000	3.68
2	50	0.75	22	1100	3.82
3	100	1.08	23	1200	4.07
4	150	1.39	24	1300	4.24
5	200	1.61	25	1400	4.43
6	250	1.752	26	1500	4.6
7	300	2.00	27	1600	4.7
8	350	2.15	28	1700	4.85
9	400	2.26	29	1800	4.98
10	450	2.383	30	1900	5.19
11	500	2.52	31	2000	5.34
12	550	2.606	32	2100	5.51
13	600	2.75	33	2200	5.69
14	650	2.856	34	2300	5.89
15	700	3.06	35	2400	6.07
16	750	3.20	36	2500	6.22
17	800	3.27	37	2600	6.28
18	850	3.38	38	2700	6.41
19	900	3.46	39	2800	6.53
20	950	3.55	40	2900	6.84



Test Report No.: 8812315253

Page 22 of 23 pages

Title: Test on Ankle transceiver

FCC ID: LCQ-TRXS-830

Model: TRXS830

Table 2. Antenna Factor

For Bilog Antenna, Model Number: CBL 6112D, S/N: 23181

No.	f / MHz)	AF / dB/m	f / MHz)	AF / dB/m	f / MHz)	AF / dB/m	f / MHz)	AF / dB/m
1	30	17.90	170	9.40	530	17.70	1040	22.20
2	32	16.70	175	9.00	540	18.25	1060	22.50
3	34	15.55	180	8.50	550	18.60	1080	22.50
4	36	14.35	185	8.45	560	14.45	1100	22.40
5	38	13.30	190	8.60	570	18.40	1120	22.60
6	40	12.20	195	8.85	580	18.50	1140	22.45
7	42	11.05	200	8.95	590	18.60	1160	22.50
8	44	9.95	205	8.80	600	18.60	1180	22.40
9	46	8.90	210	8.50	610	18.80	1200	22.80
10	48	8.05	215	8.20	620	18.99	1220	22.95
11	50	7.30	220	8.50	630	19.05	1240	23.10
12	52	6.80	225	9.00	640	19.23	1260	23.40
13	54	6.45	230	9.65	650	19.10	1280	23.35
14	56	6.00	235	10.30	660	19.13	1300	23.62
15	58	5.70	240	11.00	670	19.04	1320	23.64
16	60	5.45	245	11.60	680	19.00	1340	23.86
17	62	5.30	250	12.00	690	19.17	1360	23.95
18	64	5.20	255	12.45	700	19.28	1380	23.90
19	66	5.30	260	12.85	710	19.25	1400	24.45
20	68	5.30	265	12.50	720	19.45	1420	24.74
21	70	5.35	270	12.45	730	19.75	1440	24.93
22	72	5.50	275	12.40	740	19.95	1460	25.03
23	74	5.80	280	12.55	750	20.07	1480	25.45
24	76	6.00	285	12.65	760	19.85	1500	25.30
25	78	6.60	290	12.75	770	19.80	1520	25.25
26	80	6.70	295	12.95	780	19.85	1540	25.36
27	82	7.15	300	13.00	790	19.95	1560	25.58
28	84	7.60	310	13.35	800	20.05	1580	25.50
29	86	8.10	320	13.75	810	20.10	1600	25.65
30	88	8.50	330	13.85	820	20.35	1620	25.60
31	90	8.90	340	14.10	830	20.40	1640	25.70
32	92	9.20	350	14.50	840	20.35	1660	25.83
33	94	9.75	360	14.70	850	20.46	1680	25.97
34	96	9.95	370	14.90	860	20.39	1700	26.10
35	98	10.20	380	15.10	870	20.29	1720	26.25
36	100	10.50	390	15.45	880	20.24	1740	26.04
37	105	11.25	400	16.00	890	20.35	1760	26.14
38	110	11.70	410	16.40	900	20.55	1780	26.20
39	115	11.70	420	16.70	910	20.45	1800	26.40
40	120	11.80	430	16.35	920	20.60	1820	26.64
41	125	11.80	440	16.30	930	20.60	1840	26.86
42	130	11.70	450	16.30	940	20.66	1860	27.12
43	135	11.35	460	16.70	950	20.88	1880	27.00
44	140	10.95	470	17.05	960	21.11	1900	27.25
45	145	10.35	480	17.20	970	20.93	1920	27.36
46	150	10.05	490	17.30	980	21.03	1940	27.68
47	155	9.70	500	17.40	990	21.05	1960	27.10
48	160	9.70	510	17.50	1000	21.10	1980	27.06
49	165	9.45	520	17.60	1020	21.40	2000	27.25



Test Report No.: 8812315253

Page 23 of 23 pages

Title: Test on Ankle transceiver

FCC ID: LCQ-TRXS-830

Model: TRXS830

Antenna Factor

Double Ridged Guide Antenna mfr EMCO model 3115 1m calibration

Point	Frequency (MHz)	Antenna Factor (dB/m)
1	1000	23.9
2	2000	28.3
3	3000	31.0
4	4000	33.1
5	4500	32.5
6	5000	32.4
7	6000	53.7
8	6500	35.6
9	7000	36.4
10	7500	36.9
11	8000	37.0
12	8500	38.0
13	9000	38.6
14	9500	38.4
15	10000	38.4
16	10500	38.4
17	11000	38.9
18	11500	39.6
19	12000	39.4
20	12500	39.2
21	13000	40.3
22	13500	41.0
23	14000	41.2
24	14500	41.3
25	15000	40.0
26	15500	38.0
27	16000	38.1
28	16500	40.3
29	17000	42.2
30	17500	44.6
31	18000	46.2

Cable Loss

Type: Sucoflex 104PE; Ser.No.21328/4PE; 3 m length

Point	Frequency (GHz)	Cable Loss (dB)
0	0.0-1.8	1.67
1	1.8 – 3.6	2.39
2	3.6 – 5.4	3.04
3	5.4-7.2	3.58
4	7.2-9.0	4.06
5	9.0-10.8	4.49
6	10.8-12.6	4.91
7	12.6-14.4	5.31
8	14.4-16.2	5.66
9	16.2-18.00	6.01