

2



Test report No:
NIE: 52668RAN.001

Test report
REFERENCE STANDARDS:
FCC 47 CFR Part 2.1093
ISED RSS -102 Issue 5:2015

Identification of item tested.....:	ITE
Trademark	3M One Piece GPS Tracking Device 4i
Model and /or type reference	1Piece GPS TD4i
Other identification of the product	FCC ID: LSQ-TD4i-433
Final HW version	(Prototype) 100
Final SW version	4.10.56.29
Features	GSM/GPRS/EDGE 850, 1900 MHz Bands WCDMA FDD Bands II, IV, V RF 433.92 MHz
Manufacturer	3M ELECTRONIC MONITORING 2 Habarzel St. Tel-Aviv, 69710, Israel
Test method requested, standard.....:	1. FCC 47 CFR Part 2.1093. (10-1-15 Edition) Radiofrequency radiation exposure evaluation: portable devices. 2. ISED RSS-102 Issue 5 (2015-03) – Radio Frequency Exposure Compliance of Radiocommunication Apparatus (All Frequency Bands)
Summary	<p>Considering the results of the performed test according to FCC 47CFR Part 2.1093 and IC RSS-102 Issue 5, the item under test is IN COMPLIANCE with the requested specifications specified in the standards.</p> <p>The maximum 10g volume averaged SAR found during this test into the extremity exposure condition has been 0.410 W/kg, for WCDMA Band II.</p> <p>The maximum 10g volume averaged SAR for multiband transmission found during this test has been 0.480 W/kg.</p> <p>NOTE: The results presented in this Test Report apply only to the particular item under test established in page 1 of this document, as presented for test on the date(s) shown in section, “USAGE OF SAMPLES, TESTING PERIOD AND ENVIRONMENTAL CONDITIONS”.</p>

Approved by (name / position & signature)	Miguel Lacave Antennas Lab Manager
Date of issue	2017-04-17
Report template No.....	FDT08_19

Index

Competences and guarantees.....	4
General conditions.....	4
Uncertainty	4
Usage of samples.....	5
Test sample description	5
Identification of the client	5
Testing period.....	5
Environmental conditions.....	5
References	6
Remarks and comments.....	6
Used instrumentation.....	7
Testing verdicts	8
Appendix A – Test configuration	9
Appendix B – Test results	20
Appendix C – Measurement report	35
Appendix D – System Validation Reports	41
Appendix E – Calibration data	44
Appendix F – Photographs	104

Competences and guarantees

DEKRA Testing and Certification is a testing laboratory accredited by the National Accreditation Body (ENAC - Entidad Nacional de Acreditación), to perform the tests indicated in the Certificate No. 51/LE 147.

In order to assure the traceability to other national and international laboratories, DEKRA Testing and Certification has a calibration and maintenance program for its measurement equipment.

DEKRA Testing and Certification guarantees the reliability of the data presented in this report, which is the result of the measurements and the tests performed to the item under test on the date and under the conditions stated on the report and, it is based on the knowledge and technical facilities available at DEKRA Testing and Certification at the time of performance of the test.

DEKRA Testing and Certification is liable to the client for the maintenance of the confidentiality of all information related to the item under test and the results of the test.

The results presented in this Test Report apply only to the particular item under test established in this document.

IMPORTANT: No parts of this report may be reproduced or quoted out of context, in any form or by any means, except in full, without the previous written permission of DEKRA Testing and Certification.

General conditions

1. This report is only referred to the item that has undergone the test.
2. This report does not constitute or imply on its own an approval of the product by the Certification Bodies or competent Authorities.
3. This document is only valid if complete; no partial reproduction can be made without previous written permission of DEKRA Testing and Certification.
4. This test report cannot be used partially or in full for publicity and/or promotional purposes without previous written permission of DEKRA Testing and Certification and the Accreditation Bodies.

Uncertainty

Uncertainty (factor $k=2$) was calculated according to the following documents:

1. FCC OET KDB 865664 D01 - SAR Measurement Requirements for 100 MHz to 6 GHz v01r04 (August 2015).

Usage of samples

Samples undergoing test have been selected by: the client

Sample M/01 is composed of the following elements:

Control N°	Description	Model	Serial N°	Date of reception
50686/01	GPRS Tracking Device	1Piece GPS TD4i	34688803	2017-01-04

Sample M/02 is composed of the following elements:

Control N°	Description	Model	Serial N°	Date of reception
50686/14	GPRS Tracking Device	1Piece GPS TD4i	34688841	2017-01-25

1. Sample M/01 has undergone the test(s) specified in subclause “Test method requested”: Conducted average output power.
2. Sample M/02 has undergone the test(s) specified in subclause “Test method requested”: SAR evaluation for 2G, 3G, LTE and 802.11 modes.

Test sample description

The test sample consists of a GPS Tracking Device.

Identification of the client

3M ELECTRONIC MONITORING
2 Habarzel St. Tel-Aviv, 69710, Israel

Testing period

The performed test started on 2017-03-09 and finished on 2017-03-15.

The tests have been performed at DEKRA wireless.

Environmental conditions

In the laboratory for measurements, the following limits were not exceeded during the test:

Temperature	Min. = 20.06 °C Max. = 24.13 °C
Relative humidity	Min. = 42.82 % Max. = 57.89 %

References

The tests documented in this report were performed in accordance with FCC 47 CFR § 2.1093, IC RSS-102 Issue 5 (2015-03) – Radio Frequency Exposure Compliance of Radiocommunication Apparatus (All Frequency Bands) and the following FCC Published RF exposure KDB procedures:

1. FCC OET KDB 447498 D01 General RF Exposure Guidance v06 (October 2015)
2. FCC OET KDB 865664 D01 - SAR Measurement Requirements for 100 MHz to 6 GHz v01r04 (August 2015).
3. FCC OET KDB 865664 D02 RF Exposure Reporting v01r02 (October 2015)
4. FCC OET KDB 941225 D01 3G SAR Procedures v03r01 (October 2015).

Remarks and comments

1: Only the plots of the highest reported SAR for each test position and mode/band are included in appendix C.

2: In order to perform testing, the curved hard parts of the back side of the device have been cut and sanded. The device has been tested placed directly against the phantom surface with its back face towards the flat phantom. (See “Appendix F – Photographs” for more details)

3: According to FCC OET KDB 941225 D01 3G SAR Procedures, SAR test reduction for 2G has been determined by the source-based time-averaged output power specified for production units, including tune-up tolerance. The mode with highest specified time-averaged output power has been tested for SAR compliance in the applicable exposure conditions.

4: Testing of GPRS EDGE mode is not required according to test reductions mentioned in FCC OET KDB 941225 D01 3G SAR Procedures, paragraph “5. GSM, GPRS and EDGE”

5: Testing of HSDPA/HSPA modes are not required according to paragraph “2.1 3G SAR test reduction procedure” mentioned in FCC OET KDB 941225 D01 3G SAR Procedures.

6: Testing of RF signal mode is not required according to FCC OET KDB 447498 D01 General RF Exposure Guidance v06, paragraph “4.3.1. Standalone SAR test exclusion considerations” and to IC RSS-102 Issue 5 (2015-03) – Radio Frequency Exposure Compliance of Radiocommunication Apparatus (All Frequency Bands), paragraph 2.5.1 Exemption Limits for Routine Evaluation – SAR Evaluation.

Used instrumentation

1. Dosimetric E-field probes SPEAG EX3DV4
2. Data acquisition device SPEAG DAE4
3. Electro-optical converter SPEAG EOC3
4. 900 MHz dipole validation kit SPEAG D900V2
5. 1800MHz dipole validation kit SPEAG D1800V2
6. Robot Stäubli RX60BL
7. Robot controller Stäubli CM7MB
8. SAR measurement software SPEAG DASYS2 V52.8.8.1222
9. SAR post processing software SPEAG SEMCAD X
10. Measurement server SPEAG DASYS SE UMS 011 BS
11. Oval flat phantom SPEAG ELI 4
12. Body Tissue Equivalent Liquids for 900MHz and 1800MHz bands
13. Radio Communication Tester R&S CMU 200
14. Wideband Radio Communication Tester R&S CMW 500
15. Vector network analyzer Agilent FieldFox N9923A and Agilent E5071C.
16. Dielectric probe kit SPEAG DAK-3.5
17. Power sensor DC 50 MHz to 18 GHz R&S model NRP-Z91
18. Power meter Agilent E4419B
19. RF Generator R&S SMU200A
20. DC Power supply Agilent U8002A
21. Dual directional coupler NARDA FSCM 99899
22. Dual directional coupler HP 778D.
23. Power amplifier MITEQ AMF-4D-00400600-50-30P
24. 6 dB attenuator Weinschel 75 A-6-11
25. 20 dB attenuator Weinschel 75 A-20-11
26. SPEAG Mounting Device for Hand-Held Transmitters.
27. Anritsu MT8852A Bluetooth testing unit.
28. Digital thermometer LKM Electronics model DTM300-Spezial
29. Temperature and humidity probe HUMIDIROBE Pico Technology.

Testing verdicts

Not applicable	N/A
Pass	P
Fail	F
Not measured	N/M

FCC 47CFR Part 2.1093 & ISED RSS-102 Issue 5	VERDICT			
	NA	P	F	NM
GSM/GPRS/EDGE 850		P		
GSM/GPRS/EDGE 1900		P		
WCDMA/HSDPA/HSPA Band II		P		
WCDMA/HSDPA/HSPA Band IV		P		
WCDMA/HSDPA/HSPA Band V		P		
RF Signal 433MHz		P		

Appendix A – Test configuration

INDEX

1.	GENERAL INTRODUCTION	11
1.1.	Application Standard.....	11
1.2.	General requirements	11
1.3.	Measurement system requirements	11
1.4.	Phantom requirements.....	11
1.5.	Measurement Liquids requirements.....	11
2.	MEASUREMENT SYSTEM.....	12
2.1.	Measurement System	12
2.2.	Test Positions of device relative to body	16
2.3.	Test to be performed	16
2.4.	Description of interpolation/extrapolation scheme	16
2.5.	Determination of the largest peak spatial-average SAR	16
2.6.	System Validation	16
3.	UNCERTAINTY.....	17
4.	SAR LIMIT	18
5.	DEVICE UNDER TEST	18
5.1.	Dimensions.....	18
5.2.	Wireless Technology.....	18
5.3.	Simultaneous Transmission.....	19
5.4.	Antenna Location	19

1. GENERAL INTRODUCTION

1.1. Application Standard

The Federal Communications Commission (FCC) sets the limits for General Population/Uncontrolled exposure to radio frequency electromagnetic fields for transmitting devices designed to be used within 20 centimetres of the body of the user under FCC 47 CFR Part 2.1093 - “Radiofrequency radiation exposure evaluation: portable devices”, paragraph (d)(2).

Industry of Canada (ISED) sets the limits for General Population/Uncontrolled environment when the exposure occurs at a distance of 0.2 m or less into the RSS-102 Issue 5, paragraph 4 “Exposure Limits”, Table 3.

1.2. General requirements

The SAR measurement has been performed continuing the following considerations and environment conditions:

- The ambient temperature shall be in the range of 18°C to 25°C and the variation shall not exceed +/- 2°C during the test.
- The ambient humidity shall be in the range of and 30% - 70%.
- The device battery shall be fully charged before each measurement.

1.3. Measurement system requirements

The measurement system used for SAR tests fulfils the procedural and technical requirements described at the reference standards used.

1.4. Phantom requirements

The phantom model for body measurements is an elliptical open-top container with a flat bottom, with the following shape and dimensions:

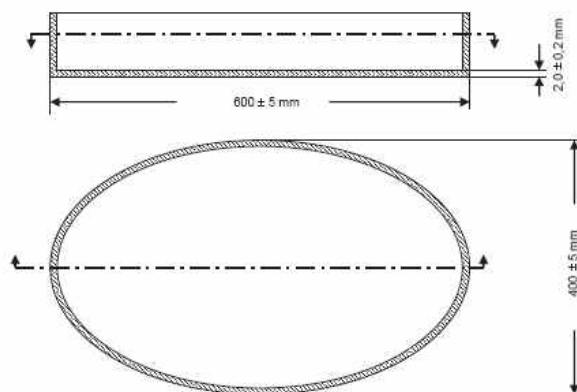

Figure 1: Proportions and shape of Phantom shell

1.5. Measurement Liquids requirements.

The liquids used to simulate the human tissues, must fulfil the requirements of the dielectric properties required. These target dielectric properties per FCC OET KDB 865664 D01 instructions come from the dipole and probe calibration data which are included in Appendix B, Section 3, of this document.

To minimize the effect of reflections on peak spatial-average SAR values, from the upper surface of the tissue-equivalent liquid, the depth of the liquid should be at least 15 cm.

2. MEASUREMENT SYSTEM

2.1. Measurement System

The DASY5 system for performing compliance tests consists of the following items:

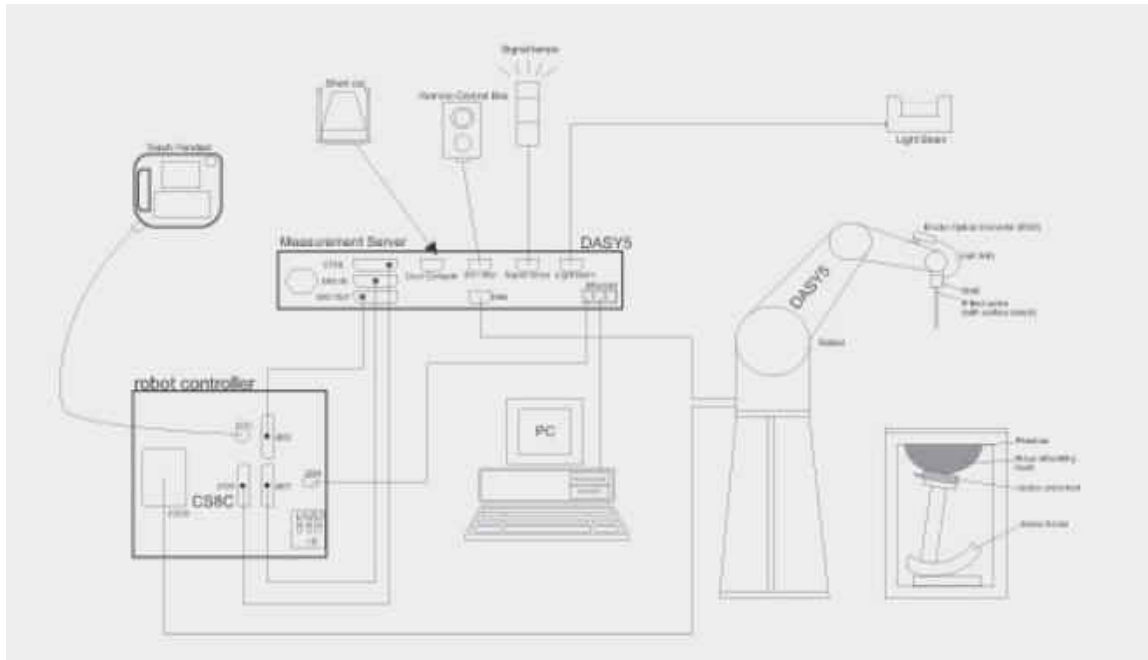



Figure 2: SAR Measurement system

- A standard high precision 6-axis robot (Stäubli TX=RX family) with controller, teach pendant and software. An arm extension for accommodating the data acquisition electronics (DAE).
- An isotropic field probe optimized and calibrated for the targeted measurement.
- A data acquisition electronics (DAE) which performs the signal amplification, signal multiplexing, AD-conversion, offset measurements, mechanical surface detection, collision detection, etc. The unit is battery powered with standard or rechargeable batteries. The signal is optically transmitted to the EOC.
- The Electro-optical converter (EOC) performs the conversion from optical to electrical signals for the digital communication to the DAE. To use optical surface detection, a special version of the EOC is required. The EOC signal is transmitted to the measurement server.
- The function of the measurement server is to perform the time critical tasks such as signal filtering, control of the robot operation and fast movement interrupts.
- The Light Beam used is for probe alignment. This improves the (absolute) accuracy of the probe positioning.
- A computer running Win7 professional operating system and the DASY5 software.
- Remote control and teach pendant as well as additional circuitry for robot safety such as warning lamps, etc.
- The phantom, the device holder and other accessories according to the targeted measurement.

Manufacturer	Device	Type
Schmid & Partner Engineering AG	Dosimetric E-Field Probe	EX3DV4
Schmid & Partner Engineering AG	Data Acquisition Electronics	DAE4
Schmid & Partner Engineering AG	Electro-Optical Converter	EOC3
Stäubli	Robot	RX60BL
Stäubli	Robot controller	CS7MB
Schmid & Partner Engineering AG	Measurement Server	DASY5 SE UMS 011 BS
Schmid & Partner Engineering AG	Oval flat phantom	SPEAG ELI 4
Schmid & Partner Engineering AG	Mounting Device for Hand-Held Transmitters	SD000 HD1HA
Schmid & Partner Engineering AG	Measurement Software	DASY52 V52.8.8.1222
Schmid & Partner Engineering AG	Postprocessing Software	SEMCAD X
Schmid & Partner Engineering AG	900 MHz System Validation Dipole	D900V2
Schmid & Partner Engineering AG	1800 MHz System Validation Dipole	D1800V2
Agilent	Vector Network Analyser	FieldFox N9923A
Schmid & Partner Engineering AG	Dielectric Probe Kit	DAK-3.5

Table 1: Measurement Equipment

	Model	EX3DV4
	Construction	Symmetrical design with triangular core. Built-in shielding against static charges. PEEK enclosure material (resistant to organic solvents, e.g., DGBE).
	Frequency	10 MHz to > 6 GHz; Linearity: ± 0.2 dB (30 MHz to 6 GHz)
	Directivity	± 0.3 dB in TSL (rotation around probe axis) ± 0.5 dB in TSL (rotation normal to probe axis)
	Dynamic Range	10 μ W/g to > 100 mW/g Linearity: ± 0.2 dB (noise: typically < 1 μ W/g)
	Dimensions	Overall length: 337 mm (Tip: 20 mm) Tip diameter: 2.5 mm (Body: 12 mm) Typical distance from probe tip to dipole centers: 1.0 mm

	Model	DAE4
	Construction	Signal amplifier, multiplexer, A/D converter, and control logic. Serial optical link communication with DASY4/5 embedded system (fully remote controlled). Two-step probe touch detector for mechanical surface detection and emergency robot stop.
	Measurement Range	-100 to +300 mV (16 bit resolution and two range settings: 4mV, 400mV)
	Input Offset Voltage	< 5 μ V (with auto zero)
	Input Resistance	200 MOhm
	Input Bias Current	< 50 fA

	Model	ELI
	Construction	Phantom for compliance testing of handheld and body-mounted wireless devices in the frequency range of 30 MHz to 6 GHz. ELI is fully compatible with the IEC 62209-2 standard and all known tissue simulating liquids. ELI has been optimized regarding its performance and can be integrated into our standard phantom tables. A cover prevents evaporation of the liquid. Reference markings on the phantom allow installation of the complete setup, including all predefined phantom positions and measurement grids, by teaching three points. The phantom is compatible with all SPEAG dosimetric probes and dipoles.
	Material	Vinylester, glass fiber reinforced (VE-GF)
	Liquid Compatibility	Compatible with all SPEAG tissue simulating liquids (incl. DGBE type)
	Shell Thickness	2 \pm 0.2 mm (bottom plate)
	Dimensions	Major axis: 600 mm Minor axis: 400 mm
	Filling Volume	Approx. 30 liters
	Wooden Support	SPEAG standard phantom table

	Model	Mounting Device for Hand-Held Transmitters
	Construction	In combination with the Twin SAM V5.0/V5.0c or ELI Phantoms, the Mounting Device for Hand-Held Transmitters enables rotation of the mounted transmitter device to specified spherical coordinates. At the heads, the rotation axis is at the ear opening. Transmitter devices can be easily and accurately positioned according to IEC 62209-1, IEEE 1528, FCC, or other specifications. The device holder can be locked for positioning at different phantom sections (left head, right head, flat).
	Material	Polyoxymethylene (POM)

	Model	System Validations Kits 450 MHz – 6 GHz			
	Construction	Symmetrical dipole with I/4 balun. Enables measurement of feedpoint impedance with NWA. Matched for use near flat phantoms filled with tissue simulating solutions.			
	Frequency	450 MHz to 5800 MHz			
	Return Loss	20 dB at specified validation position			
	Dimensions (length and overall height in mm)	Product	Dipole length	Overall height	
		D450V3	290.0	330.0	
D750V3		179.0	330.0		
D900V2		148.5	340.0		
D1800V2		72.5	300.0		
D2000V2		65.0	300.0		
D2450V2		52.0	290.0		
D2600V2	49.2	290.0			
D5GHzV2	20.6	300.0			

2.2. Test Positions of device relative to body

The device under test is a limb-worn device; it would be strapped to the leg of the user while transmitting during its normal use. According to KDB 479498 D01, the device shall be positioned directly against the phantom surface with the back side of the device towards the phantom.

The device under test has two curved hard parts at its back face, which introduce a separation distance between its back face and the flat phantom. In order to perform testing, these hard parts have been cut and sanded; therefore the device has been tested placed directly against the phantom surface with its back face towards the flat phantom. (See “Appendix F – Photographs” for more details)

2.3. Test to be performed

DUT will be placed at the center of flat phantom. The DUT position using during the body SAR tests will be the one where the maximum peak SAR was found. Each data mode, wireless technology and frequency band supported by the device must be tested. Low and high channels for each band should be tested at this position.

If the DUT is also designed to transmit with other configurations (antenna fully extended/retracted, keypad cover opened/closed...), all tests described above shall be performed for each configuration. When considering multi-mode and multi-band mobile phones, all of the tests shall be performed at each transmitting mode/band with the corresponding maximum peak power level.

2.4. Description of interpolation/extrapolation scheme

The local SAR inside the Phantom is measured using small dipole sensing elements inside a probe element. The probe tip must not be in contact with the Phantoms surface in order to minimise measurement errors, but the highest local SAR is obtained from measurements at a certain distances from the shell trough extrapolation. The accurate assessment of the maximum SAR averaged over 1 gr and 10 gr. requires a very fine resolution in the three dimensional scanned data array. Since the measurements have to be performed over a limited time, the measured data have to be interpolated to provide an array of sufficient resolution.

The interpolation of 2D area scan is used after the initial area scan, at a fixed distance from the Phantom shell wall. The initial scan data is collected with approx. 15 mm spatial resolution and this interpolation is used to find the location of the local maximum for positioning the subsequent 3D scanning within a 1 mm resolution.

For the 3D scan, data is collected on a spatially regular 3D grid having 5 mm steps in both directions. After the data collection by the SAR probe, the data are extrapolated in the depth direction to assign values to points in the 3D array closer to the shell wall. A notional extrapolation value is also assigned to the first point outside the shell wall so that subsequent interpolation schemes will be applicable right up to the shell wall boundary.

2.5. Determination of the largest peak spatial-average SAR

To determine the maximum value of the peak spatial-average SAR of a DUT, all device positions, configurations and operational modes should be tested for each frequency band.

The averaging volume shall be chosen as 1gr. of contiguous tissue. The cubic volumes, over which the SAR measurements are averaged after extrapolation and interpolation, are chosen in order to include the highest values of local SAR.

The maximum SAR level for the DUT will be the maximum level obtained of the performed measurements, and indicated in the previous points.

2.6. System Validation

Prior to the SAR measurements, system verification is done to verify the system accuracy. A complete SAR evaluation is done using a half-wavelength dipole as source with the frequency of the mid-band channel of the operating band, or within 10% of this channel.

The measured 1 gr. and 10 gr. SAR should be within 10% of the expected target values specified in the calibration certificate of the dipole, for the specific tissue and frequency used.

3. UNCERTAINTY

According to FCC OET KDB 865664 D01 - SAR Measurement Requirements for 100 MHz to 6 GHz v01r04 (August 2015), as the highest measured 1-g SAR has been < 1.5 W/kg, SAR measurement uncertainty analysis described in IEEE Std 1528-2013 is not required in the actual SAR report, but it has been included for ISO 17025 accreditation.

Uncertainty for 300 MHz – 6 GHz

ERROR SOURCES	Uncertainty value (± %)	Probability distribution	Divisor	(c _i) 1g	(c _i) 10g	Standard uncertainty (1g) (± %)	Standard uncertainty (10g) (± %)
Measurement Equipment							
Probe Calibration	6.550	N	1	1	1	6.550	6.550
Axial Isotropy	4.700	R	√3	0.7	0.7	1.899	1.899
Hemisfericall Isotropy	9.600	R	√3	0.7	0.7	3.880	3.880
Boundary effect	2.000	R	√3	1	1	1.155	1.155
Linearity	4.700	R	√3	1	1	2.714	2.714
System Detection limits	1.000	R	√3	1	1	0.577	0.577
Probe modulation response	6.100	R	√3	1	1	3.522	3.522
Readout electronics	0.300	N	1	1	1	0.300	0.300
Response time	0.800	R	√3	1	1	0.462	0.462
Integration time	2.600	R	√3	1	1	1.501	1.501
RF Ambient noise	3.000	R	√3	1	1	1.732	1.732
RF Ambient reflections	3.000	R	√3	1	1	1.732	1.732
Probe positioner mech. restrictions	0.800	R	√3	1	1	0.462	0.462
Probe positioning with respect to phantom shell	6.700	R	√3	1	1	3.868	3.868
Max. SAR Eval.	4.000	R	√3	1	1	2.309	2.309
Test Sample Related							
Device holder uncertainty	2.900	N	1	1	1	2.900	2.900
Test sample positioning	3.600	N	1	1	1	3.600	3.600
Drift of output power	5.000	R	√3	1	1	2.887	2.887
Phantom and Setup							
Phantom uncertainty (shape and thickness tolerances)	6.600	R	√3	1	1	3.811	3.811
Algorithm for correcting SAR for deviations in permittivity and conductivity	1.900	R	√3	1	0.84	1.097	0.921
Liquid conductivity (meas.)	2.454	N	1	0.78	0.71	1.914	1.742
Liquid permittivity (meas.)	2.454	N	1	0.26	0.26	0.638	0.638
Liquid conductivity – temperature uncertainty	3.400	R	√3	0.78	0.71	1.531	1.394
Liquid permittivity – temperature uncertainty	0.400	R	√3	0.23	0.26	0.053	0.060
Combined standard uncertainty	$u_c = \sqrt{\sum_{i=1}^m c_i^2 \cdot u_i^2}$					12.82	12.76
Expanded uncertainty (confidence interval of 95%)	$ue = 2.00 u_c$					25.64	25.53

Table 2: Uncertainty Assessment for 300 MHz - 6 GHz

4. SAR LIMIT

Having a worst case measurement, the SAR limit is valid for general population/uncontrolled exposure.

The SAR values have to be averaged over a mass of 1 gr. (SAR 1 gr.) with the shape of a cube and averaged over a mass of 10 gr (Extremity SAR 10 gr). These levels couldn't exceed the values indicated in the application Standard:

Standard	Exposure	SAR	SAR Limit (W/kg)
FCC 47 CFR Part 2.1093, Paragraph (d)(2) RSS-102 Issue 5 (2015-03), Paragraph 4	General population/Uncontrolled	SAR _{1 gr.}	1.6
FCC 47 CFR Part 2.1093, Paragraph (d)(2) RSS-102 Issue 5 (2015-03), Paragraph 4	General population/Uncontrolled Extremity	SAR _{10 gr.}	4.0

Table 3: SAR limit

5. DEVICE UNDER TEST

5.1. Dimensions

Dimensions	Millimetres
Height x Width x Depth	80.0 x 55.0 x 30.0
Overall Diagonal:	90.0

Table 4: Dimensions

5.2. Wireless Technology

Wireless Technology	SAR Testing	Frequency Bands	Modes
GSM	Required	850 / 1900	- Voice (GMSK) - GPRS (GMSK, Multi-slot class 33) - EGPRS (8-PSKM, Multi-slot class 33)
W-CDMA	Required	II/IV/V	- UMTS Rel. 99 (Voice & Data) - HSDPA (Rel. 5) - HSPA (Rel.6)
RF Signal	433 MHz	RF Signal	- QPSK

Table 5: Supported modes

5.3. Simultaneous Transmission

Simultaneous transmission evaluation was performed according to FCC OET KDB 447498 D01 General RF Exposure Guidance. The detailed simultaneous transmission combination is:

RF Exposure Condition	Capable Transmit Configurations
Limb-worn	1. GSM 850/1900 + RF 433 MHz 2. WCDMA Band II/IV/V + RF 433 MHz

Table 6: Simultaneous transmission

5.4. Antenna Location

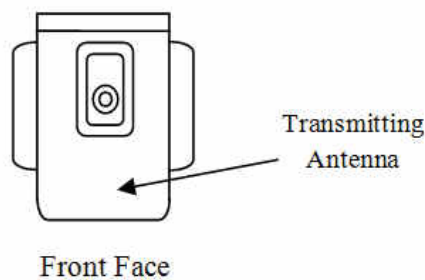

Figure 3: Antenna diagram location sketch

Appendix B – Test results

INDEX

1.	TEST CONDITIONS	22
1.1.	Power supply (V):	22
1.2.	Temperature (°C):	22
1.3.	Test signal, Output Power and Frequencies	22
1.4.	DUT and test-site configurations	23
2.	CONDUCTED AVERAGE POWER MEASUREMENTS.....	24
2.1.	GSM/GPRS/EGPRS Bands.....	24
2.2.	WCDMA/HSDPA/HSPA/HSPA+ Bands	26
2.3.	RF Signal.....	29
3.	TISSUE PARAMETERS MEASUREMENTS	30
4.	SYSTEM CHECK MEASUREMENTS	31
4.1.	Validation results for Body TSL	31
5.	MEASUREMENT RESULTS FOR SAR (SPECIFIC ABSORPTION RATE)	31
5.1.	Summary maximum results for 10-g extremity SAR measurements	31
5.2.	Result for 10g extremity simultaneous multi-band transmission	32
5.3.	Results for GPRS 850 MHz band – 4 slots.	33
5.4.	Results for GPRS 1900 MHz Band – 4 slots.	33
5.5.	Results for WCDMA Band II.....	33
5.6.	Results for WCDMA Band IV	34
5.7.	Results for WCDMA Band V	34
5.8.	Variability results.....	34

1. TEST CONDITIONS

1.1. Power supply (V):

$V_n = 3.7$ Li-polymer rechargeable battery

Type of power supply = DC Voltage from rechargeable Li-Ion 3.7 V battery.

1.2. Temperature (°C):

$T_n = +20.00$ to $+25.00$

The subscript n indicates normal test conditions.

1.3. Test signal, Output Power and Frequencies

For the GPRS/EDGE and WCDMA modes, the sample (M/02) was put into operation by using a R&S CMU 200 and a R&S CMW 500 as base station simulators. The output power of the device was set to Power Control Level (PCL) maximum for all tests.

The actual SAR sample does not have accessible antenna connectors for conducted measurements, so the conducted average output power was measured using others identical samples (M/01) provided by the manufacturer with auxiliary external connectors that makes the measurements representative and applicable for all the tested samples. See 'usage of samples' paragraph of this report.

The maximum conducted time-averaged power of the device for each mode was measured with a power sensor R&S NRP-Z91.

A fully charged battery was used for every test sequence. In all operating bands and test positions, the measurements were performed on the middle channel. In each band, for those positions where the maximum averaged SAR was found, measurements were performed on the remaining required channels.

The target power alignments for RF components declared by the manufacturer for each supported technology are:

Band/Mode	Power Class	Output Power (dBm)	Transmission Mode				
			Voice	1 Tx slot	2 Tx slots	3 Tx slots	4 Tx slots
GSM 850/GPRS850	1	Maximum	34.0	34.0	31.0	29.2	28.0
		Nominal	32.5	32.5	29.5	27.7	26.5
EGPRS 850	1	Maximum	-	28.5	25.5	23.7	22.5
		Nominal	-	27.0	24.0	22.2	21.0
GSM 1900/GPRS1900	E2	Maximum	31.0	31.0	28.0	26.2	25.0
		Nominal	29.5	29.5	26.5	24.7	23.5
EGPRS 1900	E2	Maximum	-	27.5	24.5	22.7	21.5
		Nominal	-	26.0	23.0	21.2	20

Band	Power Class	Output Power (dBm)	Mode		
			WCDMA	HSDPA	HSPA
FDD II 1900	3	Maximum	24.5	24.5	24.5
		Nominal	23.0	23.0	23.0
FDD IV 1700	3	Maximum	24.5	24.5	24.5
		Nominal	23.0	23.0	23.0
FDD V 850	3	Maximum	24.5	24.5	24.5
		Nominal	23.0	23.0	23.0

Band	Modulation	Maximum Output Power (dBm)
433 MHz	QPSK	10.00

1.4. DUT and test-site configurations

Supported 2G and 3G modes were tested for body exposure (Limb-worn). The device under test was placed with its back face directly against the flat phantom surface.

2. CONDUCTED AVERAGE POWER MEASUREMENTS

2.1. GSM/GPRS/EGPRS Bands

- GSM 850: For voice mode PCL 5 was set in the CMU-200 to allow DUT's max power transmission.

GSM 850 - Average Output Power					
Channel Number	Frequency (MHz)	Frame Average Output Power (dBm)	Average Burst Output Power (dBm)	PCL	Modulation
128	824.2	23.0	32.0	5	GMSK
190	836.6	22.8	31.9	5	GMSK
251	848.8	22.7	31.8	5	GMSK

- GPRS 850: For data mode. PCL 5, CS1 coding scheme and Gamma 3 were set in the CMU-200 to allow DUT's max power transmission for each slot.

GPRS 850 - Frame Average Output Power							
Channel Number	Frequency (MHz)	Power (dBm) 1 Slot	Power (dBm) 2 Slots	Power (dBm) 3 Slots	Power (dBm) 4 Slots	PCL	Modulation
128	824.2	22.8	25.8	26.6	26.7	5	GMSK-CS1
190	836.6	22.6	25.6	26.5	26.7	5	GMSK-CS1
251	848.8	22.5	25.5	26.4	26.5	5	GMSK-CS1

GPRS 850 - Average Burst Output Power							
Channel Number	Frequency (MHz)	Power (dBm) 1 Slot	Power (dBm) 2 Slots	Power (dBm) 3 Slots	Power (dBm) 4 Slots	PCL	Modulation
128	824.2	31.9	31.8	30.9	29.7	5	GMSK-CS1
190	836.6	31.7	31.6	30.8	29.7	5	GMSK-CS1
251	848.8	31.6	31.5	30.6	29.5	5	GMSK-CS1

- EGPRS 850: For data mode. PCL 8, MCS5 coding scheme and Gamma 6 were set in the CMU-200 to allow DUT's max power transmission for each slot.

EDGE 850 - Frame Average Output Power							
Channel Number	Frequency (MHz)	Power (dBm) 1 Slot	Power (dBm) 2 Slots	Power (dBm) 3 Slots	Power (dBm) 4 Slots	PCL	Modulation
128	824.2	17.1	20.2	21.0	21.1	8	8PSK-MCS5
190	836.6	17.1	20.0	20.9	21.0	8	8PSK-MCS5
251	848.8	17.0	19.9	20.8	20.9	8	8PSK-MCS5

EDGE 850 - Average Burst Output Power							
Channel Number	Frequency (MHz)	Power (dBm) 1 Slot	Power (dBm) 2 Slots	Power (dBm) 3 Slots	Power (dBm) 4 Slots	PCL	Modulation
128	824.2	26.2	26.2	25.3	24.1	8	8PSK-MCS5
190	836.6	26.1	26.0	25.1	24.0	8	8PSK-MCS5
251	848.8	26.1	25.9	25.1	23.9	8	8PSK-MCS5

- GSM 1900: For voice mode PCL 0 was set in the CMU-200 to allow DUT's max power transmission.

GSM 1900 - Average Output Power					
Channel Number	Frequency (MHz)	Frame Average Output Power (dBm)	Average Burst Output Power (dBm)	PCL	Modulation
512	1850.2	18.9	27.9	0	GMSK-CS1
661	1880	18.8	27.8	0	GMSK-CS1
810	1909.8	18.8	27.9	0	GMSK-CS1

- GPRS1900: For data mode. PCL 0, CS1 coding scheme and Gamma 3 were set in the CMU-200 to allow max power transmission for each slot.

GPRS 1900 - Frame Average Output Power							
Channel Number	Frequency (MHz)	Power (dBm) 1 Slot	Power (dBm) 2 Slots	Power (dBm) 3 Slots	Power (dBm) 4 Slots	PCL	Modulation
512	1850.2	18.7	21.7	22.6	22.7	0	GMSK-CS1
661	1880	18.6	21.6	22.6	22.6	0	GMSK-CS1
810	1909.8	18.7	21.6	22.6	22.7	0	GMSK-CS1

GPRS 1900 - Average Burst Output Power							
Channel Number	Frequency (MHz)	Power (dBm) 1 Slot	Power (dBm) 2 Slots	Power (dBm) 3 Slots	Power (dBm) 4 Slots	PCL	Modulation
512	1850.2	27.7	27.7	26.9	25.7	0	GMSK-CS1
661	1880	27.7	27.6	26.9	25.6	0	GMSK-CS1
810	1909.8	27.7	27.7	26.9	25.7	0	GMSK-CS1

- EGPRS 1900: For data mode, PCL 2, MCS5 coding scheme and Gamma 5 were set in the CMU-200 to allow max power transmission for each slot.

EDGE 1900 - Frame Average Output Power							
Channel Number	Frequency (MHz)	Power (dBm) 1 Slot	Power (dBm) 2 Slots	Power (dBm) 3 Slots	Power (dBm) 4 Slots	PCL	Modulation
512	1850.2	14.8	17.9	18.9	19.0	2	8PSK-MCS5
661	1880	14.8	17.9	18.9	19.0	2	8PSK-MCS5
810	1909.8	14.8	17.9	18.9	19.1	2	8PSK-MCS5

EDGE 1900 - Average Burst Output Power							
Channel Number	Frequency (MHz)	Power (dBm) 1 Slot	Power (dBm) 2 Slots	Power (dBm) 3 Slots	Power (dBm) 4 Slots	PCL	Modulation
512	1850.2	23.9	23.9	23.2	22.1	2	8PSK-MCS5
661	1880	23.8	23.9	23.1	22.0	2	8PSK-MCS5
810	1909.8	23.9	24.0	23.2	22.1	2	8PSK-MCS5

2.2. WCDMA/HSDPA/HSPA/HSPA+ Bands

- **WCDMA:** The DUT supports power Class 3, with a nominal maximum output power of 24 dBm (+1.7/-3.7). The tests were completed according to 3GPP TS34.121, section 5.

Mode	Subtest	Rel99
WCDMA	Loopback Mode	Test Mode 1
	Rel99 RMC	12.2Kbps RMC
	Power Control Algorithm	Algorithm2
	β_c/β_d	8/15

Band	Mode	Channel Number	Frequency (MHz)	Average Output Power (dBm)
FDD II 1900	WCDMA	9262	1852.4	22.81
FDD II 1900	WCDMA	9400	1880	22.55
FDD II 1900	WCDMA	9538	1907.6	22.48

Band	Mode	Channel Number	Frequency (MHz)	Average Output Power (dBm)
FDD IV 1700	WCDMA	1312	1712.4	23.13
FDD IV 1700	WCDMA	1412	1732.6	23.21
FDD IV 1700	WCDMA	1512	1752.6	23.10

Band	Mode	Channel Number	Frequency (MHz)	Average Output Power (dBm)
FDD V 850	WCDMA	4132	826.4	23.15
FDD V 850	WCDMA	4182	836.4	22.88
FDD V 850	WCDMA	4233	846.6	22.75

- **HSDPA:**

Mode	Subtest	1	2	3	4
HSDPA	Loopback Mode	Test Mode 1			
	Rel99 RMC	12.2Kbps RMC			
	HSDPA FRC	H-Set1			
	HSUPA Test	HSUPA Loopback			
	Power Control Algorithm	Algorithm 2			
	β_c	2/15	12/15	15/15	15/15
	β_d	15/15	15/15	8/15	4/15
	Bd (SF)	64	64	64	64
	β_c/β_d	2/15	12/15	15/8	15/4
	β_{hs}	4/15	24/15	30/15	30/15
	MPR	0	0	0.5	0.5
	Dack	8			
	Dnak	8			
	Ack-Nack repetition factor	3			
	DCQI	8			
	CQI Feedback	4ms			
	CQI Repetition Factor	2			
	$A_{hs} = \beta_{hs}/\beta_c$	30/15			

Band	Mode	Channel Number	Frequency (MHz)	Average Output Power (dBm)			
				Subtest 1 HSDPA	Subtest 2 HSDPA	Subtest 3 HSDPA	Subtest 4 HSDPA
FDD II 1900	HSDPA	9262	1852.4	21.78	21.6	21.73	21.72
FDD II 1900	HSDPA	9400	1880	21.34	21.22	21.36	21.34
FDD II 1900	HSDPA	9538	1907.6	21.14	21.01	21.12	21.04

Band	Mode	Channel Number	Frequency (MHz)	Average Output Power (dBm)			
				Subtest 1 HSDPA	Subtest 2 HSDPA	Subtest 3 HSDPA	Subtest 4 HSDPA
FDD IV 1700	HSDPA	1312	1712.4	22.13	21.94	22.08	22.05
FDD IV 1700	HSDPA	1412	1732.6	22.22	22.03	22.16	22.14
FDD IV 1700	HSDPA	1512	1752.6	21.96	21.7	21.83	21.78

Band	Mode	Channel Number	Frequency (MHz)	Average Output Power (dBm)			
				Subtest 1 HSDPA	Subtest 2 HSDPA	Subtest 3 HSDPA	Subtest 4 HSDPA
FDD V 850	HSDPA	4132	826.4	22.08	21.92	22.04	22.02
FDD V 850	HSDPA	4182	836.4	21.79	21.68	21.76	21.71
FDD V 850	HSDPA	4233	846.6	21.61	21.5	21.54	21.54

- **HSPA:**

Mode	Subtest	1	2	3	4	5
HSPA	Loopback Mode	Test Mode 1				
	Rel99 RMC	12.2Kbps RMC				
	HSDPA FRC	H-Set1				
	HSUPA Test	HSUPA Loopback				
	Power Control Algorithm	Algorithm 2				
	β_c	11/15	6/15	15/15	2/15	15/15
	β_d	15/15	15/15	9/15	15/15	15/15
	β_{ec}	209/225	12/15	30/15	2/15	24/15
	β_c/β_d	11/15	6/15	15/9	2/15	15/15
	β_{hs}	22/15	12/15	30/15	4/15	30/15
	β_{ed}	1309/225	94/75	47/15	56/75	134/15
	MPR (dB)	0	2	1	2	0
	Dack	8				
	Dnak	8				
	Ack-Nack repetition factor	3				
	DCQI	8				
	CQI Feedback	4ms				
	CQI Repetition Factor	2				
	Ahs = β_{hs}/β_c	30/15				
	AG Index	20	12	15	17	21
ETFCI	75	67	92	71	81	
Associated Max UL DataRate Kbps	242.1	174.9	482.8	205.8	308.9	

Band	Mode	CH	Frequency (MHz)	Average Output Power (dBm)				
				Subtest 1 HSPA	Subtest 2 HSPA	Subtest 3 HSPA	Subtest 4 HSPA	Subtest 5 HSPA
FDD II 1900	HSPA	9262	1852.4	22.28	22.12	21.92	22.59	22.69
FDD II 1900	HSPA	9400	1880	21.92	21.83	21.75	22.27	22.29
FDD II 1900	HSPA	9538	1907.6	21.93	21.67	21.5	22.12	22.19

Band	Mode	CH	Frequency (MHz)	Average Output Power (dBm)				
				Subtest 1 HSPA	Subtest 2 HSPA	Subtest 3 HSPA	Subtest 4 HSPA	Subtest 5 HSPA
FDD IV 1700	HSPA	1312	1712.4	22.65	22.6	22.39	23.01	23.16
FDD IV 1700	HSPA	1412	1732.6	22.74	22.68	22.42	23.03	23.19
FDD IV 1700	HSPA	1512	1752.6	22.37	22.29	22.08	22.72	22.88

Band	Mode	CH	Frequency (MHz)	Average Output Power (dBm)				
				Subtest 1 HSPA	Subtest 2 HSPA	Subtest 3 HSPA	Subtest 4 HSPA	Subtest 5 HSPA
FDD V 850	HSPA	4132	826.4	22.67	22.46	22.27	22.72	23.01
FDD V 850	HSPA	4182	836.4	22.38	22.03	21.95	22.65	22.71
FDD V 850	HSPA	4233	846.6	22.12	21.97	21.73	22.46	22.54

2.3. RF Signal

Based on paragraph “4.3.1 Standalone SAR test exclusion considerations” of the KDB 447498 D01 - General RF Exposure Guidance:

$$\left[\frac{(\text{max. power of channel, including tune-up tolerance, mW})}{(\text{min. test separation distance, mm})} \right] \cdot [\sqrt{f(\text{GHz})}]$$

$$\leq 3.0 \text{ for 1-g SAR and } \leq 7.5 \text{ for 10-g extremity SAR}$$

Protocol	Max. Output Power		Min. Test Distance (mm)	Freq. (GHz)	Result	Test Exclusion
	(dBm)	(mW)				
RF Signal	10.00	10.00	5	0.433	1.32	Pass

The computed value for this technology is < 3, so this mode qualifies for Standalone SAR test exclusion for 1-g SAR and 10-g SAR.

When standalone SAR test exclusion applies to an antenna that transmits simultaneously with other antennas, standalone SAR must be estimated according to following to determine simultaneous transmission SAR test exclusion:

$$(\text{max. power of channel, including tune-up tolerance, mW}) / (\text{min. test separation distance, mm}) \cdot [\sqrt{f(\text{GHz})/x}] \text{ W/kg}$$

for test separation distances ≤ 50 mm; where $x = 7.5$ for 1-g SAR and $x = 18,75$ for 10-g extremity SAR,.

When the min. test separation distance is < 5 mm, a distance of 5 mm is applied to determine SAR test exclusion.

Estimated SAR						
Protocol	Max. Output Power		Min. Test separation distance (mm)	Frequency (GHz)	Estimated 1-g SAR	Estimated 10-g SAR
	(dBm)	(mW)				
RF Signal	10.00	10.00	5	0.433	0.176	0.07

According to ISED RSS-102 Issue 5 (2015-03) – Radio Frequency Exposure Compliance of Radiocommunication Apparatus (All Frequency Bands), paragraph 2.5.1 Exemption Limits for Routine Evaluation – SAR Evaluation, if the device operates below the applicable output power level (adjusted for tune-up tolerance), for the specified separation distance defined in Table 1, SAR evaluation is not required. Output power level shall be the higher of the maximum conducted or equivalent isotropically radiated power (e.i.r.p.) source-based, time-averaged output power. For limb-worn devices where the 10 gram value applies, the exemption limits for routine evaluation in Table 1 are multiplied by a factor of 2.5.

According to Table 1, the limb-worn exemption limit for 5 mm separation distance and 450 MHz frequency is 130 mW.

The manufacturer declares a maximum output power and antenna gain values for this technology of 10.0 dBm and -14.54 dBi respectively. According to these values the isotropically radiated power (e.i.r.p.) is -4.54 dBm, which corresponds to 0.36 mW. As this value is below the limb-worn exemption limit, SAR testing is not needed for this technology according to ISED RSS-102 Issue 5 (2015-03).

3. TISSUE PARAMETERS MEASUREMENTS

Frequency (MHz)	Target Body Tissue		Measured Body Tissue		Deviation %		Measured Date
	Permittivity ϵ	Conductivity σ [S/m]	Permittivity ϵ	Conductivity σ [S/m]	Permittivity ϵ	Conductivity σ [S/m]	
835	55.2	0.97	53.80	0.96	-2.53	-1.02	2017-03-13
900	55.0	1.05	53.21	1.02	-3.25	-2.45	2017-03-13
1750	53.4	1.49	55.80	1.45	4.43	-2.47	2017-03-15
1800	53.3	1.52	55.52	1.52	4.16	-0.09	2017-03-15
1900	53.3	1.52	55.04	1.57	3.26	3.29	2017-03-15

Note: The dielectric properties have been measured by the contact probe method at 22° C.

- Composition / Information on ingredients

Head and Muscle Tissue Simulation Liquids HSL900/MSL900

H2O	Water, 35 – 58%
Sucrose	Sugar, white, refined, 40 – 60%
NaCl	Sodium Chloride, 0 – 6%
Hydroxyethyl-cellulose	Medium Viscosity (CAS# 9004-62-0), <0.3%
Preventol-D7	Preservative: aqueous preparation, (CAS# 55965-84-9), containing 5-chloro-2-methyl-3(2H)-isothiazolone and 2-methyl-3(2H)-isothiazolone, 0.1 – 0.7%

Head and Muscle Tissue Simulation Liquids HSL1800/MSL1800

H2O	Water, 52 – 75%
C8H18O3	Diethylene glycol monobutyl ether (DGBE), 25 – 48% (CAS-No. 112-34-5, EC-No. 203-961-6, EC-index-No. 603-096-00-8)
NaCl	Sodium Chloride, <1.0%

4. SYSTEM CHECK MEASUREMENTS

4.1. Validation results for Body TSL

Date	Frequency (MHz)	SAR over	SAR (W/kg)	1 W Target SAR (W/kg)	1 W Norm. SAR (W/kg)	Drift (%)
2017/03/13	900	1 gr.	2.70	10.5	10.74	2.26
		10 gr.	1.76	6.79	7.00	3.08
2017/03/15	1800	1 gr.	9.42	37.4	37.66	0.71
		10 gr.	4.95	19.8	19.79	-0.04

5. MEASUREMENT RESULTS FOR SAR (SPECIFIC ABSORPTION RATE)

5.1. Summary maximum results for 10-g extremity SAR measurements

Band	Mode	Position/ Distance	Channel (Frequency)	Reported SAR 10-g (W/kg)	SAR limit SAR 10-g (W/kg)
850 MHz	GPRS 4 slots	Back face / 0 mm	CH 128 (824.2 MHz)	0.215	4.0
	WCDMA Band V	Back face / 0 mm	CH 4233 (846.6 MHz)	0.331	4.0
1700 MHz	WCDMA Band IV	Back face / 0 mm	CH 1412 (1732.6 MHz)	0.374	4.0
1900 MHz	GPRS 4 slots	Back face / 0 mm	CH 512 (1850.2 MHz)	0.143	4.0
	WCDMA Band II	Back face / 0 mm	CH 9400 (1880 MHz)	0.410	4.0

5.2. Result for 10g extremity simultaneous multi-band transmission

Transmission Mode	Band	Max SAR 10-g (W/kg)	Σ SARi (W/kg)	Limit SAR 10-g (W/kg)	Verdict
GSM / GPRS /EDGE	850MHz	0.215	0.285	4.0	Pass
RF Signal	433 MHz	0.07			
GSM / GPRS /EDGE	1900MHz	0.143	0.213	4.0	Pass
RF Signal	433 MHz	0.07			
WCDMA	FDD II	0.410	0.480	4.0	Pass
RF Signal	433 MHz	0.07			
WCDMA	FDD IV	0.374	0.444	4.0	Pass
RF Signal	433 MHz	0.07			
WCDMA	FDD V	0.331	0.401	4.0	Pass
RF Signal	433 MHz	0.07			

5.3. Results for GPRS 850 MHz band – 4 slots.

Position	Dist (mm)	Channel (Frequency)	SAR 10-g (W/kg)	Power Drift (%)	Scale factor	Reported SAR 10-g (W/kg)	Plot No.
Back face	0	CH 190 (836.6 MHz)	0.19	0.00	1	0.19	
Back face	0	CH 128 (824.2 MHz)	0.212	-0.69	1	0.215	1
Back face	0	CH 251 (848.8 MHz)	0.197	-0.57	1	0.200	

5.4. Results for GPRS 1900 MHz Band – 4 slots.

Position	Dist (mm)	Channel (Frequency)	SAR 10-g (W/kg)	Power Drift (%)	Scale factor	Reported SAR 10-g (W/kg)	Plot No.
Back face	0	CH 661 (1880 MHz)	0.139	3.63	1	0.139	
Back face	0	CH 512 (1850.2 MHz)	0.143	1.74	1	0.143	2
Back face	0	CH 810 (1909.8 MHz)	0.126	3.04	1	0.126	

5.5. Results for WCDMA Band II

Position	Dist (mm)	Channel (Frequency)	SAR 10-g (W/kg)	Power Drift (%)	Scale factor	Reported SAR 10-g (W/kg)	Plot No.
Back face	0	CH 9400 (1880 MHz)	0.257	-0.92	1.567	0.410	3
Back face	0	CH 512 (1850.2 MHz)	0.225	-0.34	1.476	0.334	
Back face	0	CH 810 (1909.8 MHz)	0.221	0.23	1.592	0.352	

5.6. Results for WCDMA Band IV

Position	Dist (mm)	Channel (Frequency)	SAR 10-g (W/kg)	Power Drift (%)	Scale factor	Reported SAR 10-g (W/kg)	Plot No.
Back face	0	CH 1412 (1732.6 MHz)	0.269	-1.60	1.346	0.374	4
Back face	0	CH 1312 (1712.4 MHz)	0.269	0.23	1.371	0.369	
Back face	0	CH 1512 (1752.6 MHz)	0.265	-0.92	1.38	0.373	

5.7. Results for WCDMA Band V

Position	Dist (mm)	Channel (Frequency)	SAR 10-g (W/kg)	Power Drift (%)	Scale factor	Reported SAR 10-g (W/kg)	Plot No.
Back face	0	CH 4183 (836.6 MHz)	0.209	-0.12	1.452	0.304	
Back face	0	CH 4132 (826.4 MHz)	0.209	0.00	1.365	0.285	
Back face	0	CH 4233 (846.6 MHz)	0.221	0.23	1.496	0.331	5

5.8. Variability results.

According to KDB 865664 D01 SAR Measurement 100 MHz to 6 GHz, paragraph “2.8.1. SAR measurement variability”, repeated measurements are required only when the measured SAR is ≥ 0.80 W/kg.

Appendix C – Measurement report

GPRS 850 MHz 4 slots – Extremity – Back Face, d=0 mm – Low Channel – Plot 1

Test Laboratory: DEKRA Wireless; Date: 2017-03-14

DUT: 3M TD4i; Type: Limb-worn; Serial: 34688841

Communication System: UID 10028 - DAB, GPRS-FDD (TDMA, GMSK, TN 0-1-2-3); Frequency: 824.2 MHz; Duty Cycle: 1:2.26464

Medium parameters used: $f = 825 \text{ MHz}$; $\sigma = 0.95 \text{ S/m}$; $\epsilon_r = 53.96$; $\rho = 1000 \text{ kg/m}^3$

Phantom section: Flat Section

DASY5 Configuration:

- Probe: EX3DV4 - SN3687; ConvF(8.59, 8.59, 8.59); Calibrated: 2016-07-26;
- Sensor-Surface: 3mm (Mechanical Surface Detection (Locations From Previous Scan Used)), Sensor-Surface: 4mm (Mechanical Surface Detection)
- Electronics: DAE4 Sn669; Calibrated: 2016-07-18
- Phantom: Flat Phantom ELI4.0; Type: QDOVA001BA; Serial: SN:1060
- Measurement SW: DASY52, Version 52.8 (8); SEMCAD X Version 14.6.10 (7331)

Flat Phantom, d=0mm/850MHz/GPRS 4 slots, Low CH, Back face/Area Scan (61x81x1):

Interpolated grid: $dx=1.500 \text{ mm}$, $dy=1.500 \text{ mm}$

Maximum value of SAR (interpolated) = 0.328 W/kg

Flat Phantom, d=0mm/850MHz/GPRS 4 slots, Low CH, Back face/Zoom Scan (5x5x7)/Cube 0:

Measurement grid: $dx=8\text{mm}$, $dy=8\text{mm}$, $dz=5\text{mm}$

Reference Value = 17.09 V/m; Power Drift = -0.06 dB

Peak SAR (extrapolated) = 0.367 W/kg

SAR(1 g) = 0.288 W/kg; SAR(10 g) = 0.212 W/kg (SAR corrected for target medium)

Maximum value of SAR (measured) = 0.299 W/kg

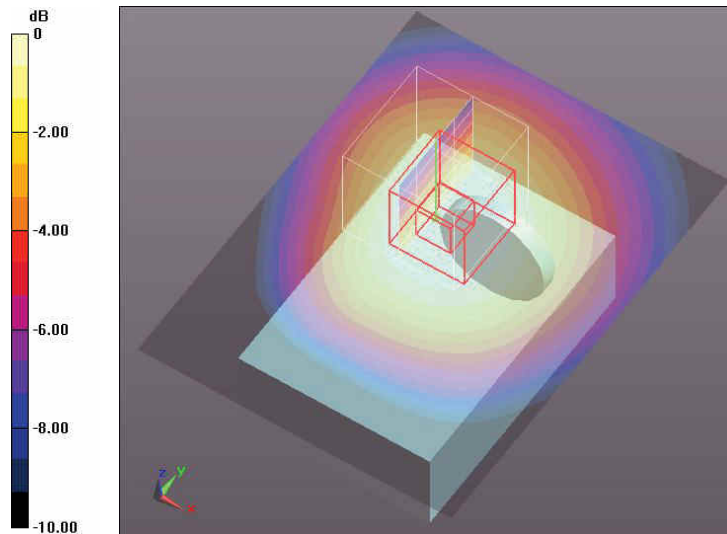

0 dB = 0.299 W/kg = -5.24 dBW/kg

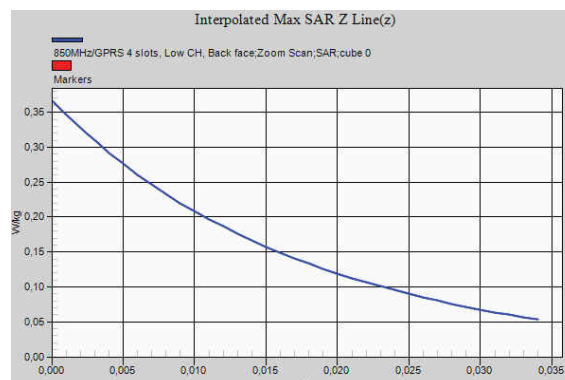

GPRS 1900 MHz 4 slots – Extremity – Back Face, d=0 mm – Low Channel – Plot 2

Test Laboratory: DEKRA Wireless; Date: 2017-03-15

DUT: 3M TD4i; Type: Limb-worn; Serial: 34688841

Communication System: UID 10028 - DAB, GPRS-FDD (TDMA, GMSK, TN 0-1-2-3); Frequency: 1850.2 MHz; Duty Cycle: 1:2.26464

Medium parameters used (interpolated): $f = 1850.2$ MHz; $\sigma = 1.55$ S/m; $\epsilon_r = 55.249$; $\rho = 1000$ kg/m³

Phantom section: Flat Section

DASY5 Configuration:

- Probe: EX3DV4 - SN3687; ConvF(7.19, 7.19, 7.19); Calibrated: 2016-07-26;
- Sensor-Surface: 3mm (Mechanical Surface Detection (Locations From Previous Scan Used)), Sensor-Surface: 4mm (Mechanical Surface Detection)
- Electronics: DAE4 Sn669; Calibrated: 2016-07-18
- Phantom: Flat Phantom ELI4.0; Type: QDOVA001BA; Serial: SN:1060
- Measurement SW: DASY52, Version 52.8 (8); SEMCAD X Version 14.6.10 (7331)

Flat Phantom, d=0mm/1900MHz/GPRS 4 slots, Low CH, Back face/Area Scan (61x81x1):

Interpolated grid: dx=1.500 mm, dy=1.500 mm

Info: [Interpolated medium parameters used for SAR evaluation.](#)

Maximum value of SAR (interpolated) = 0.299 W/kg

Flat Phantom, d=0mm/1900MHz/GPRS 4 slots, Low CH, Back face/Zoom Scan (5x5x7)/Cube 0:

Measurement grid: dx=8mm, dy=8mm, dz=5mm

Reference Value = 9.520 V/m; Power Drift = 0.15 dB

Peak SAR (extrapolated) = 0.389 W/kg

SAR(1 g) = 0.242 W/kg; SAR(10 g) = 0.143 W/kg (SAR corrected for target medium)

Info: [Interpolated medium parameters used for SAR evaluation.](#)

Maximum value of SAR (measured) = 0.264 W/kg

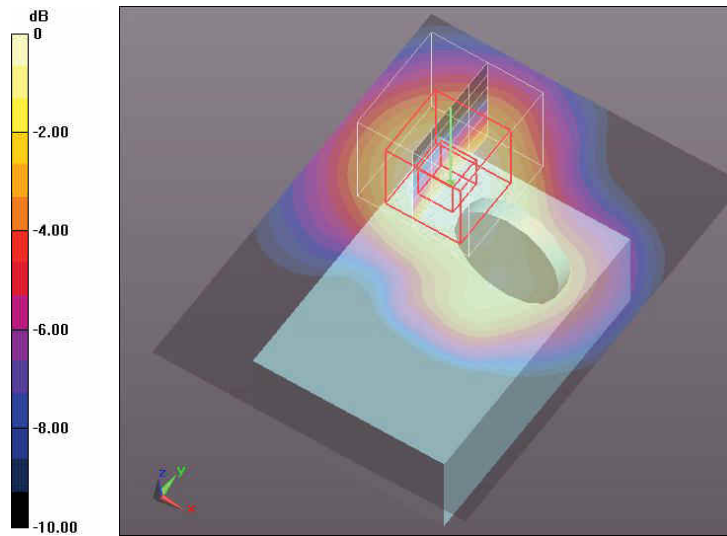

0 dB = 0.264 W/kg = -5.78 dBW/kg

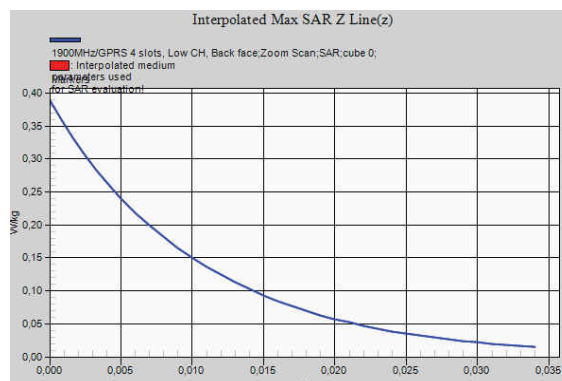

WCDMA Band II – Extremity – Back Face, d=0 mm – Middle Channel – Plot 3

Test Laboratory: DEKRA Wireless; Date: 2017-03-15

DUT: 3M TD4i; Type: Limb-worn; Serial: 34688841

Communication System: UID 10011 - CAB, UMTS-FDD (WCDMA); Frequency: 1880 MHz; Duty Cycle: 1:1.95434

Medium parameters used: $f = 1880$ MHz; $\sigma = 1.57$ S/m; $\epsilon_r = 55.1$; $\rho = 1000$ kg/m³

Phantom section: Flat Section

DASY5 Configuration:

- Probe: EX3DV4 - SN3687; ConvF(7.19, 7.19, 7.19); Calibrated: 2016-07-26;
- Sensor-Surface: 3mm (Mechanical Surface Detection), Sensor-Surface: 4mm (Mechanical Surface Detection)
- Electronics: DAE4 Sn669; Calibrated: 2016-07-18
- Phantom: Flat Phantom ELI4.0; Type: QDOVA001BA; Serial: SN:1060
- Measurement SW: DASY52, Version 52.8 (8); SEMCAD X Version 14.6.10 (7331)

Flat Phantom, d=0mm/1900MHz/WCDMA II, Mid CH, Back face/Area Scan (61x81x1):

Interpolated grid: dx=1.500 mm, dy=1.500 mm

Maximum value of SAR (interpolated) = 0.519 W/kg

Flat Phantom, d=0mm/1900MHz/WCDMA II, Mid CH, Back face/Zoom Scan (5x5x7)/Cube 0:

Measurement grid: dx=8mm, dy=8mm, dz=5mm

Reference Value = 13.10 V/m; Power Drift = -0.08 dB

Peak SAR (extrapolated) = 0.715 W/kg

SAR(1 g) = 0.437 W/kg; SAR(10 g) = 0.257 W/kg (SAR corrected for target medium)

Maximum value of SAR (measured) = 0.478 W/kg

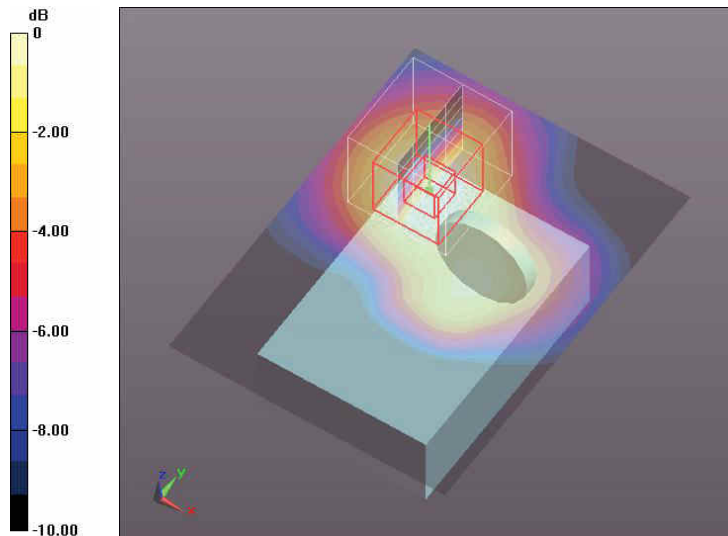

0 dB = 0.478 W/kg = -3.21 dBW/kg

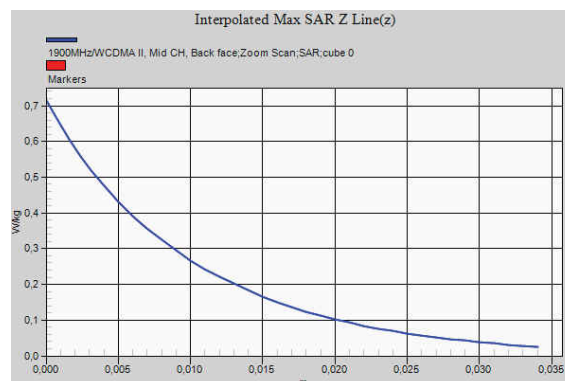

WCDMA Band IV – Extremity – Back Face, d=0 mm – Middle Channel – Plot 4

Test Laboratory: DEKRA Wireless; Date: 2017-03-15

DUT: 3M TD4i; Type: Limb-worn; Serial: 34688841

Communication System: UID 10011 - CAB, UMTS-FDD (WCDMA); Frequency: 1732.6 MHz; Duty Cycle: 1:1.95434
 Medium parameters used (interpolated): $f = 1732.6$ MHz; $\sigma = 1.425$ S/m; $\epsilon_r = 55.865$; $\rho = 1000$ kg/m³

Phantom section: Flat Section

DASY5 Configuration:

- Probe: EX3DV4 - SN3687; ConvF(7.25, 7.25, 7.25); Calibrated: 2016-07-26;
- Sensor-Surface: 3mm (Mechanical Surface Detection (Locations From Previous Scan Used)), Sensor-Surface: 4mm (Mechanical Surface Detection)
- Electronics: DAE4 Sn669; Calibrated: 2016-07-18
- Phantom: Flat Phantom ELI4.0; Type: QDOVA001BA; Serial: SN:1060
- Measurement SW: DASY52, Version 52.8 (8); SEMCAD X Version 14.6.10 (7331)

Flat Phantom, d=0mm/1700MHz/WCDMA IV, Mid CH, Back face/Area Scan (61x81x1):

Interpolated grid: dx=1.500 mm, dy=1.500 mm

[Info: Interpolated medium parameters used for SAR evaluation.](#)

Maximum value of SAR (interpolated) = 0.500 W/kg

Flat Phantom, d=0mm/1700MHz/WCDMA IV, Mid CH, Back face/Zoom Scan (5x5x7)/Cube 0:

Measurement grid: dx=8mm, dy=8mm, dz=5mm

Reference Value = 8.816 V/m; Power Drift = -0.14 dB

Peak SAR (extrapolated) = 0.696 W/kg

SAR(1 g) = 0.455 W/kg; SAR(10 g) = 0.269 W/kg (SAR corrected for target medium)

[Info: Interpolated medium parameters used for SAR evaluation.](#)

Maximum value of SAR (measured) = 0.481 W/kg

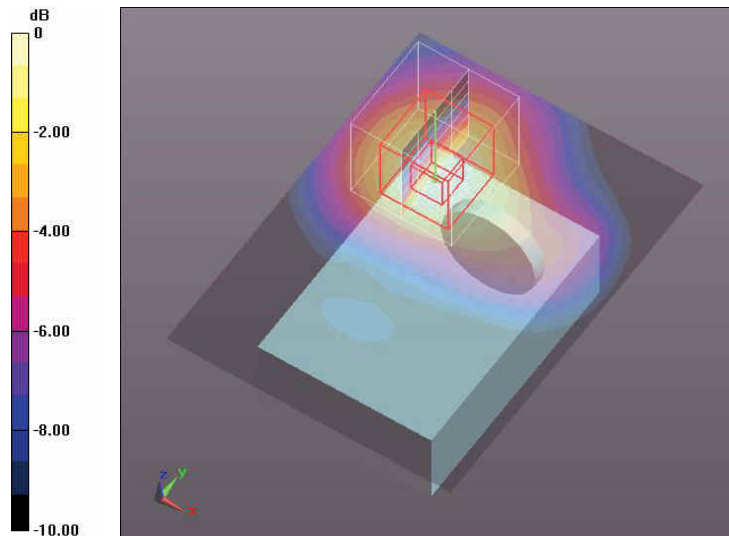

0 dB = 0.481 W/kg = -3.18 dBW/kg

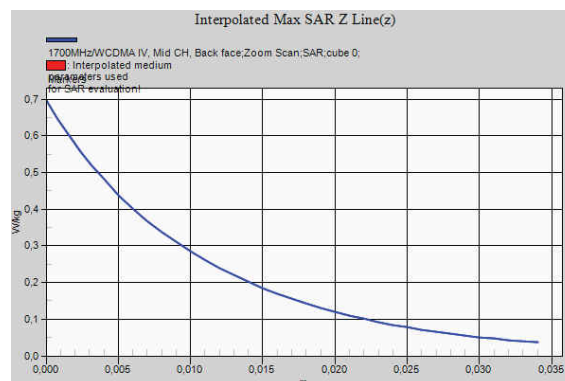

WCDMA Band V – Extremity – Back Face, d=0 mm – High Channel – Plot 5

Test Laboratory: DEKRA Wireless; Date: 2017-03-14

DUT: 3M TD4i; Type: Limb-worn; Serial: 34688841

Communication System: UID 10011 - CAB, UMTS-FDD (WCDMA); Frequency: 846.6 MHz; Duty Cycle: 1:1.95434
 Medium parameters used (interpolated): $f = 846.6 \text{ MHz}$; $\sigma = 0.973 \text{ S/m}$; $\epsilon_r = 53.684$; $\rho = 1000 \text{ kg/m}^3$

Phantom section: Flat Section

DASY5 Configuration:

- Probe: EX3DV4 - SN3687; ConvF(8.59, 8.59, 8.59); Calibrated: 2016-07-26;
- Sensor-Surface: 3mm (Mechanical Surface Detection (Locations From Previous Scan Used)), Sensor-Surface: 4mm (Mechanical Surface Detection)
- Electronics: DAE4 Sn669; Calibrated: 2016-07-18
- Phantom: Flat Phantom ELI4.0; Type: QDOVA001BA; Serial: SN:1060
- Measurement SW: DASY52, Version 52.8 (8); SEMCAD X Version 14.6.10 (7331)

Flat Phantom, d=0mm/850MHz/WCDMA V, High CH, Back face/Area Scan (61x81x1):

Interpolated grid: $dx=1.500 \text{ mm}$, $dy=1.500 \text{ mm}$

Info: [Interpolated medium parameters used for SAR evaluation.](#)

Maximum value of SAR (interpolated) = 0.342 W/kg

Flat Phantom, d=0mm/850MHz/WCDMA V, High CH, Back face/Zoom Scan (6x5x7)/Cube 0:

Measurement grid: $dx=8\text{mm}$, $dy=8\text{mm}$, $dz=5\text{mm}$

Reference Value = 17.32 V/m; Power Drift = 0.02 dB

Peak SAR (extrapolated) = 0.381 W/kg

SAR(1 g) = 0.301 W/kg; SAR(10 g) = 0.221 W/kg (SAR corrected for target medium)

Info: [Interpolated medium parameters used for SAR evaluation.](#)

Maximum value of SAR (measured) = 0.313 W/kg

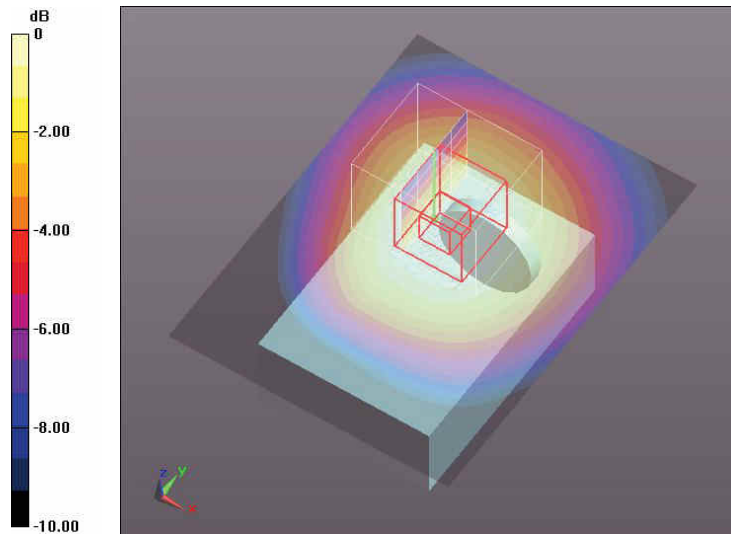

0 dB = 0.313 W/kg = -5.04 dBW/kg

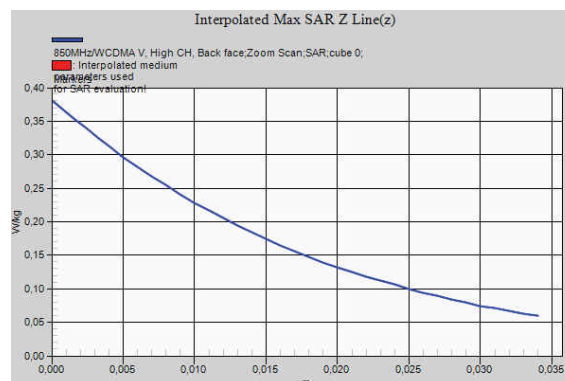

Appendix D – System Validation Reports

Validation results in 900 MHz Band for Body TSL

Test Laboratory: DEKRA Wireless; Date: 2017-03-13

DUT: Dipole 900 MHz D900V2; Type: D900V2; Serial: D900V2 - SN:1d007

Communication System: UID 0, CW; Frequency: 900 MHz; Duty Cycle: 1:1

Medium parameters used: $f = 900 \text{ MHz}$; $\sigma = 1.02 \text{ S/m}$; $\epsilon_r = 53.21$; $\rho = 1000 \text{ kg/m}^3$

Phantom section: Flat Section

DASY5 Configuration:

- Probe: EX3DV4 - SN3687; ConvF(8.49, 8.49, 8.49); Calibrated: 2016-07-26;
- Sensor-Surface: 3mm (Mechanical Surface Detection)
- Electronics: DAE4 Sn669; Calibrated: 2016-07-18
- Phantom: Flat Phantom ELI4.0; Type: QDOVA001BA; Serial: SN:1060
- Measurement SW: DASY52, Version 52.8 (8); SEMCAD X Version 14.6.10 (7331)

Configuration 900MHz, 2017-03-13/d=15mm, Pin=250 mW/Area Scan (61x91x1):

Interpolated grid: $dx=1.500 \text{ mm}$, $dy=1.500 \text{ mm}$

Maximum value of SAR (interpolated) = 3.16 W/kg

Configuration 900MHz, 2017-03-13/d=15mm, Pin=250 mW/Zoom Scan (7x7x7)/Cube 0:

Measurement grid: $dx=5\text{mm}$, $dy=5\text{mm}$, $dz=5\text{mm}$

Reference Value = 52.03 V/m; Power Drift = -0.05 dB

Peak SAR (extrapolated) = 4.01 W/kg

SAR(1 g) = 2.7 W/kg; SAR(10 g) = 1.76 W/kg (SAR corrected for target medium)

Maximum value of SAR (measured) = 3.12 W/kg

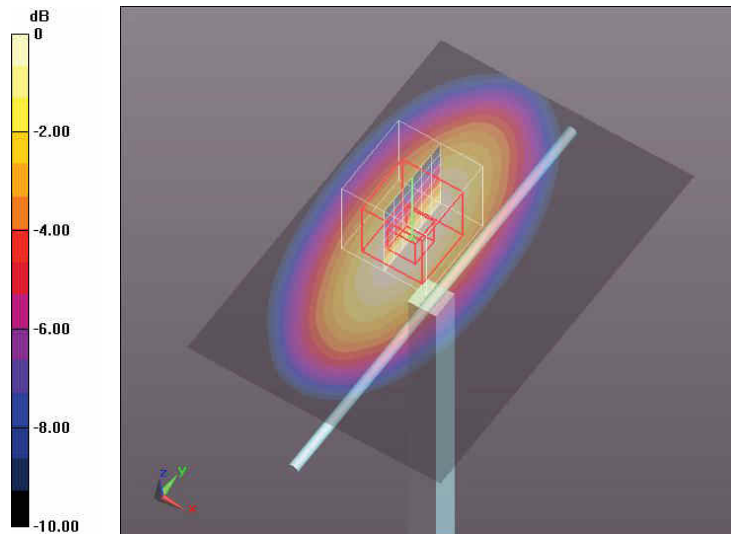

0 dB = 3.12 W/kg = 4.94 dBW/kg



Validation results in 1800 MHz Band for Body TSL

Test Laboratory: DEKRA Wireless; Date: 2017-03-15

DUT: Dipole 1800 MHz D1800V2; Type: D1800V2; Serial: D1800V2 - SN:2d099

Communication System: UID 0, CW (0); Frequency: 1800 MHz; Duty Cycle: 1:1
 Medium parameters used: $f = 1800 \text{ MHz}$; $\sigma = 1.52 \text{ S/m}$; $\epsilon_r = 55.52$; $\rho = 1000 \text{ kg/m}^3$
 Phantom section: Flat Section

DASY5 Configuration:

- Probe: EX3DV4 - SN3687; ConvF(7.25, 7.25, 7.25); Calibrated: 2016-07-26;
- Sensor-Surface: 3mm (Mechanical Surface Detection)
- Electronics: DAE4 Sn669; Calibrated: 2016-07-18
- Phantom: Flat Phantom ELI4.0; Type: QDOVA001BA; Serial: SN:1060
- Measurement SW: DASY52, Version 52.8 (8); SEMCAD X Version 14.6.10 (7331)

Configuration 1800MHz, 2017-03-15/d=10mm, Pin=250 mW/Area Scan (91x91x1):

Interpolated grid: $dx=1.000 \text{ mm}$, $dy=1.000 \text{ mm}$
 Maximum value of SAR (interpolated) = 11.9 W/kg

Configuration 1800MHz, 2017-03-15/d=10mm, Pin=250 mW/Zoom Scan (7x7x7)/Cube 0:

Measurement grid: $dx=5\text{mm}$, $dy=5\text{mm}$, $dz=5\text{mm}$
 Reference Value = 88.85 V/m; Power Drift = -0.00 dB
 Peak SAR (extrapolated) = 16.6 W/kg
SAR(1 g) = 9.42 W/kg; SAR(10 g) = 4.95 W/kg (SAR corrected for target medium)
 Maximum value of SAR (measured) = 11.9 W/kg

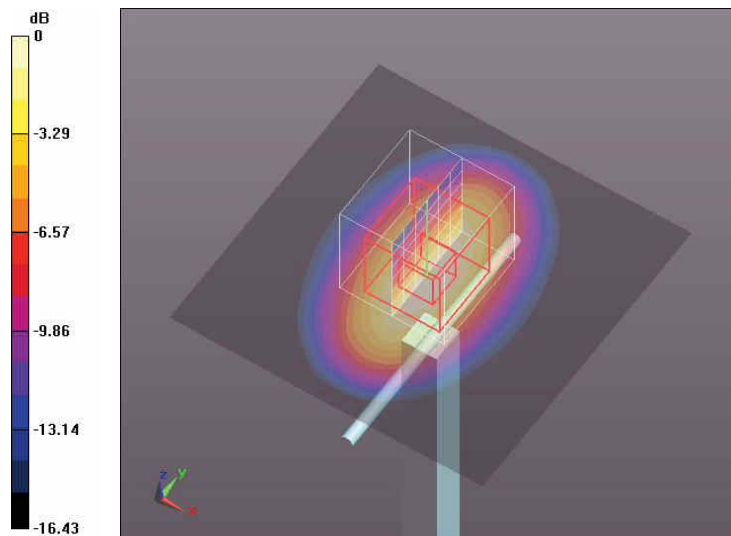

0 dB = 11.9 W/kg = 10.76 dBW/kg

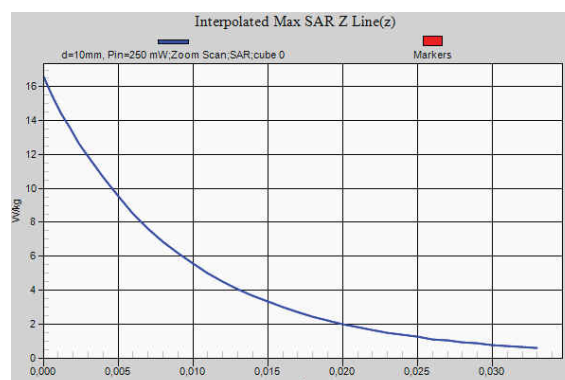

Appendix E – Calibration data

**Calibration Laboratory of
 Schmid & Partner
 Engineering AG**
 Zeughausstrasse 43, 8004 Zurich, Switzerland



S Schweizerischer Kalibrierdienst
S Service suisse d'étalonnage
C Servizio svizzero di taratura
S Swiss Calibration Service

Accredited by the Swiss Accreditation Service (SAS)
 The Swiss Accreditation Service is one of the signatories to the EA
 Multilateral Agreement for the recognition of calibration certificates

Accreditation No.: **SCS 0108**

Client **AT4 Wireless**

Certificate No: **DAE4-669_Jul16**

CALIBRATION CERTIFICATE

Object	DAE4 - SD 000 D04 BM - SN: 669																						
Calibration procedure(s)	QA CAL-06.v29 Calibration procedure for the data acquisition electronics (DAE)																						
Calibration date:	July 18, 2016																						
<p>This calibration certificate documents the traceability to national standards, which realize the physical units of measurements (SI). The measurements and the uncertainties with confidence probability are given on the following pages and are part of the certificate.</p> <p>All calibrations have been conducted in the closed laboratory facility; environment temperature (22 ± 3)°C and humidity < 70%.</p> <p>Calibration Equipment used (M&TE critical for calibration)</p> <table border="1"> <thead> <tr> <th>Primary Standards</th> <th>ID #</th> <th>Cal Date (Certificate No.)</th> <th>Scheduled Calibration</th> </tr> </thead> <tbody> <tr> <td>Keithley Multimeter Type 2001</td> <td>SN: 0810278</td> <td>09-Sep-15 (No:17153)</td> <td>Sep-16</td> </tr> <tr> <th>Secondary Standards</th> <th>ID #</th> <th>Check Date (in house)</th> <th>Scheduled Check</th> </tr> <tr> <td>Auto DAE Calibration Unit</td> <td>SE UWS 053 AA 1001</td> <td>05-Jan-16 (in house check)</td> <td>In house check: Jan-17</td> </tr> <tr> <td>Calibrator Box V2.1</td> <td>SE UMS 006 AA 1002</td> <td>05-Jan-16 (in house check)</td> <td>In house check: Jan-17</td> </tr> </tbody> </table>				Primary Standards	ID #	Cal Date (Certificate No.)	Scheduled Calibration	Keithley Multimeter Type 2001	SN: 0810278	09-Sep-15 (No:17153)	Sep-16	Secondary Standards	ID #	Check Date (in house)	Scheduled Check	Auto DAE Calibration Unit	SE UWS 053 AA 1001	05-Jan-16 (in house check)	In house check: Jan-17	Calibrator Box V2.1	SE UMS 006 AA 1002	05-Jan-16 (in house check)	In house check: Jan-17
Primary Standards	ID #	Cal Date (Certificate No.)	Scheduled Calibration																				
Keithley Multimeter Type 2001	SN: 0810278	09-Sep-15 (No:17153)	Sep-16																				
Secondary Standards	ID #	Check Date (in house)	Scheduled Check																				
Auto DAE Calibration Unit	SE UWS 053 AA 1001	05-Jan-16 (in house check)	In house check: Jan-17																				
Calibrator Box V2.1	SE UMS 006 AA 1002	05-Jan-16 (in house check)	In house check: Jan-17																				
Calibrated by:	Name Dominique Steffen	Function Technician	Signature 																				
Approved by:	Fin Bomholt	Deputy Technical Manager																					
			Issued: July 18, 2016																				

This calibration certificate shall not be reproduced except in full without written approval of the laboratory.

**Calibration Laboratory of
Schmid & Partner
Engineering AG**
Zeughausstrasse 43, 8004 Zurich, Switzerland



S Schweizerischer Kalibrierdienst
C Service suisse d'étalonnage
S Servizio svizzero di taratura
S Swiss Calibration Service

Accredited by the Swiss Accreditation Service (SAS)
The Swiss Accreditation Service is one of the signatories to the EA
Multilateral Agreement for the recognition of calibration certificates

Accreditation No.: **SCS 0108**

Glossary

DAE data acquisition electronics
Connector angle information used in DASY system to align probe sensor X to the robot coordinate system.

Methods Applied and Interpretation of Parameters

- *DC Voltage Measurement*: Calibration Factor assessed for use in DASY system by comparison with a calibrated instrument traceable to national standards. The figure given corresponds to the full scale range of the voltmeter in the respective range.
- *Connector angle*: The angle of the connector is assessed measuring the angle mechanically by a tool inserted. Uncertainty is not required.
- The following parameters as documented in the Appendix contain technical information as a result from the performance test and require no uncertainty.
 - *DC Voltage Measurement Linearity*: Verification of the Linearity at +10% and -10% of the nominal calibration voltage. Influence of offset voltage is included in this measurement.
 - *Common mode sensitivity*: Influence of a positive or negative common mode voltage on the differential measurement.
 - *Channel separation*: Influence of a voltage on the neighbor channels not subject to an input voltage.
 - *AD Converter Values with inputs shorted*: Values on the internal AD converter corresponding to zero input voltage
 - *Input Offset Measurement*: Output voltage and statistical results over a large number of zero voltage measurements.
 - *Input Offset Current*: Typical value for information; Maximum channel input offset current, not considering the input resistance.
 - *Input resistance*: Typical value for information: DAE input resistance at the connector, during internal auto-zeroing and during measurement.
 - *Low Battery Alarm Voltage*: Typical value for information. Below this voltage, a battery alarm signal is generated.
 - *Power consumption*: Typical value for information. Supply currents in various operating modes.

DC Voltage Measurement

A/D - Converter Resolution nominal

High Range: 1LSB = 6.1µV, full range = -100...+300 mV

Low Range: 1LSB = 61nV, full range = -1.....+3mV

DASY measurement parameters: Auto Zero Time: 3 sec; Measuring time: 3 sec

Calibration Factors	X	Y	Z
High Range	403.329 ± 0.02% (k=2)	403.880 ± 0.02% (k=2)	404.240 ± 0.02% (k=2)
Low Range	3.95541 ± 1.50% (k=2)	3.97473 ± 1.50% (k=2)	3.97419 ± 1.50% (k=2)

Connector Angle

Connector Angle to be used in DASY system	192.0 ° ± 1 °
---	---------------

Appendix (Additional assessments outside the scope of SCS0108)

1. DC Voltage Linearity

High Range	Reading (μV)	Difference (μV)	Error (%)
Channel X + Input	200036.84	-0.47	-0.00
Channel X + Input	20009.62	4.22	0.02
Channel X - Input	-20001.84	3.36	-0.02
Channel Y + Input	200035.95	-1.37	-0.00
Channel Y + Input	20008.11	2.95	0.01
Channel Y - Input	-20003.03	2.32	-0.01
Channel Z + Input	200036.35	-2.70	-0.00
Channel Z + Input	20008.87	3.78	0.02
Channel Z - Input	-20003.08	2.25	-0.01

Low Range	Reading (μV)	Difference (μV)	Error (%)
Channel X + Input	2001.08	-0.33	-0.02
Channel X + Input	201.62	0.14	0.07
Channel X - Input	-198.88	-0.36	0.18
Channel Y + Input	2001.32	0.23	0.01
Channel Y + Input	200.95	-0.29	-0.14
Channel Y - Input	-199.87	-1.04	0.52
Channel Z + Input	2001.30	0.12	0.01
Channel Z + Input	200.62	-0.62	-0.31
Channel Z - Input	-200.16	-1.41	0.71

2. Common mode sensitivity

DASY measurement parameters: Auto Zero Time: 3 sec; Measuring time: 3 sec

	Common mode Input Voltage (mV)	High Range Average Reading (μV)	Low Range Average Reading (μV)
Channel X	200	2.15	0.63
	- 200	0.50	-1.00
Channel Y	200	10.89	10.66
	- 200	-13.07	-13.28
Channel Z	200	-10.00	-10.04
	- 200	7.66	7.47

3. Channel separation

DASY measurement parameters: Auto Zero Time: 3 sec; Measuring time: 3 sec

	Input Voltage (mV)	Channel X (μV)	Channel Y (μV)	Channel Z (μV)
Channel X	200	-	-2.46	-2.83
Channel Y	200	8.89	-	-1.72
Channel Z	200	2.97	6.84	-

4. AD-Converter Values with inputs shorted

DASY measurement parameters: Auto Zero Time: 3 sec; Measuring time: 3 sec

	High Range (LSB)	Low Range (LSB)
Channel X	16074	15743
Channel Y	15795	15269
Channel Z	15996	15139

5. Input Offset Measurement

DASY measurement parameters: Auto Zero Time: 3 sec; Measuring time: 3 sec

Input 10M Ω

	Average (μ V)	min. Offset (μ V)	max. Offset (μ V)	Std. Deviation (μ V)
Channel X	0.25	-1.07	2.29	0.53
Channel Y	0.36	-0.99	1.48	0.38
Channel Z	0.05	-1.09	2.02	0.46

6. Input Offset Current

Nominal input circuitry offset current on all channels: <25fA

7. Input Resistance (Typical values for information)

	Zeroing (kOhm)	Measuring (MOhm)
Channel X	200	200
Channel Y	200	200
Channel Z	200	200

8. Low Battery Alarm Voltage (Typical values for information)

Typical values	Alarm Level (VDC)
Supply (+ Vcc)	+7.9
Supply (- Vcc)	-7.6

9. Power Consumption (Typical values for information)

Typical values	Switched off (mA)	Stand by (mA)	Transmitting (mA)
Supply (+ Vcc)	+0.01	+6	+14
Supply (- Vcc)	-0.01	-8	-9

**Calibration Laboratory of
 Schmid & Partner
 Engineering AG**
 Zeughausstrasse 43, 8004 Zurich, Switzerland



S Schweizerischer Kalibrierdienst
C Service suisse d'étalonnage
S Servizio svizzero di taratura
S Swiss Calibration Service

Accredited by the Swiss Accreditation Service (SAS)
 The Swiss Accreditation Service is one of the signatories to the EA
 Multilateral Agreement for the recognition of calibration certificates

Accreditation No.: **SCS 0108**

Client **AT4 Wireless**

Certificate No: **EX3-3687_Jul16**

CALIBRATION CERTIFICATE

Object **EX3DV4 - SN:3687**

Calibration procedure(s) **QA CAL-01.v9, QA CAL-12.v9, QA CAL-14.v4, QA CAL-23.v5,
 QA CAL-25.v6
 Calibration procedure for dosimetric E-field probes**

Calibration date: **July 26, 2016**

This calibration certificate documents the traceability to national standards, which realize the physical units of measurements (SI).
 The measurements and the uncertainties with confidence probability are given on the following pages and are part of the certificate.

All calibrations have been conducted in the closed laboratory facility: environment temperature (22 ± 3)°C and humidity < 70%.

Calibration Equipment used (M&TE critical for calibration)

Primary Standards	ID	Cal Date (Certificate No.)	Scheduled Calibration
Power meter NRP	SN: 104776	06-Apr-16 (No. 217-02288/02289)	Apr-17
Power sensor NRP-Z91	SN: 103244	06-Apr-16 (No. 217-02288)	Apr-17
Power sensor NRP-Z91	SN: 103245	06-Apr-16 (No. 217-02289)	Apr-17
Reference 20 dB Attenuator	SN: 55277 (20x)	05-Apr-16 (No. 217-02293)	Apr-17
Reference Probe ES3DV2	SN: 3013	31-Dec-15 (No. ES3-3013_Dec15)	Dec-16
DAEA	SN: 660	23-Dec-15 (No. DAE4-660, Dec15)	Dec-16
Secondary Standards	ID	Check Date (in house)	Scheduled Check
Power meter E4419B	SN: GB41293874	06-Apr-16 (in house check Jun-16)	in house check Jun-16
Power sensor E4412A	SN: MY41498067	06-Apr-16 (in house check Jun-16)	in house check Jun-16
Power sensor E4412A	SN: 000110210	06-Apr-16 (in house check Jun-16)	in house check Jun-16
RF generator HP 8648C	SN: US3642UD1700	04-Aug-09 (in house check Jun-16)	in house check Jun-16
Network Analyzer HP 8753E	SN: US37390585	18-Oct-01 (in house check Oct-15)	in house check Oct-16

	Name	Function	Signature
Calibrated by:	Gloria Leubler	Laboratory Technician	
Approved by:	Katja Pokovic	Technical Manager	

issued: July 27, 2016

This calibration certificate shall not be reproduced except in full without written approval of the laboratory.

Certificate No: EX3-3687_Jul16

Page 1 of 38

Calibration Laboratory of
 Schmid & Partner
 Engineering AG
 Zeughausstrasse 43, 8004 Zurich, Switzerland



S Schweizerischer Kalibrierdienst
 C Service suisse d'étalonnage
 S Servizio svizzero di taratura
 S Swiss Calibration Service

Accredited by the Swiss Accreditation Service (SAS)
 The Swiss Accreditation Service is one of the signatories to the EA
 Multilateral Agreement for the recognition of calibration certificates

Accreditation No.: SCS 0108

Glossary:

TSL	tissue simulating liquid
NORM _{x,y,z}	sensitivity in free space
ConvF	sensitivity in TSL / NORM _{x,y,z}
DCP	diode compression point
CF	crest factor (1/duty_cycle) of the RF signal
A, B, C, D	modulation dependent linearization parameters
Polarization φ	φ rotation around probe axis
Polanzation θ	θ rotation around an axis that is in the plane normal to probe axis (at measurement center), i.e., $\theta = 0$ is normal to probe axis
Connector Angle	information used in DASY system to align probe sensor X to the robot coordinate system

Calibration is Performed According to the Following Standards:

- IEEE Std 1528-2013, "IEEE Recommended Practice for Determining the Peak Spatial-Averaged Specific Absorption Rate (SAR) in the Human Head from Wireless Communications Devices: Measurement Techniques", June 2013
- IEC 62209-1, "Procedure to measure the Specific Absorption Rate (SAR) for hand-held devices used in close proximity to the ear (frequency range of 300 MHz to 3 GHz)", February 2005
- IEC 62209-2, "Procedure to determine the Specific Absorption Rate (SAR) for wireless communication devices used in close proximity to the human body (frequency range of 30 MHz to 6 GHz)", March 2010
- KDB 865864, "SAR Measurement Requirements for 100 MHz to 6 GHz"

Methods Applied and Interpretation of Parameters:

- NORM_{x,y,z}: Assessed for E-field polarization $\theta = 0$ ($f \leq 900$ MHz in TEM-cell; $f > 1800$ MHz: R22 waveguide). NORM_{x,y,z} are only intermediate values, i.e., the uncertainties of NORM_{x,y,z} does not affect the E²-field uncertainty inside TSL (see below ConvF).
- NORM(f)_{x,y,z} = NORM_{x,y,z} * frequency_response (see Frequency Response Chart). This linearization is implemented in DASY4 software versions later than 4.2. The uncertainty of the frequency response is included in the stated uncertainty of ConvF.
- DCP_{x,y,z}: DCP are numerical linearization parameters assessed based on the data of power sweep with CW signal (no uncertainty required). DCP does not depend on frequency nor media.
- PAR: PAR is the Peak to Average Ratio that is not calibrated but determined based on the signal characteristics
- A_{x,y,z}, B_{x,y,z}, C_{x,y,z}, D_{x,y,z}, VR_{x,y,z}: A, B, C, D are numerical linearization parameters assessed based on the data of power sweep for specific modulation signal. The parameters do not depend on frequency nor media. VR is the maximum calibration range expressed in RMS voltage across the diode.
- ConvF and Boundary Effect Parameters: Assessed in flat phantom using E-field (or Temperature Transfer Standard for $f \leq 800$ MHz) and inside waveguide using analytical field distributions based on power measurements for $f > 800$ MHz. The same setups are used for assessment of the parameters applied for boundary compensation (alpha, depth) of which typical uncertainty values are given. These parameters are used in DASY4 software to improve probe accuracy close to the boundary. The sensitivity in TSL corresponds to NORM_{x,y,z} * ConvF whereby the uncertainty corresponds to that given for ConvF. A frequency dependent ConvF is used in DASY version 4.4 and higher which allows extending the validity from ± 50 MHz to ± 100 MHz.
- Spherical Isotropy (3D deviation from isotropy): in a field of low gradients realized using a flat phantom exposed by a patch antenna.
- Sensor Offset: The sensor offset corresponds to the offset of virtual measurement center from the probe tip (on probe axis). No tolerance required.
- Connector Angle: The angle is assessed using the information gained by determining the NORM_x (no uncertainty required).

EX3DV4 – SN:3687

July 26, 2016

Probe EX3DV4

SN:3687

Manufactured: March 10, 2009
Calibrated: July 26, 2016

Calibrated for DASY/EASY Systems
(Note: non-compatible with DASY2 system!)

Certificate No: EX3-3687_Jul16

Page 3 of 38

EX3DV4- SN:3687

July 26, 2018

DASY/EASY - Parameters of Probe: EX3DV4 - SN:3687

Basic Calibration Parameters

	Sensor X	Sensor Y	Sensor Z	Unc (k=2)
Norm ($\mu\text{V}/(\text{V}/\text{m})^{2.5^k}$) ^a	0.51	0.43	0.48	$\pm 10.1\%$
DCP (mV) ^b	99.3	99.8	99.4	

Modulation Calibration Parameters

UID	Communication System Name		A dB	B dB $\sqrt{\mu\text{V}}$	C	D dB	VR mV	Unc (k=2)
0	CW	X	0.0	0.0	1.0	0.00	146.7	$\pm 3.0\%$
		Y	0.0	0.0	1.0		151.7	
		Z	0.0	0.0	1.0		141.2	

Note: For details on UID parameters see Appendix.

Sensor Model Parameters

	C1 fF	C2 fF	α V ⁻¹	T1 ms.V ⁻²	T2 ms.V ⁻¹	T3 ms	T4 V ⁻²	T5 V ⁻¹	T6
X	58.39	438.6	36.55	21.98	1.231	5.04	0.847	0.439	1.01
Y	58.7	443.2	36.41	22.95	1.635	5.015	0.758	0.573	1.007
Z	57.03	428.8	36.14	23.46	1.663	5.025	0.36	0.586	1.006

The reported uncertainty of measurement is stated as the standard uncertainty of measurement multiplied by the coverage factor k=2, which for a normal distribution corresponds to a coverage probability of approximately 95%.

^a The uncertainties of Norm X,Y,Z do not affect the E²-field uncertainty inside TSL (see Pages 5 and 5)

^b Numerical linearization parameter: uncertainty not required.

^c Uncertainty is determined using the max. deviation from linear response applying rectangular distribution and is expressed for the square of the field value.

EX3DV4 - SN:3687

July 26, 2016

DASY/EASY - Parameters of Probe: EX3DV4 - SN:3687

Calibration Parameter Determined in Head Tissue Simulating Media

f (MHz) ^c	Relative Permittivity ^a	Conductivity (S/m) ^a	ConvF X	ConvF Y	ConvF Z	Alpha ^b	Depth (mm) ^d	Unc (k=2)
450	43.5	0.87	9.64	9.64	9.64	0.18	1.30	± 13.3 %
750	41.9	0.89	8.82	8.82	8.82	0.51	0.95	± 12.0 %
835	41.5	0.90	8.61	8.61	8.61	0.55	0.88	± 12.0 %
900	41.5	0.97	8.25	8.25	8.25	0.38	1.03	± 12.0 %
1640	40.3	1.29	8.10	8.10	8.10	0.41	0.80	± 12.0 %
1750	40.1	1.37	7.63	7.63	7.63	0.43	0.81	± 12.0 %
1900	40.0	1.40	7.31	7.31	7.31	0.39	0.80	± 12.0 %
2000	40.0	1.40	7.23	7.23	7.23	0.33	0.80	± 12.0 %
2100	39.8	1.49	7.31	7.31	7.31	0.37	0.80	± 12.0 %
2300	39.5	1.67	7.24	7.24	7.24	0.35	0.80	± 12.0 %
2450	39.2	1.80	6.88	6.88	6.88	0.37	0.86	± 12.0 %
2600	39.0	1.96	6.73	6.73	6.73	0.44	0.81	± 12.0 %
5200	36.0	4.66	4.83	4.83	4.83	0.40	1.80	± 13.1 %
5300	35.9	4.76	4.58	4.58	4.58	0.40	1.80	± 13.1 %
5600	35.5	5.07	4.13	4.13	4.13	0.50	1.80	± 13.1 %
5800	35.3	5.27	4.24	4.24	4.24	0.50	1.80	± 13.1 %

^c Frequency validity above 300 MHz of ± 100 MHz only applies for DASY v4.4 and higher (see Page 2), else it is restricted to ± 50 MHz. The uncertainty is the RSS of the ConvF uncertainty at calibration frequency and the uncertainty for the indicated frequency band. Frequency validity below 300 MHz is ± 10, 25, 40, 50 and 70 MHz for ConvF assessments at 30, 64, 128, 150 and 220 MHz respectively. Above 5 GHz frequency validity can be extended to ± 110 MHz.

^d At frequencies below 3 GHz, the validity of tissue parameters (ϵ and σ) can be relaxed to ± 10% if liquid compensation formula is applied to measured SAR values. At frequencies above 3 GHz, the validity of tissue parameters (ϵ and σ) is restricted to ± 5%. The uncertainty is the RSS of the ConvF uncertainty for indicated target tissue parameters.

^e Alpha/Depth are determined during calibration. SPEAG warrants that the remaining deviation due to the boundary effect after compensation is always less than ± 1% for frequencies below 3 GHz and below ± 2% for frequencies between 3-6 GHz at any distance larger than half the probe tip diameter from the boundary.

EX3DV4-- SN:3687

July 26, 2016

DASY/EASY - Parameters of Probe: EX3DV4 - SN:3687

Calibration Parameter Determined in Body Tissue Simulating Media

f (MHz) ^c	Relative Permittivity ^f	Conductivity (S/m) ^f	ConvF X	ConvF Y	ConvF Z	Alpha ^g	Depth ^h (mm)	Unc (k=2)
450	56.7	0.94	10.18	10.18	10.18	0.09	1.30	± 13.3 %
750	55.5	0.96	8.61	8.61	8.61	0.44	0.80	± 12.0 %
835	55.2	0.97	8.59	8.59	8.59	0.43	0.88	± 12.0 %
900	55.0	1.05	8.49	8.49	8.49	0.42	0.80	± 12.0 %
1640	53.8	1.40	7.73	7.73	7.73	0.43	0.80	± 12.0 %
1750	53.4	1.49	7.25	7.25	7.25	0.34	1.02	± 12.0 %
1900	53.3	1.52	7.19	7.19	7.19	0.50	0.80	± 12.0 %
2000	53.3	1.52	7.23	7.23	7.23	0.44	0.80	± 12.0 %
2450	52.7	1.95	6.84	6.84	6.84	0.41	0.80	± 12.0 %
2600	52.5	2.16	6.66	6.66	6.66	0.32	0.80	± 12.0 %
5200	49.0	5.30	4.33	4.33	4.33	0.50	1.90	± 13.1 %
5300	48.8	5.42	4.16	4.16	4.16	0.50	1.90	± 13.1 %
5600	48.5	5.77	3.60	3.60	3.60	0.60	1.90	± 13.1 %
5800	48.2	6.00	3.67	3.67	3.67	0.60	1.90	± 13.1 %

^c Frequency validity above 300 MHz of ± 100 MHz only applies for DASY v4.4 and higher (see Page 2), else it is restricted to ± 50 MHz. The uncertainty is the RSS of the ConvF uncertainty at calibration frequency and the uncertainty for the indicated frequency band. Frequency validity below 300 MHz is $\pm 10, 25, 40, 50$ and 70 MHz for ConvF assessments at 30, 64, 128, 150 and 220 MHz respectively. Above 5 GHz frequency validity can be extended to ± 110 MHz.

^f At frequencies below 3 GHz, the validity of tissue parameters (ϵ and σ) can be relaxed to $\pm 10\%$ if liquid compensation formula is applied to measured SAR values. At frequencies above 3 GHz, the validity of tissue parameters (ϵ and σ) is restricted to $\pm 5\%$. The uncertainty is the RSS of the ConvF uncertainty for indicated target tissue parameters.

^g Alpha/Depth are determined during calibration. SPEAG warrants that the remaining deviation due to the boundary effect after compensation is always less than $\pm 1\%$ for frequencies below 3 GHz and below $\pm 2\%$ for frequencies between 3-6 GHz at any distance larger than half the probe tip diameter from the boundary.

EX3DV4- SN.3687

July 26, 2016

Frequency Response of E-Field (TEM-Cell:ifi110 EXX, Waveguide: R22)

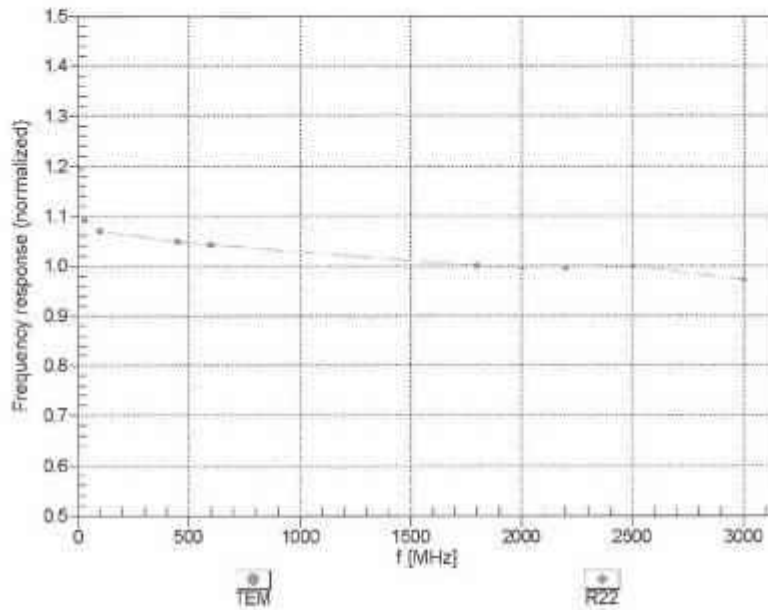

Uncertainty of Frequency Response of E-field: $\pm 6.3\%$ (k=2)

EX30V4- SN:3687

July 26, 2016

Receiving Pattern (ϕ), $\theta = 0^\circ$

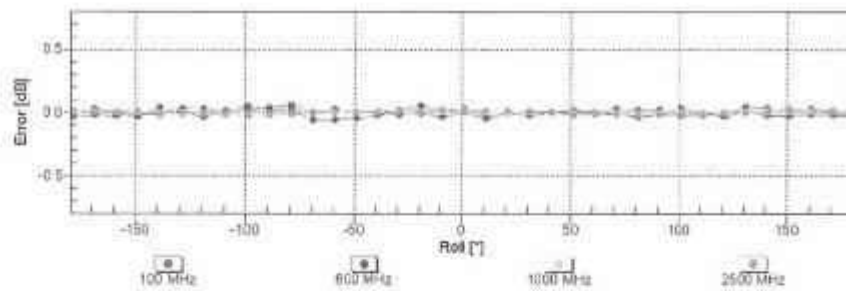
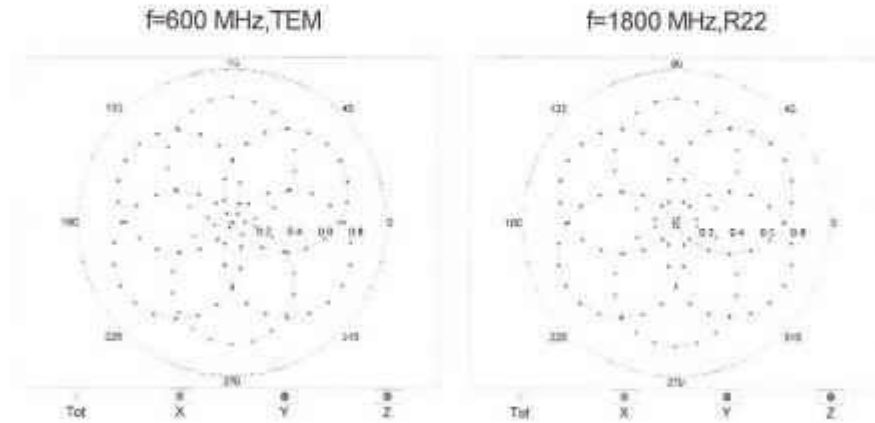

Uncertainty of Axial Isotropy Assessment: $\pm 0.5\%$ ($k=2$)

EX3DV4- SN:3667

July 26, 2016

Dynamic Range $f(SAR_{head})$ (TEM cell, $f_{eval}=1900$ MHz)

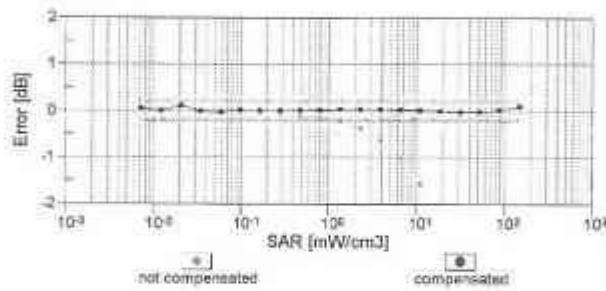
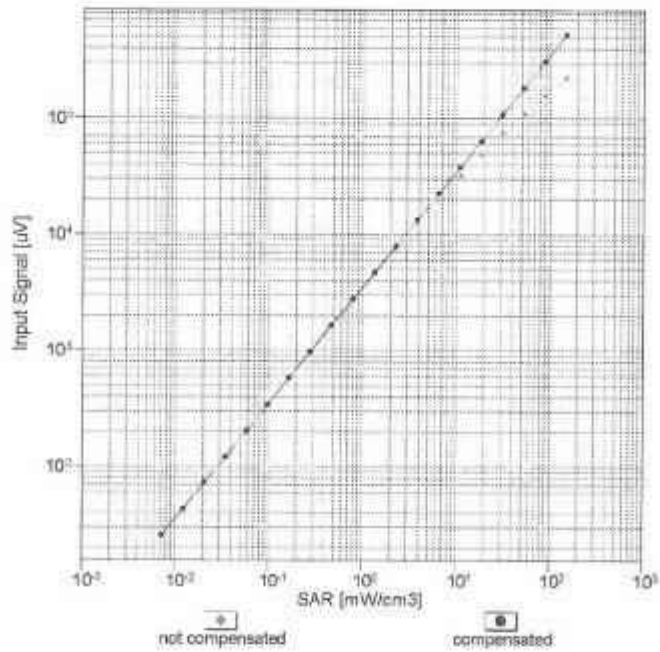

Uncertainty of Linearity Assessment: $\pm 0.6\%$ ($k=2$)

EX3DV4- SN:3687

July 26, 2016

Conversion Factor Assessment

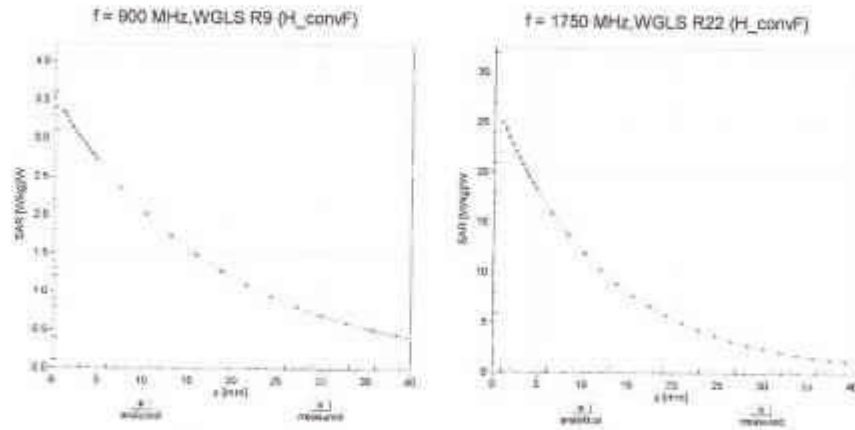

Deviation from Isotropy in Liquid Error (ϕ , θ), $f = 900$ MHz

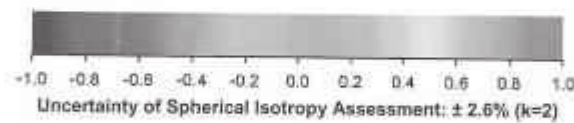
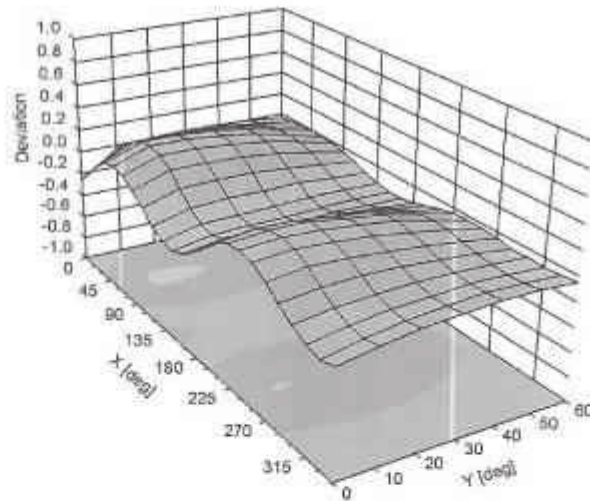

EX3DV4- SN:3687

July 28, 2016

DASY/EASY - Parameters of Probe: EX3DV4 - SN:3687

Other Probe Parameters

Sensor Arrangement	Triangular
Connector Angle (°)	131,1
Mechanical Surface Detection Mode	enabled
Optical Surface Detection Mode	disabled
Probe Overall Length	337 mm
Probe Body Diameter	10 mm
Tip Length	9 mm
Tip Diameter	2,5 mm
Probe Tip to Sensor X Calibration Point	1 mm
Probe Tip to Sensor Y Calibration Point	1 mm
Probe Tip to Sensor Z Calibration Point	1 mm
Recommended Measurement Distance from Surface	1,4 mm

EX3DV4- SN-3887

July 26, 2016

Appendix: Modulation Calibration Parameters

UID	Communication System Name		A dB	B dB/μV	C	D dB	VR mV	Max Unc ^F (k=2)
0	CW	X	0.00	0.00	1.00	0.00	146.7	± 3.0 %
		Y	0.00	0.00	1.00		151.7	
		Z	0.00	0.00	1.00		141.2	
10010- CAA	SAR Validation (Square, 100ms, 10ms)	X	8.12	80.07	17.36	10.00	20.0	± 9.6 %
		Y	4.73	72.88	14.90		20.0	
		Z	6.05	73.40	15.24		20.0	
10011- CAB	UMTS-FDD (WCDMA)	X	5.47	100.57	30.23	0.00	150.0	± 9.6 %
		Y	1.14	66.64	16.28		150.0	
		Z	1.15	69.03	16.42		150.0	
10012- CAB	IEEE 802.11b WiFi 2.4 GHz (DSSS, 1 Mbps)	X	1.47	69.37	19.72	0.41	150.0	± 9.6 %
		Y	1.25	64.81	15.82		150.0	
		Z	1.26	64.77	15.89		150.0	
10013- CAB	IEEE 802.11g WiFi 2.4 GHz (DSSS-OFDM, 6 Mbps)	X	5.10	67.32	17.88	1.46	150.0	± 9.6 %
		Y	5.03	66.66	17.13		150.0	
		Z	5.02	66.73	17.17		150.0	
10021- DAB	GSM-FDD (TDMA, GMSK)	X	100.00	117.79	30.00	9.39	50.0	± 9.6 %
		Y	47.78	106.45	27.33		50.0	
		Z	42.46	104.79	26.97		50.0	
10023- DAB	GPRS-FDD (TDMA, GMSK, TN 0)	X	100.00	117.69	30.00	9.57	50.0	± 9.6 %
		Y	32.51	100.88	25.69		50.0	
		Z	30.74	100.08	25.74		50.0	
10024- DAB	GPRS-FDD (TDMA, GMSK, TN 0-1)	X	100.00	116.35	28.31	6.56	60.0	± 9.6 %
		Y	100.00	113.60	27.27		60.0	
		Z	100.00	113.76	27.40		60.0	
10025- DAB	EDGE-FDD (TDMA, 8PSK, TN 0)	X	16.83	110.67	43.64	12.67	50.0	± 9.6 %
		Y	5.48	73.12	26.26		50.0	
		Z	13.08	99.20	38.16		50.0	
10026- DAB	EDGE-FDD (TDMA, 8PSK, TN 0-1)	X	26.54	116.56	40.95	9.56	60.0	± 9.6 %
		Y	12.44	94.04	32.21		60.0	
		Z	16.35	101.24	35.02		60.0	
10027- DAB	GPRS-FDD (TDMA, GMSK, TN 0-1-2)	X	100.00	117.84	28.21	4.60	80.0	± 9.6 %
		Y	100.00	112.56	26.01		80.0	
		Z	100.00	112.74	26.14		80.0	
10028- DAB	GPRS-FDD (TDMA, GMSK, TN 0-1-2-3)	X	100.00	121.97	29.31	3.55	100.0	± 9.6 %
		Y	100.00	112.90	25.47		100.0	
		Z	100.00	113.07	25.59		100.0	
10029- DAB	EDGE-FDD (TDMA, 8PSK, TN 0-1-2)	X	13.28	99.36	34.22	7.80	80.0	± 9.6 %
		Y	8.56	86.13	28.26		80.0	
		Z	10.11	90.33	30.07		80.0	
10030- CAA	IEEE 802.15.1 Bluetooth (GFSK, DH1)	X	100.00	115.74	27.57	5.30	70.0	± 9.6 %
		Y	100.00	111.65	25.99		70.0	
		Z	100.00	112.06	26.14		70.0	
10031- CAA	IEEE 802.15.1 Bluetooth (GFSK, DH3)	X	100.00	137.33	34.26	1.88	100.0	± 9.6 %
		Y	100.00	113.88	24.56		100.0	
		Z	100.00	113.86	24.56		100.0	

EX3QV4 - SN:3687

July 26, 2016

10032-CAA	IEEE 802.15.1 Bluetooth (GFSK, DH5)	X	100.00	178.30	49.49	1.17	100.0	± 9.6 %
		Y	100.00	120.36	26.31		100.0	
		Z	100.00	119.89	26.12		100.0	
10033-CAA	IEEE 802.15.1 Bluetooth (PI/4-DQPSK, DH1)	X	100.00	130.01	36.94	5.30	70.0	± 9.6 %
		Y	11.43	99.78	24.33		70.0	
		Z	13.89	93.71	25.23		70.0	
10034-CAA	IEEE 802.15.1 Bluetooth (PI/4-DQPSK, DH3)	X	100.00	133.95	35.99	1.88	100.0	± 9.6 %
		Y	4.42	80.86	20.04		100.0	
		Z	5.01	82.52	20.52		100.0	
10035-CAA	IEEE 802.15.1 Bluetooth (PI/4-DQPSK, DH5)	X	100.00	136.41	36.63	1.17	100.0	± 9.6 %
		Y	2.91	76.58	18.39		100.0	
		Z	3.19	77.80	18.73		100.0	
10036-CAA	IEEE 802.15.1 Bluetooth (8-DPSK, DH1)	X	100.00	130.35	36.00	5.30	70.0	± 9.6 %
		Y	14.44	94.67	25.61		70.0	
		Z	17.82	97.83	26.53		70.0	
10037-CAA	IEEE 802.15.1 Bluetooth (8-DPSK, DH3)	X	100.00	133.95	35.94	1.88	100.0	± 9.6 %
		Y	4.20	80.19	19.76		100.0	
		Z	4.77	81.87	20.26		100.0	
10038-CAA	IEEE 802.15.1 Bluetooth (8-DPSK, DH5)	X	100.00	137.26	37.00	1.17	100.0	± 9.6 %
		Y	2.98	77.16	18.70		100.0	
		Z	3.27	78.41	19.06		100.0	
10039-CAB	CDMA2000 (1xRTT, RC1)	X	100.00	138.24	37.17	0.00	150.0	± 9.6 %
		Y	2.40	75.35	18.02		150.0	
		Z	2.35	75.19	17.80		150.0	
10042-CAB	IS-54 / IS-136 FDD (TDMA/FDM, PI/4-DQPSK, Halfrate)	X	100.00	114.11	27.49	7.78	50.0	± 9.6 %
		Y	100.00	112.68	27.08		50.0	
		Z	100.00	112.74	27.16		50.0	
10044-CAA	IS-91/EIA/TIA-553 FDD (FDMA, FM)	X	0.04	60.00	7868.79	0.00	150.0	± 9.6 %
		Y	0.00	96.62	0.06		150.0	
		Z	0.00	99.29	0.03		150.0	
10048-CAA	DECT (TDD, TDMA/FDM, GFSK, Full Slot, 24)	X	51.76	108.79	29.47	13.80	25.0	± 9.6 %
		Y	11.56	84.77	22.78		25.0	
		Z	11.22	84.23	22.65		25.0	
10049-CAA	DECT (TDD, TDMA/FDM, GFSK, Double Slot, 12)	X	100.00	117.85	30.40	10.79	40.0	± 9.6 %
		Y	14.91	89.34	22.89		40.0	
		Z	14.79	89.15	22.90		40.0	
10056-CAA	UMTS-TDD (TD-SCDMA, 1.28 Mcps)	X	62.67	114.60	32.27	9.03	50.0	± 9.6 %
		Y	11.64	86.83	23.60		50.0	
		Z	12.96	88.67	24.23		50.0	
10058-DAB	EDGE-FDD (TDMA, 8PSK, TN 0-1-2-3)	X	6.79	90.34	30.31	6.55	100.0	± 9.6 %
		Y	6.54	81.22	25.72		100.0	
		Z	7.31	83.94	26.96		100.0	
10059-CAB	IEEE 802.11b WiFi 2.4 GHz (DSSS, 2 Mbps)	X	1.70	72.65	21.26	0.61	110.0	± 9.6 %
		Y	1.36	66.16	16.55		110.0	
		Z	1.37	66.46	16.89		110.0	
10060-CAB	IEEE 802.11b WiFi 2.4 GHz (DSSS, 5.5 Mbps)	X	100.00	149.26	41.21	1.30	110.0	± 9.6 %
		Y	54.10	123.50	31.89		110.0	
		Z	100.00	132.22	33.76		110.0	

EX3DV4- SN:3687

July 26, 2016

10081-CAB	IEEE 802.11b WiFi 2.4 GHz (DSSS, 11 Mbps)	X	100.00	148.01	41.80	2.04	110.0	± 9.6 %
		Y	4.81	85.34	23.42		110.0	
		Z	5.90	88.76	24.59		110.0	
10062-CAB	IEEE 802.11a/h WiFi 5 GHz (OFDM, 6 Mbps)	X	4.93	67.45	17.41	0.49	100.0	± 9.6 %
		Y	4.83	66.68	16.62		100.0	
		Z	4.81	66.71	16.62		100.0	
10063-CAB	IEEE 802.11a/h WiFi 5 GHz (OFDM, 9 Mbps)	X	4.95	67.57	17.52	0.72	100.0	± 9.6 %
		Y	4.85	66.78	16.72		100.0	
		Z	4.83	66.82	16.73		100.0	
10064-CAB	IEEE 802.11a/h WiFi 5 GHz (OFDM, 12 Mbps)	X	5.27	67.81	17.71	0.86	100.0	± 9.6 %
		Y	5.18	67.06	16.95		100.0	
		Z	5.15	67.12	16.96		100.0	
10065-CAB	IEEE 802.11a/h WiFi 5 GHz (OFDM, 18 Mbps)	X	5.13	67.75	17.82	1.21	100.0	± 9.6 %
		Y	5.04	67.00	17.04		100.0	
		Z	5.02	67.05	17.06		100.0	
10066-CAB	IEEE 802.11a/h WiFi 5 GHz (OFDM, 24 Mbps)	X	5.15	67.78	17.99	1.46	100.0	± 9.6 %
		Y	5.07	67.04	17.20		100.0	
		Z	5.05	67.11	17.24		100.0	
10067-CAB	IEEE 802.11a/h WiFi 5 GHz (OFDM, 36 Mbps)	X	5.42	67.75	18.31	2.04	100.0	± 9.6 %
		Y	5.36	67.09	17.57		100.0	
		Z	5.34	67.20	17.63		100.0	
10068-CAB	IEEE 802.11a/h WiFi 5 GHz (OFDM, 48 Mbps)	X	5.51	67.97	18.60	2.55	100.0	± 9.6 %
		Y	5.45	67.32	17.85		100.0	
		Z	5.44	67.43	17.93		100.0	
10069-CAB	IEEE 802.11a/h WiFi 5 GHz (OFDM, 54 Mbps)	X	5.57	67.85	18.73	2.67	100.0	± 9.6 %
		Y	5.52	67.23	18.00		100.0	
		Z	5.52	67.37	18.10		100.0	
10071-CAB	IEEE 802.11g WiFi 2.4 GHz (DSSS/OFDM, 9 Mbps)	X	5.20	67.41	18.16	1.99	100.0	± 9.6 %
		Y	5.14	66.77	17.43		100.0	
		Z	5.13	66.86	17.48		100.0	
10072-CAB	IEEE 802.11g WiFi 2.4 GHz (DSSS/OFDM, 12 Mbps)	X	5.22	67.89	18.44	2.30	100.0	± 9.6 %
		Y	5.15	67.18	17.66		100.0	
		Z	5.15	67.30	17.73		100.0	
10073-CAB	IEEE 802.11g WiFi 2.4 GHz (DSSS/OFDM, 18 Mbps)	X	5.29	68.07	18.76	2.83	100.0	± 9.6 %
		Y	5.23	67.36	17.97		100.0	
		Z	5.23	67.51	18.07		100.0	
10074-CAB	IEEE 802.11g WiFi 2.4 GHz (DSSS/OFDM, 24 Mbps)	X	5.27	67.97	18.92	3.30	100.0	± 9.6 %
		Y	5.22	67.30	18.14		100.0	
		Z	5.23	67.47	18.25		100.0	
10075-CAB	IEEE 802.11g WiFi 2.4 GHz (DSSS/OFDM, 36 Mbps)	X	5.35	68.25	19.31	3.82	90.0	± 9.6 %
		Y	5.31	67.58	18.51		90.0	
		Z	5.33	67.79	18.65		90.0	
10076-CAB	IEEE 802.11g WiFi 2.4 GHz (DSSS/OFDM, 48 Mbps)	X	5.32	67.92	19.35	4.15	90.0	± 9.6 %
		Y	5.30	67.31	18.58		90.0	
		Z	5.32	67.53	18.73		90.0	
10077-CAB	IEEE 802.11g WiFi 2.4 GHz (DSSS/OFDM, 54 Mbps)	X	5.34	67.97	19.44	4.30	90.0	± 9.6 %
		Y	5.32	67.36	18.66		90.0	
		Z	5.35	67.61	18.83		90.0	

EX3DV4 – SN:3687

July 26, 2016

10081-CAB	CDMA2000 (1xRTT, RC3)	X	100.00	146.01	39.19	0.00	150.0	± 9.6 %
		Y	1.06	68.37	14.70		150.0	
		Z	1.05	68.48	14.81		150.0	
10082-CAB	IS-54 / IS-136 FDD (TDM/FDD, P1/4-DQPSK, Fullrate)	X	1.10	60.54	5.66	4.77	60.0	± 9.6 %
		Y	1.19	60.42	5.97		60.0	
		Z	1.25	60.72	6.16		60.0	
10090-DAB	GPRS-FDD (TDMA, GMSK, TN 0-4)	X	100.00	116.36	29.34	6.56	60.0	± 9.6 %
		Y	100.00	113.64	27.30		60.0	
		Z	100.00	113.80	27.44		60.0	
10097-CAB	UMTS-FDD (HSOPA)	X	2.81	76.39	21.08	0.00	150.0	± 9.6 %
		Y	1.94	68.17	16.32		150.0	
		Z	1.93	68.24	16.29		150.0	
10098-CAB	UMTS-FDD (HSUPA, Subtest 2)	X	2.79	76.62	21.18	0.00	150.0	± 9.6 %
		Y	1.90	68.13	16.28		150.0	
		Z	1.89	68.21	16.27		150.0	
10099-DAB	EDGE-FDD (TDMA, 8PSK, TN 0-4)	X	26.62	116.57	40.94	9.56	60.0	± 9.6 %
		Y	12.47	94.04	32.21		60.0	
		Z	16.37	101.20	34.99		60.0	
10100-CAB	LTE-FDD (SC-FDMA, 100% RB, 20 MHz, QPSK)	X	4.77	78.19	20.90	0.00	150.0	± 9.6 %
		Y	3.38	71.21	17.21		150.0	
		Z	3.37	71.25	17.21		150.0	
10101-CAB	LTE-FDD (SC-FDMA, 100% RB, 20 MHz, 16-QAM)	X	3.79	70.60	18.13	0.00	150.0	± 9.6 %
		Y	3.40	67.94	16.26		150.0	
		Z	3.38	67.95	16.25		150.0	
10102-CAB	LTE-FDD (SC-FDMA, 100% RB, 20 MHz, 64-QAM)	X	3.85	70.26	18.07	0.00	150.0	± 9.6 %
		Y	3.51	67.88	16.35		150.0	
		Z	3.48	67.86	16.32		150.0	
10103-CAB	LTE-TDD (SC-FDMA, 100% RB, 20 MHz, QPSK)	X	9.07	81.21	22.88	3.98	65.0	± 9.6 %
		Y	7.32	76.10	20.29		65.0	
		Z	7.60	77.27	20.79		65.0	
10104-CAB	LTE-TDD (SC-FDMA, 100% RB, 20 MHz, 16-QAM)	X	6.19	77.73	22.41	3.98	65.0	± 9.6 %
		Y	7.44	74.94	20.67		65.0	
		Z	7.60	75.47	20.94		65.0	
10105-CAB	LTE-TDD (SC-FDMA, 100% RB, 20 MHz, 64-QAM)	X	7.61	76.45	22.17	3.98	65.0	± 9.6 %
		Y	6.94	73.56	20.38		65.0	
		Z	7.46	75.06	21.08		65.0	
10106-CAC	LTE-FDD (SC-FDMA, 100% RB, 10 MHz, QPSK)	X	4.14	77.29	20.62	0.00	150.0	± 9.6 %
		Y	2.98	70.38	17.04		150.0	
		Z	2.96	70.42	17.03		150.0	
10109-CAC	LTE-FDD (SC-FDMA, 100% RB, 10 MHz, 16-QAM)	X	3.49	70.88	18.35	0.00	150.0	± 9.6 %
		Y	3.07	67.80	16.23		150.0	
		Z	3.05	67.80	16.20		150.0	
10110-CAC	LTE-FDD (SC-FDMA, 100% RB, 5 MHz, QPSK)	X	3.50	77.15	21.02	0.00	150.0	± 9.6 %
		Y	2.44	68.41	16.71		150.0	
		Z	2.42	68.50	16.72		150.0	
10111-CAC	LTE-FDD (SC-FDMA, 100% RB, 5 MHz, 16-QAM)	X	3.39	73.07	19.46	0.00	150.0	± 9.6 %
		Y	2.81	68.67	16.66		150.0	
		Z	2.77	68.57	16.58		150.0	

Certificate No: EX3-3687_Jul16

Page 15 of 38

EX3DV4-SN-3687

July 28, 2016

10112-CAC	LTE-FDD (SC-FDMA, 100% RB, 10 MHz, 64-QAM)	X	3.57	70.56	18.21	0.00	150.0	± 9.6 %
		Y	3.20	67.74	16.27		150.0	
		Z	3.17	67.72	16.23		150.0	
10113-CAC	LTE-FDD (SC-FDMA, 100% RB, 5 MHz, 64-QAM)	X	3.50	72.70	19.32	0.00	150.0	± 9.6 %
		Y	2.96	68.74	16.78		150.0	
		Z	2.92	68.63	16.67		150.0	
10114-CAB	IEEE 802.11n (HT Greenfield, 13.5 Mbps, BPSK)	X	5.36	67.98	17.28	0.00	150.0	± 9.6 %
		Y	5.25	67.23	16.54		150.0	
		Z	5.22	67.22	16.52		150.0	
10115-CAB	IEEE 802.11n (HT Greenfield, 81 Mbps, 16-QAM)	X	6.72	68.24	17.38	0.00	150.0	± 9.6 %
		Y	5.61	67.53	16.70		150.0	
		Z	5.58	67.52	16.68		150.0	
10116-CAB	IEEE 802.11n (HT Greenfield, 135 Mbps, 64-QAM)	X	5.50	68.28	17.35	0.00	150.0	± 9.6 %
		Y	5.38	67.50	16.60		150.0	
		Z	5.34	67.48	16.58		150.0	
10117-CAB	IEEE 802.11n (HT Mixed, 13.5 Mbps, BPSK)	X	5.36	67.97	17.30	0.00	150.0	± 9.6 %
		Y	5.25	67.22	16.56		150.0	
		Z	5.21	67.20	16.53		150.0	
10118-CAB	IEEE 802.11n (HT Mixed, 81 Mbps, 16-QAM)	X	5.81	68.43	17.50	0.00	150.0	± 9.6 %
		Y	5.68	67.70	16.79		150.0	
		Z	5.65	67.69	16.77		150.0	
10119-CAB	IEEE 802.11n (HT Mixed, 135 Mbps, 64-QAM)	X	5.47	68.22	17.33	0.00	150.0	± 9.6 %
		Y	5.35	67.44	16.59		150.0	
		Z	5.31	67.42	16.56		150.0	
10140-CAB	LTE-FDD (SC-FDMA, 100% RB, 15 MHz, 16-QAM)	X	3.90	70.24	17.97	0.00	150.0	± 9.6 %
		Y	3.55	67.87	16.27		150.0	
		Z	3.53	67.87	16.24		150.0	
10141-CAB	LTE-FDD (SC-FDMA, 100% RB, 15 MHz, 64-QAM)	X	3.99	70.11	18.01	0.00	150.0	± 9.6 %
		Y	3.67	67.93	16.42		150.0	
		Z	3.64	67.91	16.38		150.0	
10142-CAC	LTE-FDD (SC-FDMA, 100% RB, 3 MHz, QPSK)	X	3.61	79.49	21.84	0.00	150.0	± 9.6 %
		Y	2.23	69.52	16.58		150.0	
		Z	2.21	69.58	16.57		150.0	
10143-CAC	LTE-FDD (SC-FDMA, 100% RB, 3 MHz, 16-QAM)	X	3.74	76.40	20.46	0.00	150.0	± 9.6 %
		Y	2.72	69.66	18.71		150.0	
		Z	2.67	69.50	18.54		150.0	
10144-CAC	LTE-FDD (SC-FDMA, 100% RB, 3 MHz, 64-QAM)	X	3.14	72.31	18.16	0.00	150.0	± 9.6 %
		Y	2.47	67.28	15.08		150.0	
		Z	2.45	67.30	15.02		150.0	
10145-CAC	LTE-FDD (SC-FDMA, 100% RB, 1.4 MHz, QPSK)	X	6.62	95.67	25.59	0.00	150.0	± 9.6 %
		Y	1.62	68.20	14.45		150.0	
		Z	1.57	67.89	14.13		150.0	
10146-CAC	LTE-FDD (SC-FDMA, 100% RB, 1.4 MHz, 16-QAM)	X	55.01	114.84	29.58	0.00	150.0	± 9.6 %
		Y	3.14	71.71	15.30		150.0	
		Z	2.83	69.57	14.17		150.0	
10147-CAC	LTE-FDD (SC-FDMA, 100% RB, 1.4 MHz, 64-QAM)	X	100.00	124.53	32.18	0.00	150.0	± 9.6 %
		Y	4.25	75.99	17.23		150.0	
		Z	3.26	72.51	15.62		150.0	

EX3DV4- SN-3687

July 26, 2016

10149-CAB	LTE-FDD (SC-FDMA, 50% RB, 20 MHz, 16-QAM)	X	3.50	70.96	18.41	0.00	150.0	± 9.6 %
		Y	3.08	67.67	16.28		150.0	
		Z	3.06	67.86	16.25		150.0	
10150-CAB	LTE-FDD (SC-FDMA, 50% RB, 20 MHz, 64-QAM)	X	3.58	70.57	18.26	0.00	150.0	± 9.6 %
		Y	3.21	67.80	16.31		150.0	
		Z	3.18	67.77	16.27		150.0	
10151-CAB	LTE-TDD (SC-FDMA, 50% RB, 20 MHz, QPSK)	X	10.19	64.85	24.39	3.98	65.0	± 9.6 %
		Y	7.80	78.46	21.32		65.0	
		Z	8.08	79.17	21.62		65.0	
10152-CAB	LTE-TDD (SC-FDMA, 50% RB, 20 MHz, 16-QAM)	X	7.82	78.30	22.44	3.98	65.0	± 9.6 %
		Y	6.98	74.89	20.41		65.0	
		Z	7.17	75.53	20.72		65.0	
10153-CAB	LTE-TDD (SC-FDMA, 50% RB, 20 MHz, 64-QAM)	X	8.19	79.08	23.11	3.98	65.0	± 9.6 %
		Y	7.38	75.81	21.17		65.0	
		Z	7.55	76.36	21.42		65.0	
10154-CAC	LTE-FDD (SC-FDMA, 50% RB, 10 MHz, QPSK)	X	3.68	78.13	21.50	0.00	150.0	± 9.6 %
		Y	2.51	70.00	17.06		150.0	
		Z	2.48	69.99	17.02		150.0	
10155-CAC	LTE-FDD (SC-FDMA, 50% RB, 10 MHz, 16-QAM)	X	3.39	73.07	19.46	0.00	150.0	± 9.6 %
		Y	2.81	69.68	16.69		150.0	
		Z	2.77	69.59	16.59		150.0	
10156-CAC	LTE-FDD (SC-FDMA, 50% RB, 5 MHz, QPSK)	X	4.05	82.92	23.06	0.00	150.0	± 9.6 %
		Y	2.11	69.93	16.64		150.0	
		Z	2.08	69.96	16.58		150.0	
10157-CAC	LTE-FDD (SC-FDMA, 50% RB, 5 MHz, 16-QAM)	X	3.42	75.61	19.48	0.00	150.0	± 9.6 %
		Y	2.34	68.13	15.35		150.0	
		Z	2.31	68.12	15.25		150.0	
10158-CAC	LTE-FDD (SC-FDMA, 50% RB, 10 MHz, 64-QAM)	X	3.51	72.78	19.38	0.00	150.0	± 9.6 %
		Y	2.97	66.80	16.83		150.0	
		Z	2.93	66.69	16.71		150.0	
10159-CAC	LTE-FDD (SC-FDMA, 50% RB, 5 MHz, 64-QAM)	X	3.64	76.34	19.85	0.00	150.0	± 9.6 %
		Y	2.48	68.72	15.71		150.0	
		Z	2.44	68.63	15.56		150.0	
10160-CAB	LTE-FDD (SC-FDMA, 50% RB, 15 MHz, QPSK)	X	3.65	74.05	19.70	0.00	150.0	± 9.6 %
		Y	2.93	69.11	16.71		150.0	
		Z	2.90	69.14	16.70		150.0	
10161-CAB	LTE-FDD (SC-FDMA, 50% RB, 15 MHz, 16-QAM)	X	3.48	70.62	18.30	0.00	150.0	± 9.6 %
		Y	3.10	67.72	16.27		150.0	
		Z	3.07	67.70	16.22		150.0	
10162-CAB	LTE-FDD (SC-FDMA, 50% RB, 15 MHz, 64-QAM)	X	3.57	70.54	18.28	0.00	150.0	± 9.6 %
		Y	3.21	67.79	16.34		150.0	
		Z	3.18	67.77	16.29		150.0	
10166-CAC	LTE-FDD (SC-FDMA, 50% RB, 1.4 MHz, QPSK)	X	4.11	72.19	21.18	3.01	150.0	± 9.6 %
		Y	3.92	70.03	19.41		150.0	
		Z	3.78	69.59	19.15		150.0	
10167-CAC	LTE-FDD (SC-FDMA, 50% RB, 1.4 MHz, 16-QAM)	X	5.47	76.52	22.17	3.01	150.0	± 9.6 %
		Y	5.02	73.28	20.00		150.0	
		Z	4.73	72.52	19.64		150.0	

Certificate No: EX3-3687_Jul16

Page 17 of 38

EX3DV4- SN:3687

July 28, 2016

10169-CAC	LTE-FDD (SC-FDMA, 50% RB, 1.4 MHz, 64-QAM)	X	6.19	70.29	23.65	3.01	150.0	± 9.6 %
		Y	5.62	75.73	21.40		150.0	
		Z	5.20	74.53	20.83		150.0	
10169-CAB	LTE-FDD (SC-FDMA, 1 RB, 20 MHz, QPSK)	X	3.70	73.91	22.13	3.01	150.0	± 9.6 %
		Y	3.53	71.06	19.83		150.0	
		Z	3.30	70.11	19.37		150.0	
10170-CAB	LTE-FDD (SC-FDMA, 1 RB, 20 MHz, 16-QAM)	X	6.48	84.90	26.20	3.01	150.0	± 9.6 %
		Y	5.44	78.61	22.65		150.0	
		Z	4.70	76.21	21.88		150.0	
10171-AAB	LTE-FDD (SC-FDMA, 1 RB, 20 MHz, 64-QAM)	X	4.88	78.31	22.63	3.01	150.0	± 9.6 %
		Y	4.21	73.16	19.43		150.0	
		Z	3.85	72.02	18.96		150.0	
10172-CAB	LTE-TDD (SC-FDMA, 1 RB, 20 MHz, QPSK)	X	80.84	135.90	41.68	6.02	65.0	± 9.6 %
		Y	12.39	93.36	28.20		65.0	
		Z	11.61	92.61	28.07		65.0	
10173-CAB	LTE-TDD (SC-FDMA, 1 RB, 20 MHz, 16-QAM)	X	100.00	131.01	37.95	6.02	65.0	± 9.6 %
		Y	19.60	97.20	27.69		65.0	
		Z	18.54	96.69	27.56		65.0	
10174-CAB	LTE-TDD (SC-FDMA, 1 RB, 20 MHz, 64-QAM)	X	100.00	128.63	36.72	6.02	65.0	± 9.6 %
		Y	14.08	90.60	25.17		65.0	
		Z	15.07	91.99	25.63		65.0	
10175-CAC	LTE-FDD (SC-FDMA, 1 RB, 10 MHz, QPSK)	X	3.64	73.46	21.82	3.01	150.0	± 9.6 %
		Y	3.47	70.85	19.53		150.0	
		Z	3.26	69.78	19.12		150.0	
10176-CAC	LTE-FDD (SC-FDMA, 1 RB, 10 MHz, 16-QAM)	X	6.50	84.93	26.21	3.01	150.0	± 9.6 %
		Y	5.45	78.64	22.66		150.0	
		Z	4.71	76.24	21.67		150.0	
10177-CAE	LTE-FDD (SC-FDMA, 1 RB, 5 MHz, QPSK)	X	3.68	73.69	21.95	3.01	150.0	± 9.6 %
		Y	3.51	70.87	19.86		150.0	
		Z	3.29	69.64	19.22		150.0	
10178-CAC	LTE-FDD (SC-FDMA, 1 RB, 5 MHz, 16-QAM)	X	6.35	84.45	26.00	3.01	150.0	± 9.6 %
		Y	5.35	78.24	22.47		150.0	
		Z	4.65	75.97	21.93		150.0	
10179-CAC	LTE-FDD (SC-FDMA, 1 RB, 10 MHz, 64-QAM)	X	5.62	81.51	24.30	3.01	150.0	± 9.6 %
		Y	4.74	75.60	20.84		150.0	
		Z	4.23	73.96	20.17		150.0	
10180-CAC	LTE-FDD (SC-FDMA, 1 RB, 5 MHz, 64-QAM)	X	4.83	78.16	22.54	3.01	150.0	± 9.6 %
		Y	4.19	73.03	19.35		150.0	
		Z	3.84	71.93	18.91		150.0	
10181-CAB	LTE-FDD (SC-FDMA, 1 RB, 15 MHz, QPSK)	X	3.67	73.67	21.94	3.01	150.0	± 9.6 %
		Y	3.51	70.85	19.65		150.0	
		Z	3.29	69.92	19.21		150.0	
10182-CAB	LTE-FDD (SC-FDMA, 1 RB, 15 MHz, 16-QAM)	X	6.34	84.41	25.99	3.01	150.0	± 9.6 %
		Y	5.34	78.21	22.46		150.0	
		Z	4.64	75.94	21.52		150.0	
10183-AAA	LTE-FDD (SC-FDMA, 1 RB, 15 MHz, 64-QAM)	X	4.82	78.12	22.53	3.01	150.0	± 9.6 %
		Y	4.18	73.01	19.34		150.0	
		Z	3.83	71.91	18.89		150.0	

EX3DV4- SN-3667

July 26, 2016

10184-CAC	LTE-FDD (SC-FDMA, 1 RB, 3 MHz, QPSK)	X	3.89	73.72	21.97	3.01	150.0	± 9.6 %
		Y	3.52	70.90	19.67		150.0	
		Z	3.30	69.67	19.23		150.0	
10185-CAC	LTE-FDD (SC-FDMA, 1 RB, 3 MHz, 16-QAM)	X	6.38	64.53	26.03	3.01	150.0	± 9.6 %
		Y	5.37	78.30	22.50		150.0	
		Z	4.66	76.01	21.56		150.0	
10186-AAC	LTE-FDD (SC-FDMA, 1 RB, 3 MHz, 64-QAM)	X	4.85	78.23	22.58	3.01	150.0	± 9.6 %
		Y	4.21	73.08	19.38		150.0	
		Z	3.85	71.97	18.93		150.0	
10187-CAC	LTE-FDD (SC-FDMA, 1 RB, 1.4 MHz, QPSK)	X	3.70	73.76	22.02	3.01	150.0	± 9.6 %
		Y	3.53	70.93	19.72		150.0	
		Z	3.30	70.01	19.28		150.0	
10188-CAC	LTE-FDD (SC-FDMA, 1 RB, 1.4 MHz, 16-QAM)	X	6.74	65.72	26.58	3.01	150.0	± 9.6 %
		Y	5.63	79.28	23.00		150.0	
		Z	4.82	76.72	21.94		150.0	
10189-AAC	LTE-FDD (SC-FDMA, 1 RB, 1.4 MHz, 64-QAM)	X	5.02	78.94	22.96	3.01	150.0	± 9.6 %
		Y	4.33	73.64	19.71		150.0	
		Z	3.94	72.42	19.21		150.0	
10193-CAB	IEEE 802.11n (HT Greenfield, 6.5 Mbps, BPSK)	X	4.78	67.50	17.14	0.00	150.0	± 9.6 %
		Y	4.67	66.66	16.33		150.0	
		Z	4.64	66.66	16.30		150.0	
10194-CAB	IEEE 802.11n (HT Greenfield, 39 Mbps, 16-QAM)	X	4.98	67.67	17.25	0.00	150.0	± 9.6 %
		Y	4.86	67.02	16.44		150.0	
		Z	4.83	67.01	16.41		150.0	
10195-CAB	IEEE 802.11n (HT Greenfield, 65 Mbps, 64-QAM)	X	5.02	67.67	17.25	0.00	150.0	± 9.6 %
		Y	4.81	67.04	16.45		150.0	
		Z	4.67	67.03	16.42		150.0	
10196-CAB	IEEE 802.11n (HT Mixed, 6.5 Mbps, BPSK)	X	4.80	67.61	17.18	0.00	150.0	± 9.6 %
		Y	4.69	66.76	16.36		150.0	
		Z	4.66	66.75	16.33		150.0	
10197-CAB	IEEE 802.11n (HT Mixed, 39 Mbps, 16-QAM)	X	5.00	67.89	17.26	0.00	150.0	± 9.6 %
		Y	4.88	67.04	16.45		150.0	
		Z	4.85	67.03	16.43		150.0	
10198-CAB	IEEE 802.11n (HT Mixed, 65 Mbps, 64-QAM)	X	5.03	67.80	17.26	0.00	150.0	± 9.6 %
		Y	4.81	67.05	16.46		150.0	
		Z	4.88	67.05	16.44		150.0	
10219-CAB	IEEE 802.11n (HT Mixed, 7.2 Mbps, BPSK)	X	4.76	67.66	17.17	0.00	150.0	± 9.6 %
		Y	4.64	66.77	16.33		150.0	
		Z	4.60	66.76	16.30		150.0	
10220-CAB	IEEE 802.11n (HT Mixed, 43.3 Mbps, 16-QAM)	X	5.00	67.87	17.26	0.00	150.0	± 9.6 %
		Y	4.88	67.03	16.45		150.0	
		Z	4.64	67.02	16.42		150.0	
10221-CAB	IEEE 802.11n (HT Mixed, 72.2 Mbps, 64-QAM)	X	5.03	67.80	17.24	0.00	150.0	± 9.6 %
		Y	4.92	66.98	16.45		150.0	
		Z	4.88	66.98	16.42		150.0	
10222-CAB	IEEE 802.11n (HT Mixed, 15 Mbps, BPSK)	X	5.34	66.00	17.30	0.00	150.0	± 9.6 %
		Y	5.23	67.24	16.56		150.0	
		Z	5.19	67.22	16.53		150.0	

EX3DV4- SN-3687

July 26, 2016

10223-CAB	IEEE 802.11n (HT Mixed, 90 Mbps, 16-QAM)	X	5.69	66.22	17.41	0.00	150.0	± 9.6 %
		Y	5.58	67.53	16.72		150.0	
		Z	5.53	67.46	16.67		150.0	
10224-CAB	IEEE 802.11n (HT Mixed, 150 Mbps, 64-QAM)	X	5.39	66.11	17.26	0.00	150.0	± 9.6 %
		Y	5.27	67.34	16.54		150.0	
		Z	5.24	67.32	16.51		150.0	
10225-CAB	UMTS-FDD (HSPA+)	X	3.19	68.47	17.44	0.00	150.0	± 9.6 %
		Y	2.95	66.32	15.76		150.0	
		Z	2.92	66.32	15.71		150.0	
10226-CAA	LTE-TDD (SC-FDMA, 1 RB, 1.4 MHz, 16-QAM)	X	100.00	131.25	38.11	6.02	65.0	± 9.6 %
		Y	20.98	96.60	26.20		65.0	
		Z	19.70	97.66	28.03		65.0	
10227-CAA	LTE-TDD (SC-FDMA, 1 RB, 1.4 MHz, 64-QAM)	X	100.00	128.80	36.64	6.02	65.0	± 9.6 %
		Y	17.56	94.28	26.38		65.0	
		Z	16.49	93.53	26.17		65.0	
10228-CAA	LTE-TDD (SC-FDMA, 1 RB, 1.4 MHz, QPSK)	X	100.00	140.79	42.97	6.02	65.0	± 9.6 %
		Y	16.26	98.67	30.05		65.0	
		Z	17.41	100.57	36.65		65.0	
10229-CAB	LTE-TDD (SC-FDMA, 1 RB, 3 MHz, 16-QAM)	X	100.00	131.00	37.96	6.02	65.0	± 9.6 %
		Y	19.62	97.29	27.72		65.0	
		Z	18.63	96.75	27.61		65.0	
10230-CAB	LTE-TDD (SC-FDMA, 1 RB, 3 MHz, 64-QAM)	X	100.00	128.61	36.72	6.02	65.0	± 9.6 %
		Y	16.55	93.20	25.97		65.0	
		Z	15.70	92.61	25.82		65.0	
10231-CAB	LTE-TDD (SC-FDMA, 1 RB, 3 MHz, QPSK)	X	100.00	140.80	42.85	6.02	65.0	± 9.6 %
		Y	15.36	97.68	29.58		65.0	
		Z	16.54	99.46	30.24		65.0	
10232-CAB	LTE-TDD (SC-FDMA, 1 RB, 5 MHz, 16-QAM)	X	100.00	131.01	37.96	6.02	65.0	± 9.6 %
		Y	19.59	97.28	27.72		65.0	
		Z	18.62	96.75	27.61		65.0	
10233-CAB	LTE-TDD (SC-FDMA, 1 RB, 5 MHz, 64-QAM)	X	100.00	128.63	36.72	6.02	65.0	± 9.6 %
		Y	16.54	93.19	25.96		65.0	
		Z	15.89	92.62	25.82		65.0	
10234-CAB	LTE-TDD (SC-FDMA, 1 RB, 5 MHz, QPSK)	X	100.00	140.25	42.64	6.02	65.0	± 9.6 %
		Y	14.56	96.49	29.11		65.0	
		Z	15.72	98.36	29.79		65.0	
10235-CAB	LTE-TDD (SC-FDMA, 1 RB, 10 MHz, 16-QAM)	X	100.00	131.03	37.97	6.02	65.0	± 9.6 %
		Y	19.62	97.32	27.73		65.0	
		Z	18.63	96.79	27.62		65.0	
10236-CAB	LTE-TDD (SC-FDMA, 1 RB, 10 MHz, 64-QAM)	X	100.00	128.58	36.70	6.02	65.0	± 9.6 %
		Y	16.67	93.30	25.99		65.0	
		Z	15.82	92.73	25.65		65.0	
10237-CAB	LTE-TDD (SC-FDMA, 1 RB, 10 MHz, QPSK)	X	100.00	140.63	42.85	6.02	65.0	± 9.6 %
		Y	15.42	97.76	29.63		65.0	
		Z	16.53	99.61	30.28		65.0	
10238-CAB	LTE-TDD (SC-FDMA, 1 RB, 15 MHz, 16-QAM)	X	100.00	131.02	37.96	6.02	65.0	± 9.6 %
		Y	19.57	97.27	27.71		65.0	
		Z	18.60	96.74	27.61		65.0	

Certificate No: EX3-3687_Jul16

Page 20 of 38

EX30V4-SN3687

July 28, 2016

10239-CAB	LTE-TDD (SC-FDMA, 1 RB, 15 MHz, 64-QAM)	X	100.00	128.65	36.73	6.02	65.0	± 9.6 %
		Y	18.51	93.18	25.98		65.0	
		Z	15.67	92.61	25.82		65.0	
10240-CAB	LTE-TDD (SC-FDMA, 1 RB, 15 MHz, QPSK)	X	100.00	140.64	42.86	6.02	65.0	± 9.6 %
		Y	15.37	97.72	29.61		65.0	
		Z	18.57	99.58	30.26		65.0	
10241-CAA	LTE-TDD (SC-FDMA, 50% RB, 1.4 MHz, 16-QAM)	X	11.18	87.08	28.18	6.98	65.0	± 9.6 %
		Y	9.85	82.30	25.49		65.0	
		Z	9.97	82.82	25.75		65.0	
10242-CAA	LTE-TDD (SC-FDMA, 50% RB, 1.4 MHz, 64-QAM)	X	10.03	84.59	27.11	6.98	65.0	± 9.6 %
		Y	8.73	79.66	24.33		65.0	
		Z	9.63	82.05	25.36		65.0	
10243-CAA	LTE-TDD (SC-FDMA, 50% RB, 1.4 MHz, QPSK)	X	7.74	80.52	26.42	6.98	65.0	± 9.6 %
		Y	7.01	76.51	23.85		65.0	
		Z	7.84	79.37	26.19		65.0	
10244-CAB	LTE-TDD (SC-FDMA, 50% RB, 3 MHz, 16-QAM)	X	11.81	86.45	23.80	3.98	65.0	± 9.6 %
		Y	7.61	77.57	19.62		65.0	
		Z	7.35	76.97	19.27		65.0	
10245-CAB	LTE-TDD (SC-FDMA, 50% RB, 3 MHz, 64-QAM)	X	11.08	85.36	23.16	3.98	65.0	± 9.6 %
		Y	7.51	77.12	19.39		65.0	
		Z	7.25	76.52	19.05		65.0	
10246-CAB	LTE-TDD (SC-FDMA, 50% RB, 3 MHz, QPSK)	X	16.24	95.28	26.50	3.98	65.0	± 9.6 %
		Y	7.16	79.78	26.52		65.0	
		Z	7.51	80.53	20.76		65.0	
10247-CAB	LTE-TDD (SC-FDMA, 50% RB, 5 MHz, 16-QAM)	X	8.05	81.05	22.29	3.98	65.0	± 9.6 %
		Y	6.32	75.38	19.43		65.0	
		Z	6.47	75.81	19.57		65.0	
10248-CAB	LTE-TDD (SC-FDMA, 50% RB, 5 MHz, 64-QAM)	X	7.82	80.00	21.85	3.98	65.0	± 9.6 %
		Y	6.32	74.88	19.21		65.0	
		Z	6.47	75.33	19.37		65.0	
10249-CAB	LTE-TDD (SC-FDMA, 50% RB, 5 MHz, QPSK)	X	17.10	96.66	27.78	3.98	65.0	± 9.6 %
		Y	8.08	81.80	21.94		65.0	
		Z	8.58	82.83	22.30		65.0	
10250-CAB	LTE-TDD (SC-FDMA, 50% RB, 10 MHz, 16-QAM)	X	8.60	82.25	24.10	3.98	65.0	± 9.6 %
		Y	7.18	77.35	21.51		65.0	
		Z	7.37	77.88	21.73		65.0	
10251-CAB	LTE-TDD (SC-FDMA, 50% RB, 10 MHz, 64-QAM)	X	7.82	79.11	22.53	3.98	65.0	± 9.6 %
		Y	6.80	75.16	20.30		65.0	
		Z	7.00	75.81	20.58		65.0	
10252-CAB	LTE-TDD (SC-FDMA, 50% RB, 10 MHz, QPSK)	X	12.94	91.44	26.79	3.98	65.0	± 9.6 %
		Y	8.15	81.13	22.37		65.0	
		Z	8.58	82.12	22.75		65.0	
10253-CAB	LTE-TDD (SC-FDMA, 50% RB, 15 MHz, 16-QAM)	X	7.51	77.42	22.12	3.98	65.0	± 9.6 %
		Y	6.80	74.30	20.20		65.0	
		Z	6.88	74.92	20.60		65.0	
10254-CAB	LTE-TDD (SC-FDMA, 50% RB, 15 MHz, 64-QAM)	X	7.89	78.23	22.76	3.98	65.0	± 9.6 %
		Y	7.19	75.19	20.90		65.0	
		Z	7.35	75.73	21.15		65.0	

EX3DV4- SN:3687

July 28, 2016

10255-CAB	LTE-TDD (SC-FDMA, 50% RB, 15 MHz, QPSK)	X	9.48	83.86	24.30	3.98	65.0	± 9.6 %	
		Y	7.48	77.94	21.35			65.0	
		Z	7.76	78.68	21.67			65.0	
10256-CAA	LTE-TDD (SC-FDMA, 100% RB, 1.4 MHz, 16-QAM)	X	10.02	83.36	21.55	3.98	65.0	± 9.6 %	
		Y	6.43	74.73	17.62			65.0	
		Z	8.17	74.08	17.22			65.0	
10257-CAA	LTE-TDD (SC-FDMA, 100% RB, 1.4 MHz, 64-QAM)	X	9.31	81.77	20.87	3.98	65.0	± 9.6 %	
		Y	6.31	74.11	17.29			65.0	
		Z	6.06	73.46	16.90			65.0	
10258-CAA	LTE-TDD (SC-FDMA, 100% RB, 1.4 MHz, QPSK)	X	12.43	90.01	24.07	3.98	65.0	± 9.6 %	
		Y	5.97	76.87	18.70			65.0	
		Z	6.13	77.03	18.77			65.0	
10259-CAB	LTE-TDD (SC-FDMA, 100% RB, 3 MHz, 16-QAM)	X	6.25	81.38	22.89	3.98	65.0	± 9.6 %	
		Y	6.65	76.04	20.16			65.0	
		Z	6.82	76.54	20.33			65.0	
10260-CAB	LTE-TDD (SC-FDMA, 100% RB, 3 MHz, 64-QAM)	X	8.15	80.81	22.88	3.98	65.0	± 9.6 %	
		Y	6.69	75.83	20.08			65.0	
		Z	6.85	76.30	20.25			65.0	
10261-CAB	LTE-TDD (SC-FDMA, 100% RB, 3 MHz, QPSK)	X	13.63	92.80	26.85	3.98	65.0	± 9.6 %	
		Y	7.75	80.80	21.88			65.0	
		Z	8.20	81.82	22.26			65.0	
10262-CAB	LTE-TDD (SC-FDMA, 100% RB, 5 MHz, 16-QAM)	X	8.59	82.20	24.06	3.98	65.0	± 9.6 %	
		Y	7.17	77.29	21.47			65.0	
		Z	7.38	77.84	21.89			65.0	
10263-CAB	LTE-TDD (SC-FDMA, 100% RB, 5 MHz, 64-QAM)	X	7.81	79.10	22.83	3.98	65.0	± 9.6 %	
		Y	6.79	75.15	20.30			65.0	
		Z	6.99	75.80	20.59			65.0	
10264-CAB	LTE-TDD (SC-FDMA, 100% RB, 5 MHz, QPSK)	X	12.79	91.18	26.68	3.98	65.0	± 9.6 %	
		Y	8.08	80.96	22.28			65.0	
		Z	8.51	81.98	22.87			65.0	
10265-CAB	LTE-TDD (SC-FDMA, 100% RB, 10 MHz, 16-QAM)	X	7.61	78.30	22.44	3.98	65.0	± 9.6 %	
		Y	6.98	74.89	20.42			65.0	
		Z	7.17	75.53	20.73			65.0	
10266-CAB	LTE-TDD (SC-FDMA, 100% RB, 10 MHz, 64-QAM)	X	8.18	79.07	23.10	3.98	65.0	± 9.6 %	
		Y	7.38	75.80	21.16			65.0	
		Z	7.55	76.35	21.42			65.0	
10267-CAB	LTE-TDD (SC-FDMA, 100% RB, 10 MHz, QPSK)	X	10.16	84.78	24.37	3.98	65.0	± 9.6 %	
		Y	7.79	78.42	21.30			65.0	
		Z	8.07	79.13	21.60			65.0	
10268-CAB	LTE-TDD (SC-FDMA, 100% RB, 15 MHz, 16-QAM)	X	8.11	77.19	22.31	3.98	65.0	± 9.6 %	
		Y	7.58	74.73	20.72			65.0	
		Z	7.71	75.21	20.97			65.0	
10269-CAB	LTE-TDD (SC-FDMA, 100% RB, 15 MHz, 64-QAM)	X	7.98	76.57	22.12	3.98	65.0	± 9.6 %	
		Y	7.51	74.32	20.62			65.0	
		Z	7.65	74.79	20.87			65.0	
10270-CAB	LTE-TDD (SC-FDMA, 100% RB, 15 MHz, QPSK)	X	8.88	79.87	22.63	3.98	65.0	± 9.6 %	
		Y	7.57	76.10	20.54			65.0	
		Z	7.74	76.58	20.76			65.0	

EX3DV4-SN:3687

July 25, 2016

10274-CAB	UMTS-FDD (HSUPA, Subtest 5, 3GPP Rel8.10)	X	3.03	89.54	17.75	0.00	150.0	± 9.6 %
		Y	2.89	86.60	15.63		150.0	
		Z	2.68	86.65	15.61		150.0	
10275-CAB	UMTS-FDD (HSUPA, Subtest 5, 3GPP Rel8.4)	X	3.20	81.54	22.54	0.00	150.0	± 9.6 %
		Y	1.75	88.75	16.29		150.0	
		Z	1.75	88.93	15.33		150.0	
10277-CAA	PHS (QPSK)	X	3.28	64.60	10.21	9.03	50.0	± 9.6 %
		Y	3.51	64.85	10.46		50.0	
		Z	3.00	66.03	10.57		50.0	
10278-CAA	PHS (QPSK, BW 884MHz, Roll-off 0.5)	X	10.70	84.73	21.85	9.03	50.0	± 9.6 %
		Y	6.78	76.25	18.34		50.0	
		Z	6.91	76.38	18.37		50.0	
10279-CAA	PHS (QPSK, BW 884MHz, Roll-off 0.38)	X	11.02	84.98	21.78	9.03	50.0	± 9.6 %
		Y	6.93	76.48	18.46		50.0	
		Z	7.07	76.63	19.50		50.0	
10290-AAB	CDMA2000, RC1, SO55, Full Rate	X	88.48	134.34	35.76	0.00	150.0	± 9.6 %
		Y	1.85	71.33	16.06		150.0	
		Z	1.82	71.34	15.92		150.0	
10291-AAB	CDMA2000, RC3, SO55, Full Rate	X	100.00	145.97	39.15	0.00	150.0	± 9.6 %
		Y	1.03	68.06	14.54		150.0	
		Z	1.02	68.16	14.44		150.0	
10292-AAB	CDMA2000, RC3, SO32, Full Rate	X	100.00	152.38	41.89	0.00	150.0	± 9.6 %
		Y	1.43	73.89	17.61		150.0	
		Z	1.42	74.02	17.49		150.0	
10293-AAB	CDMA2000, RC3, SO3, Full Rate	X	100.00	158.15	43.74	0.00	150.0	± 9.6 %
		Y	2.47	82.67	21.83		150.0	
		Z	2.37	82.05	21.11		150.0	
10295-AAB	CDMA2000, RC1, SO3, 1/8th Rate 25 fr.	X	11.88	89.58	26.39	9.03	50.0	± 9.6 %
		Y	8.08	80.45	22.47		50.0	
		Z	8.69	81.73	22.97		50.0	
10297-AAA	LTE-FDD (SC-FDMA, 50% RB, 20 MHz, QPSK)	X	4.17	77.48	20.92	0.00	150.0	± 9.6 %
		Y	2.99	70.50	17.11		150.0	
		Z	2.97	70.52	17.10		150.0	
10298-AAB	LTE-FDD (SC-FDMA, 50% RB, 3 MHz, QPSK)	X	5.90	90.04	24.75	0.00	150.0	± 9.6 %
		Y	1.90	69.69	15.85		150.0	
		Z	1.87	69.59	15.68		150.0	
10299-AAB	LTE-FDD (SC-FDMA, 50% RB, 3 MHz, 16-QAM)	X	16.42	98.77	26.49	0.00	150.0	± 9.6 %
		Y	3.65	73.42	16.80		150.0	
		Z	3.15	71.54	15.85		150.0	
10300-AAB	LTE-FDD (SC-FDMA, 50% RB, 3 MHz, 64-QAM)	X	4.77	78.82	18.71	0.00	150.0	± 9.6 %
		Y	2.60	67.67	13.92		150.0	
		Z	2.37	66.75	12.94		150.0	
10301-AAA	IEEE 802.16e WIMAX (29-18, 5ms, 10MHz, QPSK, PUSC)	X	5.27	67.15	18.88	4.17	50.0	± 9.6 %
		Y	6.09	65.99	17.88		50.0	
		Z	6.08	66.02	17.88		50.0	
10302-AAA	IEEE 802.16e WIMAX (29-18, 5ms, 10MHz, QPSK, PUSC, 3 CTRL symbols)	X	5.68	67.44	19.40	4.96	50.0	± 9.6 %
		Y	5.54	66.38	18.47		50.0	
		Z	5.63	66.95	18.78		50.0	

EX3DV4- SN:3687

July 26, 2016

10303-AAA	IEEE 802.16e WiMAX (31.15, 5ms, 10MHz, 64QAM, PUSC)	X	5.48	87.26	19.35	4.96	50.0	± 9.6 %
		Y	5.33	86.17	18.40		50.0	
		Z	5.42	89.78	19.73		50.0	
10304-AAA	IEEE 802.16e WiMAX (29.18, 5ms, 10MHz, 64QAM, PUSC)	X	5.23	87.00	18.77	4.17	50.0	± 9.6 %
		Y	5.09	85.90	17.82		50.0	
		Z	5.15	86.39	18.08		50.0	
10305-AAA	IEEE 802.16e WiMAX (31.15, 10ms, 10MHz, 64QAM, PUSC, 15 symbols)	X	5.32	71.38	22.39	8.02	35.0	± 9.6 %
		Y	5.16	69.71	21.00		35.0	
		Z	5.48	71.47	21.93		35.0	
10306-AAA	IEEE 802.16e WiMAX (29.18, 10ms, 10MHz, 64QAM, PUSC, 18 symbols)	X	5.34	68.90	21.13	6.02	35.0	± 9.6 %
		Y	5.26	67.79	20.07		35.0	
		Z	5.42	68.86	20.89		35.0	
10307-AAA	IEEE 802.16e WiMAX (29.18, 10ms, 10MHz, QPSK, PUSC, 18 symbols)	X	5.33	69.51	21.32	6.02	35.0	± 9.6 %
		Y	5.23	68.29	20.20		35.0	
		Z	5.42	69.47	20.88		35.0	
10308-AAA	IEEE 802.16e WiMAX (29.18, 10ms, 10MHz, 16QAM, PUSC)	X	5.32	69.81	21.51	6.02	35.0	± 9.6 %
		Y	5.21	68.52	20.34		35.0	
		Z	5.42	69.79	21.05		35.0	
10309-AAA	IEEE 802.16e WiMAX (29.18, 10ms, 10MHz, 16QAM, AMC 2x3, 18 symbols)	X	5.45	69.29	21.34	6.02	35.0	± 9.6 %
		Y	5.34	68.07	20.23		35.0	
		Z	5.52	69.18	20.87		35.0	
10310-AAA	IEEE 802.16e WiMAX (29.18, 10ms, 10MHz, QPSK, AMC 2x3, 18 symbols)	X	5.32	69.10	21.17	6.02	35.0	± 9.6 %
		Y	5.23	67.95	20.09		35.0	
		Z	5.40	69.07	20.73		35.0	
10311-AAA	LTE-FDD (SC-FDMA, 100% RB, 15 MHz, QPSK)	X	4.57	75.97	20.10	0.00	150.0	± 9.6 %
		Y	3.98	69.81	16.75		150.0	
		Z	3.34	69.79	16.72		150.0	
10313-AAA	IDEN 1.3	X	13.93	90.23	22.53	6.99	70.0	± 9.6 %
		Y	4.97	74.36	16.70		70.0	
		Z	5.29	75.06	16.97		70.0	
10314-AAA	IDEN 1.6	X	33.22	109.59	31.05	10.00	30.0	± 9.6 %
		Y	6.66	81.02	21.88		30.0	
		Z	6.67	80.82	21.76		30.0	
10315-AAB	IEEE 802.11b WiFi 2.4 GHz (DSSS, 1 Mbps, 96pc duty cycle)	X	1.36	69.56	19.97	0.17	150.0	± 9.6 %
		Y	1.15	64.42	15.76		150.0	
		Z	1.15	64.51	15.78		150.0	
10318-AAB	IEEE 802.11g WiFi 2.4 GHz (ERP-OFDM, 6 Mbps, 96pc duty cycle)	X	4.84	67.53	17.24	0.17	150.0	± 9.6 %
		Y	4.73	66.89	16.41		150.0	
		Z	4.71	66.72	16.41		150.0	
10317-AAB	IEEE 802.11a WiFi 5 GHz (OFDM, 6 Mbps, 96pc duty cycle)	X	4.84	67.53	17.24	0.17	150.0	± 9.6 %
		Y	4.73	66.89	16.41		150.0	
		Z	4.71	66.72	16.41		150.0	
10400-AAC	IEEE 802.11ac WiFi (20MHz, 64-QAM, 99pc duty cycle)	X	5.00	67.95	17.26	0.00	150.0	± 9.6 %
		Y	4.87	67.08	16.42		150.0	
		Z	4.84	67.07	16.41		150.0	
10401-AAC	IEEE 802.11ac WiFi (40MHz, 64-QAM, 99pc duty cycle)	X	5.81	67.82	17.19	0.00	150.0	± 9.6 %
		Y	5.51	67.14	16.50		150.0	
		Z	5.48	67.15	16.50		150.0	

EX3DV4- SN:3687

July 26, 2016

10402-AAC	IEEE 802.11ac WiFi (60MHz, 64-QAM, 99pc duty cycle)	X	5.82	68.33	17.27	0.00	150.0	± 9.6 %
		Y	5.81	67.66	16.81		150.0	
		Z	5.77	67.64	16.58		150.0	
10403-AAB	CDMA2000 (1xEV-DO, Rev. 0)	X	89.46	134.34	35.76	0.00	115.0	± 9.6 %
		Y	1.85	71.33	16.06		115.0	
		Z	1.82	71.34	15.92		115.0	
10404-AAB	CDMA2000 (1xEV-DO, Rev. A)	X	89.46	134.34	35.76	0.00	115.0	± 9.6 %
		Y	1.85	71.33	16.06		115.0	
		Z	1.82	71.34	15.92		115.0	
10406-AAB	CDMA2000, RC3, SO32, SCH0, Full Rate	X	100.00	132.57	35.82	0.00	100.0	± 9.6 %
		Y	100.00	122.77	31.49		100.0	
		Z	28.95	105.84	27.43		100.0	
10410-AAA	LTE-TDD (SC-FDMA, 1 RB, 10 MHz, QPSK, UL_Subframe=2,3,4,7,8,9)	X	0.91	60.00	4.98	2.23	80.0	± 9.6 %
		Y	1.02	60.00	5.06		80.0	
		Z	0.99	60.00	4.99		80.0	
10415-AAA	IEEE 802.11b WiFi 2.4 GHz (DSSS, 1 Mbps, 99pc duty cycle)	X	1.21	67.86	19.11	0.00	150.0	± 9.6 %
		Y	1.05	63.34	15.14		150.0	
		Z	1.04	63.38	15.13		150.0	
10416-AAA	IEEE 802.11g WiFi 2.4 GHz (ERP-OFDM, 6 Mbps, 99pc duty cycle)	X	4.79	67.54	17.19	0.00	150.0	± 9.6 %
		Y	4.67	66.70	16.37		150.0	
		Z	4.64	66.70	16.35		150.0	
10417-AAA	IEEE 802.11a/n WiFi 5 GHz (OFDM, 6 Mbps, 99pc duty cycle)	X	4.79	67.54	17.19	0.00	150.0	± 9.6 %
		Y	4.67	66.70	16.37		150.0	
		Z	4.64	66.70	16.35		150.0	
10418-AAA	IEEE 802.11g WiFi 2.4 GHz (DSSS-OFDM, 6 Mbps, 99pc duty cycle, Long preamble)	X	4.78	67.74	17.23	0.00	150.0	± 9.6 %
		Y	4.66	66.84	16.38		150.0	
		Z	4.63	66.85	16.36		150.0	
10419-AAA	IEEE 802.11g WiFi 2.4 GHz (DSSS-OFDM, 6 Mbps, 99pc duty cycle, Short preamble)	X	4.80	67.67	17.22	0.00	150.0	± 9.6 %
		Y	4.68	66.80	16.39		150.0	
		Z	4.65	66.80	16.37		150.0	
10422-AAA	IEEE 802.11n (HT Greenfield, 7.2 Mbps, BPSK)	X	4.92	67.62	17.20	0.00	150.0	± 9.6 %
		Y	4.81	66.80	16.40		150.0	
		Z	4.78	66.80	16.38		150.0	
10423-AAA	IEEE 802.11n (HT Greenfield, 43.3 Mbps, 16-QAM)	X	5.12	68.00	17.32	0.00	150.0	± 9.6 %
		Y	5.01	67.17	16.53		150.0	
		Z	4.97	67.16	16.51		150.0	
10424-AAA	IEEE 802.11n (HT Greenfield, 72.2 Mbps, 64-QAM)	X	5.04	67.96	17.31	0.00	150.0	± 9.6 %
		Y	4.82	67.11	16.50		150.0	
		Z	4.88	67.10	16.48		150.0	
10425-AAA	IEEE 802.11n (HT Greenfield, 15 Mbps, BPSK)	X	5.60	68.14	17.35	0.00	150.0	± 9.6 %
		Y	5.49	67.41	16.64		150.0	
		Z	5.46	67.40	16.62		150.0	
10426-AAA	IEEE 802.11n (HT Greenfield, 90 Mbps, 16-QAM)	X	5.61	68.16	17.36	0.00	150.0	± 9.6 %
		Y	5.50	67.44	16.65		150.0	
		Z	5.46	67.42	16.62		150.0	

EX3DV4- SN:3687

July 26, 2016

10427-AAA	IEEE 802.11n (HT Greenfield, 150 Mbps, 64-QAM)	X	5.63	68.15	17.35	0.00	150.0	± 9.6 %
		Y	5.62	67.44	16.66		150.0	
		Z	5.48	67.42	16.62		150.0	
10430-AAA	LTE-FDD (OFDMA, 5 MHz, E-TM 3.1)	X	4.84	73.06	20.06	0.00	150.0	± 9.6 %
		Y	4.51	71.10	18.70		150.0	
		Z	4.36	70.61	18.36		150.0	
10431-AAA	LTE-FDD (OFDMA, 10 MHz, E-TM 3.1)	X	4.57	68.47	17.47	0.00	150.0	± 9.6 %
		Y	4.40	67.28	16.45		150.0	
		Z	4.37	67.26	16.42		150.0	
10432-AAA	LTE-FDD (OFDMA, 15 MHz, E-TM 3.1)	X	4.83	68.13	17.36	0.00	150.0	± 9.6 %
		Y	4.69	67.16	16.47		150.0	
		Z	4.66	67.15	16.45		150.0	
10433-AAA	LTE-FDD (OFDMA, 20 MHz, E-TM 3.1)	X	5.06	68.01	17.34	0.00	150.0	± 9.6 %
		Y	4.93	67.15	16.53		150.0	
		Z	4.90	67.15	16.50		150.0	
10434-AAA	W-CDMA (BS Test Model 1, 64 DPCH)	X	5.13	74.55	20.37	0.00	150.0	± 9.6 %
		Y	4.85	72.04	18.79		150.0	
		Z	4.50	71.47	18.39		150.0	
10435-AAA	LTE-TDD (SC-FDMA, 1 RB, 20 MHz, QPSK, UL Subframe=2,3,4,7,8,9)	X	0.91	60.00	4.97	2.23	80.0	± 9.6 %
		Y	1.03	60.00	5.07		80.0	
		Z	0.99	60.00	4.99		80.0	
10447-AAA	LTE-FDD (OFDMA, 5 MHz, E-TM 3.1, Clipping 44%)	X	4.00	69.32	17.43	0.00	150.0	± 9.6 %
		Y	3.72	67.40	15.99		150.0	
		Z	3.69	67.40	15.93		150.0	
10448-AAA	LTE-FDD (OFDMA, 10 MHz, E-TM 3.1, Clipping 44%)	X	4.39	68.29	17.37	0.00	150.0	± 9.6 %
		Y	4.23	67.06	16.31		150.0	
		Z	4.19	67.06	16.28		150.0	
10449-AAA	LTE-FDD (OFDMA, 15 MHz, E-TM 3.1, Clipping 44%)	X	4.63	68.02	17.31	0.00	150.0	± 9.6 %
		Y	4.49	66.99	16.36		150.0	
		Z	4.45	66.99	16.35		150.0	
10450-AAA	LTE-FDD (OFDMA, 20 MHz, E-TM 3.1, Clipping 44%)	X	4.79	67.83	17.24	0.00	150.0	± 9.6 %
		Y	4.67	66.91	16.39		150.0	
		Z	4.63	66.91	16.36		150.0	
10451-AAA	W-CDMA (BS Test Model 1, 64 DPCH, Clipping 44%)	X	4.02	70.05	17.38	0.00	150.0	± 9.6 %
		Y	3.85	67.71	15.75		150.0	
		Z	3.81	67.70	15.68		150.0	
10456-AAA	IEEE 802.11ac WiFi (160MHz, 64-QAM, 99pc duty cycle)	X	6.45	68.60	17.40	0.00	150.0	± 9.6 %
		Y	6.35	68.02	16.90		150.0	
		Z	6.31	67.99	16.77		150.0	
10457-AAA	UMTS-FDD (DC-HSDPA)	X	3.95	68.14	18.97	0.00	150.0	± 9.6 %
		Y	3.87	65.33	16.10		150.0	
		Z	3.85	65.33	16.07		150.0	
10458-AAA	CDMA2000 (1xEV-DO, Rev. B, 2 carriers)	X	3.79	69.17	16.81	0.00	150.0	± 9.6 %
		Y	3.46	66.93	15.21		150.0	
		Z	3.43	67.00	15.17		150.0	
10459-AAA	CDMA2000 (1xEV-DO, Rev. B, 3 carriers)	X	4.75	68.25	15.87	0.00	150.0	± 9.6 %
		Y	4.50	64.85	15.76		150.0	
		Z	4.60	65.44	16.04		150.0	

EX30V4- SN.3687

July 26, 2016

10460-AAA	UMTS-FDD (WCDMA, AMR)	X	12,04	123,08	38,00	0,00	150,0	± 9,6 %
		Y	1,00	69,62	17,28		150,0	
		Z	1,01	70,04	17,42		150,0	
10461-AAA	LTE-TDD (SC-FDMA, 1 RB, 1,4 MHz, QPSK, UL Subframe=2,3,4,7,8,9)	X	100,00	134,29	36,64	3,29	80,0	± 9,6 %
		Y	100,00	120,65	30,55		80,0	
		Z	78,81	117,26	29,88		80,0	
10462-AAA	LTE-TDD (SC-FDMA, 1 RB, 1,4 MHz, 16-QAM, UL Subframe=2,3,4,7,8,9)	X	100,00	114,10	27,09	3,23	80,0	± 9,6 %
		Y	4,94	74,34	15,06		80,0	
		Z	3,86	71,90	14,17		80,0	
10463-AAA	LTE-TDD (SC-FDMA, 1 RB, 1,4 MHz, 64-QAM, UL Subframe=2,3,4,7,8,9)	X	100,00	100,68	25,03	3,23	80,0	± 9,6 %
		Y	2,80	67,76	12,17		80,0	
		Z	2,44	66,57	11,64		80,0	
10464-AAA	LTE-TDD (SC-FDMA, 1 RB, 3 MHz, QPSK, UL Subframe=2,3,4,7,8,9)	X	100,00	132,30	35,53	3,23	80,0	± 9,6 %
		Y	100,00	118,37	29,34		80,0	
		Z	54,89	110,54	27,47		80,0	
10465-AAA	LTE-TDD (SC-FDMA, 1 RB, 3 MHz, 16-QAM, UL Subframe=2,3,4,7,8,9)	X	100,00	113,37	28,74	3,23	80,0	± 9,6 %
		Y	3,94	71,69	14,12		80,0	
		Z	3,26	70,11	13,42		80,0	
10466-AAA	LTE-TDD (SC-FDMA, 1 RB, 3 MHz, 64-QAM, UL Subframe=2,3,4,7,8,9)	X	100,00	108,90	24,71	3,23	80,0	± 9,6 %
		Y	2,51	66,57	11,64		80,0	
		Z	2,22	66,60	11,18		80,0	
10467-AAA	LTE-TDD (SC-FDMA, 1 RB, 5 MHz, QPSK, UL Subframe=2,3,4,7,8,9)	X	100,00	132,60	35,66	3,23	80,0	± 9,6 %
		Y	100,00	118,59	29,44		80,0	
		Z	67,06	113,27	28,14		80,0	
10468-AAA	LTE-TDD (SC-FDMA, 1 RB, 5 MHz, 16-QAM, UL Subframe=2,3,4,7,8,9)	X	100,00	113,60	26,84	3,23	80,0	± 9,6 %
		Y	4,13	72,43	14,33		80,0	
		Z	3,36	70,54	13,60		80,0	
10469-AAA	LTE-TDD (SC-FDMA, 1 RB, 5 MHz, 64-QAM, UL Subframe=2,3,4,7,8,9)	X	100,00	109,03	24,72	3,23	80,0	± 9,6 %
		Y	2,51	66,61	11,65		80,0	
		Z	2,23	65,63	11,19		80,0	
10470-AAA	LTE-TDD (SC-FDMA, 1 RB, 10 MHz, QPSK, UL Subframe=2,3,4,7,8,9)	X	100,00	132,67	35,69	3,23	80,0	± 9,6 %
		Y	100,00	118,60	29,44		80,0	
		Z	67,90	113,44	28,17		80,0	
10471-AAA	LTE-TDD (SC-FDMA, 1 RB, 10 MHz, 16-QAM, UL Subframe=2,3,4,7,8,9)	X	100,00	113,53	26,81	3,23	80,0	± 9,6 %
		Y	4,10	72,35	14,29		80,0	
		Z	3,36	70,47	13,56		80,0	
10472-AAA	LTE-TDD (SC-FDMA, 1 RB, 10 MHz, 64-QAM, UL Subframe=2,3,4,7,8,9)	X	100,00	108,96	24,68	3,23	80,0	± 9,6 %
		Y	2,50	66,56	11,62		80,0	
		Z	2,21	65,56	11,16		80,0	
10473-AAA	LTE-TDD (SC-FDMA, 1 RB, 15 MHz, QPSK, UL Subframe=2,3,4,7,8,9)	X	100,00	132,63	35,67	3,23	80,0	± 9,6 %
		Y	100,00	118,57	29,43		80,0	
		Z	67,58	113,35	28,15		80,0	
10474-AAA	LTE-TDD (SC-FDMA, 1 RB, 15 MHz, 16-QAM, UL Subframe=2,3,4,7,8,9)	X	100,00	113,55	26,81	3,23	80,0	± 9,6 %
		Y	4,08	72,29	14,27		80,0	
		Z	3,34	70,42	13,54		80,0	
10475-AAA	LTE-TDD (SC-FDMA, 1 RB, 15 MHz, 64-QAM, UL Subframe=2,3,4,7,8,9)	X	100,00	106,98	24,69	3,23	80,0	± 9,6 %
		Y	2,49	66,53	11,61		80,0	
		Z	2,21	65,55	11,15		80,0	

EX3DV4- SN:3687

July 26, 2016

10477-AAA	LTE-TDD (SC-FDMA, 1 RB, 20 MHz, 16-QAM, UL Subframe=2,3,4,7,8,9)	X	100.00	113.33	26.71	3.23	80.0	± 9.6 %
		Y	3.92	71.55	14.09		80.0	
		Z	3.24	70.08	13.39		80.0	
10478-AAA	LTE-TDD (SC-FDMA, 1 RB, 20 MHz, 64-QAM, UL Subframe=2,3,4,7,8,9)	X	100.00	108.89	24.65	3.23	80.0	± 9.6 %
		Y	2.47	66.46	11.57		80.0	
		Z	2.20	65.49	11.12		80.0	
10479-AAA	LTE-TDD (SC-FDMA, 50% RB, 1.4 MHz, QPSK, UL Subframe=2,3,4,7,8,9)	X	100.00	105.44	22.69	1.99	80.0	± 9.6 %
		Y	1.40	61.91	8.83		80.0	
		Z	1.22	60.81	8.11		80.0	
10480-AAA	LTE-TDD (SC-FDMA, 50% RB, 1.4 MHz, 16-QAM, UL Subframe=2,3,4,7,8,9)	X	1.37	60.41	7.55	1.99	80.0	± 9.6 %
		Y	1.48	60.00	7.12		80.0	
		Z	1.43	60.00	6.97		80.0	
10481-AAA	LTE-TDD (SC-FDMA, 50% RB, 1.4 MHz, 64-QAM, UL Subframe=2,3,4,7,8,9)	X	1.34	60.00	7.07	1.99	80.0	± 9.6 %
		Y	1.48	60.00	6.90		80.0	
		Z	1.46	60.00	6.75		80.0	
10482-AAA	LTE-TDD (SC-FDMA, 50% RB, 3 MHz, QPSK, UL Subframe=2,3,4,7,8,9)	X	100.00	122.72	31.96	1.99	80.0	± 9.6 %
		Y	3.77	73.54	17.00		80.0	
		Z	4.03	74.45	17.27		80.0	
10483-AAA	LTE-TDD (SC-FDMA, 50% RB, 3 MHz, 16-QAM, UL Subframe=2,3,4,7,8,9)	X	100.00	118.35	30.71	1.99	80.0	± 9.6 %
		Y	5.38	74.76	17.30		80.0	
		Z	4.74	73.06	16.49		80.0	
10484-AAA	LTE-TDD (SC-FDMA, 50% RB, 3 MHz, 64-QAM, UL Subframe=2,3,4,7,8,9)	X	100.00	118.12	30.67	1.99	80.0	± 9.6 %
		Y	6.09	73.85	16.98		80.0	
		Z	4.53	72.29	16.21		80.0	
10485-AAA	LTE-TDD (SC-FDMA, 50% RB, 5 MHz, QPSK, UL Subframe=2,3,4,7,8,9)	X	96.76	125.95	34.02	1.99	80.0	± 9.6 %
		Y	4.37	75.77	18.89		80.0	
		Z	4.74	76.99	19.10		80.0	
10486-AAA	LTE-TDD (SC-FDMA, 50% RB, 5 MHz, 16-QAM, UL Subframe=2,3,4,7,8,9)	X	8.66	85.13	22.64	1.99	80.0	± 9.6 %
		Y	3.69	70.33	16.36		80.0	
		Z	3.78	70.76	16.47		80.0	
10487-AAA	LTE-TDD (SC-FDMA, 50% RB, 5 MHz, 64-QAM, UL Subframe=2,3,4,7,8,9)	X	7.93	83.06	21.95	1.99	80.0	± 9.6 %
		Y	3.68	69.94	16.21		80.0	
		Z	3.76	70.32	16.31		80.0	
10488-AAA	LTE-TDD (SC-FDMA, 50% RB, 10 MHz, QPSK, UL Subframe=2,3,4,7,8,9)	X	15.73	97.02	27.43	1.99	80.0	± 9.6 %
		Y	4.57	74.91	19.01		80.0	
		Z	4.84	75.90	19.39		80.0	
10489-AAA	LTE-TDD (SC-FDMA, 50% RB, 10 MHz, 16-QAM, UL Subframe=2,3,4,7,8,9)	X	5.83	78.04	21.39	1.99	80.0	± 9.6 %
		Y	3.98	70.26	17.45		80.0	
		Z	4.06	70.70	17.52		80.0	
10490-AAA	LTE-TDD (SC-FDMA, 50% RB, 10 MHz, 64-QAM, UL Subframe=2,3,4,7,8,9)	X	5.86	78.89	20.99	1.99	80.0	± 9.6 %
		Y	4.05	69.99	17.38		80.0	
		Z	4.13	70.41	17.54		80.0	
10491-AAA	LTE-TDD (SC-FDMA, 50% RB, 15 MHz, QPSK, UL Subframe=2,3,4,7,8,9)	X	8.34	84.36	23.56	1.99	80.0	± 9.6 %
		Y	4.54	72.73	18.36		80.0	
		Z	4.70	73.40	18.64		80.0	
10492-AAA	LTE-TDD (SC-FDMA, 50% RB, 15 MHz, 16-QAM, UL Subframe=2,3,4,7,8,9)	X	5.30	74.26	20.17	1.99	80.0	± 9.6 %
		Y	4.27	69.36	17.39		80.0	
		Z	4.33	69.72	17.54		80.0	

EX3DV4- SN:3687

July 26, 2016

10493-AAA	LTE-TDD (SC-FDMA, 50% RB, 15 MHz, 64-QAM, UL Subframe=2,3,4,7,8,9)	X	5.27	73.69	19.96	1.99	80.0	± 9.6 %	
			Y	4.33	89.18	17.35		80.0	
			Z	4.39	89.52	17.49		80.0	
10494-AAA	LTE-TDD (SC-FDMA, 50% RB, 20 MHz, QPSK, UL Subframe=2,3,4,7,8,9)	X	12.18	90.40	25.27	1.99	80.0	± 9.6 %	
			Y	5.08	74.54	18.84		80.0	
			Z	5.30	75.29	19.14		80.0	
10495-AAA	LTE-TDD (SC-FDMA, 50% RB, 20 MHz, 16-QAM, UL Subframe=2,3,4,7,8,9)	X	5.58	75.32	20.59	1.99	80.0	± 9.6 %	
			Y	4.34	89.91	17.61		80.0	
			Z	4.41	70.27	17.76		80.0	
10496-AAA	LTE-TDD (SC-FDMA, 50% RB, 20 MHz, 64-QAM, UL Subframe=2,3,4,7,8,9)	X	5.42	74.27	20.21	1.99	80.0	± 9.6 %	
			Y	4.40	89.54	17.51		80.0	
			Z	4.46	89.87	17.68		80.0	
10497-AAA	LTE-TDD (SC-FDMA, 100% RB, 1.4 MHz, QPSK, UL Subframe=2,3,4,7,8,9)	X	100.00	118.34	29.52	1.99	80.0	± 9.6 %	
			Y	2.54	66.43	14.11		80.0	
			Z	2.59	88.69	14.11		80.0	
10498-AAA	LTE-TDD (SC-FDMA, 100% RB, 1.4 MHz, 16-QAM, UL Subframe=2,3,4,7,8,9)	X	5.21	75.61	16.54	1.99	80.0	± 9.6 %	
			Y	2.00	63.12	10.90		80.0	
			Z	1.96	82.95	10.70		80.0	
10499-AAA	LTE-TDD (SC-FDMA, 100% RB, 1.4 MHz, 64-QAM, UL Subframe=2,3,4,7,8,9)	X	4.34	72.90	15.43	1.99	80.0	± 9.6 %	
			Y	1.97	62.66	10.56		80.0	
			Z	1.92	82.47	10.35		80.0	
10500-AAA	LTE-TDD (SC-FDMA, 100% RB, 3 MHz, QPSK, UL Subframe=2,3,4,7,8,9)	X	27.10	106.10	29.59	1.99	80.0	± 9.6 %	
			Y	4.31	74.91	18.67		80.0	
			Z	4.62	76.03	19.07		80.0	
10501-AAA	LTE-TDD (SC-FDMA, 100% RB, 3 MHz, 16-QAM, UL Subframe=2,3,4,7,8,9)	X	7.03	81.39	21.87	1.99	80.0	± 9.6 %	
			Y	3.82	70.30	16.79		80.0	
			Z	3.92	70.75	16.93		80.0	
10502-AAA	LTE-TDD (SC-FDMA, 100% RB, 3 MHz, 64-QAM, UL Subframe=2,3,4,7,8,9)	X	6.80	80.38	21.45	1.99	80.0	± 9.6 %	
			Y	3.86	70.08	16.67		80.0	
			Z	3.95	70.49	16.79		80.0	
10503-AAA	LTE-TDD (SC-FDMA, 100% RB, 5 MHz, QPSK, UL Subframe=2,3,4,7,8,9)	X	15.09	96.33	27.21	1.99	80.0	± 9.6 %	
			Y	4.49	74.84	18.89		80.0	
			Z	4.76	75.64	19.28		80.0	
10504-AAA	LTE-TDD (SC-FDMA, 100% RB, 5 MHz, 16-QAM, UL Subframe=2,3,4,7,8,9)	X	5.78	77.88	21.31	1.99	80.0	± 9.6 %	
			Y	3.95	70.15	17.39		80.0	
			Z	4.04	70.60	17.56		80.0	
10505-AAA	LTE-TDD (SC-FDMA, 100% RB, 5 MHz, 64-QAM, UL Subframe=2,3,4,7,8,9)	X	6.61	76.74	20.90	1.99	80.0	± 9.6 %	
			Y	4.03	66.86	17.32		80.0	
			Z	4.11	70.30	17.48		80.0	
10506-AAA	LTE-TDD (SC-FDMA, 100% RB, 10 MHz, QPSK, UL Subframe=2,3,4,7,8,9)	X	11.89	89.96	25.12	1.99	80.0	± 9.6 %	
			Y	5.02	74.35	18.75		80.0	
			Z	5.24	75.11	19.06		80.0	
10507-AAA	LTE-TDD (SC-FDMA, 100% RB, 10 MHz, 16-QAM, UL Subframe=2,3,4,7,8,9)	X	5.52	75.23	20.55	1.99	80.0	± 9.6 %	
			Y	4.32	89.83	17.56		80.0	
			Z	4.39	70.20	17.72		80.0	

EX3DV4- SN:3687

July 28, 2016

10508-AAA	LTE-TDD (SC-FDMA, 100% RB, 10 MHz, 64-QAM, UL Subframe=2,3,4,7,8,9)	X	5.39	74.16	20.16	1.99	80.0	± 9.6 %	
			Y	4.38	69.46	17.46		80.0	
			Z	4.44	69.80	17.61		80.0	
10509-AAA	LTE-TDD (SC-FDMA, 100% RB, 15 MHz, QPSK, UL Subframe=2,3,4,7,8,9)	X	8.16	81.43	22.27	1.99	60.0	± 9.6 %	
			Y	5.11	72.49	18.12		90.0	
			Z	5.25	72.98	18.32		90.0	
10510-AAA	LTE-TDD (SC-FDMA, 100% RB, 15 MHz, 16-QAM, UL Subframe=2,3,4,7,8,9)	X	5.63	73.25	19.79	1.99	80.0	± 9.6 %	
			Y	4.78	69.42	17.51		80.0	
			Z	4.64	69.71	17.64		80.0	
10511-AAA	LTE-TDD (SC-FDMA, 100% RB, 15 MHz, 64-QAM, UL Subframe=2,3,4,7,8,9)	X	5.54	72.52	19.54	1.99	80.0	± 9.6 %	
			Y	4.81	69.10	17.44		80.0	
			Z	4.86	69.37	17.56		80.0	
10512-AAA	LTE-TDD (SC-FDMA, 100% RB, 20 MHz, QPSK, UL Subframe=2,3,4,7,8,9)	X	11.61	87.72	24.17	1.99	80.0	± 9.6 %	
			Y	5.53	74.38	18.64		80.0	
			Z	5.73	75.01	18.89		80.0	
10513-AAA	LTE-TDD (SC-FDMA, 100% RB, 20 MHz, 16-QAM, UL Subframe=2,3,4,7,8,9)	X	5.73	74.32	20.21	1.99	80.0	± 9.6 %	
			Y	4.70	69.85	17.65		80.0	
			Z	4.77	70.17	17.79		80.0	
10514-AAA	LTE-TDD (SC-FDMA, 100% RB, 20 MHz, 64-QAM, UL Subframe=2,3,4,7,8,9)	X	5.51	73.18	19.82	1.99	80.0	± 9.6 %	
			Y	4.68	69.33	17.52		80.0	
			Z	4.73	69.62	17.65		80.0	
10515-AAA	IEEE 802.11b WiFi 2.4 GHz (DSSS, 2 Mbps, 99pc duty cycle)	X	1.19	68.70	19.59	0.00	150.0	± 9.6 %	
			Y	1.01	63.56	15.23		150.0	
			Z	1.00	63.61	15.22		150.0	
10516-AAA	IEEE 802.11b WiFi 2.4 GHz (DSSS, 5.5 Mbps, 99pc duty cycle)	X	100.00	198.16	59.25	0.00	150.0	± 9.6 %	
			Y	0.70	72.66	19.05		150.0	
			Z	0.75	74.40	19.64		150.0	
10517-AAA	IEEE 802.11b WiFi 2.4 GHz (DSSS, 11 Mbps, 99pc duty cycle)	X	1.53	80.19	24.97	0.00	150.0	± 9.6 %	
			Y	0.88	65.89	16.12		150.0	
			Z	0.87	66.05	16.17		150.0	
10518-AAA	IEEE 802.11a/n WiFi 5 GHz (OFDM, 9 Mbps, 99pc duty cycle)	X	4.79	67.65	17.19	0.00	150.0	± 9.6 %	
			Y	4.67	66.78	16.36		150.0	
			Z	4.64	66.78	16.33		150.0	
10519-AAA	IEEE 802.11a/n WiFi 5 GHz (OFDM, 12 Mbps, 99pc duty cycle)	X	5.00	67.90	17.30	0.00	150.0	± 9.6 %	
			Y	4.88	67.05	16.49		150.0	
			Z	4.85	67.04	16.46		150.0	
10520-AAA	IEEE 802.11a/n WiFi 5 GHz (OFDM, 18 Mbps, 99pc duty cycle)	X	4.86	67.95	17.28	0.00	150.0	± 9.6 %	
			Y	4.73	67.04	16.42		150.0	
			Z	4.70	67.03	16.39		150.0	
10521-AAA	IEEE 802.11a/n WiFi 5 GHz (OFDM, 24 Mbps, 99pc duty cycle)	X	4.80	68.00	17.29	0.00	150.0	± 9.6 %	
			Y	4.67	67.04	16.41		150.0	
			Z	4.63	67.03	16.38		150.0	
10522-AAA	IEEE 802.11a/n WiFi 5 GHz (OFDM, 36 Mbps, 99pc duty cycle)	X	4.84	67.97	17.32	0.00	150.0	± 9.6 %	
			Y	4.71	67.04	16.45		150.0	
			Z	4.68	67.05	16.43		150.0	

Certificate No: EX3-3687_Jul16

Page 30 of 38

EX3DV4- SN:3687

July 26, 2016

10523-AAA	IEEE 802.11a/h WiFi 5 GHz (OFDM, 48 Mbps, 99pc duty cycle)	X	4.72	67.91	17.21	0.00	150.0	± 9.6 %
		Y	4.59	66.94	16.31		150.0	
		Z	4.56	66.94	16.29		150.0	
10524-AAA	IEEE 802.11a/h WiFi 5 GHz (OFDM, 54 Mbps, 99pc duty cycle)	X	4.79	67.93	17.31	0.00	150.0	± 9.6 %
		Y	4.66	66.99	16.44		150.0	
		Z	4.63	66.99	16.41		150.0	
10525-AAA	IEEE 802.11ac WiFi (20MHz, MCS0, 99pc duty cycle)	X	4.77	66.97	16.89	0.00	150.0	± 9.6 %
		Y	4.63	66.03	16.03		150.0	
		Z	4.60	66.03	16.00		150.0	
10526-AAA	IEEE 802.11ac WiFi (20MHz, MCS1, 99pc duty cycle)	X	4.97	67.39	17.04	0.00	150.0	± 9.6 %
		Y	4.82	66.43	16.17		150.0	
		Z	4.79	66.43	16.15		150.0	
10527-AAA	IEEE 802.11ac WiFi (20MHz, MCS2, 99pc duty cycle)	X	4.89	67.40	17.02	0.00	150.0	± 9.6 %
		Y	4.74	66.41	16.13		150.0	
		Z	4.71	66.40	16.10		150.0	
10528-AAA	IEEE 802.11ac WiFi (20MHz, MCS3, 99pc duty cycle)	X	4.91	67.41	17.04	0.00	150.0	± 9.6 %
		Y	4.76	66.42	16.16		150.0	
		Z	4.72	66.42	16.13		150.0	
10529-AAA	IEEE 802.11ac WiFi (20MHz, MCS4, 99pc duty cycle)	X	4.91	67.41	17.04	0.00	150.0	± 9.6 %
		Y	4.76	66.42	16.16		150.0	
		Z	4.72	66.42	16.13		150.0	
10531-AAA	IEEE 802.11ac WiFi (20MHz, MCS6, 99pc duty cycle)	X	4.93	67.60	17.09	0.00	150.0	± 9.6 %
		Y	4.77	66.57	16.19		150.0	
		Z	4.73	66.55	16.16		150.0	
10532-AAA	IEEE 802.11ac WiFi (20MHz, MCS7, 99pc duty cycle)	X	4.78	67.50	17.07	0.00	150.0	± 9.6 %
		Y	4.62	66.43	16.13		150.0	
		Z	4.58	66.41	16.10		150.0	
10533-AAA	IEEE 802.11ac WiFi (20MHz, MCS9, 99pc duty cycle)	X	4.93	67.45	17.03	0.00	150.0	± 9.6 %
		Y	4.77	66.45	16.14		150.0	
		Z	4.74	66.45	16.12		150.0	
10534-AAA	IEEE 802.11ac WiFi (40MHz, MCS0, 99pc duty cycle)	X	5.41	67.35	16.95	0.00	150.0	± 9.6 %
		Y	5.28	66.55	16.20		150.0	
		Z	5.24	66.53	16.17		150.0	
10535-AAA	IEEE 802.11ac WiFi (40MHz, MCS1, 99pc duty cycle)	X	5.48	67.50	17.01	0.00	150.0	± 9.6 %
		Y	5.34	66.69	16.26		150.0	
		Z	5.31	66.68	16.23		150.0	
10536-AAA	IEEE 802.11ac WiFi (40MHz, MCS2, 99pc duty cycle)	X	5.36	67.54	17.02	0.00	150.0	± 9.6 %
		Y	5.21	66.68	16.24		150.0	
		Z	5.18	66.66	16.21		150.0	
10537-AAA	IEEE 802.11ac WiFi (40MHz, MCS3, 99pc duty cycle)	X	5.41	67.48	16.99	0.00	150.0	± 9.6 %
		Y	5.28	66.65	16.22		150.0	
		Z	5.24	66.63	16.19		150.0	
10538-AAA	IEEE 802.11ac WiFi (40MHz, MCS4, 99pc duty cycle)	X	5.52	67.50	17.03	0.00	150.0	± 9.6 %
		Y	5.38	66.71	16.29		150.0	
		Z	5.34	66.68	16.26		150.0	
10540-AAA	IEEE 802.11ac WiFi (40MHz, MCS6, 99pc duty cycle)	X	5.43	67.49	17.05	0.00	150.0	± 9.6 %
		Y	5.29	66.67	16.28		150.0	
		Z	5.25	66.65	16.25		150.0	

EX3DV4- SN:3687

July 26, 2016

10541-AAA	IEEE 802.11ac WiFi (40MHz, MCS7, 99pc duty cycle)	X	5.40	67.36	16.68	0.00	150.0	± 9.6 %
		Y	5.27	66.57	16.23		150.0	
		Z	5.23	66.54	16.20		150.0	
10542-AAA	IEEE 802.11ac WiFi (40MHz, MCS8, 99pc duty cycle)	X	5.50	67.37	16.99	0.00	150.0	± 9.6 %
		Y	5.42	66.62	16.27		150.0	
		Z	5.39	66.60	16.24		150.0	
10543-AAA	IEEE 802.11ac WiFi (40MHz, MCS9, 99pc duty cycle)	X	5.62	67.36	16.99	0.00	150.0	± 9.6 %
		Y	5.50	66.63	16.29		150.0	
		Z	5.47	66.61	16.26		150.0	
10544-AAA	IEEE 802.11ac WiFi (80MHz, MCS0, 99pc duty cycle)	X	5.68	67.38	16.88	0.00	150.0	± 9.6 %
		Y	5.66	66.66	16.18		150.0	
		Z	5.63	66.64	16.15		150.0	
10545-AAA	IEEE 802.11ac WiFi (80MHz, MCS1, 99pc duty cycle)	X	5.81	67.83	17.03	0.00	150.0	± 9.6 %
		Y	5.77	67.06	16.32		150.0	
		Z	5.73	67.04	16.30		150.0	
10546-AAA	IEEE 802.11ac WiFi (80MHz, MCS2, 99pc duty cycle)	X	5.79	67.69	16.99	0.00	150.0	± 9.6 %
		Y	5.65	66.93	16.26		150.0	
		Z	5.62	66.90	16.25		150.0	
10547-AAA	IEEE 802.11ac WiFi (80MHz, MCS3, 99pc duty cycle)	X	5.88	67.75	17.01	0.00	150.0	± 9.6 %
		Y	5.74	67.01	16.31		150.0	
		Z	5.70	66.98	16.27		150.0	
10548-AAA	IEEE 802.11ac WiFi (80MHz, MCS4, 99pc duty cycle)	X	6.23	68.98	17.59	0.00	150.0	± 9.6 %
		Y	6.03	68.00	16.77		150.0	
		Z	5.97	67.94	16.73		150.0	
10550-AAA	IEEE 802.11ac WiFi (80MHz, MCS6, 99pc duty cycle)	X	5.80	67.63	16.97	0.00	150.0	± 9.6 %
		Y	5.67	66.89	16.27		150.0	
		Z	5.64	66.87	16.24		150.0	
10551-AAA	IEEE 802.11ac WiFi (80MHz, MCS7, 99pc duty cycle)	X	5.82	67.72	16.97	0.00	150.0	± 9.6 %
		Y	5.66	66.97	16.27		150.0	
		Z	5.65	66.93	16.23		150.0	
10552-AAA	IEEE 802.11ac WiFi (80MHz, MCS8, 99pc duty cycle)	X	5.71	67.47	16.87	0.00	150.0	± 9.6 %
		Y	5.59	66.74	16.17		150.0	
		Z	5.55	66.72	16.14		150.0	
10553-AAA	IEEE 802.11ac WiFi (80MHz, MCS9, 99pc duty cycle)	X	5.80	67.50	16.90	0.00	150.0	± 9.6 %
		Y	5.68	66.79	16.22		150.0	
		Z	5.65	66.77	16.19		150.0	
10554-AAA	IEEE 1602.11ac WiFi (160MHz, MCS0, 99pc duty cycle)	X	6.09	67.71	16.93	0.00	150.0	± 9.6 %
		Y	5.96	67.03	16.27		150.0	
		Z	5.93	67.01	16.24		150.0	
10555-AAA	IEEE 1602.11ac WiFi (160MHz, MCS1, 99pc duty cycle)	X	6.24	68.06	17.07	0.00	150.0	± 9.6 %
		Y	6.11	67.35	16.40		150.0	
		Z	6.07	67.32	16.37		150.0	
10556-AAA	IEEE 1602.11ac WiFi (160MHz, MCS2, 99pc duty cycle)	X	6.26	68.09	17.08	0.00	150.0	± 9.6 %
		Y	6.12	67.37	16.41		150.0	
		Z	6.09	67.35	16.38		150.0	
10557-AAA	IEEE 1602.11ac WiFi (160MHz, MCS3, 99pc duty cycle)	X	6.24	68.02	17.07	0.00	150.0	± 9.6 %
		Y	6.10	67.32	16.41		150.0	
		Z	6.07	67.29	16.37		150.0	

EX3DV4- SN-3667

July 26, 2016

10556-AAA	IEEE 802.11ac WiFi (160MHz, MCS4, 99pc duty cycle)	X	6.30	68.23	17.18	0.00	150.0	± 9.6 %
		Y	6.16	67.50	16.51		150.0	
		Z	6.12	67.47	16.48		150.0	
10560-AAA	IEEE 802.11ac WiFi (160MHz, MCS6, 99pc duty cycle)	X	6.28	68.02	17.11	0.00	150.0	± 9.6 %
		Y	6.15	67.34	16.47		150.0	
		Z	6.12	67.32	16.44		150.0	
10561-AAA	IEEE 802.11ac WiFi (160MHz, MCS7, 99pc duty cycle)	X	6.20	67.99	17.14	0.00	150.0	± 9.6 %
		Y	6.07	67.29	16.48		150.0	
		Z	6.03	67.27	16.45		150.0	
10562-AAA	IEEE 802.11ac WiFi (160MHz, MCS8, 99pc duty cycle)	X	6.37	68.52	17.41	0.00	150.0	± 9.6 %
		Y	6.22	67.75	16.71		150.0	
		Z	6.17	67.71	16.67		150.0	
10563-AAA	IEEE 802.11ac WiFi (160MHz, MCS9, 99pc duty cycle)	X	6.74	69.13	17.64	0.00	150.0	± 9.6 %
		Y	6.55	68.30	16.92		150.0	
		Z	6.51	68.27	16.90		150.0	
10564-AAA	IEEE 802.11g WiFi 2.4 GHz (DSSS-OFDM, 9 Mbps, 99pc duty cycle)	X	5.10	67.60	17.25	0.46	150.0	± 9.6 %
		Y	5.00	66.83	16.46		150.0	
		Z	4.97	66.85	16.48		150.0	
10569-AAA	IEEE 802.11g WiFi 2.4 GHz (DSSS-OFDM, 12 Mbps, 99pc duty cycle)	X	5.36	68.08	17.56	0.46	150.0	± 9.6 %
		Y	5.25	67.33	16.83		150.0	
		Z	5.22	67.33	16.81		150.0	
10566-AAA	IEEE 802.11g WiFi 2.4 GHz (DSSS-OFDM, 18 Mbps, 99pc duty cycle)	X	5.19	67.99	17.42	0.46	150.0	± 9.6 %
		Y	5.08	67.18	16.64		150.0	
		Z	5.05	67.19	16.63		150.0	
10567-AAA	IEEE 802.11g WiFi 2.4 GHz (DSSS-OFDM, 24 Mbps, 99pc duty cycle)	X	5.23	68.44	17.60	0.46	150.0	± 9.6 %
		Y	5.12	67.62	17.02		150.0	
		Z	5.08	67.58	16.97		150.0	
10568-AAA	IEEE 802.11g WiFi 2.4 GHz (DSSS-OFDM, 36 Mbps, 99pc duty cycle)	X	5.10	67.71	17.17	0.46	150.0	± 9.6 %
		Y	4.98	66.88	16.36		150.0	
		Z	4.96	66.93	16.38		150.0	
10569-AAA	IEEE 802.11g WiFi 2.4 GHz (DSSS-OFDM, 48 Mbps, 99pc duty cycle)	X	5.18	68.49	17.84	0.46	150.0	± 9.6 %
		Y	5.06	67.66	17.06		150.0	
		Z	5.02	67.62	17.00		150.0	
10570-AAA	IEEE 802.11g WiFi 2.4 GHz (DSSS-OFDM, 54 Mbps, 99pc duty cycle)	X	5.21	68.28	17.75	0.46	150.0	± 9.6 %
		Y	5.10	67.48	16.98		150.0	
		Z	5.06	67.46	16.94		150.0	
10571-AAA	IEEE 802.11b WiFi 2.4 GHz (DSSS, 1 Mbps, 90pc duty cycle)	X	1.53	70.87	20.46	0.46	130.0	± 9.6 %
		Y	1.27	65.23	16.09		130.0	
		Z	1.27	65.46	16.10		130.0	
10572-AAA	IEEE 802.11b WiFi 2.4 GHz (DSSS, 2 Mbps, 90pc duty cycle)	X	1.61	72.30	21.21	0.46	130.0	± 9.6 %
		Y	1.29	65.89	16.48		130.0	
		Z	1.30	66.10	16.57		130.0	
10573-AAA	IEEE 802.11b WiFi 2.4 GHz (DSSS, 5.5 Mbps, 90pc duty cycle)	X	100.00	173.39	50.36	0.46	130.0	± 9.6 %
		Y	3.33	91.84	25.28		130.0	
		Z	4.95	98.23	27.15		130.0	
10574-AAA	IEEE 802.11b WiFi 2.4 GHz (DSSS, 11 Mbps, 90pc duty cycle)	X	4.46	98.73	31.86	0.46	130.0	± 9.6 %
		Y	1.53	72.83	19.67		130.0	
		Z	1.54	73.04	19.91		130.0	

Certificate No: EX3-3687_Jul16

Page 33 of 38

EX3DV4- SN:3687

July 26, 2016

10575-AAA	IEEE 802.11g WiFi 2.4 GHz (DSSS-OFDM, 6 Mbps, 90pc duty cycle)	X	4.88	67.39	17.30	0.46	130.0	± 9.6 %
		Y	4.78	66.59	16.50		130.0	
		Z	4.75	66.63	16.51		130.0	
10576-AAA	IEEE 802.11g WiFi 2.4 GHz (DSSS-OFDM, 9 Mbps, 90pc duty cycle)	X	4.91	67.57	17.38	0.46	130.0	± 9.6 %
		Y	4.81	66.77	16.57		130.0	
		Z	4.78	66.79	16.57		130.0	
10577-AAA	IEEE 802.11g WiFi 2.4 GHz (DSSS-OFDM, 12 Mbps, 90pc duty cycle)	X	5.14	67.89	17.54	0.46	130.0	± 9.6 %
		Y	5.04	67.10	16.76		130.0	
		Z	5.00	67.11	16.75		130.0	
10578-AAA	IEEE 802.11g WiFi 2.4 GHz (DSSS-OFDM, 18 Mbps, 90pc duty cycle)	X	5.05	68.12	17.68	0.46	130.0	± 9.6 %
		Y	4.93	67.29	16.87		130.0	
		Z	4.90	67.28	16.85		130.0	
10579-AAA	IEEE 802.11g WiFi 2.4 GHz (DSSS-OFDM, 24 Mbps, 90pc duty cycle)	X	4.81	67.44	17.03	0.46	130.0	± 9.6 %
		Y	4.69	66.55	16.16		130.0	
		Z	4.67	66.61	16.19		130.0	
10580-AAA	IEEE 802.11g WiFi 2.4 GHz (DSSS-OFDM, 36 Mbps, 90pc duty cycle)	X	4.85	67.42	17.02	0.46	130.0	± 9.6 %
		Y	4.74	66.53	16.16		130.0	
		Z	4.71	66.61	16.20		130.0	
10581-AAA	IEEE 802.11g WiFi 2.4 GHz (DSSS-OFDM, 48 Mbps, 90pc duty cycle)	X	4.95	68.24	17.67	0.46	130.0	± 9.6 %
		Y	4.83	67.33	16.81		130.0	
		Z	4.80	67.32	16.78		130.0	
10582-AAA	IEEE 802.11g WiFi 2.4 GHz (DSSS-OFDM, 54 Mbps, 90pc duty cycle)	X	4.75	67.17	16.81	0.46	130.0	± 9.6 %
		Y	4.64	66.28	15.94		130.0	
		Z	4.62	66.38	15.99		130.0	
10583-AAA	IEEE 802.11a/n WiFi 5 GHz (OFDM, 6 Mbps, 90pc duty cycle)	X	4.88	67.39	17.30	0.46	130.0	± 9.6 %
		Y	4.78	66.59	16.50		130.0	
		Z	4.75	66.63	16.51		130.0	
10584-AAA	IEEE 802.11a/n WiFi 5 GHz (OFDM, 9 Mbps, 90pc duty cycle)	X	4.91	67.57	17.38	0.46	130.0	± 9.6 %
		Y	4.81	66.77	16.57		130.0	
		Z	4.78	66.79	16.57		130.0	
10585-AAA	IEEE 802.11a/n WiFi 5 GHz (OFDM, 12 Mbps, 90pc duty cycle)	X	5.14	67.89	17.54	0.46	130.0	± 9.6 %
		Y	5.04	67.10	16.76		130.0	
		Z	5.00	67.11	16.75		130.0	
10586-AAA	IEEE 802.11a/n WiFi 5 GHz (OFDM, 18 Mbps, 90pc duty cycle)	X	5.05	68.12	17.68	0.46	130.0	± 9.6 %
		Y	4.93	67.29	16.87		130.0	
		Z	4.90	67.28	16.85		130.0	
10587-AAA	IEEE 802.11a/n WiFi 5 GHz (OFDM, 24 Mbps, 90pc duty cycle)	X	4.81	67.44	17.03	0.46	130.0	± 9.6 %
		Y	4.69	66.55	16.16		130.0	
		Z	4.67	66.61	16.19		130.0	
10588-AAA	IEEE 802.11a/n WiFi 5 GHz (OFDM, 36 Mbps, 90pc duty cycle)	X	4.85	67.42	17.02	0.46	130.0	± 9.6 %
		Y	4.74	66.53	16.16		130.0	
		Z	4.71	66.61	16.20		130.0	
10589-AAA	IEEE 802.11a/n WiFi 5 GHz (OFDM, 48 Mbps, 90pc duty cycle)	X	4.95	68.24	17.67	0.46	130.0	± 9.6 %
		Y	4.83	67.33	16.81		130.0	
		Z	4.80	67.32	16.78		130.0	
10590-AAA	IEEE 802.11a/n WiFi 5 GHz (OFDM, 54 Mbps, 90pc duty cycle)	X	4.75	67.17	16.81	0.46	130.0	± 9.6 %
		Y	4.64	66.28	15.94		130.0	
		Z	4.62	66.38	15.99		130.0	

EX3DV4- SN:3667

July 26, 2016

10591-AAA	IEEE 802.11n (HT Mixed, 20MHz, MCS0, 90pc duty cycle)	X	5.02	67.39	17.36	0.46	130.0	± 9.6 %
		Y	4.93	68.67	16.60		130.0	
		Z	4.90	68.69	16.60		130.0	
10592-AAA	IEEE 802.11n (HT Mixed, 20MHz, MCS1, 90pc duty cycle)	X	5.20	67.76	17.49	0.46	130.0	± 9.6 %
		Y	5.10	67.01	16.73		130.0	
		Z	5.07	67.03	16.73		130.0	
10593-AAA	IEEE 802.11n (HT Mixed, 20MHz, MCS2, 90pc duty cycle)	X	5.13	67.72	17.40	0.46	130.0	± 9.6 %
		Y	5.03	66.94	16.62		130.0	
		Z	5.00	66.97	16.62		130.0	
10594-AAA	IEEE 802.11n (HT Mixed, 20MHz, MCS3, 90pc duty cycle)	X	5.18	67.67	17.54	0.46	130.0	± 9.6 %
		Y	5.08	67.11	16.79		130.0	
		Z	5.05	67.12	16.77		130.0	
10595-AAA	IEEE 802.11n (HT Mixed, 20MHz, MCS4, 90pc duty cycle)	X	5.18	67.85	17.45	0.46	130.0	± 9.6 %
		Y	5.05	67.06	16.67		130.0	
		Z	5.02	67.08	16.67		130.0	
10596-AAA	IEEE 802.11n (HT Mixed, 20MHz, MCS5, 90pc duty cycle)	X	5.10	67.87	17.47	0.46	130.0	± 9.6 %
		Y	4.99	67.05	16.67		130.0	
		Z	4.96	67.08	16.67		130.0	
10597-AAA	IEEE 802.11n (HT Mixed, 20MHz, MCS6, 90pc duty cycle)	X	5.09	67.81	17.38	0.46	130.0	± 9.6 %
		Y	4.94	66.98	16.57		130.0	
		Z	4.91	67.01	16.57		130.0	
10598-AAA	IEEE 802.11n (HT Mixed, 20MHz, MCS7, 90pc duty cycle)	X	5.04	68.10	17.67	0.46	130.0	± 9.6 %
		Y	4.92	67.26	16.86		130.0	
		Z	4.89	67.25	16.83		130.0	
10599-AAA	IEEE 802.11n (HT Mixed, 40MHz, MCS0, 90pc duty cycle)	X	5.69	67.91	17.47	0.46	130.0	± 9.6 %
		Y	5.60	67.26	16.80		130.0	
		Z	5.57	67.26	16.79		130.0	
10600-AAA	IEEE 802.11n (HT Mixed, 40MHz, MCS1, 90pc duty cycle)	X	5.89	68.51	17.74	0.46	130.0	± 9.6 %
		Y	5.77	67.76	17.02		130.0	
		Z	5.73	67.75	17.01		130.0	
10601-AAA	IEEE 802.11n (HT Mixed, 40MHz, MCS2, 90pc duty cycle)	X	5.74	68.15	17.58	0.46	130.0	± 9.6 %
		Y	5.64	67.46	16.88		130.0	
		Z	5.61	67.45	16.87		130.0	
10602-AAA	IEEE 802.11n (HT Mixed, 40MHz, MCS3, 90pc duty cycle)	X	5.83	68.12	17.48	0.46	130.0	± 9.6 %
		Y	5.73	67.43	16.79		130.0	
		Z	5.69	67.44	16.78		130.0	
10603-AAA	IEEE 802.11n (HT Mixed, 40MHz, MCS4, 90pc duty cycle)	X	5.92	68.43	17.76	0.46	130.0	± 9.6 %
		Y	5.82	67.77	17.09		130.0	
		Z	5.78	67.76	17.07		130.0	
10604-AAA	IEEE 802.11n (HT Mixed, 40MHz, MCS5, 90pc duty cycle)	X	5.69	67.85	17.47	0.46	130.0	± 9.6 %
		Y	5.60	67.21	16.80		130.0	
		Z	5.57	67.21	16.79		130.0	
10605-AAA	IEEE 802.11n (HT Mixed, 40MHz, MCS6, 90pc duty cycle)	X	5.81	68.18	17.83	0.46	130.0	± 9.6 %
		Y	5.71	67.49	16.93		130.0	
		Z	5.68	67.51	16.94		130.0	
10606-AAA	IEEE 802.11n (HT Mixed, 40MHz, MCS7, 90pc duty cycle)	X	5.57	67.62	17.23	0.46	130.0	± 9.6 %
		Y	5.48	66.96	16.53		130.0	
		Z	5.46	67.00	16.55		130.0	

EX3DV4- SN:3687

July 25, 2018

10607-AAA	IEEE 802.11ac WiFi (20MHz, MCS0, 90pc duty cycle)	X	4.88	66.62	17.05	0.46	130.0	± 9.6 %
		Y	4.76	65.97	16.22		130.0	
		Z	4.74	65.99	16.22		130.0	
10608-AAA	IEEE 802.11ac WiFi (20MHz, MCS1, 90pc duty cycle)	X	5.10	67.27	17.21	0.46	130.0	± 9.6 %
		Y	4.97	66.40	16.38		130.0	
		Z	4.94	66.42	16.38		130.0	
10609-AAA	IEEE 802.11ac WiFi (20MHz, MCS2, 90pc duty cycle)	X	4.99	67.17	17.09	0.46	130.0	± 9.6 %
		Y	4.86	66.25	16.23		130.0	
		Z	4.83	66.28	16.23		130.0	
10610-AAA	IEEE 802.11ac WiFi (20MHz, MCS3, 90pc duty cycle)	X	5.05	67.33	17.25	0.46	130.0	± 9.6 %
		Y	4.91	66.42	16.40		130.0	
		Z	4.88	66.44	16.39		130.0	
10611-AAA	IEEE 802.11ac WiFi (20MHz, MCS4, 90pc duty cycle)	X	4.96	67.15	17.11	0.46	130.0	± 9.6 %
		Y	4.83	66.24	16.25		130.0	
		Z	4.80	66.26	16.25		130.0	
10612-AAA	IEEE 802.11ac WiFi (20MHz, MCS5, 90pc duty cycle)	X	4.99	67.34	17.17	0.46	130.0	± 9.6 %
		Y	4.84	66.38	16.28		130.0	
		Z	4.82	66.41	16.29		130.0	
10613-AAA	IEEE 802.11ac WiFi (20MHz, MCS6, 90pc duty cycle)	X	5.00	67.24	17.06	0.46	130.0	± 9.6 %
		Y	4.85	66.29	16.18		130.0	
		Z	4.83	66.32	16.19		130.0	
10614-AAA	IEEE 802.11ac WiFi (20MHz, MCS7, 90pc duty cycle)	X	4.93	67.47	17.32	0.46	130.0	± 9.6 %
		Y	4.79	66.50	16.43		130.0	
		Z	4.76	66.50	16.41		130.0	
10615-AAA	IEEE 802.11ac WiFi (20MHz, MCS8, 90pc duty cycle)	X	4.96	66.95	16.87	0.46	130.0	± 9.6 %
		Y	4.83	66.02	16.00		130.0	
		Z	4.80	66.06	16.03		130.0	
10616-AAA	IEEE 802.11ac WiFi (40MHz, MCS0, 90pc duty cycle)	X	5.53	67.26	17.14	0.46	130.0	± 9.6 %
		Y	5.42	66.52	16.42		130.0	
		Z	5.39	66.52	16.41		130.0	
10617-AAA	IEEE 802.11ac WiFi (40MHz, MCS1, 90pc duty cycle)	X	5.59	67.37	17.16	0.46	130.0	± 9.6 %
		Y	5.47	66.62	16.43		130.0	
		Z	5.44	66.63	16.43		130.0	
10618-AAA	IEEE 802.11ac WiFi (40MHz, MCS2, 90pc duty cycle)	X	5.50	67.49	17.25	0.46	130.0	± 9.6 %
		Y	5.37	66.70	16.49		130.0	
		Z	5.34	66.70	16.48		130.0	
10619-AAA	IEEE 802.11ac WiFi (40MHz, MCS3, 90pc duty cycle)	X	5.52	67.29	17.08	0.46	130.0	± 9.6 %
		Y	5.39	66.52	16.33		130.0	
		Z	5.36	66.53	16.33		130.0	
10620-AAA	IEEE 802.11ac WiFi (40MHz, MCS4, 90pc duty cycle)	X	5.62	67.35	17.16	0.46	130.0	± 9.6 %
		Y	5.50	66.61	16.43		130.0	
		Z	5.47	66.61	16.42		130.0	
10621-AAA	IEEE 802.11ac WiFi (40MHz, MCS5, 90pc duty cycle)	X	5.60	67.41	17.30	0.46	130.0	± 9.6 %
		Y	5.48	66.70	16.60		130.0	
		Z	5.45	66.68	16.57		130.0	
10622-AAA	IEEE 802.11ac WiFi (40MHz, MCS6, 90pc duty cycle)	X	5.61	67.57	17.38	0.46	130.0	± 9.6 %
		Y	5.49	66.82	16.64		130.0	
		Z	5.45	66.80	16.62		130.0	

Certificate No: EX3-3687_Jul18

Page 36 of 38

EX3DV4- SN:3687

July 26, 2018

10623-AAA	IEEE 802.11ac WiFi (40MHz, MCS7, 90pc duty cycle)	X	5.48	67.10	17.03	0.46	130.0	± 9.6 %
		Y	5.37	66.36	16.30		130.0	
		Z	6.34	66.37	16.29		130.0	
10624-AAA	IEEE 802.11ac WiFi (40MHz, MCS8, 90pc duty cycle)	X	5.67	67.27	17.16	0.46	130.0	± 9.6 %
		Y	5.56	66.56	16.46		130.0	
		Z	5.53	66.56	16.45		130.0	
10625-AAA	IEEE 802.11ac WiFi (40MHz, MCS9, 90pc duty cycle)	X	6.12	68.46	17.78	0.46	130.0	± 9.6 %
		Y	5.97	67.61	17.02		130.0	
		Z	5.93	67.60	17.01		130.0	
10626-AAA	IEEE 802.11ac WiFi (80MHz, MCS0, 90pc duty cycle)	X	5.79	67.23	17.03	0.46	130.0	± 9.6 %
		Y	5.68	66.56	16.36		130.0	
		Z	5.66	66.57	16.35		130.0	
10627-AAA	IEEE 802.11ac WiFi (80MHz, MCS1, 90pc duty cycle)	X	6.07	67.84	17.26	0.46	130.0	± 9.6 %
		Y	5.93	67.11	16.58		130.0	
		Z	5.90	67.10	16.57		130.0	
10628-AAA	IEEE 802.11ac WiFi (80MHz, MCS2, 90pc duty cycle)	X	5.86	67.42	17.02	0.46	130.0	± 9.6 %
		Y	5.74	66.71	16.32		130.0	
		Z	5.71	66.72	16.32		130.0	
10629-AAA	IEEE 802.11ac WiFi (80MHz, MCS3, 90pc duty cycle)	X	5.94	67.46	17.02	0.46	130.0	± 9.6 %
		Y	5.62	66.76	16.34		130.0	
		Z	5.80	66.78	16.34		130.0	
10630-AAA	IEEE 802.11ac WiFi (80MHz, MCS4, 90pc duty cycle)	X	6.58	69.52	18.04	0.46	130.0	± 9.6 %
		Y	6.35	68.49	17.19		130.0	
		Z	6.30	68.44	17.17		130.0	
10631-AAA	IEEE 802.11ac WiFi (80MHz, MCS5, 90pc duty cycle)	X	6.49	69.11	18.03	0.46	130.0	± 9.6 %
		Y	6.24	68.29	17.29		130.0	
		Z	6.18	68.20	17.24		130.0	
10632-AAA	IEEE 802.11ac WiFi (80MHz, MCS6, 90pc duty cycle)	X	6.03	67.89	17.44	0.46	130.0	± 9.6 %
		Y	5.91	67.21	16.76		130.0	
		Z	5.67	67.17	16.74		130.0	
10633-AAA	IEEE 802.11ac WiFi (80MHz, MCS7, 90pc duty cycle)	X	5.95	67.63	17.15	0.46	130.0	± 9.6 %
		Y	5.63	66.93	16.46		130.0	
		Z	5.79	66.91	16.44		130.0	
10634-AAA	IEEE 802.11ac WiFi (80MHz, MCS8, 90pc duty cycle)	X	5.92	67.62	17.20	0.46	130.0	± 9.6 %
		Y	5.81	66.94	16.53		130.0	
		Z	5.77	66.92	16.50		130.0	
10635-AAA	IEEE 802.11ac WiFi (80MHz, MCS9, 90pc duty cycle)	X	5.80	66.93	16.60	0.46	130.0	± 9.6 %
		Y	5.68	66.23	15.90		130.0	
		Z	5.66	66.26	15.93		130.0	
10636-AAA	IEEE 802.11ac WiFi (160MHz, MCS0, 90pc duty cycle)	X	6.21	67.59	17.09	0.46	130.0	± 9.6 %
		Y	6.09	66.95	16.45		130.0	
		Z	6.07	66.95	16.44		130.0	
10637-AAA	IEEE 802.11ac WiFi (160MHz, MCS1, 90pc duty cycle)	X	6.38	68.00	17.27	0.46	130.0	± 9.6 %
		Y	6.26	67.33	16.62		130.0	
		Z	6.23	67.32	16.61		130.0	
10638-AAA	IEEE 802.11ac WiFi (160MHz, MCS2, 90pc duty cycle)	X	6.38	67.98	17.24	0.46	130.0	± 9.6 %
		Y	6.26	67.30	16.58		130.0	
		Z	6.23	67.30	16.57		130.0	

EX3DV4- SN:3687

July 26, 2016

10639-AAA	IEEE 1602.11ac WiFi (160MHz, MCS3, 90pc duty cycle)	X	6.38	67.67	17.28	0.46	130.0	± 9.6 %
		Y	6.25	67.31	16.63		130.0	
		Z	6.22	67.30	16.62		130.0	
10640-AAA	IEEE 1602.11ac WiFi (160MHz, MCS4, 90pc duty cycle)	X	6.41	68.05	17.28	0.46	130.0	± 9.6 %
		Y	6.27	67.35	16.68		130.0	
		Z	6.24	67.35	16.59		130.0	
10641-AAA	IEEE 1602.11ac WiFi (160MHz, MCS5, 90pc duty cycle)	X	6.39	67.77	17.13	0.46	130.0	± 9.6 %
		Y	6.27	67.12	16.50		130.0	
		Z	6.25	67.14	16.50		130.0	
10642-AAA	IEEE 1602.11ac WiFi (160MHz, MCS6, 90pc duty cycle)	X	6.46	68.10	17.47	0.46	130.0	± 9.6 %
		Y	6.35	67.48	16.85		130.0	
		Z	6.31	67.45	16.82		130.0	
10643-AAA	IEEE 1602.11ac WiFi (160MHz, MCS7, 90pc duty cycle)	X	6.29	67.79	17.22	0.46	130.0	± 9.6 %
		Y	6.17	67.12	16.56		130.0	
		Z	6.14	67.13	16.56		130.0	
10644-AAA	IEEE 1602.11ac WiFi (160MHz, MCS6, 90pc duty cycle)	X	6.53	68.52	17.61	0.46	130.0	± 9.6 %
		Y	6.39	67.77	16.91		130.0	
		Z	6.35	67.76	16.90		130.0	
10645-AAA	IEEE 1602.11ac WiFi (160MHz, MCS9, 90pc duty cycle)	X	6.97	69.32	17.94	0.46	130.0	± 9.6 %
		Y	6.78	68.47	17.20		130.0	
		Z	6.76	68.52	17.22		130.0	

^F Uncertainty is determined using the max. deviation from linear response applying rectangular distribution and is expressed for the square of the field value.

**Calibration Laboratory of
 Schmid & Partner
 Engineering AG**
 Zeughausstrasse 43, 8004 Zurich, Switzerland



S Schweizerischer Kalibrierdienst
S Service suisse d'étalonnage
C Servizio svizzero di taratura
S Swiss Calibration Service

Accredited by the Swiss Accreditation Service (SAS)
 The Swiss Accreditation Service is one of the signatories to the EA
 Multilateral Agreement for the recognition of calibration certificates

Accreditation No.: **SCS 0108**

Client **AT4 Wireless**

Certificate No: **D900V2-1d007_Jul15**

CALIBRATION CERTIFICATE			
Object	D900V2 - SN: 1d007		
Calibration procedure(s)	QA CAL-05.v9 Calibration procedure for dipole validation kits above 700 MHz		
Calibration date:	July 14, 2015		
<p>This calibration certificate documents the traceability to national standards, which realize the physical units of measurements (SI). The measurements and the uncertainties with confidence probability are given on the following pages and are part of the certificate.</p> <p>All calibrations have been conducted in the closed laboratory facility: environment temperature (22 ± 3)°C and humidity < 70%.</p> <p>Calibration Equipment used (M&TE critical for calibration)</p>			
Primary Standards	ID #	Cal Date (Certificate No.)	Scheduled Calibration
Power meter EPM-442A	GB37480704	07-Oct-14 (No. 217-02020)	Oct-15
Power sensor HP 8481A	US37292783	07-Oct-14 (No. 217-02020)	Oct-15
Power sensor HP 8481A	MY41092317	07-Oct-14 (No. 217-02021)	Oct-15
Reference 20 dB Attenuator	SN: 5058 (20k)	01-Apr-15 (No. 217-02131)	Mar-16
Type-N mismatch combination	SN: 5047.2 / 06327	01-Apr-15 (No. 217-02134)	Mar-16
Reference Probe ES3DV3	SN: 3205	30-Dec-14 (No. ES3-3205_Dec14)	Dec-15
DAE4	SN: 601	18-Aug-14 (No. DAE4-601_Aug14)	Aug-15
Secondary Standards	ID #	Check Date (in house)	Scheduled Check
RF generator R&S SMT-06	100005	04-Aug-99 (in house check Oct-13)	In house check: Oct-16
Network Analyzer HP 8753E	US37390585 S4205	18-Oct-01 (in house check Oct-14)	In house check: Oct-15
Calibrated by:	Name Leif Kysner	Function Laboratory Technician	Signature
Approved by:	Name Katja Pokovic	Function Technical Manager	Signature
			Issued: July 14, 2015
This calibration certificate shall not be reproduced except in full without written approval of the laboratory.			

**Calibration Laboratory of
Schmid & Partner
Engineering AG**
Zoughausstrasse 43, 8004 Zurich, Switzerland



S Schweizerischer Kalibrierdienst
S Service suisse d'étalonnage
C Servizio svizzero di taratura
S Swiss Calibration Service

Accredited by the Swiss Accreditation Service (SAS)
The Swiss Accreditation Service is one of the signatories to the EA
Multilateral Agreement for the recognition of calibration certificates

Accreditation No.: **SCS 0108**

Glossary:

TSL	tissue simulating liquid
ConvF	sensitivity in TSL / NORM x,y,z
N/A	not applicable or not measured

Calibration is Performed According to the Following Standards:

- IEEE Std 1528-2013, "IEEE Recommended Practice for Determining the Peak Spatial-Averaged Specific Absorption Rate (SAR) in the Human Head from Wireless Communications Devices: Measurement Techniques", June 2013
- IEC 62209-1, "Procedure to measure the Specific Absorption Rate (SAR) for hand-held devices used in close proximity to the ear (frequency range of 300 MHz to 3 GHz)", February 2005
- IEC 62209-2, "Procedure to determine the Specific Absorption Rate (SAR) for wireless communication devices used in close proximity to the human body (frequency range of 30 MHz to 6 GHz)", March 2010
- KDB 865664, "SAR Measurement Requirements for 100 MHz to 6 GHz"

Additional Documentation:

- DASY4/5 System Handbook

Methods Applied and Interpretation of Parameters:

- Measurement Conditions:** Further details are available from the Validation Report at the end of the certificate. All figures stated in the certificate are valid at the frequency indicated.
- Antenna Parameters with TSL:** The dipole is mounted with the spacer to position its feed point exactly below the center marking of the flat phantom section, with the arms oriented parallel to the body axis.
- Feed Point Impedance and Return Loss:** These parameters are measured with the dipole positioned under the liquid filled phantom. The impedance stated is transformed from the measurement at the SMA connector to the feed point. The Return Loss ensures low reflected power. No uncertainty required.
- Electrical Delay:** One-way delay between the SMA connector and the antenna feed point. No uncertainty required.
- SAR measured:** SAR measured at the stated antenna input power.
- SAR normalized:** SAR as measured, normalized to an input power of 1 W at the antenna connector.
- SAR for nominal TSL parameters:** The measured TSL parameters are used to calculate the nominal SAR result.

The reported uncertainty of measurement is stated as the standard uncertainty of measurement multiplied by the coverage factor $k=2$, which for a normal distribution corresponds to a coverage probability of approximately 95%.

Measurement Conditions

DASY system configuration, as far as not given on page 1.

DASY Version	DASY5	V52.8.8
Extrapolation	Advanced Extrapolation	
Phantom	Modular Flat Phantom	
Distance Dipole Center - TSL	15 mm	with Spacer
Zoom Scan Resolution	dx, dy, dz = 5 mm	
Frequency	900 MHz ± 1 MHz	

Head TSL parameters

The following parameters and calculations were applied.

	Temperature	Permittivity	Conductivity
Nominal Head TSL parameters	22.0 °C	41.5	0.97 mho/m
Measured Head TSL parameters	(22.0 ± 0.2) °C	42.2 ± 6 %	0.95 mho/m ± 6 %
Head TSL temperature change during test	< 0.5 °C	---	---

SAR result with Head TSL

SAR averaged over 1 cm ³ (1 g) of Head TSL	Condition	
SAR measured	250 mW input power	2.60 W/kg
SAR for nominal Head TSL parameters	normalized to 1W	10.6 W/kg ± 17.0 % (k=2)

SAR averaged over 10 cm ³ (10 g) of Head TSL	condition	
SAR measured	250 mW input power	1.68 W/kg
SAR for nominal Head TSL parameters	normalized to 1W	6.82 W/kg ± 16.5 % (k=2)

Body TSL parameters

The following parameters and calculations were applied.

	Temperature	Permittivity	Conductivity
Nominal Body TSL parameters	22.0 °C	55.0	1.05 mho/m
Measured Body TSL parameters	(22.0 ± 0.2) °C	54.8 ± 6 %	1.03 mho/m ± 6 %
Body TSL temperature change during test	< 0.5 °C	---	---

SAR result with Body TSL

SAR averaged over 1 cm ³ (1 g) of Body TSL	Condition	
SAR measured	250 mW input power	2.60 W/kg
SAR for nominal Body TSL parameters	normalized to 1W	10.5 W/kg ± 17.0 % (k=2)

SAR averaged over 10 cm ³ (10 g) of Body TSL	condition	
SAR measured	250 mW input power	1.68 W/kg
SAR for nominal Body TSL parameters	normalized to 1W	6.79 W/kg ± 16.5 % (k=2)

Appendix (Additional assessments outside the scope of SCS 0108)

Antenna Parameters with Head TSL

Impedance, transformed to feed point	49.9 Ω - 3.5 j Ω
Return Loss	- 29.0 dB

Antenna Parameters with Body TSL

Impedance, transformed to feed point	45.5 Ω - 5.3 j Ω
Return Loss	- 22.8 dB

General Antenna Parameters and Design

Electrical Delay (one direction)	1.408 ns
----------------------------------	----------

After long term use with 100W radiated power, only a slight warming of the dipole near the feedpoint can be measured.

The dipole is made of standard semirigid coaxial cable. The center conductor of the feeding line is directly connected to the second arm of the dipole. The antenna is therefore short-circuited for DC-signals. On some of the dipoles, small end caps are added to the dipole arms in order to improve matching when loaded according to the position as explained in the "Measurement Conditions" paragraph. The SAR data are not affected by this change. The overall dipole length is still according to the Standard.

No excessive force must be applied to the dipole arms, because they might bend or the soldered connections near the feedpoint may be damaged.

Additional EUT Data

Manufactured by	SPEAG
Manufactured on	February 13, 2004

DASY5 Validation Report for Head TSL

Date: 14.07.2015

Test Laboratory: SPEAG, Zurich, Switzerland

DUT: Dipole 900 MHz; Type: D900V2; Serial: D900V2 - SN: 1d007

Communication System: UID 0 - CW; Frequency: 900 MHz

Medium parameters used: $f = 900$ MHz; $\sigma = 0.95$ S/m; $\epsilon_r = 42.2$; $\rho = 1000$ kg/m³

Phantom section: Flat Section

Measurement Standard: DASY5 (IEEE/IEC/ANSI C63.19-2011)

DASY52 Configuration:

- Probe: ES3DV3 - SN3205; ConvF(5.94, 5.94, 5.94); Calibrated: 30.12.2014;
- Sensor-Surface: 3mm (Mechanical Surface Detection)
- Electronics: DAE4 Sn601; Calibrated: 18.08.2014
- Phantom: Flat Phantom 4.9L; Type: QD000P49AA; Serial: 1001
- DASY52 52.8.8(1222); SEMCAD X 14.6.10(7331)

Dipole Calibration for Head Tissue/Pin=250 mW, d=15mm/Zoom Scan (7x7x7)/Cube 0:

Measurement grid: dx=5mm, dy=5mm, dz=5mm

Reference Value = 58.61 V/m; Power Drift = 0.01 dB

Peak SAR (extrapolated) = 3.88 W/kg

SAR(1 g) = 2.6 W/kg; SAR(10 g) = 1.68 W/kg

Maximum value of SAR (measured) = 3.05 W/kg

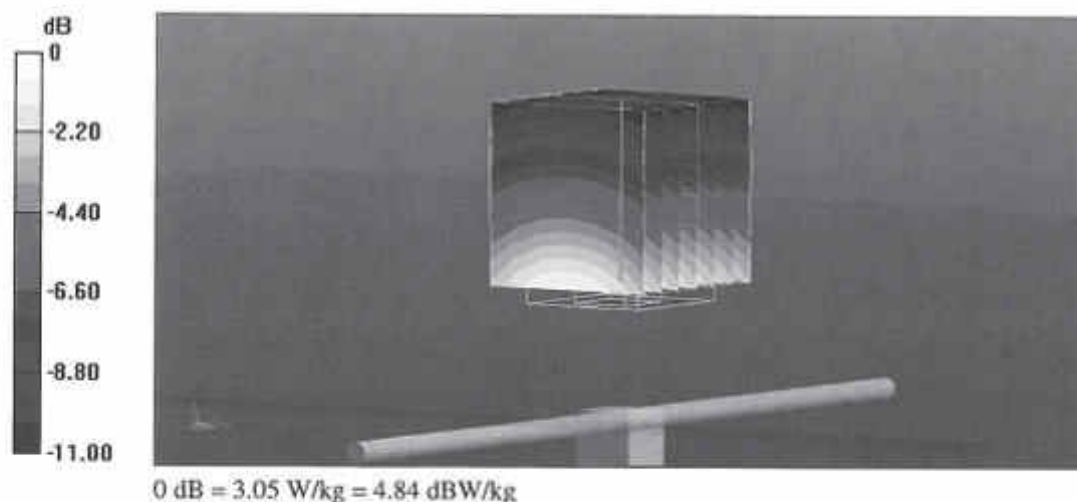

Impedance Measurement Plot for Head TSL

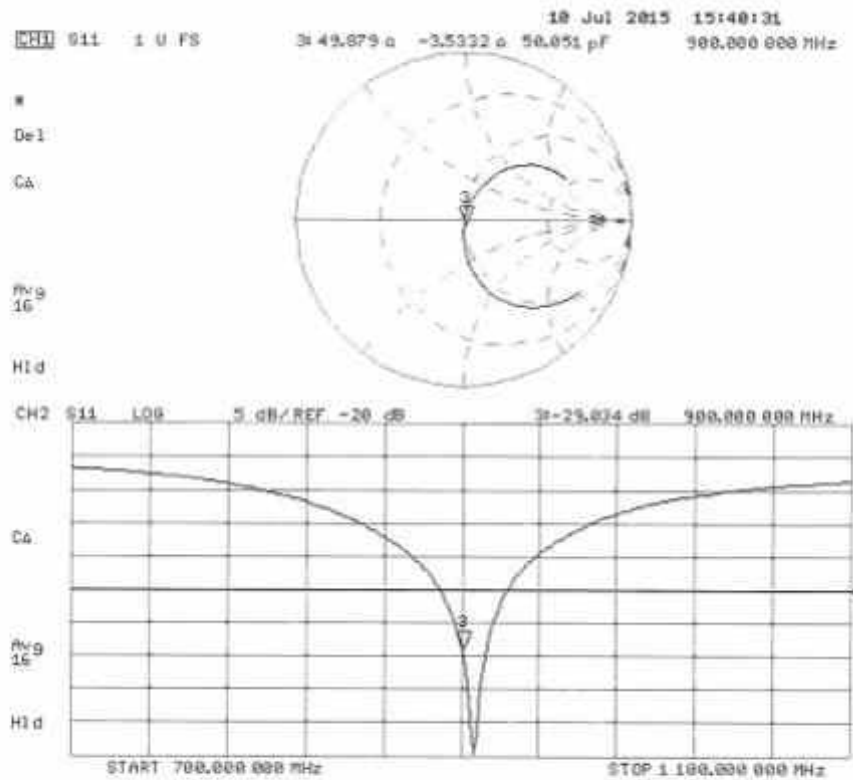

DASY5 Validation Report for Body TSL

Date: 10.07.2015

Test Laboratory: SPEAG, Zurich, Switzerland

DUT: Dipole 900 MHz; Type: D900V2; Serial: D900V2 - SN: 1d007

Communication System: UID 0 - CW; Frequency: 900 MHz

Medium parameters used: $f = 900$ MHz; $\sigma = 1.03$ S/m; $\epsilon_r = 54.8$; $\rho = 1000$ kg/m³

Phantom section: Flat Section

Measurement Standard: DASY5 (IEEE/IEC/ANSI C63.19-2011)

DASY52 Configuration:

- Probe: ES3DV3 - SN3205; ConvF(5.95, 5.95, 5.95); Calibrated: 30.12.2014;
- Sensor-Surface: 3mm (Mechanical Surface Detection)
- Electronics: DAE4 Sn601; Calibrated: 18.08.2014
- Phantom: Flat Phantom 4.9L; Type: QD000P49AA; Serial: 1001
- DASY52 52.8.8(1222); SEMCAD X 14.6.10(7331)

Dipole Calibration for Body Tissue/Pin=250 mW, d=15mm/Zoom Scan (7x7x7)/Cube 0:

Measurement grid: $dx=5$ mm, $dy=5$ mm, $dz=5$ mm

Reference Value = 56.60 V/m; Power Drift = -0.04 dB

Peak SAR (extrapolated) = 3.84 W/kg

SAR(1 g) = 2.6 W/kg; SAR(10 g) = 1.68 W/kg

Maximum value of SAR (measured) = 3.05 W/kg



Impedance Measurement Plot for Body TSL

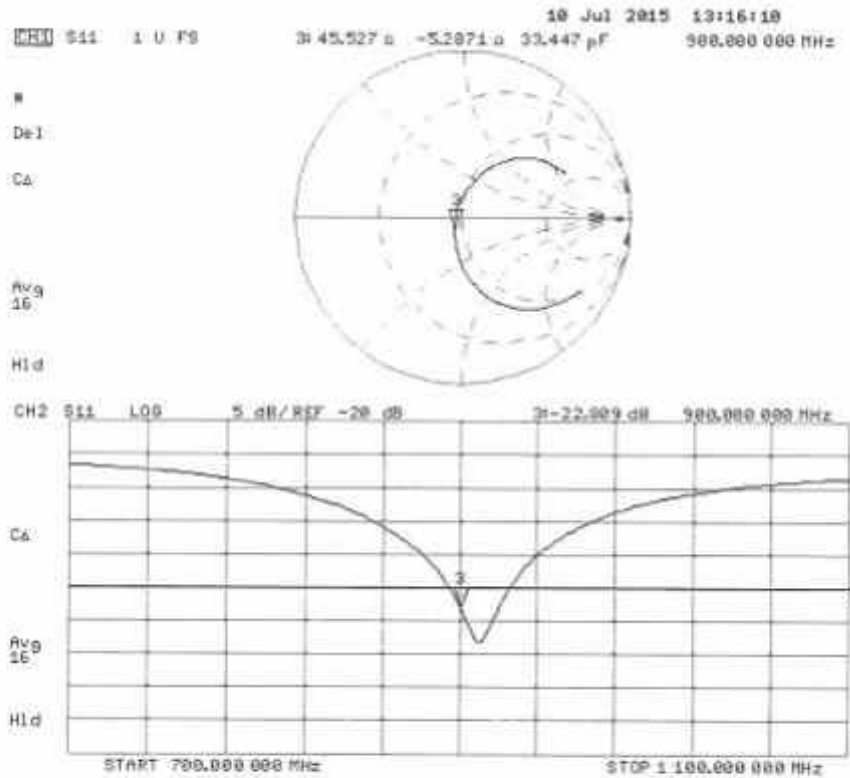

**Calibration Laboratory of
 Schmid & Partner
 Engineering AG**
 Zeughausstrasse 43, 8004 Zurich, Switzerland



S Schweizerischer Kalibrierdienst
S Service suisse d'étalonnage
C Servizio svizzero di taratura
S Swiss Calibration Service

Accredited by the Swiss Accreditation Service (SAS)
 The Swiss Accreditation Service is one of the signatories to the EA
 Multilateral Agreement for the recognition of calibration certificates

Accreditation No.: **SCS 0108**

Client **AT4 Wireless**

Certificate No: **D1800V2-2d099_Jul15**

CALIBRATION CERTIFICATE

Object: **D1800V2 - SN: 2d099**

Calibration procedure(s): **QA CAL-05.v9
 Calibration procedure for dipole validation kits above 700 MHz**

Calibration date: **July 09, 2015**

This calibration certificate documents the traceability to national standards, which realize the physical units of measurements (SI).
 The measurements and the uncertainties with confidence probability are given on the following pages and are part of the certificate.

All calibrations have been conducted in the closed laboratory facility: environment temperature (22 ± 3)°C and humidity < 70%.

Calibration Equipment used (M&TE critical for calibration)

Primary Standards	ID #	Cal Date (Certificate No.)	Scheduled Calibration
Power meter EPM-442A	GB37480704	07-Oct-14 (No. 217-02020)	Oct-15
Power sensor HP 8481A	US37282783	07-Oct-14 (No. 217-02020)	Oct-15
Power sensor HP 8481A	MY41092317	07-Oct-14 (No. 217-02021)	Oct-15
Reference 20 dB Attenuator	SN: 5058 (20k)	01-Apr-15 (No. 217-02131)	Mar-16
Type-N mismatch combination	SN: 5047.2 / 06327	01-Apr-15 (No. 217-02134)	Mar-16
Reference Probe ES3DV3	SN: 3205	30-Dec-14 (No. ES3-3205_Dec14)	Dec-15
DAE4	SN: 601	18-Aug-14 (No. DAE4-601_Aug14)	Aug-15
Secondary Standards	ID #	Check Date (in house)	Scheduled Check
RF generator R&S SMT-06	100005	04-Aug-99 (in house check Oct-13)	in house check: Oct-16
Network Analyzer HP 8753E	US37390585 S4206	18-Oct-01 (in house check Oct-14)	in house check: Oct-15

Calibrated by: **Claudio Leubler** (Name), **Laboratory Technician** (Function),  (Signature)

Approved by: **Katja Pokovic** (Name), **Technical Manager** (Function),  (Signature)

Issued: July 14, 2015

This calibration certificate shall not be reproduced except in full without written approval of the laboratory.

**Calibration Laboratory of
Schmid & Partner
Engineering AG**
Zeughausstrasse 43, 8004 Zurich, Switzerland



S Schweizerischer Kalibrierdienst
C Service suisse d'étalonnage
C Servizio svizzero di taratura
S Swiss Calibration Service

Accredited by the Swiss Accreditation Service (SAS)
The Swiss Accreditation Service is one of the signatories to the EA
Multilateral Agreement for the recognition of calibration certificates

Accreditation No.: **SCS 0108**

Glossary:

TSL	tissue simulating liquid
ConvF	sensitivity in TSL / NORM x,y,z
N/A	not applicable or not measured

Calibration is Performed According to the Following Standards:

- IEEE Std 1528-2013, "IEEE Recommended Practice for Determining the Peak Spatial-Averaged Specific Absorption Rate (SAR) in the Human Head from Wireless Communications Devices: Measurement Techniques", June 2013
- IEC 62209-1, "Procedure to measure the Specific Absorption Rate (SAR) for hand-held devices used in close proximity to the ear (frequency range of 300 MHz to 3 GHz)", February 2005
- IEC 62209-2, "Procedure to determine the Specific Absorption Rate (SAR) for wireless communication devices used in close proximity to the human body (frequency range of 30 MHz to 6 GHz)", March 2010
- KDB 865664, "SAR Measurement Requirements for 100 MHz to 6 GHz"

Additional Documentation:

- DASY4/5 System Handbook

Methods Applied and Interpretation of Parameters:

- Measurement Conditions:* Further details are available from the Validation Report at the end of the certificate. All figures stated in the certificate are valid at the frequency indicated.
- Antenna Parameters with TSL:* The dipole is mounted with the spacer to position its feed point exactly below the center marking of the flat phantom section, with the arms oriented parallel to the body axis.
- Feed Point Impedance and Return Loss:* These parameters are measured with the dipole positioned under the liquid filled phantom. The impedance stated is transformed from the measurement at the SMA connector to the feed point. The Return Loss ensures low reflected power. No uncertainty required.
- Electrical Delay:* One-way delay between the SMA connector and the antenna feed point. No uncertainty required.
- SAR measured:* SAR measured at the stated antenna input power.
- SAR normalized:* SAR as measured, normalized to an input power of 1 W at the antenna connector.
- SAR for nominal TSL parameters:* The measured TSL parameters are used to calculate the nominal SAR result.

The reported uncertainty of measurement is stated as the standard uncertainty of measurement multiplied by the coverage factor $k=2$, which for a normal distribution corresponds to a coverage probability of approximately 95%.

Measurement Conditions

DASY system configuration, as far as not given on page 1.

DASY Version	DASY5	V52.8.8
Extrapolation	Advanced Extrapolation	
Phantom	Modular Flat Phantom	
Distance Dipole Center - TSL	10 mm	with Spacer
Zoom Scan Resolution	dx, dy, dz = 5 mm	
Frequency	1800 MHz ± 1 MHz	

Head TSL parameters

The following parameters and calculations were applied.

	Temperature	Permittivity	Conductivity
Nominal Head TSL parameters	22.0 °C	40.0	1.40 mho/m
Measured Head TSL parameters	(22.0 ± 0.2) °C	38.6 ± 6 %	1.42 mho/m ± 6 %
Head TSL temperature change during test	< 0.5 °C	----	----

SAR result with Head TSL

SAR averaged over 1 cm ³ (1 g) of Head TSL	Condition	
SAR measured	250 mW input power	9.93 W/kg
SAR for nominal Head TSL parameters	normalized to 1W	39.1 W/kg ± 17.0 % (k=2)

SAR averaged over 10 cm ³ (10 g) of Head TSL	condition	
SAR measured	250 mW input power	5.21 W/kg
SAR for nominal Head TSL parameters	normalized to 1W	20.6 W/kg ± 16.5 % (k=2)

Body TSL parameters

The following parameters and calculations were applied.

	Temperature	Permittivity	Conductivity
Nominal Body TSL parameters	22.0 °C	53.3	1.52 mho/m
Measured Body TSL parameters	(22.0 ± 0.2) °C	52.0 ± 6 %	1.52 mho/m ± 6 %
Body TSL temperature change during test	< 0.5 °C	----	----

SAR result with Body TSL

SAR averaged over 1 cm ³ (1 g) of Body TSL	Condition	
SAR measured	250 mW input power	9.41 W/kg
SAR for nominal Body TSL parameters	normalized to 1W	37.4 W/kg ± 17.0 % (k=2)

SAR averaged over 10 cm ³ (10 g) of Body TSL	condition	
SAR measured	250 mW input power	4.97 W/kg
SAR for nominal Body TSL parameters	normalized to 1W	19.8 W/kg ± 16.5 % (k=2)

Appendix (Additional assessments outside the scope of SCS 0108)

Antenna Parameters with Head TSL

Impedance, transformed to feed point	49.5 Ω - 4.8 j Ω
Return Loss	- 26.3 dB

Antenna Parameters with Body TSL

Impedance, transformed to feed point	45.8 Ω - 4.3 j Ω
Return Loss	- 24.1 dB

General Antenna Parameters and Design

Electrical Delay (one direction)	1.198 ns
----------------------------------	----------

After long term use with 100W radiated power, only a slight warming of the dipole near the feedpoint can be measured.

The dipole is made of standard semirigid coaxial cable. The center conductor of the feeding line is directly connected to the second arm of the dipole. The antenna is therefore short-circuited for DC-signals. On some of the dipoles, small end caps are added to the dipole arms in order to improve matching when loaded according to the position as explained in the "Measurement Conditions" paragraph. The SAR data are not affected by this change. The overall dipole length is still according to the Standard.

No excessive force must be applied to the dipole arms, because they might bend or the soldered connections near the feedpoint may be damaged.

Additional EUT Data

Manufactured by	SPEAG
Manufactured on	January 30, 2004

DASY5 Validation Report for Head TSL

Date: 09.07.2015

Test Laboratory: SPEAG, Zurich, Switzerland

DUT: Dipole 1800 MHz; Type: D1800V2; Serial: D1800V2 - SN: 2d099

Communication System: UID 0 - CW; Frequency: 1800 MHz

Medium parameters used: $f = 1800$ MHz; $\sigma = 1.42$ S/m; $\epsilon_r = 38.6$; $\rho = 1000$ kg/m³

Phantom section: Flat Section

Measurement Standard: DASY5 (IEEE/IEC/ANSI C63.19-2011)

DASY52 Configuration:

- Probe; ES3DV3 - SN3205; ConvF(5.06, 5.06, 5.06); Calibrated: 30.12.2014;
- Sensor-Surface: 3mm (Mechanical Surface Detection)
- Electronics: DAE4 Sn601; Calibrated: 18.08.2014
- Phantom: Flat Phantom 5.0 (front); Type: QD000P50AA; Serial: 1001
- DASY52 52.8.8(1222); SEMCAD X 14.6.10(7331)

Dipole Calibration for Head Tissue/Pin=250 mW, d=10mm/Zoom Scan (7x7x7)/Cube 0:

Measurement grid: dx=5mm, dy=5mm, dz=5mm

Reference Value = 96.37 V/m; Power Drift = 0.05 dB

Peak SAR (extrapolated) = 18.2 W/kg

SAR(1 g) = 9.93 W/kg; SAR(10 g) = 5.21 W/kg

Maximum value of SAR (measured) = 12.4 W/kg

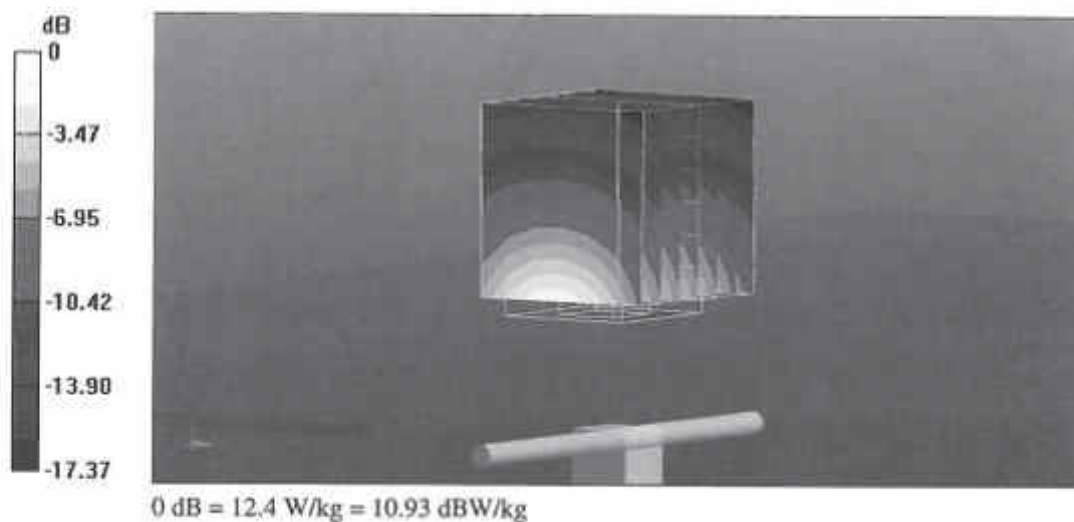

Impedance Measurement Plot for Head TSL

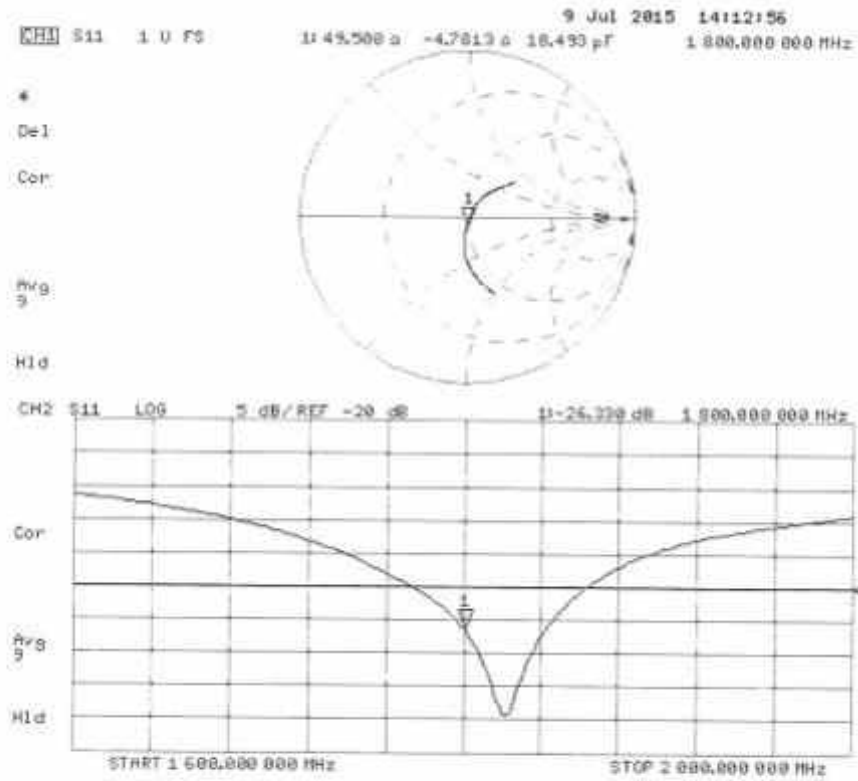

DASY5 Validation Report for Body TSL

Date: 09.07.2015

Test Laboratory: SPEAG, Zurich, Switzerland

DUT: Dipole 1800 MHz; Type: D1800V2; Serial: D1800V2 - SN: 2d099

Communication System: UID 0 - CW; Frequency: 1800 MHz

Medium parameters used: $f = 1800$ MHz; $\sigma = 1.52$ S/m; $\epsilon_r = 52$; $\rho = 1000$ kg/m³

Phantom section: Flat Section

Measurement Standard: DASY5 (IEEE/IEC/ANSI C63.19-2011)

DASY52 Configuration:

- Probe: ES3DV3 - SN3205; ConvF(4.77, 4.77, 4.77); Calibrated: 30.12.2014;
- Sensor-Surface: 3mm (Mechanical Surface Detection)
- Electronics: DAE4 Sn601; Calibrated: 18.08.2014
- Phantom: Flat Phantom 5.0 (back); Type: QD000P50AA; Serial: 1002
- DASY52 52.8.8(1222); SEMCAD X 14.6.10(7331)

Dipole Calibration for Body Tissue/Pin=250 mW, d=10mm/Zoom Scan (7x7x7)/Cube 0:

Measurement grid: dx=5mm, dy=5mm, dz=5mm

Reference Value = 91.14 V/m; Power Drift = 0.02 dB

Peak SAR (extrapolated) = 17.0 W/kg

SAR(1 g) = 9.41 W/kg; SAR(10 g) = 4.97 W/kg

Maximum value of SAR (measured) = 12.0 W/kg



Impedance Measurement Plot for Body TSL

