

DATE: 22 June 2011

I.T.L. (PRODUCT TESTING) LTD.

FCC Radio Test Report

for

ElmoTech Ltd.

Equipment under test:

2Track Base Unit

SBU 2000LL

FCC ID: LSQ-SBU2000418-4

Written by:  _____

D. Shidlow, Documentation

Approved by:  _____

A. Sharabi, Test Engineer

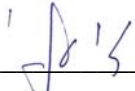
Approved by:  _____

I. Raz, EMC Laboratory Manager

This report must not be reproduced, except in full, without the written permission of I.T.L. (Product Testing) Ltd.

This report relates only to items tested.

TABLE OF CONTENTS

1.	GENERAL INFORMATION-----	5
1.1	Administrative Information.....	5
1.2	List of Accreditations	6
1.3	Product Description	7
1.4	Test Methodology	7
1.5	Test Facility	7
1.6	Measurement Uncertainty	7
2.	SYSTEM TEST CONFIGURATION-----	8
2.1	Justification.....	8
2.2	Special Accessories	8
2.3	Equipment Modifications	8
2.4	Configuration of Tested System.....	8
3.	CONDUCTED AND RADIATED MEASUREMENT TEST SET-UP PHOTO-----	9
4.	CONDUCTED EMISSION DATA-----	11
4.1	Test Specification	11
4.2	Test Procedure.....	11
4.3	Measured Data.....	11
4.4	Test Instrumentation Used, Conducted Measurement	16
5.	AVERAGE FACTOR CALCULATION HELICAL ANTENNA TRANSMITTER-----	17
5.1	Test Instrumentation Used	19
6.	PERIODIC OPERATION HELICAL ANTENNA TRANSMITTER -----	20
6.1	Specification	20
6.2	Requirements	20
6.3	Results.....	20
6.1	Test Instrumentation Used	22
7.	FIELD STRENGTH OF FUNDAMENTAL HELICAL ANTENNA TRANSMITTER -----	23
7.1	Test Specification	23
7.2	Test Procedure.....	23
7.3	Measured Data.....	23
7.4	Test Instrumentation Used, Field Strength of Fundamental	27
8.	RADIATED EMISSION, 9 KHZ – 30 MHZ HELICAL ANTENNA TRANSMITTER -----	28
8.1	Test Specification	28
8.2	Test Procedure.....	28
8.3	Measured Data.....	28
8.4	Test Instrumentation Used, Radiated Measurements	29
8.5	Field Strength Calculation	29
9.	SPURIOUS RADIATED EMISSION HELICAL ANTENNA TRANSMITTER-----	30
9.1	Test Specification	30
9.2	Test Procedure.....	30
9.3	Test Data	31
9.4	Test Instrumentation Used, Radiated Measurements	33
10.	BANDWIDTH HELICAL ANTENNA TRANSMITTER-----	34
10.1	Test procedure	34
10.2	Results table.....	35
10.3	Test Equipment Used.....	36
11.	AVERAGE FACTOR CALCULATION F ANTENNA TRANSMITTER-----	37
11.1	Test Instrumentation Used	39

12.	PERIODIC OPERATION F ANTENNA TRANSMITTER -----	40
12.1	Specification	40
12.2	Requirements	40
12.3	Results.....	40
12.4	Test Instrumentation Used	42
13.	FIELD STRENGTH OF FUNDAMENTAL F ANTENNA TRANSMITTER-----	43
13.1	Test Specification	43
13.2	Test Procedure	43
13.3	Measured Data.....	43
13.4	Test Instrumentation Used, Field Strength of Fundamental	47
14.	RADIATED EMISSION, 9 KHZ – 30 MHZ F ANTENNA TRANSMITTER -----	48
14.1	Test Specification	48
14.2	Test Procedure	48
14.3	Measured Data.....	48
14.4	Test Instrumentation Used, Radiated Measurements	49
14.5	Field Strength Calculation	49
15.	SPURIOUS RADIATED EMISSION HELICAL ANTENNA TRANSMITTER -----	50
15.1	Test Specification	50
15.2	Test Procedure	50
15.3	Test Data	51
15.4	Test Instrumentation Used, Radiated Measurements	53
16.	BANDWIDTH HELICAL ANTENNA TRANSMITTER-----	54
16.1	Test procedure	54
16.2	Results table.....	55
16.3	Test Equipment Used.....	56
17.	APPENDIX A - CORRECTION FACTORS -----	57
17.1	Correction factors for CABLE	57
17.2	Correction factors for CABLE	58
17.3	Correction factors for CABLE	59
12.6	Correction factors for LOG PERIODIC ANTENNA	60
17.4	Correction factors for LOG PERIODIC ANTENNA	61
17.5	Correction factors for BICONICAL ANTENNA.....	62
17.6	Correction factors for ACTIVE LOOP ANTENNA	63

1. General Information

1.1 Administrative Information

Manufacturer:	ElmoTech Ltd.
Manufacturer's Address:	P.O.B. 13236 2 Habarzel St., Tel-Aviv, 61132 Israel Tel: +972-3-767-1700 Fax: +972-3-767-1701
Manufacturer's Representative:	Shai Avigdori Arad Dudkevitz
Equipment Under Test (E.U.T):	2Track Base Unit
Equipment Model No.:	SBU 2000LL
Equipment Serial No.:	Not Designated
Date of Receipt of E.U.T:	19.05.11
Start of Test:	19.05.11
End of Test:	25.05.11
Test Laboratory Location:	I.T.L (Product Testing) Ltd. Kfar Bin Nun, ISRAEL 99780
Test Specifications:	FCC Part 15 Subpart C

1.2 List of Accreditations

The EMC laboratory of I.T.L. is accredited by the following bodies:

1. The American Association for Laboratory Accreditation (A2LA) (U.S.A.), Certificate No. 1152.01.
2. The Federal Communications Commission (FCC) (U.S.A.), Registration No. 90715.
3. The Israel Ministry of the Environment (Israel), Registration No. 1104/01.
4. The Voluntary Control Council for Interference by Information Technology Equipment (VCCI) (Japan), Registration Numbers: C-1350, R-1285.
5. Industry Canada (Canada), IC File No.: 46405-4025; Site No. IC 4025B-1.
6. TUV Product Services, England, ASLLAS No. 97201.

I.T.L. Product Testing Ltd. is accredited by the American Association for Laboratory Accreditation (A2LA) and the results shown in this test report have been determined in accordance with I.T.L.'s terms of accreditation unless stated otherwise in the report.

1.3 Product Description

The smart base unit is a monitoring device that receives RF transmissions from transmitting devices and reports the status of the transmitters to a service center via a PSTN or cellular communication.

The unit incorporates two RF transceivers 418MHz with non-simultaneous transmission, a modular approved GSM module, FCC ID: QIPTC63I, which does not transmit at the same time as either of the two 418 MHz transceivers, and an approved PSTN modem.

1.4 Test Methodology

Both conducted and radiated testing were performed according to the procedures in ANSI C63.4: 2003. Radiated testing was performed at an antenna to EUT distance of 3 meters.

1.5 Test Facility

The radiated emissions tests were performed at I.T.L.'s testing facility at Kfar Bin-Nun, Israel. This site is a FCC listed test laboratory (FCC Registration No. 90715, date of listing September 3, 2009).

I.T.L.'s EMC Laboratory is also accredited by A2LA, certificate No. 1152.01.

1.6 Measurement Uncertainty

Conducted Emission

Conducted Emission (CISPR 11, EN 55011, CISPR 22, EN 55022, ANSI C63.4) 0.15 – 30 MHz:

Expanded Uncertainty (95% Confidence, K=2):

± 3.44 dB

Radiated Emission

Radiated Emission (CISPR 11, EN 55011, CISPR 22, EN 55022, ANSI C63.4) for open site 30-1000MHz:

Expanded Uncertainty (95% Confidence, K=2):

± 4.96 dB

2. System Test Configuration

2.1 Justification

The E.U.T. was tested as tabletop equipment with both 418 MHz transceivers not operating simultaneously since in normal operation, the transceivers transmit separately after detection of the RSSI received from a wireless bracelet.

Testing was performed on each 418 MHz transceiver separately.

2.2 Special Accessories

No special accessories were needed.

2.3 Equipment Modifications

No modifications were needed in order to achieve compliance

2.4 Configuration of Tested System

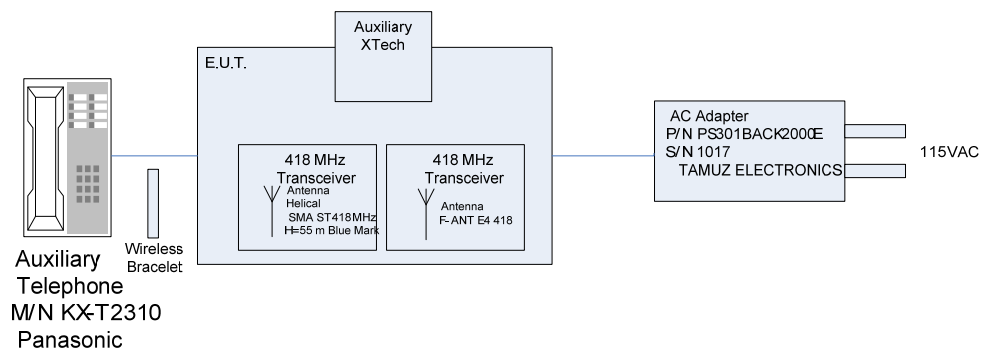

Figure 1. Configuration of Tested System

3. Conducted and Radiated Measurement Test Set-up Photo



Figure 2. Conducted Emission Test



Figure 3. Radiated Emission Test 9 kHz – 30 MHz



Figure 4. Radiated Emission Test Above 30 MHz

4. Conducted Emission Data

4.1 Test Specification

F.C.C., Part 15, Subpart C

4.2 Test Procedure

The E.U.T operation mode and test set-up are as described in Section 3.1. In order to minimize background noise interference, the conducted emission testing was performed inside a shielded room, with the E.U.T placed on an 0.8 meter high wooden table, 0.4 meter from the room's vertical wall.

The E.U.T was powered from 115 V AC / 60 Hz via a 50 Ohm / 50 μ Hn Line Impedance Stabilization Network (LISN) on the phase and neutral lines. The LISN's were grounded to the shielded room ground plane (floor), and were kept at least 0.8 meters from the nearest boundary of the E.U.T

The center of the E.U.T AC cable was folded back and forth, in order to form a bundle less than 0.40 meters and a total cable length of 1 meter.

The emission voltages at the LISN's outputs were measured using a computerized receiver, complying with CISPR 16 requirements. The specification limits are loaded to the receiver via a 3.5" floppy disk and are displayed on the receiver's spectrum display.

A frequency scan between 0.15 and 30 MHz was performed at 9 kHz I.F. band width, and using peak detection.

The spectral components having the highest level on each line were measured using a quasi-peak and average detector.

4.3 Measured Data

JUDGEMENT: Passed by 16.54dB

The margin between the emission levels and the specification limit is, in the worst case, 17.83 dB for the phase line at 0.182MHz and 16.54dB at 0.974MHz for the neutral line.

The EUT met the F.C.C. Part 15, Subpart C specification requirements.

The details of the highest emissions are given in *Figure 5* to *Figure 8*.

TEST PERSONNEL:

Tester Signature:  Date: 29.06.11

Typed/Printed Name: A. Sharabi

Conducted Emission

E.U.T Description 2Track Base Unit
 Type SBU 2000LL
 Serial Number: Not Designated

Specification: F.C.C., Part 15, Subpart C
 Lead: Phase
 Detectors: Peak, Quasi-peak, Average

EDIT PEAK LIST (Final Measurement Results)				
TRACE		FREQUENCY	LEVEL dB μ V	DELTA LIMIT dB
Trace1:	CE22BQP			
Trace2:	CE22BAP			
Trace3:	---			
1	Quasi Peak	182 kHz	46.56	-17.83
2	Average	186 kHz	34.72	-19.49
1	Quasi Peak	378 kHz	39.89	-18.42
2	Average	378 kHz	19.44	-28.88
1	Quasi Peak	498 kHz	27.77	-28.26
2	Average	498 kHz	11.99	-34.03
1	Quasi Peak	3.49 MHz	23.71	-32.28
2	Average	3.538 MHz	11.00	-35.00
1	Quasi Peak	7.602 MHz	15.41	-44.58
2	Average	7.602 MHz	6.97	-43.02
1	Quasi Peak	17.394 MHz	19.22	-40.77
2	Average	17.394 MHz	12.78	-37.21

Date: 23.MAY.2011 13:45:18

Figure 5. Detectors: Peak, Quasi-peak, AVERAGE .

Note: QP Delta/Av Delta refer to the test results obtained minus specified requirement; thus a positive number indicates failure, and a negative result indicates that the product passes the test.

Conducted Emission

E.U.T Description 2Track Base Unit
 Type SBU 2000LL
 Serial Number: Not Designated

Specification: F.C.C., Part 15, Subpart C
 Lead: Phase
 Detectors: Peak, Quasi-peak, Average

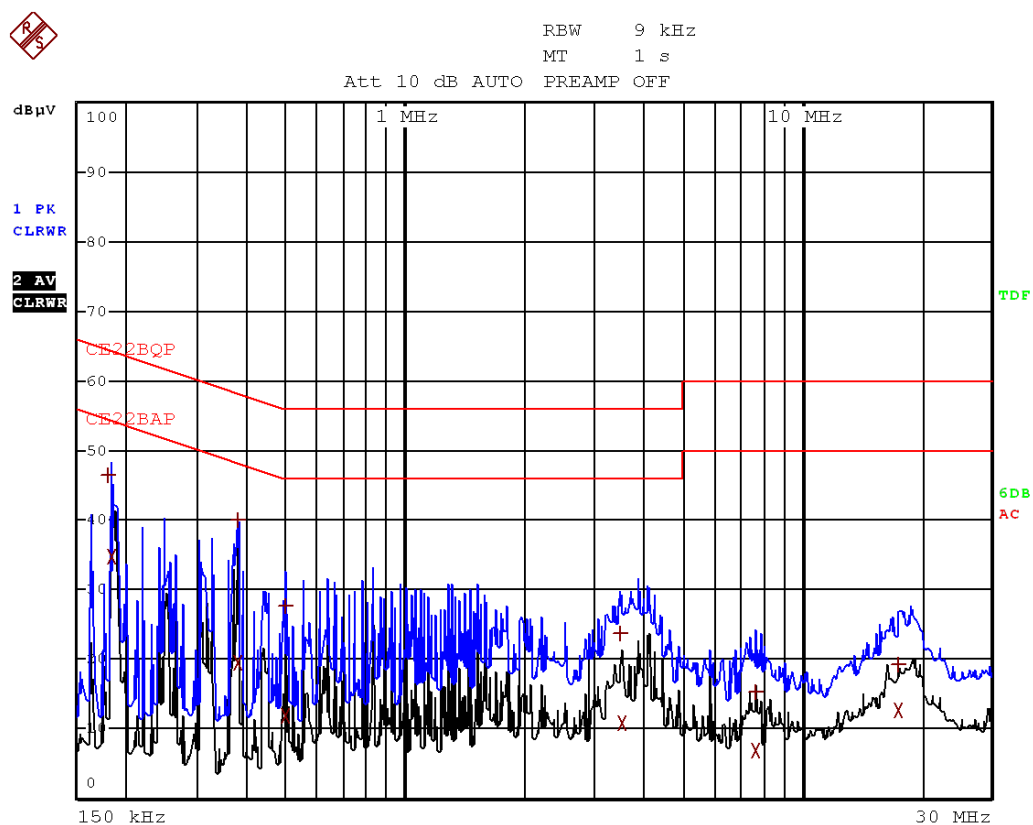

Date: 23.MAY.2011 13:46:27

Figure 6. Detectors: Peak, Quasi-peak, Average

Conducted Emission

E.U.T Description 2Track Base Unit
Type SBU 2000LL
Serial Number: Not Designated

Specification: F.C.C., Part 15, Subpart C
Lead: Neutral
Detectors: Peak, Quasi-peak, Average

EDIT PEAK LIST (Final Measurement Results)				
TRACE		FREQUENCY	LEVEL dB μ V	DELTA LIMIT dB
Trace1:	CE22BQP			
Trace2:	CE22BAP			
Trace3:	---			
1	Quasi Peak	214 kHz	40.83	-22.21
2	Average	226 kHz	34.29	-18.30
1	Quasi Peak	294 kHz	36.86	-23.54
2	Average	346 kHz	19.41	-29.64
1	Quasi Peak	402 kHz	37.28	-20.52
2	Average	402 kHz	25.49	-22.32
1	Quasi Peak	794 kHz	23.21	-32.78
2	Average	794 kHz	11.71	-34.28
1	Quasi Peak	974 kHz	30.43	-25.57
2	Average	974 kHz	29.45	-16.54
1	Quasi Peak	1.946 MHz	30.08	-25.92
2	Average	1.946 MHz	28.73	-17.26

Date: 23.MAY.2011 14:00:26

Figure 7. Detectors: Peak, Quasi-peak, AVERAGE

Note: QP Delta/Av Delta refer to the test results obtained minus specified requirement; thus a positive number indicates failure, and a negative result indicates that the product passes the test.

Conducted Emission

E.U.T Description 2Track Base Unit
 Type SBU 2000LL
 Serial Number: Not Designated

Specification: F.C.C., Part 15, Subpart C
 Lead: Neutral
 Detectors: Peak, Quasi-peak, Average

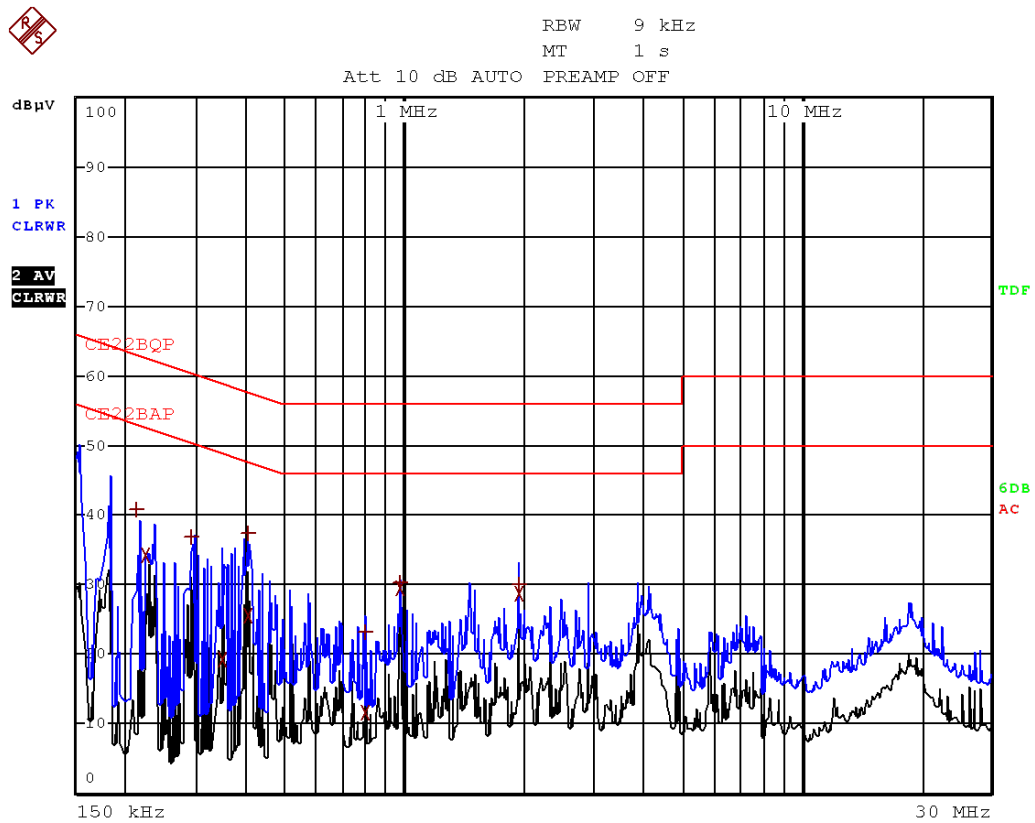

Date: 23.MAY.2011 14:01:11

Figure 8 Conducted Emission: NEUTRAL
Detectors: Peak, Quasi-peak, Average

4.4 Test Instrumentation Used, Conducted Measurement

Instrument	Manufacturer	Model	Serial No.	Last Calibration Date	Period
LISN	Fischer	FCC-LISN-2A	127	March 3, 2011	1 Year
EMI Receiver	RHODE & SCHWARZ	ESC17	100724	October 20, 2010	1 Year
Printer	HP	LaserJet 2200	JPKG19982	N/A	N/A

5. Average Factor Calculation Helical Antenna Transmitter

1. Burst duration = 4.06 msec
2. Time between bursts >100ms (minimum separation 14 seconds)
3. Average Factor = $20 \log \left[\frac{\text{Pulse duration}}{\text{Pulse period}} \times \frac{\text{burst duration}}{100\text{msec}} \times \text{Num of burst within 100msec} \right]$

Note: Pulse duration and pulse period were considered worst case always ON since unit transmits randomly.

$$\text{Average Factor} = 20 \log \left[1 \times \frac{4.06}{100} \times 1 \right] = -27.8\text{dB}$$

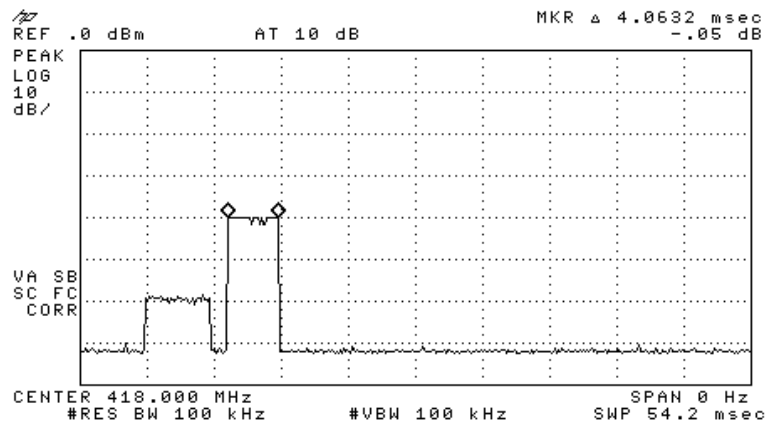

Figure 9. Burst Duration = 4.06 msec

5.1 Test Instrumentation Used

Instrument	Manufacturer	Model	Serial Number	Calibration	Period
EMI Receiver	HP	85422E	3906A00276	February 21, 2011	1 Year
RF Section	HP	85420E	3705A00248	August 1, 2010	1 Year
Antenna Bioconical	ARA	BCD 235/B	1041	March 23, 2011	1 year
Antenna Log Periodic	ARA	LPD-2010/A	1038	January 27, 2011	1 year
Antenna-Log Periodic	A.H.System	SAS-200/511	253	February 21, 2011	2 year
Antenna Mast	ARA	AAM-4A	1001	N/A	N/A
Turntable	ARA	ART-1001/4	1001	N/A	N/A
Mast & Table Controller	ARA	ACU-2/5	1001	N/A	N/A

6. Periodic Operation Helical Antenna Transmitter

6.1 Specification

F.C.C., Part 15, Subpart C, Section 15.231(a)

6.2 Requirements

Requirement	Rationale	Verdict
Continuous transmissions are not permitted.	N/A	Complies
A manually operated transmitter shall be deactivated within not more than 5 seconds after releasing the switch.	N/A	Complies
An automatically operated transmitter shall cease operation within 5 seconds after activation.	N/A	Complies
Periodic transmissions at regular predetermined intervals are not permitted.	N/A	Complies
Polling or supervised transmissions to determine system integrity of transmitter used in security or safety applications shall not exceed more than 2 seconds per hour.	See plots in Figure 11 to Figure 12	Complies

6.3 Results

JUDGEMENT: Passed

The EUT met the FCC Part 15, Subpart C, Section 15.231(a) specification requirements.

TEST PERSONNEL:

Tester Signature:  _____

Date: 29.06.11

Typed/Printed Name: A. Sharabi

Periodic Operation

E.U.T Description 2Track Base Unit
 Type SBU 2000LL
 Serial Number: Not Designated

Specification: F.C.C., Part 15, Subpart C, 15.231(a)

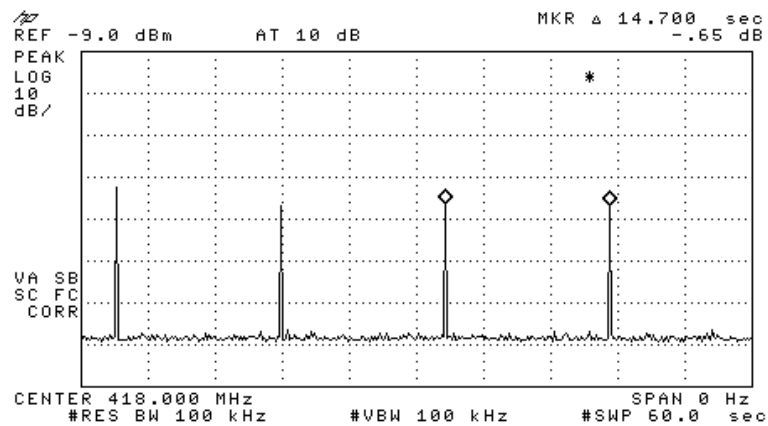

Figure 11. Signal Integrity as a Response to the Bracelet Minimum Transmission Every 20 seconds

Periodic Operation

E.U.T Description 2Track Base Unit
 Type SBU 2000LL
 Serial Number: Not Designated

Specification: F.C.C., Part 15, Subpart C, 15.231(a)

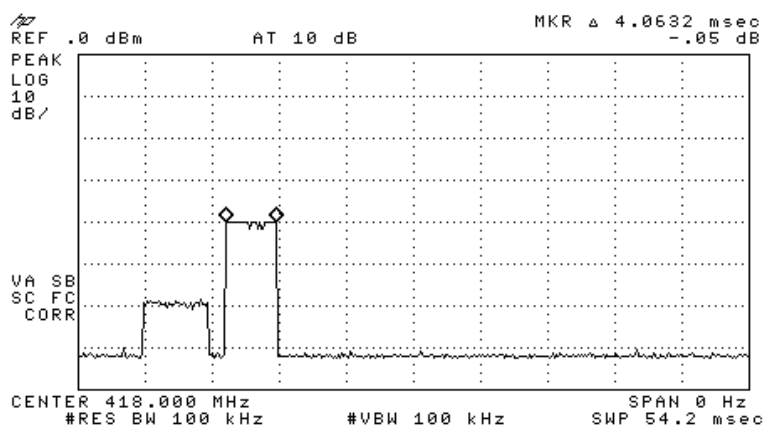

Figure 12. Signal Integrity burst as a Response to the Bracelet Transmission
 (Burst width 2.8msec x [3600/14] = 2.8 x 258 = 0.723 sec < 2 sec)

6.1 Test Instrumentation Used

Instrument	Manufacturer	Model	Serial Number	Calibration	Period
EMI Receiver	HP	85422E	3906A00276	November 24, 2010	1 Year
RF Section	HP	85420E	3705A00248	November 24, 2010	1 year

7. Field Strength of Fundamental Helical Antenna Transmitter

7.1 Test Specification

F.C.C., Part 15, Subpart C, Section 15.231(b)

7.2 Test Procedure

The E.U.T. operation mode and test set-up are as described in Section 3.

The E.U.T. was placed on a non-conductive table, 0.8 meters above the O.A.T.S. ground plane.

The EMI receiver was set to the E.U.T. Fundamental Frequency (418 MHz) and Peak Detection.

The turntable and antenna mast were adjusted for maximum level reading on the EMI receiver.

The measurement was performed for vertical and horizontal polarizations of the test antenna.

The average result is:

Peak Level(dB μ V/m) + E.U.T. Duty Cycle Factor, in 100msec time window (dB)

7.3 Measured Data

JUDGEMENT: Passed by 8.61 dB

The EUT met the FCC Part 15, Subpart C, Section 15.231(b) specification requirements.

The details of the highest emissions are given in Figure 13 to Figure 15.

TEST PERSONNEL:

Tester Signature: 

Date: 29.06.11

Typed/Printed Name: A. Sharabi

Field Strength of Fundamental

E.U.T Description 2Track Base Unit
Type SBU 2000LL
Serial Number: Not Designated

Specification: F.C.C., Part 15, Subpart C, 15.231(b)

Antenna Polarization: Horizontal/Vertical

Test Distance: 3 meters

Detector: Peak

Freq.	Pol.	Peak Reading	Average Factor	AVG Result	AVG Specification	Margin
(MHz)	V/H	(dB μ V/m)	(dB)	(dB μ V/m)	(dB μ V/m)	(dB)
418.00	H	99.47	-27.8	71.67	80.28	-8.61
418.00	V	91.85	-27.8	64.05	80.28	-16.23

Figure 13. Field Strength of Fundamental. Antenna Polarization: HORIZONTAL/VERTICAL.

Notes:

1. Margin refers to the test results obtained minus specified requirement; thus a positive number indicates failure, and a negative result indicates that the product passes the test.
2. "Peak Reading." (dB μ V/m) included the "Correction Factors".
3. "Correction Factors" (dB) = Test Antenna Correction Factor(dB) + Cable Loss.
4. "Average Result" (dB μ V/m)= Peak Reading (dB μ V/m) + Average Factor (dB)

Field Strength of Fundamental

E.U.T Description 2Track Base Unit
 Type SBU 2000LL
 Serial Number: Not Designated

Specification: F.C.C., Part 15, Subpart C, 15.231(b)

Antenna Polarization: Horizontal

Test Distance: 3 meters

Detector: Peak

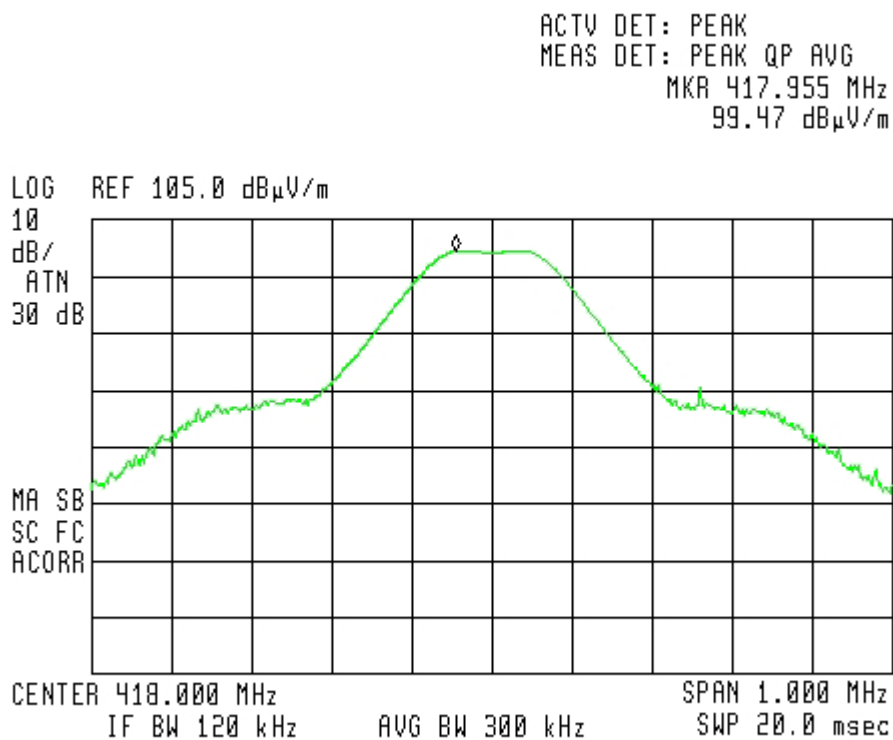

Figure 14. Field Strength of Fundamental. Antenna Polarization: HORIZONTAL.

Field Strength of Fundamental

E.U.T Description 2Track Base Unit
 Type SBU 2000LL
 Serial Number: Not Designated

Specification: F.C.C., Part 15, Subpart C, 15.231(b)

Antenna Polarization: Vertical

Test Distance: 3 meters

Detector: Peak

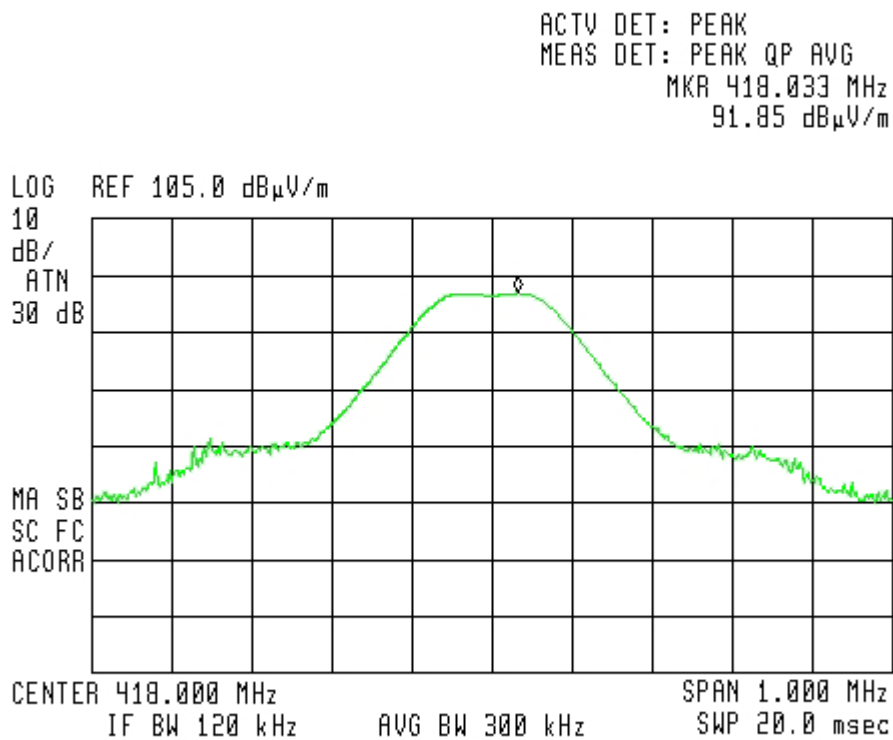

Figure 15. Field Strength of Fundamental. Antenna Polarization: VERTICAL.

7.4 Test Instrumentation Used, Field Strength of Fundamental

Instrument	Manufacturer	Model	Serial Number	Calibration	Period
EMI Receiver	HP	85422E	3906A00276	November 24, 2010	1 year
RF Section	HP	85420E	3705A00248	November 24, 2010	1 year
Antenna Log Periodic	ARA	LPD-2010/A	1038	March 23, 2011	1 year
Antenna Mast	ARA	AAM-4A	1001	N/A	N/A
Turntable	ARA	ART-1001/4	1001	N/A	N/A
Mast & Table Controller	ARA	ACU-2/5	1001	N/A	N/A
Printer	HP	LaserJet 2200	JPKG19982	N/A	N/A

8. Radiated Emission, 9 kHz – 30 MHz Helical Antenna Transmitter

8.1 Test Specification

9 kHz-30 MHz, FCC, Part 15, Subpart C, Section 209

8.2 Test Procedure

The E.U.T. operation mode and test set-up are as described in Section 3.

A preliminary measurement to characterize the E.U.T was performed inside the shielded room at a distance of 3 meters, using peak detection mode and broadband antennas. The preliminary measurements produced a list of the highest emissions. The E.U.T was then transferred to the open site, and placed on a remote-controlled turntable. The E.U.T was placed on a non-metallic table, 0.8 meters above the ground. The configuration tested is shown in Figure 3.1.

The frequency range 9 kHz-30 MHz was scanned.

The emissions were measured using a computerized EMI receiver complying to CISPR 16 requirements. The specification limits and applicable correction factors are loaded to the receiver via a 3.5" floppy disk.

In the frequency range 9 kHz-30MHz, the loop antenna was rotated on its vertical axis. The antenna height (center of loop) was 1 meter at a distance of 3 meters.

The E.U.T. was operated at the frequency of 418 MHz. This frequency was measured using a peak detector.

8.3 Measured Data

JUDGEMENT: Passed

The EUT was tested and it met the requirements of the FCC Part 15, Subpart C, specification.

No signals were detected in the frequency range of 9 kHz – 30 MHz.

TEST PERSONNEL:

Tester Signature: 

Date: 29.06.11

Typed/Printed Name: A. Sharabi

8.4 Test Instrumentation Used, Radiated Measurements

Instrument	Manufacturer	Model	Serial Number	Calibration	Period
EMI Receiver	HP	85422E	3906A00276	November 24, 2010	1 year
RF Section	HP	85420E	3705A00248	November 24, 2010	1 year
Active Loop Antenna	EMCO	6502	9506-2950	October 19, 2010	1 year
Antenna Mast	ARA	AAM-4A	1001	N/A	N/A
Turntable	ARA	ART-1001/4	1001	N/A	N/A
Mast & Table Controller	ARA	ACU-2/5	1001	N/A	N/A

8.5 Field Strength Calculation

The field strength is calculated directly by the EMI Receiver software, and a "Correction Factors" data disk, using the following equation:

$$FS = RA + AF + CF$$

FS: Field Strength [dB μ v/m]

RA: Receiver Amplitude [dB μ v]

AF: Receiving Antenna Correction Factor [dB/m]

CF: Cable Attenuation Factor [dB]

Example: FS = 30.7 dB μ V (RA) + 14.0 dB (AF) + 0.9 dB (CF) = 45.6 dB μ V

No external pre-amplifiers are used.

9. Spurious Radiated Emission Helical Antenna Transmitter

9.1 Test Specification

30 - 4500 MHz, F.C.C., Part 15, Subpart C

9.2 Test Procedure

The E.U.T. operation mode and test set-up are as described in Section 3. See Section 3.1 Justification of the System Test Configuration concerning the E.U.T. orientation for this test.

A preliminary measurement to characterize the E.U.T was performed inside the shielded room at a distance of 3 meters, using peak detection mode and broadband antennas. The preliminary measurements produced a list of the highest emissions. The E.U.T was then transferred to the open site, and placed on a remote-controlled turntable. The E.U.T was placed on a non-metallic table, 0.8 meters above the ground. The configuration tested is shown in Figure 1. The signals from the list of the highest emissions were verified and the list was updated accordingly.

The levels of the emissions within the frequency ranges of the restricted bands (Section 15.205 of FCC Part 15) were compared to the limits of the table in Section 15.209 (a), General Requirements.

The emissions were measured using a computerized EMI receiver complying to CISPR 16 requirements. The specification limits and applicable correction factors are loaded to the receiver via a 3.5" floppy disk.

In the frequency range 2.9 – 4.5 GHz, a spectrum analyzer including a low noise amplifier was used. The test distance was 3 meters. During peak measurements, the I.F. bandwidth was 1 MHz, and video bandwidth 3 MHz. During average measurements, the I.F. bandwidth was 1 MHz and video bandwidth was 100 Hz.

The readings were maximized by adjusting the antenna height between 1-4 meters, the turntable azimuth between 0-360°, and the antenna polarization. Verification of the E.U.T emissions was based on the following methods: turning the E.U.T on and off; using a frequency span less than 10 MHz; observation of the signal level during turntable rotation. (Background noise is not affected by the rotation of the E.U.T.)

The emissions were measured at a distance of 3 meters.

9.3 **Test Data**

JUDGEMENT: Passed by 42.68dB

The EUT met the requirements of the F.C.C. Part 15, Subpart C, specification.

The margin between the emission level and the specification limit was 42.68dB in the worst case at the frequency of 1254MHz, horizontal polarization.

TEST PERSONNEL:

Tester Signature: _____

Date: 29.06.11

Typed/Printed Name: A. Sharabi

Radiated Emission

E.U.T Description 2Track Base Unit
 Type SBU 2000LL
 Serial Number: Not Designated

Specification: FCC Part 15, Subpart C

Antenna Polarization: Horizontal/Vertical Frequency range: 30 MHz to 4500 MHz
 Antenna: 3 meters distance Detector: Peak

Frequency (MHz)	Antenna Polarity (H/V)	Peak Reading (dB μ V/m)	Average Factor (dB μ V/m)	Average Result (dB μ V/m)	Average Specification (dB μ V/m)	Margin (dB)
1254.0	H	45.4	-27.8	17.6	60.28	-42.68
1254.0	V	44.0	-27.8	16.72	60.28	-43.56

Figure 16. Radiated Emission.

Note: Margin refers to the test results obtained minus specified requirement; thus a positive number indicates failure, and a negative result indicates that the product passes the test.

9.4 Test Instrumentation Used, Radiated Measurements

Instrument	Manufacturer	Model	Serial Number	Calibration	Period
EMI Receiver	HP	85422E	3906A00276	November 24, 2010	1 year
RF Section	HP	85420E	3705A00248	November 24, 2010	1 year
Low Noise Amplifier	DBS MICROWAVE	LNA-DBS- 0411N313	013	November 05, 2010	1 Year
Spectrum Analyzer	HP	8592L	3826A01204	February 21, 2010	1 Year
Antenna Bioconical	ARA	BCD 235/B	1041	August 01, 2010	1 year
Antenna Log Periodic	ARA	LPD-2010/A	1038	March 23, 2011	1 year
Antenna-Log Periodic	A.H.System	SAS-200/511	253	January 27, 2011	2 year
Antenna Mast	ARA	AAM-4A	1001	N/A	N/A
Turntable	ARA	ART-1001/4	1001	N/A	N/A
Mast & Table Controller	ARA	ACU-2/5	1001	N/A	N/A
Printer	HP	LaserJet 2200	JPKG19982	N/A	N/A

10. Bandwidth Helical Antenna Transmitter

10.1 Test procedure

The transmitter unit operated with normal modulation. The spectrum analyzer was set to 120 kHz resolution BW and center frequency of the transmitter fundamental. The spectrum bandwidth of the transmitter unit was measured and recorded. The BW was measured at 20 dBc points.

The EUT was set up as shown in Figure 1, and its proper operation was checked. The transmitter occupied bandwidth was measured with the EMI receiver as frequency delta between reference points on the modulation envelope.

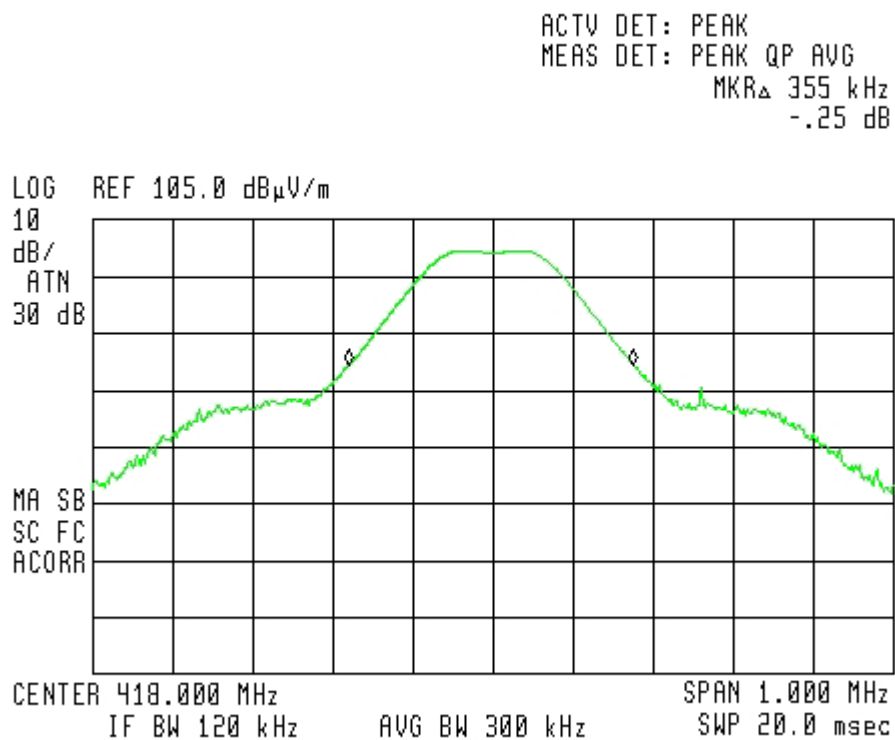

Figure 17 Bandwidth

10.2 Results table

E.U.T Description: 2Track Base Unit
 Model: SBU 2000LL
 Serial Number: Not Designated
 Specification: F.C.C. Part 15, Subpart C: (15.231(c))

Bandwidth Reading (kHz)	Specification (1) (kHz)	Margin (kHz)
355	1045	-690

Figure 18 Bandwidth

JUDGEMENT: Passed by 690 kHz

TEST PERSONNEL:

Tester Signature: _____

Date: 29.06.11

Typed/Printed Name: A. Sharabi

(1) 0.25% of the E.U.T. fundamental frequency, Section 15.231(c).

10.3 Test Equipment Used.

Bandwidth

Instrument	Manufacturer	Model	Serial Number	Calibration	Period
EMI Receiver	HP	85422E	3906A00276	November 24, 2010	1 year
RF Section	HP	85420E	3705A00248	November 24, 2010	1 year
Antenna Log Periodic	ARA	LPD-2010/A	1038	March 23, 2011	1 year
Antenna Mast	ARA	AAM-4A	1001	N/A	N/A
Turntable	ARA	ART-1001/4	1001	N/A	N/A
Mast & Table Controller	ARA	ACU-2/5	1001	N/A	N/A
Printer	HP	LaserJet 2200	JPKG19982	N/A	N/A

Figure 19 Test Equipment Used

11. Average Factor Calculation F Antenna Transmitter

1. Burst duration = 4.06 msec
2. Time between bursts >100ms (minimum separation 14 seconds)
3. Average Factor = $20 \log \left[\frac{\text{Pulse duration}}{\text{Pulse period}} \times \frac{\text{burst duration}}{100\text{msec}} \times \text{Num of burst within 100msec} \right]$

Note: Pulse duration and pulse period were considered worst case always ON since unit transmits randomly.

$$\text{Average Factor} = 20 \log \left[1 \times \frac{4.06}{100} \times 1 \right] = -27.8\text{dB}$$

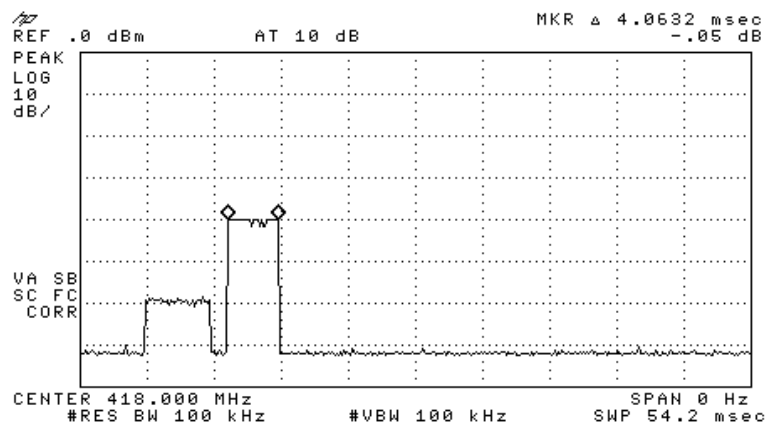

Figure 20. Burst Duration = 4.06 msec

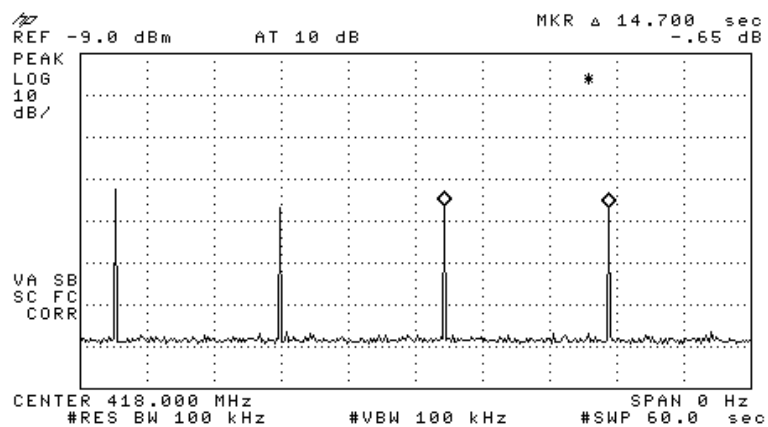

Figure 21. Time Between Bursts > 100 ms (Plot Sweep 60 sec)

11.1 Test Instrumentation Used

Instrument	Manufacturer	Model	Serial Number	Calibration	Period
EMI Receiver	HP	85422E	3906A00276	November 24, 2010	1 Year
RF Section	HP	85420E	3705A00248	November 24, 2010	1 Year
Antenna Bioconical	ARA	BCD 235/B	1041	August 1, 2010	1 year
Antenna Log Periodic	ARA	LPD-2010/A	1038	March 23, 2011	1 year
Antenna-Log Periodic	A.H.System	SAS-200/511	253	January 27, 2011	2 year
Antenna Mast	ARA	AAM-4A	1001	N/A	N/A
Turntable	ARA	ART-1001/4	1001	N/A	N/A
Mast & Table Controller	ARA	ACU-2/5	1001	N/A	N/A

12. Periodic Operation F Antenna Transmitter

12.1 Specification

F.C.C., Part 15, Subpart C, Section 15.231(a)

12.2 Requirements

Requirement	Rationale	Verdict
Continuous transmissions are not permitted.	N/A	Complies
A manually operated transmitter shall be deactivated within not more than 5 seconds after releasing the switch.	N/A	Complies
An automatically operated transmitter shall cease operation within 5 seconds after activation.	N/A	Complies
Periodic transmissions at regular predetermined intervals are not permitted.	N/A	Complies
Polling or supervised transmissions to determine system integrity of transmitter used in security or safety applications shall not exceed more than 2 seconds per hour.	See plots in Figure 11 to Figure 12	Complies

12.3 Results

JUDGEMENT: Passed

The EUT met the FCC Part 15, Subpart C, Section 15.231(a) specification requirements.

TEST PERSONNEL:

Tester Signature:  _____

Date: 29.06.11

Typed/Printed Name: A. Sharabi

Periodic Operation

E.U.T Description 2Track Base Unit
 Type SBU 2000LL
 Serial Number: Not Designated

Specification: F.C.C., Part 15, Subpart C, 15.231(a)

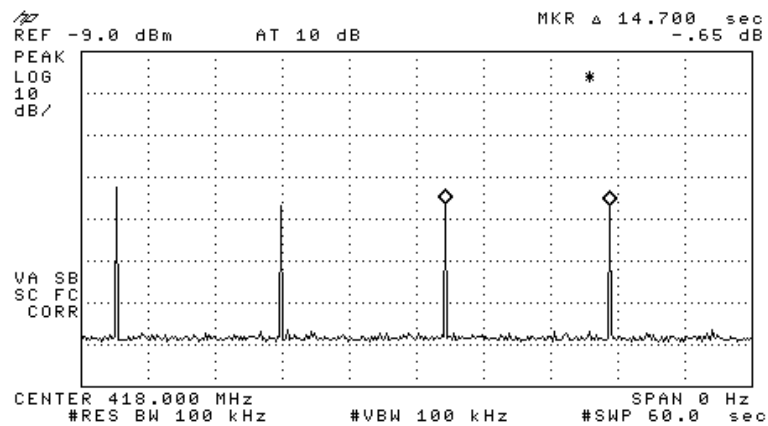

Figure 22. Signal Integrity as a Response to the Bracelet Minimum Transmission Every 20 seconds

Periodic Operation

E.U.T Description 2Track Base Unit
 Type SBU 2000LL
 Serial Number: Not Designated

Specification: F.C.C., Part 15, Subpart C, 15.231(a)

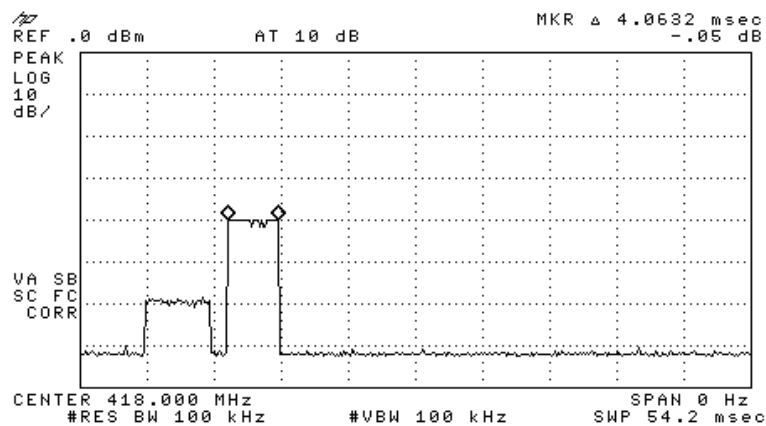

Figure 23. Signal Integrity burst as a Response to the Bracelet Transmission
(Burst width 2.8msec x [3600/14] = 2.8 x 258 = 0.723 sec < 2 sec)

12.4 Test Instrumentation Used

Instrument	Manufacturer	Model	Serial Number	Calibration	Period
EMI Receiver	HP	85422E	3906A00276	November 24, 2010	1 Year
RF Section	HP	85420E	3705A00248	November 24, 2010	1 year

13. Field Strength of Fundamental F Antenna Transmitter

13.1 Test Specification

F.C.C., Part 15, Subpart C, Section 15.231(b)

13.2 Test Procedure

The E.U.T. operation mode and test set-up are as described in Section 3.

The E.U.T. was placed on a non-conductive table, 0.8 meters above the O.A.T.S. ground plane.

The EMI receiver was set to the E.U.T. Fundamental Frequency (418 MHz) and Peak Detection.

The turntable and antenna mast were adjusted for maximum level reading on the EMI receiver.

The measurement was performed for vertical and horizontal polarizations of the test antenna.

The average result is:

Peak Level(dB μ V/m) + E.U.T. Duty Cycle Factor, in 100msec time window (dB)

13.3 Measured Data

JUDGEMENT: Passed by 8.73dB

The EUT met the FCC Part 15, Subpart C, Section 15.231(b) specification requirements.

The details of the highest emissions are given in Figure 13 to Figure 15.

TEST PERSONNEL:

Tester Signature: _____

Date: 29.06.11

Typed/Printed Name: A. Sharabi

Field Strength of Fundamental

E.U.T Description 2Track Base Unit
 Type SBU 2000LL
 Serial Number: Not Designated

Specification: F.C.C., Part 15, Subpart C, 15.231(b)

Antenna Polarization: Horizontal/Vertical

Test Distance: 3 meters

Detector: Peak

Freq.	Pol.	Peak Reading	Average Factor	AVG Result	AVG Specification	Margin
(MHz)	V/H	(dB μ V/m)	(dB)	(dB μ V/m)	(dB μ V/m)	(dB)
418.0	H	99.35	-27.8	71.55	80.28	-8.73
418.0	V	91.40	-27.8	63.6	80.28	-16.68

Figure 24. Field Strength of Fundamental.

Notes:

1. Margin refers to the test results obtained minus specified requirement; thus a positive number indicates failure, and a negative result indicates that the product passes the test.
2. "Peak Reading." (dB μ V/m) included the "Correction Factors".
3. "Correction Factors" (dB) = Test Antenna Correction Factor(dB) + Cable Loss.
4. "Average Result" (dB μ V/m)=Peak Reading (dB μ V/m) + Correction Factor (dB)

Field Strength of Fundamental

E.U.T Description 2Track Base Unit
 Type SBU 2000LL
 Serial Number: Not Designated

Specification: F.C.C., Part 15, Subpart C, 15.231(b)

Antenna Polarization: Horizontal

Test Distance: 3 meters

Detector: Peak

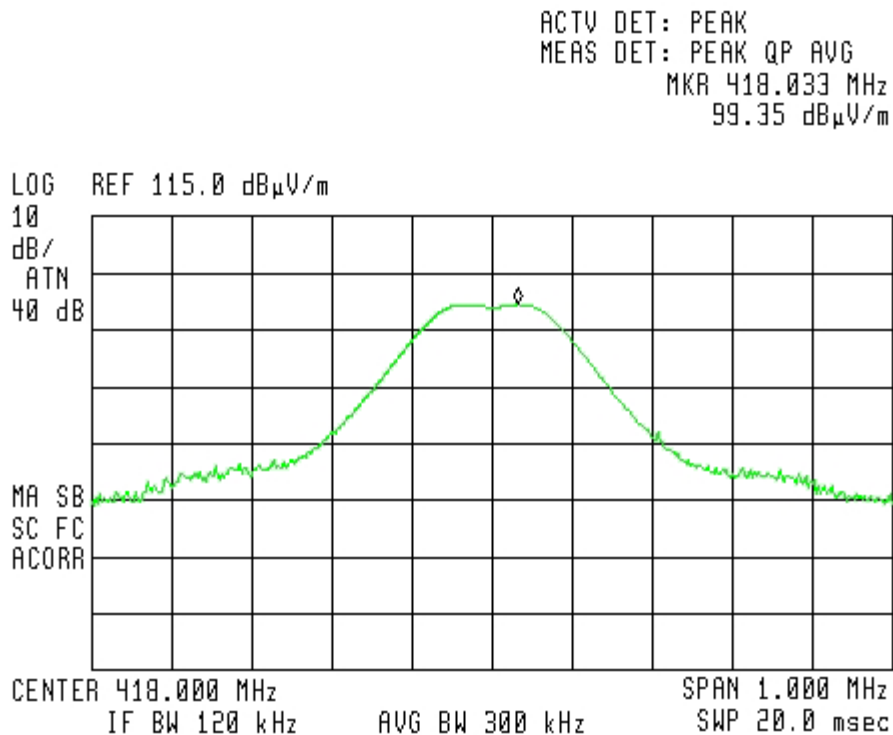

Figure 25. Field Strength of Fundamental. Antenna Polarization: HORIZONTAL.

Field Strength of Fundamental

E.U.T Description 2Track Base Unit
 Type SBU 2000LL
 Serial Number: Not Designated

Specification: F.C.C., Part 15, Subpart C, 15.231(b)

Antenna Polarization: Vertical

Test Distance: 3 meters

Detector: Peak

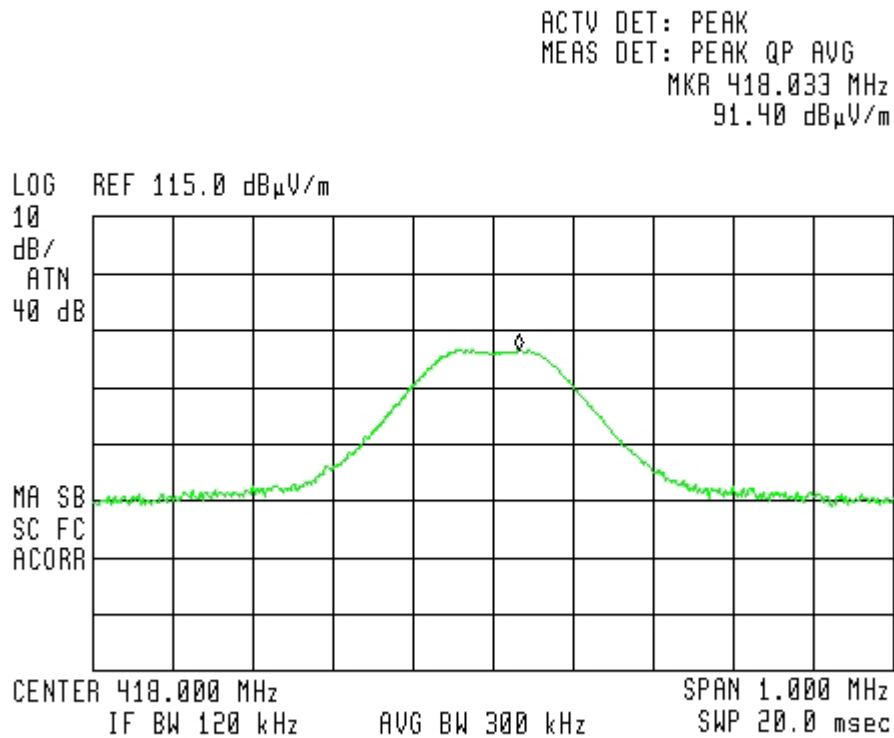

Figure 26. Field Strength of Fundamental. Antenna Polarization: VERTICAL.

13.4 Test Instrumentation Used, Field Strength of Fundamental

Instrument	Manufacturer	Model	Serial Number	Calibration	Period
EMI Receiver	HP	85422E	3906A00276	November 24, 2010	1 year
RF Section	HP	85420E	3705A00248	November 24, 2010	1 year
Antenna Log Periodic	ARA	LPD-2010/A	1038	March 23, 2011	1 year
Antenna Mast	ARA	AAM-4A	1001	N/A	N/A
Turntable	ARA	ART-1001/4	1001	N/A	N/A
Mast & Table Controller	ARA	ACU-2/5	1001	N/A	N/A
Printer	HP	LaserJet 2200	JPKG19982	N/A	N/A

14. Radiated Emission, 9 kHz – 30 MHz F Antenna Transmitter

14.1 Test Specification

9 kHz-30 MHz, FCC, Part 15, Subpart C, Section 209

14.2 Test Procedure

The E.U.T. operation mode and test set-up are as described in Section 3.

A preliminary measurement to characterize the E.U.T was performed inside the shielded room at a distance of 3 meters, using peak detection mode and broadband antennas. The preliminary measurements produced a list of the highest emissions. The E.U.T was then transferred to the open site, and placed on a remote-controlled turntable. The E.U.T was placed on a non-metallic table, 0.8 meters above the ground. The configuration tested is shown in Figure 3.1.

The frequency range 9 kHz-30 MHz was scanned.

The emissions were measured using a computerized EMI receiver complying to CISPR 16 requirements. The specification limits and applicable correction factors are loaded to the receiver via a 3.5" floppy disk.

In the frequency range 9 kHz-30MHz, the loop antenna was rotated on its vertical axis. The antenna height (center of loop) was 1 meter at a distance of 3 meters.

The E.U.T. was operated at the frequency of 418 MHz. This frequency was measured using a peak detector.

14.3 Measured Data

JUDGEMENT: Passed

The EUT was tested and it met the requirements of the FCC Part 15, Subpart C, specification.

No signals were detected in the frequency range of 9 kHz – 30 MHz.

TEST PERSONNEL:

Tester Signature: 

Date: 29.06.11

Typed/Printed Name: A. Sharabi

14.4 Test Instrumentation Used, Radiated Measurements

Instrument	Manufacturer	Model	Serial Number	Calibration	Period
EMI Receiver	HP	85422E	3906A00276	November 24, 2010	1 year
RF Section	HP	85420E	3705A00248	November 24, 2010	1 year
Active Loop Antenna	EMCO	6502	9506-2950	October 19, 2010	1 year
Antenna Mast	ARA	AAM-4A	1001	N/A	N/A
Turntable	ARA	ART-1001/4	1001	N/A	N/A
Mast & Table Controller	ARA	ACU-2/5	1001	N/A	N/A

14.5 Field Strength Calculation

The field strength is calculated directly by the EMI Receiver software, and a "Correction Factors" data disk, using the following equation:

$$FS = RA + AF + CF$$

FS: Field Strength [dB μ v/m]

RA: Receiver Amplitude [dB μ v]

AF: Receiving Antenna Correction Factor [dB/m]

CF: Cable Attenuation Factor [dB]

Example: FS = 30.7 dB μ V (RA) + 14.0 dB (AF) + 0.9 dB (CF) = 45.6 dB μ V

No external pre-amplifiers are used.

15. Spurious Radiated Emission Helical Antenna Transmitter

15.1 Test Specification

30 - 4500 MHz, F.C.C., Part 15, Subpart C

15.2 Test Procedure

The E.U.T. operation mode and test set-up are as described in Section 3. See Section 3.1 Justification of the System Test Configuration concerning the E.U.T. orientation for this test.

A preliminary measurement to characterize the E.U.T was performed inside the shielded room at a distance of 3 meters, using peak detection mode and broadband antennas. The preliminary measurements produced a list of the highest emissions. The E.U.T was then transferred to the open site, and placed on a remote-controlled turntable. The E.U.T was placed on a non-metallic table, 0.8 meters above the ground. The configuration tested is shown in Figure 1. The signals from the list of the highest emissions were verified and the list was updated accordingly.

The levels of the emissions within the frequency ranges of the restricted bands (Section 15.205 of FCC Part 15) were compared to the limits of the table in Section 15.209 (a), General Requirements.

The emissions were measured using a computerized EMI receiver complying to CISPR 16 requirements. The specification limits and applicable correction factors are loaded to the receiver via a 3.5" floppy disk.

In the frequency range 2.9 – 4.5 GHz, a spectrum analyzer including a low noise amplifier was used. The test distance was 3 meters. During peak measurements, the I.F. bandwidth was 1 MHz, and video bandwidth 3 MHz. During average measurements, the I.F. bandwidth was 1 MHz and video bandwidth was 100 Hz.

The readings were maximized by adjusting the antenna height between 1-4 meters, the turntable azimuth between 0-360°, and the antenna polarization. Verification of the E.U.T emissions was based on the following methods: turning the E.U.T on and off; using a frequency span less than 10 MHz; observation of the signal level during turntable rotation. (Background noise is not affected by the rotation of the E.U.T.)

The emissions were measured at a distance of 3 meters.

15.3 Test Data

JUDGEMENT: Passed by 40.98dB

The EUT met the requirements of the F.C.C. Part 15, Subpart C, specification.
The margin between the emission level and the specification limit was 40.98dB
in the worst case at the frequency of 1254MHz, horizontal and 42.18 db in
vertical polarizations.

TEST PERSONNEL:

Tester Signature:  _____

Date: 29.06.11

Typed/Printed Name: A. Sharabi

Radiated Emission

E.U.T Description 2Track Base Unit
 Type SBU 2000LL
 Serial Number: Not Designated

Specification: FCC Part 15, Subpart C

Antenna Polarization: Horizontal/Vertical Frequency range: 30 MHz to 4500 MHz
 Antenna: 3 meters distance Detector: Peak

Frequency (MHz)	Antenna Polarity (H/V)	Peak Reading (dB μ V/m)	Average Factor (dB μ V/m)	Average Result (dB μ V/m)	Specification (dB μ V/m)	Margin (dB)
1254.0	H	47.1	-27.8	19.3	60.28	-40.98
1254.0	V	45.9	-27.8	18.1	60.28	-42.18

Figure 27. Radiated Emission.

Note: Margin refers to the test results obtained minus specified requirement; thus a positive number indicates failure, and a negative result indicates that the product passes the test.

15.4 Test Instrumentation Used, Radiated Measurements

Instrument	Manufacturer	Model	Serial Number	Calibration	Period
EMI Receiver	HP	85422E	3906A00276	November 24, 2010	1 year
RF Section	HP	85420E	3705A00248	November 24, 2010	1 year
Low Noise Amplifier	DBS MICROWAVE	LNA-DBS- 0411N313	013	November 05, 2010	1 Year
Spectrum Analyzer	HP	8592L	3826A01204	February 21, 2010	1 Year
Antenna Bioconical	ARA	BCD 235/B	1041	August 01, 2010	1 year
Antenna Log Periodic	ARA	LPD-2010/A	1038	March 23, 2011	1 year
Antenna-Log Periodic	A.H.System	SAS-200/511	253	January 27, 2011	2 year
Antenna Mast	ARA	AAM-4A	1001	N/A	N/A
Turntable	ARA	ART-1001/4	1001	N/A	N/A
Mast & Table Controller	ARA	ACU-2/5	1001	N/A	N/A
Printer	HP	LaserJet 2200	JPKG19982	N/A	N/A

16. Bandwidth Helical Antenna Transmitter

16.1 Test procedure

The transmitter unit operated with normal modulation. The spectrum analyzer was set to 120 kHz resolution BW and center frequency of the transmitter fundamental. The spectrum bandwidth of the transmitter unit was measured and recorded. The BW was measured at 20 dBc points.

The EUT was set up as shown in Figure 1, and its proper operation was checked. The transmitter occupied bandwidth was measured with the EMI receiver as frequency delta between reference points on the modulation envelope.

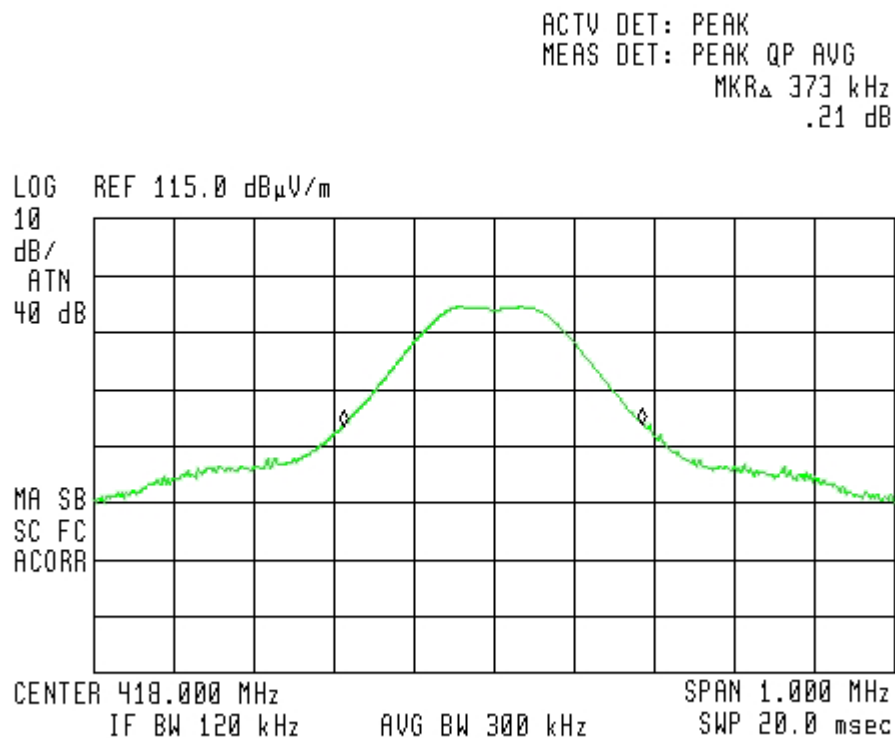

Figure 28 Bandwidth

16.2 Results table

E.U.T Description: 2Track Base Unit
 Model: SBU 2000LL
 Serial Number: Not Designated
 Specification: F.C.C. Part 15, Subpart C: (15.231(c))

Bandwidth Reading (kHz)	Specification (1) (kHz)	Margin (kHz)
373	1045	-672

Figure 29 Bandwidth

JUDGEMENT: Passed by 672 kHz

TEST PERSONNEL:

Tester Signature: _____ 

Date: 29.06.11

Typed/Printed Name: A. Sharabi

(1) 0.25% of the E.U.T. fundamental frequency, Section 15.231(c).

16.3 Test Equipment Used.

Bandwidth

Instrument	Manufacturer	Model	Serial Number	Calibration	Period
EMI Receiver	HP	85422E	3906A00276	November 24, 2010	1 year
RF Section	HP	85420E	3705A00248	November 24, 2010	1 year
Antenna Log Periodic	ARA	LPD-2010/A	1038	March 23, 2011	1 year
Antenna Mast	ARA	AAM-4A	1001	N/A	N/A
Turntable	ARA	ART-1001/4	1001	N/A	N/A
Mast & Table Controller	ARA	ACU-2/5	1001	N/A	N/A
Printer	HP	LaserJet 2200	JPKG19982	N/A	N/A

Figure 30 Test Equipment Used

17. APPENDIX A - CORRECTION FACTORS

17.1 Correction factors for CABLE from EMI receiver to test antenna at 3 meter range.

FREQUENCY (MHz)	CORRECTION FACTOR (dB)	FREQUENCY (MHz)	CORRECTION FACTOR (dB)
10.0	0.3	1200.0	7.3
20.0	0.6	1400.0	7.8
30.0	0.8	1600.0	8.4
40.0	0.9	1800.0	9.1
50.0	1.1	2000.0	9.9
60.0	1.2	2300.0	11.2
70.0	1.3	2600.0	12.2
80.0	1.4	2900.0	13.0
90.0	1.6		
100.0	1.7		
150.0	2.0		
200.0	2.3		
250.0	2.7		
300.0	3.1		
350.0	3.4		
400.0	3.7		
450.0	4.0		
500.0	4.3		
600.0	4.7		
700.0	5.3		
800.0	5.9		
900.0	6.3		
1000.0	6.7		

NOTES:

1. The cable type is RG-214.
2. The overall length of the cable is 27 meters.
3. The above data is located in file 27MO3MO.CBL on the disk marked "Radiated Emission Tests EMI Receiver".

17.2 Correction factors for CABLE
from EMI receiver
to test antenna
at 3 meter range.

FREQUENCY (GHz)	CORRECTION FACTOR (dB)
1.0	1.2
2.0	1.6
3.0	2.0
4.0	2.4
5.0	3.0
6.0	3.4
7.0	3.8
8.0	4.2
9.0	4.6
10.0	5.0
12.0	5.8

NOTES:

- 1. The cable type is RG-8.*
- 2. The overall length of the cable is 10 meters.*

17.3 Correction factors for CABLE
from spectrum analyzer
to test antenna above 2.9 GHz

FREQUENCY (GHz)	CORRECTION FACTOR (dB)	FREQUENCY (GHz)	CORRECTION FACTOR (dB)
1.0	1.9	14.0	9.1
2.0	2.7	15.0	9.5
3.0	3.5	16.0	9.9
4.0	4.2	17.0	10.2
5.0	4.9	18.0	10.4
6.0	5.5	19.0	10.7
7.0	6.0	20.0	10.9
8.0	6.5	21.0	11.2
9.0	7.0	22.0	11.6
10.0	7.5	23.0	11.9
11.0	7.9	24.0	12.3
12.0	8.3	25.0	12.6
13.0	8.7	26.0	13.0

NOTES:

- 1. The cable type is SUCOFLEX 104 E manufactured by SUHNER.*
- 2. The cable is used for measurements above 2.9 GHz.*
- 3. The overall length of the cable is 10 meters.*

12.6 Correction factors for LOG PERIODIC ANTENNA

Type LPD 2010/A at 3 and 10 meter ranges.

Distance of 3 meters

FREQUENCY (MHz)	AFE (dB/m)
200.0	9.1
250.0	10.2
300.0	12.5
400.0	15.4
500.0	16.1
600.0	19.2
700.0	19.4
800.0	19.9
900.0	21.2
1000.0	23.5

Distance of 10 meters

FREQUENCY (MHz)	AFE (dB/m)
200.0	9.0
250.0	10.1
300.0	11.8
400.0	15.3
500.0	15.6
600.0	18.7
700.0	19.1
800.0	20.2
900.0	21.1
1000.0	23.2

NOTES:

1. Antenna serial number is 1038.
2. The above lists are located in file number 38M30.ANT for a 3 meter range,
and file number 38M100.ANT for a 10 meter range.
3. The files mentioned above are located on the disk marked "Radiated Emission
Test EMI Receiver".

17.4 Correction factors for

LOG PERIODIC ANTENNA

**Type SAS-200/511
at 3 meter range.**

FREQUENCY (GHz)	ANTENNA FACTOR (dB)
1.0	24.9
1.5	27.8
2.0	29.9
2.5	31.2
3.0	32.8
3.5	33.6
4.0	34.3
4.5	35.2
5.0	36.2
5.5	36.7
6.0	37.2
6.5	38.1

FREQUENCY (GHz)	ANTENNA FACTOR (dB)
7.0	38.6
7.5	39.2
8.0	39.9
8.5	40.4
9.0	40.8
9.5	41.1
10.0	41.7
10.5	42.4
11.0	42.5
11.5	43.1
12.0	43.4
12.5	44.4
13.0	44.6

NOTES:

1. Antenna serial number is 253.
2. The above lists are located in file number SAS3M0.ANT for a 3 meter range.
3. The files mentioned above are located on the disk marked "Antenna Factors".

**17.5 Correction factors for BICONICAL ANTENNA
Type BCD-235/B,
at 3 meter range**

FREQUENCY (MHz)	AFE (dB/m)
20.0	19.4
30.0	14.8
40.0	11.9
50.0	10.2
60.0	9.1
70.0	8.5
80.0	8.9
90.0	9.6
100.0	10.3
110.0	11.0
120.0	11.5
130.0	11.7
140.0	12.1
150.0	12.6
160.0	12.8
170.0	13.0
180.0	13.5
190.0	14.0
200.0	14.8
210.0	15.3
220.0	15.8
230.0	16.2
240.0	16.6
250.0	17.6
260.0	18.2
270.0	18.4
280.0	18.7
290.0	19.2
300.0	19.9
310	20.7
320	21.9
330	23.4
340	25.1
350	27.0

NOTES:

1. Antenna serial number is 1041.
2. The above list is located in file 19BC10M1.ANT on the disk marked "Radiated Emissions Tests EMI Receiver".

17.6 Correction factors for ACTIVE LOOP ANTENNA

Model 6502

S/N 9506-2950

FREQUENCY (MHz)	Magnetic Antenna Factor (dB)	Electric Antenna Factor (dB)
.009	-35.1	16.4
.010	-35.7	15.8
.020	-38.5	13.0
.050	-39.6	11.9
.075	-39.8	11.8
.100	-40.0	11.6
.150	-40.0	11.5
.250	-40.0	11.6
.500	-40.0	11.5
.750	-40.1	11.5
1.000	-39.9	11.7
2.000	-39.5	12.0
3.000	-39.4	12.1
4.000	-39.7	11.9
5.000	-39.7	11.8
10.000	40.2	11.3
15.000	-40.7	10.8
20.000	-40.5	11.0
25.000	-41.3	10.2
30.000	42.3	9.2