

REV	Δ	Description	Sheet Effected	Date	Drawn	Checked
A				02.02.06	D.Lanuel	S.Cohen

EMC Laboratory

MEMS-3000

FCCID: LSQ-MEMS-3000
Manufactured by

EMC Test Report

According FCC Part 15 Requirements

June 2006



	Function/Title	Name	Signature	Date
Prepared by	Test Engineer	D.Lanuel		02.02.06
Checked by	Test Engineer	D.Lanuel		02.02.06
Approved by	EMC Lab. Manager	S.Cohen		02.02.06

Table of Contents

Para		Page
1	ADMINISTRATIVE DATA	3
2	GENERAL INFORMATION	3
3	TEST SUMMARY AND SIGNATURES.	4
4	E.U.T INFORMATION.....	5
5	RADIATED EMISSION PART 15.109- (FOR RX MODE).....	6
6	CONDUCTED EMISSION, AC POWER LEADS ACCORDING TO FCC 15.107	9
7	PHOTOGRAPHS.....	16
8	CORRECTION FACTORS.....	17
9	ABBREVIATIONS AND ACRONYMS	19

1 Administrative Data

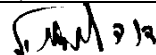
1.1. Scope

This document describes the measurement procedures and tests for Radiated and conducted emission testing of the MEMS3000 Manufactured by

2 General Information

2.1. Description of equipment Under Test

Equipment Under Test:	MEMS3000
FCCID	LSQ-MEMS-3000
Manufacturer:	Elmotech Ltd.
Serial Numbers:	001
Mode of Operation:	RX MODE
Receiver operating frequency:	318MHZ
Year of Manufacture:	2006

2.2. Applicant Information:

Applicant:	Elmotech Ltd.
Applicant Address	2, Habarzel Street Tel-Aviv
Telephone:	+972-3-6478871
FAX:	+972-3-6478872
The testing was observed by:	YARIV OREN
Following applicant's personnel:	

2.3. Test Performance:

Date of reception for testing:	01.02.06
Dates of testing;	01.02.06
Test Laboratory Name:	Tadiran EMC Laboratory
Address:	Hashoftim 26 Holon
Zip Code:	267,5812
City:	Holon
Country:	Israel
Telephone:	03-5574476
Fax:	03-5575320
Email:	Shmuel_cohen@tadcomm.com

Applicable EMC Specification:	Federal Communication Commission (FCC), Code of Federal Regulations 47, FCC Docket 89-103, Part 15: Radio Frequency Devices, Sections 15.109, 15,107
-------------------------------	---------------------------------------------------------------------------------------------------------------------------------------------------------------

3 Test Summary and Signatures.

TADIRAN EMC Laboratory has completed testing of E.U.T in accordance with the requirements of the FCC Part 15 Regulations for Class B equipment.

The E.U.T was found to comply with the requirements of the FCC Part 15 Regulations given below

Test	Test Description	Section	PASS/FAIL
1	Radiation emission	15.109	PASS
2	Conducted emission	15.107	PASS

3.1. Test performed by:

Mr. D. Lanuel Test Engineer

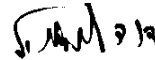

3.2. Test Report prepared by:

Mr. D. Lanuel Test Engineer

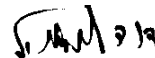

3.3. Test Report Approved by:

Mr. Samuel Cohen EMC Lab. Manager



4 E.U.T information

4.1. E.U.T description

The E.UT, MEMS 3000 is a home unit, which receives data from 318MHz alarm transmitters; it provides communication with monitoring center through modem POTS lines and infrared communication with a computer. The device is powered via external AC/DC adaptor 12v/4a, the device complies with Part 68 FCC Rules, US:LSQALBDCU2010, the EUT provides the following monitoring technologies:

- Randomly schedule video telephone calls to the client.
- Remote breath alcohol testing with a visual confirmation.
- Receiver under 318MHz

4.2. E.U.T Test Configuration

E.UT. Test configuration is shown in figure bellow

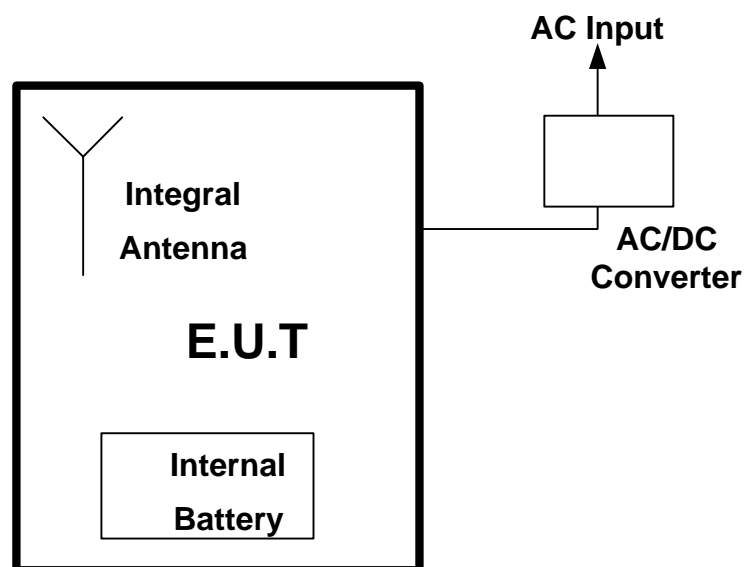

4.3. E.U.T Mode of Operation description

4.3.1 318MHz RX Mode operated by AC/DC Converter

5 Radiated emission part 15.109- (for RX mode)

5.1. Preliminary Radiated emission Test Result According Part 15.109

E.U.T: MEMS3000 001
 Test Method: ANSI 63.4
 Date: 01.02.06
 Relative Humidity: 41%
 Ambient Temperature: 19c
 Air Pressure: 1038hpa
 Test Setup: figure 1, 2

Testing Engineer: D.Lanuel  Date 02.02.06

5.2. Test Results Summary & Conclusions

The E.U.T was found in compliance with 15.109 radiated emission requirements

5.3. Limits of Radiated Interference Field Strength according 15.109

The test unit shall meet the limits of Table-1 for Class B equipment.

Table- 1 Limits For 15.109 Class B equipment

Frequency Range (MHz)	Limits (dB μ V/m)	Detector
30 - 88	40	Quasi Peak
88 - 216	43.5	
216 - 960	46	
960 - 1000	46	
1000 - 2000	53.9	Average

5.4. Test Instrumentation and Equipment

Table- 2 Test Instrumentation and Equipment

Item	Model	Manufacturer	Next Date Calibration
Spectrum Analyzer	8593E	HP	31.01.06
Double Ridge Guide Antenna(1-18GHz)	3105	EMCO	24.04.06
Broadband Antenna	BTA-L	FRANKONIA	10.04.06
Low Noise Amplifier (0-1GHz)	AM-1300-N	MITEQ	14.01.06
Low Noise Amplifier (1-4GHz)	AMM-003M	Avantek	14.01.06

5.5. Test Results

**Table- 3 Test Results for Unintentional Emissions in RX Mode
15.109**

Antenna Polarization	Freq. Range MHz	Res. BW (kHz)	Plot Ref.	PASS/FAIL
Both	30-1000	120	1	PASS
	1000-2000	1000	2	PASS

5.6. Test Procedure

5.6.1 Preliminary Test Procedure

- 5.6.1.1 The EUT was placed on the top of a rotating table 0.8 meters above the ground at a chamber shielded
- 5.6.1.2 The E.U.T was set 3 meters away from the receiving antenna, which was mounted on the top of a variable-height antenna tower.
- 5.6.1.3 The Antenna height varied from one meter to 1.8 meters above the ground and the table was rotated 360° to determine the maximum value of the field strength
- 5.6.1.4 The antenna was set both horizontal and vertical polarization.

5.6.2 Final Test Procedure

- 5.6.2.1 The EUT was tested at open area for each suspected emission,
- 5.6.2.2 The test procedure was performed according paragraph d. but the Antenna height varied from one meter to four meters above the ground

5.7. Final Test Setup

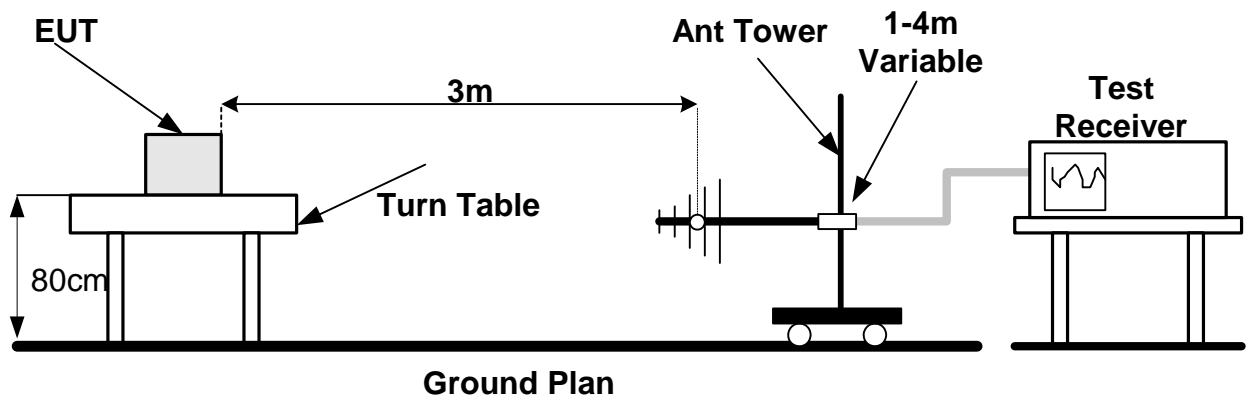

Figure- 1 Radiated Emission Test Configuration

5.8. Test Set up

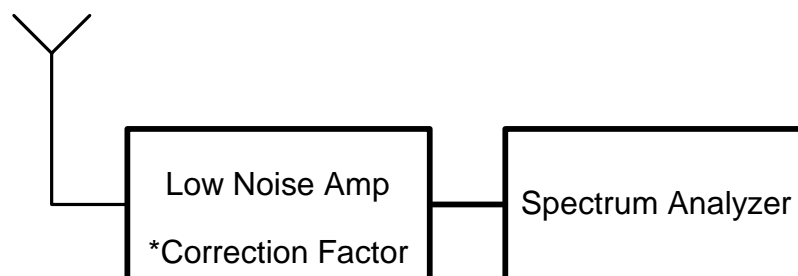

Figure- 2 Radiated Emission test 9KHz – 10GHz

6 Conducted Emission, AC Power Leads According to FCC 15.107

Frequency Range: 150 kHz – 30 MHz

E.U.T: MEMS3000 001
 Test Method: ANSI 63.4
 Date: 01.02.06
 Relative Humidity: 41%
 Ambient Temperature: 19c
 Air Pressure: 1038hpa
 Test Setup: figure 3, 4

Testing Engineer: D.Lanuel  Date : 02.02.06

6.1. Test Results Summary & Conclusions

The E.U.T was found in compliance with 15.107 conducted emission ac power requirements

6.2. Limits of Conducted Emission at Mains Terminals

The test unit shall meet the limits of Table-4 for FCC Part 15 Para 15.107 equipment.

Table- 4 Limits for intentional radiator according 15.107

Frequency Range MHz	Quasi-peak Limits dB μ V
0.15 – 0.50	66 to 56*
0.50 - 5	56
5 - 30	60

*Decreases with the logarithm of the frequency

6.3. Test Instrumentation and Equipment

Table- 5– Test Instrumentation and Equipment

Item	Model	Manufacturer	Next Date Calibration
Spectrum Analyzer	8593E	HP	31.01.06
Signal Generator	2017	Marconi	21.06.06
LISN	FCC-LISN-3B	FISCHER	31.08.06

6.4. Results

Table- 6 Test Results 15.107

Lead P/N	Mode of Operation	Frequency Range (MHz)	Resolution BW (kHz)	Plot No.	PASS/ FAIL
Neutral	RX	0.15 – 30	9	3	PASS
Phase	RX	0.15 – 30	9	4	PASS

6.5. Test Procedure

- 6.5.1.1 The EUT was placed on the top of table 1m by 1.5m, raised 0.8 meters above the conducting ground plane
- 6.5.1.2 The rear panel of the EUT was located 40cm to the vertical wall of the screen room
- 6.5.1.3 Each EUT power leads were individually connected through an LISN to the input power source. Unused 50 ohm connector of the LISN was terminated in 50ohm and other was connected to the spectrum analyzer through 20db attenuator for maximum conducted interference

6.6. Test setup

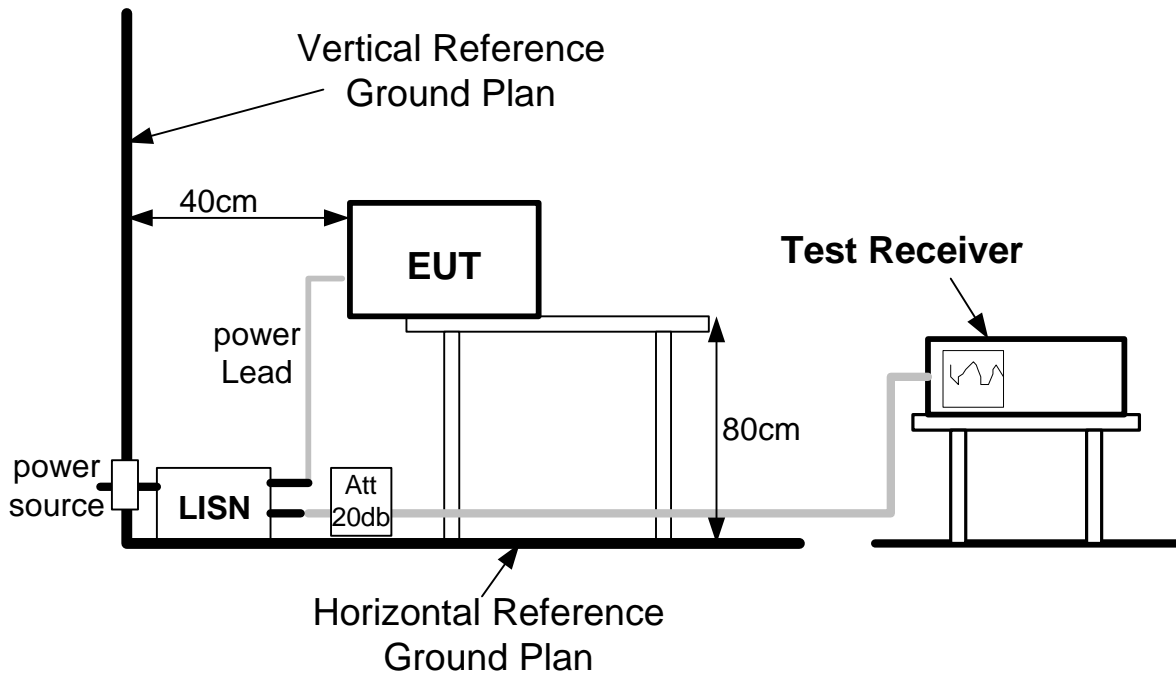

Figure- 3 Conducted emission Test Configuration

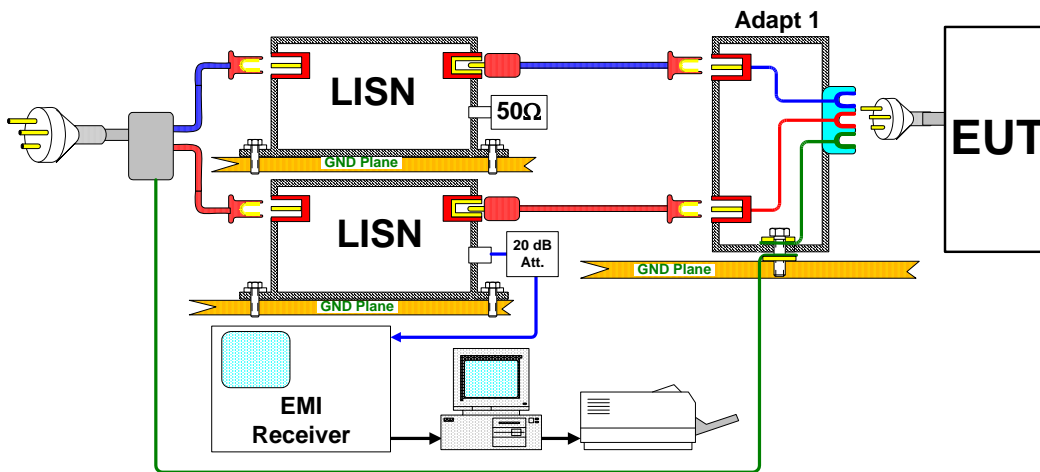

Figure- 4 Conducted emission Test setup

Test Results Plot No 1

RE102 FCC 109 30-1000MHz RX With AC/DC 318MHz

Test & EUT General Information		Receiver Setting	
EUT Name:	MEMS3000	Spect Analyzer	S.A HP 8593E
S/N:	001	Ref. Level:	70 dB μ V
Date of Test:	01.02.06	RBW:	120 kHz
Test Engineer:	S. Kozline	VBW:	1000 kHz
Antenna:	Frankonia BTA-L_A 3m	Sweep Time:	6 s
Polarization:	Horizontal and Vertical	Pre Amplifier	LNA 29db 0.01-1GHz No-3

TEST REMARKS:

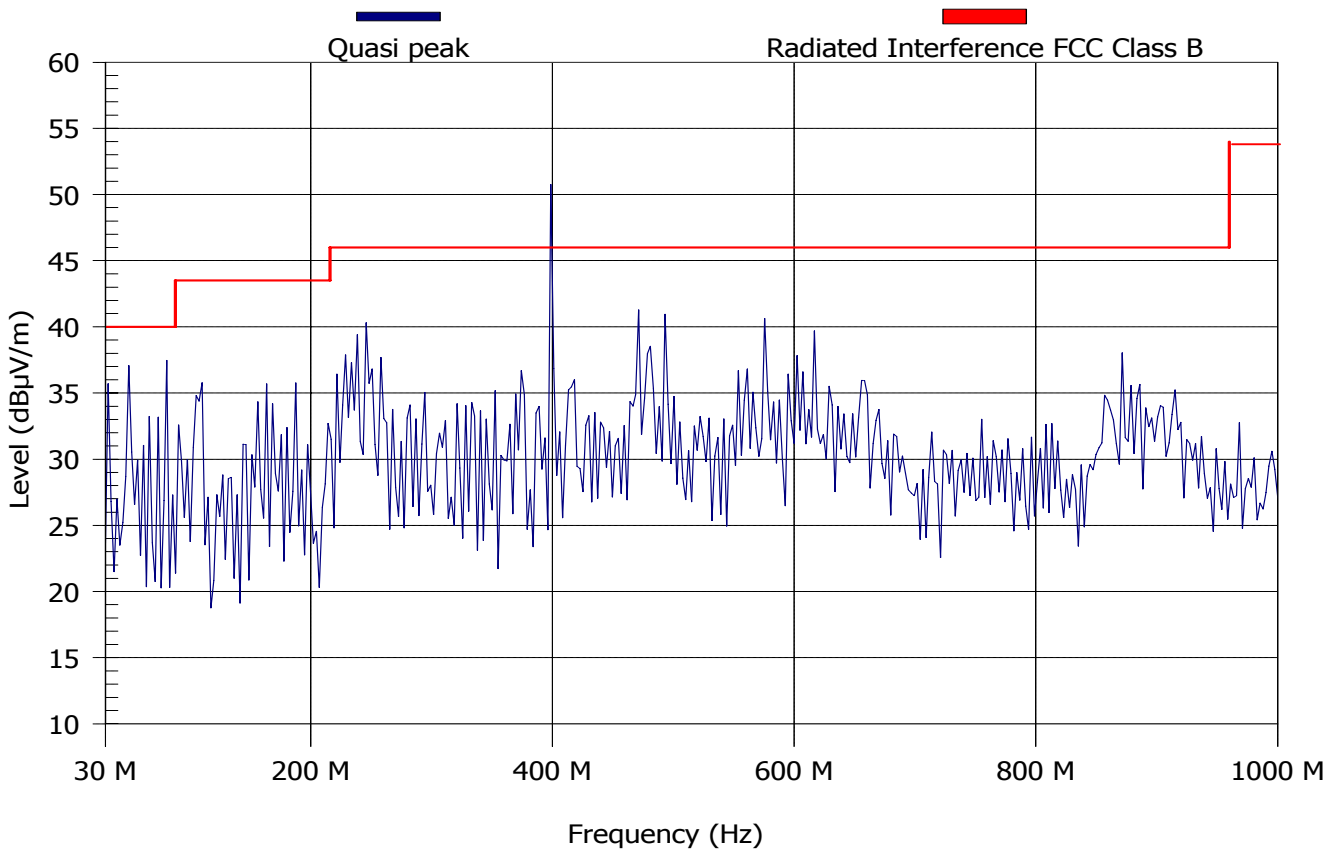

MAXIMUM RESULT DEVIATION:

Detect all peaks above 6 dB below the limit line with a maximum of 6 peaks.

Frequency (MHz)	PK MaxHold (dB μ V/m)	QP (dB μ V/m)	QP Limit (dB μ V/m)	Results	Angle (degrees)	Height (m)	H/V
32.765	37.1	36.6	40	Pass	120	1.6	V
49.149	40.6	39	40	Pass	120	1.6	V
49.151	40.4	39.3	40	Pass	60	1.6	V
229.367	42	40.3	46	Pass	240	1	H
398.6	50.8	11.3	46	Pass	300	1	V
471.35	41.3	27	46	Pass	300	1.3	H

Test Results Plot No 2

RE102 FCC 109 1000-2000MHz RX With AC/DC 318MHz

Test & EUT General Information		Receiver Setting	
EUT Name:	MEMS3000	Spect Analyzer	S.A HP 8593E
S/N:	001	Ref. Level:	70 dB μ V
Date of Test:	01.02.06	RBW:	1000 kHz
Test Engineer:	S. Kozline	VBW:	1000 kHz
Antenna:	ARA DRG-118/A 1-18GHz 1319	Sweep Time:	Auto: 20 ms
Polarization:	Horizontal and Vertical	Pre Amplifier	LNA 44db 6-18 GHz

TEST REMARKS:

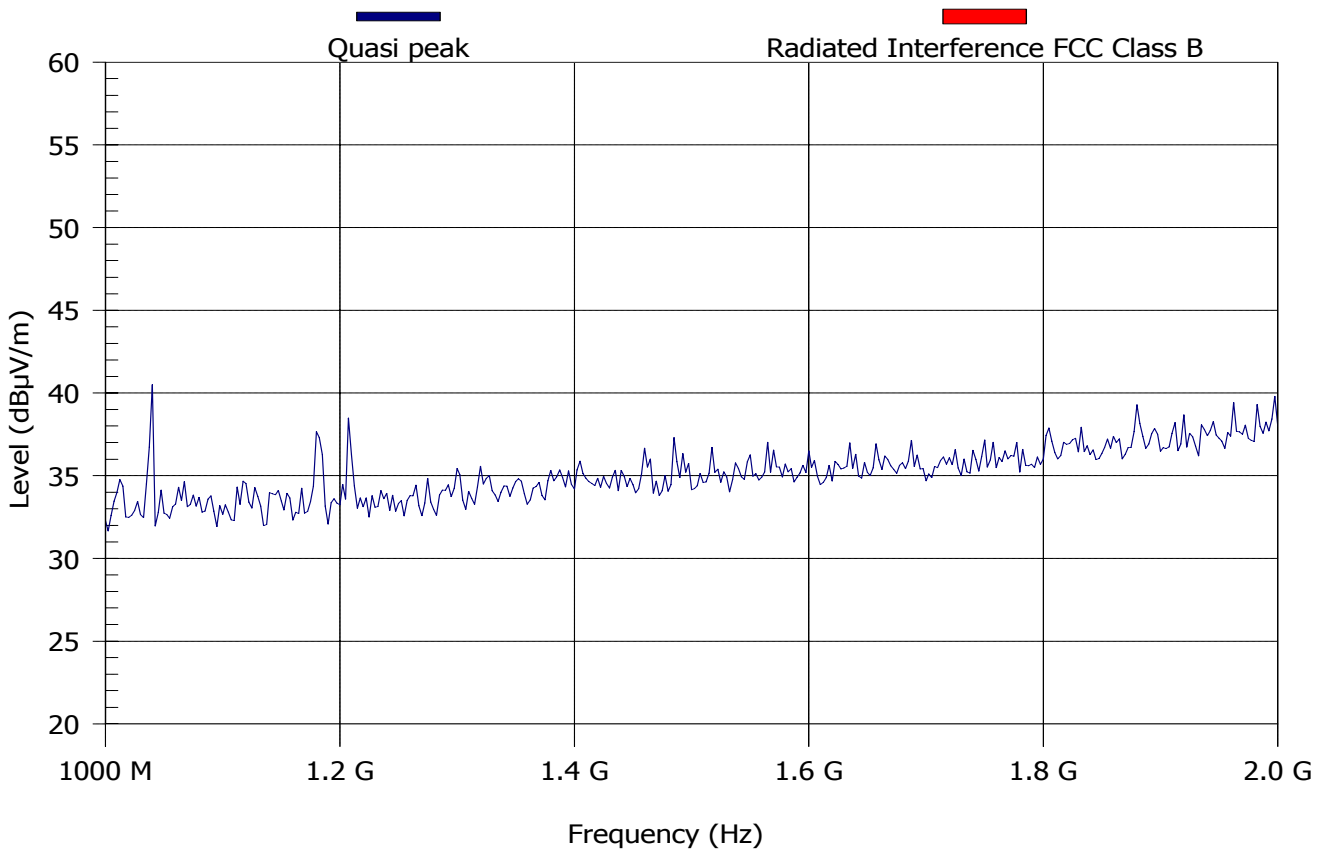

MAXIMUM RESULT DEVIATION:

Detect all peaks above 6 dB below the limit line with a maximum of 6 peaks.
None

Test Results Plot No 3
CE EN 55022 0.15-30MHz Line 1

Test & EUT General Information		Receiver Setting	
EUT Name:	MEMS3000	Spect Analyzer	S.A HP 8593E
S/N:	001	Ref. Level:	70 dB μ V
Date of Test:	01.02.06	RBW:	9 kHz
Test Engineer:	S. Kozline	VBW:	1000 kHz
Antenna:		Sweep Time:	Auto: 1.11 s
Polarization:	3 polarization	Pre Amplifier	No Description Available

TEST REMARKS:

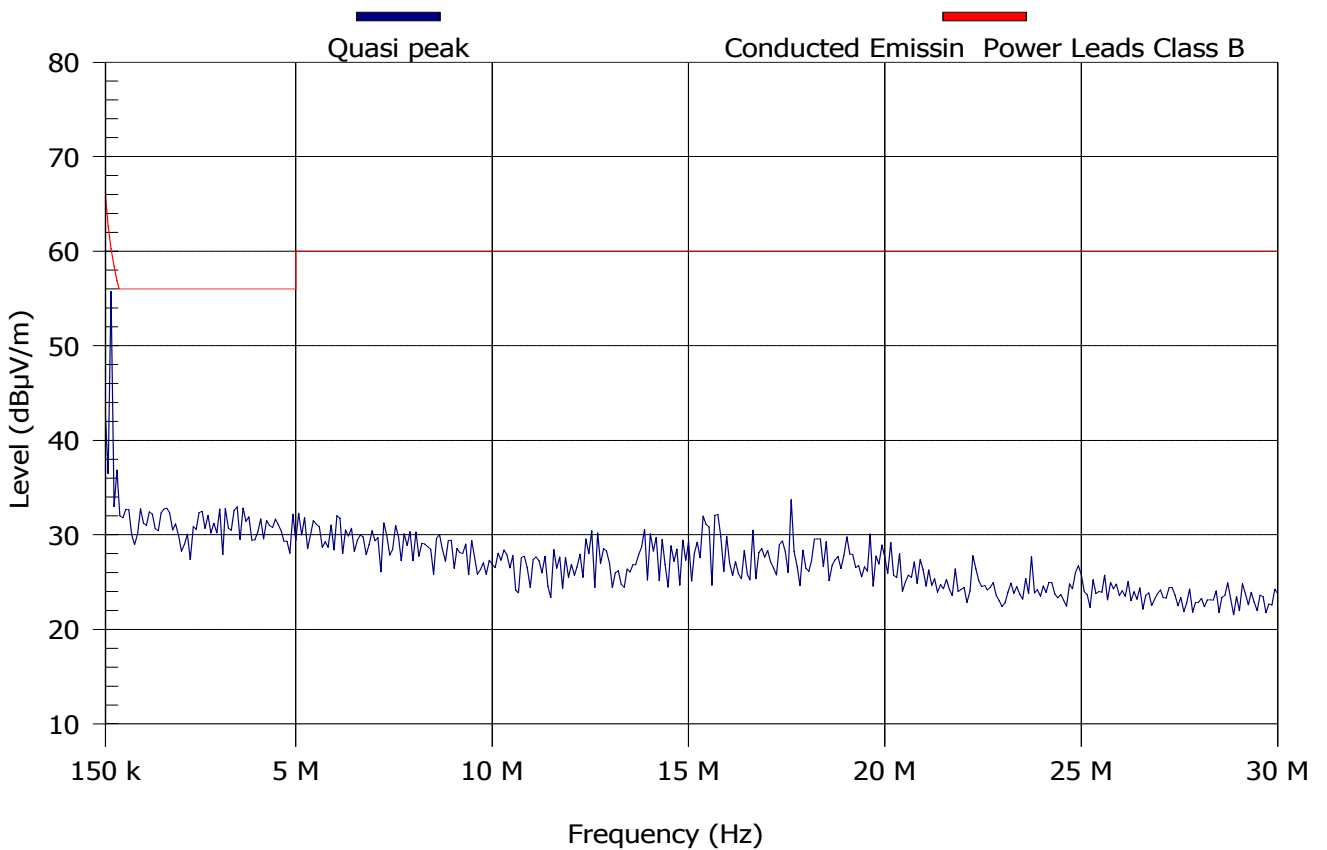

MAXIMUM RESULT DEVIATION:

Detect all peaks above 6 dB below the limit line with a maximum of 6 peaks.

Frequency (MHz)	PK MaxHold (dB μ V/m)	QP (dB μ V/m)	QP Limit (dB μ V/m)	Result	Line
0.308	56.8	50.7	60	Pass	Line 1

Test Results Plot No 4
CE EN 55022 0.15-30MHz Line 2

Test & EUT General Information		Receiver Setting	
EUT Name:	MEMS3000	Spect Analyzer	S.A HP 8593E
S/N:	001	Ref. Level:	70 dB μ V
Date of Test:	01.02.06	RBW:	9 kHz
Test Engineer:	S. Kozliner	VBW:	1000 kHz
Antenna:		Sweep Time:	Auto: 1.11 s
Polarization:	1 polarization	Pre Amplifier	No Description Available

TEST REMARKS:

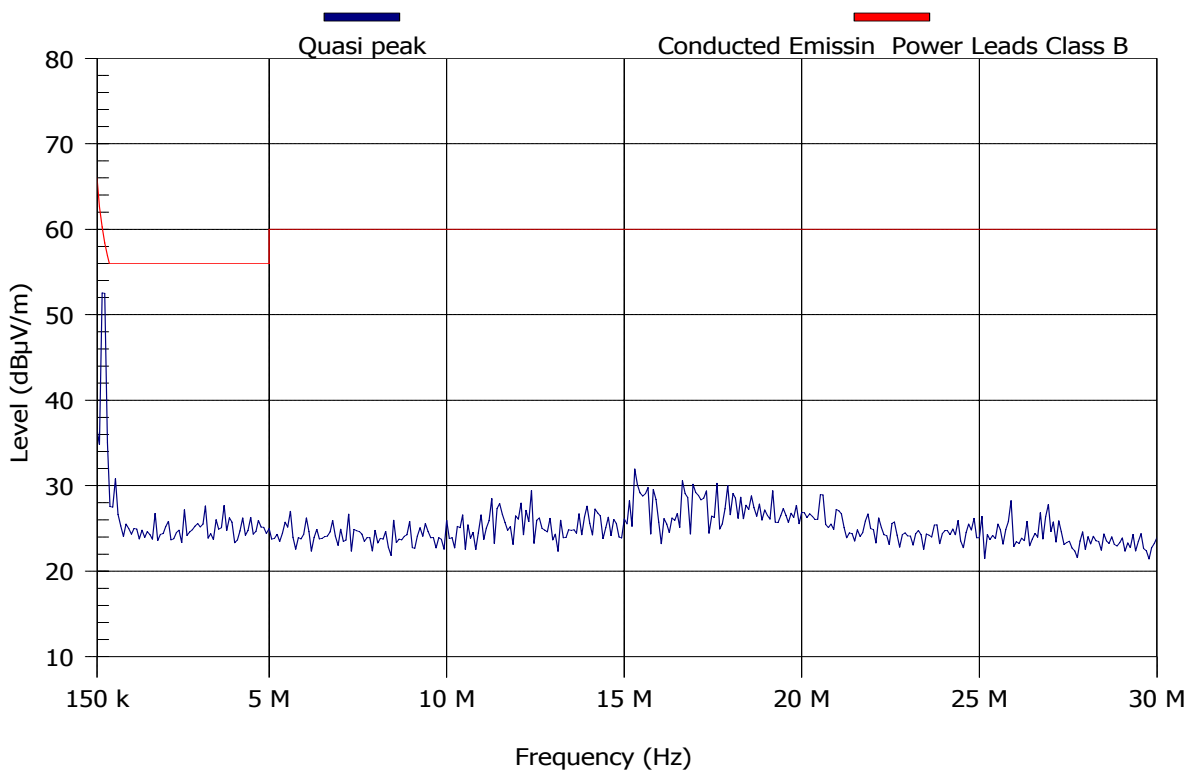

MAXIMUM RESULT DEVIATION:

Detect all peaks above 6 dB below the limit line with a maximum of 6 peaks.

Frequency (MHz)	PK MaxHold (dB μ V/m)	QP (dB μ V/m)	QP Limit (dB μ V/m)	Result	Line
0.306	53.2	50.4	60.1	Pass	Line 2

7 Photographs



Photograph/ 1 Radiated Emission 30-1000MHz test setup



Photograph/ 2 Radiated Emission 1-2GHz test setup

8 CORRECTION FACTORS

DOUBLE RIDGE HORN Model 3105 S/N:00-50C2-1C-C468 2052 Antenna Factor

Frequency (MHz)	Ant. Factor (db/m)
1000	24.4
2000	26.2
3000	30
4000	32.6
5000	33.8
6000	34.9
7000	36.2
8000	36.9
9000	37.8
10000	38.4
11000	39.1
12000	40.1
13000	42
14000	40.6
15000	39.3
16000	40.3

Antenna Factor for broadband antenna model BTA-L S/N:00-50C2-1C-C468 980045L

Frequency (KHz)	Ant. Factor (db/m)	Frequency (KHz)	Ant. Factor (db/m)
30	19.05	300	14.35
32	19.13	310	14.28
34	18.74	320	14.43
36	18.03	330	14.13
38	16.61	340	14.48
40	15.44	350	14.89
45	13.66	360	15.12
50	11.52	370	15.70
55	10.04	380	15.78
60	7.68	390	16.22
65	6.11	400	16,45
70	5.47	425	16.99
75	5.98	450	17.59
80	6.86	475	17.28
85	7.20	500	17.69
90	7.47	525	18.91
95	7.23	550	19.06
100	7.20	575	18.20
105	7.30	600	18.87
110	7.37	625	18.81
115	7.02	650	19.64
120	6.82	675	19.92
125	7.05	700	20.66
130	7.83	725	21.08
135	9.61	750	21.53
140	7.93	775	22.39
145	8.03	800	22.66
150	8.29	825	22.87
160	8.72	850	22.65
170	9.18	875	23.12
180	9.05	900	23.70
190	9.80	925	23.40
200	10.61	950	23.43
210	10.34	975	23.30
220	11.21	1000	24.02
230	11.69		
240	11.62		
250	11.85		
260	12.45		
270	13.16		
280	13.48		
290	13.74		

9 Abbreviations and Acronyms

The following abbreviations and acronyms are applicable in this document

BW Bandwidth

R.BW Resolution Bandwidth

V.BW Video Bandwidth

db Decibel

EMI Electromagnetic interference

E.U.T Equipment under test

LISN Line impedance stabilization network

N.P.C.R Non Periodic Calibration Requisite

S/N Serial number

QP Quasi peak

PK Peak