

REV	Δ	Description	Sheet Effected	Date	Drawn	Checked
A				08.06.03	D.Lanuel	S.Cohen

EMC Laboratory

# LOCAL PAGER UNIT

FCCID :LSQ-LPU-800  
 Manufactured by  
 Elmotech Ltd.

EMC Test Report

According FCC Part 15 Requirements

JUNE 2003

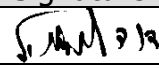
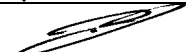
	Function/Title	Name	Signature	Date
Prepared by	Test Engineer	D.Lanuel		08.06.03
Approved by	EMC Lab. Manager	S.Cohen		08.06.03

## Table of Contents

Para	Page
1 TEST DATA INFORMATION .....	3
<b>A. DESCRIPTION OF EQUIPMENT UNDER TEST. ....</b>	<b>3</b>
<b>B. APPLICANT INFORMATION: .....</b>	<b>3</b>
<b>C. TEST PERFORMANCE: .....</b>	<b>3</b>
2 TEST SUMMARY AND SIGNATURES. ....	4
<b>A. TEST PERFORMED BY: .....</b>	<b>4</b>
<b>B. TEST REPORT PREPARED BY: .....</b>	<b>4</b>
<b>C. TEST REPORT APPROVED BY: .....</b>	<b>4</b>
3 GENERAL INFORMATION .....	5
<b>A. SPECIFICATION REFERENCE .....</b>	<b>5</b>
<b>B. APPLICABLE DOCUMENTS.....</b>	<b>5</b>
4 ADMINISTRATIVE DATA .....	6
<b>A. SCOPE .....</b>	<b>6</b>
<b>B. ADMINISTRATIVE DATA .....</b>	<b>6</b>
<b>C. CERTIFICATION AND QUALIFICATIONS.....</b>	<b>6</b>
<b>D. MEASUREMENT REPEATABILITY INFORMATION .....</b>	<b>6</b>
<b>E. MEASURING EQUIPMENT CALIBRATION .....</b>	<b>7</b>
<b>F. ANTENNAS CALIBRATION .....</b>	<b>7</b>
5 E.U.T INFORMATION.....	7
<b>A. E.U.T DESCRIPTION .....</b>	<b>7</b>
<b>B. E.U.T TEST CONFIGURATION .....</b>	<b>7</b>
<b>C. E.U.T MODE OF OPERATION DESCRIPTION .....</b>	<b>7</b>
6 OUT OF BAND RADIATED FIELD STRENGTH MEASUREMENT TEST ACCORDING TO 15.109.....	8
<b>A. GENERAL .....</b>	<b>8</b>
<b>B. TEST RESULTS SUMMARY &amp; CONCLUSIONS .....</b>	<b>8</b>
<b>C. LIMITS OF RADIATED INTERFERENCE FIELD STRENGTH ACCORDING 15.109 .....</b>	<b>8</b>
<b>D. TEST INSTRUMENTATION AND EQUIPMENT.....</b>	<b>9</b>
<b>E. PRELIMINARY TEST PROCEDURE .....</b>	<b>11</b>
<b>F. PRELIMINARY RESULTS .....</b>	<b>12</b>
7 FINAL RADIATED INTERFERENCE FIELD STRENGTH EASUREMENT.....	27
<b>A. TEST INSTRUMENTATION AND EQUIPMENT .....</b>	<b>27</b>
<b>B. TEST SETUP.....</b>	<b>27</b>
<b>C. FINAL TEST RESULTS .....</b>	<b>29</b>
8 CONDUCTED EMISSIONS, AC POWER LEADS ACCORDING TO FCC 15.107 .....	30
<b>A. EQUIPMENT UNDER TEST DESCRIPTION AND OPERATION .....</b>	<b>30</b>
<b>B. TEST RESULTS SUMMARY &amp; CONCLUSIONS .....</b>	<b>30</b>
<b>C. LIMITS OF CONDUCTED EMISSION AT MAINS TERMINALS .....</b>	<b>30</b>
<b>D. TEST INSTRUMENTATION AND EQUIPMENT.....</b>	<b>30</b>
<b>E. TEST SETUP.....</b>	<b>31</b>
<b>F. TEST PROCEDURE .....</b>	<b>33</b>

## 1 TEST DATA INFORMATION

### a. Description of equipment Under Test.

Equipment Under Test:	Local Pager Unit
FCCID	LSQ-LPU-800
Manufacturer:	Elmotech Ltd.
Serial Numbers:	0001
Mode of Operation:	RX MODE
Receiver operating frequency:	318MHZ
Year of Manufacture:	2003

### b. Applicant Information:

Applicant:	Elmotech Ltd.
Applicant Address	2, Habarzel Street Tel-Aviv
Telephone:	+972-3-6478871
FAX:	+972-3-6478872
The testing was observed by following applicant's personnel:	alex Rachman

### c. Test Performance:

Date of reception for testing:	20.05.03
Dates of testing	21.05.03
Test Laboratory Location	TADIRAN EMC LAB , Hashoftim 26 Holon 58102 ISRAEL Tel: 972-3-5574476 Fax: 972-3-5575320
Applicable EMC Specification:	Federal Communication Commission (FCC), Code of Federal Regulations 47, FCC Docket 89-103,Part 15: Radio Frequency Devices, Sections 15.107 & 15.109

## 2 TEST SUMMARY AND SIGNATURES.

TADIRAN EMC Laboratory has completed testing of E.U.T in accordance with the requirements of the FCC Part 15 Regulations for Class B equipment.

**The E.U.T has been found to comply with the emission requirements of the FCC Part 15 Regulations for parts 15.107 & 15.109**

**a. Test performed by:**

Mr. D. Lanuel Test Engineer



**b. Test Report prepared by:**

Mr. D. Lanuel Test Engineer



**c. Test Report Approved by:**

Mr. Samuel Cohen EMC Lab. Manager



### 3 GENERAL INFORMATION

#### a. Specification Reference

- Section 15.107: Limits of Mains Terminal Interference Voltage (Conducted Emission) in the 0.15MHz to 30MHz frequency range. For Unintentional Radiators.
- Section 15.109: Limits of Radiated Interference Field Strength in the 30MHz to 1000MHz frequency range.

#### b. Applicable Documents.

- 3.1 Federal Communication Commission (FCC), Code of Federal Regulations 47, FCC Docket 89-103, Part 15: Radio Frequency Devices, Sections 15.107 & 15.109.
- 3.2 FCC/OET, Laboratory Measurement Procedures MP-4, July 1987, "FCC Procedures for Measuring RF Emissions from Computing Devices".
- 3.3 FCC/Office of Science and Technology OST-55, August 1982, "Characteristics of Open Field Test Sites".
- 3.4 FCC/OET, "FCC Procedure for Measuring Electromagnetic Emissions from Digital Devices", TP-5, March 1989.
- 3.5 FCC/OET, "Understanding the FCC Regulations Concerning Computing Devices", OST-62, May 1984
- 3.6 International Special Committee On Radio Interference (CISPR) Publication 16, First Edition 1977, "CISPR Specification for Radio Interference Measuring Apparatus and Measurement Methods".
- 3.7 American National Standard, "Specifications for Electromagnetic Noise and Field Strength Instrumentation, 9KHz to 1GHz", ANSI C63.2, 1987.
- 3.8 American National Standard, "Method of Measurement Electromagnetic Emissions from Low-Voltage Electrical and Electronic Equipment in the range of 9KHz to 40GHz", ANSI C63.4, 1992.

## 4 ADMINISTRATIVE DATA

### a. Scope

This document describes the measurement procedures and tests for Radiated and conducted emission testing of the LSQ-LPU-800 Manufactured by Elmotech Ltd..

### b. Administrative Data

The test was performed by the TADIRAN / EMC Laboratory, 26 Hashoftim St. P.O.B. 267, 58102 Holon, ISRAEL.

### c. Certification And Qualifications

I Certify that TADIRAN / EMC Laboratory. Conducted the tests performed in order to obtain a technical data presented in this application. Also based on the results of this enclosed data I have concluded that the equipment tested meets or exceeds the requirements of the Rules and regulations governing this application.

TADIRAN / EMC Laboratory, 26 Hashoftim St. P.O.B. 267, 58102 Holon, ISRAEL was established in 1975 to provide Electromagnetic Compatibility testing, Consulting and Engineering. All facility are equipped with modern Automated test equipment and staffed with experienced EMC test engineers. Engineering support is a standard feather of our sites, we are ready to support and assist our customers in meeting the compliance requirements.

Our qualifications include:

Quality assurance MIL-I-45208A

Calibration per MIL-STD-45662A

FCC Listed

ISO 9001 Approved By The International Certification Network "IQNet"

ISO 9001 Approved By the Standards Institute of Israel.

Approved by I.D.F for Compliance with regulation.

Approved by I.A.F for Compliance with regulation

TADIRAN / EMC Laboratory has previously performed FCC testing of similar equipment.

Appendix A includes an FCC approval of our application for licensing of a previous generation of a Transceiver product operating under the requirements of FCC part 15.247 for intentional radiator equipment. As well as evidence for our accreditation by ISO 9001 & listing by FCC.

### d. Measurement Repeatability information

The test data presented in this report has been acquired using the guidelines set forth in FCC Part 15 .The test data presented in this document are valid only for the equipment identified under the test conditioned described. Repeatability of these tests results will only be achieved with identical test conditions. This conditions include: the same test distance, E.U.T height, measurement site characteristics and the same E.U.T System components, The system must have the same interconnecting cables arranged in identical placement to that in the test set-up, with the system and /or E.U.T functioning in identical mode of operation (i.e. software and so on) as on the date of the test. Any deviation from the test conditions and the environment on the date of test may result in measurement repeatability difficulties. All changes made to the E.U.T during the course of testing as identified in this test report must be incorporated into the E.U.T or identical modes to ensure compliance with the FCC regulations.

**e. Measuring Equipment Calibration****(1) Receiving System Calibration**

The equipment calibration is traceable. Calibration is performed under the MIL-STD-45662A requirements

**f. Antennas calibration**

Biconical and Log-periodic antennas are calibrated by using the reference antenna method according to ANSI C63.5-1988, when the reference antenna is the Robert's antenna.

Double-ridged guide antennas (1-18 GHz) are calibrated by using two identical antenna methods according to ANSI C63.2-1987 and SAE ARP-958

Calibration of listed above antennas is performed periodically once a year

Robert antenna is calibrated every three years by using the reference antenna method according to ANSI C63.5-1988, when the reference antenna is the calibrated Robert antenna.

Antennas, which are used according to military standards tests, are calibrated every two years by using two identical antenna methods according to SAE ARP-958.

**5 E.U.T INFORMATION****a. E.U.T description**

- (1) The Local Pager Unit (LSQ-LPU-800) is a compact RF receiver unit operates at 318MHz that is generally carried out and can be used in several modes of operation. The EUT powered by two 3.0V lithium batteries, connected in series.

**b. E.U.T Test Configuration**

The E.U.T test configuration for Conducted and Radiated Emission measurements is given in figures RE-A and CE-2

Auxiliary test equipment list for radiated emission test is given in table RE-2

Auxiliary test equipment list for Conducted emission test is given in table CE-2

**c. E.U.T Mode of Operation description**

The test was performed to measure Radiated & Conducted emission at RX Mode by two configurations:

A Battery only configuration-The EUT operated by Battery

B AC Adapter configuration-The EUT operated by 220VAC for charging

## 6 OUT OF BAND RADIATED FIELD STRENGTH MEASUREMENT TEST ACCORDING TO 15.109

Testing Engineer: D.Lanuel *[Signature]*

Date 20/05/03

### a. General

The test was performed to measure Radiated emission at RX Mode by tow configurations:

- 1 Battery only configuration
- 2 AC Adapter configuration

### b. Test Results Summary & Conclusions

The E.U.T was found in compliance with 15.109 Requirements

### c. Limits of Radiated Interference Field Strength according 15.109

The test unit shall meet the limits of Table RE-1 for Class B equipment.

**Table RE-1 Limits For Class B equipment**

Frequency Range (MHz)	Quasi-peak Limits (dB $\mu$ V/m)
30 - 88	40
88 - 216	43
216 - 960	46
Above 960	54

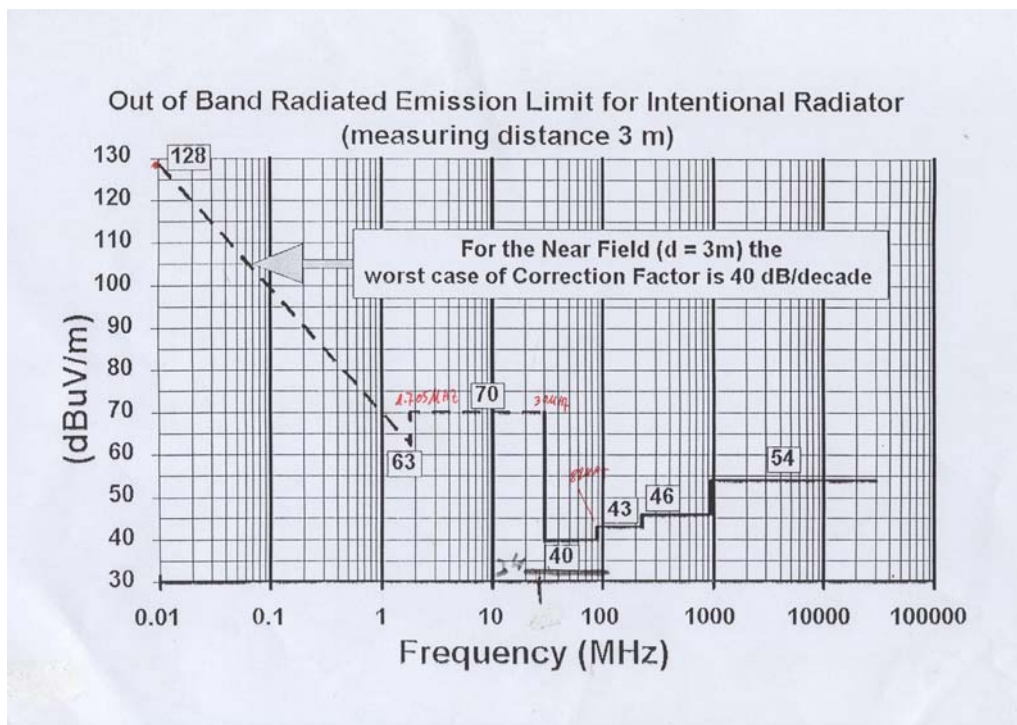



**d. Test Instrumentation and Equipment**

**Table RE-2 Test Instrumentation and Equipment**

Item	Model	Manufacturer	Next Date Calibration
Spectrum Analyzer	8568A	HP	12/08/03
Spectrum Analyzer	8593E	HP	31/01/04
Broadband Antenna	BTA-L	FRANKONIA	10.04.04
Low Noise Amplifier (0-1GHz)	AM-1300-N	MITEQ	14.01.04
Low Noise Amplifier (1-2GHz)	SMC-09	MITEQ	14.01.04
Low Noise Amplifier (2-6GHz)	MWA-02060-4025	ELISRA	14.01.04

- (1) The measuring system block diagram shown in Figure RE-1.
- (2) E.U.T orientation and antenna position shown in Figure RE-2
- (3) Cables configuration shown in Figure RE-3

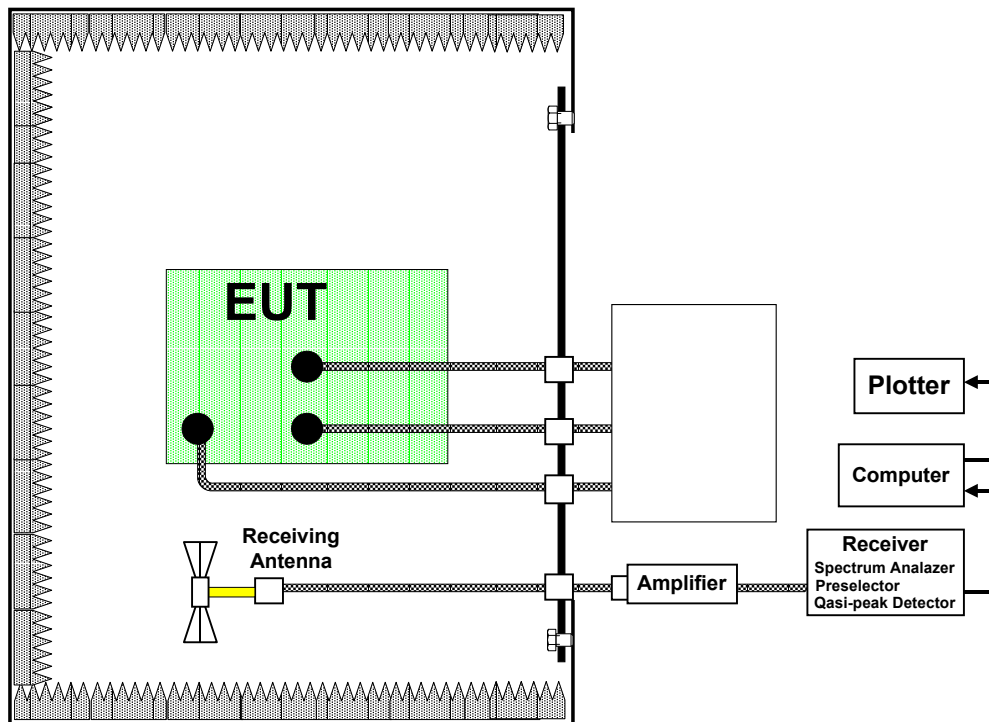

**Absorber-Lined Shielded Room**

**Figure RE-1**

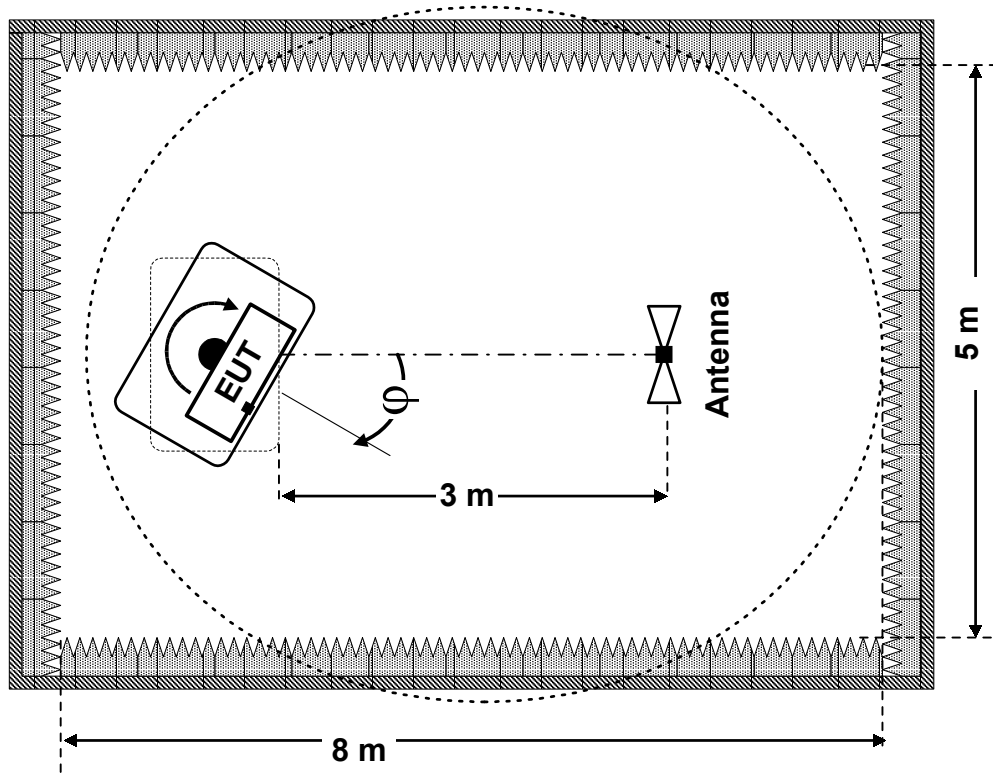

**Figure RE-2**

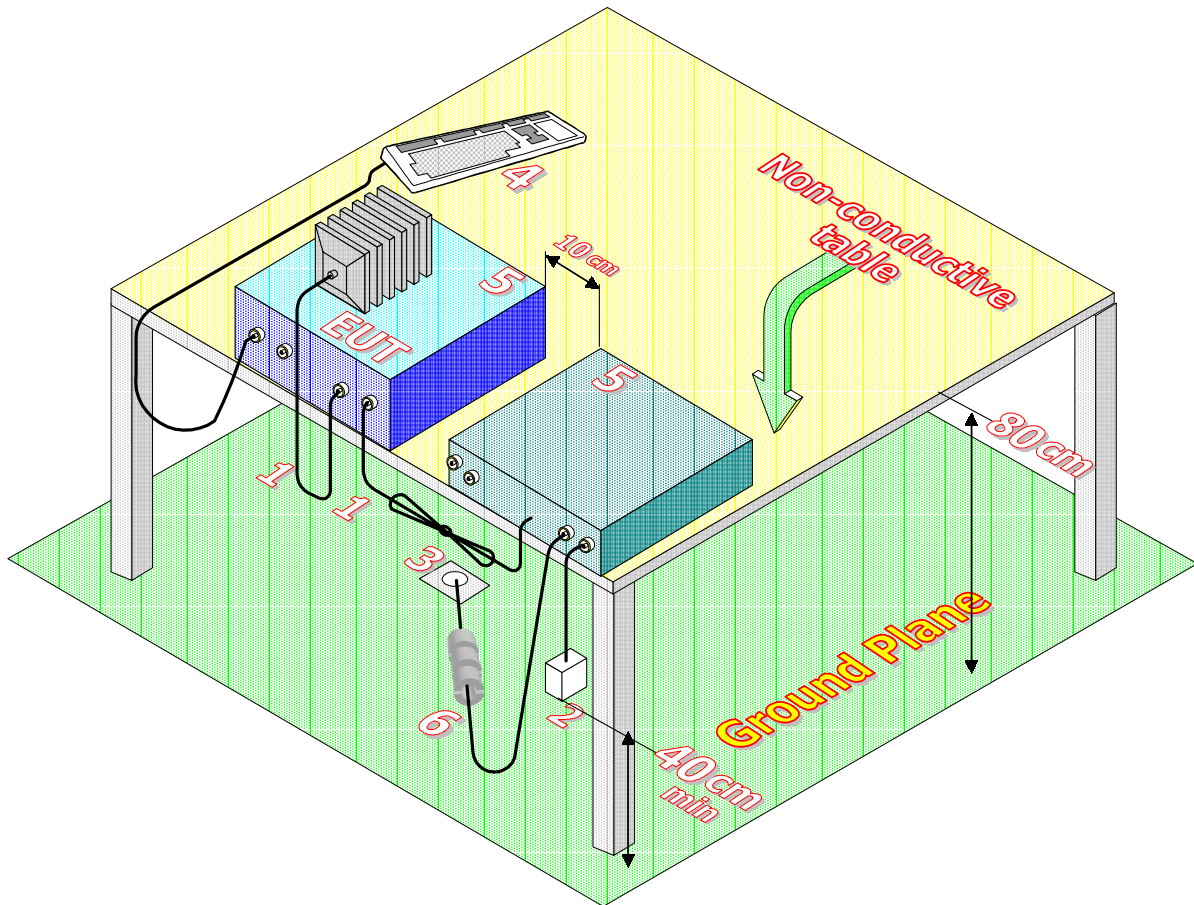

**Figure RE-3**

1. If cables, which hang closer than 40 cm to the horizontal ground plane cannot be shortened to the appropriate length, the excess shall be folded back and forth forming a bundle 30 cm to 40 cm long.
2. The end of I/O signal cables, which are not connected to a peripheral, may be terminated, if required to proper operation using correct terminating impedance.
- 3 Main junction boxes shall be flush with, and bonded directly to, metal ground plane
4. Cables of hand operated devices such as keyboards, mouses; etc. shall be placed as for normal usage.
5. Peripherals shall be placed at distance 10 cm from each other and from the controller, except for the monitor, which, if for an acceptable installation practice, shall be placed directly on top of the controller.
6. Mains cables, telephone lines or other connections to auxiliary equipment located outside the test area shall drape to the floor, be fitted with ferrite clamps or ferrite tubes placed on the floor at the point where the cable reaches the floor and then routed to the place where they leave the turn table. No extension cords shall be used to mains receptacle.
- 7 Ferrite clamps or ferrite tubes. No more than one cable per clamp.

**e. Preliminary Test Procedure**

- (1) Maintain setup in absorber-lined shielded room as shown in Figures RE-1, RE-2 and RE-3.
- (2) Turn on the E.U.T and allow sufficient time for stabilization.
- (3) Monitor the frequency range of interest at a fixed antenna height and E.U.T azimuth.
- (4) Rotate the E.U.T 360° to maximize the suspected highest amplitude signal.
- (5) Move the antenna over its full-allowed range of travel to maximize the suspected highest amplitude signal.
- (6) Change the polarity of the antenna and repeat step d and e. compare the result suspected highest amplitude signal with that found for the other polarity. Select and note the higher of the two signals. The signal is termed the highest observed signal with the respect to the limit.
- (7) Repeat testing for each operational mode of the E.U.T.
- (8) Choose six highest emissions relative to limit and record antenna heights and polarities, E.U.T configuration for each emission frequency.
- (9) Perform measurements for selected frequencies using quasi-peak detector.

**f. Preliminary Results**

**Table RE-3 Preliminary Test Results for RX Mode 15.109**

Configuration	Antenna Polarization	Freq. Range MHz	Res. BW (kHz)	Plot No.	Compl. Y/N
Calibration		30	120	Plot REcal/1	Y
		200		Plot REcal/2	Y
		1000		Plot REcal/3	Y
		2000		Plot REcal/4	Y
Battery only Configuration	Both Hor.&Ver	30-200	120	Plot RE/1	Y
		200-1000		Plot RE/2	Y
		1000-2000	1000	Plot RE/3	Y
		2000-5000	1000	Plot RE/4	Y
AC Adapter Configuration	Both Hor.&Ver	30-200	120	Plot RE/5	Y
		200-1000		Plot RE/6	Y
		1000-2000	1000	Plot RE/7	Y
		2000-5000	1000	Plot RE/8	Y

**EUT File:**

S:\EMC\_LAB\common\DAMATEC\LPU\_TNG\Data\Fcc1.eut

**Order Number:**

**EUT**

Name: LPU-TNG  
Serial Number: 0001

**Client**

Name: Dmatek  
Contact Person: Alex Rachman

**Radiated Emission**

Description: 16) RE FCC CLASS B calibration 30MHz  
From 29 MHz to 31 MHz

**Graph:**

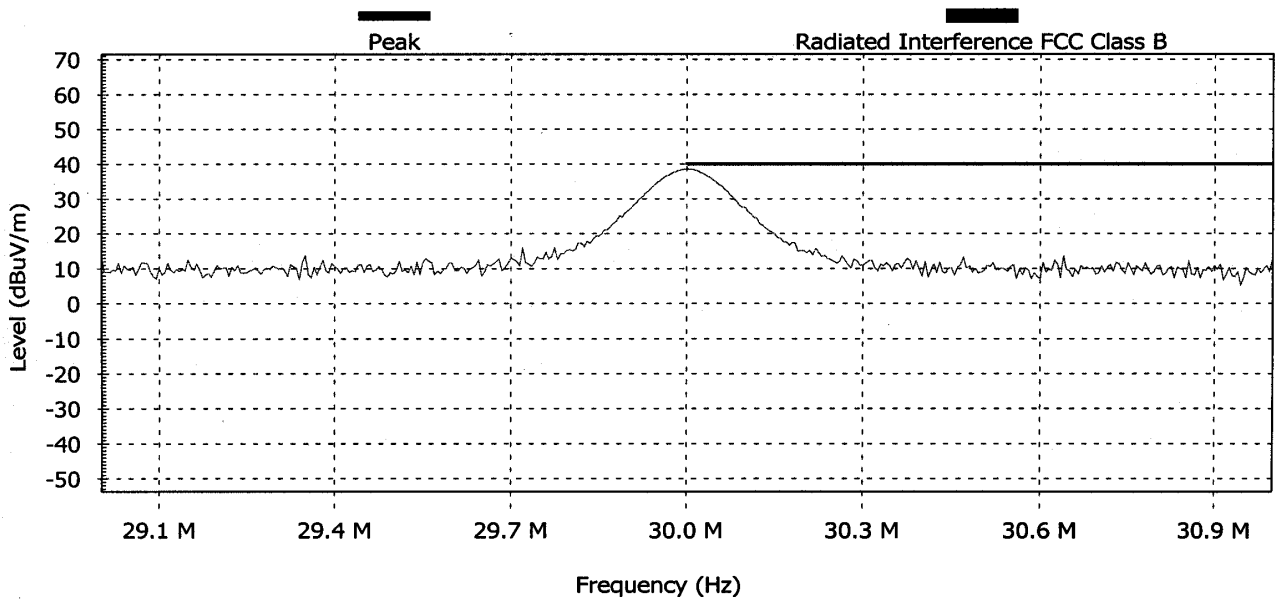

**Detected Peaks:**

Nr	Frequency (MHz)	PK (dBuV/m)	PK Limit (dBuV/m)	PK Pass	Pass	Angle (degrees)	Height (m)
1	29.995	40.7		Pass	Pass	275	2

**Settings:**

Antenna: Horizontal at 3 m  
Ref. Level: 70.0 dBuV/m Att: 0 dB. RBW: 120 kHz. VBW: 1000 kHz. Sweep time: 20 ms.  
Detect all peaks above 6 dB below the limit lines  
Measure the peaks with the peak detector

**Note:**

Calibration for 30MHz , 40dbuV

**Plot REcal/ 1**

**EUT File:**  
S:\EMC\_LAB\common\DAMATEC\LPU\_TNG\Data\Fcc1.eut  
**Order Number:**

**EUT**  
Name: LPU-TNG  
Serial Number: 0001

**Client**  
Name: Dmatek  
Contact Person: Alex Rachman

**Radiated Emission**

Description: 19) RE FCC CLASS B calibration 200MHz  
From 195 MHz to 205 MHz

**Graph:**

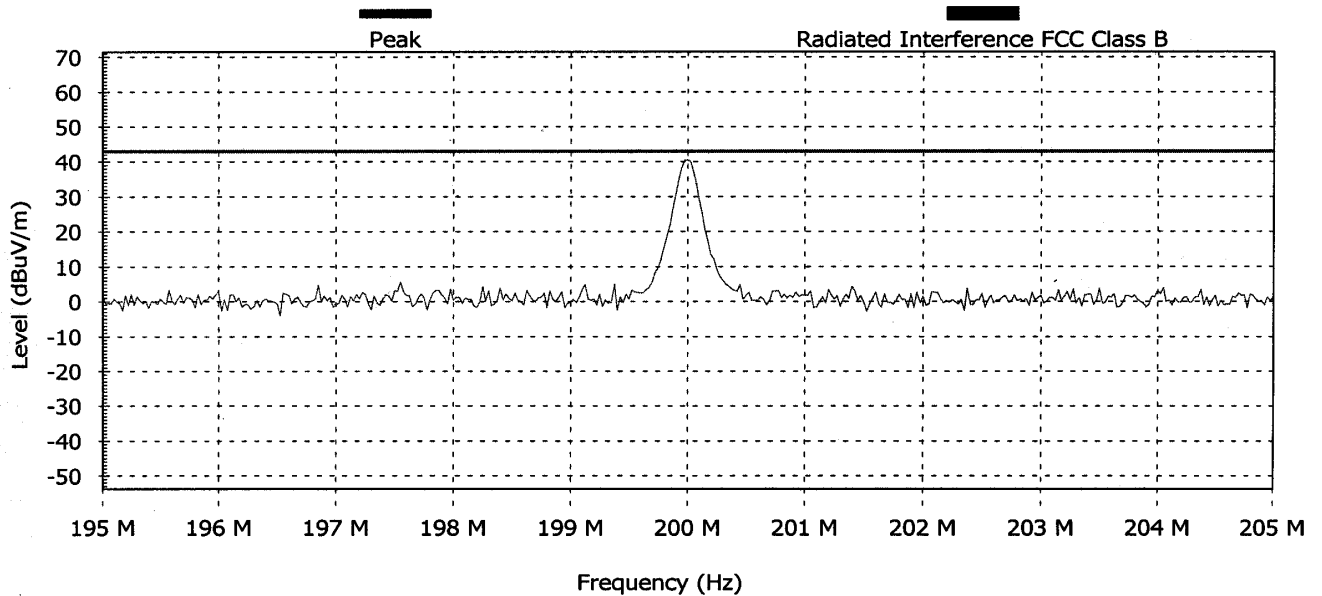

**Detected Peaks:**

Nr	Frequency (MHz)	PK (dBuV/m)	PK Limit (dBuV/m)	PK Pass	Pass	Angle (degrees)	Height (m)
1	200.003	42.7		Pass	Pass	270	2

**Settings:**

Antenna: Horizontal at 3 m  
Ref. Level: 70.0 dBuV/m Att: 0 dB. RBW: 120 kHz. VBW: 1000 kHz. Sweep time: 20 ms.  
Detect all peaks above 6 dB below the limit lines with a maximum of 6 peaks.  
Measure the peaks with the peak detector

**Note:**

Calibration for 200MHz , 43dbuV

**Plot REcal/ 2**

**EUT File:**  
S:\EMC LAB\common\DAMATEC\LPU\_TNG\Data\Fcc1.eut  
**Order Number:**

**EUT**  
Name: LPU-TNG  
Serial Number: 0001

**Client**  
Name: Dmatek  
Contact Person: Alex Rachman

**Radiated Emission**

Description: 23) RE FCC CLASS B calibration 1000MHz  
From 992 MHz to 996 MHz  
**Graph:**

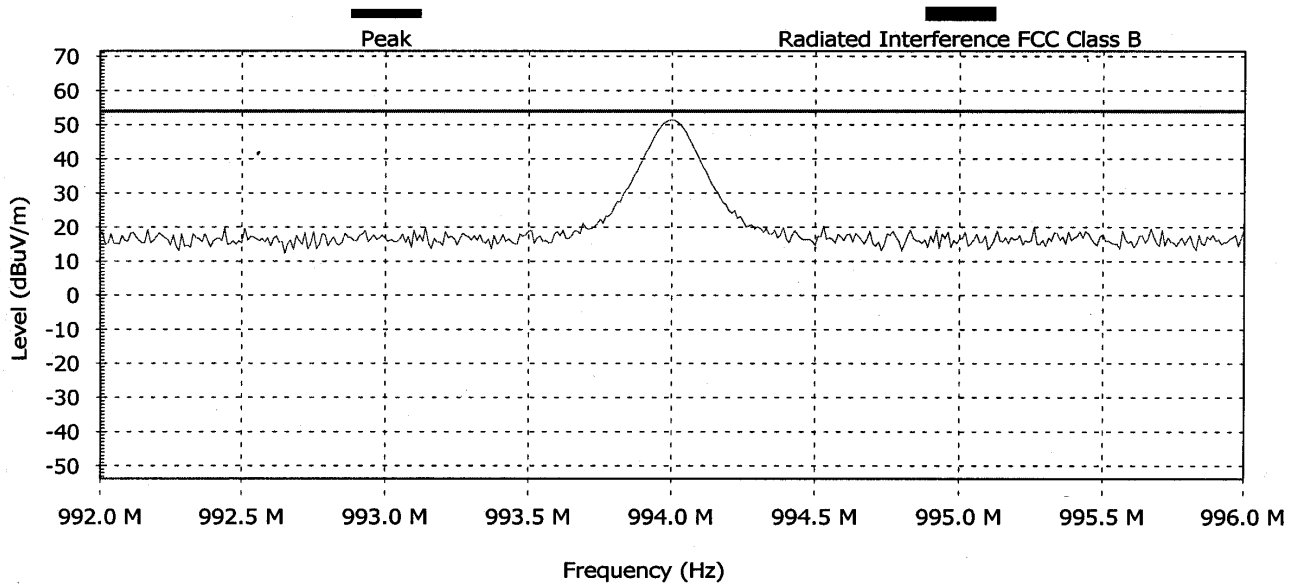

**Detected Peaks:**

Nr	Frequency (MHz)	PK (dBuV/m)	PK Limit (dBuV/m)	PK Pass	Pass	Angle (degrees)	Height (m)
1	994	53.6		Pass	Pass	270	2

**Settings:**

Antenna: Horizontal at 3 m  
Ref. Level: 70.0 dBuV/m Att: 0 dB. RBW: 120 kHz. VBW: 1000 kHz. Sweep time: 20 ms.  
Detect all peaks above 6 dB below the limit lines with a maximum of 6 peaks.  
Measure the peaks with the peak detector

**Note:**

Calibration for 994MHz , 54dbuV

**Plot REcal/ 3**

**EUT File:**  
S:\EMC\_LAB\common\DAMATEC\LPU\_TNG\Data\Fcc1.eut  
**Order Number:**

**EUT**  
Name: LPU-TNG  
Serial Number: 0001

**Client**  
Name: Dmatek  
Contact Person: Alex Rachman

**Radiated Emission**

Description: 29) RE FCC CLASS B calibration 2000MHz  
From 1984 MHz to 1988 MHz

**Graph:**

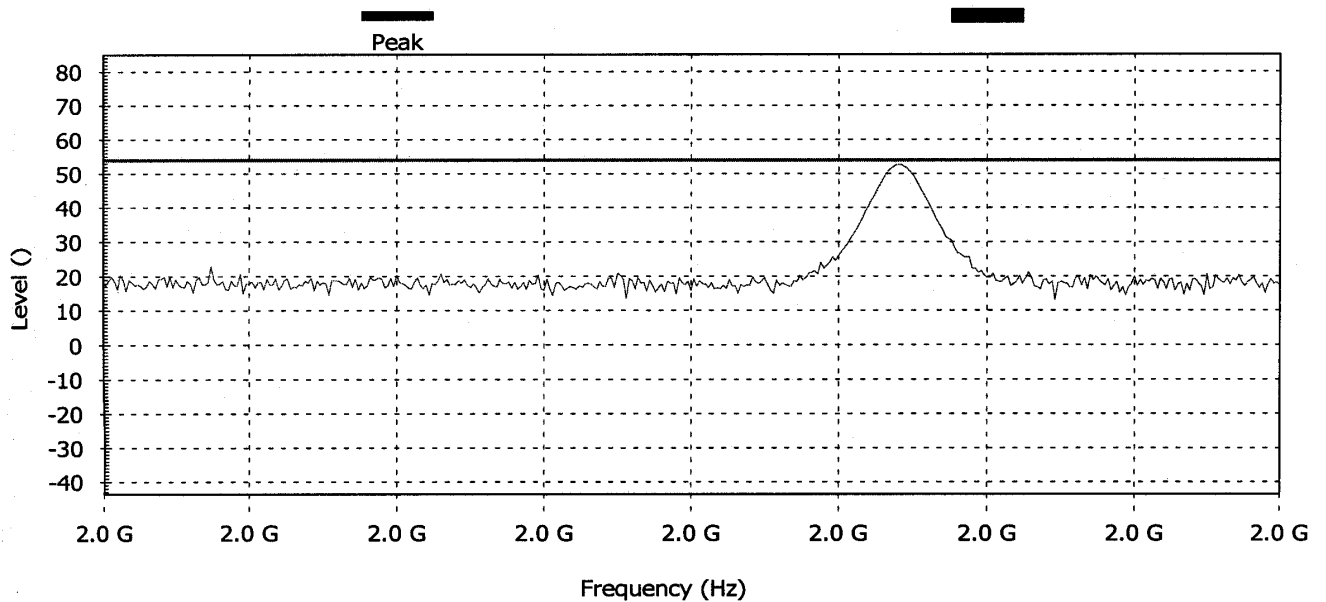

**Detected Peaks:**

Nr	Frequency (MHz)	PK (dBuV/m)	PK Limit (dBuV/m)	PK Pass	Pass	Angle (degrees)	Height (m)
1	1986.703	54.8	54.0	Pass	Pass	275	2

**Settings:**

Antenna: Horizontal at 3 m  
Ref. Level: 70.0 dBuV/m Att: 0 dB. RBW: 120 kHz. VBW: 1000 kHz. Sweep time: 20 ms.  
Detect all peaks above 6 dB below the limit lines with a maximum of 6 peaks.  
Measure the peaks with the peak detector

**Note:**

CALIBRATION FOR 1986MHz 54dbuV

**Plot REcal/ 4**



**EUT File:**  
S:\EMC\_LAB\common\DAMATEC\LPU\_TNG\Data\Fcc1.eut  
**Order Number:**

**EUT**  
Name: LPU-TNG  
Serial Number: 0001

**Client**  
Name: Dmatek  
Contact Person: Alex Rachman

**Radiated Emission**  
Description: 5) RE FCC CLASS B 30-200MHz  
From 30 MHz to 200 MHz

**Graph:**

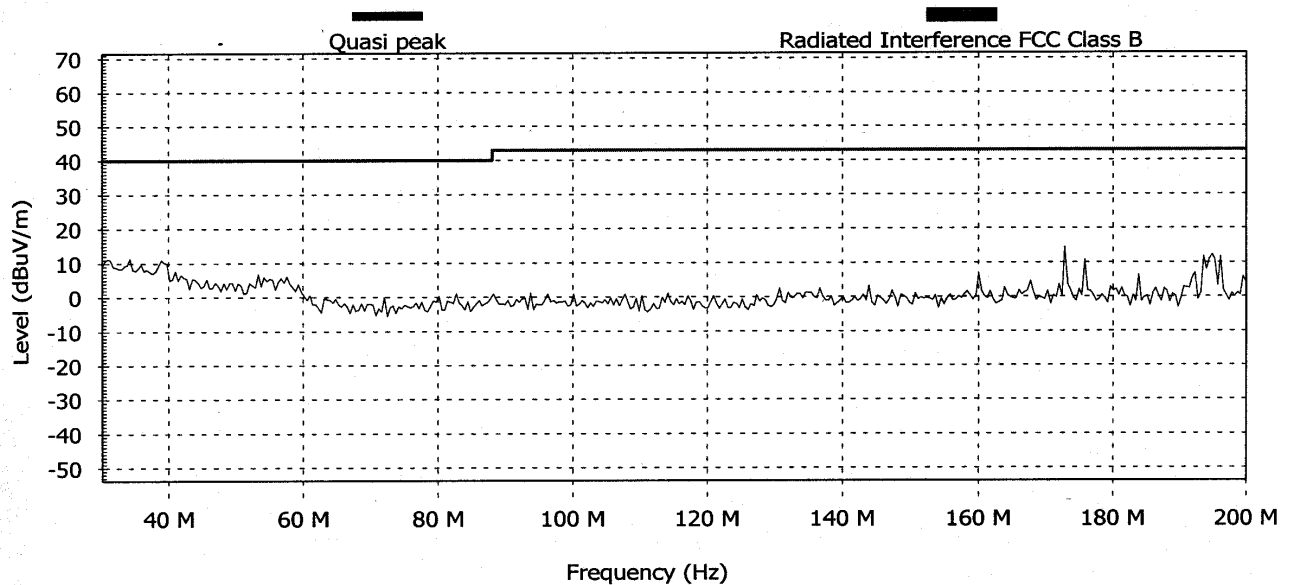

**Detected Peaks:**

Nr	Frequency (MHz)	PK (dBuV/m)	AVG (dBuV/m)	QP (dBuV/m)	RMS (dBuV/m)	PK Limit (dBuV/m)	AVG Limit (dBuV/m)	QP Limit (dBuV/m)	RMS Limit (dBuV/m)	PK Pass	AVG Pass	QP Pass	RMS Pass	Pass	Angle (degrees)	Height (m)

**Settings:**

Antenna: Both Polarizations at 3 m  
Ref. Level: 70.0 dBuV/m Att: 0 dB. RBW: 120 kHz. VBW: 1000 kHz. Sweep time: 35.4169998168  
Detect all peaks above 6 dB below the limit lines with a maximum of 6 peaks.  
Measure the peaks with the quasi-peak detector

**Note:**  
battery only

**Plot RE/ 1**

**EUT File:**  
S:\EMC\_LAB\common\DAMATEC\LPU\_TNG\Data\Fcc1.eut  
**Order Number:**

**EUT**  
Name: LPU-TNG  
Serial Number: 0001

**Client**  
Name: Dmatek  
Contact Person: Alex Rachman

**Radiated Emission**

Description: 6) RE FCC CLASS B 200-1000 MHz  
From 200 MHz to 1000 MHz

**Graph:**

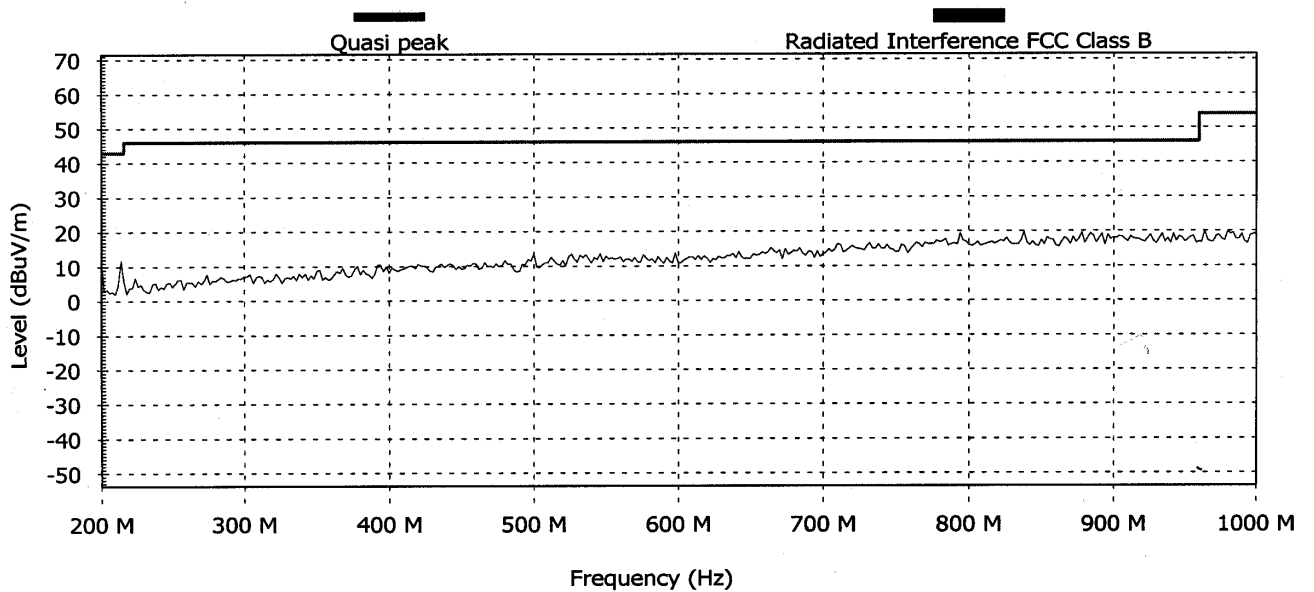

**Detected Peaks:**

Nr	Frequency (MHz)	PK (dBuV/m)	AVG (dBuV/m)	QP (dBuV/m)	RMS (dBuV/m)	PK Limit (dBuV/m)	AVG Limit (dBuV/m)	QP Limit (dBuV/m)	RMS Limit (dBuV/m)	PK Pass	AVG Pass	QP Pass	RMS Pass	Pass	Angle (degrees)	Height (m)

**Settings:**

Antenna: Both Polarizations at 3 m  
Ref. Level: 70.0 dBuV/m Att: 0 dB. RBW: 120 kHz. VBW: 1000 kHz. Sweep time: 166.666992187  
Detect all peaks above 6 dB below the limit lines with a maximum of 6 peaks.  
Measure the peaks with the quasi-peak detector

**Note:**  
battery only

**Plot RE/ 2**

**EUT File:**

S:\EMC LAB\common\DAMATEC\LPU\_TNG\Data\Fcc1.eut

**Order Number:**

**EUT**

Name: LPU-TNG  
Serial Number: 0001

**Client**

Name: Dmatek  
Contact Person: Alex Rachman

**Radiated Emission**

Description: 34) RE FCC CLASS B 1-2GHz  
From 1000 MHz to 2000 MHz

**Graph:**

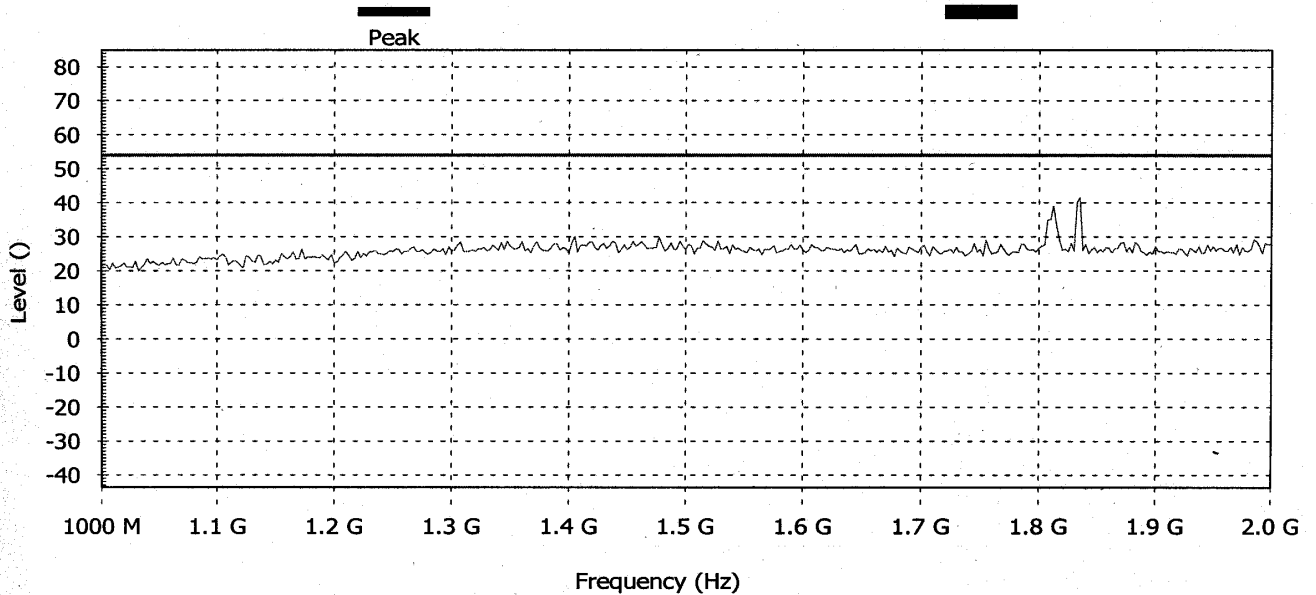

**Detected Peaks:**

Nr	Frequency (MHz)	PK (dBuV/m)	AVG (dBuV/m)	QP (dBuV/m)	RMS (dBuV/m)	PK Limit (dBuV/m)	AVG Limit (dBuV/m)	QP Limit (dBuV/m)	RMS Limit (dBuV/m)	PK Pass	AVG Pass	QP Pass	RMS Pass	Pass	Angle (degrees)	Height (m)

**Settings:**

Antenna: Both Polarizations at 3 m  
Ref. Level: 70.0 dBuV/m Att: 0 dB. RBW: 1000 kHz. VBW: 1000 kHz. Sweep time: 20 ms.  
Detect all peaks above 6 dB below the limit lines with a maximum of 10 peaks.  
Measure the peaks with the peak detector

**Note:**

Battery only

**Plot RE/ 3**

**EUT File:**  
S:\EMC\_LAB\common\DAMATEC\LPU\_TNG\Data\Fcc1.eut  
**Order Number:**

**EUT**  
Name: LPU-TNG  
Serial Number: 0001

**Client**  
Name: Dmatek  
Contact Person: Alex Rachman

**Radiated Emission**

Description: 24) RE FCC CLASS B 2-6GHz  
From 2000 MHz to 5000 MHz

**Graph:**

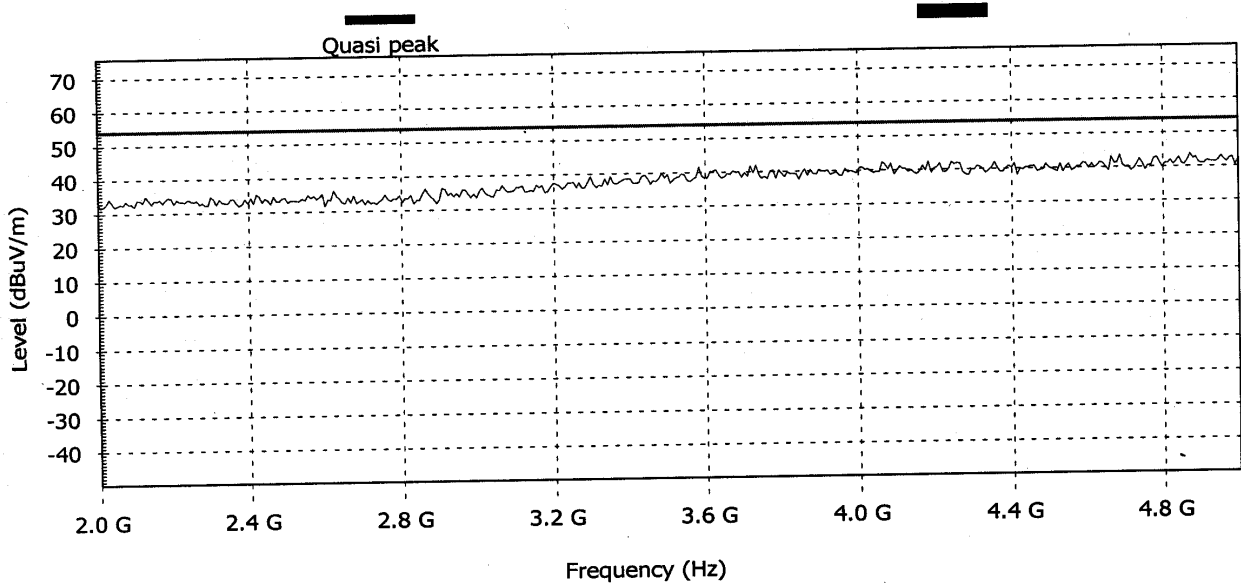

**Detected Peaks:**

Nr	Frequency (MHz)	PK (dBuV/m)	AVG (dBuV/m)	QP (dBuV/m)	RMS (dBuV/m)	PK Limit (dBuV/m)	AVG Limit (dBuV/m)	QP Limit (dBuV/m)	RMS Limit (dBuV/m)	PK Pass	AVG Pass	QP Pass	RMS Pass	Pass	Angle (degrees)	Height (m)

**Settings:**

Antenna: Both Polarizations at 3 m  
Ref. Level: 70.0 dBuV/m Att: 0 dB. RBW: 1000 kHz. VBW: 1000 kHz. Sweep time: 46.427997589  
Detect all peaks above 6 dB below the limit lines with a maximum of 6 peaks.  
Measure the peaks with the quasi-peak detector

**Note:**  
battery only

**Plot RE/ 4**

**EUT File:**

S:\EMC\_LAB\common\DAMATEC\LPU\_TNG\Data\Fcc1.eut

**Order Number:**

**EUT**

Name: LPU-TNG

Serial Number: 0001

**Client**

Name: Dmatek

Contact Person: Alex Rachman

**Radiated Emission**

Description: 2) RE FCC CLASS B 30-200MHz

From 30 MHz to 200 MHz

**Graph:**

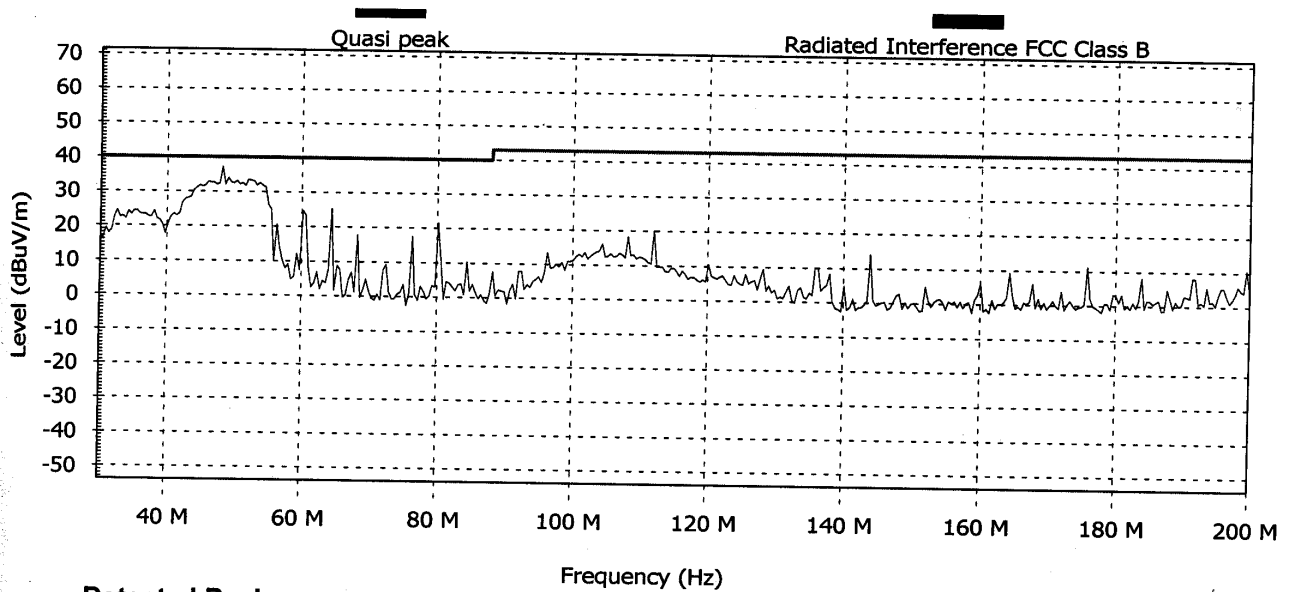

**Detected Peaks:**

Nr	Frequency (MHz)	PK (dBuV/m)	QP (dBuV/m)	PK Limit (dBuV/m)	QP Limit (dBuV/m)	PK Pass	QP Pass	Pass	Angle (degrees)	Height (m)
1	48	43.3	31.1		40.0	Pass	Pass	Pass	270	1

**Settings:**

Antenna: Both Polarizations at 3 m

Ref. Level: 70.0 dBuV/m Att: 0 dB. RBW: 120 kHz. VBW: 1000 kHz. Sweep time: 35.4169998168

Detect all peaks above 6 dB below the limit lines with a maximum of 6 peaks.

Measure the peaks with the quasi-peak detector

**Note:**

with transformer

**Plot RE/ 5**

**EUT File:**

S:\EMC LAB\common\DAMATEC\LPU\_TNG\Data\Fcc1.eut

**Order Number:**

**EUT**

Name: LPU-TNG

Serial Number: 0001

**Client**

Name: Dmatek

Contact Person: Alex Rachman

**Radiated Emission**

Description: 4) RE FCC CLASS B 200-1000 MHz

From 200 MHz to 1000 MHz

**Graph:**

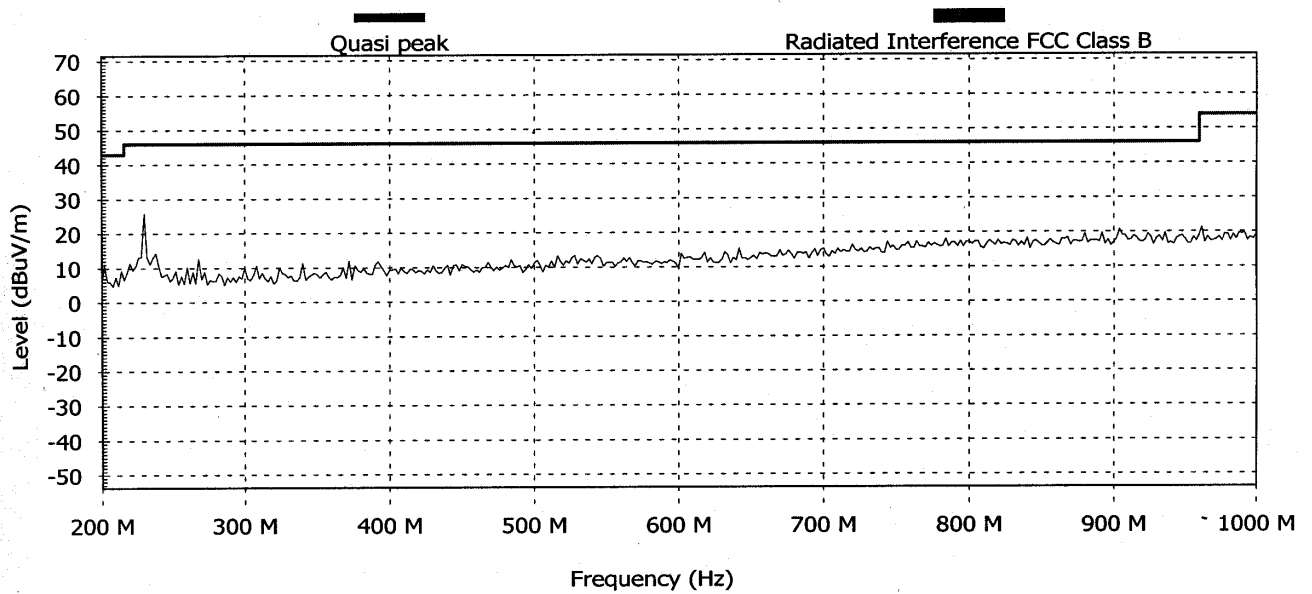

**Detected Peaks:**

Nr	Frequency (MHz)	PK (dBuV/m)	AVG (dBuV/m)	QP (dBuV/m)	RMS (dBuV/m)	PK Limit (dBuV/m)	AVG Limit (dBuV/m)	QP Limit (dBuV/m)	RMS Limit (dBuV/m)	PK Pass	AVG Pass	QP Pass	RMS Pass	Pass	Angle (degrees)	Height (m)

**Settings:**

Antenna: Both Polarizations at 3 m

Ref. Level: 70.0 dBuV/m Att: 0 dB. RBW: 120 kHz. VBW: 1000 kHz. Sweep time: 166.666992187

Detect all peaks above 6 dB below the limit lines with a maximum of 6 peaks.

Measure the peaks with the quasi-peak detector

**Note:**

with transformer

**Plot RE/ 6**

**EUT File:**  
S:\EMC\_LAB\common\DAMATEC\LPU\_TNG\Data\Fcc1.eut  
**Order Number:**

**EUT**  
Name: LPU-TNG  
Serial Number: 0001

**Client**  
Name: Dmatek  
Contact Person: Alex Rachman

**Radiated Emission**

Description: 35) RE FCC CLASS B 1-2GHz  
From 1000 MHz to 2000 MHz

**Graph:**

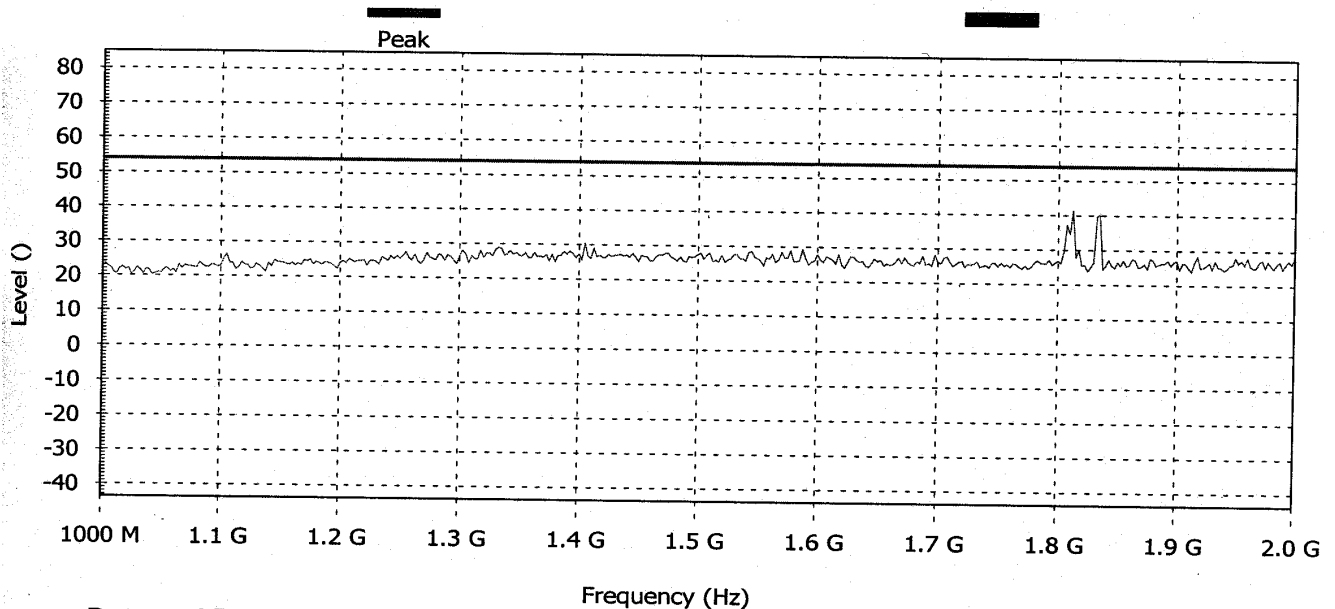

**Detected Peaks:**

Nr	Frequency (MHz)	PK (dBuV/m)	AVG (dBuV/m)	QP (dBuV/m)	RMS (dBuV/m)	PK Limit (dBuV/m)	AVG Limit (dBuV/m)	QP Limit (dBuV/m)	RMS Limit (dBuV/m)	PK Pass	AVG Pass	QP Pass	RMS Pass	Pass	Angle (degrees)	Height (m)

**Settings:**

Antenna: Both Polarizations at 3 m  
Ref. Level: 70.0 dBuV/m Att: 0 dB. RBW: 1000 kHz. VBW: 1000 kHz. Sweep time: 20 ms.  
Detect all peaks above 6 dB below the limit lines with a maximum of 10 peaks.  
Measure the peaks with the peak detector

**Note:**  
with transformator

**Plot RE/ 7**

**EUT File:**  
S:\EMC LAB\common\DAMATEC\LPU\_TNG\Data\Fcc1.eut  
**Order Number:**

**EUT**  
Name: LPU-TNG  
Serial Number: 0001

**Client**  
Name: Dmatek  
Contact Person: Alex Rachman

**Radiated Emission**  
Description: 25) RE FCC CLASS B 2-6GHz  
From 2000 MHz to 5000 MHz

**Graph:**

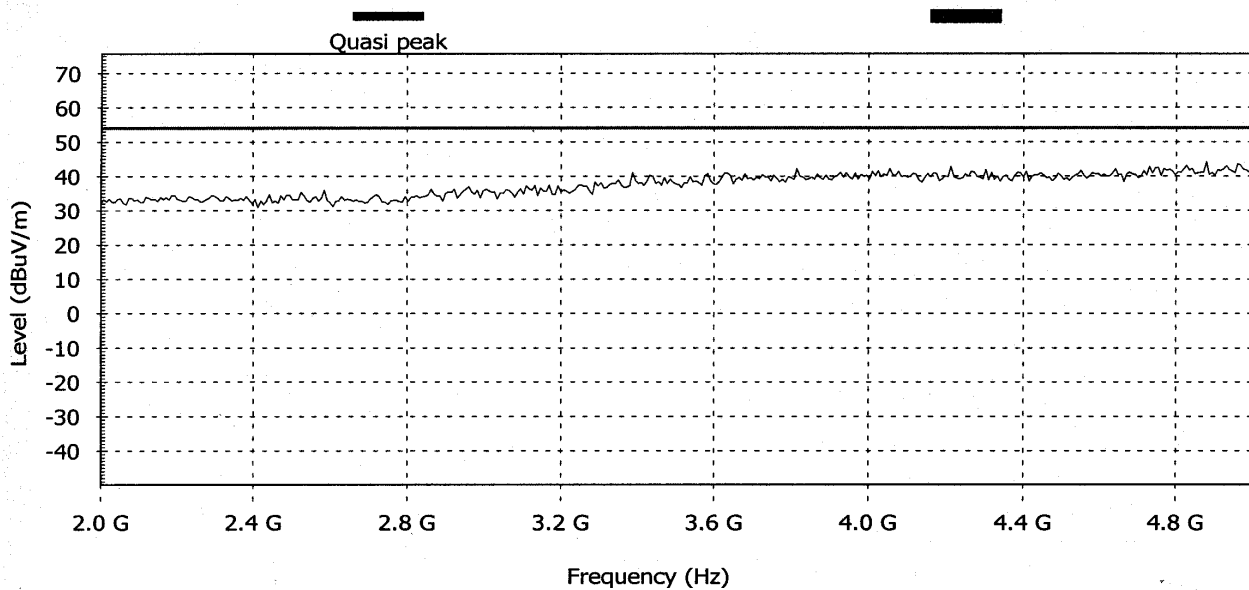

**Detected Peaks:**

Nr	Frequency (MHz)	PK (dBuV/m)	AVG (dBuV/m)	QP (dBuV/m)	RMS (dBuV/m)	PK Limit (dBuV/m)	AVG Limit (dBuV/m)	QP Limit (dBuV/m)	RMS Limit (dBuV/m)	PK Pass	AVG Pass	QP Pass	RMS Pass	Pass	Angle (degrees)	Height (m)

**Settings:**

Antenna: Both Polarizations at 3 m  
Ref. Level: 70.0 dBuV/m Att: 0 dB. RBW: 1000 kHz. VBW: 1000 kHz. Sweep time: 46.427997589  
Detect all peaks above 6 dB below the limit lines with a maximum of 6 peaks.  
Measure the peaks with the quasi-peak detector

**Note:**  
with biconical 3m

**Plot RE/ 8**



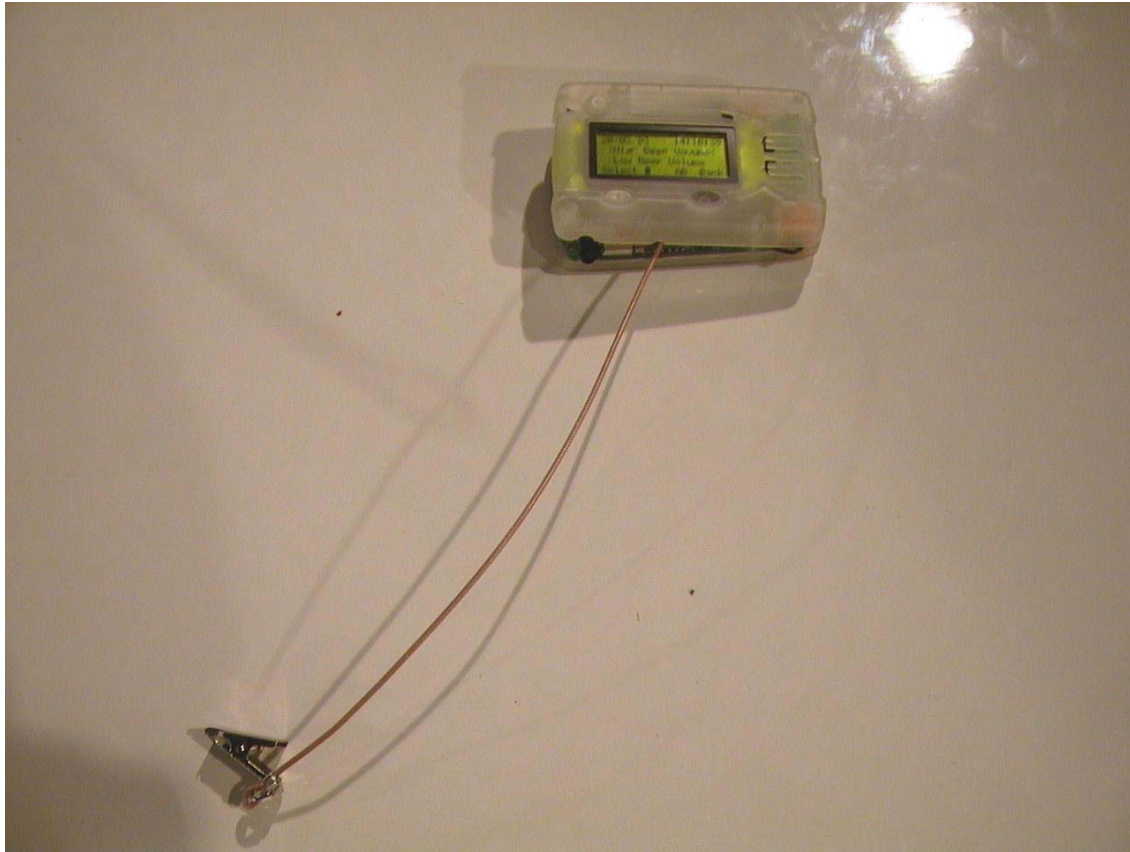

**Picture RE/1 Set up for Battery only Configuration**



**Picture RE/2 Set up for Battery only Configuration**

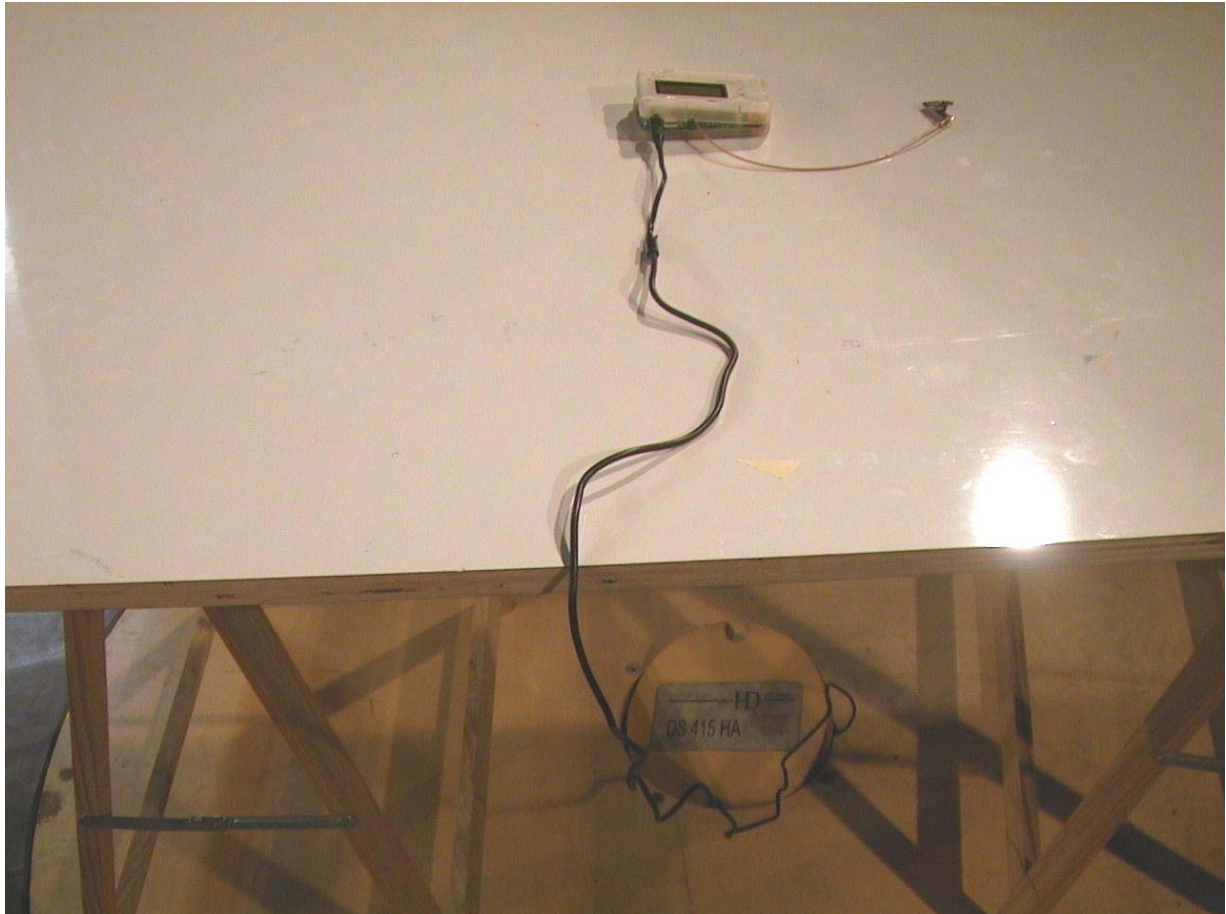

**Picture RE/3 Set up for AC Adapter Configuration**

## 7 FINAL RADIATED INTERFERENCE FIELD STRENGTH EASUREMENT

Testing Engineer: D.Lanuel *[Signature]*

Date 20/05/03

### a. Test Instrumentation and Equipment

**Table RE-A Test Instrumentation and Equipment**

Item	Model	Manufacturer	Next Date Cal.
Spectrum Analyzer	8568B+opt 462	HP	12.08.03
Preselector	85685A	HP	12.08.03
Quasi-Peak Detector	85650	HP	12.08.03
Broadband Antenna	BTA-L	FRANKONIA	10.04.04
Computer	PENTIUM	IBM Comp.	N.P.C.R

### b. Test Setup

- (1) The measuring system block diagram shown in Figure RE-A.
- (2) E.U.T orientation and antenna position shown in Figure RE-B
- (3) Cables configuration shown in Figure RE-C

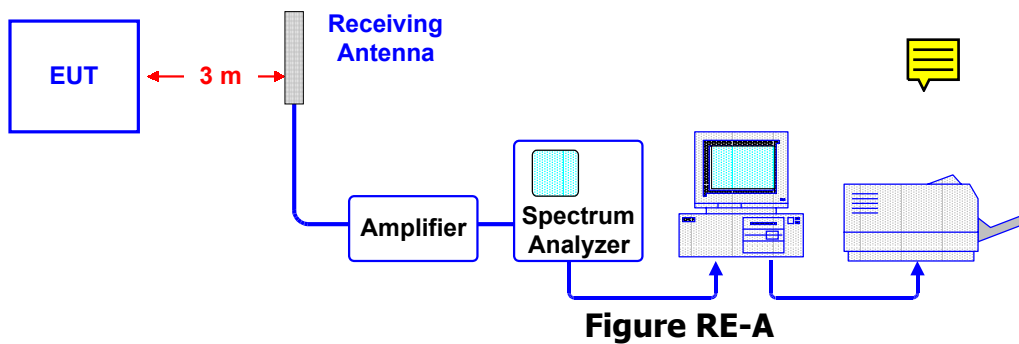

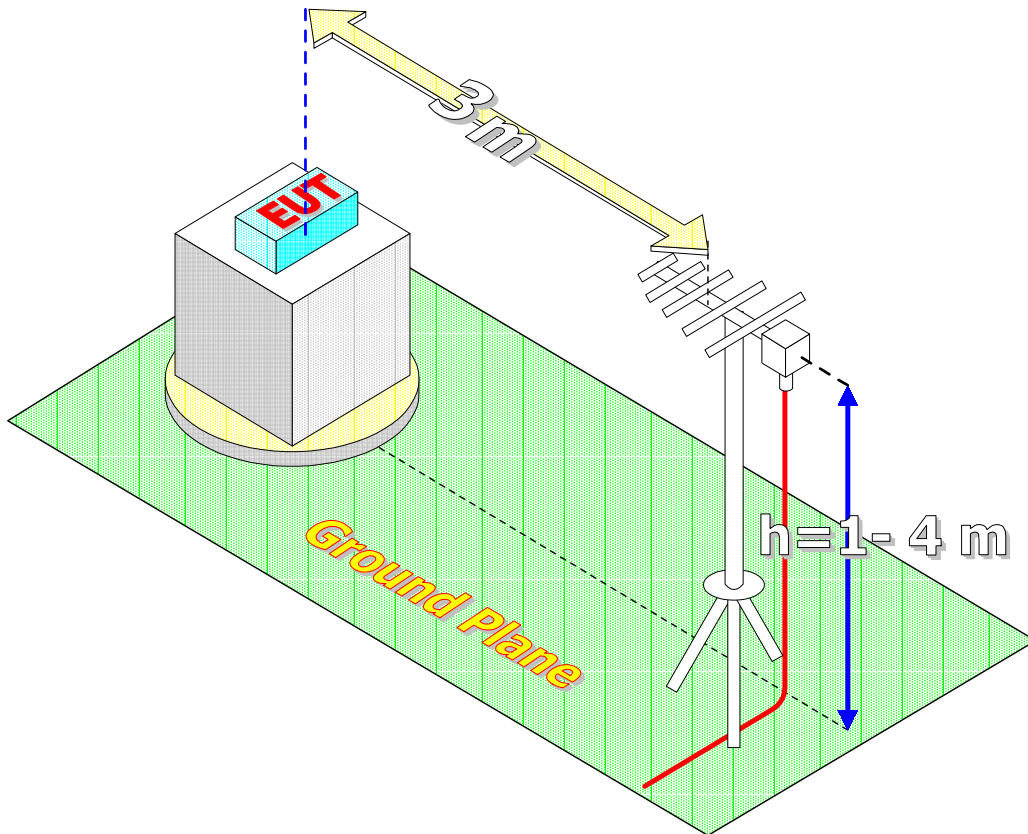

**Figure RE-B**

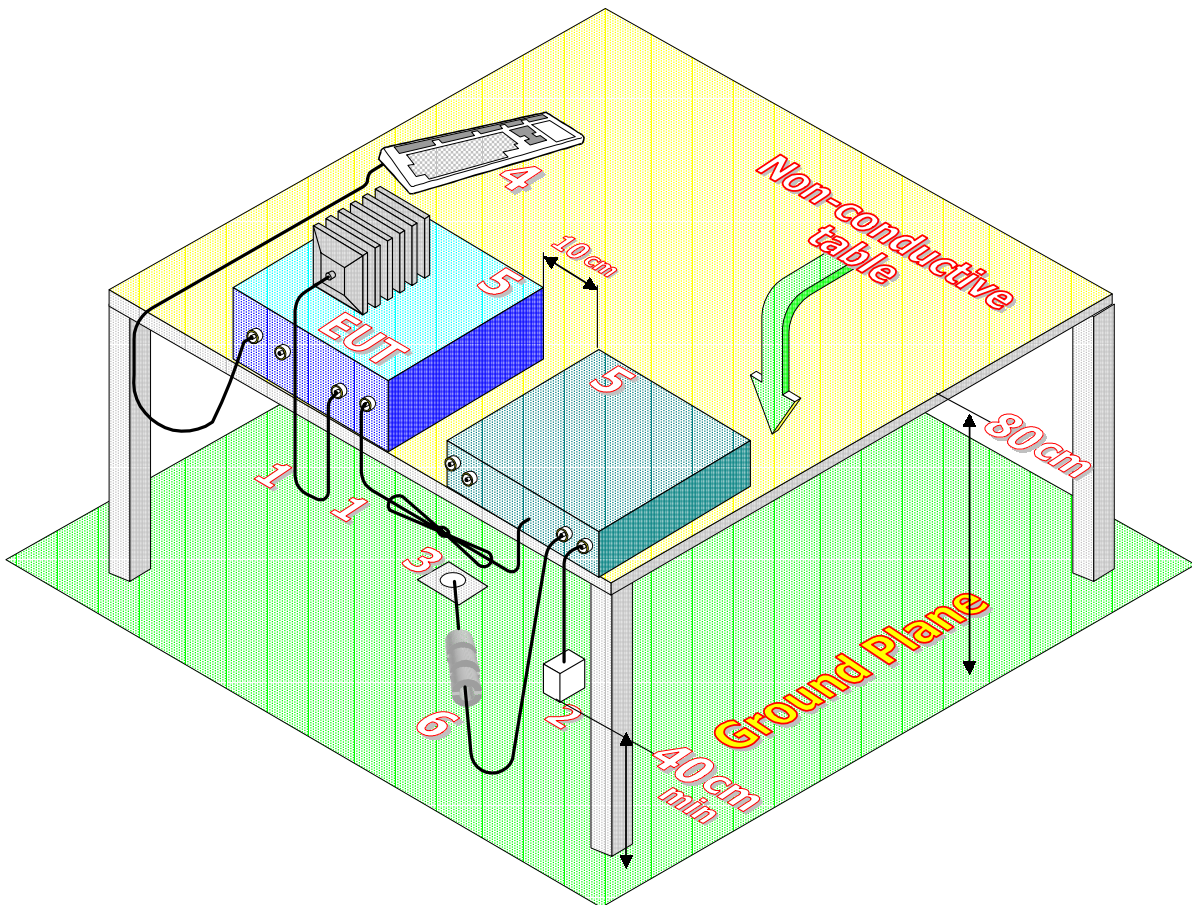

**Figure RE-C**

1. If cables, which hand closer than 40 cm to the horizontal ground plane cannot be shortened to the appropriate length, the excess shall be folded back and forth forming a bundle 30 cm to 40 cm long.
2. The end of I/O signal cables, which are not connected to a peripheral, may be terminated, if required to proper operation using correct terminating impedance.  
Main junction boxes shall be flush with, and bonded directly to, metal ground plane
4. Cables of hand operated devices such as keyboards, mouses; etc. shall be placed as for normal usage.
5. Peripherals shall be placed at distance 10 cm from each other and from the controller, except for the monitor, which, if for an acceptable installation practice, shall be placed directly on top of the controller.
- 6 Mains cables, telephone lines or other connections to auxiliary equipment located outside the test area shall drape to the floor, be fitted with ferrite clamps or ferrite tubes placed on the floor at the point where the cable reaches the floor and then routed to the place where they leave the turn table. No extension cords shall be used to mains receptacle.  
Ferrite clamps or ferrite tubes. No more than one cable per clamp.

**c. Final Test Results**

**Table RE-B Six Highest Emissions RX Mode 15.109**

Mode Of Operation	Freq. (MHz)	Quasi-peak Reading (*) (dB $\mu$ V/m)	Limit dB $\mu$ V/m	Margin (dB)	Polarity Ver/Hor	Height (m)
RX Battery Only Config.	All Range	Background Noise				

(\*)Resolution B/W = 120 kHz

**Table RE-C Six Highest Emissions RX Mode 15.109**

Mode Of Operation	Freq. (MHz)	Quasi-peak Reading(*) (dB $\mu$ V/m)	Limit dB $\mu$ V/m	Margin (dB)	Polarity Ver/Hor	Height (m)
RX AC Adapter	48	32	40	8	H	1
	All Range	Background Noise				

(\*)Resolution B/W = 120 kHz

## 8 CONDUCTED EMISSIONS, AC POWER LEADS ACCORDING TO FCC 15.107

Frequency Range: 150 kHz – 30 MHz

Testing Engineer: D.Lanuel *[Signature]*

Date : 20/05/03

### a. Equipment Under Test Description and Operation

LSQ-LPU-800, S/N 0001 manufactured by ELMOTECH LTD.

#### (1) Modes of Operation

The LSQ-LPU-800 was set to Battery Charge at RX Mode

#### (2) Operating Voltage **110 V, AC 60Hz**

### b. Test Results Summary & Conclusions

The LSQ-LPU-800 complies with FCC, Part 15.107 conducted emissions requirement.

### c. Limits of Conducted Emission at Mains Terminals

The test unit shall meet the limits of Table CE-1 for FCC Part 15 Para 15.107 equipment.

**Table CE-1 Limits for intentional radiator according 15.107**

Frequency Range MHz	Quasi-peak Limits dB $\mu$ V
0.15 – 0.50	66 to 56*
0.50 - 5	56
5 - 30	60

\*Decreases with the logarithm of the frequency

### d. Test Instrumentation and Equipment

**Table CE-2 – Test Instrumentation and Equipment**

Item	Model	Manufacturer	Next Date Calibration
Spectrum Analyzer	8593E	HP	31/01/04
Signal Generator	2017	Marconi	21/06/03
LISN	FCC-LISN-3B	FISCHER	31/08/04

**e. Test Setup**

- (1) Calibration setup shown in Figure CE-1.
- (2) The testing setup shown in Figure CE-2.
- (3) configurations for Equipment and cable are shown in Figure CE-3.

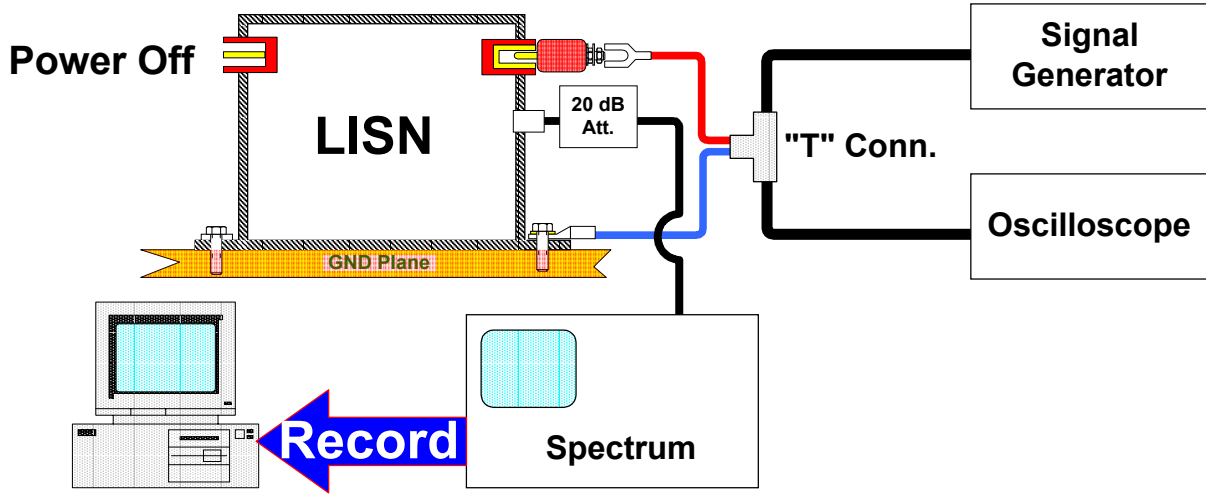

**Figure CE-1**

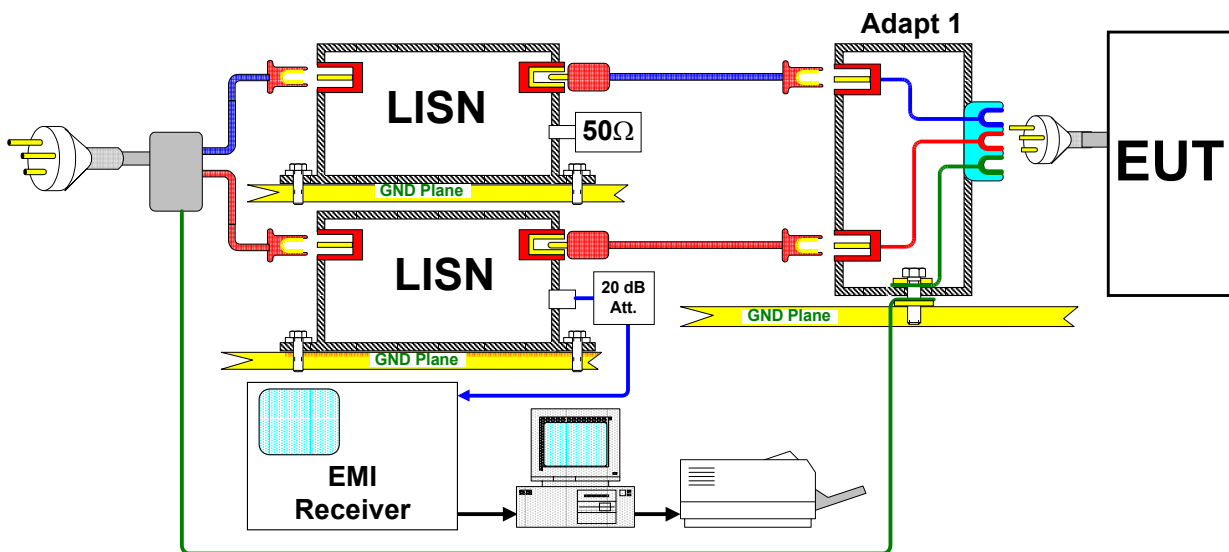

**Figure CE-2**





**f. Test Procedure**

The test procedure shall be as follows:

- (1) Calibration.  
Perform the measured system check using the calibration setup shown in Figure CE-1.
- (2) Turn on the measurement equipment and allow sufficient time for stabilization.
- (3) Apply the calibrated signal level, which is 6 dB below the limit given in Table 1 at 500kHz and 29 MHz to the power output terminal of LISN.
- (4) Scan the spectrum analyzer for each frequency in the same manner as a normal data scan. Verify that the spectrum analyzer indicates a level within  $\pm 3$  dB of injected level. Correction factor shall be applied for LISN and 20 dB for attenuator.
- (5) E.U.T Testing. Perform emission data scan using the measurement setup shown in Figures CE-2 and CE-3.
- (6) Turn on the E.U.T to operational mode and allow sufficient time for stabilization.
- (7) Select (Phase) lead for testing.
- (8) Scan the spectrum analyzer over the applicable frequency range
- (9) Repeat (2) and (3) for (Neutral) lead.
- (10) Choose six highest emissions relative to limit and feel Table CE-3.
- (11) Perform measurements for selected frequencies using quasi-peak detector.

**Table CE-3 Calibration Results**

Lead P/N	Frequency MHz	Plot No.	Test Signal DBuV(peak)	Result dBuV	Deviation dB
Neutral	0.5	CE-CAL/ 1	48	48.1	0.1
	10	CE-CAL/ 2	48	48	0
	29	CE-CAL/ 3	48	47.4	-0.6
Phase(Line 2)	0.5	CE-CAL/ 4	48	47.4	-0.6
	10	CE-CAL/ 5	48	48.1	0.1
	29	CE-CAL/ 6	48	47.6	-0.4

**Table CE-4 Test Results 15.107**

Lead P/N	Mode of Operation	Frequency Range (MHz)	Resolution BW (kHz)	Plot No.	Comply. Y/N
Neutral	RX	0.15 – 0.5	9	CE/ 1	Y
		0.5 - 1		CE/ 2	Y
		1 - 30		CE/ 3	Y
Phase	RX	0.15 – 0.5	9	CE/ 4	Y
		0.5 - 1		CE/ 5	Y
		1 - 30		CE/ 6	Y

**EUT File:**

S:\EMC LAB\common\DAMATEC\LPU\_TNG\Data\Fcc1.eut

**Order Number:**

**EUT**

Name: LPU-TNG

Serial Number: 0001

**Client**

Name: Dmatek

Contact Person: Alex Rachman

**Conducted Emission LISN**

Description: 50) Calibration 500KHz CE FCC CLASS B

From 0.499 MHz to 0.501 MHz

**Graph:**

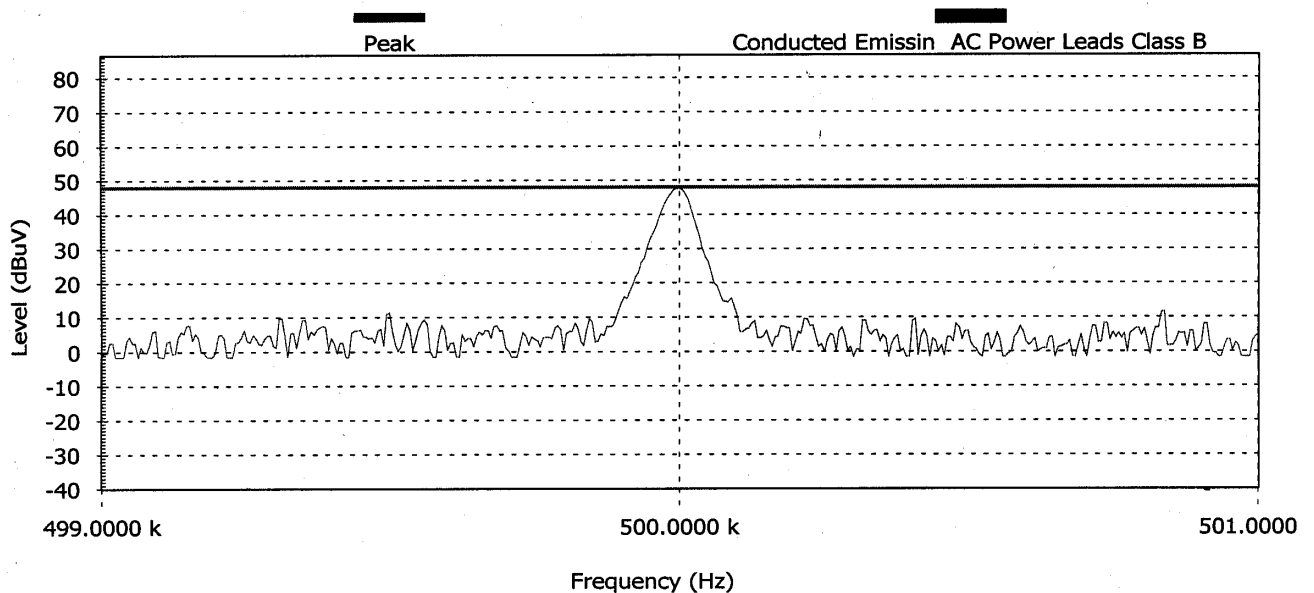

**Detected Peaks:**

Nr	Frequency (MHz)	PK (dBuV)	PK Limit (dBuV)	PK Pass	Pass	Line
1	0.5	44.7		Pass	Pass	Neutral

**Settings:**

Description: 50) Calibration 500KHz CE FCC CLASS B

From 0.499 MHz to 0.501 MHz

Ref. Level: 60.0 dBuV Att: 0 dB. RBW: 2.99999993294477E-02 kHz. VBW: 2.99999993294477E-

Detect all peaks above 6 dB below the limit lines with a maximum of 1 peaks.

Measure the peaks with the peak detector

**Note:**

Calibration for 500KHz 48dbuV ,LISN Neutral

**Plot CEcal/ 1**

**EUT File:**  
S:\EMC\_LAB\common\DAMATEC\LPU\_TNG\Data\Fcc1.eut  
**Order Number:**

**EUT**  
Name: LPU-TNG  
Serial Number: 0001

**Client**  
Name: Dmatek  
Contact Person: Alex Rachman

**Conducted Emission CISPR LISN**

Description: 54) Calibration 10MHz CE FCC CLASS B  
From 9.5 MHz to 10.5 MHz

**Graph:**

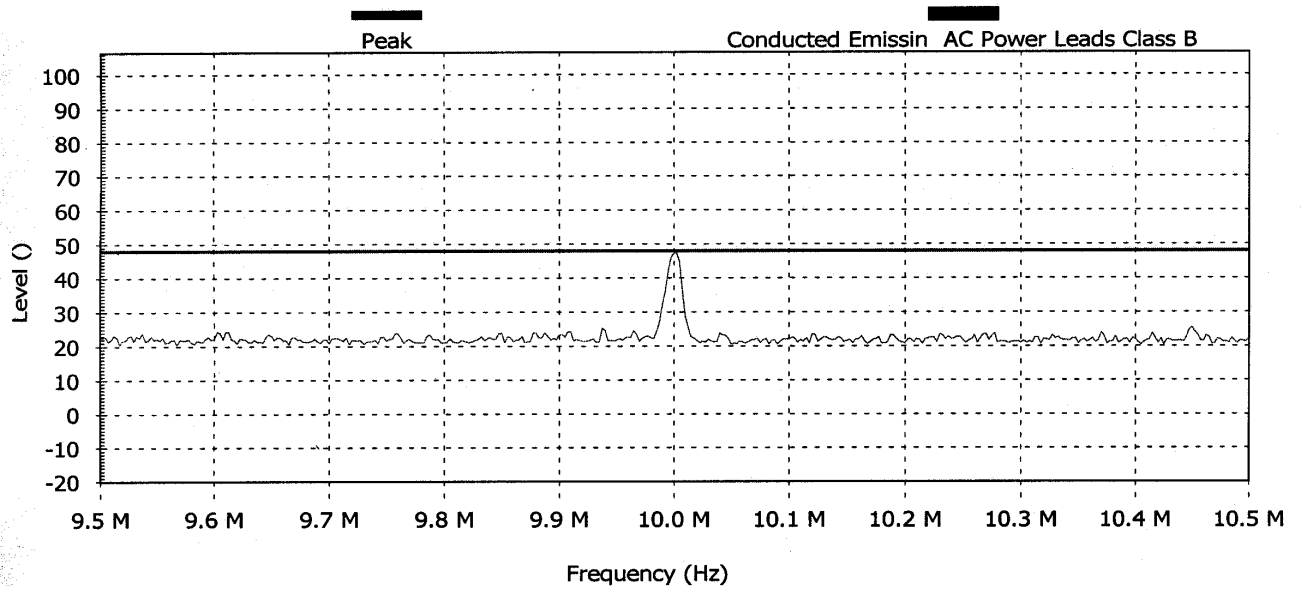

**Detected Peaks:**

Nr	Frequency (MHz)	PK (dBuV/m)	PK Limit (dBuV/m)	PK Pass	Pass	Line
1	10	48.0		Pass	Pass	Neutral

**Settings:**

Description: 54) Calibration 10MHz CE FCC CLASS B  
From 9.5 MHz to 10.5 MHz  
Ref. Level: 80.0 dBuV/m Att: 0 dB. RBW: 9 kHz. VBW: 30 kHz. Sweep time: 37.0369987487793 r  
Detect all peaks above 6 dB below the limit lines with a maximum of 1 peaks.  
Measure the peaks with the peak detector

**Note:**

Calibration for 10MHz 48dbuV , LISN Neutral

**Plot CEcal/ 2**

**EUT File:**  
S:\EMC LAB\common\DAMATEC\LPU\_TNG\Data\Fcc1.eut  
**Order Number:**

**EUT**  
Name: LPU-TNG  
Serial Number: 0001

**Client**  
Name: Dmatek  
Contact Person: Alex Rachman

**Conducted Emission LISN**  
  
Description: 49) Calibration 29MHz CE FCC CLASS B  
From 28.5 MHz to 29.5 MHz

**Graph:**

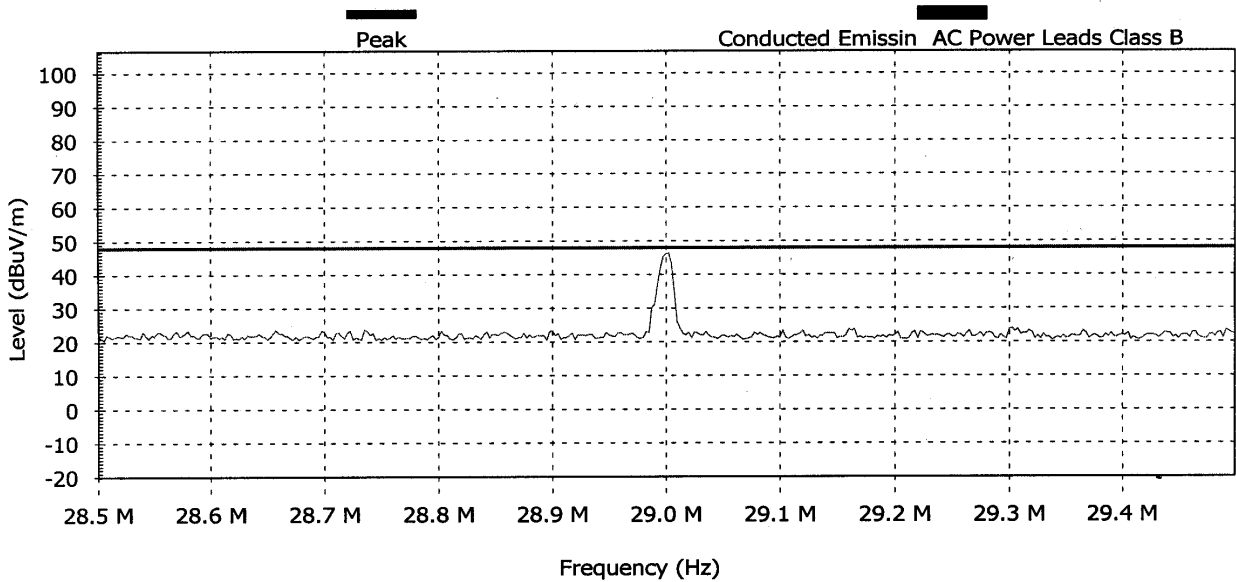

**Detected Peaks:**

Nr	Frequency (MHz)	PK (dBuV/m)	PK Limit (dBuV/m)	PK Pass	Pass	Line
1	29	47.4		Pass	Pass	Neutral

**Settings:**

Description: 49) Calibration 29MHz CE FCC CLASS B  
From 28.5 MHz to 29.5 MHz  
Ref. Level: 80.0 dBuV/m Att: 0 dB. RBW: 9 kHz. VBW: 30 kHz. Sweep time: 37.0369987487793 s  
Detect all peaks above 6 dB below the limit lines with a maximum of 1 peaks.  
Measure the peaks with the peak detector

**Note:**

Calibration for 30MHz 48dbuV, LISN Neutral

**Plot CEcal/ 3**

**EUT File:**

S:\EMC\_LAB\common\DAMATEC\LPU\_TNG\Data\Fcc1.eut

**Order Number:**

**EUT**

Name: LPU-TNG

Serial Number: 0001

**Client**

Name: Dmatek

Contact Person: Alex Rachman

**Conducted Emission LISN**

Description: 45) Calibration 500KHz CE FCC CLASS B

From 0.499 MHz to 0.501 MHz

**Graph:**

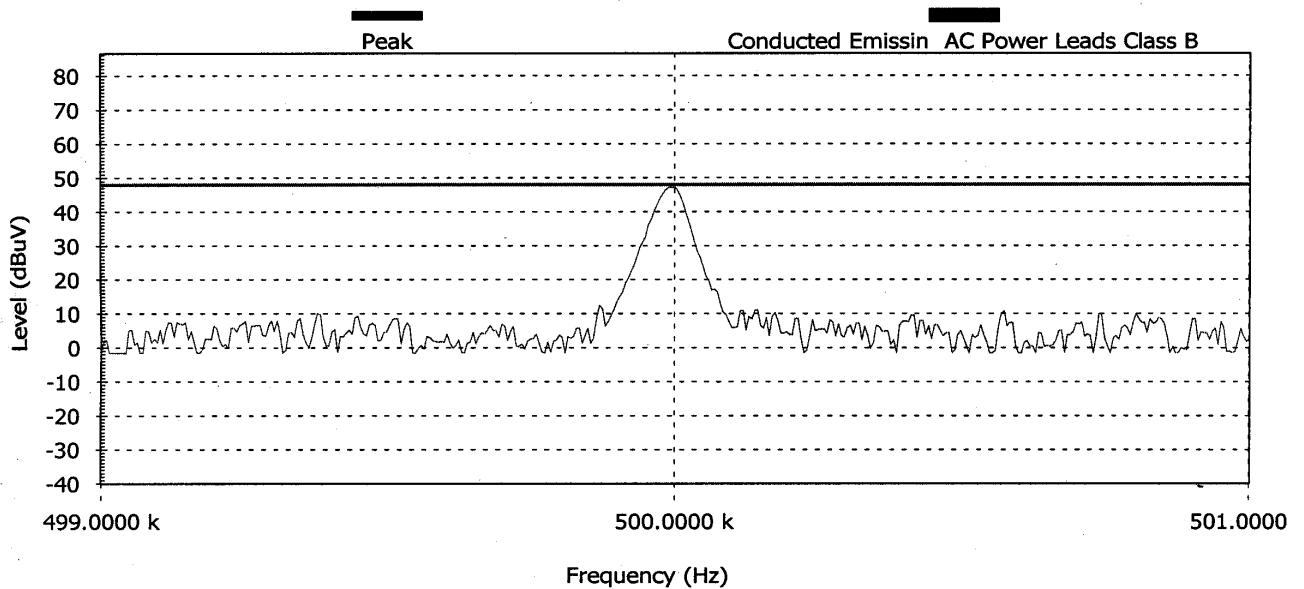

**Detected Peaks:**

Nr	Frequency (MHz)	PK (dBuV)	PK Limit (dBuV)	PK Pass	Pass	Line
1	0.5	47.4		Pass	Pass	Line 2

**Settings:**

Description: 45) Calibration 500KHz CE FCC CLASS B

From 0.499 MHz to 0.501 MHz

Ref. Level: 60.0 dBuV Att: 0 dB. RBW: 2.99999993294477E-02 kHz. VBW: 2.99999993294477E-

Detect all peaks above 6 dB below the limit lines with a maximum of 1 peaks.

Measure the peaks with the peak detector

**Note:**

Calibration for 500KHz 48dbuV , LISN PHASE

**Plot CEcal/ 4**

**EUT File:**  
S:\EMC\_LAB\common\DAMATEC\LPU\_TNG\Data\Fcc1.eut  
**Order Number:**

**EUT**  
Name: LPU-TNG  
Serial Number: 0001

**Client**  
Name: Dmatek  
Contact Person: Alex Rachman

**Conducted Emission CISPR LISN**

Description: 52) Calibration 10MHz CE FCC CLASS B  
From 9.5 MHz to 10.5 MHz

**Graph:**

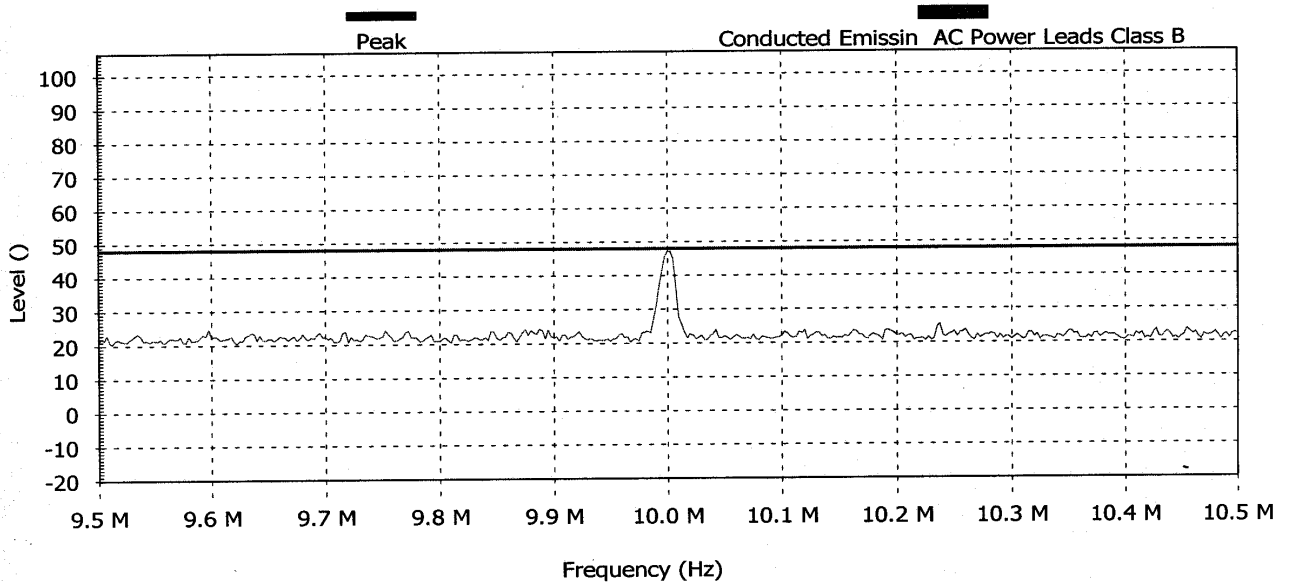

**Detected Peaks:**

Nr	Frequency (MHz)	PK (dBuV/m)	PK Limit (dBuV/m)	PK Pass	Pass	Line
1	10.001	48.1		Pass	Pass	Line 2

**Settings:**

Description: 52) Calibration 10MHz CE FCC CLASS B  
From 9.5 MHz to 10.5 MHz  
Ref. Level: 80.0 dBuV/m Att: 0 dB. RBW: 9 kHz. VBW: 30 kHz. Sweep time: 37.0369987487793 r  
Detect all peaks above 6 dB below the limit lines with a maximum of 1 peaks.  
Measure the peaks with the peak detector

**Note:**

Calibration for 10MHz 48dbuV, LISN PHASE

**Plot CEcal/ 5**

**EUT File:**  
S:\EMC\_LAB\common\DAMATEC\LPU\_TNG\Data\Fcc1.eut  
**Order Number:**

**EUT**  
Name: LPU-TNG  
Serial Number: 0001

**Client**  
Name: Dmatek  
Contact Person: Alex Rachman

**Conducted Emission LISN**

Description: 48) Calibration 29MHz CE FCC CLASS B  
From 28.5 MHz to 29.5 MHz

**Graph:**

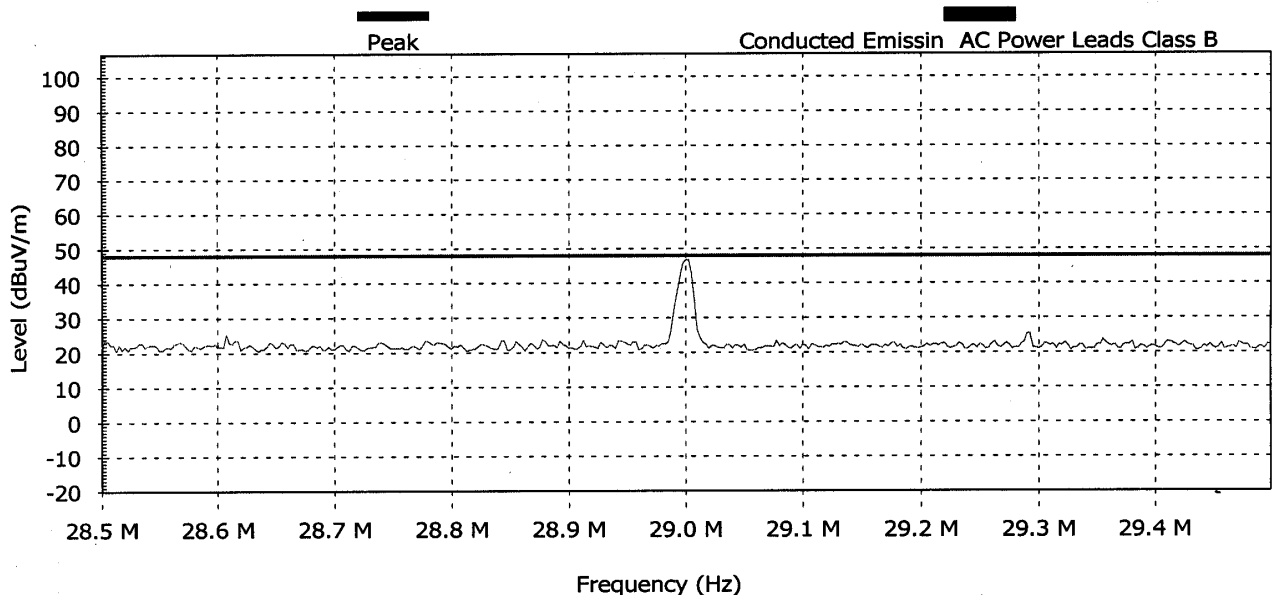

**Detected Peaks:**

Nr	Frequency (MHz)	PK (dBuV/m)	PK Limit (dBuV/m)	PK Pass	Pass	Line
1	29	47.6		Pass	Pass	Line 2

**Settings:**

Description: 48) Calibration 29MHz CE FCC CLASS B  
From 28.5 MHz to 29.5 MHz  
Ref. Level: 80.0 dBuV/m Att: 0 dB. RBW: 9 kHz. VBW: 30 kHz. Sweep time: 37.0369987487793 s  
Detect all peaks above 6 dB below the limit lines with a maximum of 1 peaks.

Measure the peaks with the peak detector

**Note:**

Calibration for 30MHz 48dbuV, LISN PHASE

**Plot CEcal/ 6**

**EUT File:**  
S:\EMC\_LAB\common\DAMATEC\LPU\_TNG\Data\Fcc1.eut  
**Order Number:**

**EUT**  
Name: LPU-TNG  
Serial Number: 0001

**Client**  
Name: Dmatek  
Contact Person: Alex Rachman

**Conducted Emission LISN**  
Description: 55) CE FCC CLASS B  
From 150 kHz to 500 kHz

**Graph:**

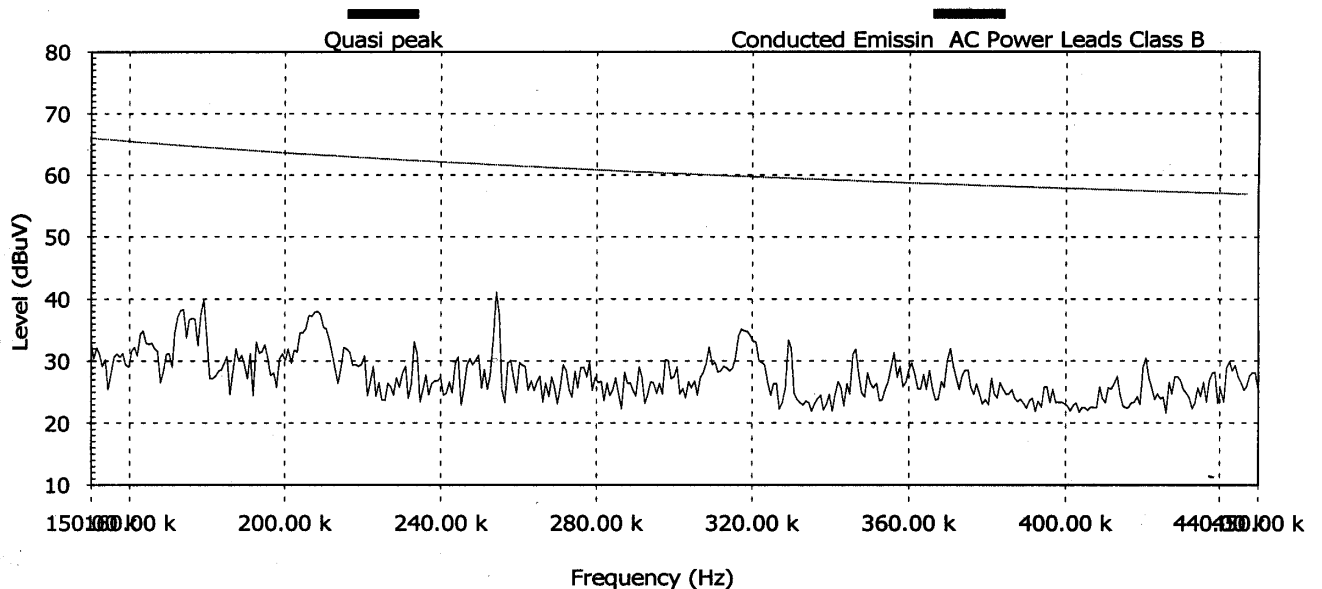

**Detected Peaks:**

Nr	Frequency (MHz)	PK (dBuV)	AVG (dBuV)	QP (dBuV)	RMS (dBuV)	PK Limit (dBuV)	PK Diff (dBuV)	AVG Limit (dBuV)	AVG Diff (dBuV)	QP Limit (dBuV)	QP Diff (dBuV)	RMS Limit (dBuV)	RMS Diff (dBuV)	PK Pass	AVG Pass	QP Pass	RMS Pass	Pass	Line

**Settings:**

Description: 55) CE FCC CLASS B  
From 150 kHz to 450 kHz  
Ref. Level: 80.0 dBuV Att: 0 dB. RBW: 9 kHz. VBW: 1000 kHz. Sweep time: 33.3330001831055 r  
Detect all peaks above 6 dB below the limit lines with a maximum of 3 peaks.  
Measure the peaks with the quasi-peak detector

**Note:**

**Plot CE/ 1**



**EUT File:**  
S:\EMC\_LAB\common\DAMATEC\LPU\_TNG\Data\En1.eut  
**Order Number:**

**EUT**  
Name: LPU-TNG  
Serial Number: 0001

**Client**  
Name: Dmatek  
Contact Person: Alex Rachman

**Conducted Emission LISN**  
Description: 31) CE FCC CLASS B  
From 0.5 MHz to 1 MHz

**Graph:**

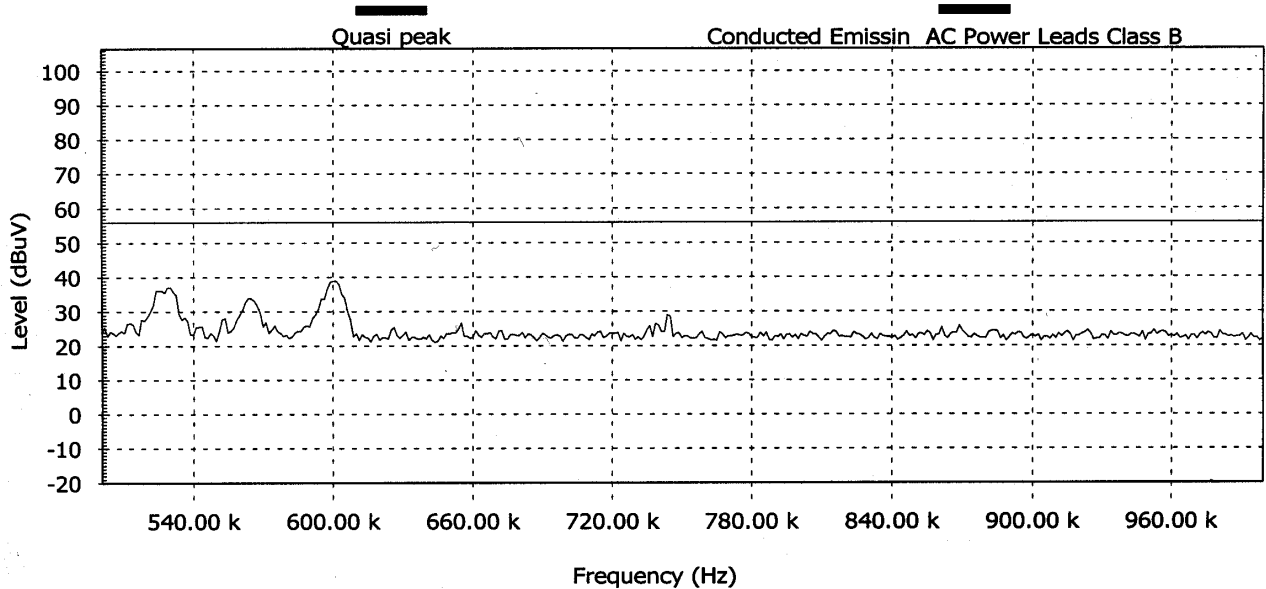

**Detected Peaks:**

Nr	Frequency (MHz)	PK (dBuV)	AVG (dBuV)	QP (dBuV)	RMS (dBuV)	PK Limit (dBuV)	AVG Limit (dBuV)	QP Limit (dBuV)	RMS Limit (dBuV)	PK Pass	AVG Pass	QP Pass	RMS Pass	Pass	Line

**Settings:**

Description: 31) CE FCC CLASS B  
From 0.5 MHz to 1 MHz  
Ref. Level: 80.0 dBuV Att: 0 dB. RBW: 9 kHz. VBW: 1000 kHz. Sweep time: 33.3330001831055 s  
Detect all peaks above 6 dB below the limit lines with a maximum of 3 peaks.  
Measure the peaks with the quasi-peak detector

**Note:**  
220VAC - NEYTRAL

**Plot CE/ 2**

**EUT File:**  
S:\EMC\_LAB\common\DAMATEC\LPU\_TNG\Data\En1.eut  
**Order Number:**

**EUT**  
Name: LPU-TNG  
Serial Number: 0001

**Client**  
Name: Dmatek  
Contact Person: Alex Rachman

**Conducted Emission LISN**  
Description: 33) CE FCC CLASS B  
From 1 MHz to 30 MHz

**Graph:**

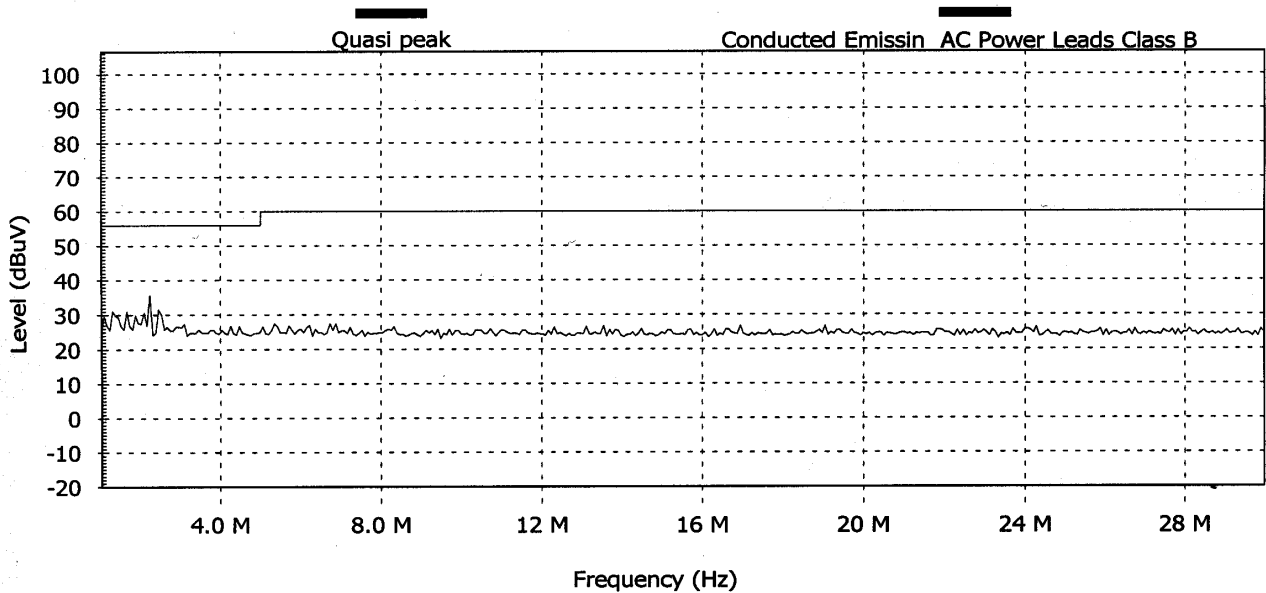

**Detected Peaks:**

Nr	Frequency (MHz)	PK (dBuV)	AVG (dBuV)	QP (dBuV)	RMS (dBuV)	PK Limit (dBuV)	AVG Limit (dBuV)	QP Limit (dBuV)	RMS Limit (dBuV)	PK Pass	AVG Pass	QP Pass	RMS Pass	Pass	Line

**Settings:**

Description: 33) CE FCC CLASS B  
From 1 MHz to 30 MHz  
Ref. Level: 80.0 dBuV Att: 0 dB. RBW: 9 kHz. VBW: 1000 kHz. Sweep time: 1074.07397460938 r  
Detect all peaks above 6 dB below the limit lines with a maximum of 3 peaks.  
Measure the peaks with the quasi-peak detector

**Note:**  
220VAC-NEUTRAL

**Plot CE/ 3**

**EUT File:**

S:\EMC\_LAB\common\DAMATEC\LPU\_TNG\Data\Fcc1.eut

**Order Number:**

**EUT**

Name: LPU-TNG

Serial Number: 0001

**Client**

Name: Dmatek

Contact Person: Alex Rachman

**Conducted Emission LISN**

Description: 56) CE FCC CLASS B

From 150 kHz to 500 kHz

**Graph:**

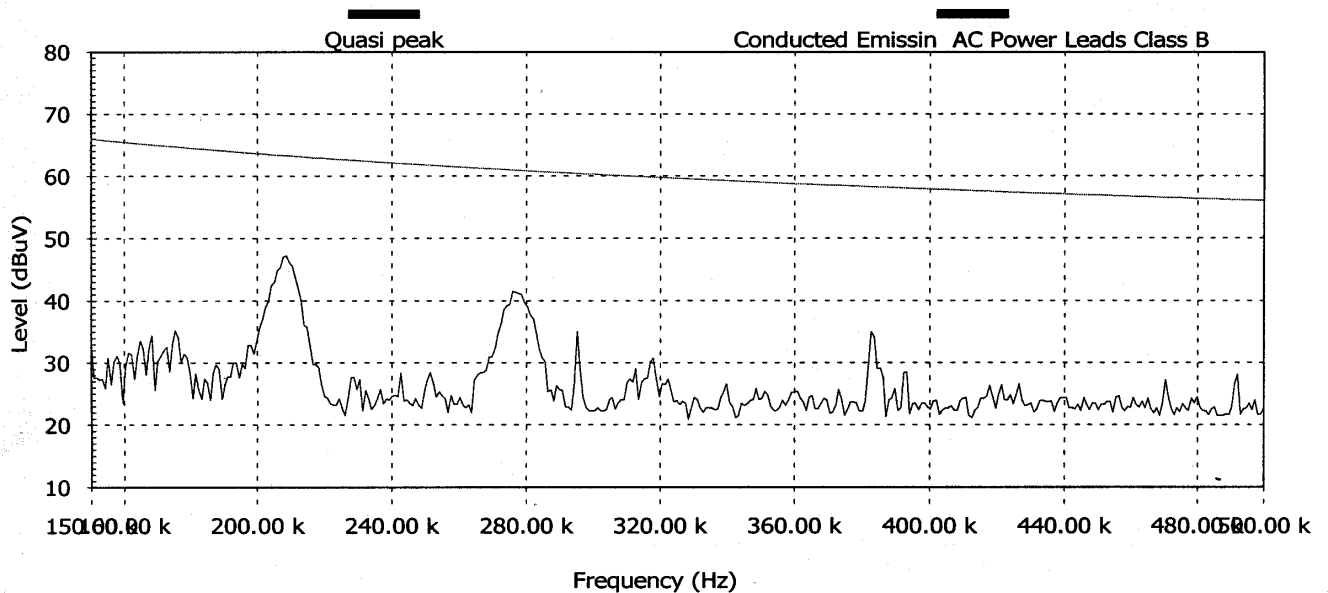

**Settings:**

Ref. Level: 80.0 dBuV Att: 0 dB. RBW: 9 kHz. VBW: 1000 kHz. Sweep time: 33.3330001831055 "

Detect all peaks above 6 dB, below the limit lines with a maximum of 3 peaks.

Measure the peaks with the quasi-peak detector

**Note:**

**Plot CE/ 4**

**EUT File:**  
S:\EMC\_LAB\common\DAMATEC\LPU\_TNG\Data\En1.eut  
**Order Number:**

**EUT**  
Name: LPU\_TNG  
Serial Number: 00001

**Client**  
Name:  
Contact Person:

**Conducted Emission LISN**

Description: 28) CE FCC CLASS B  
From 0.15 MHz to 0.5 MHz

**Graph:**

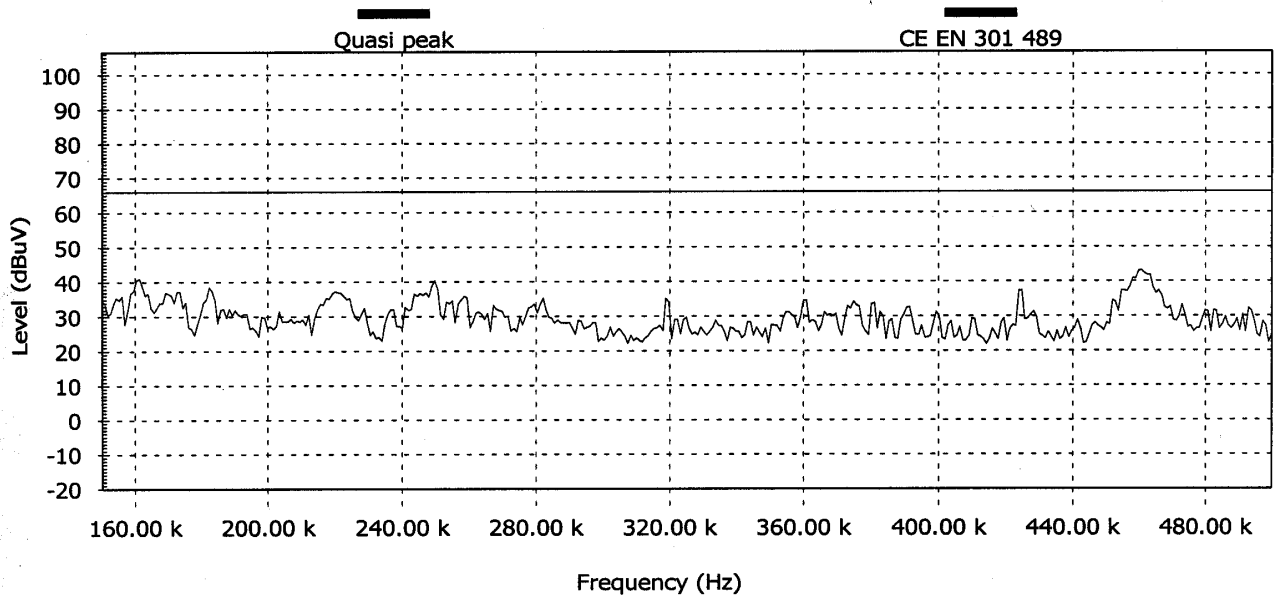

**Detected Peaks:**

Nr	Frequency (MHz)	PK (dBuV)	AVG (dBuV)	QP (dBuV)	RMS (dBuV)	PK Limit (dBuV)	AVG Limit (dBuV)	QP Limit (dBuV)	RMS Limit (dBuV)	PK Pass	AVG Pass	QP Pass	RMS Pass	Pass	Line

**Settings:**

Description: 28) CE FCC CLASS B  
From 0.15 MHz to 0.5 MHz  
Ref. Level: 80.0 dBuV Att: 0 dB. RBW: 9 kHz. VBW: 1000 kHz. Sweep time: 33.3330001831055 r  
Detect all peaks above 6 dB below the limit lines with a maximum of 3 peaks.  
Measure the peaks with the quasi-peak detector

**Note:**  
220VAC-PHASE

**Plot CE/ 5**

**EUT File:**  
S:\EMC LAB\common\DAMATEC\LPU\_TNG\Data\En1.eut  
**Order Number:**

**EUT**  
Name: LPU-TNG  
Serial Number: 0001

**Client**  
Name: Dmatek  
Contact Person: Alex Rachman

**Conducted Emission LISN**

Description: 30) CE FCC CLASS B  
From 1 MHz to 30 MHz

**Graph:**

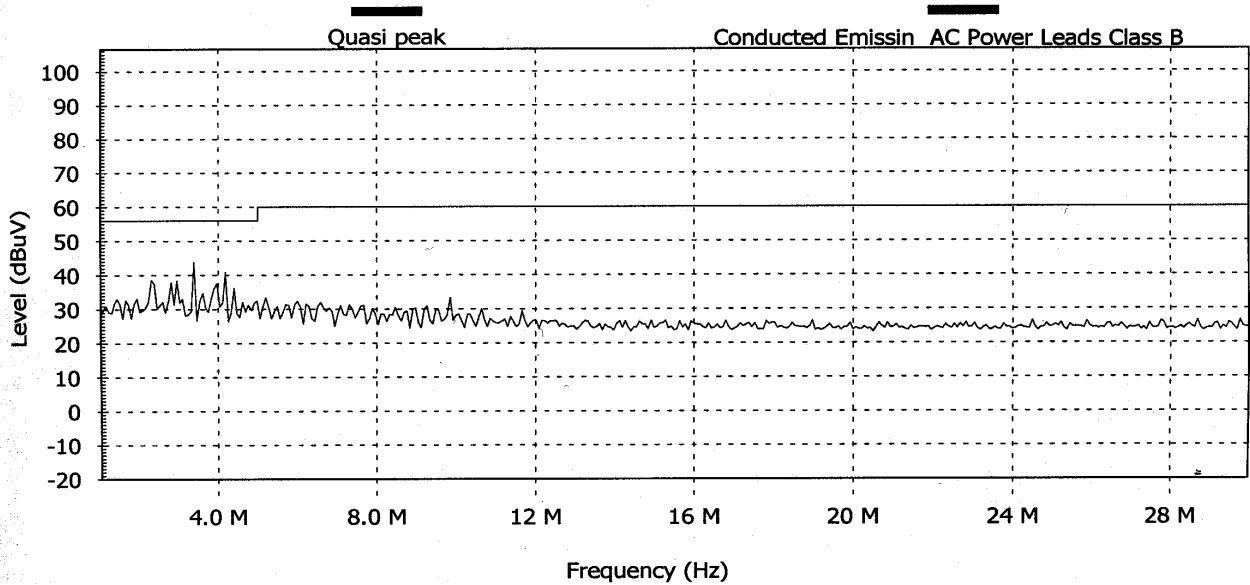

**Detected Peaks:**

Nr	Frequency (MHz)	PK (dBuV)	AVG (dBuV)	QP (dBuV)	RMS (dBuV)	PK Limit (dBuV)	AVG Limit (dBuV)	QP Limit (dBuV)	RMS Limit (dBuV)	PK Pass	AVG Pass	QP Pass	RMS Pass	Pass	Line

**Settings:**

Description: 30) CE FCC CLASS B  
From 1 MHz to 30 MHz  
Ref. Level: 80.0 dBuV Att: 0 dB. RBW: 9 kHz. VBW: 1000 kHz. Sweep time: 1074.07397460938 s  
Detect all peaks above 6 dB below the limit lines with a maximum of 3 peaks.  
Measure the peaks with the quasi-peak detector

**Note:**  
220VAC-PHASE

**Plot CE/ 6**

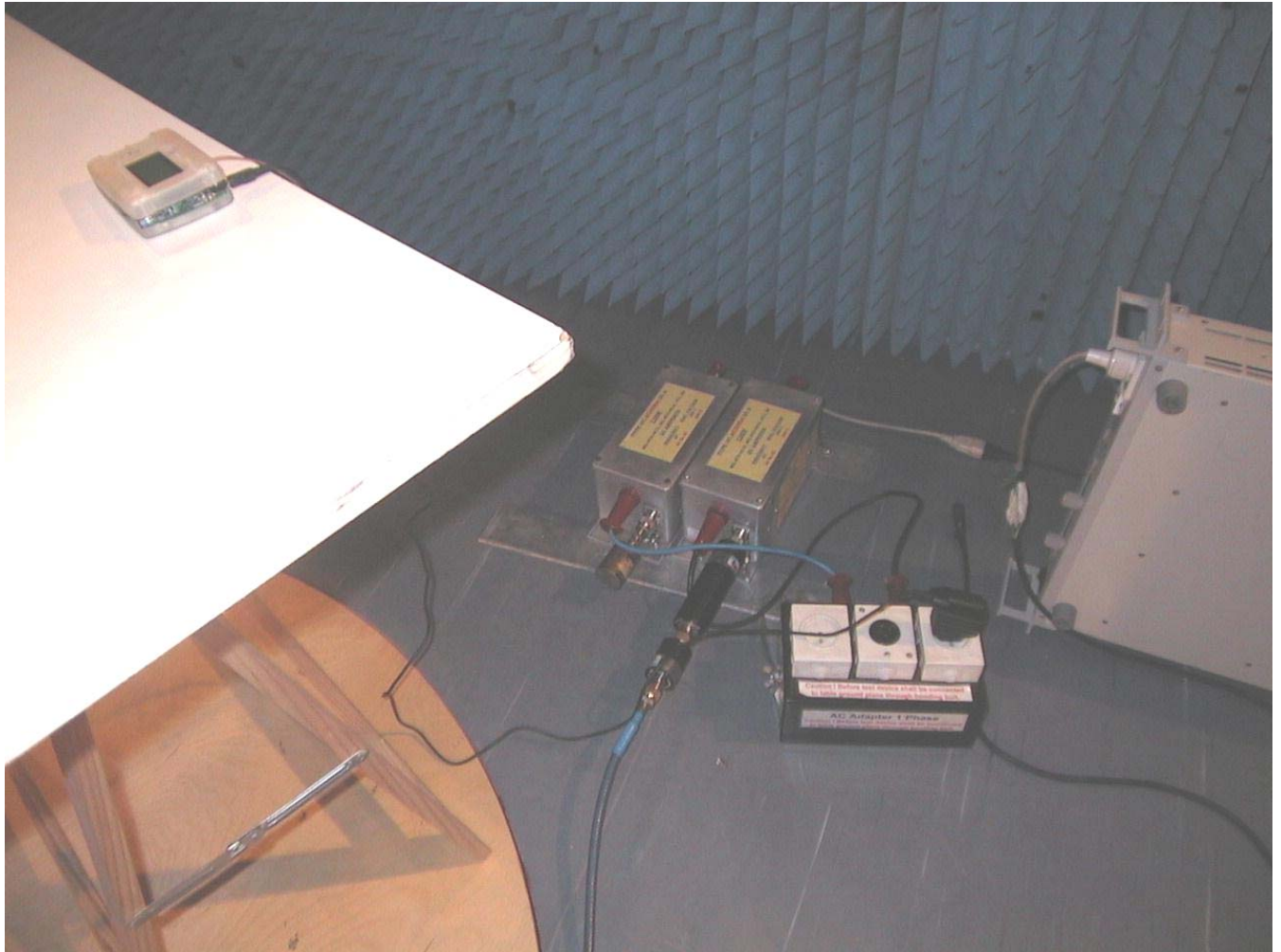

**Picture CE-1 Test Set up for Conducted Emission**