





FCC PART 90 TEST AND MEASUREMENT REPORT

For
Pyrammid Communications

37 Shield, Irvine, CA 92618, USA

FCC ID: LRUSVR-300UD

| | |
|---|---|
| Report Type: CIIPC | Product type: UHF Digital Transceiver |
| Prepared By: <u>Troy Pandhumsoporn</u> Test Engineer |  |
| Report Number: <u>R1711224-90</u> | |
| Report Date: <u>2018-07-03</u> | |
| Reviewed By: <u>Jin Yang</u> Test Engineer |  |
| Bay Area Compliance Laboratories Corp. 1274 Anvilwood Avenue, Sunnyvale, CA 94089, U.S.A. Tel: 1 (408) 732-9162 Fax: 1 (408) 732 9164 | |

Note: This test report is prepared for the customer shown above and for the device described herein. It may not be duplicated or used in part without prior written consent from Bay Area Compliance Laboratories Corp. This report must not be used by the customer to claim product certification, approval, or endorsement by A2LA* or any agency of the Federal Government. * This report may contain data that are not covered by the A2LA accreditation and are marked with an asterisk "*" (Rev.3)

TABLE OF CONTENTS

| | |
|---|-----------|
| 1. General Information..... | 4 |
| 1.1 PRODUCT DESCRIPTION FOR EQUIPMENT UNDER TEST (EUT)..... | 4 |
| 1.2 MECHANICAL DESCRIPTION | 4 |
| 1.3 OBJECTIVE..... | 4 |
| 1.4 RELATED SUBMITTAL(S)/GRANT(S) | 4 |
| 1.5 TEST METHODOLOGY | 5 |
| 1.6 MEASUREMENT UNCERTAINTY | 5 |
| 1.7 TEST FACILITY | 5 |
| 1.8 TEST FACILITY ACCREDITATIONS | 6 |
| 2 System Test Configuration..... | 9 |
| 2.1 JUSTIFICATION..... | 9 |
| 2.2 EQUIPMENT MODIFICATIONS..... | 9 |
| 2.3 LOCAL SUPPORT EQUIPMENT | 9 |
| 2.4 SUPPORT EQUIPMENT | 9 |
| 2.5 LOCAL SUPPORT EQUIPMENT POWER SUPPLY AND LINE FILTERS | 9 |
| 2.6 EXTERNAL I/O CABLING LIST AND DETAILS | 10 |
| 2.7 TEST SETUP BLOCK DIAGRAM | 10 |
| 2.8 ANTENNA PORT CONDUCTED TEST | 11 |
| 3 Summary of Test Results..... | 12 |
| 4 FCC §2.1091 - RF Exposure | 13 |
| 4.1 APPLICABLE STANDARDS | 13 |
| 4.2 MPE PREDICTION..... | 13 |
| 4.3 MPE RESULTS | 14 |
| 5 FCC §2.1046 & §90.205 - RF Output Power | 15 |
| 5.1 APPLICABLE STANDARD..... | 15 |
| 5.2 TEST PROCEDURE..... | 15 |
| 5.3 TEST EQUIPMENT LIST AND DETAILS | 15 |
| 5.4 TEST ENVIRONMENTAL CONDITIONS..... | 15 |
| 5.5 TEST RESULTS | 15 |
| 6 FCC §2.1053 & §90.210 - Field Strength of Spurious Radiation | 18 |
| 6.1 APPLICABLE STANDARD..... | 18 |
| 6.2 TEST PROCEDURE..... | 18 |
| 6.3 TEST EQUIPMENT LIST AND DETAILS | 19 |
| 6.4 TEST ENVIRONMENTAL CONDITIONS..... | 19 |
| 6.5 TEST RESULTS | 20 |
| 7 Appendix A - EUT Photo | 21 |
| 8 Appendix B (Informative) - Declaration of Similarity Letter | 22 |
| 9 Appendix C (Informative) - A2LA Electrical Testing Certificate | 23 |

DOCUMENT REVISION HISTORY

| Revision Number | Report Number | Description of Revision | Date of Revision |
|------------------------|----------------------|--------------------------------|-------------------------|
| 0 | R1711224-90 | CIIPC Report | 2018-07-03 |

1. General Information

1.1 Product Description for Equipment under Test (EUT)

This test and measurement report was prepared on behalf *Pyrammid Communications* and their product, FCC ID: LRUSVR-300UD, model: SVR-300UD, which will henceforth be referred to as the EUT (Equipment Under Test). The EUT is a UHF digital transceiver that operates in 450-512 MHz band.

The EUTs are UHF Transceivers that operates under FCC Part 90

| Specifications | |
|----------------------|---|
| Frequency Bands | 450-512 MHz |
| Emission Designators | 7K60FXE/7K60FXD/11K0F3E/8K10F1E 8K10F1D/8K10F1W/8K30F1E/8K30F1D 8K30F7W/4K00F1E/4K00F1D/4K00F7W/4K00F2D |
| RF Output Power | 2 Watts |
| Channel Spacing | 12.5 kHz |
| Power Supply | 12-13.6 VDC |

1.2 Mechanical Description

The EUT measures approximately 23.1 cm (L) x 14.6 cm (W) x 5.3 cm (H) and weighs approximately 1249 g.

The test data gathered are from production sample, serial number: B5200134, provided by the manufacturer.

1.3 Objective

This type approval report is prepared on behalf of *Pyrammid Communications* in accordance with Part 90 of the Federal Communication Commissions rules.

The objective was to determine that the changes in components do not degrade the performance of the EUT.

1.4 Related Submittal(s)/Grant(s)

N/A

1.5 Test Methodology

All tests and measurements indicated in this document were performed in accordance with the Code of federal Regulations Title 47 Part 2, Sub-part J as well as the following individual parts:

Part 90 – Private Land Mobile Radio Service

Applicable Standards: TIA-603-D, Land Mobile FM or PM Communications Equipment Measurement and Performance Standards.

All emissions measurement was performed by Bay Area Compliance Laboratories Corp. The radiated testing was performed at an antenna-to-EUT distance of 3 meters.

1.6 Measurement Uncertainty

All measurements involve certain levels of uncertainties, especially in the field of EMC. The factors contributing to uncertainties are spectrum analyzer, cable loss, antenna factor calibration, antenna directivity, antenna factor variation with height, antenna phase center variation, antenna factor frequency interpolation, measurement distance variation, site imperfections, mismatch (average), and system repeatability.

| Parameter | Measurement uncertainty |
|----------------------------|-------------------------|
| RF output power, conducted | ±0.57 dB |
| All emissions, radiated | ±4.0 dB |
| Temperature | ±2 ° C |
| Humidity | ±5 % |
| Time | ±2 % |

1.7 Test Facility

BACLs test facilities that are used to perform Radiated and Conducted Emissions tests are currently recognized by the Federal Communications Commission as Accredited with NIST Designation Number US1129.

BACL's test facilities that are used to perform Radiated and Conducted Emissions tests are currently registered with Industry Canada under Registration Numbers: 3062A-1, 3062A-2, and 3062A-3.

BACL is a Chinese Taipei Bureau of Standards Metrology and Inspection (BSMI) validated Conformity Assessment Body (CAB), under Appendix B, Phase I Procedures of the APEC Mutual Recognition Arrangement (MRA). BACL's BSMI Lab Code Number is: SL2-IN-E-1002R

BACL's test facilities that are used to perform AC Line Conducted Emissions, Telecommunications Line Conducted Emissions, Radiated Emissions from 30 MHz to 1 GHz, and Radiated Emissions from 1 GHz to 6 GHz are currently recognized as Accredited in accordance with the Voluntary Control Council for Interference [VCCI] Article 15 procedures under Registration Number A-0027.

1.8 Test Facility Accreditations

Bay Area Compliance Laboratories Corp. (BACL) is:

A- An independent, 3rd-Party, Commercial Test Laboratory accredited to ISO/IEC 17025:2005 by A2LA (Test Laboratory Accreditation Certificate Number 3297.02), in the fields of: Electromagnetic Compatibility and Telecommunications. Unless noted by an Asterisk (*) in the Compliance Matrix (See Section 3 of this Test Report), BACL's ISO/IEC 17025:2005 Scope of Accreditation includes all of the Test Method Standards and/or the Product Family Standards detailed in this Test Report..

BACL's ISO/IEC 17025:2005 Scope of Accreditation includes a comprehensive suite of EMC Emissions, EMC Immunity, Radio, RF Exposure, Safety and wireline Telecommunications test methods applicable to a wide range of product categories. These product categories include Central Office Telecommunications Equipment [including NEBS - Network Equipment Building Systems], Unlicensed and Licensed Wireless and RF devices, Information Technology Equipment (ITE); Telecommunications Terminal Equipment (TTE); Medical Electrical Equipment; Industrial, Scientific and Medical Test Equipment; Professional Audio and Video Equipment; Industrial and Scientific Instruments and Laboratory Apparatus; Cable Distribution Systems, and Energy Efficient Lighting.

B- A Product Certification Body accredited to ISO/IEC 17065:2012 by A2LA (Product Certification Body Accreditation Certificate Number 3297.03) to certify

- For the USA (Federal Communications Commission):

- 1- All Unlicensed radio frequency devices within FCC Scopes A1, A2, A3, and A4;
- 2- All Licensed radio frequency devices within FCC Scopes B1, B2, B3, and B4;
- 3- All Telephone Terminal Equipment within FCC Scope C.

- For the Canada (Industry Canada):

- 1 All Scope 1-Licence-Exempt Radio Frequency Devices;
- 2 All Scope 2-Licensed Personal Mobile Radio Services;
- 3 All Scope 3-Licensed General Mobile & Fixed Radio Services;
- 4 All Scope 4-Licensed Maritime & Aviation Radio Services;
- 5 All Scope 5-Licensed Fixed Microwave Radio Services
- 6 All Broadcasting Technical Standards (BETS) in the Category I Equipment Standards List.

- For Singapore (Info-Communications Development Authority (IDA)):

- 1 All Line Terminal Equipment: All Technical Specifications for Line Terminal Equipment – Table 1 of IDA MRA Recognition Scheme: 2011, Annex 2
2. All Radio-Communication Equipment: All Technical Specifications for Radio-Communication Equipment – Table 2 of IDA MRA Recognition Scheme: 2011, Annex 2

- For the Hong Kong Special Administrative Region:

- 1 All Radio Equipment, per KHCA 10XX-series Specifications;
- 2 All GMDSS Marine Radio Equipment, per HKCA 12XX-series Specifications;
- 3 All Fixed Network Equipment, per HKCA 20XX-series Specifications.

- For Japan:

- 1 MIC Telecommunication Business Law (Terminal Equipment):
 - All Scope A1 - Terminal Equipment for the Purpose of Calls;
 - All Scope A2 - Other Terminal Equipment
- 2 Radio Law (Radio Equipment):
 - All Scope B1 - Specified Radio Equipment specified in Article 38-2-2, paragraph 1, item 1 of the Radio Law
 - All Scope B2 - Specified Radio Equipment specified in Article 38-2-2, paragraph 1, item 2 of the Radio Law

- All Scope B3 - Specified Radio Equipment specified in Article 38-2-2, paragraph 1, item 3 of the Radio Law

C- A Product Certification Body accredited to ISO/IEC 17065:2012 by A2LA (Product Certification Body Accreditation Certificate Number 3297.01) to certify Products to USA's Environmental Protection Agency (EPA) ENERGY STAR Product Specifications for:

- 1 Electronics and Office Equipment:
 - for Telephony (ver. 3.0)
 - for Audio/Video (ver. 3.0)
 - for Battery Charging Systems (ver. 1.1)
 - for Set-top Boxes & Cable Boxes (ver. 4.1)
 - for Televisions (ver. 6.1)
 - for Computers (ver. 6.0)
 - for Displays (ver. 6.0)
 - for Imaging Equipment (ver. 2.0)
 - for Computer Servers (ver. 2.0)
- 2 Commercial Food Service Equipment
 - for Commercial Dishwashers (ver. 2.0)
 - for Commercial Ice Machines (ver. 2.0)
 - for Commercial Ovens (ver. 2.1)
 - for Commercial Refrigerators and Freezers
- 3 Lighting Products
 - For Decorative Light Strings (ver. 1.5)
 - For Luminaires (including sub-components) and Lamps (ver. 1.2)
 - For Compact Fluorescent Lamps (CFLs) (ver. 4.3)
 - For Integral LED Lamps (ver. 1.4)
- 4 Heating, Ventilation, and AC Products
 - for Residential Ceiling Fans (ver. 3.0)
 - for Residential Ventilating Fans (ver. 3.2)
- 5 Other
 - For Water Coolers (ver. 3.0)

D. A NIST Designated Phase-I and Phase-II Conformity Assessment Body (CAB) for the following economies and regulatory authorities under the terms of the stated MRAs/Treaties:

- Australia: ACMA (Australian Communication and Media Authority) – APEC Tel MRA -Phase I;
- Canada: (Industry Canada - IC) Foreign Certification Body – FCB – APEC Tel MRA -Phase I & Phase II;
- Chinese Taipei (Republic of China – Taiwan):
 - o BSMI (Bureau of Standards, Metrology and Inspection) APEC Tel MRA -Phase I;
 - o NCC (National Communications Commission) APEC Tel MRA -Phase I;
- European Union:
 - o EMC Directive 2014/30/EC US-EU EMC & Telecom MRA CAB
 - o Radio & Teleterminal Equipment (R&TTE) Directive 1995/5/EC
US -EU EMC & Telecom MRA CAB
- Hong Kong Special Administrative Region: (Office of the Telecommunications Authority – OFTA)
APEC Tel MRA -Phase I & Phase II
- Israel – US-Israel MRA Phase I
- Republic of Korea (Ministry of Communications - Radio Research Laboratory) APEC Tel MRA - Phase I
- Singapore: (Infocomm Development Authority - IDA) APEC Tel MRA -Phase I & Phase II;

- Japan: VCCI - Voluntary Control Council for Interference US-Japan Telecom Treaty VCCI Side Letter-
- USA:
 - o ENERGY STAR Recognized Test Laboratory – US EPA
 - o Telecommunications Certification Body (TCB) – US FCC;
- Vietnam: APEC Tel MRA -Phase I;

2 System Test Configuration

2.1 Justification

The EUT was configured for testing according to TIA-603-D and the instructions and default settings provided by Pyrammid Communications.

The EUT was tested in the normal (native) operating mode to represent *worst*-case results during the final qualification test.

| Bands (MHz) | Channel | Frequency (MHz) | Power Setting |
|---------------|---------|-----------------|---------------|
| 450 - 512 MHz | 1 | 450.05 | Default |
| | 2 | 481.05 | Default |
| | 3 | 511.95 | Default |

2.2 Equipment Modifications

No modifications were made to the EUT.

2.3 Local Support Equipment

| Manufacturer | Description | Model No. | Serial No. |
|--------------|-------------|--------------|------------|
| Fluke | Multimeter | 75 Series II | 56500901 |

2.4 Support Equipment

| Manufacturer | Description | Model No. | Serial No. |
|-------------------------|--------------|-----------|------------|
| Pyrammid Communications | EUT Test Set | - | - |

2.5 Local Support Equipment Power Supply and Line Filters

| Manufacturer | Description | Model | Serial Number |
|--------------|-----------------|-------|---------------|
| Kepeco | DC Power Supply | - | - |

2.6 External I/O Cabling List and Details

| Cable Description | Length (m) | From | To |
|------------------------------|------------|----------------|--------------|
| RS-232 Adapter | < 1.0 | EUT Test Set | EUT |
| DC Adapter with Banana Plugs | > 1.0 | DC Barrel Jack | Power Supply |

2.7 Test Setup Block Diagram

Radiated Emission Test

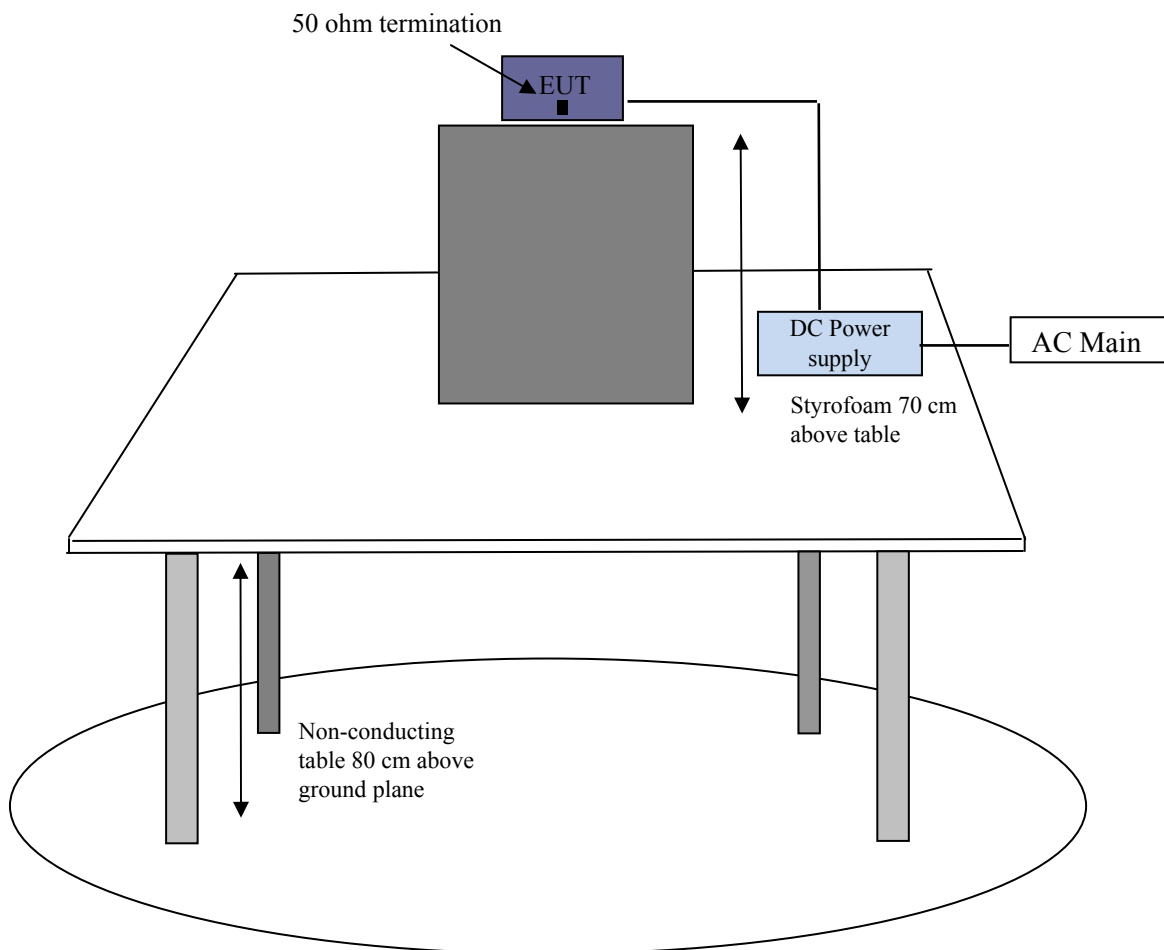

2.8 Antenna Port Conducted Test

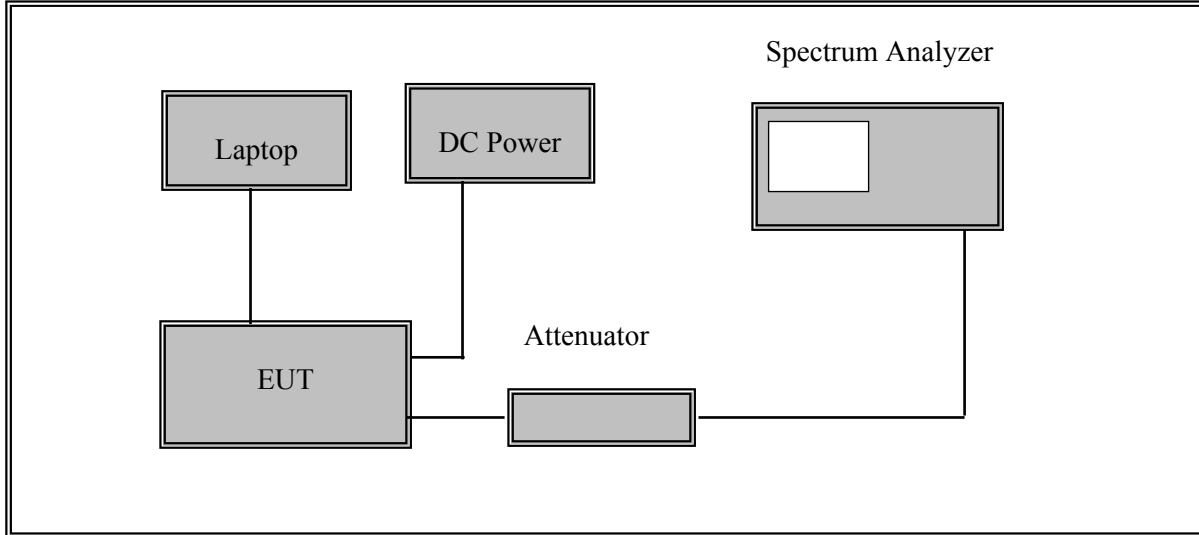

3 Summary of Test Results

| FCC Rules | Description of Tests | Results |
|------------------|--------------------------------------|-----------|
| §2.1091 | RF Exposure | Compliant |
| §2.1046, §90.205 | RF Output Power | Compliant |
| §2.1053, §90.210 | Field Strength of Spurious Radiation | Compliant |

4 FCC §2.1091 - RF Exposure

4.1 Applicable Standards

According to FCC §15.247(i), §15.407(f) and §1.1307(b)(1), systems operating under the provisions of this section shall be operated in a manner that ensures that the public is not exposed to radio frequency energy level in excess of the Commission's guidelines.

Limits for General Population/Uncontrolled Exposure

| Frequency Range (MHz) | Electric Field Strength (V/m) | Magnetic Field Strength (A/m) | Power Density (mW/cm ²) | Averaging Time (minutes) |
|---|-------------------------------|-------------------------------|-------------------------------------|--------------------------|
| Limits for General Population/Uncontrolled Exposure | | | | |
| 0.3-1.34 | 614 | 1.63 | * (100) | 30 |
| 1.34-30 | 824/f | 2.19/f | * (180/f ²) | 30 |
| 30-300 | 27.5 | 0.073 | 0.2 | 30 |
| 300-1500 | / | / | f/1500 | 30 |
| 1500-100,000 | / | / | 1.0 | 30 |

f = frequency in MHz

* = Plane-wave equivalent power density

Before equipment certification is granted, the procedure of ISED RSS-102 must be followed concerning the exposure of humans to RF field

4.2 MPE Prediction

Predication of MPE limit at a given distance, Equation from OET Bulletin 65, Edition 97-01

$$S = PG/4\pi R^2$$

Where: S = power density

P = power input to antenna

G = power gain of the antenna in the direction of interest relative to an isotropic radiator

R = distance to the center of radiation of the antenna

4.3 MPE Results

| | |
|---|---------------|
| <u>Maximum peak output power at antenna input terminal (dBm):</u> | <u>33.65</u> |
| <u>Maximum peak output power at antenna input terminal (mW):</u> | <u>2317.4</u> |
| <u>50% Duty Cycle Maximum peak output power at antenna input terminal (mW):</u> | <u>1158.7</u> |
| <u>Prediction distance (cm):</u> | <u>25</u> |
| <u>Prediction frequency (MHz):</u> | <u>450.05</u> |
| <u>Maximum Antenna Gain, typical (dBi):</u> | <u>2.15</u> |
| <u>Maximum Antenna Gain (numeric):</u> | <u>1.641</u> |
| <u>Power density of prediction frequency at 25.0 cm (mW/cm²):</u> | <u>0.242</u> |
| <u>FCC MPE limit for uncontrolled exposure at prediction frequency (mW/cm²):</u> | <u>0.30</u> |

Conclusion

The device is compliant with the requirement MPE limit for uncontrolled exposure. All transceiver modules must be installed with a separation distance of no less than **25** cm from all persons.

5 FCC §2.1046 & §90.205 - RF Output Power

5.1 Applicable Standard

According to FCC §2.1046, and §90.205, 450-470 MHz. (1) The maximum allowable station effective radiated power (ERP) is dependent upon the station's antenna HAAT and required service area and will be authorized in accordance with table 2. Applicants requesting an ERP in excess of that listed in table 2 must submit an engineering analysis based upon generally accepted engineering practices and standards that includes coverage contours to demonstrate that the requested station parameters will not produce coverage in excess of that which the applicant requires.

470-512 MHz. Power and height limitations are specified in §§90.307 and 90.309.

5.2 Test Procedure

The RF output of the transmitter was connected to the input of the spectrum analyzer through sufficient attenuation.

5.3 Test Equipment List and Details

| Manufacturer | Description | Model | Serial Number | Calibration Date | Calibration Interval |
|--------------|-------------------|---------------------|---------------|------------------|----------------------|
| Agilent | Spectrum Analyzer | E4446A | MY48250238 | 2018-01-29 | 1 year |
| JYE-BAO | 30 dB Attenuator | 50 Ω 20W HPT-TMO/3G | - | - | - |
| - | RF Cable | - | - | - | - |

Statement of Traceability: BACL Corp. attests that all calibrations have been performed according to A2LA requirements, traceable to the NIST.

5.4 Test Environmental Conditions

| | |
|---------------------------|-------------|
| Temperature: | 20-25 °C |
| Relative Humidity: | 44-55 % |
| ATM Pressure: | 101-102 kPa |

The testing was performed by Harry Zhao and Frank Wang on 2018-02-02 in RF Site

5.5 Test Results

| Frequency (MHz) | Channel | Frequency (MHz) | Conducted Output Power | |
|-----------------|---------|-----------------|------------------------|--------|
| | | | (dBm) | (Watt) |
| 450-512 | 1 | 450.05 | 33.65 | 2.32 |
| | 2 | 481.05 | 33.53 | 2.25 |
| | 3 | 511.95 | 32.95 | 1.97 |

Note: The maximum output power allowed by §90.205(s) is 2.4 W.

Channel 1: 450.05 MHz

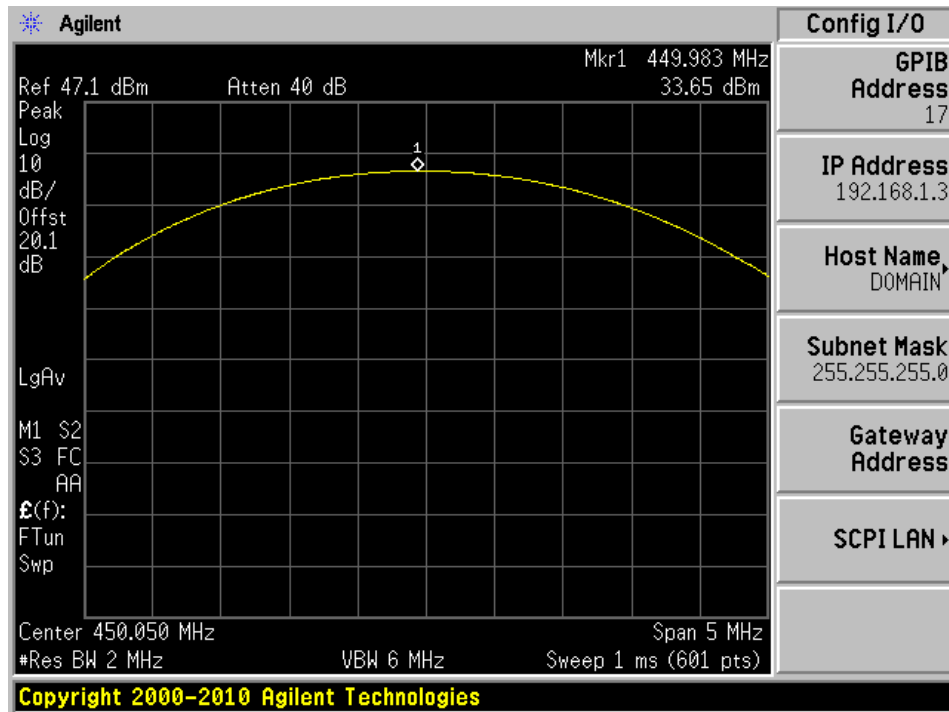

Channel 2: 481.05 MHz

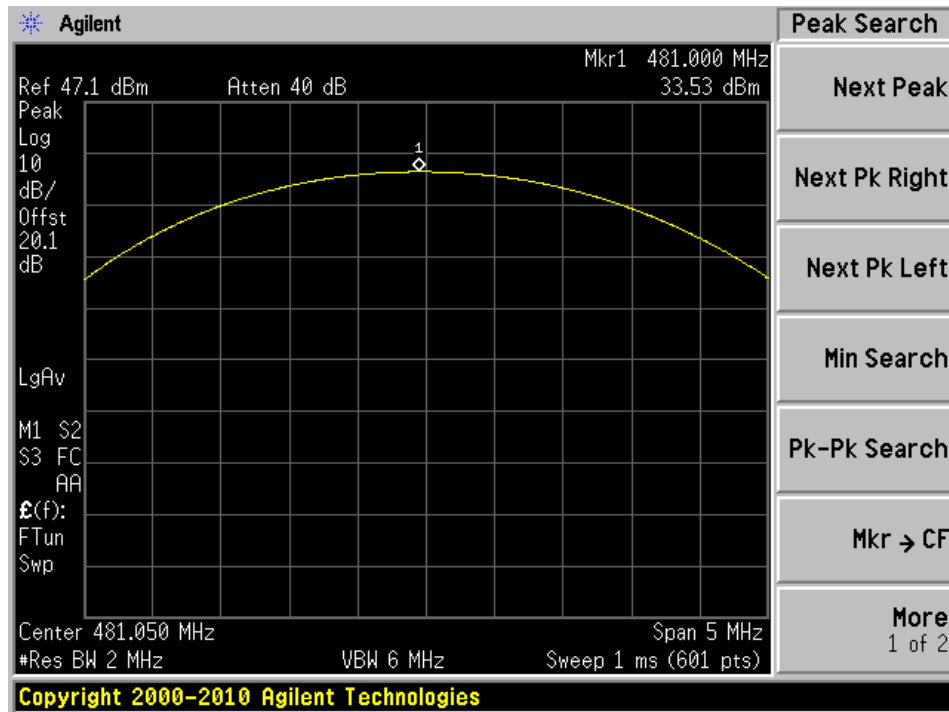

Channel 3: 511.95 MHz

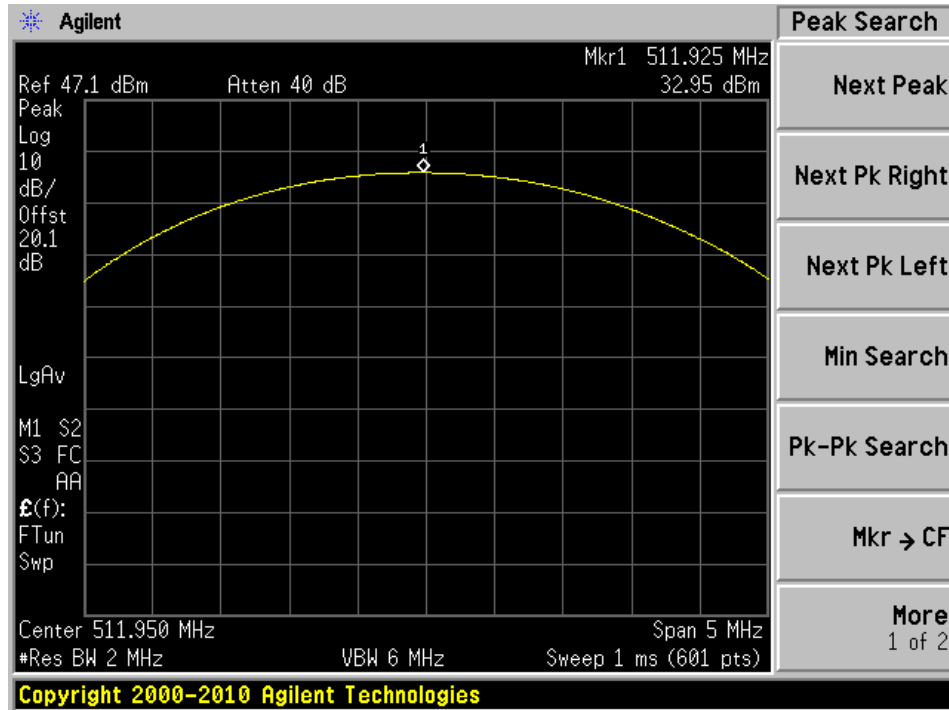

6 FCC §2.1053 & §90.210 - Field Strength of Spurious Radiation

6.1 Applicable Standard

According to FCC §90.210:

(d) *Emission Mask D—12.5 kHz channel bandwidth equipment.* For transmitters designed to operate with a 12.5 kHz channel bandwidth, any emission must be attenuated below the power (P) of the highest emission contained within the authorized bandwidth as follows:

- (1) On any frequency from the center of the authorized bandwidth f_0 to 5.625 kHz removed from f_0 : Zero dB.
- (2) On any frequency removed from the center of the authorized bandwidth by a displacement frequency (f_d in kHz) of more than 5.625 kHz but no more than 12.5 kHz: At least $7.27(f_d - 2.88)$ dB.
- (3) On any frequency removed from the center of the authorized bandwidth by a displacement frequency (f_d in kHz) of more than 12.5 kHz: At least $50 + 10 \log(P)$ dB or 70 dB, whichever is the lesser attenuation.
- (4) The reference level for showing compliance with the emission mask shall be established using a resolution bandwidth sufficiently wide (usually two or three times the channel bandwidth) to capture the true peak emission of the equipment under test. In order to show compliance with the emission mask up to and including 50 kHz removed from the edge of the authorized bandwidth, adjust the resolution bandwidth to 100 Hz with the measuring instrument in a peak hold mode. A sufficient number of sweeps must be measured to insure that the emission profile is developed. If video filtering is used, its bandwidth must not be less than the instrument resolution bandwidth. For emissions beyond 50 kHz from the edge of the authorized bandwidth, see paragraph (o) of this section. If it can be shown that use of the above instrumentation settings do not accurately represent the true interference potential of the equipment under test, an alternate procedure may be used provided prior Commission approval is obtained.

6.2 Test Procedure

The transmitter was placed on a Styrofoam with wooden turntable, and it was normal transmitting with 50ohm termination which was also placed on the turntable.

The measurement antenna was placed at a distance of 3 meters from the EUT. During the tests, the antenna height and polarization as well as EUT azimuth were varied in order to identify the maximum level of emissions from the EUT. The test was performed by placing the EUT on 3-orthogonal axis.

The frequency range up to tenth harmonic of the fundamental frequency was investigated.

Remove the EUT and replace it with substitution antenna. A signal generator was connected to the substitution antenna by a non-radiating cable. The absolute levels of the spurious emissions were measured by the substitution.

Spurious emissions in dB = $10 \lg(\text{TXpwr in Watts}/0.001)$ – the absolute level

6.3 Test Equipment List and Details

| Manufacturer | Description | Model | Serial Number | Calibration Date | Calibration Interval |
|-----------------------|---------------------|---------|-----------------------|------------------------|----------------------|
| Agilent | Analyzer, Spectrum | E4440A | US45303156 | 2017-02-24 | 1 year |
| Sunol Science Corp | System Controller | SC99V | 122303-1 | N/R | N/R |
| Sunol Sciences | Antenna, Biconi-Log | JB3 | A020106-2 | 2018-01-25 | 30 months |
| Agilent | Pre-Amplifier | 8449B | 3008A01978 | 2017-06-15 | 1 year |
| Agilent | Amplifier, Pre | 8447D | 2944A10187 | 2017-05-17 | 1 year |
| Sunol Sciences | Antenna, Horn | DRH-118 | A052704 | 2017-03-27 | 2 years |
| EMCO | Antenna, Horn | 3115 | 9511-4627 | 2016-01-28 | 26 months |
| Keysight Technologies | Generator, Signal | N5182B | MY51350070 | 2018-01-06 | 1 year |
| Agilent | Generator, Signal | E4438C | MY45091309 | 2017-11-06 | 1 year |
| COM-POWER | Antenna, Dipole | AD-100 | 721033DB1, 2, 3, 4 | 2017-02-13 | 2 years |
| - | RF Cable | - | - | Each time ¹ | N/A |

Statement of Traceability: BACL Corp. attests that all calibrations have been performed according to A2LA requirements, traceable to the NIST.

6.4 Test Environmental Conditions

| | |
|---------------------------|-------------|
| Temperature: | 18-24 °C |
| Relative Humidity: | 35-50 % |
| ATM Pressure: | 101-102 kPa |

The testing was performed by Troy Pandhumsoporn on 2018-02-02, 2018-02-07 to 2018-02-08 in 5 meter chamber 3.

6.5 Test Results**12.5 kHz Channel Spacing****SVR-300UD****Frequency: 450-512 MHz:**

Worst Margin: -25.959 dB at 4043 MHz in the Vertical polarization.

450-512 MHz:

12.5 kHz Channel Spacing, Channel 2 – 481.05 MHz

| Indicated | | Azimuth (Degrees) | Test Antenna | | Substituted | | | | | Limit (dBm) | Margin (dB) |
|----------------|----------------|----------------------|----------------|----------------|----------------|----------------|-----------------------------|-----------------------|----------------------------|----------------|----------------|
| Freq. (MHz) | Amp. (dBuV) | | Height (cm) | Polar (H/V) | Freq. (MHz) | Level (dBm) | Antenna Gain (dB/dBi) | Cable Loss (dB) | Absolute Level (dBm) | | |
| 240 | 41.51 | 157 | 176 | H | 240 | -63.97 | 0 | 0.227 | -64.197 | -20 | -44.197 |
| 208 | 37.68 | 152 | 156 | V | 208 | -62.7 | 0 | 0.227 | -62.927 | -20 | -42.927 |
| 224 | 51.54 | 150 | 222 | H | 224 | -49.63 | 0 | 0.227 | -49.857 | -20 | -29.857 |
| 224 | 45.43 | 157 | 112 | V | 224 | -56.93 | 0 | 0.227 | -57.157 | -20 | -37.157 |
| 2000 | 47.58 | 0 | 100 | H | 2000 | -58.47 | 7.134 | 0.591 | -51.927 | -20 | -31.927 |
| 2000 | 47.54 | 0 | 100 | V | 2000 | -58.47 | 7.113 | 0.591 | -51.948 | -20 | -31.948 |
| 4000 | 45.04 | 0 | 100 | H | 4000 | -55.86 | 9.944 | 0.927 | -46.843 | -20 | -26.843 |
| 4043 | 46.41 | 0 | 100 | V | 4043 | -54.82 | 9.788 | 0.927 | -45.959 | -20 | -25.959 |

7 Appendix A - EUT Photo

Please see attachments:

- Exhibit A – EUT Test Setup Photographs
- Exhibit B – EUT External Photographs
- Exhibit C – EUT Internal Photographs

8 Appendix B (Informative) - Declaration of Similarity Letter



P Y R A M I D
C O M M U N I C A T I O N S

Re: DECLARATION OF SIMILARITY

May 21, 2018

To:

Bay Area Compliance Laboratories Corp.
1274 Anvilwood Ave.
Sunnyvale, CA 94089
Phone: 408-732-9162, Fax: 408-732-9164
<http://www.baclcorp.com>

Dear Sir or Madam:

We Pyramid Communications hereby declare that product: *Land Mobile Radios*, model(s): *SVR-300UD, SVR-P300UD, SVR-N300UD, and SVR-D300UD* are electrically identical with the same electromagnetic emissions and electromagnetic compatibility characteristics as model: *SVR-300UD* tested by BAACL, the results of which are featured in BAACL project: *R1711224*.

A description of the differences between the tested model and those that are declared similar are as follows:

Model Number(s) indicate an operational difference for the type of modulation used for marketing purposes. For example, SVR-N300UD = NXDN mode, SVR-D300UD = DMR Mode and SVR-P300UD = P25 mode operation.

Please contact me should there be need for any additional clarification or information.

Best Regards,

Chris Carbajal

President & CTO
Pyramid Communications

9 Appendix C (Informative) - A2LA Electrical Testing Certificate



Accredited Laboratory

A2LA has accredited

BAY AREA COMPLIANCE LABORATORIES CORP.
Sunnyvale, CA

for technical competence in the field of

Electrical Testing

This laboratory is accredited in accordance with the recognized International Standard ISO/IEC 17025:2005 *General requirements for the competence of testing and calibration laboratories*. This laboratory also meets the requirements of any additional program requirements in the Electrical field. This accreditation demonstrates technical competence for a defined scope and the operation of a laboratory quality management system (refer to joint ISO-ILAC-IAF Communiqué dated 8 January 2009).



Presented this 30th day of August 2016.



President and CEO
For the Accreditation Council
Certificate Number 3297.02
Valid to September 30, 2018
Revised November 14, 2016

For the tests to which this accreditation applies, please refer to the laboratory's Electrical Scope of Accreditation.

Please follow the web link below for a full ISO 17025 scope

<https://www.a2la.org/scopepdf/3297-02.pdf>

----- END OF REPORT -----