



**MOTOROLA**



TESTING CERT: 2518.01

**FCC ID: LO6-DVRSUHF  
DECLARATION OF COMPLIANCE MPE ASSESSMENT**

**Networks & Enterprise**  
**EME Test Laboratory**  
8000 West Sunrise Blvd  
Fort Lauderdale, FL. 33322

**Date of Report:** February 08, 2007  
**Report Revision:** Rev. 0  
**Report ID:** FCC MPE rpt\_DVR UHF R4 XTL  
UHF R1 Rev O\_070208\_SR4230

**Responsible Engineer:** Stephen Whalen (EME Principle Staff Eng.)  
**Date/s Tested:** 07/10/2006, 4/19/2006 & 6/3/2006 – 6/4/2006  
**Manufacturer/Location:** Futurecom Systems Group Inc., Concord, Ontario, Canada  
**Date submitted for test:** 07/05/06 (DVR)  
**DUT Description:** 470-512MHz DVRS  
**Test TX mode(s):** CW  
**Max. Power output:** 10W (conducted into antenna), 100% Duty Cycle  
**TX Frequency Bands:** 470-512MHz  
**Signaling type:** FM; APCO 25  
**Model(s) Tested:** DQPM DVR6000P  
**Model(s) Certified:** DQPM DVR6000P  
**Serial Number(s):** 06041701  
**Classification:** Occupational Controlled (Operator); General Population/Uncontrolled (Passengers/Bystanders)  
**Rule Part(s):** 2.1091 (d)



**Approved Accessories:**

**Antenna(s):**  
HAE4004A (470-512MHz ¼ wave trunk mount antenna; 0dBd gain)  
HAE6016A (450-512MHz ¼ wave trunk mount antenna; 0dBd gain)

**Companion Mobiles and Antennas:**

FCC ID	Mobile Description	Antenna(s)
AZ492FT4870	Motorola XTL5000 Model M20QTS9PW1AN, 380-470MHz Mobile, Transmit conducted power up to 100W, 50% transmit duty cycle.	HAE6012A (380-433MHz; ¼ wave Roof mount; 0dBd gain) HAE6013A (380-470MHz; ½ wave Roof mount; 2dBd gain) HAE4003A (450-470MHz; ¼ wave Roof mount; 0dBd gain) HAE4011A (445-470MHz; ½ wave Roof mount; 3.5dBd gain)
AZ492FT4862	Motorola XTL5000 Model M20QSS9PW1AN, 380-470MHz Mobile, Transmit conducted power up to 40W, 50% transmit duty cycle.	HAE6012A (380-433MHz; ¼ wave Roof mount; 0dBd gain) HAE6013A (380-470MHz; ½ wave Roof mount; 2dBd gain) HAE4003A (450-470MHz; ¼ wave Roof mount; 0dBd gain) HAE4011A (445-470MHz; ½ wave Roof mount; 3.5dBd gain)

**Final RF Exposure Results:  
Combined UHF DVR and UHF Mobile max calculated 1-g Avg. S.A.R.: 0.26mW/g**

Based on the information and the testing results provided herein, the undersigned certifies that when used as stated in the operating instructions supplied, said product complies with the national and international reference standards and guidelines listed in section 3.0 of this report. This report shall not be reproduced without written approval from an officially designated representative of the Motorola EME Laboratory.

**Signature on file**  
Deanna Zakharia NE EME Lab Senior Resource Manager,  
Laboratory Director,

**Approval Date:** 2/8/2007

**Certification Date:**

**Certification No.:**

**TABLE OF CONTENTS**

- 1.0 Product and System Description
- 2.0 Additional Options and Accessories
- 3.0 Measurement and Limit Standards
- 4.0 Data Collection Consideration
- 5.0 Measurement System Uncertainty Levels
- 6.0 Method of Measurement
  - 6.1 DVR UHF EME measurements made with trunk mounted antenna(s)
    - 6.1.1 External vehicle EME measurement
    - 6.1.2 Internal vehicle EME measurement
  - 6.2 Mobile UHF EME measurements made with roof mounted antenna(s)
    - 6.2.1 External vehicle EME measurements
    - 6.2.2 Internal vehicle EME measurement
- 7.0 Test Site
- 8.0 Measurement System/Equipment
- 9.0 Test Unit Description
- 10.0 Test Set-Up Description
- 11.0 Test Results Summary
- 12.0 Conclusion

- APPENDIX A: Illustration of Antenna Location and Test Distances
- APPENDIX B: Block Diagram of MPE Test Configuration
- APPENDIX C: Meter/Probe Calibration Certificates
- APPENDIX D: Photos of Assessed Antennas
- APPENDIX E: Detailed MPE Measurement Data
- APPENDIX F: Computational EME Assessment

**REVISION HISTORY**

Date	Revision	Comments
02/08/07	O	Original release

## 1.0 Product and System Description

FCC ID: LO6-DVRSUHF is a MOBEXCOM Digital Vehicular Repeater (DVR) manufactured by FUTURECOM Systems Group. The DVR, in addition to standalone operation, is capable of interfacing to a companion mobile radio using serial data protocol for audio and control. The full duplex DVR provides local area coverage for portable to portable communication in the 470-512MHz band while the companion mobile radio provides wide-area coverage extension.

The system can operate in the following modes: Mobile mode - where the vehicular repeat function is off but receives emergency and mode change commands from portable devices; Local mode - with portable to portable repeat and network monitoring capabilities; and System mode - with portable to portable repeat functions with full network interconnect. Furthermore, the DVRS offers a busy lockout feature where a simulcast prevention algorithm is used for seamless multi-vehicle operation on the same channel. Moreover, the system supports emergency calls in the MDC1200 signaling format. Other system features include field programmability, seamless interface to a mobile radio through the control head bus, controllability via a mobile radio control head, as well as remotely by a dispatcher or portable user. The DVR supports up to 64 channels and 255 talk groups, MDC1200, DTMF, EIA, CCIR signaling as well as PL and DPL. The DVR supports programmability of leading and/or trailing tones, and audio and TX priorities per mode as well as talk group steering.

This test report covers the RF Exposure performance of the 470-512MHz 10 watts DVR interfaced with, and transmitting simultaneously with, either companion UHF(380-470MHz) mobile radios with transmit powers up to 48 watts (M20QSS9PW1AN) and 120 watts (M20QTS9PW1AN) and with both units, installed in a typical vehicle.

The DVR transmit frequency range is 470-512MHz at transmit duty cycle up to 100%. The UHF mobile transmit frequency range is 380-470MHz at transmit duty cycle up to 50%. The DVR antennas are limited to  $\frac{1}{4}\lambda$  (0dBd gain) mounted at the center of the trunk, and the UHF mobile antennas are limited to  $\frac{1}{4}\lambda$  and  $\frac{1}{2}\lambda$  (0dBd, 2dBd and 3.5dBd gain) mounted at the center of the roof. The maximum conducted power delivered to the DVR antenna is 10 watts.

This device will be marketed to and used by employees solely for work-related operations, such as public safety agencies, e.g. police, fire and emergency medical. User training is the responsibility of these agencies which can be expected to employ the usage instructions, safety information and operational cautions set forth in the user's manual, instructional sessions or other means.

Accordingly this product is classified as Occupational/Controlled Exposure. However, In accordance with FCC requirements, the passengers inside the vehicle and the bystanders external to the vehicle are evaluated to the General Population/Uncontrolled Exposure Limits.

(Note that "By-standers" as used herein mean people other than operator)

**2.0 Additional Options and Accessories:**

NA

**3.0 Measurement and Limit Standards**

Measurements were performed according to the recommended guidelines in IEEE/ANSI C95.3-2002 and compared to FCC Limits Per 47 CFR 2.1091 (d) for General Population/Uncontrolled RF Exposure.

For test frequencies ranging from 470-512MHz and 380-470MHz the MPE (Maximum Permissible Exposure) limit to electromagnetic energy in equivalent plane wave free-space power density is 0.31-0.34 mW/cm<sup>2</sup> and 0.25–0.31mW/cm<sup>2</sup> respectively and calculated using the formula  $f/1500$ .

**4.0 Data Collection Consideration**

Power density testing was performed with DUT installed in a 1991 Ford Taurus (4-door). Measurement data was taken with the vehicles’ electrical system powered by an equivalent source equal to the car running at idle and the vehicle battery measuring 13.8 volts.

**5.0 Measurement System Uncertainty Levels**

The information below presents an estimate of the possible errors that are associated with the measurement system.

Uncertainty Budget for Near Field Probe Measurements

	<b>Tol.</b> <b>(± %)</b>	<b>Prob</b> <b>Dist.</b>	<b>Divisor</b>	<b><i>u<sub>i</sub></i></b> <b>(±%)</b>
<b>Measurement System</b>				
Survey Meter Calibration	3.0	N	1.00	3.0
Repeatability Accuracy	7.0	N	1.00	7.0
<b>Combined Standard Uncertainty</b>		RSS		7.6
<b>Expanded Uncertainty</b>		<i>k</i> =2		15

**6.0 Method of Measurement**

MPE measurements were conducted for each transmitter individually per the procedures described in the following sections. Percent of Limit was calculated for each transmitter individually for each position. Final results representing the maximum combined exposure of DVR and mobile radio were obtained by summing the highest percent of limit results from each transmitter.

## **6.1 DVR UHF EME measurements made with trunk mounted antenna(s)**

(For reference, see Illustration of antenna location and test distances in APPENDIX A)

### **6.1.1 External vehicle EME measurement**

(Antenna mounted at trunk center)

MPE measurements for by-stander conditions are determined by taking the average of (10) measurements in a 2m vertical line for each of the (5) test locations indicated in APPENDIX A with 20cm increments at the test distance of 90cm from the test vehicle's body, as stated in the user manual. The measurement probe sensor is rotated 180° at each of the ten incremental measurements to ensure the highest result is captured. These measurements are representative of persons other than the operator standing next to the vehicle.

The DVR antennas mounted at the center of the trunk were assessed across the TX band for the (5) by-stander conditions presented in APPENDIX A.

### **6.1.2 Internal vehicle EME measurement**

(Antenna mounted at trunk center)

While rotating survey meter probe through 180 degrees to ensure that the highest level is found, scans were performed inside of the vehicle, at both front and back seating areas, across the TX band to ascertain the highest level at the head. After the highest level is found, scans were performed vertically making two (2) additional measurements within an area approximately 40cm wide (representing the width of a person) so as to have a total of three (3) measured points, indicated below, that are averaged.

- a) Head area
- b) Chest area
- c) Lower Trunk area

## **6.2 Mobile UHF EME measurements made with roof mounted antenna(s)**

(For reference, see Illustration of antenna location and test distances in APPENDIX A).

### **6.2.1 External vehicle EME measurement**

(Antenna mounted at roof center)

MPE measurements for by-stander conditions are determined by taking the average of (10) measurements in a 2m vertical line for each of the (5) test locations indicated in APPENDIX A with 20cm increments at the test distance of 90cm from the test vehicle's body, as stated in the user manual. The measurement probe sensor is rotated 180° at each of the ten incremental measurements to ensure the highest result is captured. These measurements are representative of persons other than the operator standing next to the vehicle.

The mobile antennas mounted at the center of the roof were assessed across the TX band for the (5) by-stander conditions presented in APPENDIX A.

**6.2.2 Internal vehicle EME measurement**  
 (Antenna mounted at roof center)

While rotating survey meter probe through 180 degrees to ensure that the highest level is found, scans were performed inside of the vehicle, both at the front and back seating areas, across the TX band to ascertain the highest level in each location. After the highest level is found, two (2) additional measurements were performed vertically within an area approximately 40cm wide (representing the width of a person) so as to have a total of three (3) measured points as indicated below that are averaged.

- a) Head area
- b) Chest area
- c) Lower Trunk area

**7.0 Test Site**

The test site is the Motorola open area test site located at 8000 W. Sunrise Blvd., Plantation, FL. 33322.

**8.0 Measurement System/Equipment**

Equipment Type	Model #	SN	Calibration Due Date
Automobile	1991 Ford Taurus, 4-Door		
*Survey Meter	NARDA Model 8718	01122	4/20/07
*Probe - E-Field (Electric Field)	NARDA Model 8722B	12023	4/20/07
**Survey Meter	NARDA Model 8718	01108	5/17/06
**Probe - E-Field (Electric Field)	NARDA Model 8722B	13001	2/28/07
***Survey Meter	NARDA Model 8718	01122	4/20/07
***Probe - E-Field (Electric Field)	NARDA Model 8722B	13001	2/28/07

\* Equipment used during DVR UHF (test date 7/10/2006)  
 \*\* Equipment used during UHF mobile M20QSS9PW1AN (test date 4/19/2006)  
 \*\*\* Equipment used during UHF mobile M20QTS9PW1AN (test dates 6/3/2006 – 6/4/2006)

**9.0 Test Unit Description**

Power density measurements were performed on a representative sample of the DVR UHF 470-512MHz 10 watt radio with serial number 06041701.

Power density measurements were performed on the following representative sample of the Motorola XTL5000 UHF M20QSS9PW1AN 48watt radio with serial number X17890085 and XTL5000 UHF M20QTS9PW1AN 120 watt with radio serial number U2A024.

Presented below is a summary of the tested frequencies and associated power outputs for each DUT.

DVR		Mobile UHF Radios			
DQPM DVR6000P		M20QSS9PW1AN		M20QTS9PW1AN	
Frequency (MHz)	Po (W)	Frequency (MHz)	Po (W)	Frequency (MHz)	Po (W)
470	10	380.012	47.3	380.012	117.0
491	10	425.0125	47.1	425.0125	119.0
512	10	460.0125	47.2	460.0125	119.0
		469.9875	47.5	469.9875	120.0

**10.0 Test Set-Up Description**

The following are the mobile antenna test configurations used for this product. (for reference, see Illustration of antenna location and test distances in the APPENDIX A)

Mobile - The ¼ and ½ wave antennas (HAE6012A 0dBd, HAE6013A 2dBd, HAE4003A 0dBd, HAE4011A 3.5dBd) were assessed while mounted at the center of the roof of the test vehicle.

DVR - The ¼ wave antennas (HAE4004A 0dBd and HAE6016A 0dBd) were assessed while mounted at the trunk.

Assessments were made internal and external to the test vehicle at the specified distances and test locations indicated in sections 6.0, 11.0, and the APPENDIX A.

**11.0 Test Results Summary**

APPENDIX E presents detailed MPE measurement information for each test configuration; person external or internal to the vehicle, TX frequency, antenna (location, model and gain), distance from antenna to probe sensor, E field measurements, calibration factor, MPE average over body, initial power, power density calc, power density max calc, IEEE/FCC controlled and uncontrolled limits, and maximum output power.

The Average over Body test methodology is consistent with IEEE/ANSI C95.3-2002 guidelines

MPE results are based on a DVR 100% duty cycle and Mobile 50% duty cycle which is in accordance with the User Manual instructions.

Below is an explanation of how the MPE results are calculated.

External to vehicle - 10 measurements are averaged over the body (*Body\_Avg*).

Internal to vehicle - 3 measurements are averaged over the body (*Body\_Avg*).

Narda Survey Meter measures in percent of the controlled limit. Therefore the averages over the body used in the calculations below reflect percentages.

Therefore;

$$Average\_over\_Body = Body\_Avg * Controlled\_Limit$$

$$Pwr\_Density\_Calc = Average\_over\_Body * Duty\_Cycle$$

$$Pwr\_Density\_Max\_Calc = Pwr\_Density\_Calc * \frac{Max\_Output\_Power}{Initial\_Output\_Power}$$

Note; For Initial Output Power > Max\_Output\_Power, Max\_Output\_Power / Initial Output Power = 1

The tables below summarize the highest MPE results of the E field test configurations for the UHF mobiles, DVR UHF, and combined assessments. See APPENDICES A and E respectively for the indicated test locations and detailed MPE measurement data.

**Table 1 – UHF mobile M20QTS9PW1AN Assessments – Highest MPE result per test position**

Tables	Antenna Model	Antenna Location	Test Frequency (MHz)	E/H Field	Passenger/By-Stander Pos.	Max Calc Pwr Density (mW/cm <sup>2</sup> )	% of Uncontrolled limit
Table 10	HAE6013A	Roof	425.0125	E	Passenger	0.17	60.7%
Table 7	HAE6013A	Roof	380.0125	E	By-Stander Pos. #1	0.10	40.0%
Table 18	HAE6013A	Roof	380.0125	E	By-Stander Pos. #2	0.09	36.0%
Table 26	HAE6013A	Roof	425.0125	E	By-Stander Pos. #3	0.11	39.3%
Table 33	HAE6013A	Roof	425.0125	E	By-Stander Pos. #4	0.09	32.1%
Table 36	HAE6012A	Roof	380.0125	E	By-Stander Pos. #5	0.07	25.9%

**Table 2 – UHF mobile M20QSS9PW1AN Assessments – Highest MPE result per test position**

Tables	Antenna Model	Antenna Location	Test Frequency (MHz)	E/H Field	Passenger/By-Stander Pos.	Max Calc Pwr Density (mW/cm <sup>2</sup> )	% of Uncontrolled limit
Table 10	HAE6013A	Roof	425.0125	E	Passenger	0.07	25.0%
Table 9	HAE6013A	Roof	425.0125	E	By-Stander Pos. #1	0.06	21.4%
Table 18	HAE6013A	Roof	380.0125	E	By-Stander Pos. #2	0.04	16.0%
Table 25	HAE6013A	Roof	380.0125	E	By-Stander Pos. #3	0.04	16.0%
Table 32	HAE6013A	Roof	380.0125	E	By-Stander Pos. #4	0.02	8.0%
Table 39	HAE6013A	Roof	380.0125	E	By-Stander Pos. #5	0.02	8.0%



**Table 3 – DVR UHF DQPM DVR6000P Assessments - Highest MPE result per test position**

Tables	Antenna Model	Antenna Location	Test Frequency (MHz)	E/H Field	Passenger/By-Stander Pos.	Max Calc Pwr Density (mW/cm <sup>2</sup> )	% of Uncontrolled limit
Table 4	HAE6016A	Trunk	491.0	E	Passenger	0.20	60.6%
Table 7	HAE4004A	Trunk	470.0	E	By-Stander Pos. #1	0.03	9.7%
Table 13	HAE6016A	Trunk	470.0	E	By-Stander Pos. #2	0.02	6.5%
Table 22	HAE4004A	Trunk	470.0	E	By-Stander Pos. #3	0.04	12.9%
Table 26	HAE6016A	Trunk	491.0	E	By-Stander Pos. #4	0.07	21.2%
Table 32	HAE6016A	Trunk	491.0	E	By-Stander Pos. #5	0.06	18.2%

**Table 4 - Combined UHF Mobile M20QTS9PW1AN and DVR UHF DQPM DVR6000P (Calculated % of limit performance)**

Test Position	Percentage of Limit		
	UHF Mobile (380-470MHz)	DVR UHF (470-512MHz)	Combined Percentages
Passenger	60.7%	60.6%	*121.3%
By-Stander #1	40.0%	9.7%	49.7%
By-Stander #2	36.0%	6.5%	42.5%
By-Stander #3	39.3%	12.9%	52.2%
By-Stander #4	32.1%	21.2%	53.3%
By-Stander #5	25.9%	18.2%	44.1%

\* Exceeds MPE General Population/Uncontrolled exposure limit

**Table 5 - Combined UHF Mobile M20QSS9PW1AN and DVR UHF DQPM DVR6000P (Calculated % of limit performance)**

Test Position	Percentage of Limit		
	UHF Mobile (380-470MHz)	DVR UHF (470-512MHz)	Combined Percentages
Passenger	25.0%	60.6%	85.6%
By-Stander #1	21.4%	9.7%	31.1%
By-Stander #2	16.0%	6.5%	22.5%
By-Stander #3	16.0%	12.9%	28.9%
By-Stander #4	8.0%	21.2%	29.2%
By-Stander #5	8.0%	18.2%	26.2%

**Table 6 – Highest combined passenger (backseat) MPE percent of limit**

		UHF Mobile 120W Roof Mount				
		HAE6012A 380.0125MHz	HAE6013A 425.0125MHz	HAE4011A 460.0125MHz	HAE4003A 469.9875MHz	
		Measured Results (%)	40.0%	60.7%	9.7%	41.9%
<b>DVR UHF 10W Trunk Mount</b>	HAE6016A 470MHz	48.4%	88.4%	*109.1%	58.1%	90.3%
	HAE6016A 491MHz	60.6%	*100.6%	*121.3%	70.3%	*102.5%
	HAE4004A 512MHz	55.9%	95.9%	*116.6%	65.6%	97.8%

\* Exceeds MPE General Population/Uncontrolled exposure limit

**12.0 Conclusion**

Because the signals emitted by each individual transmitter are statistically uncorrelated, the collective compliance of the transmitters is determined by summing the individual ratios between actual (S) and maximum allowed MPE exposure. Compliance is achieved if the total exposure level (T) is less than one:

Formula:

$$T = \frac{S_1}{SAR_1} + \frac{S_2}{SAR_2} + \dots < 1 \quad \text{Or} \quad T = \frac{S_1}{MPE_1} + \frac{S_2}{MPE_2} + \dots < 1$$

Depending on the test frequency, the mobile assessments were performed with an output power range of 47.1W – 47.5W (M20QSS9P1AN) and 117.0W – 120.0W (M20QTS9PW1AN). The DVR output power across the TX band is 10.0W. The highest power density results for the XTL5000 UHF mobile device scaled to the maximum allowable power output is 0.17mW/cm<sup>2</sup> internal to the vehicle and 0.10mW/cm<sup>2</sup> external to the vehicle. The highest power density results for the DVR UHF device scaled to the maximum allowable power output is 0.20mW/cm<sup>2</sup> internal to the vehicle and 0.07mW/cm<sup>2</sup> external to the vehicle. The highest combined passenger power density performance is 121.3% and highest combined by-stander power density performance is 53.3% (refer to table 4 test position 4) of the FCC/IEEE MPE limits using the methodology and formula below.

Therefore:

Passenger	$T = \frac{0.20}{0.33} + \frac{0.17}{0.28} = 1.213 < 1$	(non-compliant)
By-stander	$T = \frac{0.07}{0.33} + \frac{0.09}{0.28} = 0.533 < 1$	(compliant)

The MPE results presented herein demonstrate compliance to the applicable FCC/IEEE Occupational/Controlled exposure limit of 1.57-1.71mW/cm<sup>2</sup> for the 470-512MHz frequency range and 1.27-1.57mW/cm<sup>2</sup> for the 380-470MHz frequency range. FCC/IEEE Occupational/Controlled exposure limits are calculated by f/300 for the frequency range of 300-1500MHz.

FCC rules require compliance for passengers and bystanders to the FCC General Population/Uncontrolled limits. Although MPE is a convenient method of demonstrating compliance, SAR is recognized as the "basic restriction". For those configurations exceeding the MPE limit noted in table 6 section 11.0, compliance to the FCC/IEEE SAR General Population/Uncontrolled limit of 1.6mW/g is demonstrated in Part II Computational EME Compliance Assessment via SAR computational analysis.

The computation results show that this device, when used with the specified antennas, exhibit a maximum combined peak 1-g average SAR of 0.26mW/g.

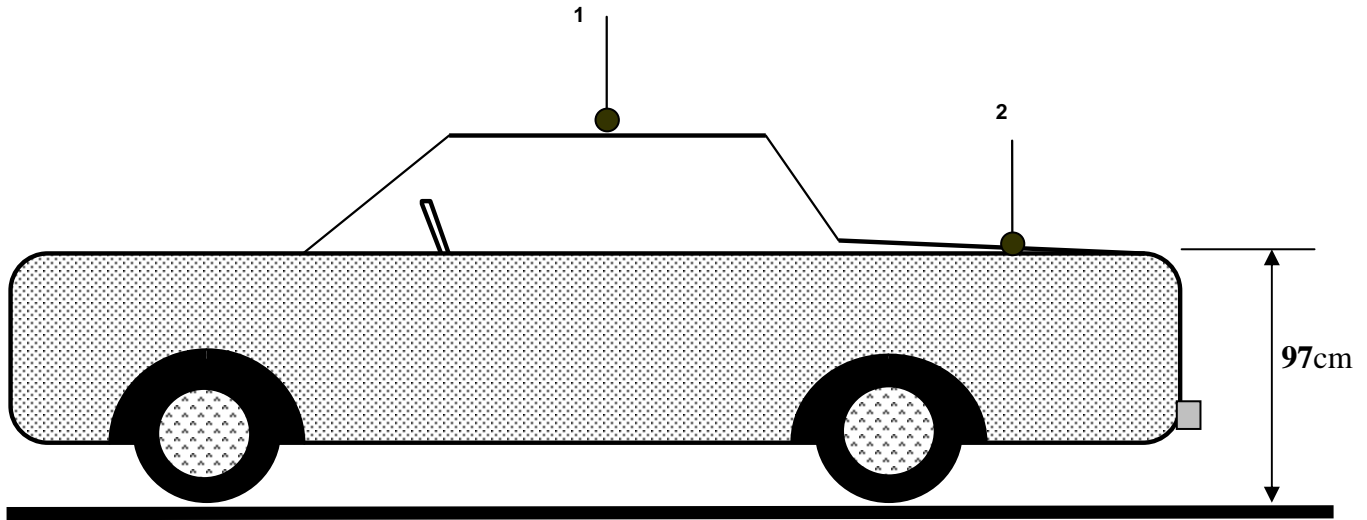
Therefore:

$$\text{Passenger} \quad T = \frac{0.078}{1.6} + \frac{0.180}{1.6} = 0.161 < 1 \quad (\text{compliant})$$

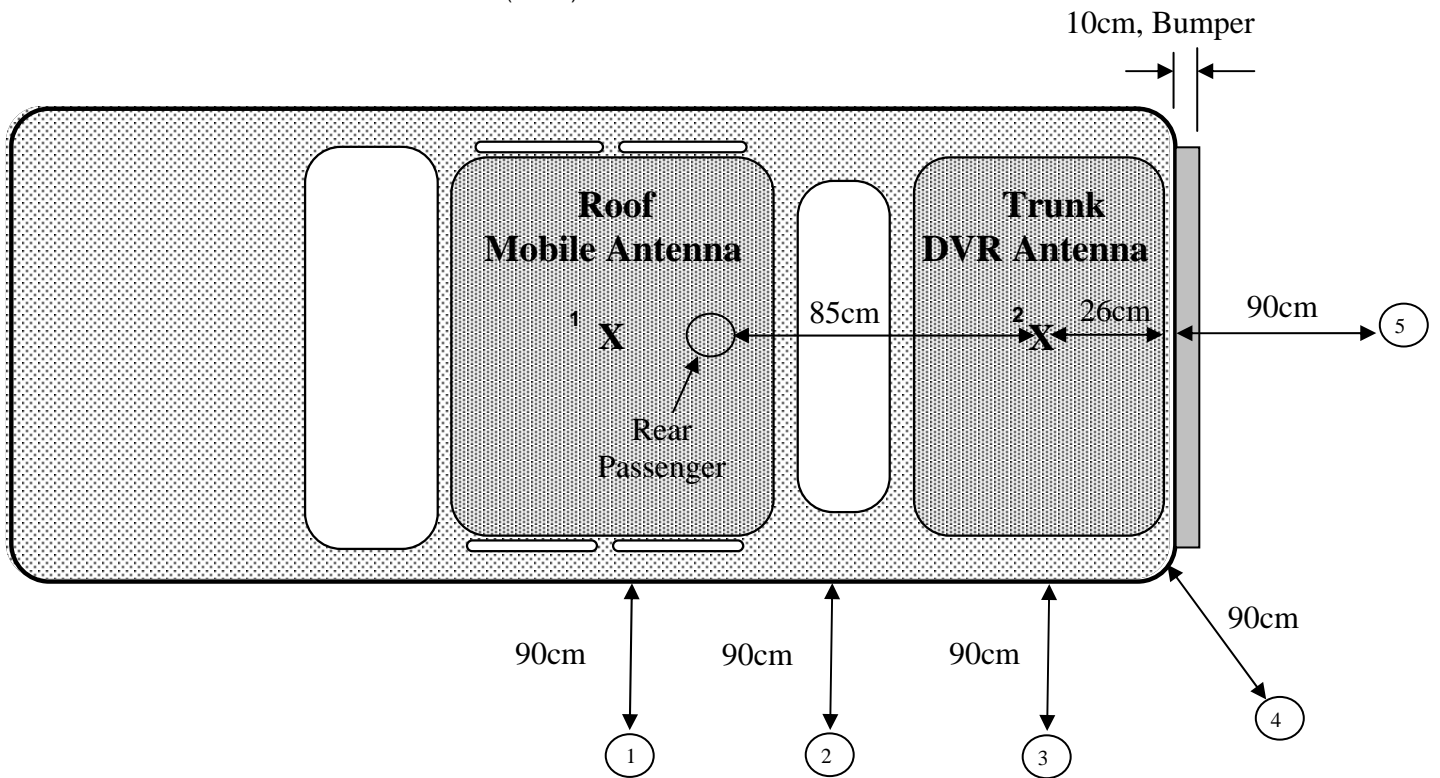
**APPENDIX A**

**Illustration of Antenna Locations and Test Distances**

### Illustration of Antenna Locations and Test Distances



1 - Roof (center)  
2 - Trunk (center)



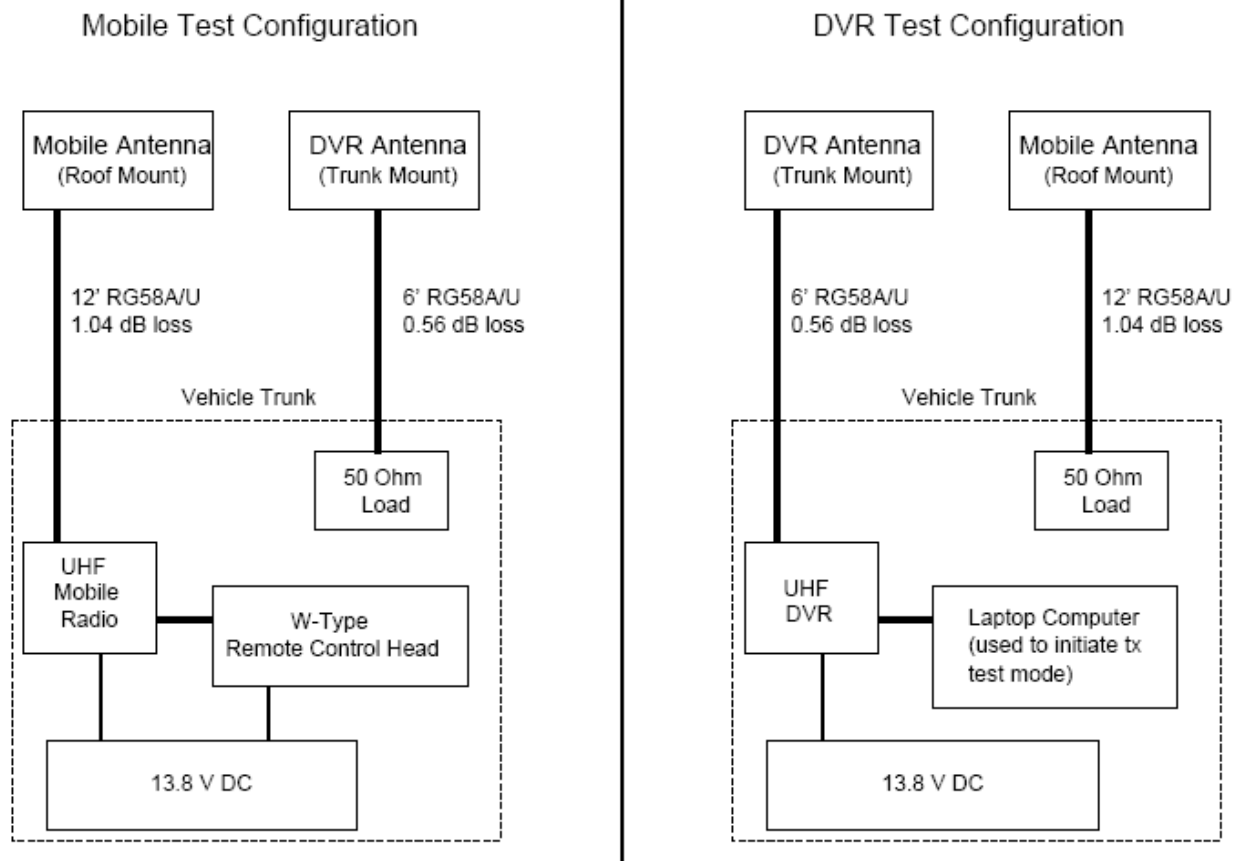
**Notes**

- 1) Assessments were performed at each test position for each offered antenna
- 2) By-stander positions (1-5) are 90cm from the vehicle body
- 3) By-stander position 2 is located at the mid point between the two antennas
- 4) Total distance between by-stander position 1 and roof mount antenna is 180cm
- 5) Total distance between by-stander position 5 and trunk mount antenna is 119.5cm
- 6) Total distance between trunk mount antenna and rear passenger is 85cm

**APPENDIX B**

**Block Diagram of MPE Test Configuration**

MPE Test Configuration



**APPENDIX C**

**Meter/Probe Calibration Certificates**





# Certificate of Calibration

L-3 Communications, Narda Microwave-East, hereby certifies that the referenced RF Radiation Hazard monitoring equipment has been calibrated in accordance with MIL-STD-45662A, ANSI Z540, ISO 10012 and ISO 9001: 2000.

The measured values were determined by comparison with our standards, which are traceable to the National Institute of Standards and Technology to the extent allowed by NIST's calibration facilities.

Customer: MOTOROLA  
SCHAUMBURG, IL 60168-0429

Certificate #: 64777 1

Model #: 8718-10

Serial #: 01122

Description: METER W/CABLE

PO #: NP2398645

Date Calibrated: 04/20/2006

R.O. #: 64777

  
Vince Donovan  
Manufacturing

  
Ken Peck  
Quality Assurance

This certificate shall not be reproduced, except in full, without written approval from L-3 Communications, Narda Microwave-East



# Certificate of Calibration

L-3 Communications, Narda Microwave-East, hereby certifies that the referenced RF Radiation Hazard monitoring equipment has been calibrated in accordance with MIL-STD-45662A, ANSI Z540, ISO 10012 and ISO 9001:2000.

The measured values were determined by comparison with our standards, which are traceable to the National Institute of Standards and Technology to the extent allowed by NIST's calibration facilities.

Customer: **MOTOROLA**  
**SCHAUMBURG, IL 60168-0429**

Certificate #: 64777 2

Model #: 8722B

Serial #: 12023

Description: PROBE

PO #: NP2398645

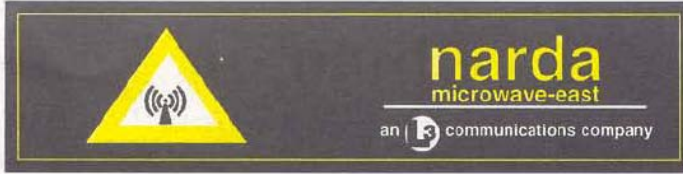
Date Calibrated: 04/20/2006

R.O. #: 64777

  
 Vince Donovan  
 Manufacturing

  
 Ken Peck  
 Quality Assurance

This certificate shall not be reproduced, except in full, without written approval from L-3 Communications, Narda Microwave-East



DATE 20-Apr-2006  
REL HUMIDITY 46%

RELEASE # R64777  
TEMP 21 DEG. C

NARDA MICROWAVE - EAST

MODEL # 8722B  
SERIAL # 12023

FREQ MHZ	PRE-CAL DATA	FINAL CAL DATA	ELLIPSE RATIO, dB	FINAL CORR. FACTOR
.30	0.81	0.78	+/- 0.24	1.28
3.00	1.27	1.23	+/- 0.38	0.81
10.00	0.76	0.74	+/- 0.23	1.35
30.00	0.65	0.63	+/- 0.13	1.58
100.00	1.17	1.14	+/- 0.22	0.88
300.00	0.90	0.87	+/- 0.34	1.14
750.00	1.31	1.27	+/- 0.30	0.79
1000.00	1.63	1.58	+/- 0.35	0.63
1700.00	1.00	0.97	+/- 0.48	1.03
2450.00	1.35	1.37	+/- 0.45	0.73
4000.00	0.92	0.93	+/- 0.43	1.07
8200.00	1.05	1.07	+/- 0.46	0.94
10000.00	1.05	1.07	+/- 0.42	0.94
18000.00	1.17	1.19	+/- 0.75	0.84
26500.00	0.93	0.94	+/- 0.83	1.07
40000.00	0.72	0.73	+/- 0.67	1.37

LOW FREQUENCY MULTIPLIER = 0.972      HIGH FREQUENCY MULTIPLIER = 1.014  
 FREQ. DEV. (3-40000 MHZ) = 3.993 DB  
 FREQ. DEV. (0.3-40000 MHZ) = 3.99 DB  
 MAX. ELLIPSE RATIO (0.3-40000 MHZ) = +/- 0.83 DB  
 PRE-CAL DATA REFLECTS THE MEAN ELLIPSE RATIO OF PROBE AS RECEIVED BY  
 NARDA CALIBRATION DEPARTMENT, OR IS THE INITIAL, UN-ADJUSTED RATIO.  
 (PRE-CAL x OLD CORR. FACTOR) - 1 = DEVIATION FROM PREVIOUS (OLD)  
 CALIBRATION DATA. NOTE: NOT APPLICABLE FOR NEW PROBES.  
 FINAL CAL DATA IS THE RATIO OF THE DISPLAYED TO THE APPLIED FIELD STRENGTH.  
 FINAL CORR. FACTOR IS THE RECIPROCAL OF FINAL CAL DATA.  
 FINAL CORR. FACTOR MULTIPLIED BY THE DISPLAYED FIELD STRENGTH READING  
 GIVES THE ACTUAL ("CORRECTED") FIELD STRENGTH.  
 ELLIPSE RATIO IS EXPRESSED IN dB DEVIATION FROM THE MEAN DATA  
 RMS Uncertainty = +/- 0.5db.    ATP # = 502120 REVJ

TESTER L-V      Q.A. APPROVAL 



# Certificate of Calibration

L-3 Communications, Narda Microwave-East, hereby certifies that the referenced RF Radiation Hazard monitoring equipment has been calibrated in accordance with MIL-STD-45662A, ANSI Z540, ISO 10012 and ISO 9001: 2000.

The measured values were determined by comparison with our standards, which are traceable to the National Institute of Standards and Technology to the extent allowed by NIST's calibration facilities.

Customer: MOTOROLA Certificate #: 56219 1  
 SCHAUMBURG, IL 60168-0429  
 Model #: 8718-10 Serial #: 01108  
 Description: METER W/CABLE PO #: NP1819669  
 Date Calibrated: 05/17/2005 R.O. #: 56219

*Vince Donovan*  
 Vince Donovan  
 Manager of Instruments Assembly and Test

*John C. Stine*  
 John C. Stine  
 Director of Quality Assurance

This certificate shall not be reproduced, except in full, without written approval from L-3 Communications, Narda Microwave-East



# Certificate of Calibration

L-3 Communications, Narda Microwave-East, hereby certifies that the referenced RF Radiation Hazard monitoring equipment has been calibrated in accordance with MIL-STD-45662A, ANSI Z540, ISO 10012 and ISO 9001: 2000.

The measured values were determined by comparison with our standards, which are traceable to the National Institute of Standards and Technology to the extent allowed by NIST's calibration facilities.

Customer: MOTOROLA  
PLANTATION, FL 33322

Certificate #: 63648 1

Model #: 8722B

Serial #: 13001


Description: PROBE

PO #: NP2316554

Date Calibrated: 02-28-06

R.O. #: 63648

  
Vince Donovan  
Manufacturing

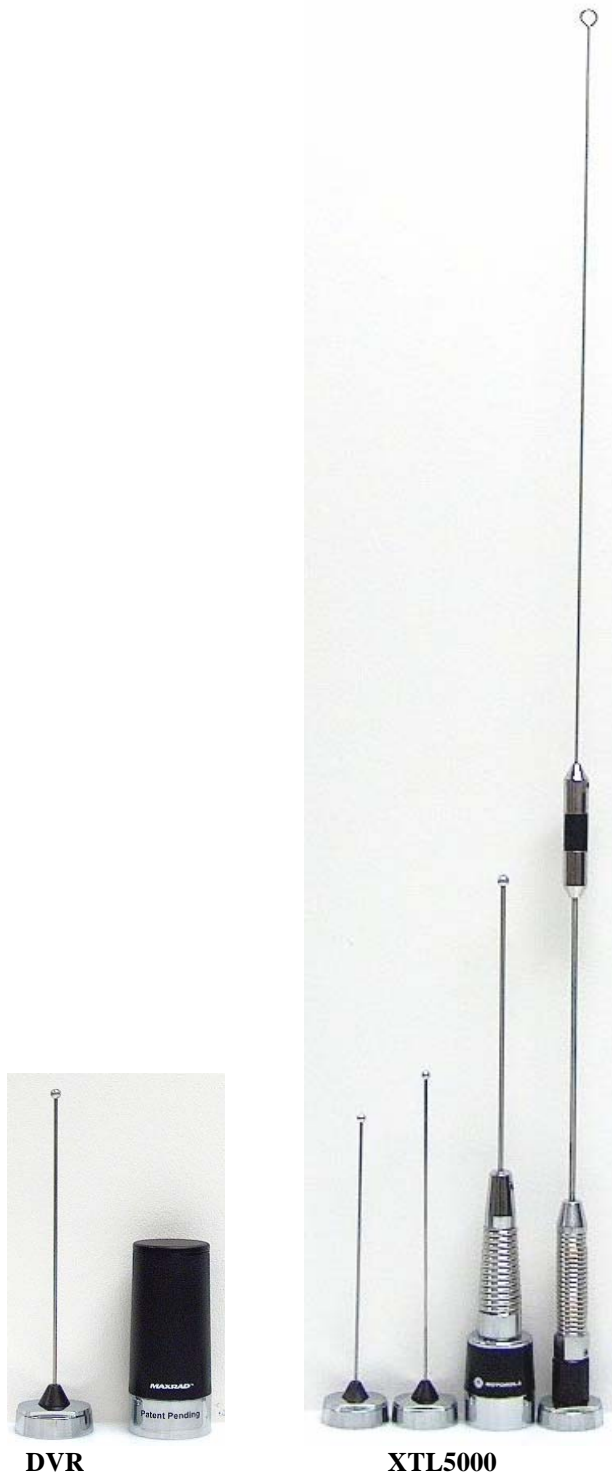
  
Ken Peck  
Quality Assurance

This certificate shall not be reproduced, except in full, without written approval from L-3 Communications, Narda Microwave-East



**APPENDIX D**

**Photos of Assessed Antennas**



**DVR**

**XTL5000**

**Antenna kit numbers, from left to right;  
DVR HAE4004A, HAE6016A, XTL5000 HAE4003A, HAE6012A, HAE6013A, HAE4011A**



**APPENDIX E**

**Detailed MPE Measurement Data**

**UHF DVR DQPM DVR6000P**

BS-Position 1

**Table 1**

External Vehicle MPE Assessment @ 470 MHz									
Antenna Location	Antenna Model	Gain (dBi)	Meas. Distance (cm)	E/H Field	Calibration Factor	Average over Body (mW/cm <sup>2</sup> )	Initial Power (W)	Pwr. Density Calc. (mW/cm <sup>2</sup> )	Pwr. Density Max Calc. (mW/cm <sup>2</sup> )
Trunk (cnt)	HAE6016A	2.15	90	E	1.01	0.025	10.0	0.025	0.03
Measurement Grid									
Test Position	Height (cm)	% of Control Limit		Test Position	Height (cm)	% of Control Limit		IEEE Controlled Limit	IEEE Uncontrolled Limit
1	20	0.6%		6	120	1.8%		1.57	0.31
2	40	0.9%		7	140	1.9%			
3	60	1.3%		8	160	1.7%			
4	80	1.2%		9	180	2.4%			
5	100	1.4%		10	200	2.9%			
								<b>RF Po (*Max)</b>	10.0

P-Position 1

**Table 2**

Internal Vehicle MPE Assessment @ 470 MHz										
Antenna Location	Antenna Model	Gain (dBi)	Meas. Distance (cm)	E/H Field	Calibration Factor	Average over Head, Chest, Lower Trunk Back/Front seats (mW/cm <sup>2</sup> )		Initial Power (W)	Pwr. Density Calc. (mW/cm <sup>2</sup> )	Pwr. Density Max Calc. (mW/cm <sup>2</sup> )
						Back	Front			
Trunk (cnt)	HAE6016A	2.15	Highest Reading	E	1.01	0.148	0.087	10.0	0.148	0.15
Measurement Grid										
Test Position		% of Control Limit Head		% of Control Limit Chest		% of Control Limit Lower Trunk		IEEE Controlled Limit:		1.57
Back Seat		14.3%		8.2%		5.8%		IEEE Uncontrolled Limit:		0.31
Front Seat		5.5%		2.9%		8.3%		<b>RF Po (*Max):</b>		10.0

BS-Position 1

**Table 3**

External Vehicle MPE Assessment @ 491 MHz									
Antenna Location	Antenna Model	Gain (dBi)	Meas. Distance (cm)	E/H Field	Calibration Factor	Average over Body (mW/cm <sup>2</sup> )	Initial Power (W)	Pwr. Density Calc. (mW/cm <sup>2</sup> )	Pwr. Density Max Calc. (mW/cm <sup>2</sup> )
Trunk (cnt)	HAE6016A	2.15	90	E	0.99	0.035	10.0	0.035	0.03
Measurement Grid									
Test Position	Height (cm)	% of Control Limit		Test Position	Height (cm)	% of Control Limit		IEEE Controlled Limit	IEEE Uncontrolled Limit
1	20	1.0%		6	120	2.3%		1.64	0.33
2	40	1.2%		7	140	2.7%			
3	60	1.2%		8	160	2.5%			
4	80	1.6%		9	180	2.9%			
5	100	2.2%		10	200	3.5%			
								<b>RF Po (*Max)</b>	10.0

**UHF DVR DQPMDVR6000P**

P-Position 1

**Table 4**

Internal Vehicle MPE Assessment @ 491 MHz										
Antenna Location	Antenna	Gain (dBi)	Meas. Distance (cm)	E/H Field	Calibration Factor	Average over Head, Chest, Lower Trunk Back/Front seats (mW/cm <sup>2</sup> )		Initial Power (W)	Pwr. Density Calc. (mW/cm <sup>2</sup> )	Pwr. Density Max Calc. (mW/cm <sup>2</sup> )
						Back	Front			
Trunk (cnt)	HAE6016A	2.15	Highest Reading	E	0.99	0.196	0.071	10.0	0.196	0.20
Measurement Grid										
Test Position		% of Control Limit Head	% of Control Limit Chest	% of Control Limit Lower Trunk		IEEE Controlled Limit:			1.64	
Back Seat		16.3%	13.1%	6.6%		IEEE Uncontrolled Limit:			0.33	
Front Seat		5.8%	3.8%	3.4%		<b>RF Po (*Max):</b>			10.0	

BS-Position 1

**Table 5**

External Vehicle MPE Assessment @ 512 MHz										
Antenna Location	Antenna Model	Gain (dBi)	Meas. Distance (cm)	E/H Field	Calibration Factor	Average over Body (mW/cm <sup>2</sup> )	Initial Power (W)	Pwr. Density Calc. (mW/cm <sup>2</sup> )	Pwr. Density Max Calc. (mW/cm <sup>2</sup> )	
Trunk (cnt)	HAE6016A	2.15	90	E	0.98	0.025	10.0	0.025	0.03	
Measurement Grid										
Test Position	Height (cm)	% of Control Limit		Test Position	Height (cm)	% of Control Limit		IEEE Controlled Limit	IEEE Uncontrolled Limit	
1	20	1.0%		6	120	1.4%		1.71	0.34	
2	40	1.0%		7	140	1.5%				
3	60	1.1%		8	160	1.8%				
4	80	1.2%		9	180	2.0%				
5	100	1.3%		10	200	2.4%				
								<b>RF Po (*Max)</b>		10.0

P-Position 1

**Table 6**

Internal Vehicle MPE Assessment @ 512 MHz										
Antenna Location	Antenna	Gain (dBi)	Meas. Distance (cm)	E/H Field	Calibration Factor	Average over Head, Chest, Lower Trunk Back/Front seats (mW/cm <sup>2</sup> )		Initial Power (W)	Pwr. Density Calc. (mW/cm <sup>2</sup> )	Pwr. Density Max Calc. (mW/cm <sup>2</sup> )
						Back	Front			
Trunk (cnt)	HAE6016A	2.15	Highest Reading	E	0.98	0.135	0.062	10.0	0.135	0.13
Measurement Grid										
Test Position		% of Control Limit Head	% of Control Limit Chest	% of Control Limit Lower Trunk		IEEE Controlled Limit:			1.71	
Back Seat		12.3%	8.4%	3.0%		IEEE Uncontrolled Limit:			0.34	
Front Seat		4.8%	3.3%	2.8%		<b>RF Po (*Max):</b>			10.0	

**UHF DVR DQPMDVR6000P**

BS-Position 1

**Table 7**

External Vehicle MPE Assessment @ 470 MHz									
Antenna Location	Antenna Model	Gain (dBi)	Meas. Distance (cm)	E/H Field	Calibration Factor	Average over Body (mW/cm <sup>2</sup> )	Initial Power (W)	Pwr. Density Calc. (mW/cm <sup>2</sup> )	Pwr. Density Max Calc. (mW/cm <sup>2</sup> )
Trunk (cnt)	HAE4004A	2.15	90	E	1.01	0.032	10.0	0.032	0.03
Measurement Grid									
Test Position	Height (cm)	% of Control Limit		Test Position	Height (cm)	% of Control Limit		IEEE Controlled Limit	IEEE Uncontrolled Limit
1	20	1.0%		6	120	2.3%		1.57	0.31
2	40	1.2%		7	140	2.4%			
3	60	1.4%		8	160	2.7%			
4	80	1.6%		9	180	2.6%			
5	100	2.0%		10	200	3.0%			
								<b>RF Po (*Max)</b>	10.0

P-Position 1

**Table 8**

Internal Vehicle MPE Assessment @ 470 MHz										
Antenna Location	Antenna Model	Gain (dBi)	Meas. Distance (cm)	E/H Field	Calibration Factor	Average over Head, Chest, Lower Trunk Back/Front seats (mW/cm <sup>2</sup> )		Initial Power (W)	Pwr. Density Calc. (mW/cm <sup>2</sup> )	Pwr. Density Max Calc. (mW/cm <sup>2</sup> )
						Back	Front			
Trunk (cnt)	HAE4004A	2.15	Highest Reading	E	1.01	0.143	0.095	10.0	0.143	0.14
Measurement Grid										
Test Position		% of Control Limit Head		% of Control Limit Chest		% of Control Limit Lower Trunk		IEEE Controlled Limit:		1.57
Back Seat		13.7%		8.0%		5.7%		IEEE Uncontrolled Limit:		0.31
Front Seat		5.7%		3.6%		8.8%		<b>RF Po (*Max):</b>		10.0

BS-Position 1

**Table 9**

External Vehicle MPE Assessment @ 491 MHz									
Antenna Location	Antenna Model	Gain (dBi)	Meas. Distance (cm)	E/H Field	Calibration Factor	Average over Body (mW/cm <sup>2</sup> )	Initial Power (W)	Pwr. Density Calc. (mW/cm <sup>2</sup> )	Pwr. Density Max Calc. (mW/cm <sup>2</sup> )
Trunk (cnt)	HAE4004A	2.15	90	E	0.99	0.034	10.0	0.034	0.03
Measurement Grid									
Test Position	Height (cm)	% of Control Limit		Test Position	Height (cm)	% of Control Limit		IEEE Controlled Limit	IEEE Uncontrolled Limit
1	20	1.1%		6	120	2.0%		1.64	0.33
2	40	1.1%		7	140	2.2%			
3	60	1.5%		8	160	2.5%			
4	80	1.8%		9	180	3.1%			
5	100	1.8%		10	200	3.7%			
								<b>RF Po (*Max)</b>	10.0

**UHF DVR DQPMDVR6000P**

P-Position 1

**Table 10**

Internal Vehicle MPE Assessment @ 491 MHz										
Antenna Location	Antenna	Gain (dBi)	Meas. Distance (cm)	E/H Field	Calibration Factor	Average over Head, Chest, Lower Trunk Back/Front seats (mW/cm <sup>2</sup> )		Initial Power (W)	Pwr. Density Calc. (mW/cm <sup>2</sup> )	Pwr. Density Max Calc. (mW/cm <sup>2</sup> )
						Back	Front			
Trunk (cnt)	HAE4004A	2.15	Highest Reading	E	0.99	0.163	0.057	10.0	0.163	0.16
Measurement Grid										
Test Position		% of Control Limit Head	% of Control Limit Chest	% of Control Limit Lower Trunk		IEEE Controlled Limit:			1.64	
Back Seat		14.1%	10.4%	5.3%		IEEE Uncontrolled Limit:			0.33	
Front Seat		4.4%	3.4%	2.7%		<b>RF Po (*Max):</b>			10.0	

BS-Position 1

**Table 11**

External Vehicle MPE Assessment @ 512 MHz									
Antenna Location	Antenna Model	Gain (dBi)	Meas. Distance (cm)	E/H Field	Calibration Factor	Average over Body (mW/cm <sup>2</sup> )	Initial Power (W)	Pwr. Density Calc. (mW/cm <sup>2</sup> )	Pwr. Density Max Calc. (mW/cm <sup>2</sup> )
Trunk (cnt)	HAE4004A	2.15	90	E	0.98	0.028	10.0	0.028	0.03
Measurement Grid									
Test Position	Height (cm)	% of Control Limit		Test Position	Height (cm)	% of Control Limit		IEEE Controlled Limit	IEEE Uncontrolled Limit
1	20	1.0%		6	120	1.6%		1.71	0.34
2	40	1.1%		7	140	2.0%		<b>RF Po (*Max)</b>	10.0
3	60	1.2%		8	160	2.0%			
4	80	1.4%		9	180	2.3%			
5	100	1.4%		10	200	2.4%			

P-Position 1

**Table 12**

Internal Vehicle MPE Assessment @ 512 MHz										
Antenna Location	Antenna	Gain (dBi)	Meas. Distance (cm)	E/H Field	Calibration Factor	Average over Head, Chest, Lower Trunk Back/Front seats (mW/cm <sup>2</sup> )		Initial Power (W)	Pwr. Density Calc. (mW/cm <sup>2</sup> )	Pwr. Density Max Calc. (mW/cm <sup>2</sup> )
						Back	Front			
Trunk (cnt)	HAE4004A	2.15	Highest Reading	E	0.98	0.193	0.077	10.0	0.193	0.19
Measurement Grid										
Test Position		% of Control Limit Head	% of Control Limit Chest	% of Control Limit Lower Trunk		IEEE Controlled Limit:			1.71	
Back Seat		15.4%	13.7%	4.8%		IEEE Uncontrolled Limit:			0.34	
Front Seat		6.9%	3.3%	3.4%		<b>RF Po (*Max):</b>			10.0	

**UHF DVR DQPMDVR6000P**

BS-Position 2

**Table 13**

External Vehicle MPE Assessment @ 470 MHz									
Antenna Location	Antenna Model	Gain (dBi)	Meas. Distance (cm)	E/H Field	Calibration Factor	Average over Body (mW/cm <sup>2</sup> )	Initial Power (W)	Pwr. Density Calc. (mW/cm <sup>2</sup> )	Pwr. Density Max Calc. (mW/cm <sup>2</sup> )
Trunk (cnt)	HAE6016A	2.15	90	E	1.01	0.020	10.0	0.020	0.02
Measurement Grid									
Test Position	Height (cm)	% of Control Limit		Test Position	Height (cm)	% of Control Limit		IEEE Controlled Limit	IEEE Uncontrolled Limit
1	20	0.3%		6	120	1.0%		1.57	0.31
2	40	0.2%		7	140	1.7%			
3	60	0.3%		8	160	1.9%			
4	80	0.4%		9	180	2.8%			
5	100	0.7%		10	200	3.4%			
								<b>RF Po (*Max)</b>	10.0

BS-Position 2

**Table 14**

External Vehicle MPE Assessment @ 491 MHz									
Antenna Location	Antenna Model	Gain (dBi)	Meas. Distance (cm)	E/H Field	Calibration Factor	Average over Body (mW/cm <sup>2</sup> )	Initial Power (W)	Pwr. Density Calc. (mW/cm <sup>2</sup> )	Pwr. Density Max Calc. (mW/cm <sup>2</sup> )
Trunk (cnt)	HAE6016A	2.15	90	E	0.99	0.020	10.0	0.020	0.02
Measurement Grid									
Test Position	Height (cm)	% of Control Limit		Test Position	Height (cm)	% of Control Limit		IEEE Controlled Limit	IEEE Uncontrolled Limit
1	20	0.3%		6	120	1.0%		1.64	0.33
2	40	0.2%		7	140	1.7%			
3	60	0.3%		8	160	2.2%			
4	80	0.5%		9	180	2.5%			
5	100	0.8%		10	200	2.5%			
								<b>RF Po (*Max)</b>	10.0

BS-Position 2

**Table 15**

External Vehicle MPE Assessment @ 512 MHz									
Antenna Location	Antenna Model	Gain (dBi)	Meas. Distance (cm)	E/H Field	Calibration Factor	Average over Body (mW/cm <sup>2</sup> )	Initial Power (W)	Pwr. Density Calc. (mW/cm <sup>2</sup> )	Pwr. Density Max Calc. (mW/cm <sup>2</sup> )
Trunk (cnt)	HAE6016A	2.15	90	E	0.98	0.016	10.0	0.016	0.02
Measurement Grid									
Test Position	Height (cm)	% of Control Limit		Test Position	Height (cm)	% of Control Limit		IEEE Controlled Limit	IEEE Uncontrolled Limit
1	20	0.5%		6	120	0.9%		1.71	0.34
2	40	0.4%		7	140	1.0%			
3	60	0.5%		8	160	1.4%			
4	80	0.5%		9	180	1.4%			
5	100	0.6%		10	200	2.3%			
								<b>RF Po (*Max)</b>	10.0

**UHF DVR DQPM DVR6000P**

BS-Position 2

**Table 16**

External Vehicle MPE Assessment @ 470 MHz									
Antenna Location	Antenna Model	Gain (dBi)	Meas. Distance (cm)	E/H Field	Calibration Factor	Average over Body (mW/cm <sup>2</sup> )	Initial Power (W)	Pwr. Density Calc. (mW/cm <sup>2</sup> )	Pwr. Density Max Calc. (mW/cm <sup>2</sup> )
Trunk (cnt)	HAE4004A	2.15	90	E	1.01	0.017	10.0	0.017	0.02
Measurement Grid									
Test Position	Height (cm)	% of Control Limit		Test Position	Height (cm)	% of Control Limit		IEEE Controlled Limit	IEEE Uncontrolled Limit
1	20	0.2%		6	120	1.0%		1.57	0.31
2	40	0.1%		7	140	1.3%			
3	60	0.2%		8	160	2.2%			
4	80	0.4%		9	180	2.4%			
5	100	0.5%		10	200	2.6%			
								RF Po (*Max)	10.0

BS-Position 2

**Table 17**

External Vehicle MPE Assessment @ 491 MHz									
Antenna Location	Antenna Model	Gain (dBi)	Meas. Distance (cm)	E/H Field	Calibration Factor	Average over Body (mW/cm <sup>2</sup> )	Initial Power (W)	Pwr. Density Calc. (mW/cm <sup>2</sup> )	Pwr. Density Max Calc. (mW/cm <sup>2</sup> )
Trunk (cnt)	HAE4004A	2.15	90	E	0.99	0.021	10.0	0.021	0.02
Measurement Grid									
Test Position	Height (cm)	% of Control Limit		Test Position	Height (cm)	% of Control Limit		IEEE Controlled Limit	IEEE Uncontrolled Limit
1	20	0.1%		6	120	1.4%		1.64	0.33
2	40	0.2%		7	140	1.7%			
3	60	0.4%		8	160	1.8%			
4	80	0.7%		9	180	2.6%			
5	100	0.9%		10	200	3.0%			
								RF Po (*Max)	10.0

BS-Position 2

**Table 18**

External Vehicle MPE Assessment @ 512 MHz									
Antenna Location	Antenna Model	Gain (dBi)	Meas. Distance (cm)	E/H Field	Calibration Factor	Average over Body (mW/cm <sup>2</sup> )	Initial Power (W)	Pwr. Density Calc. (mW/cm <sup>2</sup> )	Pwr. Density Max Calc. (mW/cm <sup>2</sup> )
Trunk (cnt)	HAE4004A	2.15	90	E	0.98	0.025	10.0	0.025	0.02
Measurement Grid									
Test Position	Height (cm)	% of Control Limit		Test Position	Height (cm)	% of Control Limit		IEEE Controlled Limit	IEEE Uncontrolled Limit
1	20	0.4%		6	120	1.7%		1.71	0.34
2	40	0.6%		7	140	1.8%			
3	60	0.7%		8	160	2.0%			
4	80	1.0%		9	180	2.1%			
5	100	1.3%		10	200	2.9%			
								RF Po (*Max)	10.0

**UHF DVR DQPM DVR6000P**

BS-Position 3

**Table 19**

External Vehicle MPE Assessment @ 470 MHz									
Antenna Location	Antenna Model	Gain (dBi)	Meas. Distance (cm)	E/H Field	Calibration Factor	Average over Body (mW/cm <sup>2</sup> )	Initial Power (W)	Pwr. Density Calc. (mW/cm <sup>2</sup> )	Pwr. Density Max Calc. (mW/cm <sup>2</sup> )
Trunk (cnt)	HAE6016A	2.15	90	E	1.01	0.034	10.0	0.034	0.03
Measurement Grid									
Test Position	Height (cm)	% of Control Limit		Test Position	Height (cm)	% of Control Limit		IEEE Controlled Limit	IEEE Uncontrolled Limit
1	20	1.2%		6	120	2.3%		1.57	0.31
2	40	0.8%		7	140	3.3%			
3	60	1.1%		8	160	3.4%			
4	80	1.6%		9	180	2.9%			
5	100	2.2%		10	200	2.8%			
								<b>RF Po (*Max)</b>	10.0

BS-Position 3

**Table 20**

External Vehicle MPE Assessment @ 491 MHz									
Antenna Location	Antenna Model	Gain (dBi)	Meas. Distance (cm)	E/H Field	Calibration Factor	Average over Body (mW/cm <sup>2</sup> )	Initial Power (W)	Pwr. Density Calc. (mW/cm <sup>2</sup> )	Pwr. Density Max Calc. (mW/cm <sup>2</sup> )
Trunk (cnt)	HAE6016A	2.15	90	E	0.99	0.041	10.0	0.041	0.04
Measurement Grid									
Test Position	Height (cm)	% of Control Limit		Test Position	Height (cm)	% of Control Limit		IEEE Controlled Limit	IEEE Uncontrolled Limit
1	20	1.0%		6	120	2.7%		1.64	0.33
2	40	1.1%		7	140	4.1%			
3	60	1.2%		8	160	4.0%			
4	80	1.9%		9	180	3.6%			
5	100	2.3%		10	200	3.2%			
								<b>RF Po (*Max)</b>	10.0

BS-Position 3

**Table 21**

External Vehicle MPE Assessment @ 512 MHz									
Antenna Location	Antenna Model	Gain (dBi)	Meas. Distance (cm)	E/H Field	Calibration Factor	Average over Body (mW/cm <sup>2</sup> )	Initial Power (W)	Pwr. Density Calc. (mW/cm <sup>2</sup> )	Pwr. Density Max Calc. (mW/cm <sup>2</sup> )
Trunk (cnt)	HAE6016A	2.15	90	E	0.98	0.025	10.0	0.025	0.02
Measurement Grid									
Test Position	Height (cm)	% of Control Limit		Test Position	Height (cm)	% of Control Limit		IEEE Controlled Limit	IEEE Uncontrolled Limit
1	20	0.3%		6	120	1.5%		1.71	0.34
2	40	0.3%		7	140	1.8%			
3	60	0.8%		8	160	2.4%			
4	80	1.2%		9	180	2.5%			
5	100	1.3%		10	200	2.5%			
								<b>RF Po (*Max)</b>	10.0



**UHF DVR DQPMDVR6000P**

BS-Position 3

**Table 22**

External Vehicle MPE Assessment @ 470 MHz									
Antenna Location	Antenna Model	Gain (dBi)	Meas. Distance (cm)	E/H Field	Calibration Factor	Average over Body (mW/cm <sup>2</sup> )	Initial Power (W)	Pwr. Density Calc. (mW/cm <sup>2</sup> )	Pwr. Density Max Calc. (mW/cm <sup>2</sup> )
Trunk (cnt)	HAE4004A	2.15	90	E	1.01	0.039	10.0	0.039	0.04
Measurement Grid									
Test Position	Height (cm)	% of Control Limit		Test Position	Height (cm)	% of Control Limit		IEEE Controlled Limit	IEEE Uncontrolled Limit
1	20	0.9%		6	120	3.5%		1.57	0.31
2	40	1.0%		7	140	3.8%			
3	60	1.6%		8	160	3.6%			
4	80	2.4%		9	180	3.0%			
5	100	2.5%		10	200	2.8%			
								<b>RF Po (*Max)</b>	
								10.0	

BS-Position 3

**Table 23**

External Vehicle MPE Assessment @ 491 MHz									
Antenna Location	Antenna Model	Gain (dBi)	Meas. Distance (cm)	E/H Field	Calibration Factor	Average over Body (mW/cm <sup>2</sup> )	Initial Power (W)	Pwr. Density Calc. (mW/cm <sup>2</sup> )	Pwr. Density Max Calc. (mW/cm <sup>2</sup> )
Trunk (cnt)	HAE4004A	2.15	90	E	0.99	0.039	10.0	0.039	0.04
Measurement Grid									
Test Position	Height (cm)	% of Control Limit		Test Position	Height (cm)	% of Control Limit		IEEE Controlled Limit	IEEE Uncontrolled Limit
1	20	0.8%		6	120	2.7%		1.64	0.33
2	40	1.1%		7	140	3.1%			
3	60	1.8%		8	160	3.6%			
4	80	2.0%		9	180	3.6%			
5	100	2.3%		10	200	3.1%			
								<b>RF Po (*Max)</b>	
								10.0	

BS-Position 3

**Table 24**

External Vehicle MPE Assessment @ 512 MHz									
Antenna Location	Antenna Model	Gain (dBi)	Meas. Distance (cm)	E/H Field	Calibration Factor	Average over Body (mW/cm <sup>2</sup> )	Initial Power (W)	Pwr. Density Calc. (mW/cm <sup>2</sup> )	Pwr. Density Max Calc. (mW/cm <sup>2</sup> )
Trunk (cnt)	HAE4004A	2.15	90	E	0.98	0.033	10.0	0.033	0.03
Measurement Grid									
Test Position	Height (cm)	% of Control Limit		Test Position	Height (cm)	% of Control Limit		IEEE Controlled Limit	IEEE Uncontrolled Limit
1	20	1.0%		6	120	2.4%		1.71	0.34
2	40	0.5%		7	140	2.8%			
3	60	1.0%		8	160	3.0%			
4	80	1.2%		9	180	3.0%			
5	100	1.8%		10	200	2.9%			
								<b>RF Po (*Max)</b>	
								10.0	

**UHF DVR DQPM DVR6000P**

BS-Position 4

**Table 25**

External Vehicle MPE Assessment @ 470 MHz									
Antenna Location	Antenna Model	Gain (dBi)	Meas. Distance (cm)	E/H Field	Calibration Factor	Average over Body (mW/cm <sup>2</sup> )	Initial Power (W)	Pwr. Density Calc. (mW/cm <sup>2</sup> )	Pwr. Density Max Calc. (mW/cm <sup>2</sup> )
Trunk (cnt)	HAE6016A	2.15	90	E	1.01	0.061	10.0	0.061	0.06
Measurement Grid									
Test Position	Height (cm)	% of Control Limit		Test Position	Height (cm)	% of Control Limit		IEEE Controlled Limit	IEEE Uncontrolled Limit
1	20	2.5%		6	120	4.7%		1.57	0.31
2	40	2.6%		7	140	4.6%			
3	60	2.9%		8	160	4.6%			
4	80	3.6%		9	180	4.5%			
5	100	4.3%		10	200	4.4%			
								<b>RF Po (*Max)</b>	
								10.0	

BS-Position 4

**Table 26**

External Vehicle MPE Assessment @ 491 MHz									
Antenna Location	Antenna Model	Gain (dBi)	Meas. Distance (cm)	E/H Field	Calibration Factor	Average over Body (mW/cm <sup>2</sup> )	Initial Power (W)	Pwr. Density Calc. (mW/cm <sup>2</sup> )	Pwr. Density Max Calc. (mW/cm <sup>2</sup> )
Trunk (cnt)	HAE6016A	2.15	90	E	0.99	0.069	10.0	0.069	0.07
Measurement Grid									
Test Position	Height (cm)	% of Control Limit		Test Position	Height (cm)	% of Control Limit		IEEE Controlled Limit	IEEE Uncontrolled Limit
1	20	3.1%		6	120	5.2%		1.64	0.33
2	40	2.5%		7	140	5.5%			
3	60	3.0%		8	160	5.5%			
4	80	3.8%		9	180	4.9%			
5	100	4.2%		10	200	4.5%			
								<b>RF Po (*Max)</b>	
								10.0	

BS-Position 4

**Table 27**

External Vehicle MPE Assessment @ 512 MHz									
Antenna Location	Antenna Model	Gain (dBi)	Meas. Distance (cm)	E/H Field	Calibration Factor	Average over Body (mW/cm <sup>2</sup> )	Initial Power (W)	Pwr. Density Calc. (mW/cm <sup>2</sup> )	Pwr. Density Max Calc. (mW/cm <sup>2</sup> )
Trunk (cnt)	HAE6016A	2.15	90	E	0.98	0.053	10.0	0.053	0.05
Measurement Grid									
Test Position	Height (cm)	% of Control Limit		Test Position	Height (cm)	% of Control Limit		IEEE Controlled Limit	IEEE Uncontrolled Limit
1	20	1.5%		6	120	3.4%		1.71	0.34
2	40	1.5%		7	140	3.5%			
3	60	3.0%		8	160	4.5%			
4	80	3.3%		9	180	4.0%			
5	100	2.9%		10	200	3.5%			
								<b>RF Po (*Max)</b>	
								10.0	

**UHF DVR DQPM DVR6000P**

BS-Position 4

**Table 28**

External Vehicle MPE Assessment @ 470 MHz									
Antenna Location	Antenna Model	Gain (dBi)	Meas. Distance (cm)	E/H Field	Calibration Factor	Average over Body (mW/cm <sup>2</sup> )	Initial Power (W)	Pwr. Density Calc. (mW/cm <sup>2</sup> )	Pwr. Density Max Calc. (mW/cm <sup>2</sup> )
Trunk (cnt)	HAE4004A	2.15	90	E	1.01	0.044	10.0	0.044	0.04
Measurement Grid									
Test Position	Height (cm)	% of Control Limit		Test Position	Height (cm)	% of Control Limit		IEEE Controlled Limit	IEEE Uncontrolled Limit
1	20	1.8%		6	120	3.3%		1.57	0.31
2	40	1.5%		7	140	3.7%			
3	60	1.9%		8	160	3.9%			
4	80	2.7%		9	180	3.4%			
5	100	3.1%		10	200	2.8%			
								<b>RF Po (*Max)</b>	10.0

BS-Position 4

**Table 29**

External Vehicle MPE Assessment @ 491 MHz									
Antenna Location	Antenna Model	Gain (dBi)	Meas. Distance (cm)	E/H Field	Calibration Factor	Average over Body (mW/cm <sup>2</sup> )	Initial Power (W)	Pwr. Density Calc. (mW/cm <sup>2</sup> )	Pwr. Density Max Calc. (mW/cm <sup>2</sup> )
Trunk (cnt)	HAE4004A	2.15	90	E	0.99	0.046	10.0	0.046	0.05
Measurement Grid									
Test Position	Height (cm)	% of Control Limit		Test Position	Height (cm)	% of Control Limit		IEEE Controlled Limit	IEEE Uncontrolled Limit
1	20	1.2%		6	120	3.4%		1.64	0.33
2	40	1.7%		7	140	3.9%			
3	60	2.0%		8	160	4.2%			
4	80	2.6%		9	180	3.4%			
5	100	3.0%		10	200	2.6%			
								<b>RF Po (*Max)</b>	10.0

BS-Position 4

**Table 30**

External Vehicle MPE Assessment @ 512 MHz									
Antenna Location	Antenna Model	Gain (dBi)	Meas. Distance (cm)	E/H Field	Calibration Factor	Average over Body (mW/cm <sup>2</sup> )	Initial Power (W)	Pwr. Density Calc. (mW/cm <sup>2</sup> )	Pwr. Density Max Calc. (mW/cm <sup>2</sup> )
Trunk (cnt)	HAE4004A	2.15	90	E	0.98	0.043	10.0	0.043	0.04
Measurement Grid									
Test Position	Height (cm)	% of Control Limit		Test Position	Height (cm)	% of Control Limit		IEEE Controlled Limit	IEEE Uncontrolled Limit
1	20	1.4%		6	120	2.8%		1.71	0.34
2	40	1.5%		7	140	3.0%			
3	60	1.9%		8	160	3.4%			
4	80	2.2%		9	180	3.6%			
5	100	2.5%		10	200	3.1%			
								<b>RF Po (*Max)</b>	10.0

**UHF DVR DQPM DVR6000P**

BS-Position 5

**Table 31**

External Vehicle MPE Assessment @ 470 MHz									
Antenna Location	Antenna Model	Gain (dBi)	Meas. Distance (cm)	E/H Field	Calibration Factor	Average over Body (mW/cm <sup>2</sup> )	Initial Power (W)	Pwr. Density Calc. (mW/cm <sup>2</sup> )	Pwr. Density Max Calc. (mW/cm <sup>2</sup> )
Trunk (cnt)	HAE6016A	2.15	90	E	1.01	0.048	10.0	0.048	0.05
Measurement Grid									
Test Position	Height (cm)	% of Control Limit		Test Position	Height (cm)	% of Control Limit		IEEE Controlled Limit	IEEE Uncontrolled Limit
1	20	1.4%		6	120	3.7%		1.57	0.31
2	40	2.0%		7	140	4.8%			
3	60	2.1%		8	160	4.2%			
4	80	2.8%		9	180	3.6%			
5	100	3.1%		10	200	2.7%			
								<b>RF Po (*Max)</b>	10.0

BS-Position 5

**Table 32**

External Vehicle MPE Assessment @ 491 MHz									
Antenna Location	Antenna Model	Gain (dBi)	Meas. Distance (cm)	E/H Field	Calibration Factor	Average over Body (mW/cm <sup>2</sup> )	Initial Power (W)	Pwr. Density Calc. (mW/cm <sup>2</sup> )	Pwr. Density Max Calc. (mW/cm <sup>2</sup> )
Trunk (cnt)	HAE6016A	2.15	90	E	0.99	0.057	10.0	0.057	0.06
Measurement Grid									
Test Position	Height (cm)	% of Control Limit		Test Position	Height (cm)	% of Control Limit		IEEE Controlled Limit	IEEE Uncontrolled Limit
1	20	1.9%		6	120	4.6%		1.64	0.33
2	40	2.3%		7	140	5.3%			
3	60	2.6%		8	160	4.6%			
4	80	3.0%		9	180	3.4%			
5	100	4.2%		10	200	2.8%			
								<b>RF Po (*Max)</b>	10.0

BS-Position 5

**Table 33**

External Vehicle MPE Assessment @ 512 MHz									
Antenna Location	Antenna Model	Gain (dBi)	Meas. Distance (cm)	E/H Field	Calibration Factor	Average over Body (mW/cm <sup>2</sup> )	Initial Power (W)	Pwr. Density Calc. (mW/cm <sup>2</sup> )	Pwr. Density Max Calc. (mW/cm <sup>2</sup> )
Trunk (cnt)	HAE6016A	2.15	90	E	0.98	0.051	10.0	0.051	0.05
Measurement Grid									
Test Position	Height (cm)	% of Control Limit		Test Position	Height (cm)	% of Control Limit		IEEE Controlled Limit	IEEE Uncontrolled Limit
1	20	1.2%		6	120	4.0%		1.71	0.34
2	40	1.4%		7	140	4.3%			
3	60	2.3%		8	160	4.5%			
4	80	3.0%		9	180	3.4%			
5	100	3.2%		10	200	2.8%			
								<b>RF Po (*Max)</b>	10.0

**UHF DVR DQPM DVR6000P**

BS-Position 5

**Table 34**

External Vehicle MPE Assessment @ 470 MHz									
Antenna Location	Antenna Model	Gain (dBi)	Meas. Distance (cm)	E/H Field	Calibration Factor	Average over Body (mW/cm <sup>2</sup> )	Initial Power (W)	Pwr. Density Calc. (mW/cm <sup>2</sup> )	Pwr. Density Max Calc. (mW/cm <sup>2</sup> )
Trunk (cnt)	HAE4004A	2.15	90	E	1.01	0.046	10.0	0.046	0.05
Measurement Grid									
Test Position	Height (cm)	% of Control Limit		Test Position	Height (cm)	% of Control Limit		IEEE Controlled Limit	IEEE Uncontrolled Limit
1	20	1.4%		6	120	4.5%		1.57	0.31
2	40	1.8%		7	140	4.4%			
3	60	2.6%		8	160	3.7%			
4	80	3.0%		9	180	2.5%			
5	100	3.4%		10	200	2.2%			
								RF Po (*Max)	10.0

BS-Position 5

**Table 35**

External Vehicle MPE Assessment @ 491 MHz									
Antenna Location	Antenna Model	Gain (dBi)	Meas. Distance (cm)	E/H Field	Calibration Factor	Average over Body (mW/cm <sup>2</sup> )	Initial Power (W)	Pwr. Density Calc. (mW/cm <sup>2</sup> )	Pwr. Density Max Calc. (mW/cm <sup>2</sup> )
Trunk (cnt)	HAE4004A	2.15	90	E	0.99	0.053	10.0	0.053	0.05
Measurement Grid									
Test Position	Height (cm)	% of Control Limit		Test Position	Height (cm)	% of Control Limit		IEEE Controlled Limit	IEEE Uncontrolled Limit
1	20	1.5%		6	120	4.3%		1.64	0.33
2	40	2.1%		7	140	4.4%			
3	60	3.2%		8	160	3.8%			
4	80	3.2%		9	180	3.5%			
5	100	3.8%		10	200	2.4%			
								RF Po (*Max)	10.0

BS-Position 5

**Table 36**

External Vehicle MPE Assessment @ 512 MHz									
Antenna Location	Antenna Model	Gain (dBi)	Meas. Distance (cm)	E/H Field	Calibration Factor	Average over Body (mW/cm <sup>2</sup> )	Initial Power (W)	Pwr. Density Calc. (mW/cm <sup>2</sup> )	Pwr. Density Max Calc. (mW/cm <sup>2</sup> )
Trunk (cnt)	HAE4004A	2.15	90	E	0.98	0.065	10.0	0.065	0.06
Measurement Grid									
Test Position	Height (cm)	% of Control Limit		Test Position	Height (cm)	% of Control Limit		IEEE Controlled Limit	IEEE Uncontrolled Limit
1	20	1.9%		6	120	5.5%		1.71	0.34
2	40	2.4%		7	140	5.7%			
3	60	3.3%		8	160	4.9%			
4	80	3.5%		9	180	3.8%			
5	100	4.2%		10	200	2.6%			
								RF Po (*Max)	10.0

**UHF Mobile M20QSS9PW1AN**

BS-Position 1

**Table 1**

External Vehicle MPE Assessment @ 380.0125 MHz									
Antenna Location	Antenna Model	Gain (dBi)	Meas. Distance (cm)	E/H Field	Calibration Factor	Average over Body (mW/cm <sup>2</sup> )	Initial Power (W)	Pwr. Density Calc. (mW/cm <sup>2</sup> )	Pwr. Density Max Calc. (mW/cm <sup>2</sup> )
Roof (cnt)	HAE6012A	2.15	90	E	1.40	0.083	47.3	0.041	0.04
Measurement Grid									
Test Position	Height (cm)	% of Control Limit		Test Position	Height (cm)	% of Control Limit		IEEE Controlled Limit	IEEE Uncontrolled Limit
1	20	1.7%		6	120	7.5%		1.27	0.25
2	40	2.2%		7	140	9.4%			
3	60	2.5%		8	160	9.4%			
4	80	4.9%		9	180	10.5%			
5	100	7.1%		10	200	10.1%			
								<b>RF Po (*Max)</b>	48.0

P-Position 1

**Table 2**

Internal Vehicle MPE Assessment @ 380.0125 MHz										
Antenna Location	Antenna Model	Gain (dBi)	Meas. Distance (cm)	E/H Field	Calibration Factor	Average over Head, Chest, Lower Trunk Back/Front seats (mW/cm <sup>2</sup> )		Initial Power (W)	Pwr. Density Calc. (mW/cm <sup>2</sup> )	Pwr. Density Max Calc. (mW/cm <sup>2</sup> )
						Back	Front			
Roof (cnt)	HAE6012A	2.15	Highest Reading	E	1.40	0.065	0.078	47.3	0.039	0.04
Measurement Grid										
Test Position		% of Control Limit Head		% of Control Limit Chest		% of Control Limit Lower Trunk		IEEE Controlled Limit:		1.27
Back Seat		8.1%		4.0%		3.4%		IEEE Uncontrolled Limit:		0.25
Front Seat		8.3%		5.7%		4.5%		<b>RF Po (*Max):</b>		48.0

BS-Position 1

**Table 3**

External Vehicle MPE Assessment @ 425.0125 MHz									
Antenna Location	Antenna Model	Gain (dBi)	Meas. Distance (cm)	E/H Field	Calibration Factor	Average over Body (mW/cm <sup>2</sup> )	Initial Power (W)	Pwr. Density Calc. (mW/cm <sup>2</sup> )	Pwr. Density Max Calc. (mW/cm <sup>2</sup> )
Roof (cnt)	HAE6012A	2.15	90	E	1.33	0.090	47.1	0.045	0.05
Measurement Grid									
Test Position	Height (cm)	% of Control Limit		Test Position	Height (cm)	% of Control Limit		IEEE Controlled Limit	IEEE Uncontrolled Limit
1	20	0.9%		6	120	6.5%		1.42	0.28
2	40	2.0%		7	140	10.4%			
3	60	2.0%		8	160	11.9%			
4	80	2.0%		9	180	11.6%			
5	100	4.0%		10	200	12.5%			
								<b>RF Po (*Max)</b>	48.0

**UHF Mobile M20QSS9PW1AN**

P-Position 1

**Table 4**

Internal Vehicle MPE Assessment @ 425.0125 MHz										
Antenna Location	Antenna	Gain (dBi)	Meas. Distance (cm)	E/H Field	Calibration Factor	Average over Head, Chest, Lower Trunk Back/Front seats (mW/cm <sup>2</sup> )		Initial Power (W)	Pwr. Density Calc. (mW/cm <sup>2</sup> )	Pwr. Density Max Calc. (mW/cm <sup>2</sup> )
						Back	Front			
Roof (cnt)	HAE6012A	2.15	Highest Reading	E	1.33	0.120	0.080	47.1	0.060	0.06
Measurement Grid										
Test Position		% of Control Limit Head		% of Control Limit Chest		% of Control Limit Lower Trunk		IEEE Controlled Limit:		1.42
Back Seat		13.2%		5.5%		6.8%		IEEE Uncontrolled Limit:		0.28
Front Seat		4.2%		4.5%		8.2%		RF Po (*Max):		48.0

BS-Position 1

**Table 5**

External Vehicle MPE Assessment @ 469.9875 MHz									
Antenna Location	Antenna Model	Gain (dBi)	Meas. Distance (cm)	E/H Field	Calibration Factor	Average over Body (mW/cm <sup>2</sup> )	Initial Power (W)	Pwr. Density Calc. (mW/cm <sup>2</sup> )	Pwr. Density Max Calc. (mW/cm <sup>2</sup> )
Roof (cnt)	HAE4003A	2.15	90	E	1.26	0.100	47.5	0.050	0.05
Measurement Grid									
Test Position	Height (cm)	% of Control Limit		Test Position	Height (cm)	% of Control Limit		IEEE Controlled Limit	IEEE Uncontrolled Limit
1	20	0.9%		6	120	5.1%		RF Po (*Max)	0.31
2	40	1.4%		7	140	8.8%			
3	60	2.3%		8	160	11.1%			
4	80	3.5%		9	180	13.0%			
5	100	5.0%		10	200	12.5%			48.0

P-Position 1

**Table 6**

Internal Vehicle MPE Assessment @ 469.9875 MHz										
Antenna Location	Antenna	Gain (dBi)	Meas. Distance (cm)	E/H Field	Calibration Factor	Average over Head, Chest, Lower Trunk Back/Front seats (mW/cm <sup>2</sup> )		Initial Power (W)	Pwr. Density Calc. (mW/cm <sup>2</sup> )	Pwr. Density Max Calc. (mW/cm <sup>2</sup> )
						Back	Front			
Roof (cnt)	HAE4003A	2.15	Highest Reading	E	1.26	0.083	0.074	47.5	0.041	0.04
Measurement Grid										
Test Position		% of Control Limit Head		% of Control Limit Chest		% of Control Limit Lower Trunk		IEEE Controlled Limit:		1.57
Back Seat		5.8%		5.8%		4.2%		IEEE Uncontrolled Limit:		0.31
Front Seat		3.0%		3.1%		8.1%		RF Po (*Max):		48.0

**UHF Mobile M20QSS9PW1AN**

BS-Position 1

**Table 7**

External Vehicle MPE Assessment @ 380.0125 MHz									
Antenna Location	Antenna Model	Gain (dBi)	Meas. Distance (cm)	E/H Field	Calibration Factor	Average over Body (mW/cm <sup>2</sup> )	Initial Power (W)	Pwr. Density Calc. (mW/cm <sup>2</sup> )	Pwr. Density Max Calc. (mW/cm <sup>2</sup> )
Roof (cnt)	HAE6013A	4.15	90	E	1.40	0.097	47.3	0.048	0.05
Measurement Grid									
Test Position	Height (cm)	% of Control Limit			Test Position	Height (cm)	% of Control Limit		
1	20	2.1%			6	120	8.1%		
2	40	3.3%			7	140	9.9%		
3	60	4.5%			8	160	10.4%		
4	80	5.7%			9	180	11.6%		
5	100	8.1%			10	200	12.8%		
								IEEE Controlled Limit	1.27
								IEEE Uncontrolled Limit	0.25
								<b>RF Po (*Max)</b>	48.0

P-Position 1

**Table 8**

Internal Vehicle MPE Assessment @ 380.0125 MHz										
Antenna Location	Antenna Model	Gain (dBi)	Meas. Distance (cm)	E/H Field	Calibration Factor	Average over Head, Chest, Lower Trunk, Back/Front seats (mW/cm <sup>2</sup> )		Initial Power (W)	Pwr. Density Calc. (mW/cm <sup>2</sup> )	Pwr. Density Max Calc. (mW/cm <sup>2</sup> )
						Back	Front			
Roof (cnt)	HAE6013A	4.15	Highest Reading	E	1.40	0.088	0.076	47.3	0.044	0.04
Measurement Grid										
Test Position		% of Control Limit Head		% of Control Limit Chest		% of Control Limit Lower Trunk		IEEE Controlled Limit:		1.27
Back Seat		7.7%		7.9%		5.2%		IEEE Uncontrolled Limit:		0.25
Front Seat		6.7%		5.6%		5.6%		<b>RF Po (*Max):</b>		48.0

BS-Position 1

**Table 9**

External Vehicle MPE Assessment @ 425.0125 MHz									
Antenna Location	Antenna Model	Gain (dBi)	Meas. Distance (cm)	E/H Field	Calibration Factor	Average over Body (mW/cm <sup>2</sup> )	Initial Power (W)	Pwr. Density Calc. (mW/cm <sup>2</sup> )	Pwr. Density Max Calc. (mW/cm <sup>2</sup> )
Roof (cnt)	HAE6013A	4.15	90	E	1.33	0.113	47.1	0.057	0.06
Measurement Grid									
Test Position	Height (cm)	% of Control Limit			Test Position	Height (cm)	% of Control Limit		
1	20	1.6%			6	120	8.0%		
2	40	1.7%			7	140	12.1%		
3	60	2.3%			8	160	13.7%		
4	80	4.7%			9	180	14.3%		
5	100	7.3%			10	200	14.2%		
								IEEE Controlled Limit	1.42
								IEEE Uncontrolled Limit	0.28
								<b>RF Po (*Max)</b>	48.0



**UHF Mobile M20QSS9PW1AN**

P-Position 1

**Table 10**

Internal Vehicle MPE Assessment @ 425.0125 MHz										
Antenna Location	Antenna	Gain (dBi)	Meas. Distance (cm)	E/H Field	Calibration Factor	Average over Head, Chest, Lower Trunk Back/Front seats (mW/cm <sup>2</sup> )		Initial Power (W)	Pwr. Density Calc. (mW/cm <sup>2</sup> )	Pwr. Density Max Calc. (mW/cm <sup>2</sup> )
						Back	Front			
Roof (cnt)	HAE6013A	4.15	Highest Reading	E	1.33	0.142	0.089	47.1	0.071	0.07
Measurement Grid										
Test Position		% of Control Limit Head		% of Control Limit Chest		% of Control Limit Lower Trunk		IEEE Controlled Limit:		1.42
Back Seat		13.3%		6.8%		10.0%		IEEE Uncontrolled Limit:		0.28
Front Seat		6.6%		5.1%		7.2%			<b>RF Po (*Max):</b>	48.0

BS-Position 1

**Table 11**

External Vehicle MPE Assessment @ 469.9875 MHz									
Antenna Location	Antenna Model	Gain (dBi)	Meas. Distance (cm)	E/H Field	Calibration Factor	Average over Body (mW/cm <sup>2</sup> )	Initial Power (W)	Pwr. Density Calc. (mW/cm <sup>2</sup> )	Pwr. Density Max Calc. (mW/cm <sup>2</sup> )
Measurement Grid									
Test Position	Height (cm)	% of Control Limit		Test Position	Height (cm)	% of Control Limit		IEEE Controlled Limit	IEEE Uncontrolled Limit
1	20	1.0%		6	120	6.0%		1.57	0.31
2	40	1.1%		7	140	9.4%			
3	60	2.9%		8	160	11.5%			
4	80	4.6%		9	180	13.0%			
5	100	5.8%		10	200	13.1%			
								<b>RF Po (*Max)</b>	48.0

P-Position 1

**Table 12**

Internal Vehicle MPE Assessment @ 469.9875 MHz										
Antenna Location	Antenna	Gain (dBi)	Meas. Distance (cm)	E/H Field	Calibration Factor	Average over Head, Chest, Lower Trunk Back/Front seats (mW/cm <sup>2</sup> )		Initial Power (W)	Pwr. Density Calc. (mW/cm <sup>2</sup> )	Pwr. Density Max Calc. (mW/cm <sup>2</sup> )
						Back	Front			
Roof (cnt)	HAE6013A	4.15	Highest Reading	E	1.26	0.073	0.079	47.5	0.040	0.04
Measurement Grid										
Test Position		% of Control Limit Head		% of Control Limit Chest		% of Control Limit Lower Trunk		IEEE Controlled Limit:		1.57
Back Seat		5.6%		5.8%		2.6%		IEEE Uncontrolled Limit:		0.31
Front Seat		2.4%		3.7%		9.1%			<b>RF Po (*Max):</b>	48.0

**UHF Mobile M20QSS9PW1AN**

BS-Position 1

**Table 13**

External Vehicle MPE Assessment @ 460.0125 MHz									
Antenna Location	Antenna Model	Gain (dBi)	Meas. Distance (cm)	E/H Field	Calibration Factor	Average over Body (mW/cm <sup>2</sup> )	Initial Power (W)	Pwr. Density Calc. (mW/cm <sup>2</sup> )	Pwr. Density Max Calc. (mW/cm <sup>2</sup> )
Roof (cnt)	HAE4011A	5.65	90	E	1.28	0.092	47.2	0.046	0.05
Measurement Grid									
Test Position	Height (cm)	% of Control Limit		Test Position	Height (cm)	% of Control Limit		IEEE Controlled Limit	IEEE Uncontrolled Limit
1	20	0.7%		6	120	4.8%		1.53	0.31
2	40	0.9%		7	140	8.4%			
3	60	1.0%		8	160	11.6%			
4	80	1.9%		9	180	14.2%			
5	100	3.5%		10	200	13.3%			
								<b>RF Po (*Max)</b>	48.0

P-Position 1

**Table 14**

Internal Vehicle MPE Assessment @ 460.0125 MHz										
Antenna Location	Antenna Model	Gain (dBi)	Meas. Distance (cm)	E/H Field	Calibration Factor	Average over Head, Chest, Lower Trunk Back/Front seats (mW/cm <sup>2</sup> )		Initial Power (W)	Pwr. Density Calc. (mW/cm <sup>2</sup> )	Pwr. Density Max Calc. (mW/cm <sup>2</sup> )
						Back	Front			
Roof (cnt)	HAE4011A	5.65	Highest Reading	E	1.28	0.022	0.027	47.2	0.014	0.01
Measurement Grid										
Test Position		% of Control Limit Head		% of Control Limit Chest		% of Control Limit Lower Trunk		IEEE Controlled Limit:		1.53
Back Seat		1.1%		1.4%		1.8%		IEEE Uncontrolled Limit:		0.31
Front Seat		1.1%		1.7%		2.5%		<b>RF Po (*Max):</b>		48.0

BS-Position 2

**Table 15**

External Vehicle MPE Assessment @ 380.0125 MHz									
Antenna Location	Antenna Model	Gain (dBi)	Meas. Distance (cm)	E/H Field	Calibration Factor	Average over Body (mW/cm <sup>2</sup> )	Initial Power (W)	Pwr. Density Calc. (mW/cm <sup>2</sup> )	Pwr. Density Max Calc. (mW/cm <sup>2</sup> )
Roof (cnt)	HAE6012A	2.15	90	E	1.40	0.073	47.3	0.036	0.04
Measurement Grid									
Test Position	Height (cm)	% of Control Limit		Test Position	Height (cm)	% of Control Limit		IEEE Controlled Limit	IEEE Uncontrolled Limit
1	20	2.0%		6	120	6.6%		1.27	0.25
2	40	3.2%		7	140	7.0%			
3	60	3.4%		8	160	8.0%			
4	80	5.5%		9	180	8.2%			
5	100	6.4%		10	200	7.2%			
								<b>RF Po (*Max)</b>	48.0

**UHF Mobile M20QSS9PW1AN**

BS-Position 2

**Table 16**

External Vehicle MPE Assessment @ 425.0125 MHz									
Antenna Location	Antenna Model	Gain (dBi)	Meas. Distance (cm)	E/H Field	Calibration Factor	Average over Body (mW/cm <sup>2</sup> )	Initial Power (W)	Pwr. Density Calc. (mW/cm <sup>2</sup> )	Pwr. Density Max Calc. (mW/cm <sup>2</sup> )
Roof (cnt)	HAE6012A	2.15	90	E	1.33	0.069	47.1	0.035	0.04
Measurement Grid									
Test Position	Height (cm)	% of Control Limit		Test Position	Height (cm)	% of Control Limit		IEEE Controlled Limit	IEEE Uncontrolled Limit
1	20	2.0%		6	120	5.4%		1.42	0.28
2	40	2.1%		7	140	6.5%			
3	60	2.5%		8	160	6.9%			
4	80	4.0%		9	180	8.2%			
5	100	5.3%		10	200	6.0%			

BS-Position 2

**Table 17**

External Vehicle MPE Assessment @ 469.9875 MHz									
Antenna Location	Antenna Model	Gain (dBi)	Meas. Distance (cm)	E/H Field	Calibration Factor	Average over Body (mW/cm <sup>2</sup> )	Initial Power (W)	Pwr. Density Calc. (mW/cm <sup>2</sup> )	Pwr. Density Max Calc. (mW/cm <sup>2</sup> )
Roof (cnt)	HAE4003A	2.15	90	E	1.26	0.065	47.5	0.033	0.03
Measurement Grid									
Test Position	Height (cm)	% of Control Limit		Test Position	Height (cm)	% of Control Limit		IEEE Controlled Limit	IEEE Uncontrolled Limit
1	20	2.0%		6	120	4.6%		1.57	0.31
2	40	2.3%		7	140	5.3%			
3	60	2.6%		8	160	5.9%			
4	80	2.9%		9	180	6.2%			
5	100	3.0%		10	200	7.0%			

BS-Position 2

**Table 18**

External Vehicle MPE Assessment @ 380.0125 MHz									
Antenna Location	Antenna Model	Gain (dBi)	Meas. Distance (cm)	E/H Field	Calibration Factor	Average over Body (mW/cm <sup>2</sup> )	Initial Power (W)	Pwr. Density Calc. (mW/cm <sup>2</sup> )	Pwr. Density Max Calc. (mW/cm <sup>2</sup> )
Roof (cnt)	HAE6013A	4.15	90	E	1.40	0.078	47.3	0.039	0.04
Measurement Grid									
Test Position	Height (cm)	% of Control Limit		Test Position	Height (cm)	% of Control Limit		IEEE Controlled Limit	IEEE Uncontrolled Limit
1	20	2.2%		6	120	7.1%		1.27	0.25
2	40	3.4%		7	140	9.2%			
3	60	3.7%		8	160	8.4%			
4	80	4.1%		9	180	8.7%			
5	100	6.8%		10	200	7.7%			

**UHF Mobile M20QSS9PW1AN**

BS-Position 2

**Table 19**

External Vehicle MPE Assessment @ 425.0125 MHz									
Antenna Location	Antenna Model	Gain (dBi)	Meas. Distance (cm)	E/H Field	Calibration Factor	Average over Body (mW/cm <sup>2</sup> )	Initial Power (W)	Pwr. Density Calc. (mW/cm <sup>2</sup> )	Pwr. Density Max Calc. (mW/cm <sup>2</sup> )
Roof (cnt)	HAE6013A	4.15	90	E	1.33	0.077	47.1	0.039	0.04
Measurement Grid									
Test Position	Height (cm)	% of Control Limit		Test Position	Height (cm)	% of Control Limit		IEEE Controlled Limit	IEEE Uncontrolled Limit
1	20	2.4%		6	120	6.5%		1.42	0.28
2	40	3.5%		7	140	7.4%			
3	60	3.7%		8	160	7.9%			
4	80	3.8%		9	180	7.8%			
5	100	4.9%		10	200	6.8%			
								<b>RF Po (*Max)</b>	48.0

BS-Position 2

**Table 20**

External Vehicle MPE Assessment @ 469.9875 MHz									
Antenna Location	Antenna Model	Gain (dBi)	Meas. Distance (cm)	E/H Field	Calibration Factor	Average over Body (mW/cm <sup>2</sup> )	Initial Power (W)	Pwr. Density Calc. (mW/cm <sup>2</sup> )	Pwr. Density Max Calc. (mW/cm <sup>2</sup> )
Roof (cnt)	HAE6013A	4.15	90	E	1.26	0.076	47.5	0.038	0.04
Measurement Grid									
Test Position	Height (cm)	% of Control Limit		Test Position	Height (cm)	% of Control Limit		IEEE Controlled Limit	IEEE Uncontrolled Limit
1	20	2.2%		6	120	5.7%		1.57	0.31
2	40	2.5%		7	140	6.3%			
3	60	2.7%		8	160	6.6%			
4	80	3.6%		9	180	7.2%			
5	100	3.7%		10	200	7.7%			
								<b>RF Po (*Max)</b>	48.0

BS-Position 2

**Table 21**

External Vehicle MPE Assessment @ 460.0125 MHz									
Antenna Location	Antenna Model	Gain (dBi)	Meas. Distance (cm)	E/H Field	Calibration Factor	Average over Body (mW/cm <sup>2</sup> )	Initial Power (W)	Pwr. Density Calc. (mW/cm <sup>2</sup> )	Pwr. Density Max Calc. (mW/cm <sup>2</sup> )
Roof (cnt)	HAE4011A	5.65	90	E	1.28	0.073	47.2	0.036	0.04
Measurement Grid									
Test Position	Height (cm)	% of Control Limit		Test Position	Height (cm)	% of Control Limit		IEEE Controlled Limit	IEEE Uncontrolled Limit
1	20	1.3%		6	120	3.5%		1.53	0.31
2	40	1.4%		7	140	6.7%			
3	60	1.8%		8	160	8.8%			
4	80	2.5%		9	180	9.5%			
5	100	2.8%		10	200	9.2%			
								<b>RF Po (*Max)</b>	48.0

**UHF Mobile M20QSS9PW1AN**

BS-Position 3

**Table 22**

External Vehicle MPE Assessment @ 380.0125 MHz									
Antenna Location	Antenna Model	Gain (dBi)	Meas. Distance (cm)	E/H Field	Calibration Factor	Average over Body (mW/cm <sup>2</sup> )	Initial Power (W)	Pwr. Density Calc. (mW/cm <sup>2</sup> )	Pwr. Density Max Calc. (mW/cm <sup>2</sup> )
Roof (cnt)	HAE6012A	2.15	90	E	1.40	0.059	47.3	0.029	0.03
Measurement Grid									
Test Position	Height (cm)	% of Control Limit		Test Position	Height (cm)	% of Control Limit		IEEE Controlled Limit	IEEE Uncontrolled Limit
1	20	2.7%		6	120	4.5%		1.27	0.25
2	40	2.7%		7	140	5.1%			
3	60	3.2%		8	160	6.6%			
4	80	3.3%		9	180	6.9%			
5	100	4.3%		10	200	7.1%			

BS-Position 3

**Table 23**

External Vehicle MPE Assessment @ 425.0125 MHz									
Antenna Location	Antenna Model	Gain (dBi)	Meas. Distance (cm)	E/H Field	Calibration Factor	Average over Body (mW/cm <sup>2</sup> )	Initial Power (W)	Pwr. Density Calc. (mW/cm <sup>2</sup> )	Pwr. Density Max Calc. (mW/cm <sup>2</sup> )
Roof (cnt)	HAE6012A	2.15	90	E	1.33	0.067	47.1	0.034	0.03
Measurement Grid									
Test Position	Height (cm)	% of Control Limit		Test Position	Height (cm)	% of Control Limit		IEEE Controlled Limit	IEEE Uncontrolled Limit
1	20	1.9%		6	120	6.0%		1.42	0.28
2	40	2.8%		7	140	6.4%			
3	60	3.4%		8	160	5.8%			
4	80	4.8%		9	180	5.8%			
5	100	5.4%		10	200	5.3%			

BS-Position 3

**Table 24**

External Vehicle MPE Assessment @ 469.9875 MHz									
Antenna Location	Antenna Model	Gain (dBi)	Meas. Distance (cm)	E/H Field	Calibration Factor	Average over Body (mW/cm <sup>2</sup> )	Initial Power (W)	Pwr. Density Calc. (mW/cm <sup>2</sup> )	Pwr. Density Max Calc. (mW/cm <sup>2</sup> )
Roof (cnt)	HAE4003A	2.15	90	E	1.26	0.072	47.5	0.036	0.04
Measurement Grid									
Test Position	Height (cm)	% of Control Limit		Test Position	Height (cm)	% of Control Limit		IEEE Controlled Limit	IEEE Uncontrolled Limit
1	20	2.2%		6	120	4.6%		1.57	0.31
2	40	2.4%		7	140	5.3%			
3	60	3.6%		8	160	6.3%			
4	80	4.5%		9	180	6.9%			
5	100	4.5%		10	200	5.9%			

**UHF Mobile M20QSS9PW1AN**

BS-Position 3

**Table 25**

External Vehicle MPE Assessment @ 380.0125 MHz									
Antenna Location	Antenna Model	Gain (dBi)	Meas. Distance (cm)	E/H Field	Calibration Factor	Average over Body (mW/cm <sup>2</sup> )	Initial Power (W)	Pwr. Density Calc. (mW/cm <sup>2</sup> )	Pwr. Density Max Calc. (mW/cm <sup>2</sup> )
Roof (cnt)	HAE6013A	4.15	90	E	1.40	0.071	47.3	0.035	0.04
Measurement Grid									
Test Position	Height (cm)	% of Control Limit		Test Position	Height (cm)	% of Control Limit		IEEE Controlled Limit	IEEE Uncontrolled Limit
1	20	2.5%		6	120	6.4%		1.27	0.25
2	40	3.2%		7	140	6.8%			
3	60	4.1%		8	160	7.1%			
4	80	4.2%		9	180	8.1%			
5	100	5.4%		10	200	8.0%			

BS-Position 3

**Table 26**

External Vehicle MPE Assessment @ 425.0125 MHz									
Antenna Location	Antenna Model	Gain (dBi)	Meas. Distance (cm)	E/H Field	Calibration Factor	Average over Body (mW/cm <sup>2</sup> )	Initial Power (W)	Pwr. Density Calc. (mW/cm <sup>2</sup> )	Pwr. Density Max Calc. (mW/cm <sup>2</sup> )
Roof (cnt)	HAE6013A	4.15	90	E	1.33	0.083	47.1	0.041	0.04
Measurement Grid									
Test Position	Height (cm)	% of Control Limit		Test Position	Height (cm)	% of Control Limit		IEEE Controlled Limit	IEEE Uncontrolled Limit
1	20	3.0%		6	120	6.4%		1.42	0.28
2	40	3.0%		7	140	7.1%			
3	60	4.4%		8	160	7.5%			
4	80	5.5%		9	180	7.1%			
5	100	7.7%		10	200	6.8%			

BS-Position 3

**Table 27**

External Vehicle MPE Assessment @ 469.9875 MHz									
Antenna Location	Antenna Model	Gain (dBi)	Meas. Distance (cm)	E/H Field	Calibration Factor	Average over Body (mW/cm <sup>2</sup> )	Initial Power (W)	Pwr. Density Calc. (mW/cm <sup>2</sup> )	Pwr. Density Max Calc. (mW/cm <sup>2</sup> )
Roof (cnt)	HAE6013A	4.15	90	E	1.26	0.060	47.5	0.030	0.03
Measurement Grid									
Test Position	Height (cm)	% of Control Limit		Test Position	Height (cm)	% of Control Limit		IEEE Controlled Limit	IEEE Uncontrolled Limit
1	20	1.5%		6	120	3.9%		1.57	0.31
2	40	2.6%		7	140	4.1%			
3	60	2.6%		8	160	4.4%			
4	80	3.8%		9	180	5.4%			
5	100	4.4%		10	200	5.4%			

**UHF Mobile M20QSS9PW1AN**

BS-Position 3

**Table 28**

External Vehicle MPE Assessment @ 460.0125 MHz									
Antenna Location	Antenna Model	Gain (dBi)	Meas. Distance (cm)	E/H Field	Calibration Factor	Average over Body (mW/cm <sup>2</sup> )	Initial Power (W)	Pwr. Density Calc. (mW/cm <sup>2</sup> )	Pwr. Density Max Calc. (mW/cm <sup>2</sup> )
Roof (cnt)	HAE4011A	5.65	90	E	1.28	0.054	47.2	0.027	0.03
Measurement Grid									
Test Position	Height (cm)	% of Control Limit		Test Position	Height (cm)	% of Control Limit		IEEE Controlled Limit	IEEE Uncontrolled Limit
1	20	0.9%		6	120	3.6%		1.53	0.31
2	40	1.1%		7	140	4.2%			
3	60	1.4%		8	160	5.7%			
4	80	2.9%		9	180	6.0%			
5	100	3.1%		10	200	6.0%			
								<b>RF Po (*Max)</b>	48.0

BS-Position 4

**Table 29**

External Vehicle MPE Assessment @ 380.0125 MHz									
Antenna Location	Antenna Model	Gain (dBi)	Meas. Distance (cm)	E/H Field	Calibration Factor	Average over Body (mW/cm <sup>2</sup> )	Initial Power (W)	Pwr. Density Calc. (mW/cm <sup>2</sup> )	Pwr. Density Max Calc. (mW/cm <sup>2</sup> )
Roof (cnt)	HAE6012A	2.15	90	E	1.40	0.033	47.3	0.017	0.02
Measurement Grid									
Test Position	Height (cm)	% of Control Limit		Test Position	Height (cm)	% of Control Limit		IEEE Controlled Limit	IEEE Uncontrolled Limit
1	20	1.3%		6	120	3.5%		1.27	0.25
2	40	1.6%		7	140	3.2%			
3	60	1.8%		8	160	2.5%			
4	80	2.6%		9	180	2.7%			
5	100	4.0%		10	200	3.2%			
								<b>RF Po (*Max)</b>	48.0

BS-Position 4

**Table 30**

External Vehicle MPE Assessment @ 425.0125 MHz									
Antenna Location	Antenna Model	Gain (dBi)	Meas. Distance (cm)	E/H Field	Calibration Factor	Average over Body (mW/cm <sup>2</sup> )	Initial Power (W)	Pwr. Density Calc. (mW/cm <sup>2</sup> )	Pwr. Density Max Calc. (mW/cm <sup>2</sup> )
Roof (cnt)	HAE6012A	2.15	90	E	1.33	0.038	47.1	0.019	0.02
Measurement Grid									
Test Position	Height (cm)	% of Control Limit		Test Position	Height (cm)	% of Control Limit		IEEE Controlled Limit	IEEE Uncontrolled Limit
1	20	1.8%		6	120	2.8%		1.42	0.28
2	40	1.7%		7	140	2.6%			
3	60	2.3%		8	160	3.1%			
4	80	2.5%		9	180	2.8%			
5	100	3.5%		10	200	3.9%			
								<b>RF Po (*Max)</b>	48.0

**UHF Mobile M20QSS9PW1AN**

BS-Position 4

**Table 31**

External Vehicle MPE Assessment @ 469.9875 MHz									
Antenna Location	Antenna Model	Gain (dBi)	Meas. Distance (cm)	E/H Field	Calibration Factor	Average over Body (mW/cm <sup>2</sup> )	Initial Power (W)	Pwr. Density Calc. (mW/cm <sup>2</sup> )	Pwr. Density Max Calc. (mW/cm <sup>2</sup> )
Roof (cnt)	HAE4003A	2.15	90	E	1.26	0.036	47.5	0.018	0.02
Measurement Grid									
Test Position	Height (cm)	% of Control Limit		Test Position	Height (cm)	% of Control Limit		IEEE Controlled Limit	IEEE Uncontrolled Limit
1	20	1.3%		6	120	3.2%		1.57	0.31
2	40	1.2%		7	140	2.1%			
3	60	1.6%		8	160	2.4%			
4	80	2.6%		9	180	2.6%			
5	100	2.5%		10	200	3.3%			
								<b>RF Po (*Max)</b>	
								48.0	

BS-Position 4

**Table 32**

External Vehicle MPE Assessment @ 380.0125 MHz									
Antenna Location	Antenna Model	Gain (dBi)	Meas. Distance (cm)	E/H Field	Calibration Factor	Average over Body (mW/cm <sup>2</sup> )	Initial Power (W)	Pwr. Density Calc. (mW/cm <sup>2</sup> )	Pwr. Density Max Calc. (mW/cm <sup>2</sup> )
Roof (cnt)	HAE6013A	4.15	90	E	1.40	0.037	47.3	0.018	0.02
Measurement Grid									
Test Position	Height (cm)	% of Control Limit		Test Position	Height (cm)	% of Control Limit		IEEE Controlled Limit	IEEE Uncontrolled Limit
1	20	1.3%		6	120	3.5%		1.27	0.25
2	40	2.1%		7	140	3.4%			
3	60	2.9%		8	160	3.0%			
4	80	3.6%		9	180	2.3%			
5	100	4.2%		10	200	2.7%			
								<b>RF Po (*Max)</b>	
								48.0	

BS-Position 4

**Table 33**

External Vehicle MPE Assessment @ 425.0125 MHz									
Antenna Location	Antenna Model	Gain (dBi)	Meas. Distance (cm)	E/H Field	Calibration Factor	Average over Body (mW/cm <sup>2</sup> )	Initial Power (W)	Pwr. Density Calc. (mW/cm <sup>2</sup> )	Pwr. Density Max Calc. (mW/cm <sup>2</sup> )
Roof (cnt)	HAE6013A	4.15	90	E	1.33	0.048	47.1	0.024	0.02
Measurement Grid									
Test Position	Height (cm)	% of Control Limit		Test Position	Height (cm)	% of Control Limit		IEEE Controlled Limit	IEEE Uncontrolled Limit
1	20	1.7%		6	120	3.3%		1.42	0.28
2	40	2.2%		7	140	3.9%			
3	60	2.4%		8	160	4.0%			
4	80	2.8%		9	180	3.8%			
5	100	4.9%		10	200	4.6%			
								<b>RF Po (*Max)</b>	
								48.0	



**UHF Mobile M20QSS9PW1AN**

BS-Position 4

**Table 34**

External Vehicle MPE Assessment @ 469.9875 MHz									
Antenna Location	Antenna Model	Gain (dBi)	Meas. Distance (cm)	E/H Field	Calibration Factor	Average over Body (mW/cm <sup>2</sup> )	Initial Power (W)	Pwr. Density Calc. (mW/cm <sup>2</sup> )	Pwr. Density Max Calc. (mW/cm <sup>2</sup> )
Roof (cnt)	HAE6013A	4.15	90	E	1.26	0.040	47.5	0.020	0.02
Measurement Grid									
Test Position	Height (cm)	% of Control Limit		Test Position	Height (cm)	% of Control Limit		IEEE Controlled Limit	IEEE Uncontrolled Limit
1	20	1.1%		6	120	2.7%		1.57	0.31
2	40	1.4%		7	140	3.3%			
3	60	1.8%		8	160	3.1%			
4	80	2.4%		9	180	3.4%			
5	100	2.2%		10	200	4.1%			
								<b>RF Po (*Max)</b>	
								48.0	

BS-Position 4

**Table 35**

External Vehicle MPE Assessment @ 460.0125 MHz									
Antenna Location	Antenna Model	Gain (dBi)	Meas. Distance (cm)	E/H Field	Calibration Factor	Average over Body (mW/cm <sup>2</sup> )	Initial Power (W)	Pwr. Density Calc. (mW/cm <sup>2</sup> )	Pwr. Density Max Calc. (mW/cm <sup>2</sup> )
Roof (cnt)	HAE4011A	5.65	90	E	1.28	0.042	47.2	0.021	0.02
Measurement Grid									
Test Position	Height (cm)	% of Control Limit		Test Position	Height (cm)	% of Control Limit		IEEE Controlled Limit	IEEE Uncontrolled Limit
1	20	1.0%		6	120	3.2%		1.53	0.31
2	40	1.2%		7	140	3.0%			
3	60	1.3%		8	160	3.4%			
4	80	1.9%		9	180	4.0%			
5	100	3.2%		10	200	5.5%			
								<b>RF Po (*Max)</b>	
								48.0	

BS-Position 5

**Table 36**

External Vehicle MPE Assessment @ 380.0125 MHz									
Antenna Location	Antenna Model	Gain (dBi)	Meas. Distance (cm)	E/H Field	Calibration Factor	Average over Body (mW/cm <sup>2</sup> )	Initial Power (W)	Pwr. Density Calc. (mW/cm <sup>2</sup> )	Pwr. Density Max Calc. (mW/cm <sup>2</sup> )
Roof (cnt)	HAE6012A	2.15	90	E	1.40	0.023	47.3	0.011	0.01
Measurement Grid									
Test Position	Height (cm)	% of Control Limit		Test Position	Height (cm)	% of Control Limit		IEEE Controlled Limit	IEEE Uncontrolled Limit
1	20	0.4%		6	120	1.3%		1.27	0.25
2	40	0.4%		7	140	2.6%			
3	60	0.6%		8	160	3.3%			
4	80	0.8%		9	180	4.0%			
5	100	1.2%		10	200	3.4%			
								<b>RF Po (*Max)</b>	
								48.0	

**UHF Mobile M20QSS9PW1AN**

BS-Position 5

**Table 37**

External Vehicle MPE Assessment @ 425.0125 MHz									
Antenna Location	Antenna Model	Gain (dBi)	Meas. Distance (cm)	E/H Field	Calibration Factor	Average over Body (mW/cm <sup>2</sup> )	Initial Power (W)	Pwr. Density Calc. (mW/cm <sup>2</sup> )	Pwr. Density Max Calc. (mW/cm <sup>2</sup> )
Roof (cnt)	HAE6012A	2.15	90	E	1.33	0.021	47.1	0.011	0.01
Measurement Grid									
Test Position	Height (cm)	% of Control Limit		Test Position	Height (cm)	% of Control Limit		IEEE Controlled Limit	IEEE Uncontrolled Limit
1	20	1.0%		6	120	2.0%		1.42	0.28
2	40	0.6%		7	140	1.4%			
3	60	0.9%		8	160	1.6%			
4	80	1.0%		9	180	1.9%			
5	100	2.1%		10	200	2.5%			
								<b>RF Po (*Max)</b>	48.0

BS-Position 5

**Table 38**

External Vehicle MPE Assessment @ 469.9875 MHz									
Antenna Location	Antenna Model	Gain (dBi)	Meas. Distance (cm)	E/H Field	Calibration Factor	Average over Body (mW/cm <sup>2</sup> )	Initial Power (W)	Pwr. Density Calc. (mW/cm <sup>2</sup> )	Pwr. Density Max Calc. (mW/cm <sup>2</sup> )
Roof (cnt)	HAE4003A	2.15	90	E	1.26	0.023	47.5	0.012	0.01
Measurement Grid									
Test Position	Height (cm)	% of Control Limit		Test Position	Height (cm)	% of Control Limit		IEEE Controlled Limit	IEEE Uncontrolled Limit
1	20	0.9%		6	120	1.5%		1.57	0.31
2	40	0.6%		7	140	2.0%			
3	60	0.8%		8	160	2.2%			
4	80	0.8%		9	180	2.1%			
5	100	1.3%		10	200	2.8%			
								<b>RF Po (*Max)</b>	48.0

BS-Position 5

**Table 39**

External Vehicle MPE Assessment @ 380.0125 MHz									
Antenna Location	Antenna Model	Gain (dBi)	Meas. Distance (cm)	E/H Field	Calibration Factor	Average over Body (mW/cm <sup>2</sup> )	Initial Power (W)	Pwr. Density Calc. (mW/cm <sup>2</sup> )	Pwr. Density Max Calc. (mW/cm <sup>2</sup> )
Roof (cnt)	HAE6013A	4.15	90	E	1.40	0.030	47.3	0.015	0.02
Measurement Grid									
Test Position	Height (cm)	% of Control Limit		Test Position	Height (cm)	% of Control Limit		IEEE Controlled Limit	IEEE Uncontrolled Limit
1	20	1.2%		6	120	2.4%		1.27	0.25
2	40	0.7%		7	140	2.9%			
3	60	1.3%		8	160	3.7%			
4	80	1.7%		9	180	3.7%			
5	100	2.1%		10	200	4.3%			
								<b>RF Po (*Max)</b>	48.0

**UHF Mobile M20QSS9PW1AN**

BS-Position 5

**Table 40**

External Vehicle MPE Assessment @ 425.0125 MHz									
Antenna Location	Antenna Model	Gain (dBi)	Meas. Distance (cm)	E/H Field	Calibration Factor	Average over Body (mW/cm <sup>2</sup> )	Initial Power (W)	Pwr. Density Calc. (mW/cm <sup>2</sup> )	Pwr. Density Max Calc. (mW/cm <sup>2</sup> )
Roof (cnt)	HAE6013A	4.15	90	E	1.33	0.024	47.1	0.012	0.01
Measurement Grid									
Test Position	Height (cm)	% of Control Limit		Test Position	Height (cm)	% of Control Limit		IEEE Controlled Limit	IEEE Uncontrolled Limit
1	20	0.8%		6	120	1.9%		1.42	0.28
2	40	0.8%		7	140	1.9%			
3	60	1.0%		8	160	2.1%			
4	80	0.9%		9	180	2.1%			
5	100	2.1%		10	200	3.2%			
								<b>RF Po (*Max)</b>	48.0

BS-Position 5

**Table 41**

External Vehicle MPE Assessment @ 469.9875 MHz									
Antenna Location	Antenna Model	Gain (dBi)	Meas. Distance (cm)	E/H Field	Calibration Factor	Average over Body (mW/cm <sup>2</sup> )	Initial Power (W)	Pwr. Density Calc. (mW/cm <sup>2</sup> )	Pwr. Density Max Calc. (mW/cm <sup>2</sup> )
Roof (cnt)	HAE6013A	4.15	90	E	1.26	0.027	47.5	0.014	0.01
Measurement Grid									
Test Position	Height (cm)	% of Control Limit		Test Position	Height (cm)	% of Control Limit		IEEE Controlled Limit	IEEE Uncontrolled Limit
1	20	0.7%		6	120	1.9%		1.57	0.31
2	40	0.6%		7	140	2.5%			
3	60	0.8%		8	160	2.6%			
4	80	1.3%		9	180	2.2%			
5	100	1.4%		10	200	3.3%			
								<b>RF Po (*Max)</b>	48.0

BS-Position 5

**Table 42**

External Vehicle MPE Assessment @ 460.0125 MHz									
Antenna Location	Antenna Model	Gain (dBi)	Meas. Distance (cm)	E/H Field	Calibration Factor	Average over Body (mW/cm <sup>2</sup> )	Initial Power (W)	Pwr. Density Calc. (mW/cm <sup>2</sup> )	Pwr. Density Max Calc. (mW/cm <sup>2</sup> )
Roof (cnt)	HAE4011A	5.65	90	E	1.28	0.029	47.2	0.015	0.01
Measurement Grid									
Test Position	Height (cm)	% of Control Limit		Test Position	Height (cm)	% of Control Limit		IEEE Controlled Limit	IEEE Uncontrolled Limit
1	20	0.7%		6	120	2.4%		1.53	0.31
2	40	0.6%		7	140	2.8%			
3	60	0.7%		8	160	2.7%			
4	80	0.8%		9	180	3.3%			
5	100	1.2%		10	200	3.9%			
								<b>RF Po (*Max)</b>	48.0

**UHF Mobile M20QTS9PW1AN**

BS-Position 1

**Table 1**

External Vehicle MPE Assessment @ 380.0125 MHz									
Antenna Location	Antenna Model	Gain (dBi)	Meas. Distance (cm)	E/H Field	Calibration Factor	Average over Body (mW/cm <sup>2</sup> )	Initial Power (W)	Pwr. Density Calc. (mW/cm <sup>2</sup> )	Pwr. Density Max Calc. (mW/cm <sup>2</sup> )
Roof (cnt)	HAE6012A	2.15	90	E	1.40	0.198	117.0	0.099	0.10
Measurement Grid									
Test Position	Height (cm)	% of Control Limit		Test Position	Height (cm)	% of Control Limit		IEEE Controlled Limit	IEEE Uncontrolled Limit
1	20	3.4%		6	120	17.2%		1.27	0.25
2	40	4.6%		7	140	21.5%			
3	60	7.8%		8	160	23.5%			
4	80	11.7%		9	180	25.3%			
5	100	14.5%		10	200	27.0%			
								<b>RF Po (*Max)</b>	120.0

P-Position 1

**Table 2**

Internal Vehicle MPE Assessment @ 380.0125 MHz										
Antenna Location	Antenna Model	Gain (dBi)	Meas. Distance (cm)	E/H Field	Calibration Factor	Average over Head, Chest, Lower Trunk Back/Front seats (mW/cm <sup>2</sup> )		Initial Power (W)	Pwr. Density Calc. (mW/cm <sup>2</sup> )	Pwr. Density Max Calc. (mW/cm <sup>2</sup> )
						Back	Front			
Roof (cnt)	HAE6012A	2.15	Highest Reading	E	1.40	0.201	0.175	117.0	0.101	0.10
Measurement Grid										
Test Position		% of Control Limit Head		% of Control Limit Chest		% of Control Limit Lower Trunk		IEEE Controlled Limit:		1.27
Back Seat		19.7%		15.9%		12.1%		IEEE Uncontrolled Limit:		0.25
Front Seat		15.2%		11.4%		14.9%		<b>RF Po (*Max):</b>		120.0

BS-Position 1

**Table 3**

External Vehicle MPE Assessment @ 425.0125 MHz									
Antenna Location	Antenna Model	Gain (dBi)	Meas. Distance (cm)	E/H Field	Calibration Factor	Average over Body (mW/cm <sup>2</sup> )	Initial Power (W)	Pwr. Density Calc. (mW/cm <sup>2</sup> )	Pwr. Density Max Calc. (mW/cm <sup>2</sup> )
Roof (cnt)	HAE6012A	2.15	90	E	1.33	0.177	119.0	0.089	0.09
Measurement Grid									
Test Position	Height (cm)	% of Control Limit		Test Position	Height (cm)	% of Control Limit		IEEE Controlled Limit	IEEE Uncontrolled Limit
1	20	1.8%		6	120	14.5%		1.42	0.28
2	40	3.2%		7	140	17.8%			
3	60	4.3%		8	160	20.3%			
4	80	5.2%		9	180	24.7%			
5	100	7.6%		10	200	25.7%			
								<b>RF Po (*Max)</b>	120.0

**UHF Mobile M20QTS9PW1AN**

P-Position 1

**Table 4**

Internal Vehicle MPE Assessment @ 425.0125 MHz										
Antenna Location	Antenna	Gain (dBi)	Meas. Distance (cm)	E/H Field	Calibration Factor	Average over Head, Chest, Lower Trunk Back/Front seats (mW/cm <sup>2</sup> )		Initial Power (W)	Pwr. Density Calc. (mW/cm <sup>2</sup> )	Pwr. Density Max Calc. (mW/cm <sup>2</sup> )
						Back	Front			
Roof (cnt)	HAE6012A	2.15	Highest Reading	E	1.33	0.263	0.147	119.0	0.132	0.13
Measurement Grid										
Test Position	% of Control Limit Head		% of Control Limit Chest		% of Control Limit Lower Trunk		IEEE Controlled Limit:		1.42	
Back Seat	30.1%		13.8%		11.8%		IEEE Uncontrolled Limit:		0.28	
Front Seat	7.9%		8.2%		15.0%		RF Po (*Max):		120.0	

BS-Position 1

**Table 5**

External Vehicle MPE Assessment @ 469.9875 MHz										
Antenna Location	Antenna Model	Gain (dBi)	Meas. Distance (cm)	E/H Field	Calibration Factor	Average over Body (mW/cm <sup>2</sup> )	Initial Power (W)	Pwr. Density Calc. (mW/cm <sup>2</sup> )	Pwr. Density Max Calc. (mW/cm <sup>2</sup> )	
Roof (cnt)	HAE4003A	2.15	90	E	1.26	0.218	120.0	0.109	0.11	
Measurement Grid										
Test Position	Height (cm)	% of Control Limit		Test Position	Height (cm)	% of Control Limit		IEEE Controlled Limit	IEEE Uncontrolled Limit	
1	20	2.1%		6	120	13.8%		1.57	0.31	
2	40	2.5%		7	140	20.3%				
3	60	3.6%		8	160	23.9%				
4	80	5.9%		9	180	29.3%				
5	100	8.3%		10	200	29.2%				
								RF Po (*Max):		120.0

P-Position 1

**Table 6**

Internal Vehicle MPE Assessment @ 469.9875 MHz										
Antenna Location	Antenna	Gain (dBi)	Meas. Distance (cm)	E/H Field	Calibration Factor	Average over Head, Chest, Lower Trunk Back/Front seats (mW/cm <sup>2</sup> )		Initial Power (W)	Pwr. Density Calc. (mW/cm <sup>2</sup> )	Pwr. Density Max Calc. (mW/cm <sup>2</sup> )
						Back	Front			
Roof (cnt)	HAE4003A	2.15	Highest Reading	E	1.26	0.174	0.260	120.0	0.130	0.13
Measurement Grid										
Test Position	% of Control Limit Head		% of Control Limit Chest		% of Control Limit Lower Trunk		IEEE Controlled Limit:		1.57	
Back Seat	8.6%		15.7%		9.0%		IEEE Uncontrolled Limit:		0.31	
Front Seat	10.6%		10.6%		28.5%		RF Po (*Max):		120.0	

**UHF Mobile M20QTS9PW1AN**

BS-Position 1

**Table 7**

External Vehicle MPE Assessment @ 380.0125 MHz									
Antenna Location	Antenna Model	Gain (dBi)	Meas. Distance (cm)	E/H Field	Calibration Factor	Average over Body (mW/cm <sup>2</sup> )	Initial Power (W)	Pwr. Density Calc. (mW/cm <sup>2</sup> )	Pwr. Density Max Calc. (mW/cm <sup>2</sup> )
Roof (cnt)	HAE6013A	4.15	90	E	1.40	0.191	117.0	0.095	0.10
Measurement Grid									
Test Position	Height (cm)	% of Control Limit		Test Position	Height (cm)	% of Control Limit		IEEE Controlled Limit	IEEE Uncontrolled Limit
1	20	3.3%		6	120	15.7%		1.27	0.25
2	40	4.3%		7	140	19.2%			
3	60	6.5%		8	160	22.4%			
4	80	10.8%		9	180	26.3%			
5	100	15.6%		10	200	26.6%			
								<b>RF Po (*Max)</b>	120.0

P-Position 1

**Table 8**

Internal Vehicle MPE Assessment @ 380.0125 MHz										
Antenna Location	Antenna Model	Gain (dBi)	Meas. Distance (cm)	E/H Field	Calibration Factor	Average over Head, Chest, Lower Trunk Back/Front seats (mW/cm <sup>2</sup> )		Initial Power (W)	Pwr. Density Calc. (mW/cm <sup>2</sup> )	Pwr. Density Max Calc. (mW/cm <sup>2</sup> )
						Back	Front			
Roof (cnt)	HAE6013A	4.15	Highest Reading	E	1.40	0.176	0.149	117.0	0.088	0.09
Measurement Grid										
Test Position		% of Control Limit Head		% of Control Limit Chest		% of Control Limit Lower Trunk		IEEE Controlled Limit:		1.27
Back Seat		16.5%		17.7%		7.4%		IEEE Uncontrolled Limit:		0.25
Front Seat		11.1%		11.4%		12.7%		<b>RF Po (*Max):</b>		120.0

BS-Position 1

**Table 9**

External Vehicle MPE Assessment @ 425.0125 MHz									
Antenna Location	Antenna Model	Gain (dBi)	Meas. Distance (cm)	E/H Field	Calibration Factor	Average over Body (mW/cm <sup>2</sup> )	Initial Power (W)	Pwr. Density Calc. (mW/cm <sup>2</sup> )	Pwr. Density Max Calc. (mW/cm <sup>2</sup> )
Roof (cnt)	HAE6013A	4.15	90	E	1.33	0.216	119.0	0.108	0.11
Measurement Grid									
Test Position	Height (cm)	% of Control Limit		Test Position	Height (cm)	% of Control Limit		IEEE Controlled Limit	IEEE Uncontrolled Limit
1	20	2.5%		6	120	13.8%		1.42	0.28
2	40	3.6%		7	140	21.3%			
3	60	4.4%		8	160	27.8%			
4	80	6.5%		9	180	31.9%			
5	100	9.5%		10	200	31.1%			
								<b>RF Po (*Max)</b>	120.0

**UHF Mobile M20QTS9PW1AN**

P-Position 1

**Table 10**

Internal Vehicle MPE Assessment @ 425.0125 MHz										
Antenna Location	Antenna	Gain (dBi)	Meas. Distance (cm)	E/H Field	Calibration Factor	Average over Head, Chest, Lower Trunk Back/Front seats (mW/cm <sup>2</sup> )		Initial Power (W)	Pwr. Density Calc. (mW/cm <sup>2</sup> )	Pwr. Density Max Calc. (mW/cm <sup>2</sup> )
						Back	Front			
Roof (cnt)	HAE6013A	4.15	Highest Reading	E	1.33	0.338	0.261	119.0	0.169	0.17
Measurement Grid										
Test Position		% of Control Limit Head		% of Control Limit Chest		% of Control Limit Lower Trunk		IEEE Controlled Limit:		1.42
Back Seat		42.2%		18.4%		11.0%		IEEE Uncontrolled Limit:		0.28
Front Seat		13.0%		15.8%		26.4%		<b>RF Po (*Max):</b>		120.0

BS-Position 1

**Table 11**

External Vehicle MPE Assessment @ 469.9875 MHz										
Antenna Location	Antenna Model	Gain (dBi)	Meas. Distance (cm)	E/H Field	Calibration Factor	Average over Body (mW/cm <sup>2</sup> )	Initial Power (W)	Pwr. Density Calc. (mW/cm <sup>2</sup> )	Pwr. Density Max Calc. (mW/cm <sup>2</sup> )	
										Roof (cnt)
Measurement Grid										
Test Position	Height (cm)	% of Control Limit		Test Position	Height (cm)	% of Control Limit		IEEE Controlled Limit	IEEE Uncontrolled Limit	
1	20	1.9%		6	120	14.1%		1.57	0.31	
2	40	2.7%		7	140	19.3%				
3	60	4.0%		8	160	23.5%				
4	80	5.3%		9	180	26.3%				
5	100	8.5%		10	200	25.4%				
								<b>RF Po (*Max):</b>		120.0

P-Position 1

**Table 12**

Internal Vehicle MPE Assessment @ 469.9875 MHz										
Antenna Location	Antenna	Gain (dBi)	Meas. Distance (cm)	E/H Field	Calibration Factor	Average over Head, Chest, Lower Trunk Back/Front seats (mW/cm <sup>2</sup> )		Initial Power (W)	Pwr. Density Calc. (mW/cm <sup>2</sup> )	Pwr. Density Max Calc. (mW/cm <sup>2</sup> )
						Back	Front			
Roof (cnt)	HAE6013A	4.15	Highest Reading	E	1.26	0.184	0.242	120.0	0.121	0.12
Measurement Grid										
Test Position		% of Control Limit Head		% of Control Limit Chest		% of Control Limit Lower Trunk		IEEE Controlled Limit:		1.57
Back Seat		9.4%		17.4%		8.5%		IEEE Uncontrolled Limit:		0.31
Front Seat		12.4%		10.1%		23.8%		<b>RF Po (*Max):</b>		120.0

**UHF Mobile M20QTS9PW1AN**

BS-Position 1

**Table 13**

External Vehicle MPE Assessment @ 460.0125 MHz									
Antenna Location	Antenna Model	Gain (dBi)	Meas. Distance (cm)	E/H Field	Calibration Factor	Average over Body (mW/cm <sup>2</sup> )	Initial Power (W)	Pwr. Density Calc. (mW/cm <sup>2</sup> )	Pwr. Density Max Calc. (mW/cm <sup>2</sup> )
Roof (cnt)	HAE4011A	5.65	90	E	1.28	0.203	119.0	0.102	0.10
Measurement Grid									
Test Position	Height (cm)	% of Control Limit		Test Position	Height (cm)	% of Control Limit		IEEE Controlled Limit	IEEE Uncontrolled Limit
1	20	1.0%		6	120	12.1%		1.53	0.31
2	40	1.5%		7	140	18.6%			
3	60	1.8%		8	160	28.2%			
4	80	2.5%		9	180	31.3%			
5	100	5.4%		10	200	30.3%			

P-Position 1

**Table 14**

Internal Vehicle MPE Assessment @ 460.0125 MHz										
Antenna Location	Antenna Model	Gain (dBi)	Meas. Distance (cm)	E/H Field	Calibration Factor	Average over Head, Chest, Lower Trunk Back/Front seats (mW/cm <sup>2</sup> )		Initial Power (W)	Pwr. Density Calc. (mW/cm <sup>2</sup> )	Pwr. Density Max Calc. (mW/cm <sup>2</sup> )
						Back	Front			
Roof (cnt)	HAE4011A	5.65	Highest Reading	E	1.28	0.038	0.063	119.0	0.031	0.03
Measurement Grid										
Test Position		% of Control Limit Head		% of Control Limit Chest		% of Control Limit Lower Trunk		IEEE Controlled Limit:		1.53
Back Seat		2.0%		2.3%		3.2%		IEEE Uncontrolled Limit:		0.31
Front Seat		2.2%		3.2%		6.9%		<b>RF Po (*Max):</b>		120.0

BS-Position 2

**Table 15**

External Vehicle MPE Assessment @ 380.0125 MHz									
Antenna Location	Antenna Model	Gain (dBi)	Meas. Distance (cm)	E/H Field	Calibration Factor	Average over Body (mW/cm <sup>2</sup> )	Initial Power (W)	Pwr. Density Calc. (mW/cm <sup>2</sup> )	Pwr. Density Max Calc. (mW/cm <sup>2</sup> )
Roof (cnt)	HAE6012A	2.15	90	E	1.40	0.162	117.0	0.081	0.08
Measurement Grid									
Test Position	Height (cm)	% of Control Limit		Test Position	Height (cm)	% of Control Limit		IEEE Controlled Limit	IEEE Uncontrolled Limit
1	20	5.6%		6	120	13.3%		1.27	0.25
2	40	7.1%		7	140	15.0%			
3	60	7.6%		8	160	18.9%			
4	80	7.7%		9	180	20.5%			
5	100	11.7%		10	200	20.6%			



**UHF Mobile M20QTS9PW1AN**

BS-Position 2

**Table 16**

External Vehicle MPE Assessment @ 425.0125 MHz									
Antenna Location	Antenna Model	Gain (dBi)	Meas. Distance (cm)	E/H Field	Calibration Factor	Average over Body (mW/cm <sup>2</sup> )	Initial Power (W)	Pwr. Density Calc. (mW/cm <sup>2</sup> )	Pwr. Density Max Calc. (mW/cm <sup>2</sup> )
Roof (cnt)	HAE6012A	2.15	90	E	1.33	0.117	119.0	0.059	0.06
Measurement Grid									
Test Position	Height (cm)	% of Control Limit			Test Position	Height (cm)	% of Control Limit		
1	20	3.1%			6	120	7.5%		
2	40	3.7%			7	140	13.1%		
3	60	3.3%			8	160	13.5%		
4	80	4.6%			9	180	14.7%		
5	100	7.0%			10	200	12.4%		
								IEEE Controlled Limit	IEEE Uncontrolled Limit
								1.42	0.28
								<b>RF Po (*Max)</b>	
								120.0	

BS-Position 2

**Table 17**

External Vehicle MPE Assessment @ 469.9875 MHz									
Antenna Location	Antenna Model	Gain (dBi)	Meas. Distance (cm)	E/H Field	Calibration Factor	Average over Body (mW/cm <sup>2</sup> )	Initial Power (W)	Pwr. Density Calc. (mW/cm <sup>2</sup> )	Pwr. Density Max Calc. (mW/cm <sup>2</sup> )
Roof (cnt)	HAE4003A	2.15	90	E	1.26	0.159	120.0	0.079	0.08
Measurement Grid									
Test Position	Height (cm)	% of Control Limit			Test Position	Height (cm)	% of Control Limit		
1	20	3.9%			6	120	10.2%		
2	40	4.8%			7	140	11.9%		
3	60	5.4%			8	160	16.4%		
4	80	5.7%			9	180	16.4%		
5	100	7.4%			10	200	19.2%		
								IEEE Controlled Limit	IEEE Uncontrolled Limit
								1.57	0.31
								<b>RF Po (*Max)</b>	
								120.0	

BS-Position 2

**Table 18**

External Vehicle MPE Assessment @ 380.0125 MHz									
Antenna Location	Antenna Model	Gain (dBi)	Meas. Distance (cm)	E/H Field	Calibration Factor	Average over Body (mW/cm <sup>2</sup> )	Initial Power (W)	Pwr. Density Calc. (mW/cm <sup>2</sup> )	Pwr. Density Max Calc. (mW/cm <sup>2</sup> )
Roof (cnt)	HAE6013A	4.15	90	E	1.40	0.176	117.0	0.088	0.09
Measurement Grid									
Test Position	Height (cm)	% of Control Limit			Test Position	Height (cm)	% of Control Limit		
1	20	6.9%			6	120	14.7%		
2	40	8.6%			7	140	17.7%		
3	60	8.9%			8	160	20.1%		
4	80	9.5%			9	180	20.7%		
5	100	11.8%			10	200	19.7%		
								IEEE Controlled Limit	IEEE Uncontrolled Limit
								1.27	0.25
								<b>RF Po (*Max)</b>	
								120.0	

**UHF Mobile M20QTS9PW1AN**

BS-Position 2

**Table 19**

External Vehicle MPE Assessment @ 425.0125 MHz									
Antenna Location	Antenna Model	Gain (dBi)	Meas. Distance (cm)	E/H Field	Calibration Factor	Average over Body (mW/cm <sup>2</sup> )	Initial Power (W)	Pwr. Density Calc. (mW/cm <sup>2</sup> )	Pwr. Density Max Calc. (mW/cm <sup>2</sup> )
Roof (cnt)	HAE6013A	4.15	90	E	1.33	0.184	119.0	0.092	0.09
Measurement Grid									
Test Position	Height (cm)	% of Control Limit		Test Position	Height (cm)	% of Control Limit		IEEE Controlled Limit	IEEE Uncontrolled Limit
1	20	7.8%		6	120	16.4%		1.42	0.28
2	40	6.5%		7	140	18.9%			
3	60	5.8%		8	160	18.7%			
4	80	7.8%		9	180	21.0%			
5	100	10.1%		10	200	16.8%			
								<b>RF Po (*Max)</b>	120.0

BS-Position 2

**Table 20**

External Vehicle MPE Assessment @ 469.9875 MHz									
Antenna Location	Antenna Model	Gain (dBi)	Meas. Distance (cm)	E/H Field	Calibration Factor	Average over Body (mW/cm <sup>2</sup> )	Initial Power (W)	Pwr. Density Calc. (mW/cm <sup>2</sup> )	Pwr. Density Max Calc. (mW/cm <sup>2</sup> )
Roof (cnt)	HAE6013A	4.15	90	E	1.26	0.192	120.0	0.096	0.10
Measurement Grid									
Test Position	Height (cm)	% of Control Limit		Test Position	Height (cm)	% of Control Limit		IEEE Controlled Limit	IEEE Uncontrolled Limit
1	20	4.6%		6	120	12.9%		1.57	0.31
2	40	6.2%		7	140	16.9%			
3	60	6.3%		8	160	18.0%			
4	80	7.0%		9	180	18.9%			
5	100	11.8%		10	200	19.7%			
								<b>RF Po (*Max)</b>	120.0

BS-Position 2

**Table 21**

External Vehicle MPE Assessment @ 460.0125 MHz									
Antenna Location	Antenna Model	Gain (dBi)	Meas. Distance (cm)	E/H Field	Calibration Factor	Average over Body (mW/cm <sup>2</sup> )	Initial Power (W)	Pwr. Density Calc. (mW/cm <sup>2</sup> )	Pwr. Density Max Calc. (mW/cm <sup>2</sup> )
Roof (cnt)	HAE4011A	5.65	90	E	1.28	0.184	119.0	0.092	0.09
Measurement Grid									
Test Position	Height (cm)	% of Control Limit		Test Position	Height (cm)	% of Control Limit		IEEE Controlled Limit	IEEE Uncontrolled Limit
1	20	2.6%		6	120	12.4%		1.53	0.31
2	40	4.1%		7	140	17.1%			
3	60	4.4%		8	160	20.7%			
4	80	5.7%		9	180	21.9%			
5	100	7.3%		10	200	23.7%			
								<b>RF Po (*Max)</b>	120.0

**UHF Mobile M20QTS9PW1AN**

BS-Position 3

**Table 22**

External Vehicle MPE Assessment @ 380.0125 MHz											
Antenna Location	Antenna Model	Gain (dBi)	Meas. Distance (cm)	E/H Field	Calibration Factor	Average over Body (mW/cm <sup>2</sup> )	Initial Power (W)	Pwr. Density Calc. (mW/cm <sup>2</sup> )	Pwr. Density Max Calc. (mW/cm <sup>2</sup> )		
Roof (cnt)	HAE6012A	2.15	90	E	1.40	0.112	117.0	0.056	0.06		
Measurement Grid											
Test Position	Height (cm)	% of Control Limit			Test Position	Height (cm)	% of Control Limit			IEEE Controlled Limit	IEEE Uncontrolled Limit
1	20	3.6%			6	120	8.4%			1.27	0.25
2	40	4.7%			7	140	10.9%			RF Po (*Max)	120.0
3	60	4.9%			8	160	12.1%				
4	80	6.5%			9	180	13.3%				
5	100	9.1%			10	200	14.7%				

BS-Position 3

**Table 23**

External Vehicle MPE Assessment @ 425.0125 MHz											
Antenna Location	Antenna Model	Gain (dBi)	Meas. Distance (cm)	E/H Field	Calibration Factor	Average over Body (mW/cm <sup>2</sup> )	Initial Power (W)	Pwr. Density Calc. (mW/cm <sup>2</sup> )	Pwr. Density Max Calc. (mW/cm <sup>2</sup> )		
Roof (cnt)	HAE6012A	2.15	90	E	1.33	0.137	119.0	0.069	0.07		
Measurement Grid											
Test Position	Height (cm)	% of Control Limit			Test Position	Height (cm)	% of Control Limit			IEEE Controlled Limit	IEEE Uncontrolled Limit
1	20	5.0%			6	120	9.5%			1.42	0.28
2	40	6.3%			7	140	11.3%			RF Po (*Max)	120.0
3	60	8.4%			8	160	13.6%				
4	80	9.0%			9	180	13.4%				
5	100	9.3%			10	200	11.2%				

BS-Position 3

**Table 24**

External Vehicle MPE Assessment @ 469.9875 MHz											
Antenna Location	Antenna Model	Gain (dBi)	Meas. Distance (cm)	E/H Field	Calibration Factor	Average over Body (mW/cm <sup>2</sup> )	Initial Power (W)	Pwr. Density Calc. (mW/cm <sup>2</sup> )	Pwr. Density Max Calc. (mW/cm <sup>2</sup> )		
Roof (cnt)	HAE4003A	2.15	90	E	1.26	0.141	120.0	0.070	0.07		
Measurement Grid											
Test Position	Height (cm)	% of Control Limit			Test Position	Height (cm)	% of Control Limit			IEEE Controlled Limit	IEEE Uncontrolled Limit
1	20	4.8%			6	120	10.3%			1.57	0.31
2	40	5.5%			7	140	10.8%			RF Po (*Max)	120.0
3	60	7.4%			8	160	10.9%				
4	80	9.5%			9	180	11.0%				
5	100	9.6%			10	200	10.0%				

**UHF Mobile M20QTS9PW1AN**

BS-Position 3

**Table 25**

External Vehicle MPE Assessment @ 380.0125 MHz										
Antenna Location	Antenna Model	Gain (dBi)	Meas. Distance (cm)	E/H Field	Calibration Factor	Average over Body (mW/cm <sup>2</sup> )	Initial Power (W)	Pwr. Density Calc. (mW/cm <sup>2</sup> )	Pwr. Density Max Calc. (mW/cm <sup>2</sup> )	
Roof (cnt)	HAE6013A	4.15	90	E	1.40	0.153	117.0	0.077	0.08	
Measurement Grid										
Test Position	Height (cm)	% of Control Limit			Test Position	Height (cm)	% of Control Limit		IEEE Controlled Limit	IEEE Uncontrolled Limit
1	20	3.2%			6	120	13.8%		1.27	0.25
2	40	4.1%			7	140	15.4%			
3	60	5.2%			8	160	17.4%			
4	80	7.0%			9	180	18.8%			
5	100	12.3%			10	200	23.6%			
								<b>RF Po (*Max)</b>	120.0	

BS-Position 3

**Table 26**

External Vehicle MPE Assessment @ 425.0125 MHz										
Antenna Location	Antenna Model	Gain (dBi)	Meas. Distance (cm)	E/H Field	Calibration Factor	Average over Body (mW/cm <sup>2</sup> )	Initial Power (W)	Pwr. Density Calc. (mW/cm <sup>2</sup> )	Pwr. Density Max Calc. (mW/cm <sup>2</sup> )	
Roof (cnt)	HAE6013A	4.15	90	E	1.33	0.211	119.0	0.105	0.11	
Measurement Grid										
Test Position	Height (cm)	% of Control Limit			Test Position	Height (cm)	% of Control Limit		IEEE Controlled Limit	IEEE Uncontrolled Limit
1	20	6.1%			6	120	15.6%		1.42	0.28
2	40	8.1%			7	140	19.0%			
3	60	10.2%			8	160	19.1%			
4	80	14.5%			9	180	20.5%			
5	100	15.1%			10	200	20.4%			
								<b>RF Po (*Max)</b>	120.0	

BS-Position 3

**Table 27**

External Vehicle MPE Assessment @ 469.9875 MHz										
Antenna Location	Antenna Model	Gain (dBi)	Meas. Distance (cm)	E/H Field	Calibration Factor	Average over Body (mW/cm <sup>2</sup> )	Initial Power (W)	Pwr. Density Calc. (mW/cm <sup>2</sup> )	Pwr. Density Max Calc. (mW/cm <sup>2</sup> )	
Roof (cnt)	HAE6013A	4.15	90	E	1.26	0.161	120.0	0.081	0.08	
Measurement Grid										
Test Position	Height (cm)	% of Control Limit			Test Position	Height (cm)	% of Control Limit		IEEE Controlled Limit	IEEE Uncontrolled Limit
1	20	6.3%			6	120	10.7%		1.57	0.31
2	40	7.6%			7	140	10.5%			
3	60	10.8%			8	160	10.3%			
4	80	11.5%			9	180	11.9%			
5	100	10.0%			10	200	13.4%			
								<b>RF Po (*Max)</b>	120.0	

**UHF Mobile M20QTS9PW1AN**

BS-Position 3

**Table 28**

External Vehicle MPE Assessment @ 460.0125 MHz									
Antenna Location	Antenna Model	Gain (dBi)	Meas. Distance (cm)	E/H Field	Calibration Factor	Average over Body (mW/cm <sup>2</sup> )	Initial Power (W)	Pwr. Density Calc. (mW/cm <sup>2</sup> )	Pwr. Density Max Calc. (mW/cm <sup>2</sup> )
Roof (cnt)	HAE4011A	5.65	90	E	1.28	0.166	119.0	0.083	0.08
Measurement Grid									
Test Position	Height (cm)	% of Control Limit		Test Position	Height (cm)	% of Control Limit		IEEE Controlled Limit	IEEE Uncontrolled Limit
1	20	3.7%		6	120	10.2%		1.53	0.31
2	40	5.3%		7	140	12.3%			
3	60	6.2%		8	160	14.3%			
4	80	8.0%		9	180	21.0%			
5	100	8.2%		10	200	19.0%			
								<b>RF Po (*Max)</b>	120.0

BS-Position 4

**Table 29**

External Vehicle MPE Assessment @ 380.0125 MHz									
Antenna Location	Antenna Model	Gain (dBi)	Meas. Distance (cm)	E/H Field	Calibration Factor	Average over Body (mW/cm <sup>2</sup> )	Initial Power (W)	Pwr. Density Calc. (mW/cm <sup>2</sup> )	Pwr. Density Max Calc. (mW/cm <sup>2</sup> )
Roof (cnt)	HAE6012A	2.15	90	E	1.40	0.106	117.0	0.053	0.05
Measurement Grid									
Test Position	Height (cm)	% of Control Limit		Test Position	Height (cm)	% of Control Limit		IEEE Controlled Limit	IEEE Uncontrolled Limit
1	20	4.9%		6	120	11.1%		1.27	0.25
2	40	5.6%		7	140	10.1%			
3	60	6.2%		8	160	8.8%			
4	80	7.3%		9	180	9.8%			
5	100	10.3%		10	200	9.9%			
								<b>RF Po (*Max)</b>	120.0

BS-Position 4

**Table 30**

External Vehicle MPE Assessment @ 425.0125 MHz									
Antenna Location	Antenna Model	Gain (dBi)	Meas. Distance (cm)	E/H Field	Calibration Factor	Average over Body (mW/cm <sup>2</sup> )	Initial Power (W)	Pwr. Density Calc. (mW/cm <sup>2</sup> )	Pwr. Density Max Calc. (mW/cm <sup>2</sup> )
Roof (cnt)	HAE6012A	2.15	90	E	1.33	0.113	119.0	0.057	0.06
Measurement Grid									
Test Position	Height (cm)	% of Control Limit		Test Position	Height (cm)	% of Control Limit		IEEE Controlled Limit	IEEE Uncontrolled Limit
1	20	4.7%		6	120	9.7%		1.42	0.28
2	40	5.7%		7	140	7.5%			
3	60	5.8%		8	160	7.7%			
4	80	8.9%		9	180	9.7%			
5	100	10.5%		10	200	9.8%			
								<b>RF Po (*Max)</b>	120.0

**UHF Mobile M20QTS9PW1AN**

BS-Position 4

**Table 31**

External Vehicle MPE Assessment @ 469.9875 MHz										
Antenna Location	Antenna Model	Gain (dBi)	Meas. Distance (cm)	E/H Field	Calibration Factor	Average over Body (mW/cm <sup>2</sup> )	Initial Power (W)	Pwr. Density Calc. (mW/cm <sup>2</sup> )	Pwr. Density Max Calc. (mW/cm <sup>2</sup> )	
Roof (cnt)	HAE4003A	2.15	90	E	1.26	0.141	120.0	0.070	0.07	
Measurement Grid										
Test Position	Height (cm)	% of Control Limit			Test Position	Height (cm)	% of Control Limit		IEEE Controlled Limit	IEEE Uncontrolled Limit
1	20	3.3%			6	120	12.4%		1.57	0.31
2	40	4.1%			7	140	11.1%			
3	60	4.3%			8	160	12.3%			
4	80	8.3%			9	180	12.8%			
5	100	9.2%			10	200	12.0%			
								<b>RF Po (*Max)</b>	120.0	

BS-Position 4

**Table 32**

External Vehicle MPE Assessment @ 380.0125 MHz										
Antenna Location	Antenna Model	Gain (dBi)	Meas. Distance (cm)	E/H Field	Calibration Factor	Average over Body (mW/cm <sup>2</sup> )	Initial Power (W)	Pwr. Density Calc. (mW/cm <sup>2</sup> )	Pwr. Density Max Calc. (mW/cm <sup>2</sup> )	
Roof (cnt)	HAE6013A	4.15	90	E	1.40	0.163	117.0	0.082	0.08	
Measurement Grid										
Test Position	Height (cm)	% of Control Limit			Test Position	Height (cm)	% of Control Limit		IEEE Controlled Limit	IEEE Uncontrolled Limit
1	20	2.9%			6	120	16.1%		1.27	0.25
2	40	11.3%			7	140	15.8%			
3	60	10.3%			8	160	14.4%			
4	80	11.6%			9	180	13.6%			
5	100	15.9%			10	200	16.8%			
								<b>RF Po (*Max)</b>	120.0	

BS-Position 4

**Table 33**

External Vehicle MPE Assessment @ 425.0125 MHz										
Antenna Location	Antenna Model	Gain (dBi)	Meas. Distance (cm)	E/H Field	Calibration Factor	Average over Body (mW/cm <sup>2</sup> )	Initial Power (W)	Pwr. Density Calc. (mW/cm <sup>2</sup> )	Pwr. Density Max Calc. (mW/cm <sup>2</sup> )	
Roof (cnt)	HAE6013A	4.15	90	E	1.33	0.172	119.0	0.086	0.09	
Measurement Grid										
Test Position	Height (cm)	% of Control Limit			Test Position	Height (cm)	% of Control Limit		IEEE Controlled Limit	IEEE Uncontrolled Limit
1	20	3.3%			6	120	14.2%		1.42	0.28
2	40	11.8%			7	140	9.9%			
3	60	12.0%			8	160	13.3%			
4	80	12.8%			9	180	13.2%			
5	100	14.0%			10	200	16.8%			
								<b>RF Po (*Max)</b>	120.0	

**UHF Mobile M20QTS9PW1AN**

BS-Position 4

**Table 34**

External Vehicle MPE Assessment @ 469.9875 MHz									
Antenna Location	Antenna Model	Gain (dBi)	Meas. Distance (cm)	E/H Field	Calibration Factor	Average over Body (mW/cm <sup>2</sup> )	Initial Power (W)	Pwr. Density Calc. (mW/cm <sup>2</sup> )	Pwr. Density Max Calc. (mW/cm <sup>2</sup> )
Roof (cnt)	HAE6013A	4.15	90	E	1.26	0.180	120.0	0.090	0.09
Measurement Grid									
Test Position	Height (cm)	% of Control Limit		Test Position	Height (cm)	% of Control Limit		IEEE Controlled Limit	IEEE Uncontrolled Limit
1	20	8.0%		6	120	12.2%		1.57	0.31
2	40	10.2%		7	140	11.5%			
3	60	8.7%		8	160	11.2%			
4	80	12.9%		9	180	12.6%			
5	100	12.4%		10	200	15.2%			
								<b>RF Po (*Max)</b>	120.0

BS-Position 4

**Table 35**

External Vehicle MPE Assessment @ 460.0125 MHz									
Antenna Location	Antenna Model	Gain (dBi)	Meas. Distance (cm)	E/H Field	Calibration Factor	Average over Body (mW/cm <sup>2</sup> )	Initial Power (W)	Pwr. Density Calc. (mW/cm <sup>2</sup> )	Pwr. Density Max Calc. (mW/cm <sup>2</sup> )
Roof (cnt)	HAE4011A	5.65	90	E	1.28	0.184	119.0	0.092	0.09
Measurement Grid									
Test Position	Height (cm)	% of Control Limit		Test Position	Height (cm)	% of Control Limit		IEEE Controlled Limit	IEEE Uncontrolled Limit
1	20	4.7%		6	120	12.0%		1.53	0.31
2	40	7.0%		7	140	11.3%			
3	60	9.0%		8	160	14.2%			
4	80	11.5%		9	180	18.3%			
5	100	12.6%		10	200	19.6%			
								<b>RF Po (*Max)</b>	120.0

BS-Position 5

**Table 36**

External Vehicle MPE Assessment @ 380.0125 MHz									
Antenna Location	Antenna Model	Gain (dBi)	Meas. Distance (cm)	E/H Field	Calibration Factor	Average over Body (mW/cm <sup>2</sup> )	Initial Power (W)	Pwr. Density Calc. (mW/cm <sup>2</sup> )	Pwr. Density Max Calc. (mW/cm <sup>2</sup> )
Roof (cnt)	HAE6012A	2.15	90	E	1.40	0.131	117.0	0.066	0.07
Measurement Grid									
Test Position	Height (cm)	% of Control Limit		Test Position	Height (cm)	% of Control Limit		IEEE Controlled Limit	IEEE Uncontrolled Limit
1	20	1.0%		6	120	12.3%		1.27	0.25
2	40	0.5%		7	140	14.4%			
3	60	1.9%		8	160	17.0%			
4	80	10.3%		9	180	18.0%			
5	100	11.1%		10	200	17.3%			
								<b>RF Po (*Max)</b>	120.0

**UHF Mobile M20QTS9PW1AN**

BS-Position 5

**Table 37**

External Vehicle MPE Assessment @ 425.0125 MHz									
Antenna Location	Antenna Model	Gain (dBi)	Meas. Distance (cm)	E/H Field	Calibration Factor	Average over Body (mW/cm <sup>2</sup> )	Initial Power (W)	Pwr. Density Calc. (mW/cm <sup>2</sup> )	Pwr. Density Max Calc. (mW/cm <sup>2</sup> )
Roof (cnt)	HAE6012A	2.15	90	E	1.33	0.050	119.0	0.025	0.03
Measurement Grid									
Test Position	Height (cm)	% of Control Limit		Test Position	Height (cm)	% of Control Limit		IEEE Controlled Limit	IEEE Uncontrolled Limit
1	20	0.2%		6	120	2.1%		1.42	0.28
2	40	1.1%		7	140	2.4%			
3	60	1.1%		8	160	2.6%			
4	80	1.2%		9	180	11.4%			
5	100	1.2%		10	200	12.1%			
								RF Po (*Max)	120.0

BS-Position 5

**Table 38**

External Vehicle MPE Assessment @ 469.9875 MHz									
Antenna Location	Antenna Model	Gain (dBi)	Meas. Distance (cm)	E/H Field	Calibration Factor	Average over Body (mW/cm <sup>2</sup> )	Initial Power (W)	Pwr. Density Calc. (mW/cm <sup>2</sup> )	Pwr. Density Max Calc. (mW/cm <sup>2</sup> )
Roof (cnt)	HAE4003A	2.15	90	E	1.26	0.092	120.0	0.046	0.05
Measurement Grid									
Test Position	Height (cm)	% of Control Limit		Test Position	Height (cm)	% of Control Limit		IEEE Controlled Limit	IEEE Uncontrolled Limit
1	20	1.0%		6	120	3.4%		1.57	0.31
2	40	1.0%		7	140	9.5%			
3	60	1.0%		8	160	12.6%			
4	80	1.6%		9	180	11.9%			
5	100	2.7%		10	200	13.8%			
								RF Po (*Max)	120.0

BS-Position 5

**Table 39**

External Vehicle MPE Assessment @ 380.0125 MHz									
Antenna Location	Antenna Model	Gain (dBi)	Meas. Distance (cm)	E/H Field	Calibration Factor	Average over Body (mW/cm <sup>2</sup> )	Initial Power (W)	Pwr. Density Calc. (mW/cm <sup>2</sup> )	Pwr. Density Max Calc. (mW/cm <sup>2</sup> )
Roof (cnt)	HAE6013A	4.15	90	E	1.40	0.057	117.0	0.028	0.03
Measurement Grid									
Test Position	Height (cm)	% of Control Limit		Test Position	Height (cm)	% of Control Limit		IEEE Controlled Limit	IEEE Uncontrolled Limit
1	20	0.3%		6	120	4.3%		1.27	0.25
2	40	1.0%		7	140	6.8%			
3	60	1.2%		8	160	7.4%			
4	80	1.5%		9	180	8.7%			
5	100	4.0%		10	200	9.5%			
								RF Po (*Max)	120.0



**UHF Mobile M20QTS9PW1AN**

BS-Position 5

**Table 40**

External Vehicle MPE Assessment @ 425.0125 MHz									
Antenna Location	Antenna Model	Gain (dBi)	Meas. Distance (cm)	E/H Field	Calibration Factor	Average over Body (mW/cm <sup>2</sup> )	Initial Power (W)	Pwr. Density Calc. (mW/cm <sup>2</sup> )	Pwr. Density Max Calc. (mW/cm <sup>2</sup> )
Roof (cnt)	HAE6013A	4.15	90	E	1.33	0.048	119.0	0.024	0.02
Measurement Grid									
Test Position	Height (cm)	% of Control Limit		Test Position	Height (cm)	% of Control Limit		IEEE Controlled Limit	IEEE Uncontrolled Limit
1	20	0.8%		6	120	3.2%		1.42	0.28
2	40	0.8%		7	140	4.4%			RF Po (*Max)
3	60	1.2%		8	160	4.9%			
4	80	2.9%		9	180	6.1%			
5	100	3.6%		10	200	5.9%			

BS-Position 5

**Table 41**

External Vehicle MPE Assessment @ 469.9875 MHz									
Antenna Location	Antenna Model	Gain (dBi)	Meas. Distance (cm)	E/H Field	Calibration Factor	Average over Body (mW/cm <sup>2</sup> )	Initial Power (W)	Pwr. Density Calc. (mW/cm <sup>2</sup> )	Pwr. Density Max Calc. (mW/cm <sup>2</sup> )
Roof (cnt)	HAE6013A	4.15	90	E	1.26	0.053	120.0	0.027	0.03
Measurement Grid									
Test Position	Height (cm)	% of Control Limit		Test Position	Height (cm)	% of Control Limit		IEEE Controlled Limit	IEEE Uncontrolled Limit
1	20	0.1%		6	120	3.1%		1.57	0.31
2	40	0.8%		7	140	4.8%			RF Po (*Max)
3	60	1.0%		8	160	5.8%			
4	80	1.7%		9	180	6.9%			
5	100	2.1%		10	200	7.7%			

BS-Position 5

**Table 42**

External Vehicle MPE Assessment @ 460.0125 MHz									
Antenna Location	Antenna Model	Gain (dBi)	Meas. Distance (cm)	E/H Field	Calibration Factor	Average over Body (mW/cm <sup>2</sup> )	Initial Power (W)	Pwr. Density Calc. (mW/cm <sup>2</sup> )	Pwr. Density Max Calc. (mW/cm <sup>2</sup> )
Roof (cnt)	HAE4011A	5.65	90	E	1.28	0.076	119.0	0.038	0.04
Measurement Grid									
Test Position	Height (cm)	% of Control Limit		Test Position	Height (cm)	% of Control Limit		IEEE Controlled Limit	IEEE Uncontrolled Limit
1	20	0.2%		6	120	4.8%		1.53	0.31
2	40	0.4%		7	140	7.5%			RF Po (*Max)
3	60	1.1%		8	160	8.8%			
4	80	1.8%		9	180	10.2%			
5	100	2.7%		10	200	12.3%			

**APPENDIX F**  
**Computational EME Assessment**



**COMPUTATIONAL EME COMPLIANCE ASSESSMENT OF THE DIGITAL  
VEHICULAR REPEATER (DVR UHF), MODEL #DQPM DVR6000P, FCC ID  
LO6-DVRSUHF AND XTL5000 UHF MOBILE RADIO, MODEL  
#M20QTS9PW1AN and #M20QSS9PW1AN**

**January 18, 2007**

Giorgi Bit-Babik, Ph.D., and Antonio Faraone, Ph.D.  
Motorola Corporate EME Research Lab, Plantation, Florida

**Introduction**

This report summarizes the computational [numerical modeling] analysis performed to document compliance of the DVR UHF 10 watt model DQPM DVR6000P interfaced with, and transmitting simultaneously with, either companion UHF Mobile Radio models M20QTS9PW1AN with maximum transmit power up to 120 watts or M20QSS9PW1AN with maximum transmit power up to 48 watts and vehicle-mounted antennas with the Federal Communications Commission (FCC) guidelines for human exposure to radio frequency (RF) emissions. The DVR radio operates in the 470 - 512 MHz frequency band while the companion UHF mobile radios operate in the 380-470 MHz band.

This computational analysis supplements the measurements conducted to evaluate the FCC *maximum permissible exposure* (MPE) limits for this mobile device. All test conditions (5 in total) that did not conform with applicable MPE limits were analyzed to determine whether those conditions complied with the *specific absorption rate* (SAR) limits for general public exposure (1.6 W/kg averaged over 1 gram of tissue and 0.08 W/kg averaged over the whole body) set forth in FCC guidelines, which are based on the IEEE C95.1-1999 standard [1]. In total 12 independent simulations have been performed. Six simulations are addressing the exposure to UHF mobile radios with roof-mount quarter wavelength or half wavelength monopole antennas, and another six are

addressing the exposure of passenger to the DVR UHF with trunk-mount quarter wavelength antennas. For both simulations groups, a commercial code based on Finite-Difference-Time-Domain (FDTD) methodology was employed to carry out the computational analysis. It is well established and recognized within the scientific community that SAR is the primary dosimetric quantity used to evaluate the human body's absorption of RF energy and that MPEs are in fact derived from SAR. Accordingly, the SAR computations provide a scientifically valid and more relevant estimate of human exposure to RF energy.

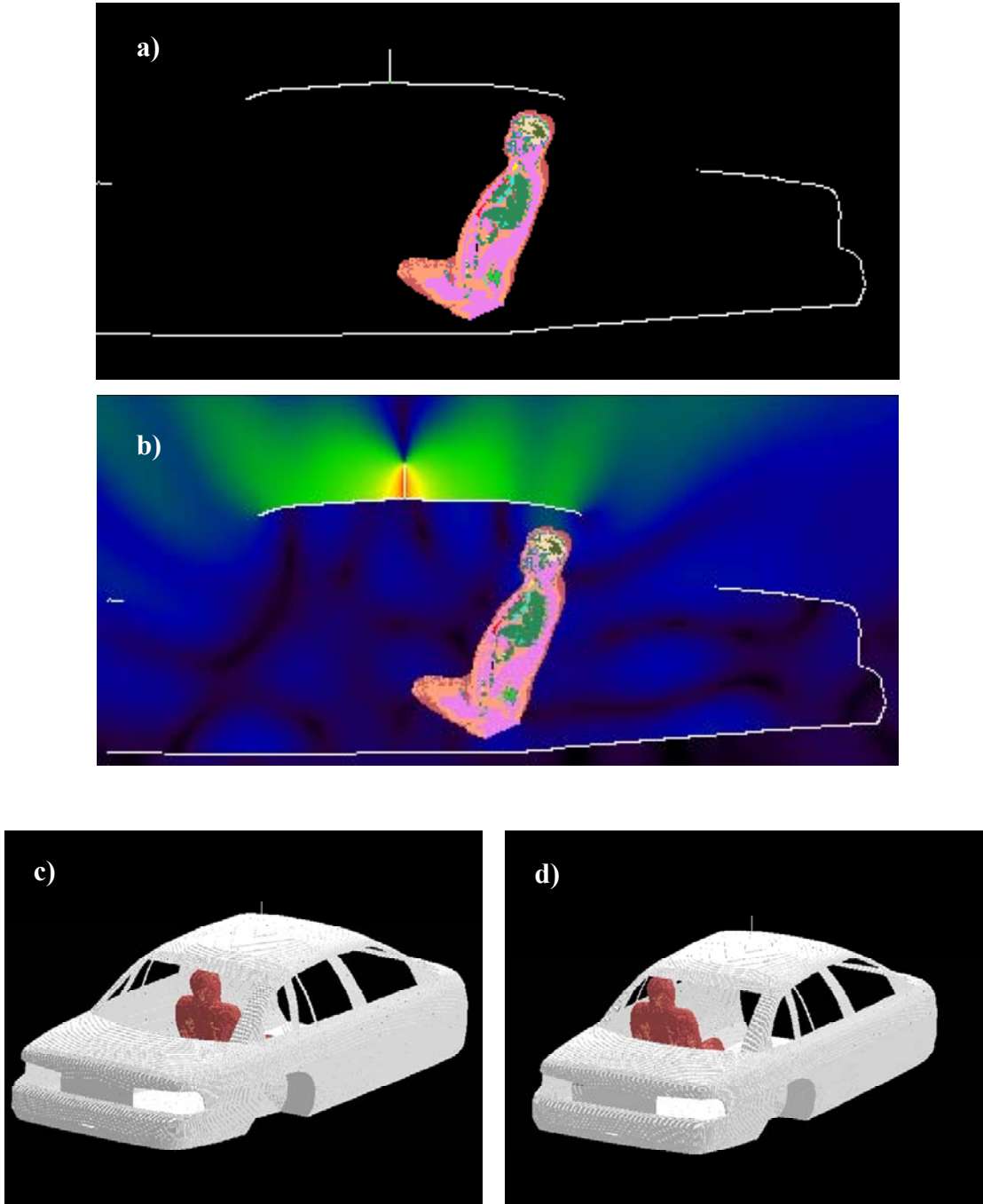
## **Method**

The simulation code employed is XFDTD™ v6.3, by Remcom Inc., State College, PA. This computational suite features a heterogeneous full body standing model (High Fidelity Body Mesh), derived from the so-called Visible Human [2], discretized in 5 mm voxels. The dielectric properties of 23 body tissues are automatically assigned by XFDTD™ at any specific frequency. The “seated” man model was obtained from the standing model by modifying the articulation angles at the hips and the knees. Details of the computational method and model are provided in the Appendix to this report, following the structure outlined in Appendix B.III of the Supplement C to the FCC OET Bulletin 65.

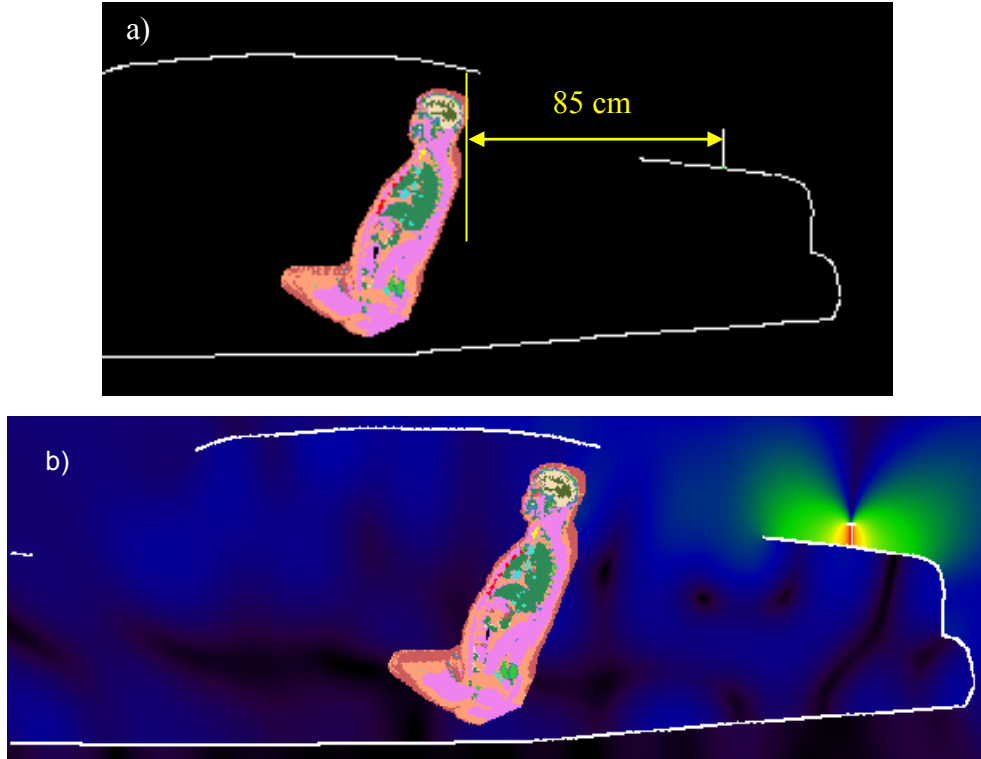
The car model has been imported into XFDTD™ from the CAD file of a sedan car having dimensions 4.98 m (L) x 1.85 m (W) x 1.18 m (H), and discretized in 5mm voxels. For the car model the wheels and part of the hood were omitted in order to fit within the computational memory available. These omissions would not be expected to affect the exposure calculations in any event.

For passenger exposure from UHF mobile radio roof-mount antennas the antenna was located in the center of the roof, so as to replicate the experimental conditions used in MPE measurements. Figure 1 shows one of the XFDTD™ computational models used for passenger exposure from the roof mounted antenna. For passenger exposure from DVR UHF trunk-mount antennas the distance of antennas from the passenger head was set at 85 cm and the antenna was located at 26 cm distance from the end of the trunk, so as to replicate the experimental conditions used in MPE measurements. Figures 2 shows

one of the XFDTD™ computational models used for passenger exposure to trunk mounted antenna.



**Figure 1: Passenger model exposed to a roof-mount antenna (16 cm) operating at 470 MHz: XFDTD geometry (a) and H-field distribution (b). The antenna is mounted in the center of the roof. The passenger model is located either in the center (c) or on the side of the back seat (d).**



**Figure 2: Passenger model exposed to a trunk-mount antenna (8.3 cm) operating at 470 MHz: XFDTD geometry (a) and H-field distribution (b). The antenna is mounted at 85 cm from the passenger.**

The computational code employs a time-harmonic excitation to produce a steady state electromagnetic field in the exposed body. Subsequently, the corresponding SAR distribution is automatically processed in order to determine the whole-body and 1-g average SAR. The maximum output power from UHF mobile radio antenna is 120 W *rms*. Since the ohmic losses in the cable and in the car materials, as well as the mismatch losses at the antenna feed-point, are neglected, and source-based time averaging (50% talk time) is employed, all computational results are normalized to half of it, i.e., 60 W *rms* net output power. The maximum output power from DVR UHF system is 10 W *rms* and the computational results are normalized to 10 W *rms*. Two independent set simulations, one for DVR UHF trunk mount antenna and one for UHF radio roof-mount antenna were performed. Since UHF mobile radio and DVR UHF repeater can transmit simultaneously, the maximum peak and whole body average SAR results from each set of

data were combined for the corresponding passenger location to produce peak SAR value for the composite exposure from both roof and trunk-mount antennas. The obtained composite peak SAR value is an overestimation of the actual exposure because the peak SAR values from the roof- and trunk-mount antennas that contribute to the composite value are not found at the same location in the body.

### Results of SAR computations for car passengers

The test conditions for DVR UHF repeater requiring SAR computations are summarized in Table I, together with the antenna data and the SAR results. The conditions are for antenna mounted on the trunk. The passenger is located in the center or on the side of the rear seat. The passenger model is surrounded by air, as the seat, which is made out of poorly conductive fabrics, is not included in the computational model. All the transmit frequency, antenna length, and passenger location combinations reported in Table I have been simulated individually.

Table I: Results of the SAR computations for passenger exposure from DVR UHF trunk-mount antennas

MPE Table #	Mount location	Antenna Kit #	Antenna length		Freq [MHz]	Exposure location	SAR [W/kg]	
			Physical	XFDTD			1-g	WB
1	Trunk	<b>HAE6016A</b>	8.3 cm	8.0 cm	470	center	0.0463	0.00193
2	Trunk	<b>HAE6016A</b>	8.3 cm	8.0 cm	491	center	0.0880	0.00245
3	Trunk	<b>HAE4004A</b>	14.8 cm	15.0 cm	512	center	0.0926	0.00244
4	Trunk	<b>HAE6016A</b>	8.3 cm	8.0 cm	470	side	0.0599	0.00239
5	Trunk	<b>HAE6016A</b>	8.3 cm	8.0 cm	491	side	0.0598	0.00276
6	Trunk	<b>HAE4004A</b>	14.8 cm	15.0 cm	512	side	0.0781	0.00259

The test conditions for UHF mobile radio requiring SAR computations are summarized in Table II, together with the antenna data and the SAR results. The conditions are for antenna mounted on the roof. The passenger is located at the same location as in previously described conditions, i.e. in the center or on the side of the rear seat. All the transmit frequency, antenna length, and passenger location combinations reported in Table II have been simulated individually.

Table II: Results of the SAR computations for passenger exposure from UHF mobile radio roof-mount antennas (50% talk time)

MPE Table #	Mount location	Antenna Kit #	Antenna length		Freq [MHz]	Exposure location	SAR [W/kg]	
			Physical	XFDTD			1-g	WB
1	Roof	HAE6012A	18.2 cm	18.0 cm	380	center	0.16	0.0071
2	Roof	HAE6013A	28.4 cm	28.5 cm	425	center	0.14	0.0094
3	Roof	HAE4003A	16.2 cm	16.0 cm	470	center	0.097	0.0037
4	Roof	HAE6012A	18.2 cm	18.0 cm	380	side	0.11	0.0048
5	Roof	HAE6013A	28.4 cm	28.5 cm	425	side	0.18	0.0081
6	Roof	HAE4003A	16.2 cm	16.0 cm	470	side	0.054	0.0028

For each location of the passenger on the back seat (center and side) the peak SAR values were identified for both DVR UHF and UHF mobile radio exposure and then combined to produce the composite peak SAR value. Table III and Table IV present those values.

Table III: Peak 1-g average SAR for both passenger locations on the back seat and composite 1-g average SAR from simultaneous exposure.

Passenger location	DVR UHF [W/kg]	UHF mobile radio [W/kg]	Total SAR [W/kg]
Center of the back seat	0.093	0.16	0.25
Side of the back seat	0.078	0.18	0.26

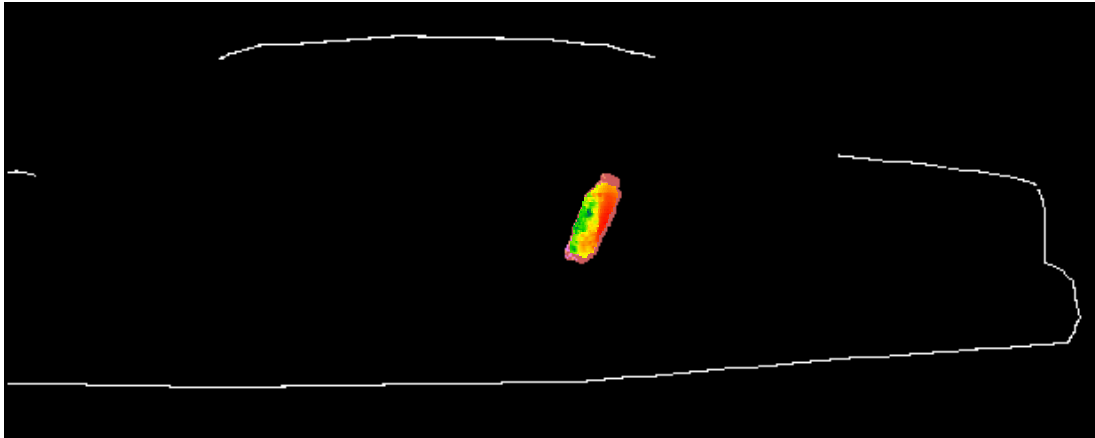
Table IV: Peak whole body average SAR for both passenger locations on the back seat and composite whole body average SAR from simultaneous exposure.

Passenger location	DVR UHF [W/kg]	UHF mobile radio [W/kg]	Total SAR [W/kg]
Center of the back seat	0.0025	0.0094	0.012
Side of the back seat	0.0028	0.0081	0.011

From Table III and Table IV the maximum combined peak 1-g SAR is 0.26 W/kg which occurs in the body located on the side of the back seat, while the maximum combined whole-body average SAR is 0.011 W/kg which occurs in the body located in the center of the back seat.

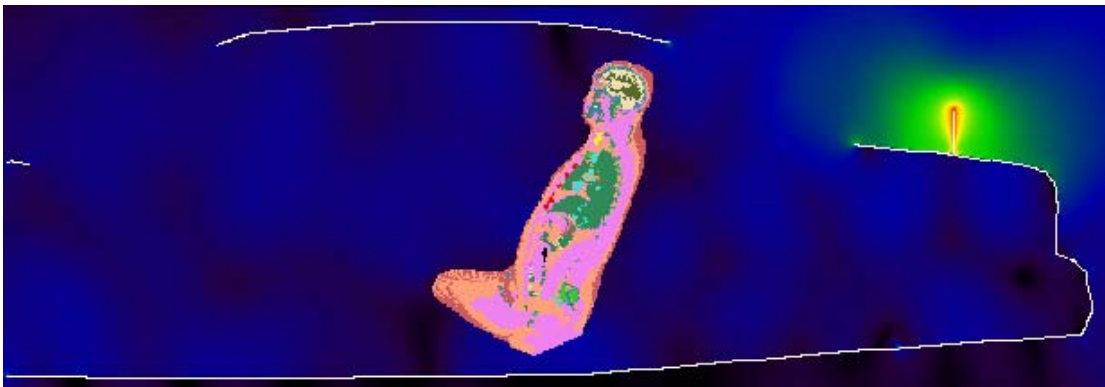


The SAR distribution in the passenger model in the exposure condition with DVR UHF radio trunk-mount antennas that gave highest 1-g SAR is reported in Fig. 3 (512 MHz, passenger in the center of the back seat, HAE4004A antenna).

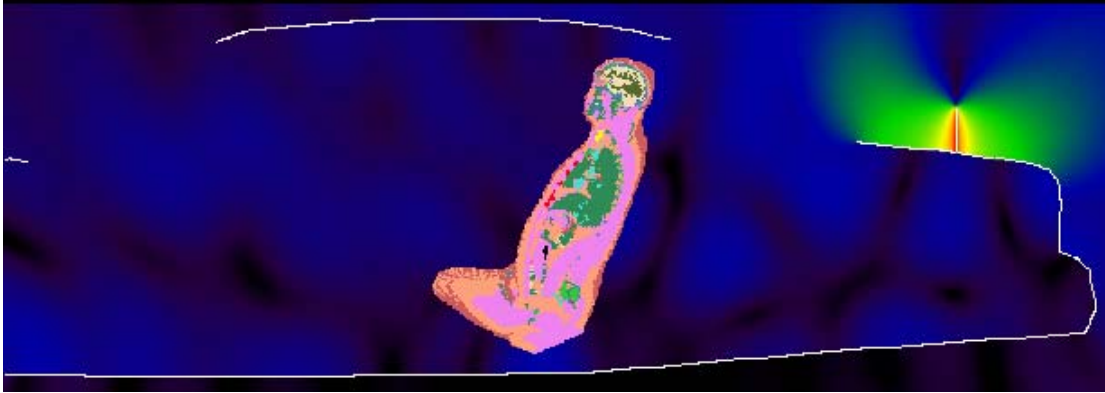


**Figure 3. SAR at 512 MHz in the passenger located in the center of the back seat, produced by the trunk-mount HAE4004A antenna. The contour plot in the figure is relative to the plane where the peak 1-g average SAR for this exposure condition occurs.**

The two pictures below show the E and H field distributions in the plane of the antenna corresponding to the condition represented in Fig 3.



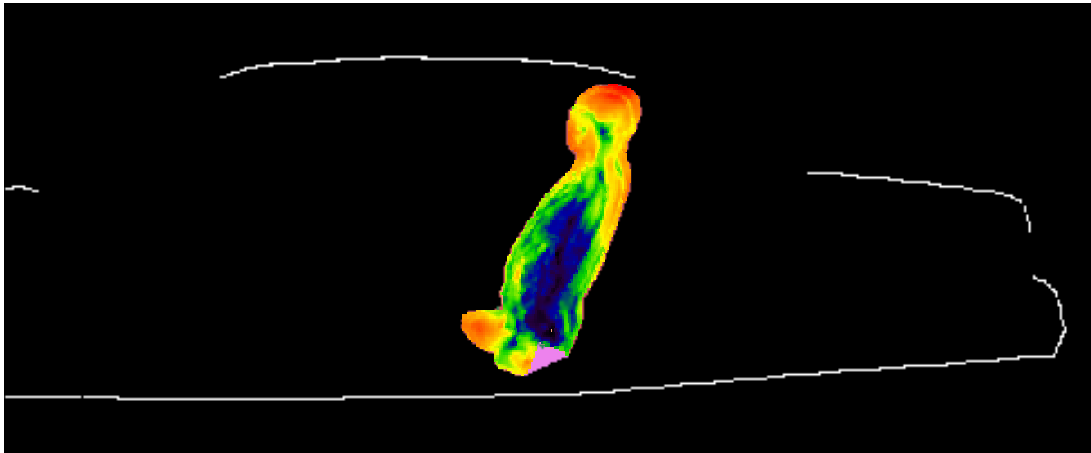
**(a)**



(b)

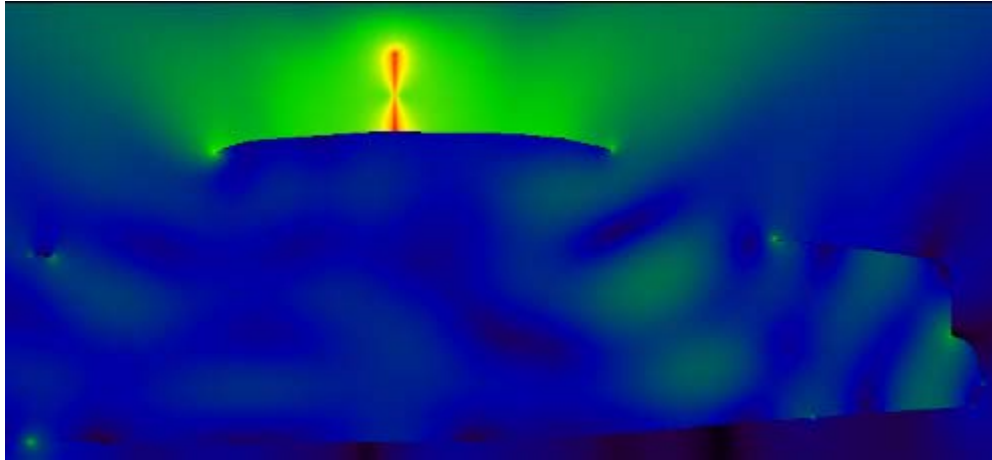
**Figure 4. (a) E-field distribution corresponding to exposure condition of Fig. 3, and (b) H-field distribution corresponding to exposure condition of Fig. 3.**

The SAR distribution in the passenger model in the exposure condition with UHF mobile radio roof-mount antennas that gave highest 1-g SAR is reported in Fig. 5 (425 MHz, passenger on the side of the back seat, HAE6013A antenna).

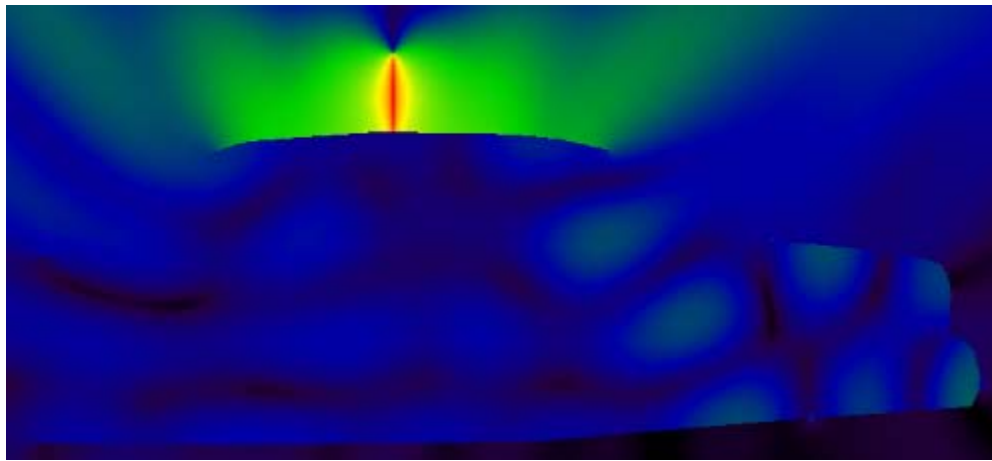


**Figure 5. SAR distribution at 425 MHz in the passenger located on the side of the back seat, produced by the roof-mount HAE6013A antenna. The contour plot in the figure is relative to the plane where the peak 1-g average SAR for this exposure condition occurs.**

As in previous case the two following pictures below show the E and H field distributions in the plane of the antenna corresponding to the condition represented in Fig 5.



(a)



(b)

**Figure 6. (a) E-field distribution corresponding to exposure condition of Fig. 5, and (b) H-field distribution corresponding to exposure condition of Fig. 5.**

## Conclusions

Under the test conditions described for evaluating passenger and bystander exposure to the RF electromagnetic fields emitted by vehicle-mounted antennas used in conjunction with this mobile radio product, the present analysis shows that the computed SAR values are compliant with the FCC exposure limits for the general public.

## References

- [1] IEEE Standard C95.1-1999. *IEEE Standard for Safety Levels with Respect to Human Exposure to RF Electromagnetic Fields, 3 kHz to 300 GHz.*
- [2] [http://www.nlm.nih.gov/research/visible/visible\\_human.html](http://www.nlm.nih.gov/research/visible/visible_human.html)

## APPENDIX: SPECIFIC INFORMATION FOR SAR COMPUTATIONS

This appendix follows the structure outlined in Appendix B.III of the Supplement C to the FCC OET Bulletin 65. Most of the information regarding the code employed to perform the numerical computations has been adapted from the XFDTD™ v5.3 and v6.3 User Manuals. Remcom Inc., owner of XFDTD™, is kindly acknowledged for the help provided.

### 1) Computational resources

- a) A distributed Linux based multi-CPU computer cluster equipped with AMD 64-bit Opteron processors was employed for all simulations.
- b) The memory requirement was close to 3 GB in all cases. Using the above-mentioned system with four processors operating concurrently, the typical simulation would run for 2 hours.

### 2) FDTD algorithm implementation and validation

- a) We employed a commercial code (XFDTD™ v6.3, by Remcom Inc.) that implements the Yee's FDTD formulation [1]. The solution domain was discretized according to a rectangular grid with a uniform 5 mm step in all directions. Sub-gridding was not used. Liao's absorbing boundary conditions [2] are set at the domain boundary to simulate free space radiation processes. The excitation is a lumped voltage generator with 50-ohm source impedance. The code allows selecting *wire objects* without specifying their radius. We used a wire to represent the antenna. The car body is modeled by solid metal. We did not employ the "thin wire" algorithm in XFDTD™ since the antenna radius was never smaller than one-fifth the voxel dimension. In fact, the XFDTD™ manual specifies that "Thin Wire materials may be used in special situations where a wire with a radius much smaller than the cell size is required... in cases where the wire radius is important to the calculation and is less than approximately 1/5 the cell size, the thin wire material may be used to accurately simulate the correct wire dimensions." The voxel size in all our simulations was 5 mm, and the antenna radius is always at least 1 mm (1 mm for the short quarter-wave antennas and 1.5 mm for the long gain antennas), so there was no need to specify a "thin wire" material. Because the field impinges on the bystander or passenger model at a distance of several tens of voxels from the antenna, the details of antenna wire modeling are not expected to have significant impact on the exposure level.
- b) XFDTD™ is one of the most widely employed commercial codes for electromagnetic simulations. It has gone through extensive validation and has proven its accuracy over time in many different applications. One example is provided in [3].

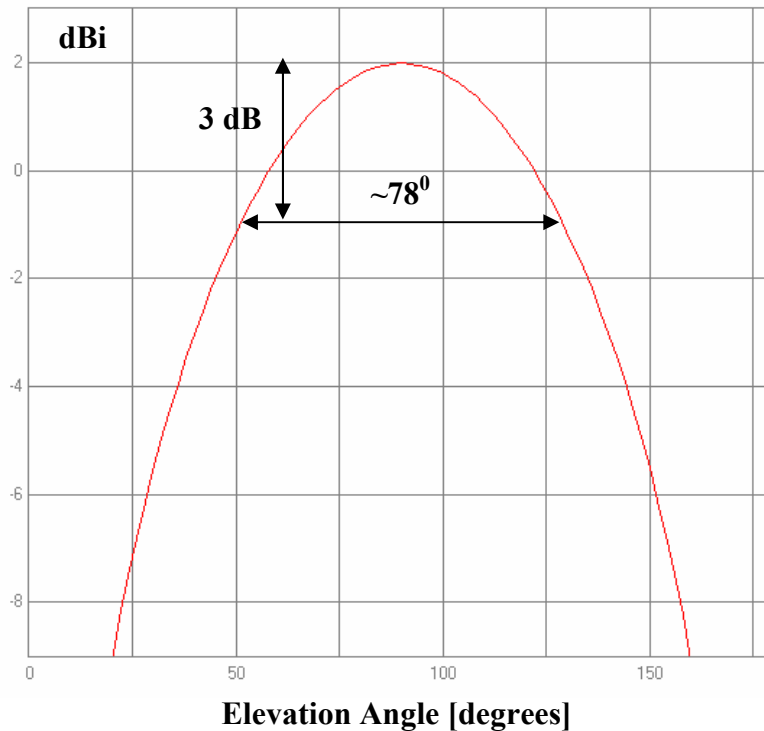
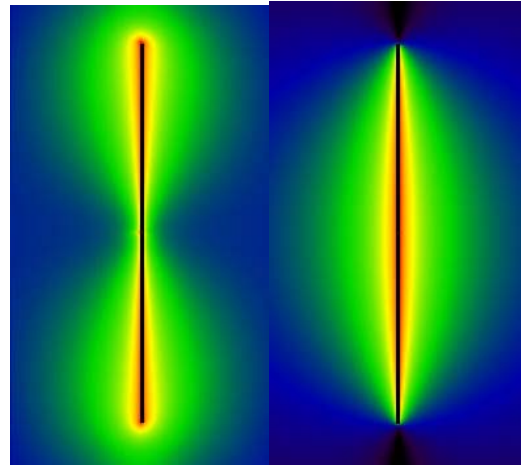
We carried out a validation of the code algorithm by running the canonical test case involving a half-wave wire dipole. The dipole is 0.475 times the free space wavelength at 160 MHz, i.e., 88.5 cm long. The discretization used in the model was uniform in all directions and equal to 5 mm, so the dipole was 177 cells long. Also in this case, the "thin

wire” model was not needed. The following picture shows XFDTD™ outputs regarding the antenna feed-point impedance ( $72.6 - j 11.6$  ohm), as well as qualitative distributions of the total E and H fields near the dipole. The radiation pattern is shown as well (one lobe in elevation). As expected, the 3 dB beamwidth is about 78 degrees.

**Total  
E-field**

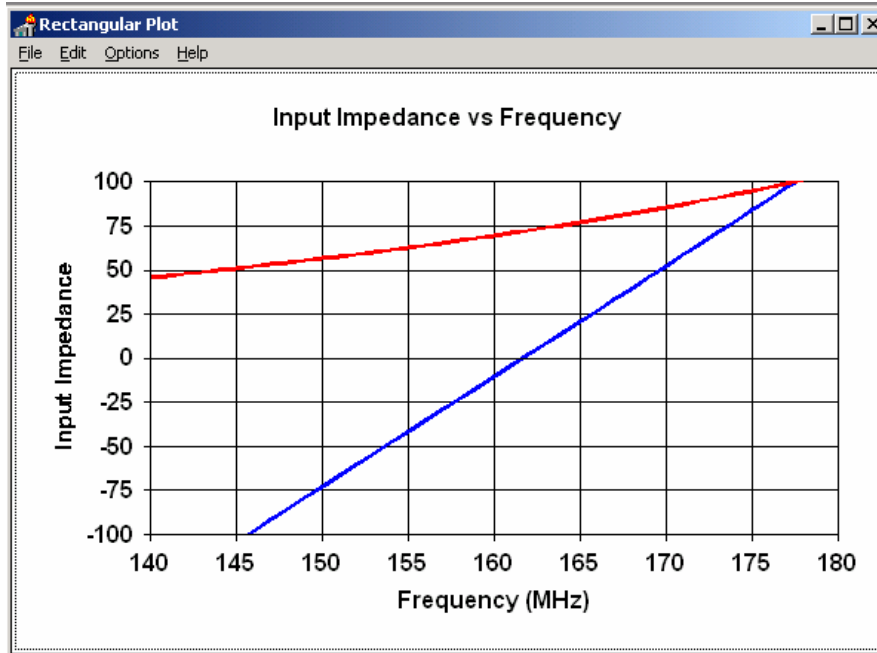
**Total  
H-field**

Complex Feed Point Impedance (Ohms)			
Feed	Real	Imaginary	
1	72.553001	-11.623300	



We also compared the XFDTD™ result with the results derived from NEC [4], which is a code based on the method of moments. In this case, we used a dipole with radius 1

mm, length 88.5 cm, and the discretization is 5 mm. The corresponding input impedance at 160 MHz is  $69.5-j10.5$  ohm. Its frequency dependence is reported in the following figure.



This validation ensures that the input impedance calculation is carried out correctly in XFDTD™, thereby enabling accurate estimates of the radiated power. It further ensures that the wire model employed in XFDTD™, which we used to model the antennas, produces physically meaningful current and fields distributions. Both these aspects ensure that the field quantities are correctly computed both in terms of absolute amplitude and relative distribution.

### 3) Computational parameters

a) The following table reports the main parameters of the FDTD model employed to perform our computational analysis:

PARAMETER	X	Y	Z
Voxel size	5 mm	5 mm	5 mm
Maximum domain dimensions employed for passenger computations with the roof-mount antennas	387	737	342
Maximum domain dimensions employed for passenger computations with the trunk-mount antennas	387	737	256
Time step	Exactly equal to Courant limit (typically 10 ps at this frequency, with the body model)		
Objects separation from FDTD boundary (voxels)	>10	>10	>10
Number of time steps for passenger at VHF frequencies	At least 6000 in all simulations		
Number of time steps for passenger at UHF frequencies	At least 3000 in all simulations		
Excitation	Sinusoidal (not less than 9-10 periods)		

#### 4) Phantom model implementation and validation

a) The FDTD mesh of a male human body was created using digitized data in the form of transverse color images. The data is from the *visible human project* sponsored by the National Library of Medicine (NLM) and is available via the Internet ([http://www.nlm.nih.gov/research/visible/visible\\_human.html](http://www.nlm.nih.gov/research/visible/visible_human.html)). The male data set consists of MRI, CT and anatomical images. Axial MRI images of the head and neck and longitudinal sections of the rest of the body are available at 4 mm intervals. The MRI images have 256 pixel by 256 pixel resolution. Each pixel has 12 bits of gray tone resolution. The CT data consists of axial CT scans of the entire body taken at 1 mm intervals at a resolution of 512 pixels by 512 pixels where each pixel is made up of 12 bits of gray tone. The axial anatomical images are 2048 pixels by 1216 pixels where each pixel is defined by 24 bits of color. The anatomical cross sections are also at 1 mm intervals and coincide with the CT axial images. There are 1871 cross sections. The XFDTD™ High Fidelity Body Mesh uses 5x5x5 mm cells and has dimensions 136 x 87 x 397. Dr. Michael Smith and Dr. Chris Collins of the Milton S. Hershey Medical Center, Hershey, Pa, created the High Fidelity Body mesh. Details of body model creation are given in the *methods* section in [5]. The body mesh contains 23 tissues materials. Measured values for the tissue parameters for a broad frequency range are included with the mesh data. The correct values are interpolated from the table of measured data and entered into the appropriate mesh variables. The tissue conductivity and permittivity variation vs. frequency is included in the XFDTD™ calculation by a multiple-pole approximation to the Cole-Cole approximated tissue parameters reported by Camelia Gabriel, Ph.D., and Sami Gabriel, M. Sc. (<http://www.brooks.af.mil/AFRL/HED/hedr/reports/dielectric/home.html>).

a) The XFDTD™ High Fidelity Body Mesh model correctly represents the anatomical structure and the dielectric properties of body tissues, so it is appropriate for determining the highest exposure expected for normal device operation.

b) One example of the accuracy of XFDTD™ for computing SAR has been provided in [6]. The study reported in [6] is relative to a large-scale benchmark of measurement and computational tools carried out within the IEEE Standards Coordinating Committee 34, Sub-Committee 2.

#### 5) Tissue dielectric parameters

a) The following table reports the dielectric properties used by XFDTD™ for the 23 body tissue materials in the High Fidelity Body Mesh at 450 MHz.

#	Tissue	$\epsilon_r$	$\sigma$ (S/m)	Density (kg/m <sup>3</sup> )
1	skin	41.5	0.57	1125
2	tendon, pancreas, prostate, aorta, liver, other	50.3	0.76	1151
3	fat, yellow marrow	5.02	0.05	943

4	cortical bone	13.4	0.11	1850
5	cancellous bone	21.0	0.23	1080
6	blood	57.2	1.72	1057
7	muscle, heart, spleen, colon, tongue	63.5	0.99	1059
8	gray matter, cerebellum	54.1	0.88	1035.5
9	white matter	39.7	0.54	1027.4
10	CSF	68.9	2.32	1000
11	sclera/cornea	54.4	1.04	1151
12	vitreous humor	68.3	1.56	1000
13	bladder	17.6	0.31	1132
14	nerve	35.5	0.50	1112
15	cartilage	43.4	0.66	1171
16	gall bladder bile	76.5	1.62	928
17	thyroid	59.8	0.82	1035.5
18	stomach/esophagus	74.4	1.13	1126
19	lung	52.8	0.72	563
20	kidney	57.0	1.16	1147
21	testis	65.2	1.13	1158
22	lens	51.9	0.71	1163
23	small intestine	73.7	2.07	1153

Similarly, the table below reports the tissue dielectric properties at 155 MHz (mid-band for this VHF mobile radio product).

#	Tissue	$\epsilon_r$	$\sigma$ (S/m)	Density (kg/m <sup>3</sup> )
1	skin	50.5	0.49	1125
2	tendon, pancreas, prostate, aorta, liver, other	59.3	0.63	1151
3	fat, yellow marrow	5.8	0.04	943
4	cortical bone	15.5	0.08	1850
5	cancellous bone	26.0	0.17	1080
6	blood	64.5	1.65	1057
7	muscle, heart, spleen, colon, tongue	73.6	0.84	1059
8	gray matter, cerebellum	71.5	0.73	1035.5
9	white matter	51.4	0.41	1027.4
10	CSF	73.9	2.29	1000
11	sclera/cornea	61.8	0.94	1151
12	vitreous humor	68.6	1.52	1000
13	bladder	19.1	0.28	1132
14	nerve	44.0	0.41	1112
15	cartilage	53.8	0.53	1171
16	gall bladder bile	86.6	1.49	928
17	thyroid	65.9	0.71	1035.5
18	stomach/esophagus	78.5	1.03	1126
19	lung	52.3	0.59	563



20	kidney	72.9	1.02	1147
21	testis	72.6	0.99	1158
22	lens	57.3	0.61	1163
23	small intestine	89.5	1.85	1153

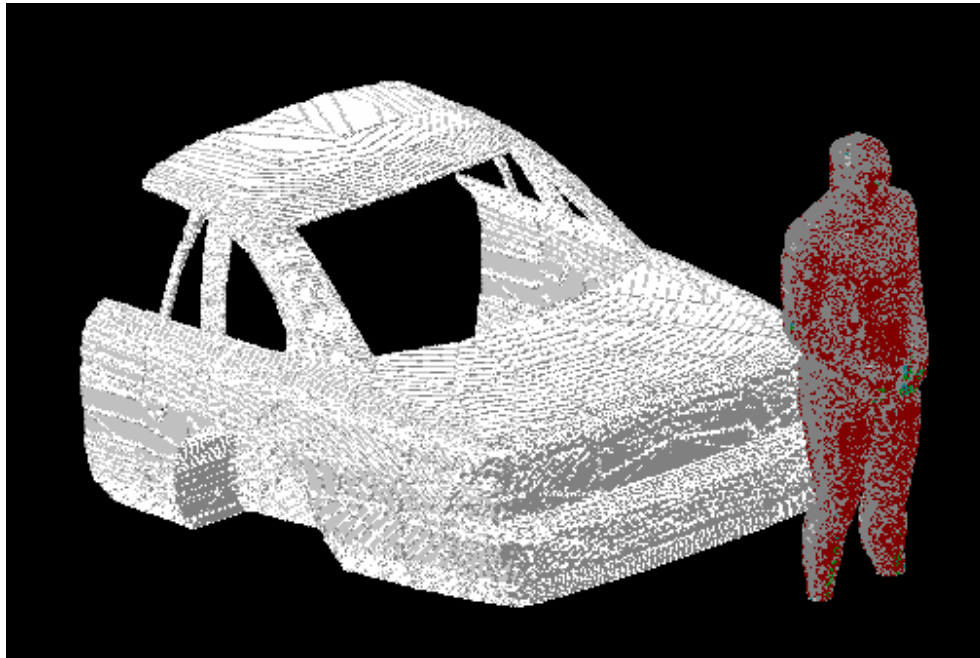
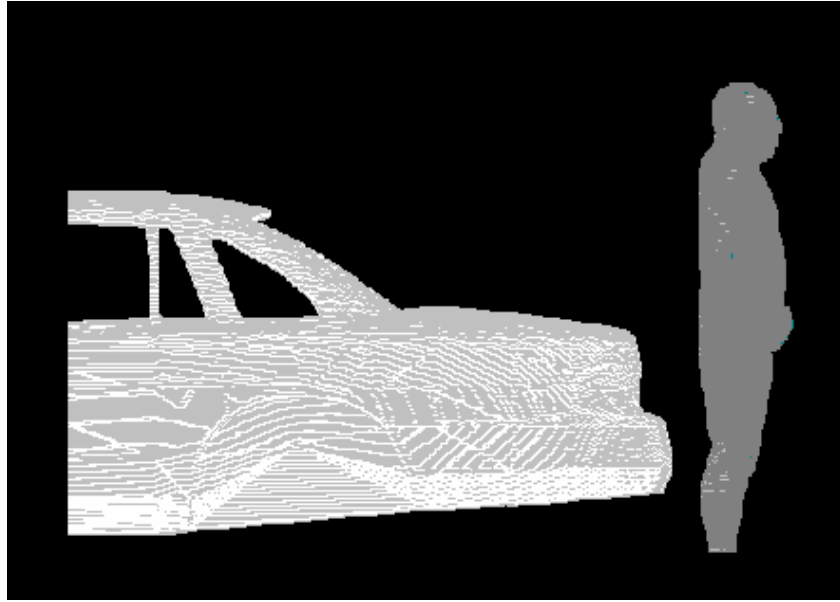
b) The tissue types and dielectric parameters used in the SAR computation are appropriate for determining the highest exposure expected for normal device operation, because they are derived from measurements performed on real biological tissues (<http://www.brooks.af.mil/AFRL/HED/hedr/reports/dielectric/home.html>).

c) The tabulated list of the dielectric parameters used in phantom models is provided at point 5(a). As regards the device (car plus antenna), we used perfect electric conductors.

## 6) Transmitter model implementation and validation

a) The essential features that must be modeled correctly for the particular test device model to be valid are:

- Car body. We developed one very similar to the car used for MPE measurements, so as to be able to correlate measured and simulated field values. The model was imported in XFDTD™ from a CAD model that is commercially available at <http://www.3dcadbrowser.com/>
- Antenna. We used a straight wire, even when the gain antenna has a base coil for tuning. All the coil does is compensating for excess capacitance due to the antenna being slightly longer than half a wavelength. We do not need to do that in the model, as we used normalization with respect to the net radiated power, which is determined by the input resistance only. In this way, we neglect mismatch losses and artificially produce an overestimation of the SAR, thereby introducing a conservative bias in the model. In case of low profile vertical monopole antenna (HAE6016A) which has an additional horizontal metal circular disk at the tip, the disk was included in the model and well represented in 5 mm resolution mesh.
- Antenna location. We used the same location, relative to the edge of the car trunk, the backseat, or the roof, used in the MPE measurements. The following pictures show a lateral and a perspective view of the whole model (XFDTD™ does not show wires in this type of view, that is why the antenna is not visible).

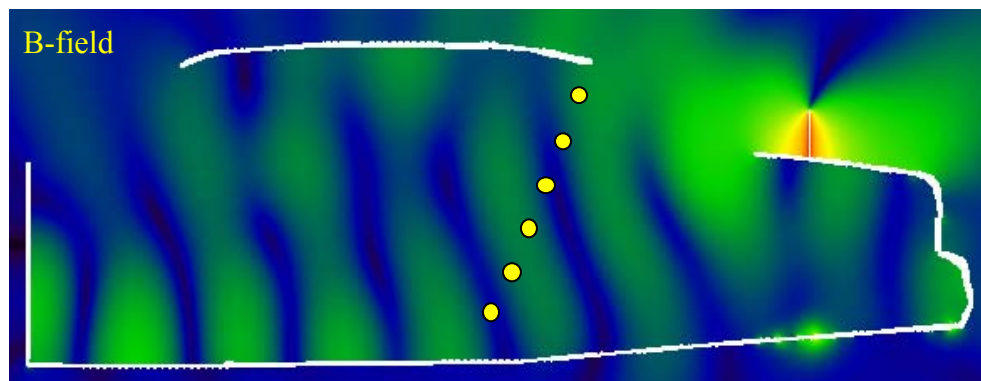
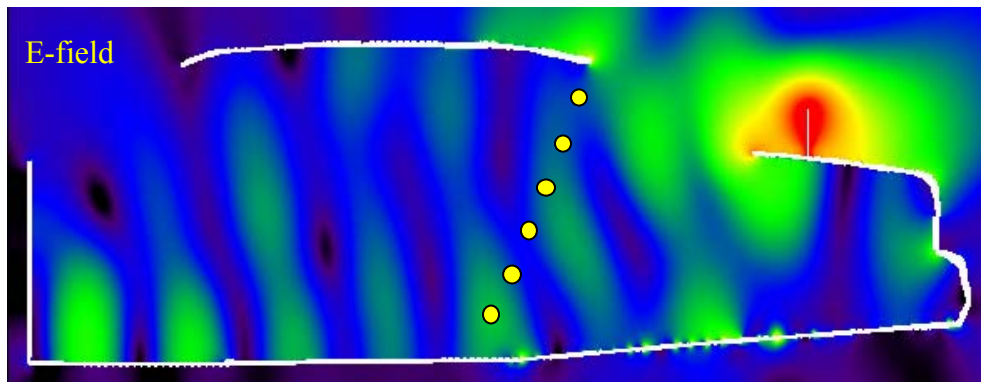


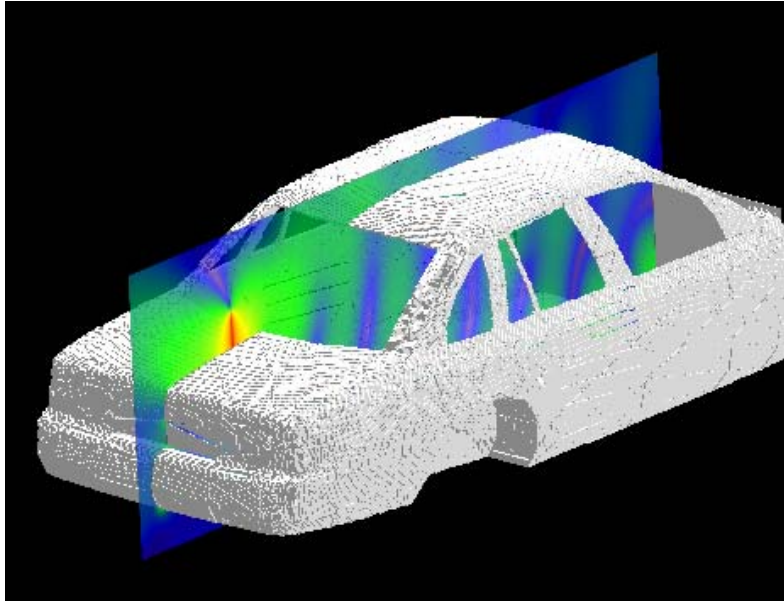
The car model is constituted by perfect electric conductor and does not include wheels in order to reduce its complexity. The passenger model is surrounded by air, as the seat, which is made out of poorly conductive fabrics, is not included in the computational model. The pavement has not been included in the model. The passenger and bystander models were validated for similar antenna and frequency conditions by comparing the MPE measurements at two VHF frequencies (146 MHz and 164 MHz) for antennas used for a VHF mobile radio analyzed previously in 2003 (FCC ID#ABZ99FT3046). The corresponding MPE measurements are reported in the compliance report relative to FCC ID#ABZ99FT3046. The comparison results are presented below, according to following definitions for the equivalent power densities (based on E or H-field):

$$S_E = \frac{|\mathbf{E}|^2}{2\eta}, \quad S_H = \frac{\eta}{2} |\mathbf{H}|^2, \quad \eta = 377 \Omega$$

Passenger with 17.5 cm monopole antenna (HAE4002A 421.5 MHz)

The following figure of the test model shows the car model, where the yellow dots individuate the back seat, as it can be observed from the other figure showing the cross section of the passenger. The comparison has been performed by taking the average of the computed steady-state field values at the six dotted locations, corresponding to the head, chest, and legs along the yellow dots line, and comparing them with the average of the MPE measurements performed at the head, chest and legs locations. Such a comparison is carried out at the same rms power level (22 W, including the 50% duty factor) used in the MPE measurements.





The equivalent power density (S) is computed from the E-field and the H-field separately. The following table reports the E-field values computed by XFDTD™ at the six locations, and the corresponding power density.

Location Number	E-field, V/m	Eq. Power Density 1.0 V source	Scaled Power Dens. 22 W output, mW/cm <sup>2</sup>
1	5.83E-01	4.51E-04	4.41E-01
2	6.31E-01	5.28E-04	5.16E-01
3	6.50E-01	5.60E-04	5.48E-01
4	5.50E-01	4.01E-04	3.92E-01
5	4.50E-01	2.69E-04	2.63E-01
6	7.80E-01	8.07E-04	7.89E-01
Equivalent average Power Density			<b>4.92E-01</b>

Location Number	B-field, Weber/m <sup>2</sup>	Eq. Power Density 1.0 V source	Scaled Power Dens. 22 W output, mW/cm <sup>2</sup>
1	2.26E-09	0.00061	5.96E-01
2	9.00E-10	0.00010	9.45E-02
3	1.20E-09	0.00017	1.68E-01
4	2.20E-09	0.00058	5.65E-01
5	1.90E-09	0.00043	4.21E-01
6	9.00E-10	0.00010	9.45E-02
Equivalent average Power Density			<b>3.23E-01</b>

The input impedance is  $36.2+j24.8$  ohm, therefore the radiated power (considering the mismatch to the 50 ohm unitary voltage source) is  $2.25E-3$  W, therefore a factor equal to 9779 is required to scale up to 22 W radiated. The corresponding scaled-up power densities are reported in the tables above, which show that the simulation overestimates the average power density from the MPE measurements ( $0.29$  mW/cm<sup>2</sup>), as derived from the measured E-field reported in the following table:

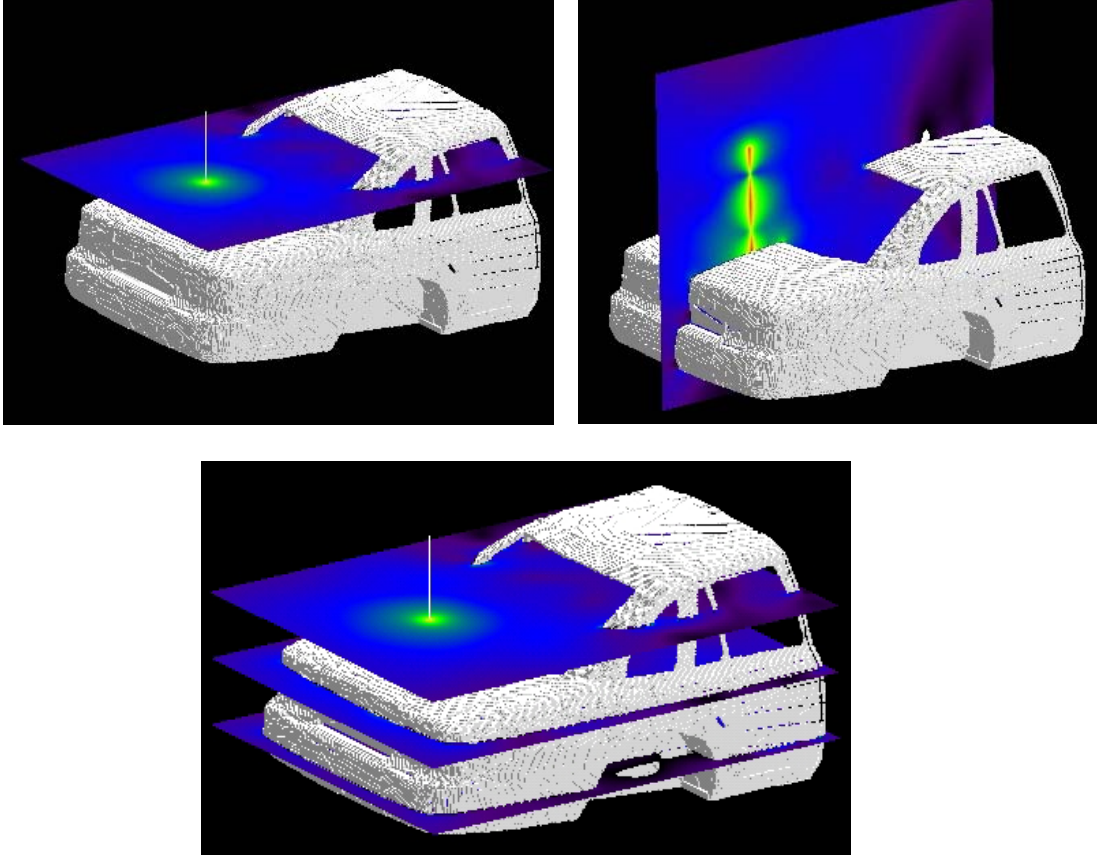
Position	SE (meas), 22 W output mW/cm <sup>2</sup>
Head	0.38
Chest	0.33
Lower Trunk	0.16

The simulations tend to overestimate the average power density levels, which is understandable since there are no ohmic losses and perfect impedance matching is enforced in the computational models. Based on these results, we conclude that the simulation will produce slight exposure overestimates (about 12%).

- b) Descriptions and illustrations showing the correspondence between the modeled test device and the actual device, with respect to shape, size, dimensions and near-field radiating characteristics, are found in the main report.
- c) Verification that the test device model is equivalent to the actual device for predicting the SAR distributions descends from the fact that the car and antenna size and location in the numerical model correspond to those used in the measurements.
- d) The peak SAR is in the neck region for the passenger, which is in line with MPE measurements and predictions.

Passenger with 63.5 cm monopole antenna (HAE6010A 425 MHz)

The following figures show the car model with the field distribution in the horizontal planes where the MPE measurements have been performed. The comparison has been performed by taking the average of the computed steady-state field values at the three locations, corresponding to the head, chest, and lower trunk, and comparing them with the average of the MPE measurements performed at the head, chest and lower trunk locations. Such a comparison is carried out at the same rms power level (61.5 W, including the 50% duty factor) used in the MPE measurements.



The equivalent power density (S) is computed from the E-field. The following table reports the E-field values computed by XFDTD™ at the three locations, and the corresponding power density.

Location Number	E-field, V/m	Eq. Power Density 1.0 V source	Scaled Power Dens. 61.5 W output, mW/cm <sup>2</sup>
1	2.10E-01	5.85E-05	0.561
2	3.66E-01	1.78E-04	1.70
3	1.72E-01	3.92E-04	0.376
Equivalent average Power Density			<b>0.88</b>

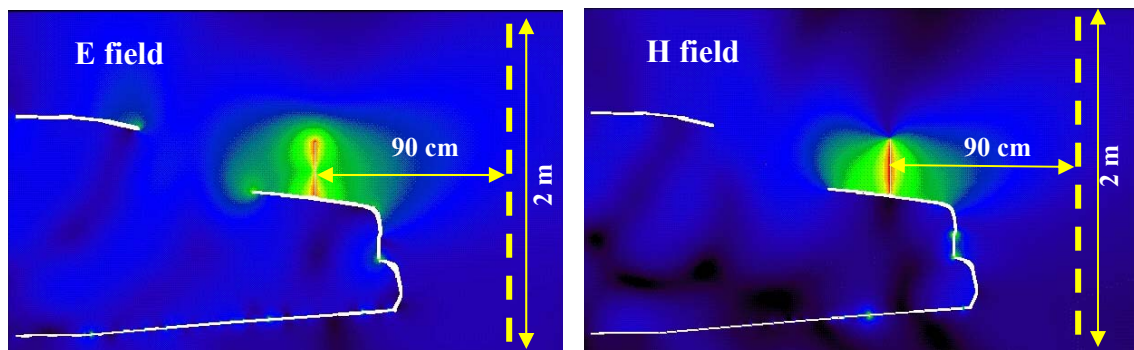
The corresponding scaled-up power densities are reported in the tables above, which show that the simulation overestimates the average power density from the MPE measurements (0.52 mW/cm<sup>2</sup>), as derived from the measured E-field reported in the following table:

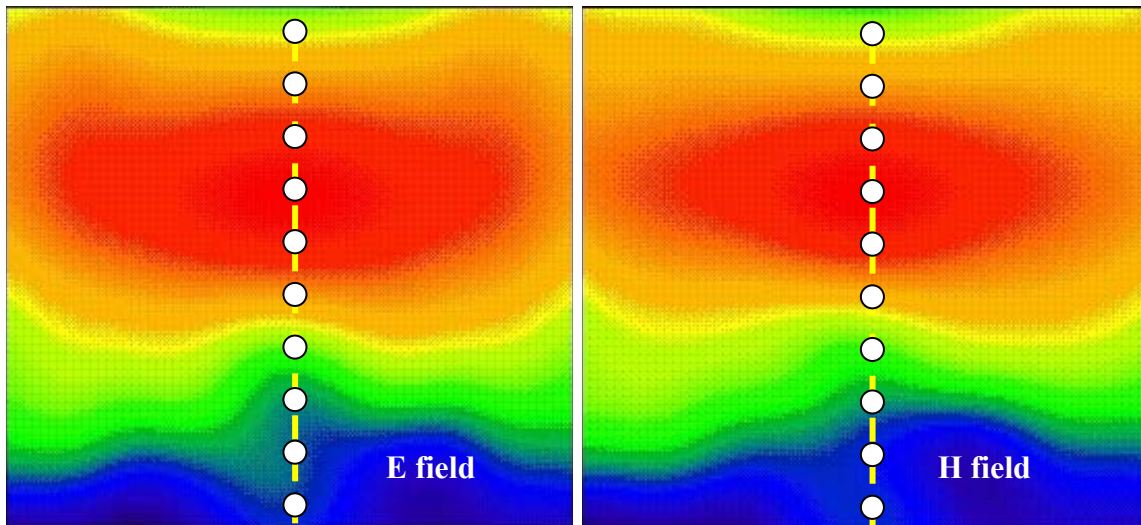
Position	SE (meas), 60 W output mW/cm <sup>2</sup>
Head	0.72
Chest	0.64
Lower Trunk	0.19

The simulations tend to overestimate the average power density levels, which is understandable since there are no ohmic losses and perfect impedance matching is enforced in the computational models. Based on these results, we conclude that the simulation will produce exposure overestimates (about 69%).

Bystander with 29 cm monopole antenna (HAE6013A 425 MHz)

The following figures show the E-field and H-field distributions across a vertical plane passing for the antenna and cutting the car in half. As done in the measurements, the MPE is computed from both E-field and H-field distributions, along the yellow dotted line at 10 points spaced 20 cm apart from each other up to 2 m in height. These lines and the field evaluation points are approximately indicated in the figures. The E-field and H-field distributions in the vertical plane placed at 90 cm from the antenna, behind the case, are shown as well. The points where the fields are sampled to determine the equivalent power density (S) are approximately indicated by the white dots. A picture of the antenna is not reported because it is identical to the HAE6013A.



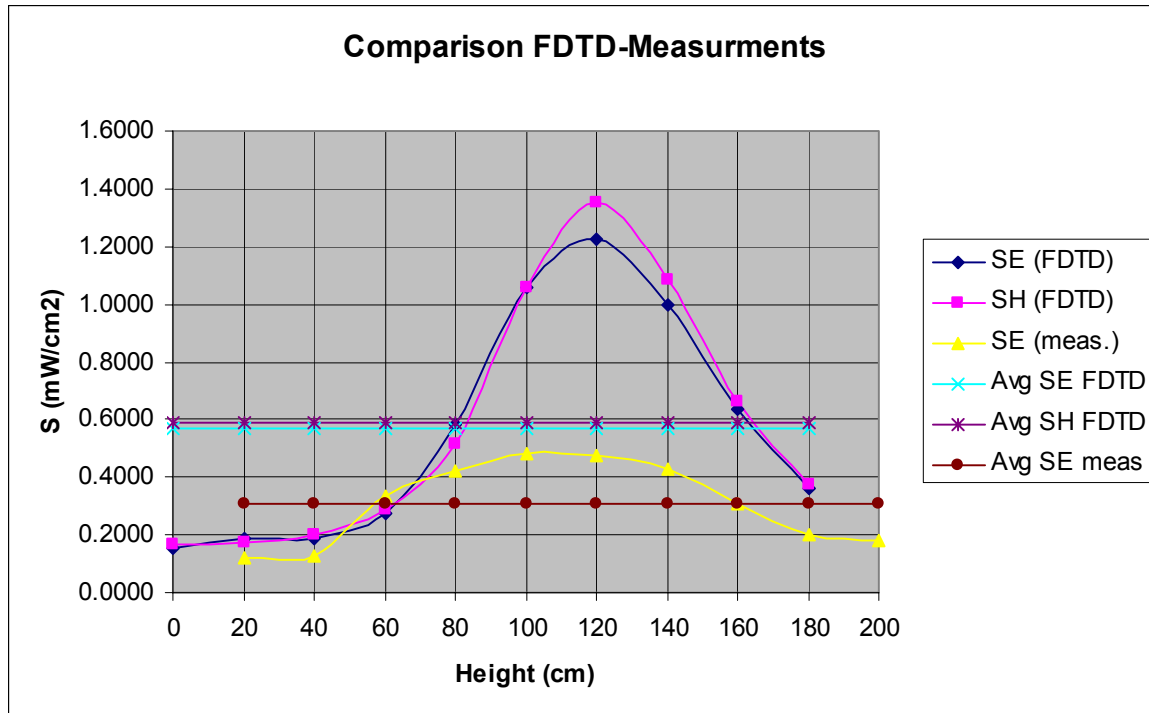


The following table reports the field values computed by XFDTD™ and the corresponding power density values. The average exposure levels are computed as well.

Height (cm)	E (V/m)	$S_E$ (W/m <sup>2</sup> )	H (A/m)	$S_H$ (W/m <sup>2</sup> )
0	1.05E-01	1.46E-05	2.90E-05	1.589E-05
20	1.14E-01	1.72E-05	2.90E-05	1.598E-05
40	1.16E-01	1.78E-05	3.14E-05	1.871E-05
60	1.39E-01	2.56E-05	3.75E-05	2.669E-05
80	2.03E-01	5.47E-05	5.03E-05	4.795E-05
100	2.73E-01	9.88E-05	7.23E-05	9.923E-05
120	2.94E-01	1.15E-04	8.17E-05	1.266E-04
140	2.65E-01	9.31E-05	7.32E-05	1.016E-04
160	2.12E-01	5.96E-05	5.73E-05	6.219E-05
180	1.60E-01	3.40E-05	4.32E-05	3.531E-05
<b>Average <math>S_E</math></b>		<b>5.302E-05</b>	<b>Average <math>S_H</math></b>	<b>5.501E-05</b>

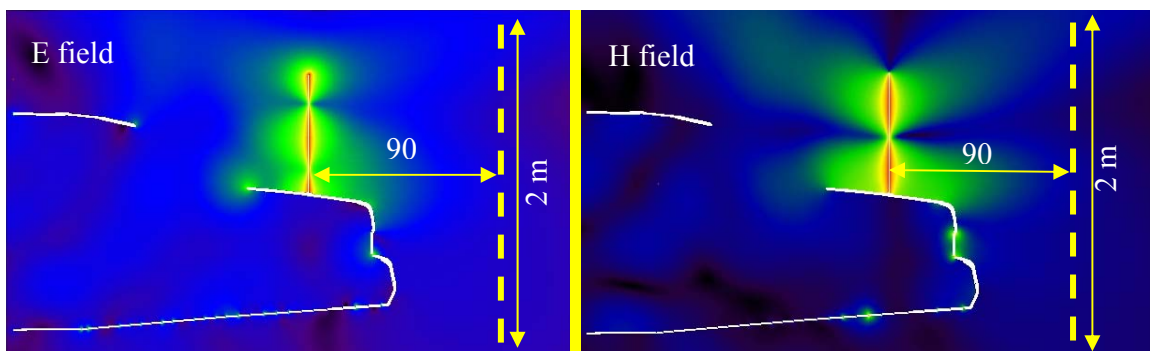
Since the conducted power during the MPE measurement was 123 W the calculated power density was then scaled up for 61.5 W radiated power (taking into account 50% talk time). This model does not include the mismatch loss, loss in the cable and finite conductivity of the car surface and as represents a conservative model for exposure assessment. The scaled-up power density values for 61.5 W radiated power are 5.67 W/m<sup>2</sup> (E), and 5.88 W/m<sup>2</sup> (H), that correspond to 0.57 mW/cm<sup>2</sup> (E), and 0.59 mW/cm<sup>2</sup> (H). Measurements yielded average power density of 0.309 mW/cm<sup>2</sup> (E), which shows that the calculated power density is overestimated. The following graph shows a comparison between the measured power density and the simulated one, based on E or H fields, normalized to 61.5 W radiated power.

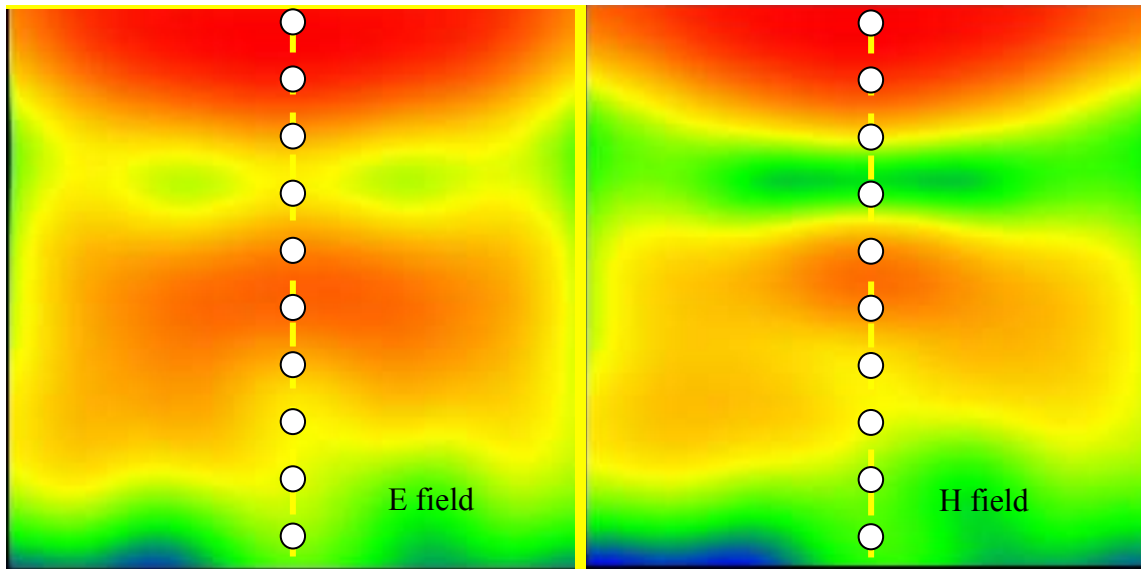




Bystander with 63.5 cm monopole antenna (HAE6010A 425 MHz)

The following figures show the E-field and H-field distributions across a vertical plane passing for the antenna and cutting the car in half. As done in the measurements, the MPE is computed from both E-field and H-field distributions, along the yellow dotted line at 10 points spaced 20 cm apart from each other up to 2 m in height. These lines and the field evaluation points are approximately indicated in the figures. The E-field and H-field distributions in the vertical plane placed at 90 cm from the antenna, behind the case, are shown as well. The points where the fields are sampled to determine the equivalent power density (S) are approximately indicated by the white dots. A picture of the antenna is not reported because it is identical to the HAE6010A.



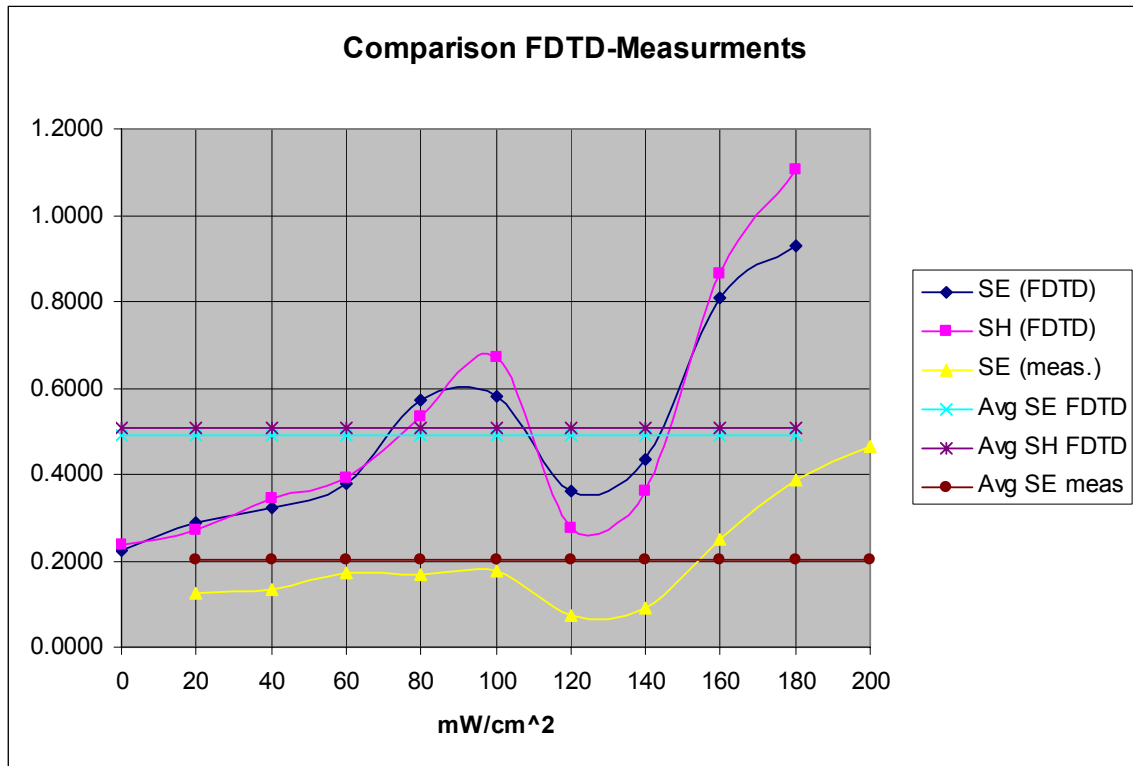


The following table reports the field values computed by XFDTD™ and the corresponding power density values. The average exposure levels are computed as well.

Height (cm)	E (V/m)	S <sub>E</sub> (W/m <sup>2</sup> )	H (A/m)	S <sub>H</sub> (W/m <sup>2</sup> )
0	1.32E-01	2.31E-05	4.51E-10	2.43E-05
20	1.49E-01	2.94E-05	4.82E-10	2.77E-05
40	1.58E-01	3.31E-05	5.44E-10	3.53E-05
60	1.71E-01	3.88E-05	5.79E-10	4.00E-05
80	2.10E-01	5.85E-05	6.78E-10	5.48E-05
100	2.12E-01	5.96E-05	7.60E-10	6.89E-05
120	1.67E-01	3.70E-05	4.86E-10	2.82E-05
140	1.83E-01	4.44E-05	5.57E-10	3.70E-05
160	2.50E-01	8.29E-05	8.62E-10	8.86E-05
180	2.68E-01	9.53E-05	9.75E-10	1.13E-04
<b>Average S<sub>E</sub></b>		<b>5.38E-05</b>	<b>Average S<sub>H</sub></b>	<b>5.18E-05</b>

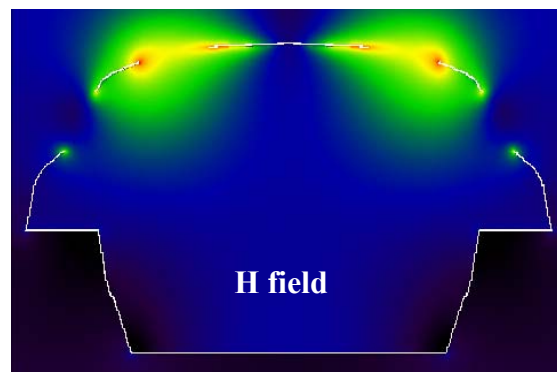
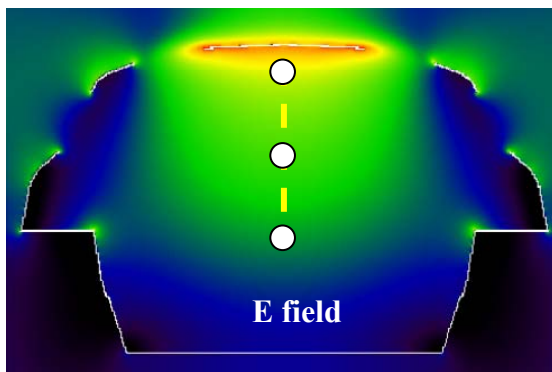
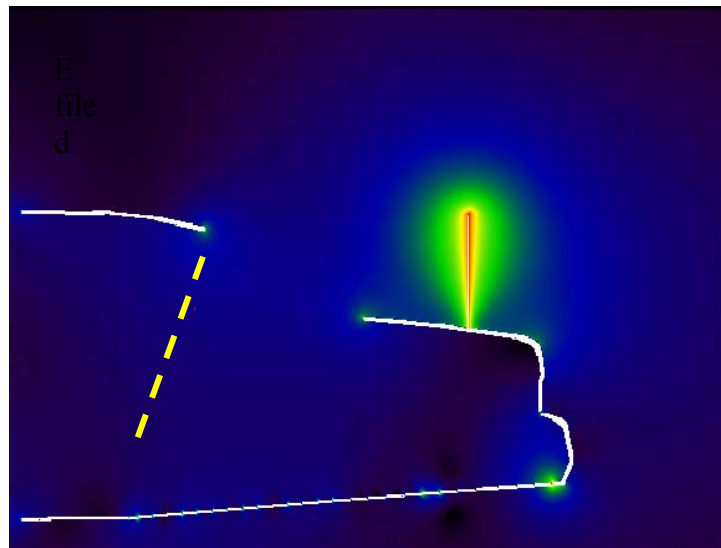
Since the conducted power during the MPE measurement was 123 W the calculated power density was then scaled up for 61.5 W radiated power (taking into account 50% talk time). This model does not include the mismatch loss, loss in the cable and finite conductivity of the car surface and as represents a conservative model for exposure assessment. The scaled-up power density values for 61.5 W radiated power are 5.25 W/m<sup>2</sup> (E), and 5.06 W/m<sup>2</sup> (H), that correspond to 0.52 mW/cm<sup>2</sup> (E), and 0.51 mW/cm<sup>2</sup> (H). Measurements yielded average power density of 0.204 mW/cm<sup>2</sup> (E), which shows that the calculated power density is overestimated. The following graph shows a comparison between the measured power density and the simulated one, based on E or H

fields, normalized to 61.5 W radiated power.



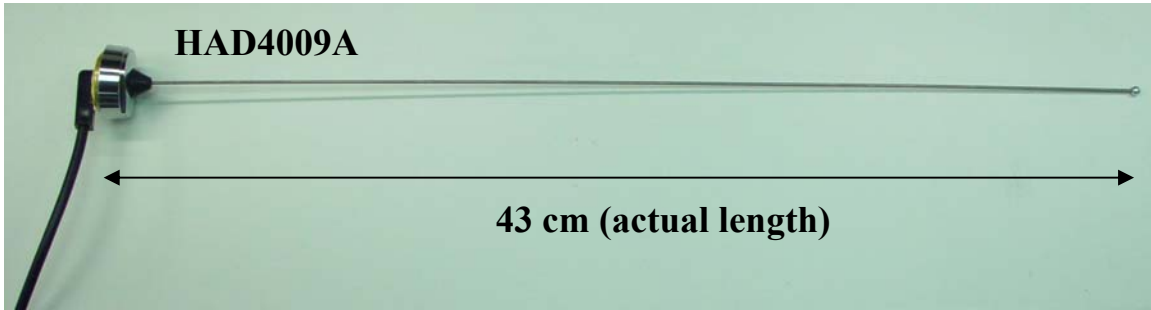
Passenger with 43 cm monopole antenna (HAD4009A 164 MHz)

The following figures of the test model show the empty car model, where the yellow dotted line represents the back seat, as it can be observed from the right-hand side figure showing the passenger. The comparison has been performed by taking the computed steady-state field values at the locations corresponding to the head, chest, and legs along the yellow line and comparing them with the corresponding measurements. Such a comparison is carried out at the same rms power level (56.5 W) used in the measurements. Steady-state E-field and H-field distributions at a vertical plane transverse to the car and crossing the passenger's head are displayed as well. Finally, a picture of the antenna is shown.



The highest exposure occurs in the middle of the backseat, which is also the case in the measurements. Therefore, the field values were determined on the yellow line centered at the middle of the backseat, approximately at the three locations that are shown by white dots. In actuality, the line is inclined so as to follow the inclination of the passenger's

back, as shown previously.



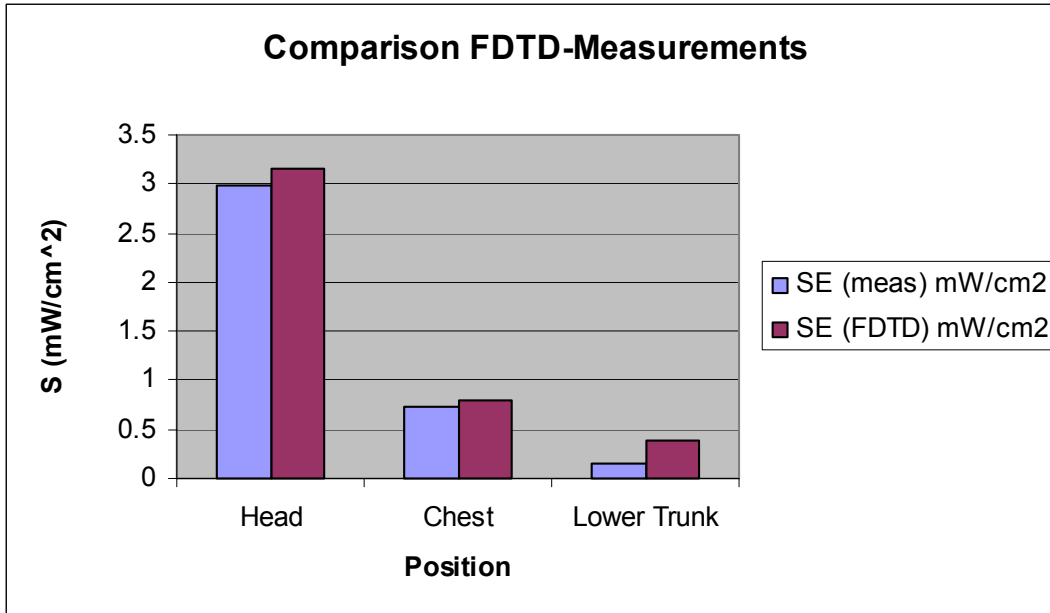
Because the peak exposure occurs in the center of the back seat, that was where we placed the passenger model to perform the SAR evaluations presented in the report. However, it can be observed that the H-field distribution features peaks near the lateral edges of the rear window. That is the reason why we also carried out one SAR computation by placing the passenger laterally in the back seat, in order to determine whether the SAR would be higher in this case.

As done in the measurements, the equivalent power density (S) is computed from the E-field, the H-field being much lower. The following table reports the E-field values computed by XFDTD™ at the three locations, and the corresponding power density.

Location	E-field magnitude (V/m)	S (W/m <sup>2</sup> )
Head	1.10	1.33E-03
Chest	0.70	3.32E-04
Lower Trunk area	0.52	1.62E-04
<b>Average S</b>		<b>6.07E-04</b>

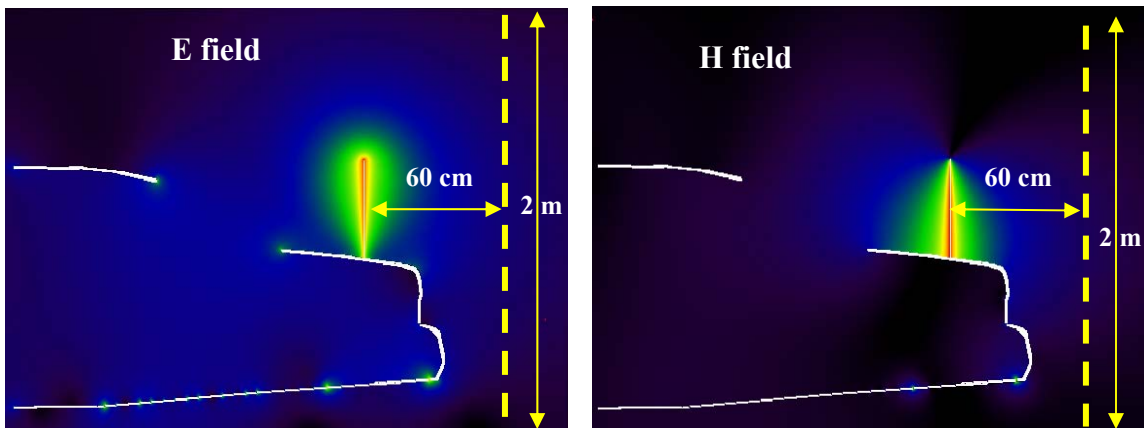
The input impedance is 32.4-j4.8 ohm, therefore the radiated power (considering the mismatch to the 50 ohm unitary voltage source) is 2.38E-3 W. The scaled-up power density for 56.5 W radiated power is 14.4 W/m<sup>2</sup>, corresponding to 1.44 mW/cm<sup>2</sup>. Measurements gave an average of 1.29 mW/cm<sup>2</sup>, which is in agreement considering conservativeness of simulations model. The following table and the graph show a comparison between the simulated power density and the measured one (see also MPE report in FCC ID#ABZ99FT3046, Table 43), normalized to 56.5 W radiated.

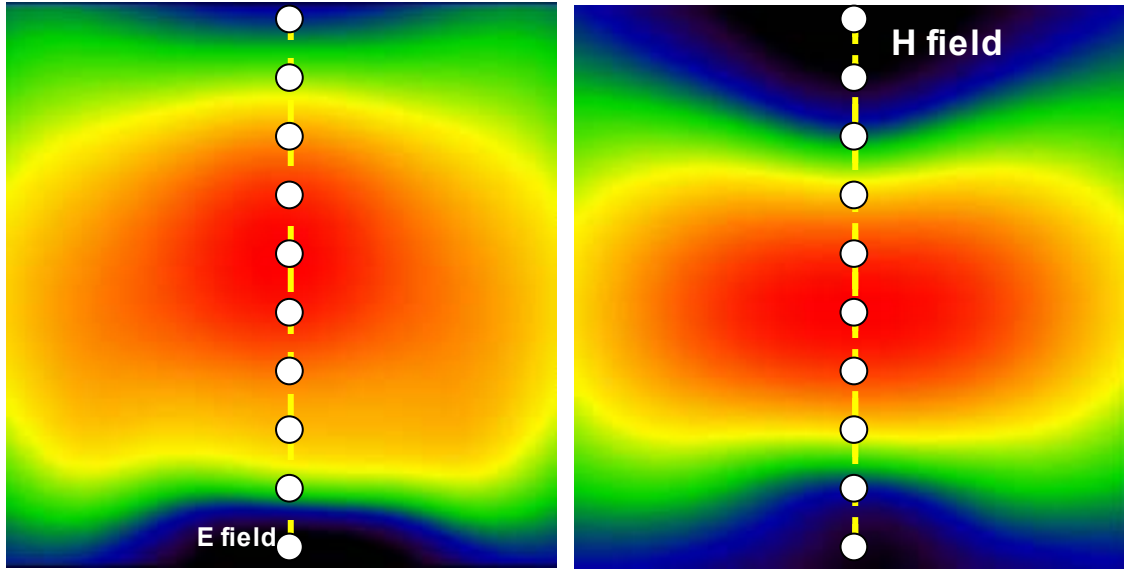
Position	SE (meas) mW/cm <sup>2</sup>	SE (FDTD) mW/cm <sup>2</sup>
Head	2.98	3.15
Chest	0.74	0.79
Lower Trunk	0.14	0.39



Bystander with 48 cm monopole antenna (HAD4007A 146 MHz)

The following figures show the E-field and H-field distributions across a vertical plane passing for the antenna and cutting the car in half. As done in the measurements, the MPE is computed from both E-field and H-field distributions, along the yellow dotted line at 10 points spaced 20 cm apart from each other up to 2 m in height. These lines and the field evaluation points are approximately indicated in the figures. The E-field and H-field distributions in the vertical plane placed at 60 cm from the antenna, behind the case, are shown as well. The points where the fields are sampled to determine the equivalent power density (S) are approximately indicated by the white dots. A picture of the antenna is not reported because it is identical to the HAD4009A except for the length.



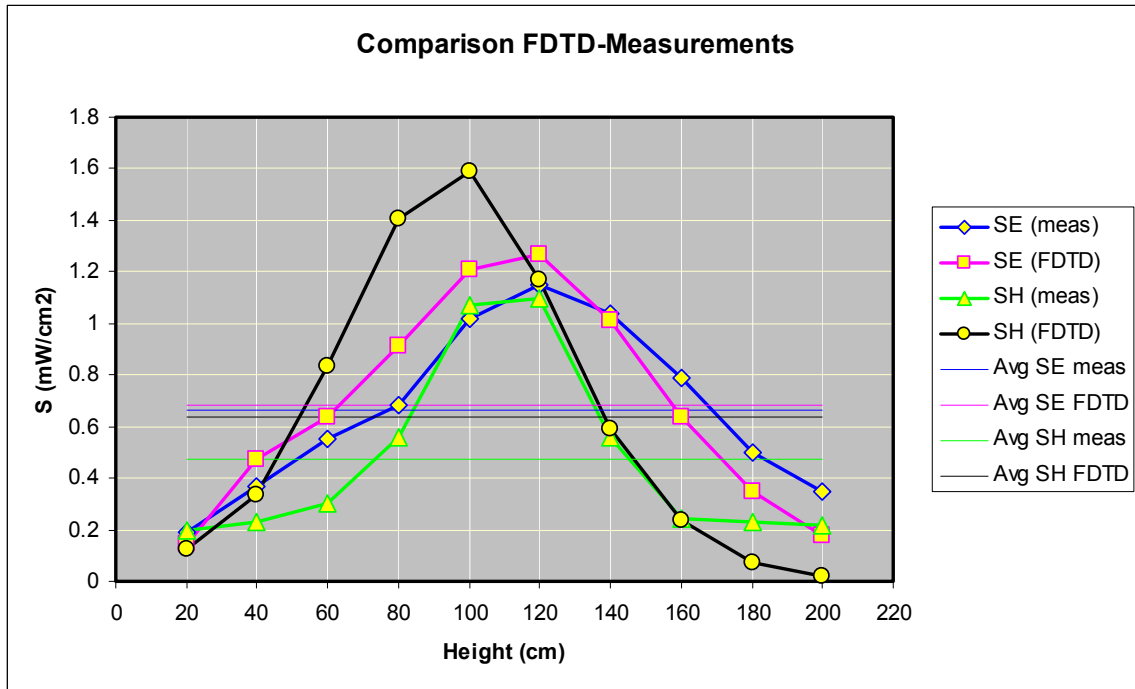


The following table reports the field values computed by XFDTD™ and the corresponding power density values. The average exposure levels are computed as well.

Height (cm)	E (V/m)	S <sub>E</sub> (W/m <sup>2</sup> )	H (A/m)	S <sub>H</sub> (W/m <sup>2</sup> )
20	2.12E-01	5.96E-05	5.21E-04	5.12E-05
40	3.86E-01	1.98E-04	8.59E-04	1.39E-04
60	4.48E-01	2.66E-04	1.36E-03	3.49E-04
80	5.36E-01	3.81E-04	1.77E-03	5.88E-04
100	6.17E-01	5.05E-04	1.88E-03	6.65E-04
120	6.32E-01	5.30E-04	1.61E-03	4.87E-04
140	5.65E-01	4.23E-04	1.15E-03	2.48E-04
160	4.47E-01	2.65E-04	7.21E-04	9.80E-05
180	3.30E-01	1.44E-04	4.07E-04	3.13E-05
200	2.35E-01	7.32E-05	1.93E-04	6.99E-06
<b>Average S<sub>E</sub></b>		2.85E-04	<b>Average S<sub>H</sub></b>	

The input impedance is 27.9-j14.3 ohm, therefore the radiated power (considering the mismatch to the 50 ohm unitary voltage source) is 2.22E-3 W. The scaled-up power density values for 53.2 W radiated power are 6.81 W/m<sup>2</sup> (E), and 6.38 W/m<sup>2</sup> (H), that correspond to 0.68 mW/cm<sup>2</sup> (E), and 0.64 mW/cm<sup>2</sup> (H). Measurements yielded average power density of 0.664 mW/cm<sup>2</sup> (E), and 0.471 mW/cm<sup>2</sup> (H), i.e., which are in good agreement with the simulations. The following table and graph show a comparison between the simulated power density and the measured one, based on E (see MPE report in FCC ID#ABZ99FT3046, Table 1) or H fields (see MPE report in FCC ID#ABZ99FT3046, Table 13), normalized to 53.2 W radiated.

Height (cm)	SE (meas) mW/cm <sup>2</sup>	SE (FDTD) mW/cm <sup>2</sup>	SH (meas) mW/cm <sup>2</sup>	SH (FDTD) mW/cm <sup>2</sup>	Avg SE meas mW/cm <sup>2</sup>	Avg SE FDTD mW/cm <sup>2</sup>	Avg SH meas mW/cm <sup>2</sup>	Avg SH FDTD mW/cm <sup>2</sup>
20	0.19	0.14	0.2	0.12	0.664	0.681	0.471	0.638
40	0.37	0.47	0.23	0.33				
60	0.55	0.64	0.3	0.84				
80	0.68	0.91	0.56	1.41				
100	1.02	1.21	1.07	1.59				
120	1.15	1.27	1.1	1.17				
140	1.04	1.01	0.56	0.59				
160	0.79	0.63	0.24	0.23				
180	0.5	0.35	0.23	0.07				
200	0.35	0.18	0.22	0.02				



## 7) Test device positioning

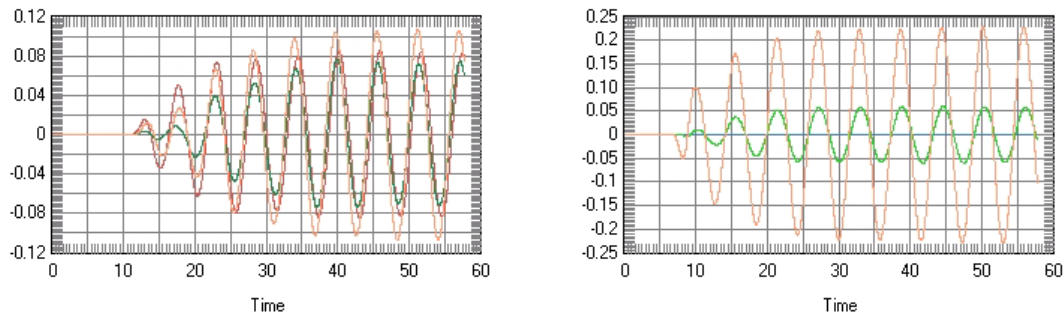
a) A description of the device test positions used in the SAR computations is provided in the SAR report.

b) Illustrations showing the separation distances between the test device and the phantom for the tested configurations are provided in the SAR report.



## 8) Steady state termination procedures

a) The criteria used to determine that sinusoidal steady-state conditions have been reached throughout the computational domain for terminating the computations are based on the monitoring of field points to make sure they converge. For at least one passenger and one bystander exposure condition, we placed one “field sensor” near the antenna, others between the body and the domain boundary at different locations, and one inside the head of the model. In all simulations, isotropic E-field sensors were placed at opposite corners of the computational domain. We used isotropic E and H field “sensors”, meaning that all three components of the fields are monitored at these points. The following figures show an example of the time waveforms at the field point sensors in the in two opposite points in the computational domain. We selected points near the lowest and highest grid index points. They are shown together in the figure. The highest field levels are observed for the higher index point, as it is closer to the antenna. In all cases, the field reaches the steady-state after a few cycles.



b) 6000 time steps were used, with a time step approximately equal to  $10\text{ ps}$  (meeting the Courant criterion), which corresponds to 10 wave periods at 146 MHz. 4000 time steps were used, with a time step approximately equal to  $10\text{ ps}$  (meeting the Courant criterion), which corresponds to 18 wave periods at 450 MHz.

c) The XFDTD™ algorithm determines the field phasors by using the so-called “two-equations two-unknowns” method. Details of the algorithm are explained in [7].

## 9) Computing peak SAR from field components

a) The twelve E-field phasors at the edges of each Yee voxel are combined to yield the SAR associated to that voxel. In particular, the average is performed on the SAR values computed at the 12 edges of each voxel. Notice that in XFDTD™ the dielectric tissue properties are assigned to the voxel edges, thereby allowing said averaging procedure.

b) The IEEE Standards Coordinating Committee 34, Sub-Committee 2 draft standard P1529 (June 2000) discusses several algorithms for volumetric SAR averaging. It states that “It is observed that while the 12 components algorithm is the most appropriate from the mathematical point of view, the differences in 1g SAR calculated with either the 12 or 6 component methods are negligible for practical mesh resolutions (below 5mm). On the

other hand, it is shown that the 3 components approach may lead to significant errors.” XFDTD™ employs the 12-component method, which is the one recommended in the draft standard, thus providing the best achievable accuracy.

## **10) One-gram averaged SAR procedures**

a) XFDTD™ computes the Specific Absorption Rate (SAR) in each complete cell containing lossy dielectric material and with a non-zero material density. To be considered a complete cell, the twelve cell edges must belong to lossy dielectric materials. The averaging calculation uses an interpolation scheme for finding the averages. Cubical spaces centered on a cell are formed and the mass and average SAR of the sample cubes are found. The size of the sample cubes increases until the total mass of the enclosed exceeds either 1 or 10 grams. The mass and average SAR value of each cube is saved and used to interpolate the average SAR values at either 1 or 10 grams. The interpolation is performed using two methods (polynomial fit and rational function fit) and the one with the lowest error is chosen. The sample cube must meet some conditions to be considered valid. The cube may contain some non-tissue cells, but some checks are performed on the distribution of the non-tissue cells. A valid cube will not contain an entire side or corner of non-tissue cells.

b) The sample cube increases in odd-numbered steps (1x1x1, 3x3x3, 5x5x5, etc) to remain centered on the desired cell. Since the visible human model employed herein has 5 mm resolution, the one-gram SAR is computed by averaging first over 1x1x1 voxels, corresponding to 0.125 cm<sup>3</sup> (not enough yet), and then over a 3x3x3 voxel cube, corresponding to about 3.4 cm<sup>3</sup>, which is enough to include 1-g, and finally over a 5x5x5 voxel cube, corresponding to about 15.6 cm<sup>3</sup>, which includes 10-g. The 1-g average SAR is computed by interpolating these three data points. This procedure is repeated in the surroundings of each voxel that is constituted by lossy materials, so as to determine the 1-g and/or 10-g SAR distributions.

c) As mentioned at points 10(a) and 10(b), the 1-gram average SAR is determined by interpolating the average SAR for the 1x1x1, 3x3x3, and the 5x5x5 data points, corresponding to 0.125 cm<sup>3</sup>, 3.4 cm<sup>3</sup>, and 15.6 cm<sup>3</sup>, respectively. Because the interpolation is carried out across three data points, the error introduced should be negligible because the interpolating curve crosses exactly the data points.

**11) Total computational uncertainty** – We derived an estimate for the uncertainty of FDTD methods in evaluating SAR by referring to [6]. In Fig. 7 in [6] it is shown that the deviation between SAR estimates using the XFDTD™ code and those measured with a compliance system are typically within 10% when the probe is away from the phantom surface so that boundary effects are negligible. In that example, the simulated SAR always exceeds the measured SAR.

As discussed in 6(a), a conservative bias has been introduced in the model so as to reduce concerns regarding the computational uncertainty related to the car modeling, antenna modeling, and phantom modeling. The results of the comparison between measurements

and simulations presented in 6(a) suggest that the present model produces an overestimate of the exposure between 4% and 36%. Such a conservative bias should eliminate the need for including uncertainty considerations in the SAR assessment.

## 12) Test results for determining SAR compliance

a) Illustrations showing the SAR distribution of dominant peak locations produced by the test transmitter, with respect to the phantom and test device, are provided in the SAR report.

b) The input impedance and the total power radiated under the impedance match conditions that occur at the test frequency are provided by XFDTD™. XFDTD™ computes the input impedance by following the method outlined in [8], which consists in performing the integration of the steady-state magnetic field around the feed point edge to compute the steady-state feed point current ( $I$ ), which is then used to divide the feed-gap steady-state voltage ( $V$ ). The net *rms* radiated power is computed as

$$P_{XFDTD} = \frac{1}{2} \text{Re}\{VI^*\}$$

Both the input impedance and the net rms radiated power are provided by XFDTD™ at the end of each individual simulation.

We normalize the SAR to such a power, thereby obtaining SAR per radiated Watt (*normalized SAR*) values for the whole body and the 1-g SAR. Finally, we multiply such normalized SAR values times the max power rating of the device under test. In this way, we obtain the exposure metrics for 100% talk-time, i.e., without applying source-based time averaging.

c) For mobile radios, 50% source-based time averaging is applied by multiplying the SAR values determined at point 12(b) times a 0.5 factor.

## REFERENCES

[1] K. S. Yee, "Numerical Solution of Initial Boundary Value Problems Involving Maxwell's Equations in Isotropic Media," *IEEE Transactions on Antennas and Propagation*, vol. 14, no. 3, 302-307, March 1966.

[2] Z. P. Liao, H. L. Wong, G. P. Yang, and Y. F. Yuan, "A transmitting boundary for transient wave analysis," *Scientia Sinica*, vol. 28, no. 10, pp 1063-1076, Oct. 1984.

[3] Validation exercise: Mie sphere. Remcom Inc. (enclosed PDF)



Remcom.pdf

[4] NEC-Win PRO™ v 1.1, Nittany Scientific, Inc., Riverton, UT.

[5] C. M. Collins and M. B. Smith, "Calculations of B1 distribution, SNR, and SAR for a surface coil against an anatomically-accurate human body model," *Magn. Reson. Med.*, 45:692-699, 2001. (enclosed TIF)



Collins & Smith.pdf

[6] Martin Siegbahn and Christer Törnevik, "Measurements and FDTD Computations of the IEEE SCC 34 Spherical Bowl and Dipole Antenna," Report to the IEEE Standards Coordinating Committee 34, Sub-Committee 2, 1998. (enclosed PDF)



Ericsson.pdf

[7] C. M. Furse and O. P. Gandhi, "Calculation of electric fields and currents induced in a millimeter-resolution human model at 60 Hz using the FDTD method with a novel time-to-frequency-domain conversion," Antennas and Propagation Society International Symposium, 1996. (enclosed PDF)



Furse & Gandhi.pdf

[8] *The Finite Difference Time Domain Method for Electromagnetics*, Chapter 14.2, by K. S. Kunz and R. J. Luebbers, CRC Press, Boca Raton, Florida, 1993.