

# ENGINEERING TEST REPORT

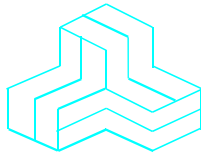

**Vehicular Repeater**  
**Model No.: MOBEXCOM DVRS UHF**  
**FCC ID: LO6-DVRSUHF**

*Applicant:*

**Futurecom Systems Group Inc.**  
3277 Langstaff Road  
Concord, Ontario  
Canada, L4K 5P8

*Tested in Accordance With*

**Federal Communications Commission (FCC)**  
**47 CFR, Parts 2 and 90 (Subpart I)**

**UltraTech's File No.: FSG-039FCC90**

This Test report is Issued under the Authority of  
Tri M. Luu, Professional Engineer,  
Vice President of Engineering  
UltraTech Group of Labs

Date: December 06, 2004



Report Prepared by: Anca Dobre

Tested by: Hung Trinh, EMI/RFI Technician

Issued Date: December 06, 2004

Test Dates: November 7 – November 15, 2004

- *The results in this Test Report apply only to the sample(s) tested, and the sample tested is randomly selected.*
- *This report must not be used by the client to claim product endorsement by NVLAP or any agency of the US Government.*

## UltraTech

3000 Bristol Circle, Oakville, Ontario, Canada, L6H 6G4  
Tel.: (905) 829-1570 Fax: (905) 829-8050

Website: [www.ultratech-labs.com](http://www.ultratech-labs.com), Email: [vic@ultratech-labs.com](mailto:vic@ultratech-labs.com), Email: [tri@ultratech-labs.com](mailto:tri@ultratech-labs.com)



## TABLE OF CONTENTS

<b>EXHIBIT 1.</b>	<b>SUBMITTAL CHECK LIST .....</b>	<b>1</b>
<b>EXHIBIT 2.</b>	<b>INTRODUCTION.....</b>	<b>2</b>
2.1.	SCOPE .....	2
2.2.	RELATED SUBMITTAL(S)/GRANT(S).....	2
2.3.	NORMATIVE REFERENCES .....	2
<b>EXHIBIT 3.</b>	<b>PERFORMANCE ASSESSMENT .....</b>	<b>3</b>
3.1.	CLIENT INFORMATION .....	3
3.2.	EQUIPMENT UNDER TEST (EUT) INFORMATION.....	3
3.3.	EUT'S TECHNICAL SPECIFICATIONS .....	4
3.4.	LIST OF EUT'S PORTS .....	4
3.5.	ANCILLARY EQUIPMENT .....	5
3.6.	GENERAL TEST SETUP .....	5
<b>EXHIBIT 4.</b>	<b>EUT OPERATING CONDITIONS AND CONFIGURATIONS DURING TESTS.....</b>	<b>6</b>
4.1.	CLIMATE TEST CONDITIONS .....	6
4.2.	OPERATIONAL TEST CONDITIONS & ARRANGEMENT FOR TEST SIGNALS .....	6
<b>EXHIBIT 5.</b>	<b>SUMMARY OF TEST RESULTS.....</b>	<b>7</b>
5.1.	LOCATION OF TESTS .....	7
5.2.	APPLICABILITY & SUMMARY OF EMC EMISSION TEST RESULTS.....	7
5.3.	MODIFICATIONS INCORPORATED IN THE EUT FOR COMPLIANCE PURPOSES .....	7
<b>EXHIBIT 6.</b>	<b>MEASUREMENTS, EXAMINATIONS &amp; TEST DATA FOR EMC EMISSIONS .....</b>	<b>8</b>
6.1.	TEST PROCEDURES.....	8
6.2.	MEASUREMENT UNCERTAINTIES.....	8
6.3.	MEASUREMENT EQUIPMENT USED .....	8
6.4.	ESSENTIAL/PRIMARY FUNCTIONS AS DECLARED BY THE MANUFACTURER.....	8
6.5.	RF POWER OUTPUT [ §§ 2.1046 & 90.205] .....	9
6.6.	RF EXPOSURE REQUIREMENTS [ §§ 1.1310 & 2.1091].....	11
6.7.	FREQUENCY STABILITY [ §§ 2.1055 & 90.213] .....	14
6.8.	AUDIO FREQUENCY RESPONSE [ § 2.1047(A) & § 90.242(B) (8)].....	16
6.9.	MODULATION LIMITING [ §§ 2.1047(B) & 90.210].....	21
6.10.	OCCUPIED BANDWIDTH AND EMISSION MASK [ §§ 2.1049, 90.209 & 90.210].....	26
6.11.	TRANSMITTER ANTENNA POWER SPURIOUS/HARMONIC CONDUCTED EMISSIONS [ §§ 2.1051, 90.209 & 90.210].....	69
6.12.	TRANSMITTER SPURIOUS/HARMONIC RADIATED EMISSIONS [ §§ 90.208 & 90.210] .....	82
6.13.	TRANSIENT FREQUENCY BEHAVIOR [ § 90.214].....	85
<b>EXHIBIT 7.</b>	<b>MEASUREMENT UNCERTAINTY.....</b>	<b>91</b>
7.1.	RADIATED EMISSION MEASUREMENT UNCERTAINTY .....	91
<b>EXHIBIT 8.</b>	<b>MEASUREMENT METHODS.....</b>	<b>92</b>
8.1.	CONDUCTED POWER MEASUREMENTS.....	92
8.2.	RADIATED POWER MEASUREMENTS (ERP & EIRP) USING SUBSTITUTION METHOD.....	93
8.3.	FREQUENCY STABILITY .....	96
8.4.	EMISSION MASK.....	97
8.5.	SPURIOUS EMISSIONS (CONDUCTED) .....	97
8.6.	TRANSIENT FREQUENCY BEHAVIOR .....	98

## EXHIBIT 1. SUBMITTAL CHECK LIST

Annex No.	Exhibit Type	Description of Contents	Quality Check (OK)
--	Test Report	<ul style="list-style-type: none"> <li>• Exhibit 1: Submittal check lists</li> <li>• Exhibit 2: Introduction</li> <li>• Exhibit 3: Performance Assessment</li> <li>• Exhibit 4: EUT Operation and Configuration during Tests</li> <li>• Exhibit 5: Summary of test Results</li> <li>• Exhibit 6: Measurement Data</li> <li>• Exhibit 7: Measurement Uncertainty</li> <li>• Exhibit 8: Measurement Methods</li> </ul>	OK
1	Test Setup Photos	Radiated Emission Setup Photos	OK
2	External Photos of EUT	External Photos	OK
3	Internal Photos of EUT	Internal Photos	OK
4	Cover Letters	<ul style="list-style-type: none"> <li>• Letter from Ultratech for Certification Request</li> <li>• Letter from the Applicant to appoint Ultratech to act as an agent</li> <li>• Letter from the Applicant to request for Confidentiality Filing</li> </ul>	OK
5	Attestation Statements	Attestation Letter	OK
6	ID Label/Location Info	ID Label and Location of ID Label	OK
7	Block Diagrams	Block Diagram	OK
8	Schematic Diagrams	Schematics	OK
9	Parts List/Tune Up Info	Parts List/ Tuning Procedures	OK
10	Operational Description	Operational Description	OK
11	RF Exposure Info	See Section 6.6 of this test report for MPE evaluation	OK
12	Users Manual	Users Manual	OK

### ULTRATECH GROUP OF LABS

3000 Bristol Circle, Oakville, Ontario, Canada L6H 6G4  
 Tel. #: 905-829-1570, Fax. #: 905-829-8050, Email: [vic@ultratech-labs.com](mailto:vic@ultratech-labs.com), Website: <http://www.ultratech-labs.com>

File #: FSG-039FCC90  
 December 06, 2004

*All test results contained in this engineering test report are traceable to National Institute of Standards and Technology (NIST)*

## EXHIBIT 2. INTRODUCTION

### 2.1. SCOPE

<b>Reference:</b>	FCC Parts 2 and 90
<b>Title:</b>	Code of Federal Regulations (CFR) Title 47 - Telecommunication, Parts 2 and 90 (Subpart I).
<b>Purpose of Test:</b>	To gain FCC Certification Authorization for Radio operating in the frequency band 403-512 MHz (12.5 kHz and 25 kHz Channel Spacings).
<b>Test Procedures:</b>	Both conducted and radiated emissions measurements were conducted in accordance with American National Standards Institute ANSI C63.4 - American National Standard for Methods of Measurement of Radio-Noise Emissions from Low-Voltage Electrical and Electronic Equipment in the Range of 9 kHz to 40 GHz.
<b>Environmental Classification:</b>	Commercial, industrial or business

### 2.2. RELATED SUBMITTAL(S)/GRANT(S)

None.

### 2.3. NORMATIVE REFERENCES

Publication	Year	Title
FCC CFR Parts 0-19, 80-End	2003	Code of Federal Regulations – Telecommunication
ANSI C63.4	2003	American National Standard for Methods of Measurement of Radio-Noise Emissions from Low-Voltage Electrical and Electronic Equipment in the Range of 9 kHz to 40 GHz
CISPR 22 & EN 55022	2003 2003	Limits and Methods of Measurements of Radio Disturbance Characteristics of Information Technology Equipment
CISPR 16-1	2003	Specification for Radio Disturbance and Immunity measuring apparatus and methods

## EXHIBIT 3. PERFORMANCE ASSESSMENT

### 3.1. CLIENT INFORMATION

APPLICANT	
<b>Name:</b>	Futurecom Systems Group Inc.
<b>Address:</b>	3277 Langstaff Road Concord, Ontario Canada, L4K 5P8
<b>Contact Person:</b>	Mr. Mike Wyrzykow Phone #: 905-660-5548 Fax #: 905-660-1380 Email Address: mikew@futurecom.com

MANUFACTURER	
<b>Name:</b>	Futurecom Systems Group Inc.
<b>Address:</b>	3277 Langstaff Road Concord, Ontario Canada, L4K 5P8
<b>Contact Person:</b>	Mr. Mike Wyrzykow Phone #: 905-660-5548 Fax #: 905-660-1380 Email Address: mikew@futurecom.com

### 3.2. EQUIPMENT UNDER TEST (EUT) INFORMATION

The following information (with the exception of the Date of Receipt) has been supplied by the applicant.

<b>Brand Name:</b>	Futurecom Systems Group Inc.
<b>Product Name:</b>	Vehicular Repeater
<b>Model Name or Number:</b>	MOBEXCOM DVRS UHF
<b>Type of Equipment:</b>	Non-broadcast Radio Communication Equipment
<b>External Power Supply:</b>	None
<b>Primary User functions of EUT:</b>	To provide extended portable radio coverage
<b>Transmitting/Receiving Antenna Type:</b>	Non-Integral

### 3.3. EUT'S TECHNICAL SPECIFICATIONS

<b>TRANSMITTER</b>	
<b>Equipment Type:</b>	Mobile
<b>Intended Operating Environment:</b>	Commercial, industrial or business environment
<b>Power Supply Requirement:</b>	13.8 Vdc
<b>RF Input Power Rating:</b>	0 dBm
<b>RF Output Power Rating:</b>	<ul style="list-style-type: none"> <li>• 20 watts max.</li> <li>• 1 watt min.</li> </ul>
<b>Operating Frequency Range:</b>	403-512 MHz
<b>RF Output Impedance:</b>	50 Ohms
<b>Channel Spacing</b>	12.5 kHz and 25 kHz
<b>Occupied Bandwidth (99%):</b>	<ul style="list-style-type: none"> <li>• 6.9 kHz (12.5 kHz Channel Spacing)</li> <li>• 14.9 kHz (25 kHz Channel Spacing)</li> </ul>
<b>Emission Designation:</b>	<ul style="list-style-type: none"> <li>• 11K0F3E and 11K0F1E (12.5 kHz Channel Spacing)</li> <li>• 16K0F3E and 16K0F1E (25 kHz Channel Spacing)</li> </ul>
<b>Antenna Connector Type:</b>	SMA Female
<b>Antenna Description:</b>	Omnidirectional antenna : The Antenna Gain Limit is 2.15 dBi

\* For an average case of commercial telephony, the Necessary Bandwidth is calculated as follows:

For FM Voice Modulation:

Channel Spacing = 12.5 KHz, D = 2.5 KHz max., K = 1, M = 3 KHz

$$B_n = 2M + 2DK = 2(3) + 2(2.5)(1) = \underline{11 \text{ KHz}}$$

Emission designation: 11K0F3E

Channel Spacing = 25 KHz, D = 5 KHz max., K = 1, M = 3 KHz

$$B_n = 2M + 2DK = 2(3) + 2(5)(1) = \underline{16 \text{ KHz}}$$

Emission designation: 16K0F3E

### 3.4. LIST OF EUT'S PORTS

Port Number	EUT's Port Description	Number of Identical Ports	Connector Type	Cable Type (Shielded/Non-shielded)
1	Transmitter	1	SMA	Terminated with 50 Ohm load
2	Receiver	1	SMA	Terminated with 50 Ohm load
3	DC Input	1	4-pin	Non-shielded
4	RS 232	1	DB9	Shielded
5	Mobile Radio	1	DB25	Shielded
6	Control Head	1	DB25	Shielded

#### ULTRATECH GROUP OF LABS

3000 Bristol Circle, Oakville, Ontario, Canada L6H 6G4  
 Tel. #: 905-829-1570, Fax. #: 905-829-8050, Email: [vic@ultratech-labs.com](mailto:vic@ultratech-labs.com), Website: <http://www.ultratech-labs.com>

File #: FSG-039FCC90  
 December 06, 2004

All test results contained in this engineering test report are traceable to National Institute of Standards and Technology (NIST)

### 3.5. ANCILLARY EQUIPMENT

None.

### 3.6. GENERAL TEST SETUP

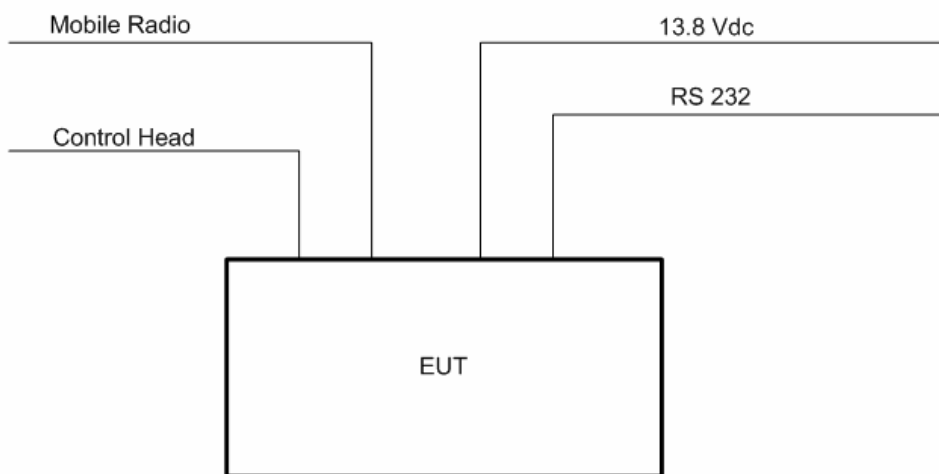

## EXHIBIT 4. EUT OPERATING CONDITIONS AND CONFIGURATIONS DURING TESTS

### 4.1. CLIMATE TEST CONDITIONS

The climate conditions of the test environment are as follows:

Temperature:	21°C
Humidity:	51%
Pressure:	102 kPa
Power input source:	13.8 Vdc

### 4.2. OPERATIONAL TEST CONDITIONS & ARRANGEMENT FOR TEST SIGNALS

<b>Operating Modes:</b>	The transmitter was operated in a continuous transmission mode with the carrier modulated as specified in the Test Data.
<b>Special Test Software:</b>	Testing software provided by the manufacturer to configure different test configurations.
<b>Special Hardware Used:</b>	N/A
<b>Transmitter Test Antenna:</b>	The EUT is tested with the transmitter antenna port terminated to a 50 Ohms RF Load.

Transmitter Test Signals	
<b>Frequency Band(s):</b>	403 – 512 MHz
<b>Frequency(ies) Tested:</b> (Near lowest and near highest frequencies in the frequency range of operation.)	406.1 MHz; 450 MHz & 470 MHz
<b>RF Power Output (measured maximum output power):</b>	20 Watts High & 1 Watt Low
<b>Normal Test Modulation:</b>	Unmodulated, FM Voice (analog & digital)
<b>Modulating signal source:</b>	External



## EXHIBIT 5. SUMMARY OF TEST RESULTS

### 5.1. LOCATION OF TESTS

All of the measurements described in this report were performed at Ultratech Group of Labs located in the city of Oakville, Province of Ontario, Canada.

- AC Power Line Conducted Emissions were performed in UltraTech's shielded room, 24'(L) by 16'(W) by 8'(H).
- Radiated Emissions were performed at the Ultratech's 3 Meter Open Field Test Site (OFTS) situated in the Town of Oakville, province of Ontario.

The above sites have been calibrated in accordance with ANSI C63.4, and found to be in compliance with the requirements of Sec. 2.948 of the FCC Rules. The descriptions and site measurement data of the Oakville Open Field Test Site has been filed with FCC office (FCC File No.: 31040/SIT 1300B3) and Industry Canada office (Industry Canada File No.: IC2049). Last Date of Site Calibration: February 17, 2004.

### 5.2. APPLICABILITY & SUMMARY OF EMC EMISSION TEST RESULTS

FCC Section(s)	Test Requirements	Applicability (Yes/No)
2.1046 & 90.205	RF Power Output	Yes
1.1307, 1.1310, 2.1091 & 2.1093	RF Exposure Limit	Yes
2.1055 & 90.213	Frequency Stability	Yes
2.1047(a) & 90.242(b)(8)	Audio Frequency Response	Not applicable to new standard. However, tests are conducted under FCC's recommendation.
2.1047(b) & 90.210	Modulation Limiting	Yes
2.1049 & 90.210	Emission Limitation & Emission Mask	Yes
2.1051, 2.1057 & 90.210	Emission Limits - Spurious Emissions at Antenna Terminal	Yes
2.1053, 2.1057 & 90.210	Emission Limits - Field Strength of Spurious Emissions	Yes
90.214	Transient Frequency Behavior	Yes
<b>Vehicular Repeater, Model No: MOBEXCOM DVRS UHF, by Futurecom Systems Group Inc. has also been tested and found to comply with FCC Part 15, Subpart B – Radio Receivers and Class A digital Devices.</b>		

### 5.3. MODIFICATIONS INCORPORATED IN THE EUT FOR COMPLIANCE PURPOSES

None

---

#### ULTRATECH GROUP OF LABS

3000 Bristol Circle, Oakville, Ontario, Canada L6H 6G4  
 Tel. #: 905-829-1570, Fax. #: 905-829-8050, Email: [vic@ultratech-labs.com](mailto:vic@ultratech-labs.com), Website: <http://www.ultratech-labs.com>

File #: FSG-039FCC90  
 December 06, 2004

*All test results contained in this engineering test report are traceable to National Institute of Standards and Technology (NIST)*

## **EXHIBIT 6. MEASUREMENTS, EXAMINATIONS & TEST DATA FOR EMC EMISSIONS**

### **6.1. TEST PROCEDURES**

This section contains test results only. Details of test methods and procedures can be found in Exhibit 8 of this report

### **6.2. MEASUREMENT UNCERTAINTIES**

The measurement uncertainties stated were calculated in accordance with requirements of UKAS Document NIS 81 with a confidence level of 95%. Please refer to Exhibit 7 for Measurement Uncertainties.

### **6.3. MEASUREMENT EQUIPMENT USED**

The measurement equipment used complied with the requirements of the Standards referenced in the Methods & Procedures ANSI C63.4 and CISPR 16-1.

### **6.4. ESSENTIAL/PRIMARY FUNCTIONS AS DECLARED BY THE MANUFACTURER**

The essential function of the EUT is to provide portable radio users greater communication range by repeating signals through the vehicle's mobile radio to the dispatch centre. The Vehicular Repeater connects to an existing mobile radio and a control head. The mobile radio provides demodulated mobile audio signal to the repeater and receives demodulated repeater audio signal from the repeater. Therefore, the repeater thus allows local RF repeat operation. It also locally transmits mobile radio received signal and allows the mobile radio to retransmit signals locally received by the repeater from portable radios.

## 6.5. RF POWER OUTPUT [§§ 2.1046 & 90.205]

### 6.5.1. Limits

Please refer to FCC 47 CFR 90.205 for specification details.

### 6.5.2. Method of Measurements

Refer to ULTRATECH Test Procedures, File # ULTR P001-2004, ANSI C63.4 and Exhibit 8, section 8.1 (Conducted) and 8.2 (Radiated) of this report for measurement details.

### 6.5.3. Test Equipment List

Test Instruments	Manufacturer	Model No.	Serial No.	Frequency Range
Power Meter	Hewlett Packard	436A	2709A27515	10kHz – 50 GHz, sensor dependent
Attenuator	Weinschel Corp	48-30-34	BM5354	DC – 18 GHz
Power Sensor	Hewlett Packard	8481A	2702A68983	10 MHz – 18 GHz

### 6.5.4. Test Arrangement

Power at RF Power Output Terminals:

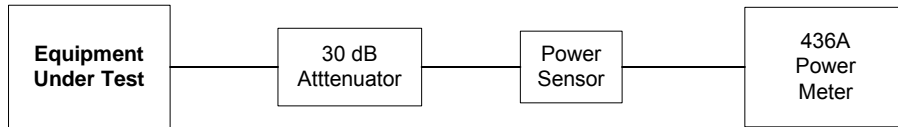

**6.5.5. Test Data**

**6.5.5.1. TRANSMITTER MODE, RF POWER OUTPUT with NO MODULATION**

Channel Spacings (kHz)	Transmitter Channel Output	Fundamental Frequency (MHz)	Measured (Average) Power (Watts)	Power Rating (Watts)
High Power				
12.5	Lowest	406.1	20.14	20.0
12.5	Middle	450.0	20.18	20.0
12.5	Highest	470.0	20.18	20.0
25.0	Lowest	406.1	20.18	20.0
25.0	Middle	450.0	20.18	20.0
25.0	Highest	470.0	20.18	20.0
Low Power				
12.5	Lowest	406.1	1.04	1.0
12.5	Middle	450.0	1.04	1.0
12.5	Highest	470.0	1.03	1.0
25.0	Lowest	406.1	1.00	1.0
25.0	Middle	450.0	1.04	1.0
25.0	Highest	470.0	1.03	1.0

**6.5.5.2. REPEATER MODE, RF POWER OUTPUT with NO MODULATION, Maximum RF IN = 0 dBm**

Channel Spacings (kHz)	Transmitter Channel Output	Fundamental Frequency (MHz)	Measured (Average) Power (Watts)	Power Rating (Watts)
High Power				
12.5	Lowest	406.1	20.04	20.0
12.5	Middle	450.0	20.18	20.0
12.5	Highest	470.0	20.18	20.0
25.0	Lowest	406.1	20.14	20.0
25.0	Middle	450.0	20.14	20.0
25.0	Highest	470.0	20.18	20.0
Low Power				
12.5	Lowest	406.1	1.04	1.0
12.5	Middle	450.0	1.04	1.0
12.5	Highest	470.0	1.03	1.0
25.0	Lowest	406.1	1.00	1.0
25.0	Middle	450.0	1.04	1.0
25.0	Highest	470.0	1.03	1.0

## 6.6. RF EXPOSURE REQUIREMENTS [§§ 1.1310 & 2.1091]

### 6.6.1. Limits

**FCC 1.1310:-** The criteria listed in the following table shall be used to evaluate the environmental impact of human exposure to radio-frequency (RF) radiation as specified in 1.1307(b).

TABLE 1—LIMITS FOR MAXIMUM PERMISSIBLE EXPOSURE (MPE)

Frequency range (MHz)	Electric field strength (V/m)	Magnetic field strength (A/m)	Power density (mW/cm <sup>2</sup> )	Averaging time (minutes)
<b>(A) Limits for Occupational/Controlled Exposures</b>				
0.3–3.0 .....	614	1.63	*(100)	6
3.0–30 .....	1842/f	4.89/f	*(900/f <sup>2</sup> )	6
30–300 .....	61.4	0.163	1.0	6
300–1500 .....	.....	.....	f/300	6
1500–100,000 .....	.....	.....	5	6
<b>(B) Limits for General Population/Uncontrolled Exposure</b>				
0.3–1.34 .....	614	1.63	*(100)	30
1.34–30 .....	824/f	2.19/f	*(180/f <sup>2</sup> )	30
30–300 .....	27.5	0.073	0.2	30
300–1500 .....	.....	.....	f/1500	30
1500–100,000 .....	.....	.....	1.0	30

f = frequency in MHz

\* = Plane-wave equivalent power density

NOTE 1 TO TABLE 1: Occupational/controlled limits apply in situations in which persons are exposed as a consequence of their employment provided those persons are fully aware of the potential for exposure and can exercise control over their exposure. Limits for occupational/controlled exposure also apply in situations when an individual is transient through a location where occupational/controlled limits apply provided he or she is made aware of the potential for exposure.

NOTE 2 TO TABLE 1: General population/uncontrolled exposures apply in situations in which the general public may be exposed, or in which persons that are exposed as a consequence of their employment may not be fully aware of the potential for exposure or can not exercise control over their exposure.

### 6.6.2. Method of Measurements

Refer to FCC @ 1.1310 and 2.1091

- In order to demonstrate compliance with MPE requirements (see Section 2.1091), the following information is typically needed:
  - (1) Calculation that estimates the minimum separation distance (20 cm or more) between an antenna and persons required to satisfy power density limits defined for free space.
  - (2) Antenna installation and device operating instructions for installers (professional/unskilled users), and the parties responsible for ensuring compliance with the RF exposure requirement.
  - (3) Any caution statements and/or warning labels that are necessary in order to comply with the exposure limits.
  - (4) Any other RF exposure related issues that may affect MPE compliance.

**Calculation Method of RF Safety Distance:**

$$S = PG/4\pi r^2 = EIRP/4\pi r^2$$

Where: P: power input to the antenna in mW  
EIRP: Equivalent (effective) isotropic radiated power.  
S: power density mW/cm<sup>2</sup>  
G: numeric gain of antenna relative to isotropic radiator  
r: distance to centre of radiation in cm

$$r = \sqrt{PG/4\pi S}$$

- For portable transmitters (see Section 2.1093), or devices designed to operate next to a person's body, compliance is determined with respect to the SAR limit (define in the body tissues) for near-field exposure conditions. If the maximum average output power, operating condition configurations and exposure conditions are comparable to those of existing cellular and PCS phones, SAR evaluation may be required in order to determine if such a device complies with SAR limit. When SAR evaluation data is not available, and the additional supporting information cannot assure compliance, the Commission may request that an SAR evaluation be performed, as provided for in Section 1.1307(d).

**6.6.3. Test Data**

**Antenna Gain Limit specified by Manufacturer: 0 dBd or 2.15 dBi**

(1) Lowest Frequency (MHz)	Measured Peak RF Conducted Power (dBm)	(2) Average RF Conducted Power (dBm)	Calculated EIRP (dBm)	Exposure Condition	Calculated Minimum RF Safety Distance r (cm)*
406.1	43.05	40.04	42.2	Occupational	31.2
406.1	43.05	40.04	42.2	Bystanders	69.8

Notes:

- (1) The calculation is based on the lowest frequency (406.1 MHz) and the highest conducted power (43.05 dBm) for the worst case.
- (2) Duty cycle is 50% for push to talk radio

\* The minimum separation distance between the antenna and bodies of users are calculated using the following formula:

$$\text{RF EXPOSURE DISTANCE LIMITS: } r = (PG/4\pi S)^{1/2} = (\text{EIRP}/4\pi S)^{1/2}$$

$$\text{Occupational/ Control Exposures: } S = f/300 = 406.1/300 \text{ mW/cm}^2$$

$$\text{For bystanders/ Uncontrolled Exposure: } S = f/1500 = 406.1/1500 \text{ mW/cm}^2$$

$$\text{Occupational: } r = (\text{EIRP}/4\pi S)^{1/2} = (16,595.87/(4\pi(406.1/300)))^{1/2} = 31.20 \text{ cm}$$

$$\text{For bystanders: } r = (\text{EIRP}/4\pi S)^{1/2} = (16,595.87/(4\pi(406.1/1500)))^{1/2} = 69.8 \text{ cm}$$

Evaluation of RF Exposure Compliance Requirements	
RF Exposure Requirements	Compliance with FCC Rules
Minimum calculated separation distance between antenna and persons required:  Occupational: 31.2 cm Bystanders: 69.8 cm	Manufacturer' instruction for separation distance between antenna and persons required:  70 cm
Antenna installation and device operating instructions for installers (professional/unskilled users), and the parties responsible for ensuring compliance with the RF exposure requirement	Please refer to User's Manual for details.
Caution statements and/or warning labels that are necessary in order to comply with the exposure limits	Please refer to User's Manual for RF Exposure Information.
Any other RF exposure related issues that may affect MPE compliance	None.

## 6.7. FREQUENCY STABILITY [§§ 2.1055 & 90.213]

### 6.7.1. Limits

Refer to FCC 47 CFR 90.213 for specification details.

Frequency Range (MHz)	Channel Bandwidth (kHz)	Frequency Tolerance (ppm)		
		Fixed and Base Stations	Mobile Stations	
			> 2 W	≤ 2 W
421-512 MHz	12.5	1.5	2.5	2.5
	25	2.5	5.0	5.0

### 6.7.2. Method of Measurements

Refer to ULTRATECH Test Procedures, File # ULTR P001-2004 and Exhibit 8 of this report for measurement details.

### 6.7.3. Test Equipment List

Test Instruments	Manufacturer	Model No.	Serial No.	Frequency Range
Microwave Frequency Counter	EIP Microwave	545A	02683	10 kHz – 18 GHz
Attenuator	Weinschel Corp	23-20-34	BH7876	DC – 18 GHz
Temperature & Humidity Chamber	Tenney	T5	9723B	-40° to +60° C range

### 6.7.4. Test Arrangement

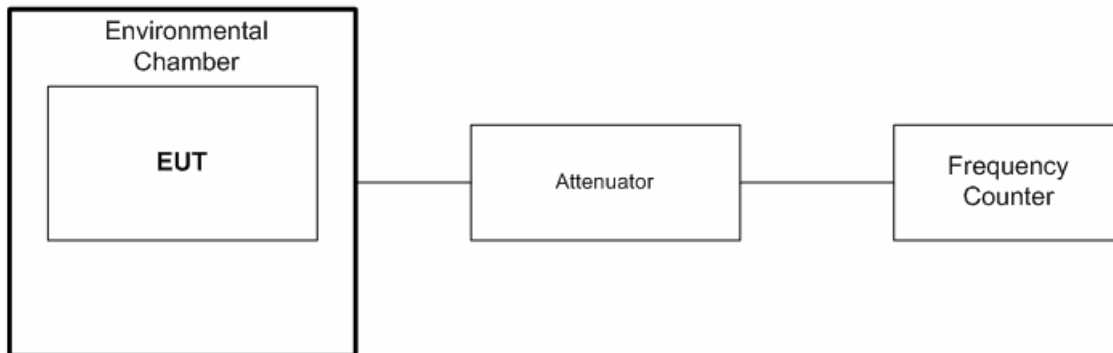



**6.7.5. Test Data**

<b>Product Name:</b>	Vehicular Repeater
<b>Model No.:</b>	MOBEXCOM DVRS UHF
<b>Center Frequency:</b>	406.1 MHz
<b>Full Power Level:</b>	43 dBm
<b>Frequency Tolerance Limit:</b>	$\pm 1.5$ ppm or $\pm 609.15$ Hz
<b>Max. Frequency Tolerance Measured:</b>	357 Hz or 0.9 ppm
<b>Input Voltage Rating:</b>	13.8 Vdc

Ambient Temperature (°C)	CENTER FREQUENCY & RF POWER OUTPUT VARIATION		
	Supply Voltage (Nominal) 13.8 Vdc	Supply Voltage (85% of Nominal) 11.73 Vdc	Supply Voltage (115% of Nominal) 15.87 Vdc
	Hz	Hz	Hz
-30	- 357	N/A	N/A
-20	- 195	N/A	N/A
-10	- 80	N/A	N/A
0	-20	N/A	N/A
+10	0	N/A	N/A
+20	0	-1	-2
+30	3	N/A	N/A
+40	47	N/A	N/A
+50	201	N/A	N/A
+60	234	N/A	N/A

## 6.8. AUDIO FREQUENCY RESPONSE [§ 2.1047(a) & § 90.242(b) (8)]

### 6.8.1. Limits

Recommended audio filter attenuation characteristics are given below:

RF Band	Audio band	Minimum Attenuation Rel. to 1 kHz Attenuation
421-512 MHz	3 –20 kHz Above 20 kHz	$60 \log_{10}(f/3)$ dB where f is in kHz 50dB

### 6.8.2. Method of Measurements

The rated audio input signal was applied to the input of the audio lowpass filter (or of all modulation stages) using an audio oscillator, this input signal level and its corresponding output signal were then measured and recorded using the FFT (Audio) EMI Receiver. Tests were repeated at different audio signal frequencies from 0 to 50 kHz.

### 6.8.3. Test Equipment List

Test Instruments	Manufacturer	Model No.	Serial No.	Frequency Range
FFT (audio) EMI Receiver	Advantest	R9211E	82020336	10 mHz – 100 kHz, 1 MHz Input Impedance
Radio Communication	Marconi	2955	132037/226	20 Hz – 20 kHz
Synthesized Function Generator	Stanford Research Systems	DS 345	34591	1 μHz – 30.2 MHz

### 6.8.4. Test Arrangement

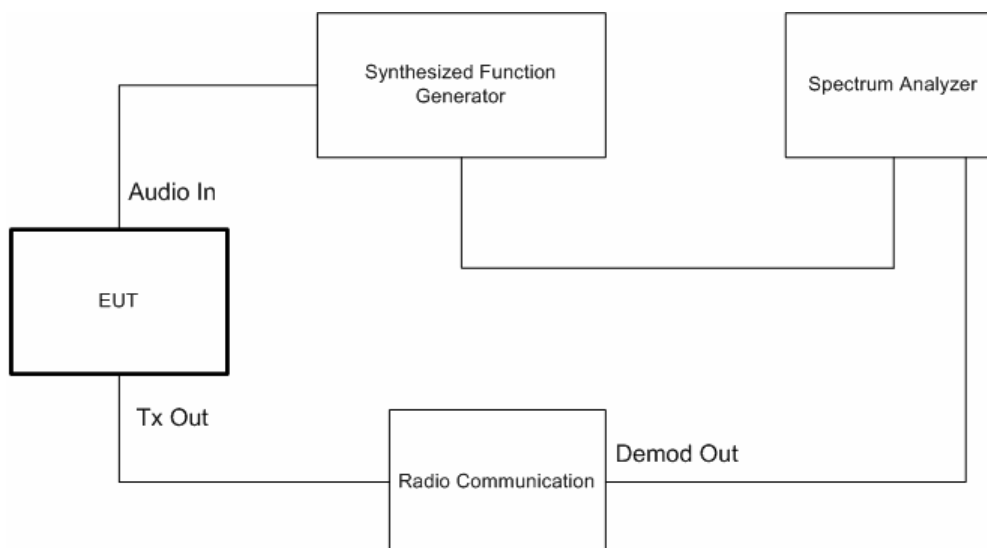

### 6.8.5. Test Data

#### 6.8.5.1. 12.5 kHz Channel Spacing, Frequency of All Modulation States

Frequency (kHz)	Audio IN (dBV)	Audio OUT (dBV)	Attenuation (OUT - IN) (dB)	Attenuation wrt. 1 kHz (dB)	* Recommended Attenuation (dB)
0.1	-22.98	-60.00	-37.0	-58.7	--
0.2	-22.98	-60.00	-37.0	-58.7	--
0.4	-22.98	-8.98	14.0	-7.7	--
0.6	-22.98	-5.68	17.3	-4.4	--
0.8	-22.98	-3.08	19.9	-1.8	--
1.0	-22.98	-1.32	21.7	0.0	--
1.5	-22.98	2.23	25.2	3.6	--
2.0	-22.98	3.78	26.8	5.1	--
2.5	-22.98	3.73	26.7	5.1	--
3.0	-22.98	3.09	26.1	4.4	0
3.5	-22.98	2.12	25.1	3.4	-4
4.0	-22.98	-9.61	13.4	-8.3	-7
4.5	-22.98	-60.00	-37.0	-58.7	-11
5.0	-22.98	-60.00	-37.0	-58.7	-13
6.0	-22.98	-60.00	-37.0	-58.7	-18
7.0	-22.98	-60.00	-37.0	-58.7	-22
8.0	-22.98	-60.00	-37.0	-58.7	-26
9.0	-22.98	-60.00	-37.0	-58.7	-29
10.0	-22.98	-60.00	-37.0	-58.7	-31
12.0	-22.98	-60.00	-37.0	-58.7	-36
14.0	-22.98	-60.00	-37.0	-58.7	-40
16.0	-22.98	-60.00	-37.0	-58.7	-44
18.0	-22.98	-60.00	-37.0	-58.7	-47
20.0	-22.98	-60.00	-37.0	-58.7	-50
25.0	-22.98	-60.00	-37.0	-58.7	-50
30.0	-22.98	-60.00	-37.0	-58.7	-50
35.0	-22.98	-60.00	-37.0	-58.7	--
40.0	-22.98	-60.00	-37.0	-58.7	--
45.0	-22.98	-60.00	-37.0	-58.7	--
50.0	-22.98	-60.00	-37.0	-58.7	--

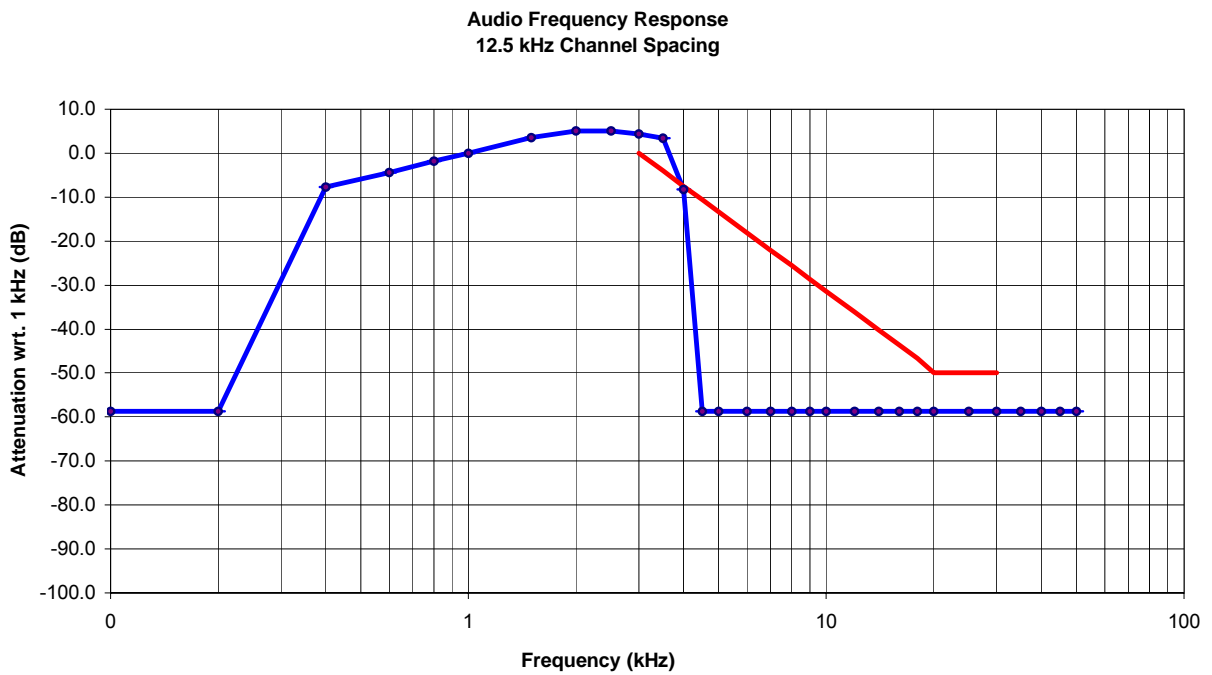

6.8.5.2. 25 kHz Channel Spacing, Frequency of All Modulation States

Frequency (kHz)	Audio IN (dBV)	Audio OUT (dBV)	Attenuation (OUT - IN) (dB)	Attenuation wrt. 1 kHz (dB)	* Recommended Attenuation (dB)
0.1	-21.99	-60.00	-38.0	-65.8	--
0.2	-21.99	-60.00	-38.0	-65.8	--
0.4	-21.99	-1.95	20.0	-7.8	--
0.6	-21.99	1.38	23.4	-4.4	--
0.8	-21.99	3.95	25.9	-1.9	--
1.0	-21.99	5.82	27.8	0.0	--
1.5	-21.99	-10.45	11.5	-16.3	--
2.0	-21.99	-9.86	12.1	-15.7	--
2.5	-21.99	-9.68	12.3	-15.5	--
3.0	-21.99	-10.67	11.3	-16.5	0
3.5	-21.99	-11.42	10.6	-17.2	-4
4.0	-21.99	-1.76	20.2	-7.6	-7
4.5	-21.99	-60.00	-38.0	-65.8	-11
5.0	-21.99	-60.00	-38.0	-65.8	-13
6.0	-21.99	-60.00	-38.0	-65.8	-18
7.0	-21.99	-60.00	-38.0	-65.8	-22
8.0	-21.99	-60.00	-38.0	-65.8	-26
9.0	-21.99	-60.00	-38.0	-65.8	-29
10.0	-21.99	-60.00	-38.0	-65.8	-31
12.0	-21.99	-60.00	-38.0	-65.8	-36
14.0	-21.99	-60.00	-38.0	-65.8	-40
16.0	-21.99	-60.00	-38.0	-65.8	-44
18.0	-21.99	-60.00	-38.0	-65.8	-47
20.0	-21.99	-60.00	-38.0	-65.8	-50
25.0	-21.99	-60.00	-38.0	-65.8	-50
30.0	-21.99	-60.00	-38.0	-65.8	-50
35.0	-21.99	-60.00	-38.0	-65.8	--
40.0	-21.99	-60.00	-38.0	-65.8	--
45.0	-21.99	-60.00	-38.0	-65.8	--
50.0	-21.99	-60.00	-38.0	-65.8	--

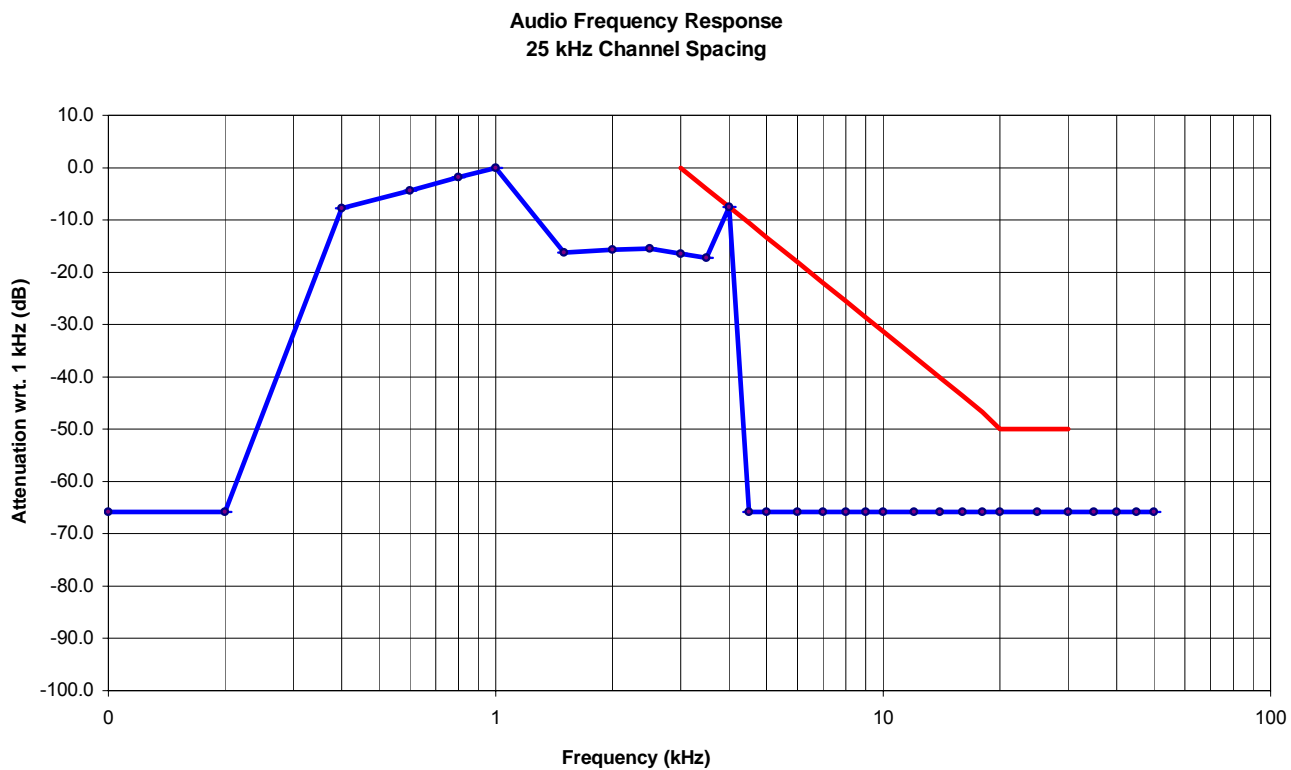

## 6.9. MODULATION LIMITING [§§ 2.1047(b) & 90.210]

### 6.9.1. Limits

Recommended frequency deviation characteristics are given below:

- 2.5 kHz for 12.5 kHz Channel Spacing
- 5 kHz for 25 kHz Channel Spacing System

### 6.9.2. Method of Measurements

Refer to ULTRATECH Test Procedures, File # ULTR P001-2004.

### 6.9.3. Test Equipment List

Test Instruments	Manufacturer	Model No.	Serial No.	Frequency Range
Synthesized Function Generator	Stanford Research Systems	DS 345	34591	1 $\mu$ Hz – 30.2 MHz
Modulation Analyzer	HP	8910B	3226A04606	150 kHz – 1300 MHz

### 6.9.4. Test Arrangement

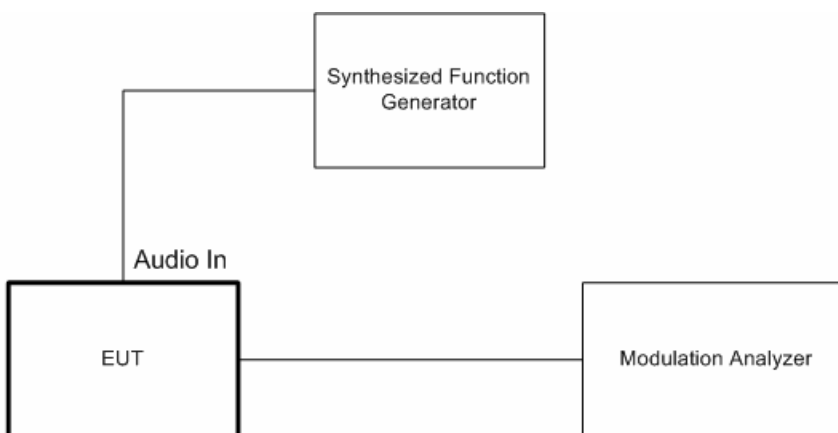

**6.9.5. Test Data**

**6.9.5.1. Voice Modulation Limiting for 12.5 kHz Channel Spacing Operation with High Power setting @ 406.1 MHz**

MODULATING SIGNAL LEVEL (mVrms)	PEAK FREQUENCY DEVIATION (kHz) at the following modulating frequency:					MAXIMUM LIMIT (kHz)
	0.1 kHz	0.5 kHz	1.0 kHz	3.0 kHz	5.0 kHz	
20	0.38	0.48	0.80	1.36	0.69	2.5
40	0.38	0.67	1.10	2.26	0.69	2.5
60	0.38	0.89	1.23	2.39	0.69	2.5
80	0.38	1.06	1.69	2.39	0.69	2.5
100	0.38	1.23	2.09	2.39	0.69	2.5
150	0.38	1.67	2.47	2.39	0.69	2.5
200	0.38	2.07	2.48	2.39	0.69	2.5
250	0.38	2.44	2.48	2.39	0.69	2.5
300	0.38	2.44	2.48	2.39	0.69	2.5
350	0.38	2.44	2.48	2.39	0.69	2.5
400	0.38	2.44	2.48	2.39	0.69	2.5
450	0.38	2.44	2.48	2.42	0.69	2.5
500	0.38	2.44	2.48	2.42	0.69	2.5
550	0.38	2.44	2.48	2.42	0.69	2.5
600	0.38	2.44	2.48	2.42	0.69	2.5
650	0.38	2.44	2.48	2.42	0.69	2.5
700	0.38	2.44	2.48	2.42	0.69	2.5
750	0.38	2.44	2.48	2.42	0.69	2.5
800	0.38	2.44	2.48	2.42	0.69	2.5
850	0.38	2.44	2.48	2.42	0.69	2.5
900	0.38	2.44	2.48	2.42	0.69	2.5
950	0.38	2.44	2.48	2.42	0.69	2.5
1000	0.38	2.44	2.48	2.42	0.69	2.5



Voice Signal Input Level = STD MOD Level + 16 dB  
 = 70 mVrms + 16 dB  
 = 36.90 dBmV + 16 dB  
 = 52.90 dBmV  
 = 441.67 Vrms

MODULATING FREQUENCY (KHz)	PEAK FREQUENCY DEVIATION (KHz)	MAXIMUM LIMIT (KHz)
0.1	0.57	2.5
0.2	0.97	2.5
0.4	2.37	2.5
0.6	2.42	2.5
0.8	2.42	2.5
1.0	2.47	2.5
1.2	2.48	2.5
1.4	2.48	2.5
1.6	2.48	2.5
1.8	2.48	2.5
2.0	2.48	2.5
2.5	2.48	2.5
3.0	2.48	2.5
3.5	2.36	2.5
4.0	1.78	2.5
4.5	0.89	2.5
5.0	0.59	2.5
6.0	0.53	2.5
7.0	0.42	2.5
8.0	0.41	2.5
9.0	0.38	2.5
10.0	0.38	2.5

**6.9.5.2. Voice Modulation Limiting for 25 kHz Channel Spacing Operation with High Power setting @ 406.1 MHz**

MODULATING SIGNAL LEVEL (mVrms)	PEAK FREQUENCY DEVIATION (kHz) at the following modulating frequency:					MAXIMUM LIMIT (kHz)
	0.1 kHz	0.5 kHz	1.0 kHz	3.0 kHz	5.0 kHz	
20	0.37	0.36	1.04	2.33	0.58	5
40	0.37	0.36	1.87	4.84	0.58	5
60	0.37	0.36	2.46	4.84	0.58	5
80	0.37	1.68	3.09	4.84	0.58	5
100	0.37	2.03	3.79	4.84	0.58	5
150	0.37	3.79	4.86	4.84	0.58	5
200	0.37	4.11	4.86	4.84	0.58	5
250	0.37	4.76	4.86	4.84	0.58	5
300	0.37	4.76	4.86	4.84	0.58	5
350	0.37	4.76	4.86	4.84	0.58	5
400	0.37	4.76	4.86	4.84	0.58	5
450	0.37	4.76	4.86	4.84	0.58	5
500	0.38	4.76	4.86	4.84	0.58	5
550	0.38	4.76	4.86	4.84	0.58	5
600	0.38	4.76	4.86	4.84	0.58	5
650	0.38	4.76	4.86	4.84	0.58	5
700	0.38	4.76	4.86	4.84	0.58	5
750	0.38	4.76	4.86	4.84	0.58	5
800	0.38	4.76	4.86	4.84	0.58	5
850	0.38	4.76	4.86	4.84	0.58	5
900	0.38	4.76	4.86	4.84	0.58	5
950	0.38	4.76	4.86	4.84	0.58	5
1000	0.38	4.76	4.86	4.84	0.58	5

Voice Signal Input Level = STD MOD Level + 16 dB  
 = 80 mVrms + 16 dB  
 = 38.06 dBmV + 16 dB  
 = 54.06 dBmV  
 = 504.66 Vrms

MODULATING FREQUENCY (KHz)	PEAK FREQUENCY DEVIATION (KHz)	MAXIMUM LIMIT (KHz)
0.1	1.02	5
0.2	1.98	5
0.4	4.86	5
0.6	4.86	5
0.8	4.86	5
1.0	4.86	5
1.2	4.86	5
1.4	4.86	5
1.6	4.86	5
1.8	4.86	5
2.0	4.86	5
2.5	4.86	5
3.0	4.86	5
3.5	4.86	5
4.0	3.32	5
4.5	0.74	5
5.0	0.74	5
6.0	0.74	5
7.0	0.74	5
8.0	0.74	5
9.0	0.74	5
10.0	0.74	5

**ULTRATECH GROUP OF LABS**

3000 Bristol Circle, Oakville, Ontario, Canada L6H 6G4  
 Tel. #: 905-829-1570, Fax. #: 905-829-8050, Email: [vic@ultratech-labs.com](mailto:vic@ultratech-labs.com), Website: <http://www.ultratech-labs.com>

File #: FSG-039FCC90

December 06, 2004

All test results contained in this engineering test report are traceable to National Institute of Standards and Technology (NIST)

**6.10. OCCUPIED BANDWIDTH AND EMISSION MASK [§§ 2.1049, 90.209 & 90.210]**

**6.10.1. Limits**

Emissions shall be attenuated below the mean output power of the transmitter as follows:

Frequency Band (MHz)	Maximum Authorized BW (kHz)	Channel Spacing (kHz)	FCC Applicable Mask @ FCC 90.210
403-512	11.25	12.5	MASK D
403-512	20	25	MASK B

**6.10.2. Method of Measurements**

Refer to ULTRATECH Test Procedures, File # ULTR P001-2004 and Exhibit 8 of this report for measurement details.

**6.10.3. Test Equipment List**

Test Instruments	Manufacturer	Model No.	Serial No.	Frequency Range
Spectrum Analyzer	Rohde & Schwarz	FSEK20/B4/B21	834157/005	9 kHz – 40 GHz
Function Generator	Stanford Research Systems	DS345	34591	1Hz -30.2 MHz
Voice Guard Digital Speech Encryption	General Electric	9600-SW	9614517	--
Attenuator	Weinschel Corp	48-30-34	BM5354	DC - 18 GHz

**6.10.4. Test Arrangement**

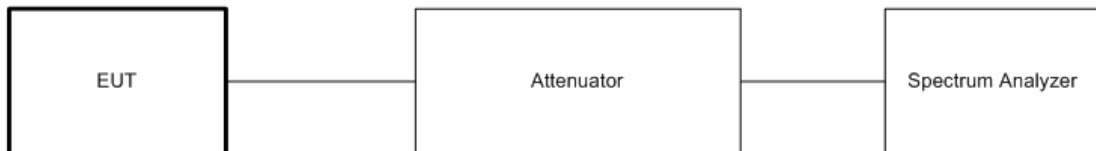

### 6.10.5. Test Data

#### 6.10.5.1. 99% Occupied Bandwidth Measurements

Frequency (MHz)	Channel Spacing (kHz)	Modulation	*Measured 99% OBW at Maximum Freq. Deviation (kHz)	Maximum Authorized Bandwidth (kHz)
406.1	12.5	FM with 2.5 kHz sine wave signal	9.9	11.25
450.0	12.5	FM with 2.5 kHz sine wave signal	10.2	11.25
470.0	12.5	FM with 2.5 kHz sine wave signal	10.4	11.25
406.1	25.0	FM with 2.5 kHz sine wave signal	14.9	20.0
450.0	25.0	FM with 2.5 kHz sine wave signal	15.5	20.0
470.0	25.0	FM with 2.5 kHz sine wave signal	15.9	20.0
406.1	12.5	C4FM Digital Modulation	6.9	11.25
450.0	12.5	C4FM Digital Modulation	6.9	11.25
470.0	12.5	C4FM Digital Modulation	6.9	11.25

\*Refer to the following test data plots (1 through 9) for details.

**PLOT # 1**      **99% Occupied Bandwidth**  
**Frequency: 406.1 MHz, 12.5 kHz Channel Spacing**  
**Modulation: FM modulation with 2.5 kHz sine wave signal**

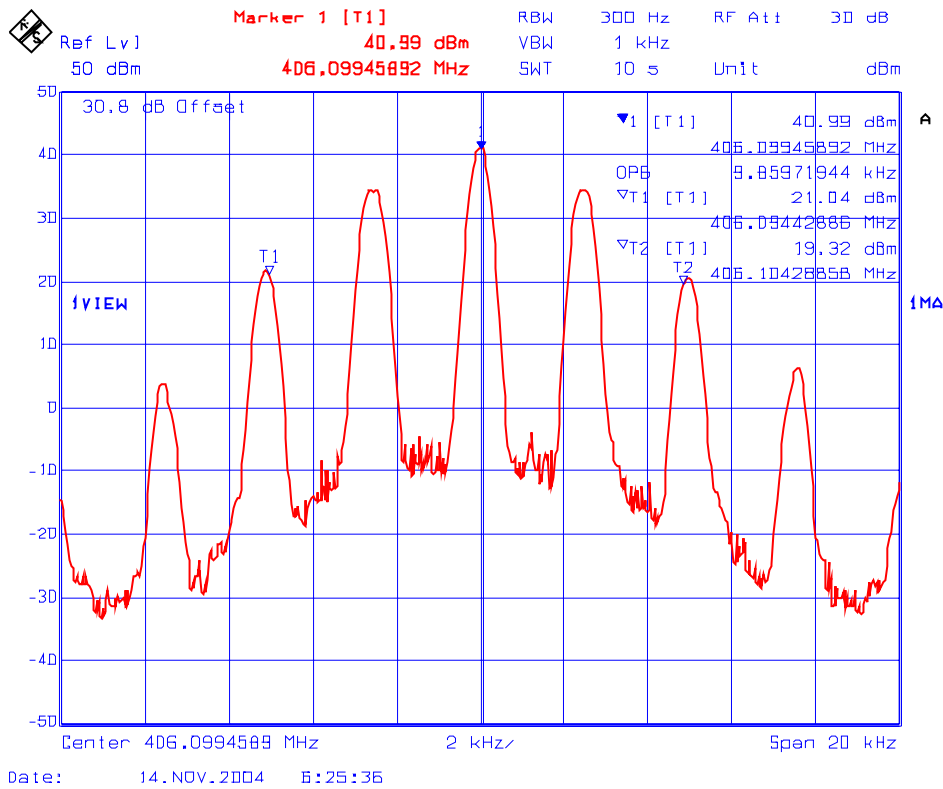

**ULTRATECH GROUP OF LABS**

3000 Bristol Circle, Oakville, Ontario, Canada L6H 6G4  
 Tel. #: 905-829-1570, Fax. #: 905-829-8050, Email: [vic@ultratech-labs.com](mailto:vic@ultratech-labs.com), Website: <http://www.ultratech-labs.com>

File #: FSG-039FCC90

December 06, 2004

All test results contained in this engineering test report are traceable to National Institute of Standards and Technology (NIST)

**PLOT # 2**      **99% Occupied Bandwidth**  
**Frequency: 450 MHz, 12.5 kHz Channel Spacing**  
**Modulation: FM modulation with 2.5 kHz Sine wave signal**

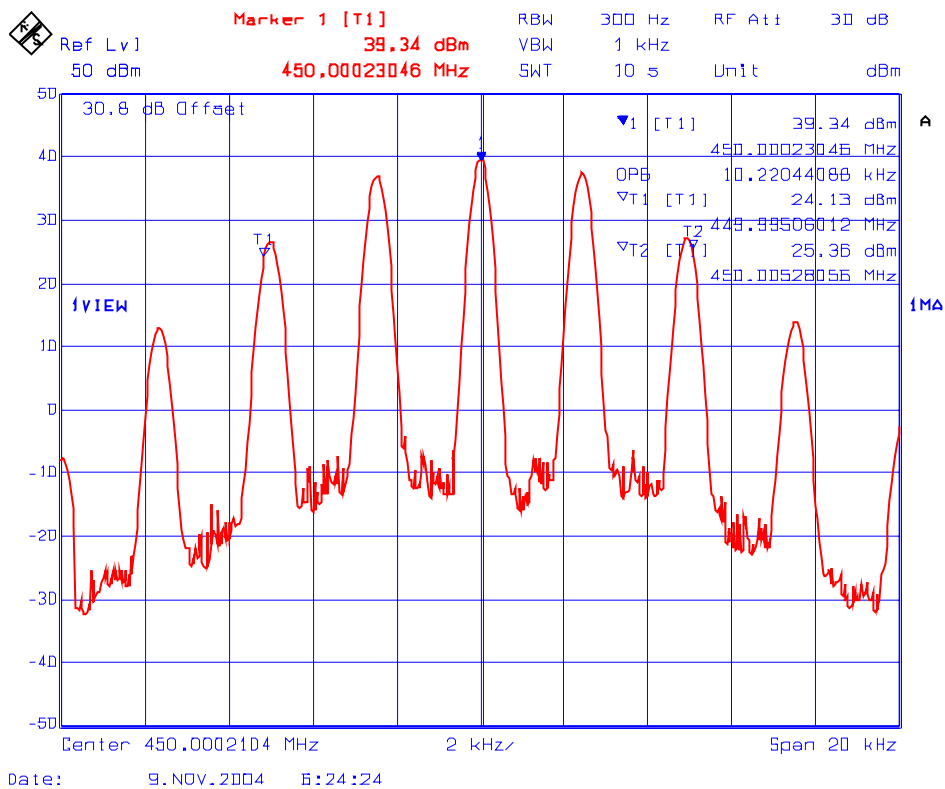

**ULTRATECH GROUP OF LABS**

3000 Bristol Circle, Oakville, Ontario, Canada L6H 6G4  
 Tel. #: 905-829-1570, Fax. #: 905-829-8050, Email: [vic@ultratech-labs.com](mailto:vic@ultratech-labs.com), Website: <http://www.ultratech-labs.com>

File #: FSG-039FCC90

December 06, 2004

All test results contained in this engineering test report are traceable to National Institute of Standards and Technology (NIST)

**PLOT # 3**      **99% Occupied Bandwidth**  
**Frequency: 470 MHz, 12.5 kHz Channel Spacing**  
**Modulation: FM modulation with 2.5 kHz sine wave signal**

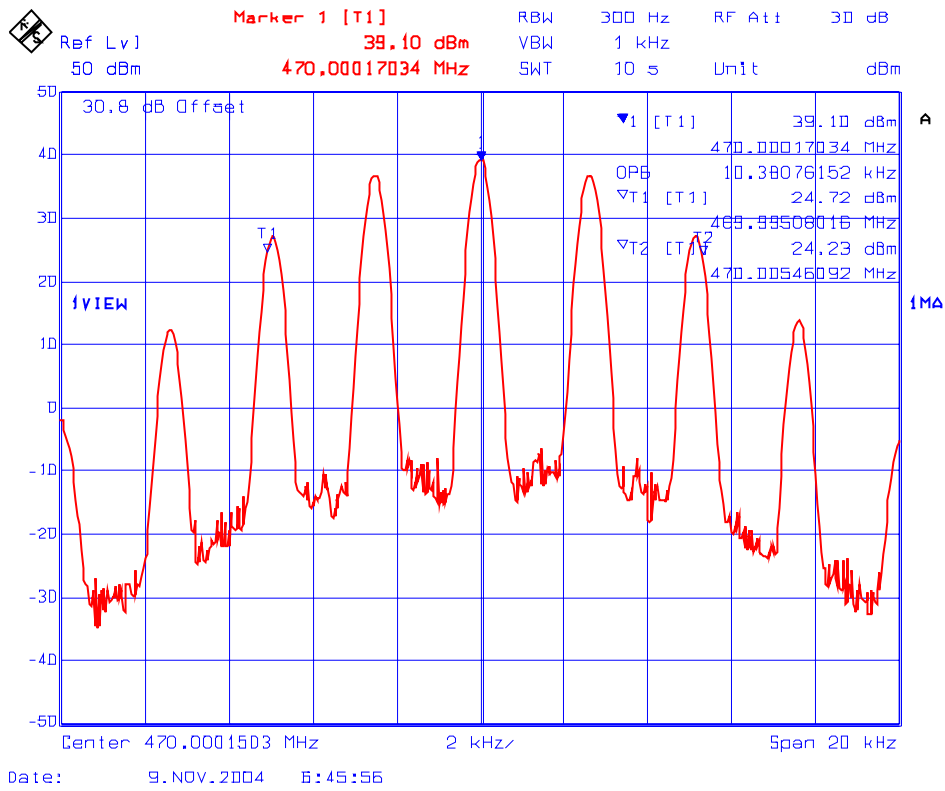



**PLOT # 4**      **99% Occupied Bandwidth**  
**Frequency: 406.1 MHz, 25 kHz Channel Spacing**  
**Modulation: FM modulation with 2.5 kHz sine wave signal**

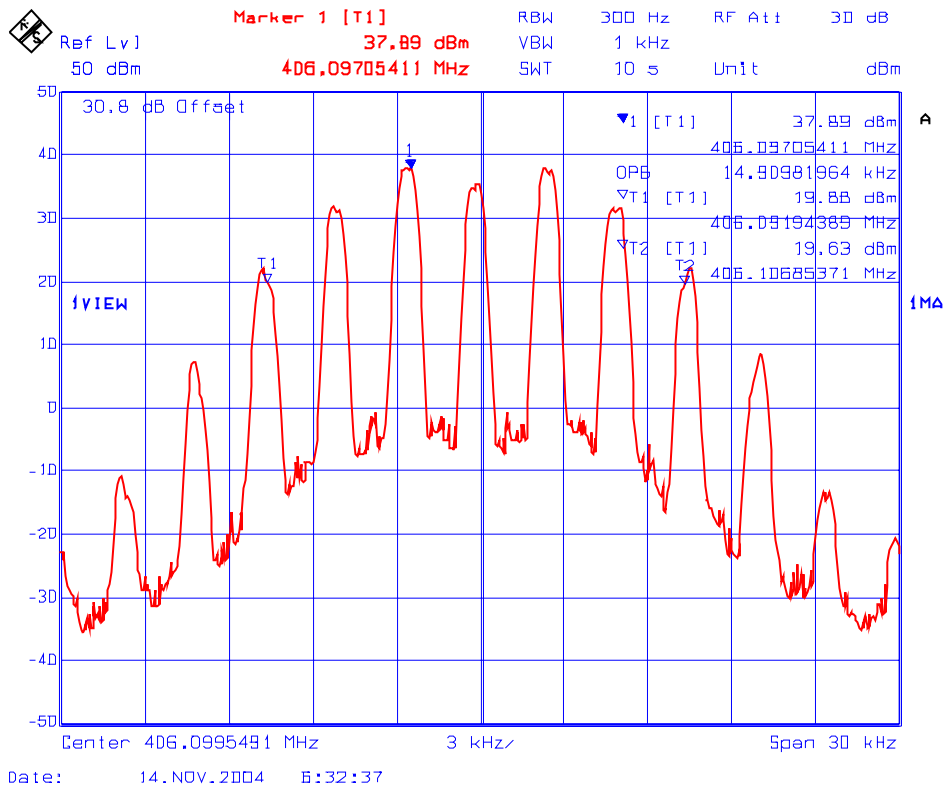

**PLOT # 5**      **99% Occupied Bandwidth**  
**Frequency: 450 MHz, 25 kHz Channel Spacing**  
**Modulation: FM modulation with 2.5 kHz sine wave signal**

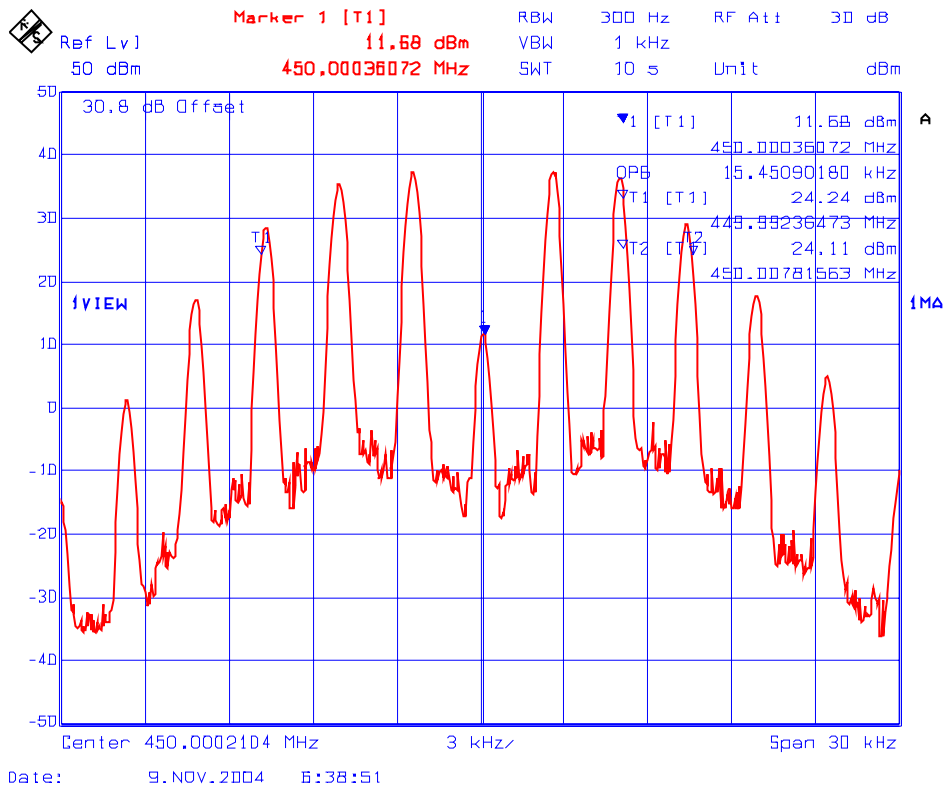

**ULTRATECH GROUP OF LABS**

3000 Bristol Circle, Oakville, Ontario, Canada L6H 6G4  
Tel. #: 905-829-1570, Fax. #: 905-829-8050, Email: [vic@ultratech-labs.com](mailto:vic@ultratech-labs.com), Website: <http://www.ultratech-labs.com>

File #: FSG-039FCC90

December 06, 2004

All test results contained in this engineering test report are traceable to National Institute of Standards and Technology (NIST)

**PLOT # 6**      **99% Occupied Bandwidth**  
**Frequency: 470 MHz, 25 kHz Channel Spacing**  
**Modulation: FM modulation with 2.5 sine wave signal**

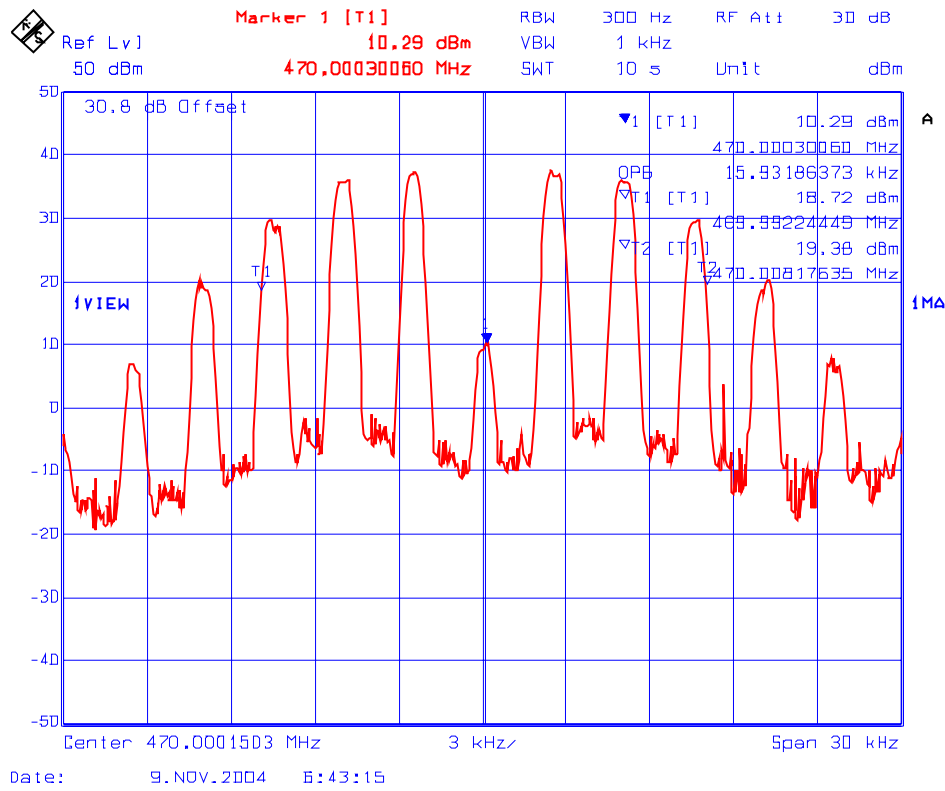

**ULTRATECH GROUP OF LABS**

3000 Bristol Circle, Oakville, Ontario, Canada L6H 6G4  
 Tel. #: 905-829-1570, Fax. #: 905-829-8050, Email: [vic@ultratech-labs.com](mailto:vic@ultratech-labs.com), Website: <http://www.ultratech-labs.com>

File #: FSG-039FCC90

December 06, 2004

All test results contained in this engineering test report are traceable to National Institute of Standards and Technology (NIST)

**PLOT # 7**      **99% Occupied Bandwidth**  
**Frequency: 406.1, 12.5 kHz Channel Spacing**  
**Modulation: C4FM digital modulation**

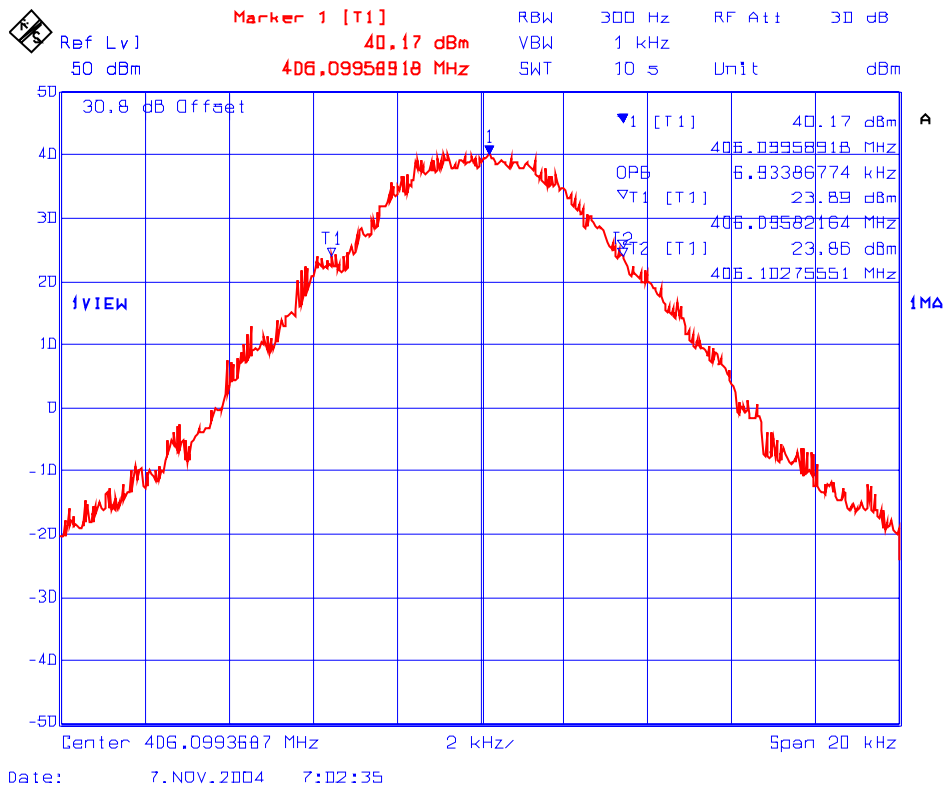

**PLOT # 8**      **99% Occupied Bandwidth**  
**Frequency: 450 MHz, 12.5 kHz Channel Spacing**  
**Modulation: C4FM digital modulation**

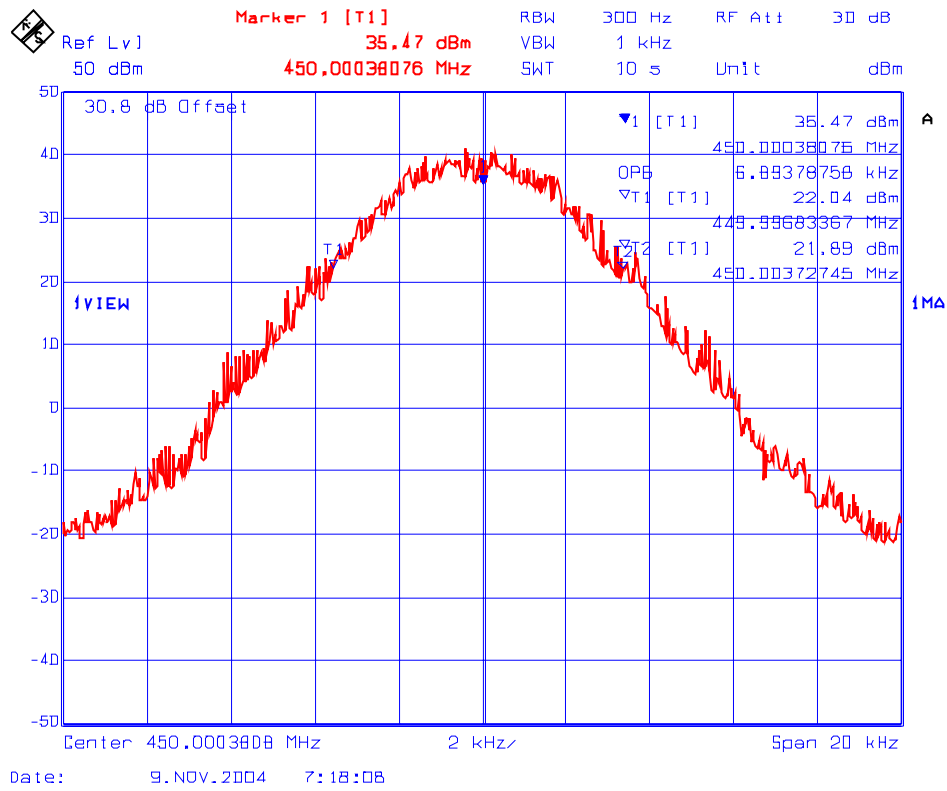

**PLOT # 9 99% Occupied Bandwidth**  
**Frequency: 470 MHz, 12.5 kHz Channel Spacing**  
**Modulation: C4FM digital modulation**

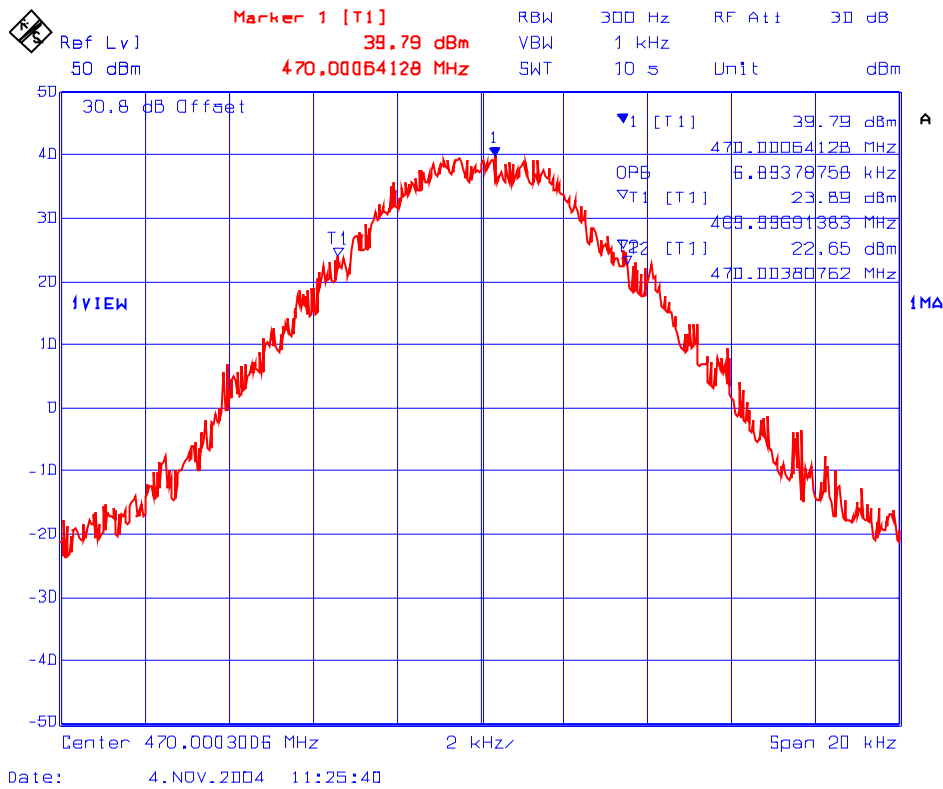

6.10.5.2. Emission Masks

Conform. See the following test data plots (10 through 41) for details.

6.10.5.2.1. Emission Mask B, RF output, Repeater Mode

See the following plots (10 through 15) for details.

**PLOT # 10** Emission Mask B, *Repeater Mode*  
RF Input: 406.1 MHz, 0 dBm  
RF Output: 406.1 MHz, 25 kHz Channel Spacing, High Power  
Modulation: FM modulation with 2.5 kHz Sine wave signal

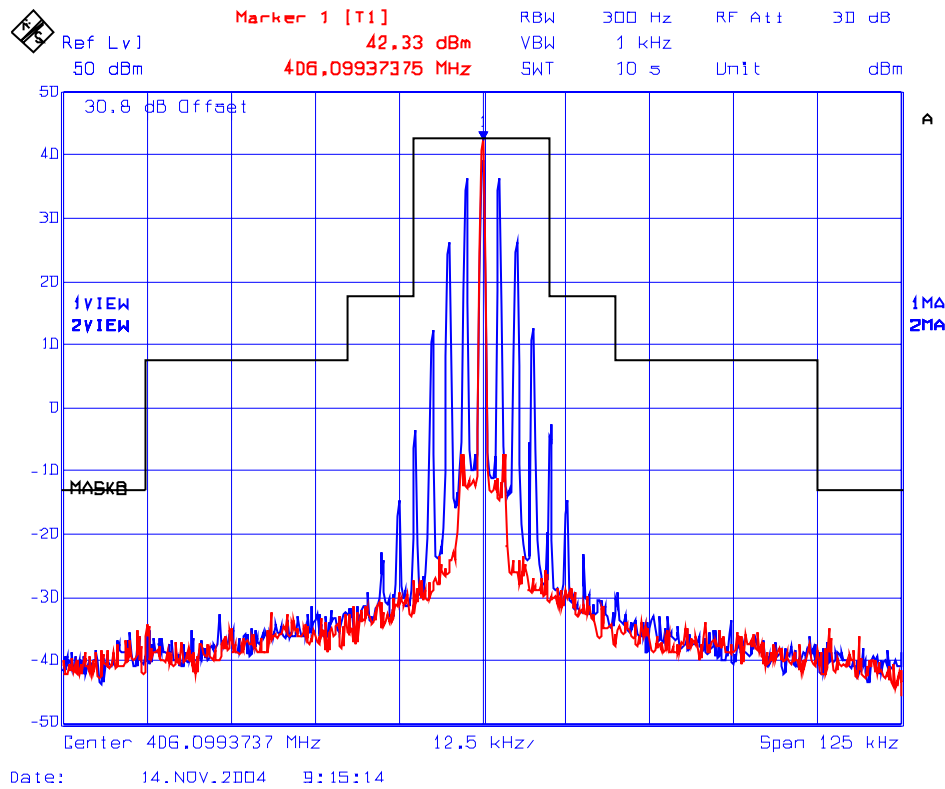

**PLOT # 11**    **Emission Mask B, *Repeater Mode***  
**RF Input: 450 MHz, 0 dBm**  
**RF Output: 450 MHz, 25 kHz Channel Spacing, High Power**  
**Modulation: FM modulation with 2.5 kHz Sine wave signal**

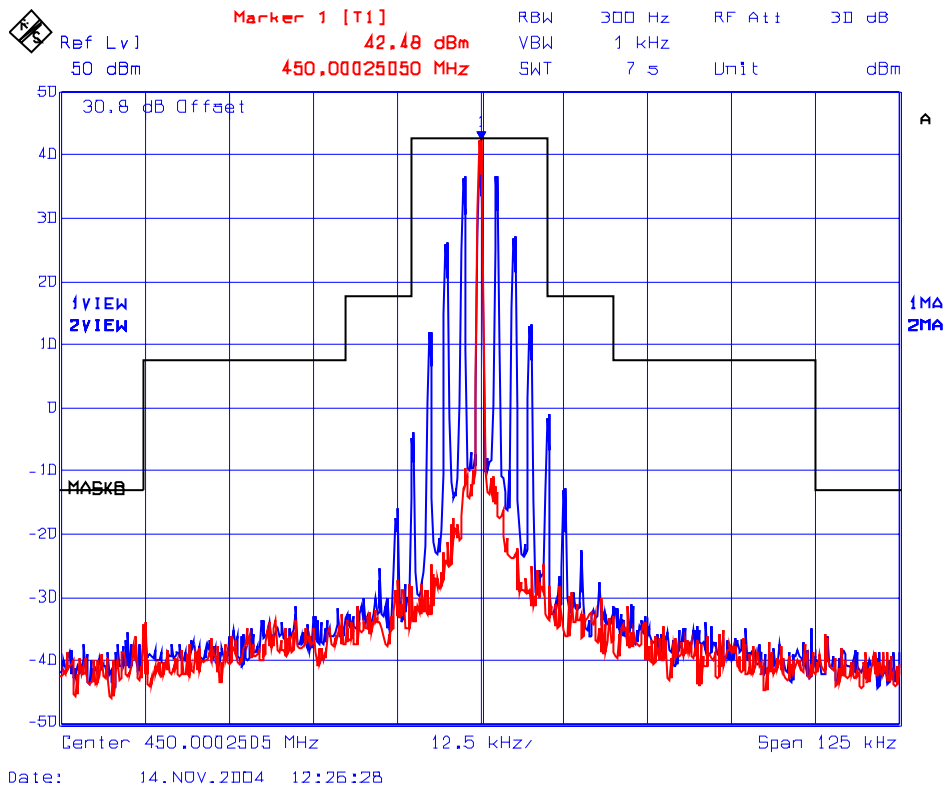

**ULTRATECH GROUP OF LABS**

3000 Bristol Circle, Oakville, Ontario, Canada L6H 6G4  
Tel. #: 905-829-1570, Fax. #: 905-829-8050, Email: [vic@ultratech-labs.com](mailto:vic@ultratech-labs.com), Website: <http://www.ultratech-labs.com>

File #: FSG-039FCC90

December 06, 2004

All test results contained in this engineering test report are traceable to National Institute of Standards and Technology (NIST)



**PLOT # 12**      **Emission Mask B, *Repeater Mode***  
**RF Input: 470 MHz, 0dBm**  
**RF Output: 470 MHz, 25 kHz Channel Spacing, High Power**  
**Modulation: FM modulation with 2.5 kHz Sine wave signal**

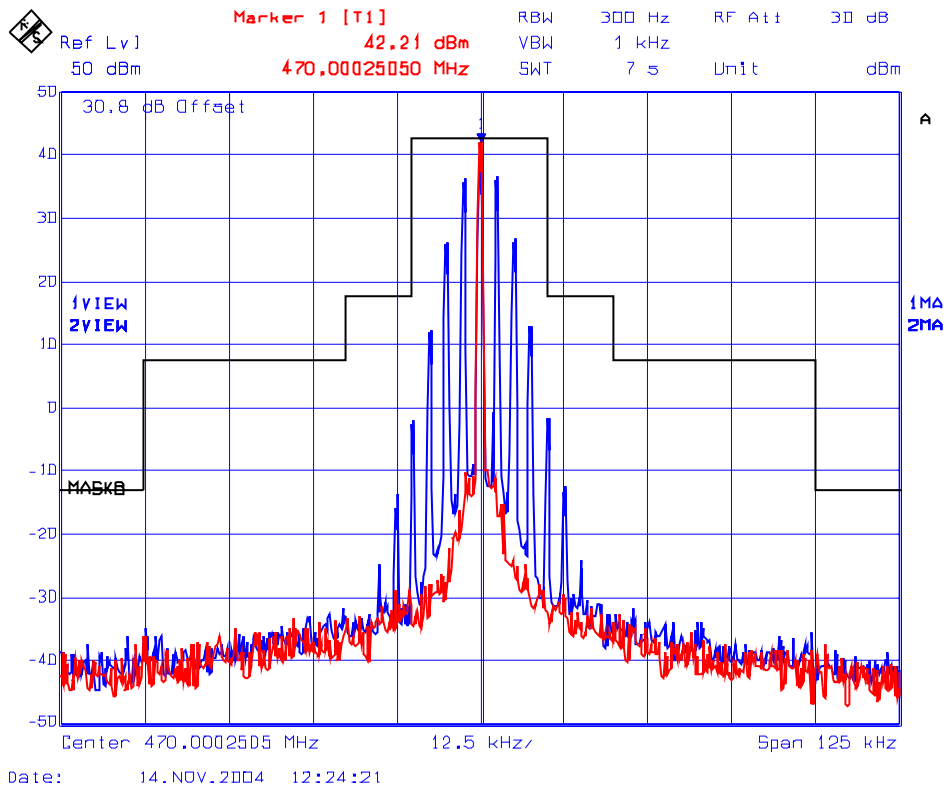

**ULTRATECH GROUP OF LABS**

3000 Bristol Circle, Oakville, Ontario, Canada L6H 6G4  
Tel. #: 905-829-1570, Fax. #: 905-829-8050, Email: [vic@ultratech-labs.com](mailto:vic@ultratech-labs.com), Website: <http://www.ultratech-labs.com>

File #: FSG-039FCC90

December 06, 2004

All test results contained in this engineering test report are traceable to National Institute of Standards and Technology (NIST)

**PLOT # 13**      **Emission Mask B, Repeater Mode**  
**RF Input: 406.1 MHz, 0dBm**  
**RF Output: 406.1 MHz, 25 kHz Channel Spacing, Low Power**  
**Modulation: FM modulation with 2.5 kHz Sine wave signal**

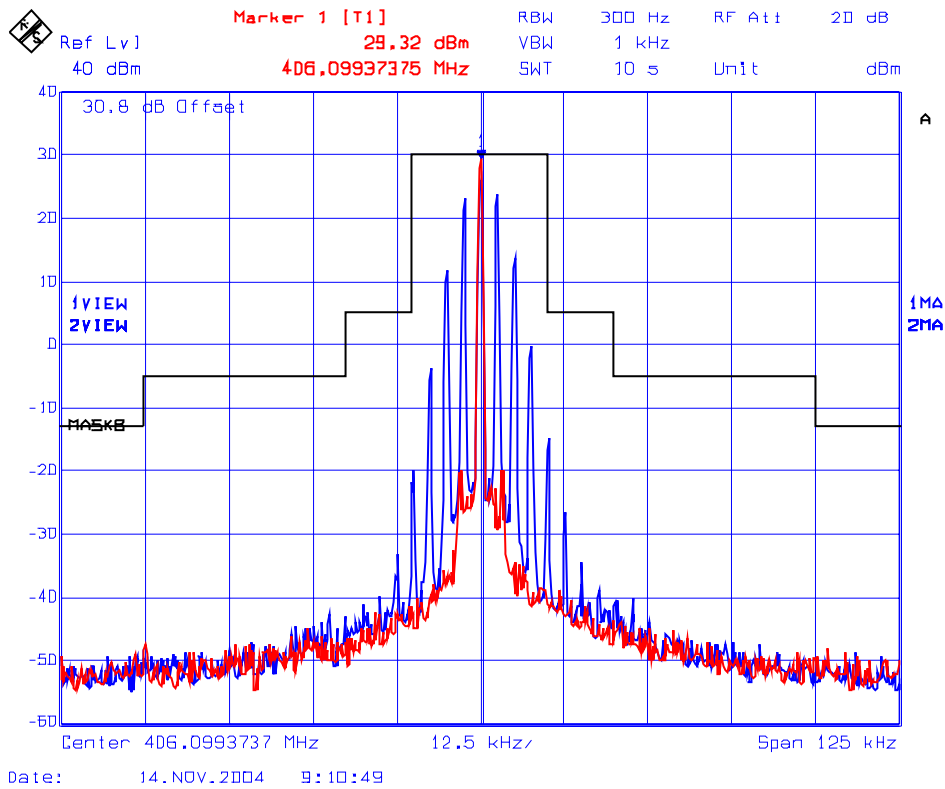

**PLOT # 14**    **Emission Mask B, *Repeater Mode***  
**RF Input: 450 MHz, 0dBm**  
**RF Output: 450 MHz, 25 kHz Channel Spacing, Low Power**  
**Modulation: FM modulation with 2.5 kHz sine wave signal**

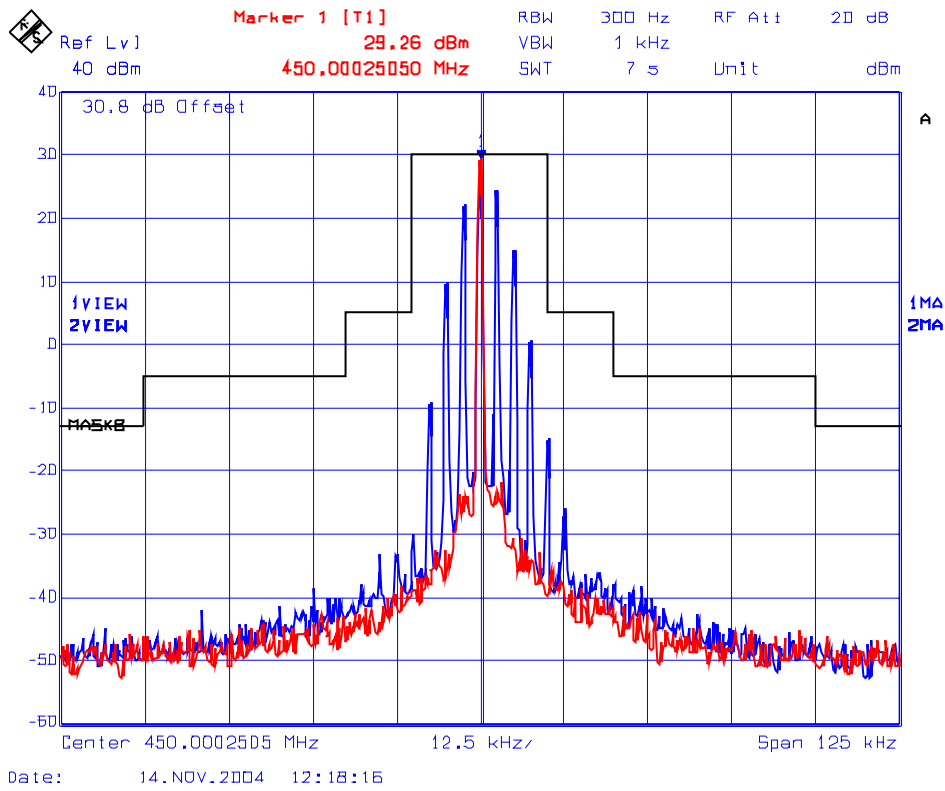

**ULTRATECH GROUP OF LABS**

3000 Bristol Circle, Oakville, Ontario, Canada L6H 6G4  
Tel. #: 905-829-1570, Fax. #: 905-829-8050, Email: [vic@ultratech-labs.com](mailto:vic@ultratech-labs.com), Website: <http://www.ultratech-labs.com>

File #: FSG-039FCC90

December 06, 2004

All test results contained in this engineering test report are traceable to National Institute of Standards and Technology (NIST)

**PLOT # 15**    **Emission Mask B, *Repeater Mode***  
**RF Input: 470 MHz, 0 dBm**  
**RF Output: 470 MHz, 25 kHz Channel Spacing, Low Power**  
**Modulation: FM modulation with 2.5 kHz sine wave signal**

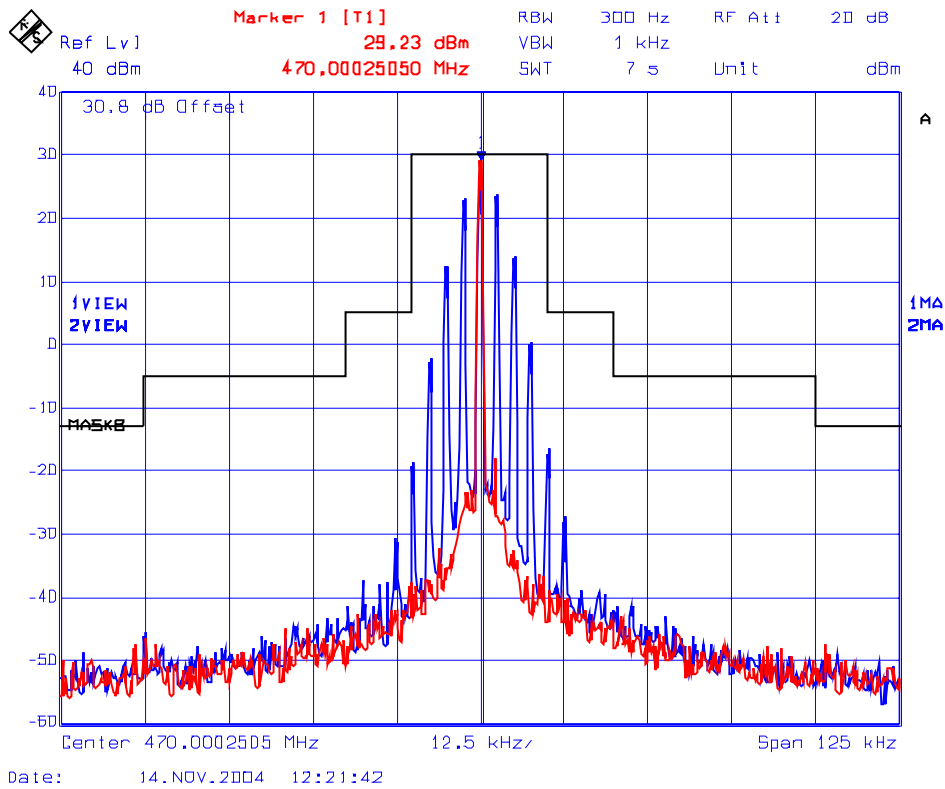

**ULTRATECH GROUP OF LABS**

3000 Bristol Circle, Oakville, Ontario, Canada L6H 6G4  
Tel. #: 905-829-1570, Fax. #: 905-829-8050, Email: [vic@ultratech-labs.com](mailto:vic@ultratech-labs.com), Website: <http://www.ultratech-labs.com>

File #: FSG-039FCC90

December 06, 2004

All test results contained in this engineering test report are traceable to National Institute of Standards and Technology (NIST)

6.10.5.2.2. Emission Mask B, RF input, Repeater Mode

See the following plot (#16) for details.

PLOT # 16 Emission Mask B, Repeater Mode  
RF Input: 450 MHz, 0 dBm, 25 kHz Channel Spacing  
Modulation: FM modulation with 2.5 kHz sine wave signal

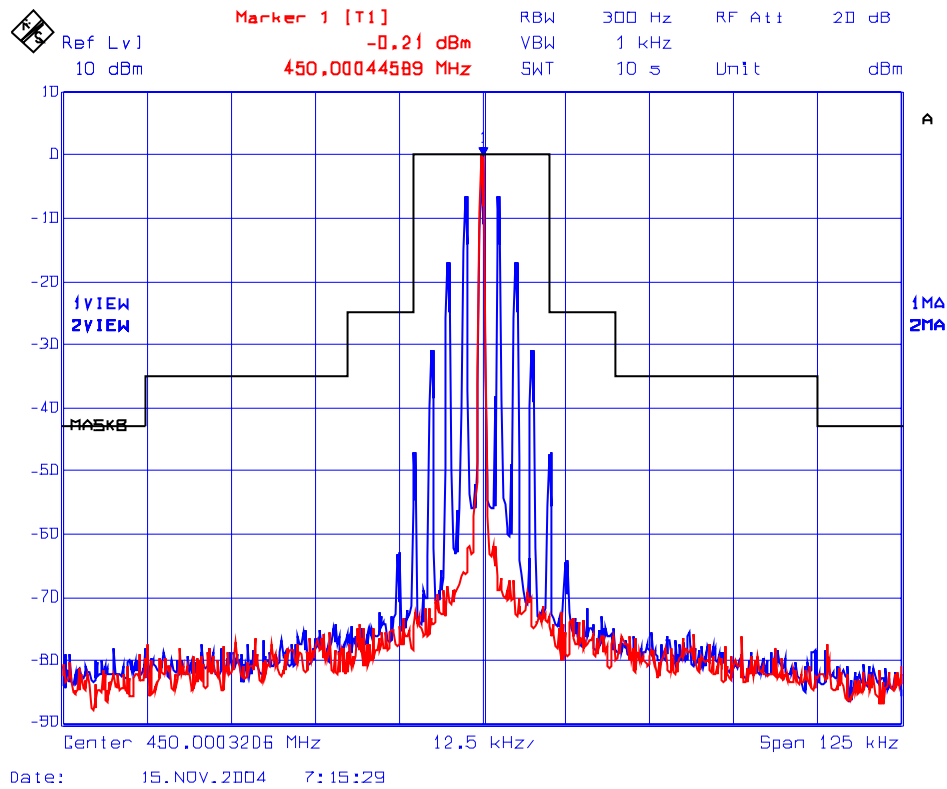

6.10.5.2.3. Emission Mask D, RF output, Repeater Mode

See the following plots (plot #17 through 22) for details.

**PLOT # 17** Emission Mask D, Repeater Mode  
RF Input: 406.1 MHz, 0 dBm  
RF Output: 406.1 MHz, 12.5 kHz Channel Spacing, High Power  
Modulation: FM modulation with 2.5 kHz sine wave signal

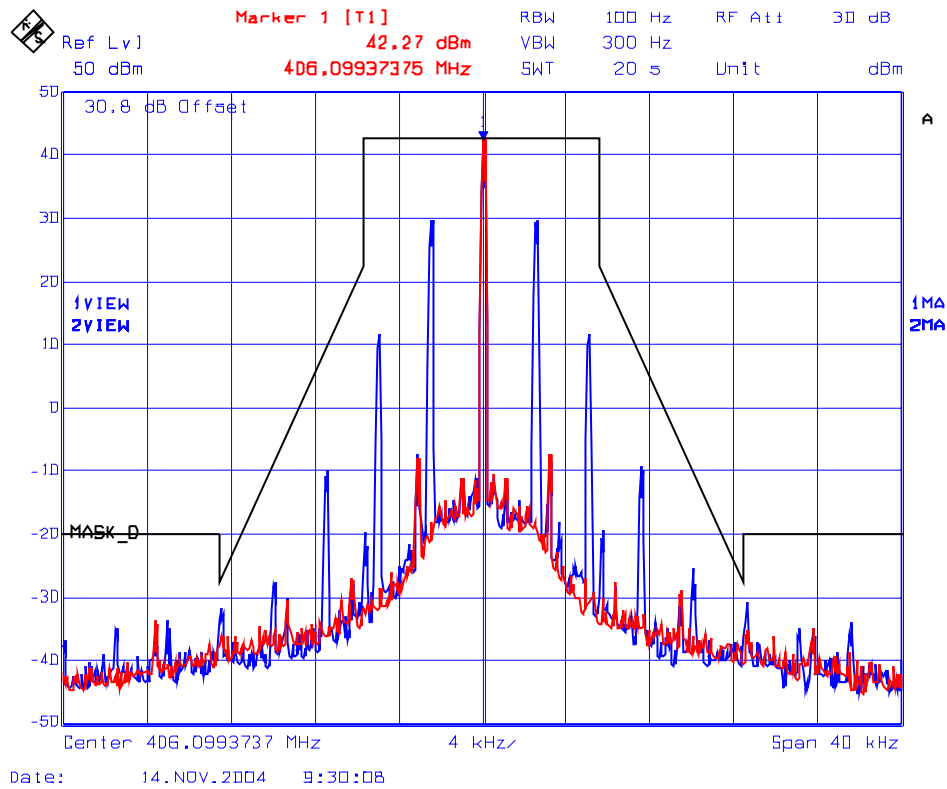

**PLOT # 18**      **Emission Mask D, *Repeater Mode***  
**RF Input: 450 MHz, 0 dBm**  
**RF Output: 450 MHz, 12.5 kHz Channel Spacing, High Power**  
**Modulation: FM modulation with 2.5 kHz Sine wave signal**

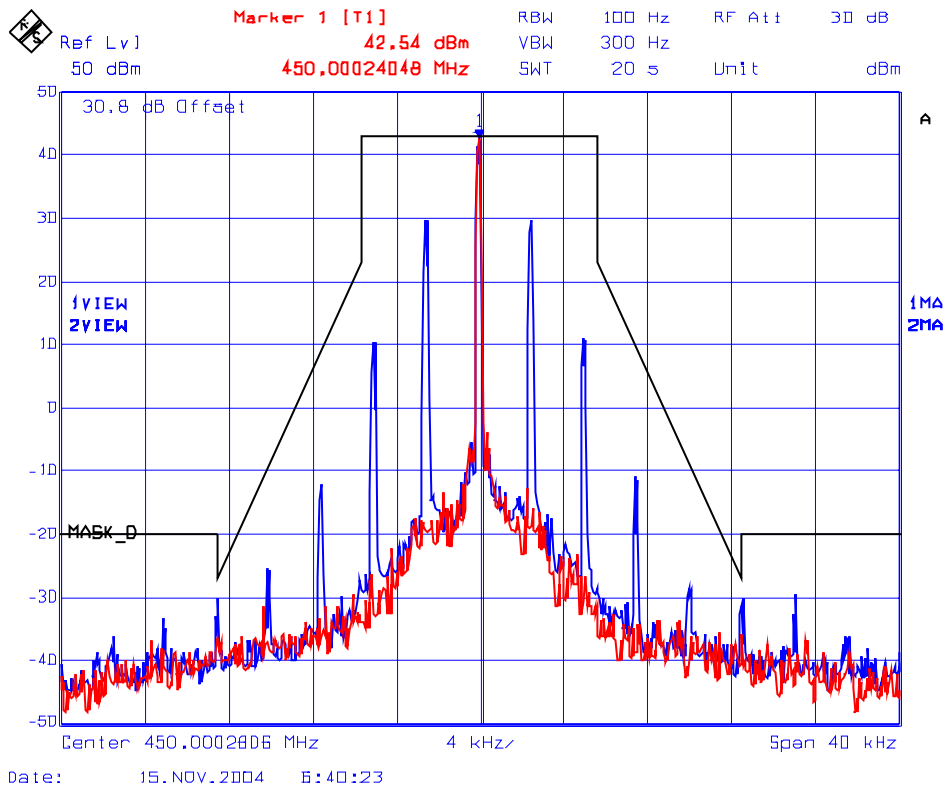

**PLOT # 19**      **Emission Mask D, Repeater Mode**  
**RF Input: 470 MHz, 0dBm**  
**RF Output: 470 MHz, 12.5 kHz Channel Spacing, High Power**  
**Modulation: FM modulation with 2.5 kHz Sine wave signal**

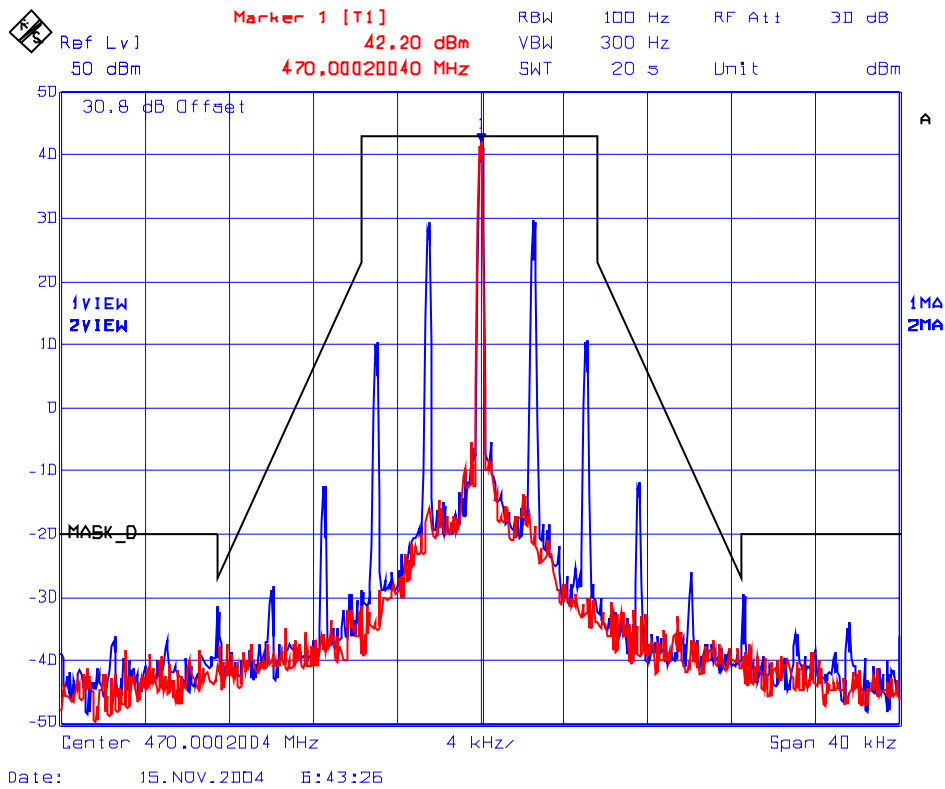

**ULTRATECH GROUP OF LABS**

3000 Bristol Circle, Oakville, Ontario, Canada L6H 6G4  
Tel. #: 905-829-1570, Fax. #: 905-829-8050, Email: [vic@ultratech-labs.com](mailto:vic@ultratech-labs.com), Website: <http://www.ultratech-labs.com>

File #: FSG-039FCC90

December 06, 2004

All test results contained in this engineering test report are traceable to National Institute of Standards and Technology (NIST)



**PLOT # 20**      **Emission Mask D, *Repeater Mode***  
**RF Input: 406.1 MHz, 0 dBm**  
**RF Output: 406.1 MHz, 12.5 kHz Channel Spacing, Low Power**  
**Modulation: FM modulation with 2.5 kHz Sine wave signal**

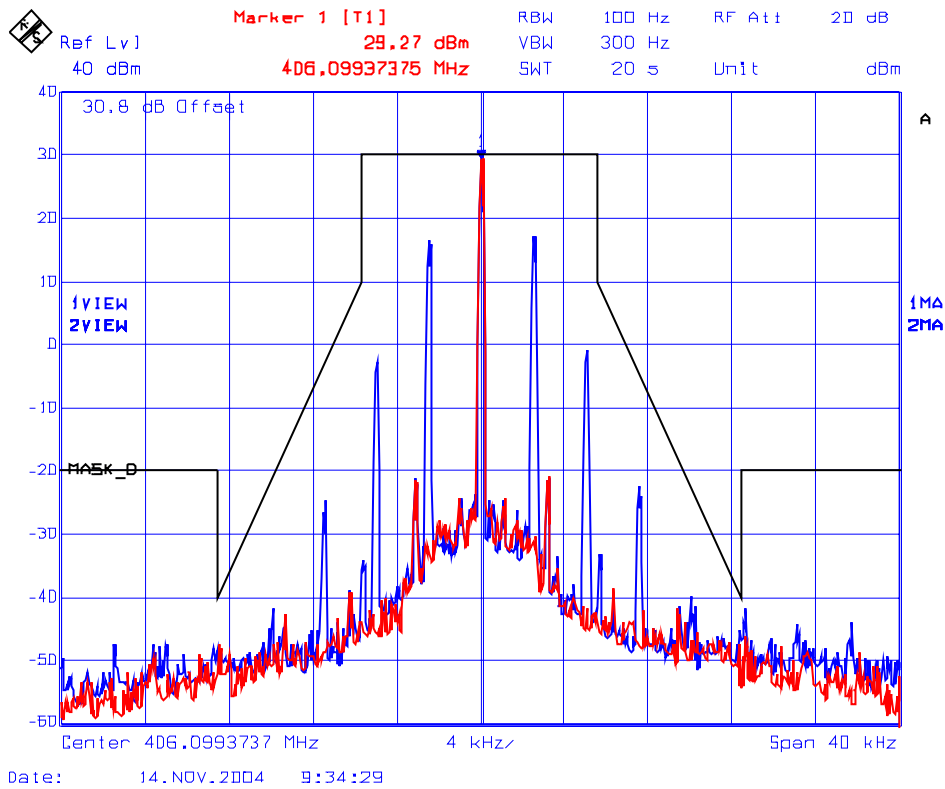

**ULTRATECH GROUP OF LABS**

3000 Bristol Circle, Oakville, Ontario, Canada L6H 6G4  
Tel. #: 905-829-1570, Fax. #: 905-829-8050, Email: [vic@ultratech-labs.com](mailto:vic@ultratech-labs.com), Website: <http://www.ultratech-labs.com>

File #: FSG-039FCC90

December 06, 2004

All test results contained in this engineering test report are traceable to National Institute of Standards and Technology (NIST)

**PLOT # 21**    **Emission Mask D, *Repeater Mode***  
**RF Input: 450 Mhz, 0 dBm**  
**RF Output: 450 MHz, 12.5 kHz Channel Spacing, Low Power**  
**Modulation: FM modulation with 2.5 kHz Sine wave signal**

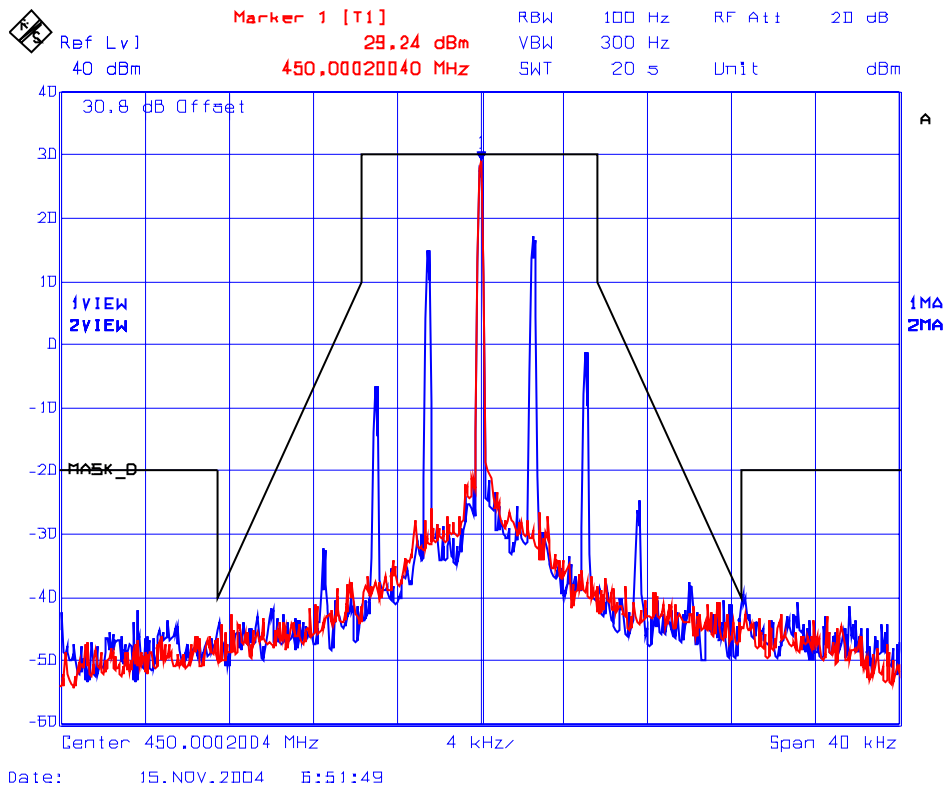

**PLOT # 22**    **Emission Mask D, *Repeater Mode***  
**RF Input: 470 MHz, 0 dBm**  
**RF Output: 470 MHz, 12.5 kHz Channel Spacing, Low Power**  
**Modulation: FM modulation with 2.5 kHz sine wave signal**

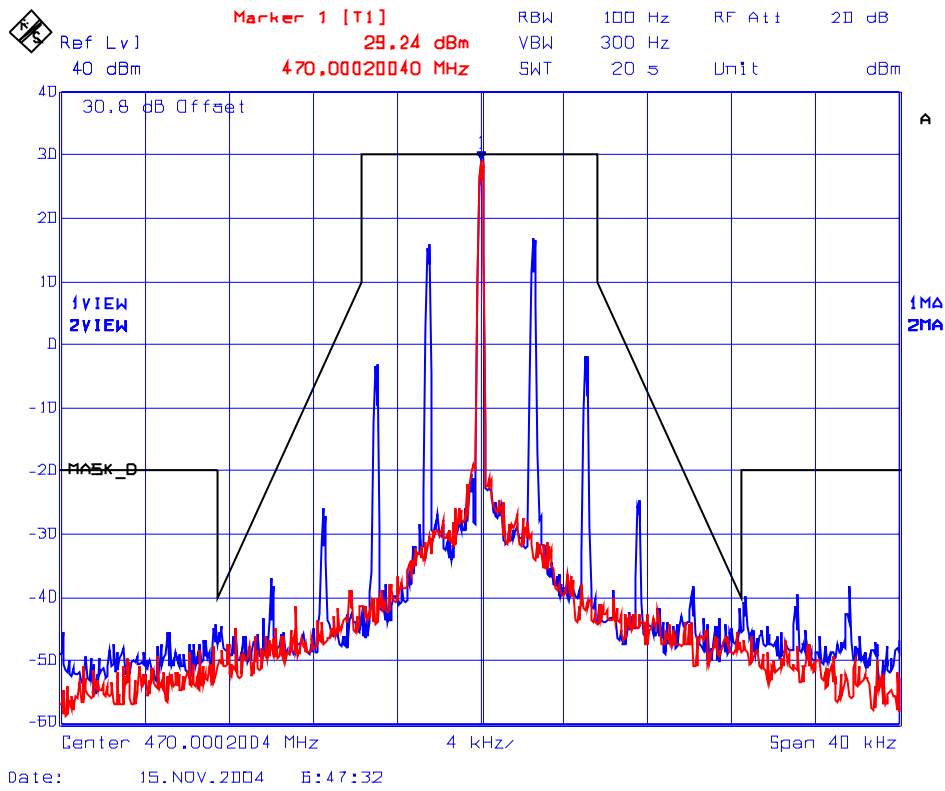

6.10.5.2.4. Emission Mask D, RF input, Repeater Mode

See the following plot (#23) for details.

**PLOT # 23** Emission Mask D, *Repeater Mode*  
RF Input: 450 MHz, 12.5 kHz Channel Spacing  
Modulation: FM modulation with 2.5 kHz sine wave signal

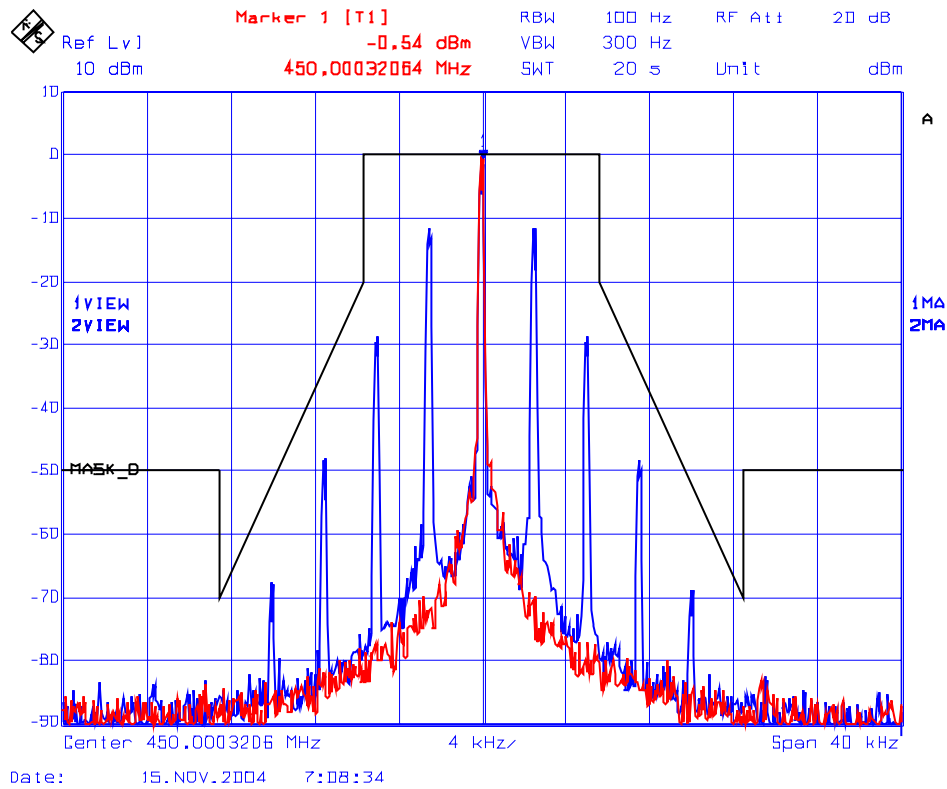

6.10.5.2.5. Emission Mask B & D, Transmitter Mode

See the following plots (plot #24 through 41) for details.

**PLOT # 24** Emission Mask B, *Transmitter Mode*  
Frequency: 406.1 MHz, 25 kHz Channel Spacing, High Power  
Modulation: FM modulation with 2.5 kHz sine wave signal

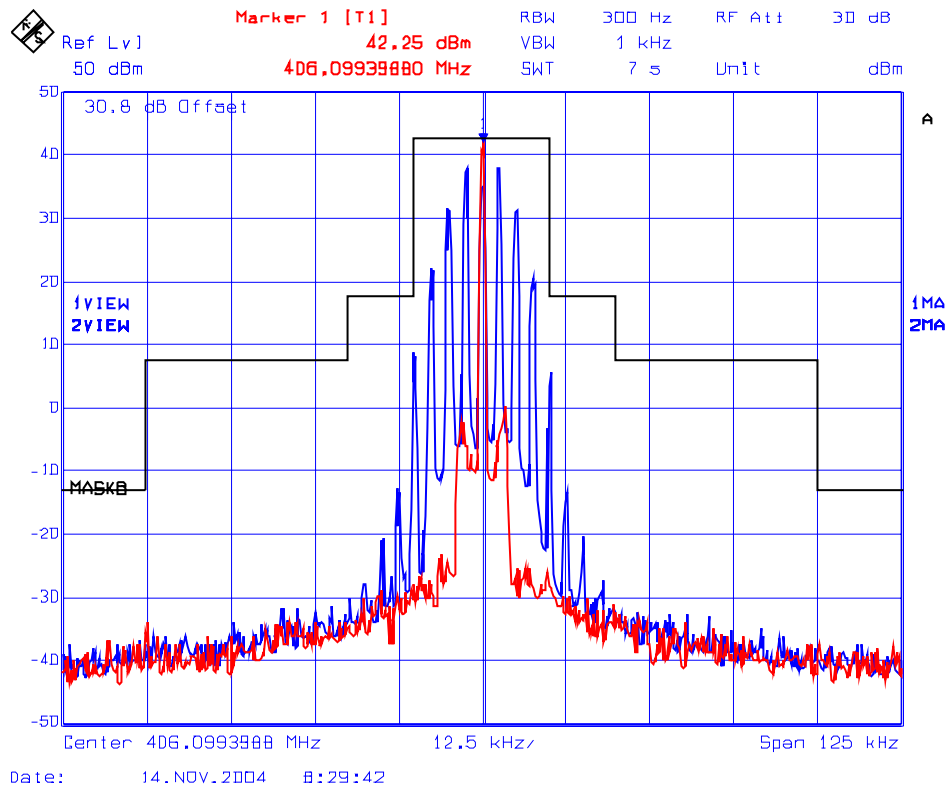

**PLOT # 25**      **Emission Mask B, *Transmitter Mode***  
**Frequency: 450 MHz, 25 kHz Channel Spacing, High Power**  
**Modulation: FM modulation with 2.5 kHz sine wave signal**

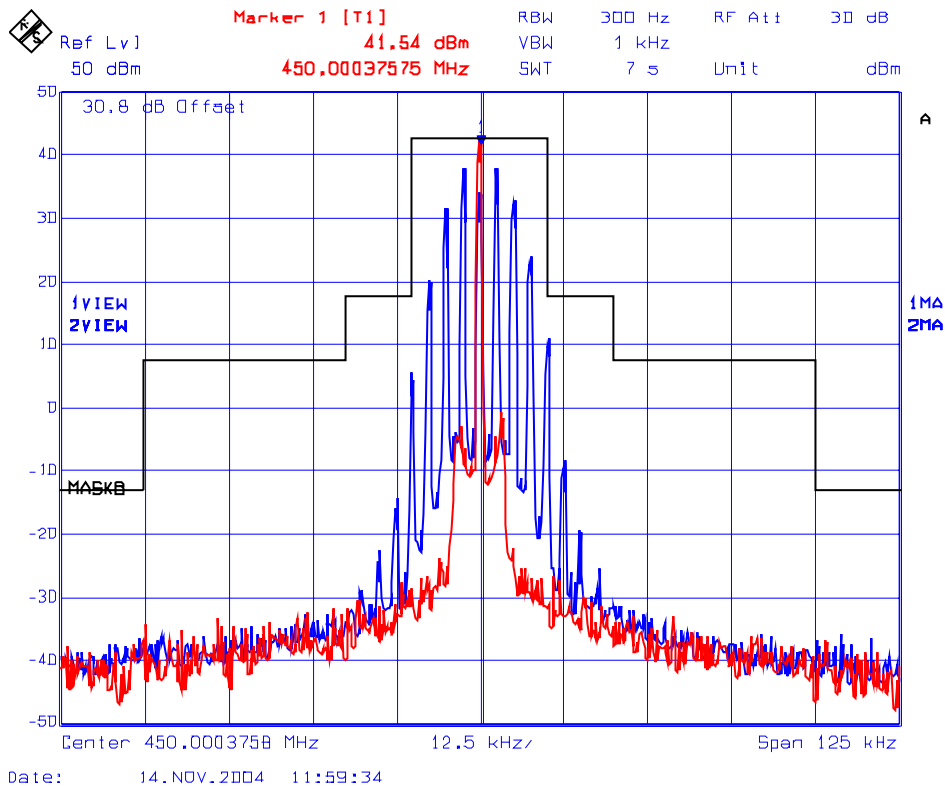

**PLOT # 26**      **Emission Mask B, *Transmitter Mode***  
**Frequency: 470 MHz, 25 kHz Channel Spacing, High Power**  
**Modulation: FM modulation with 2.5 kHz sine wave signal**

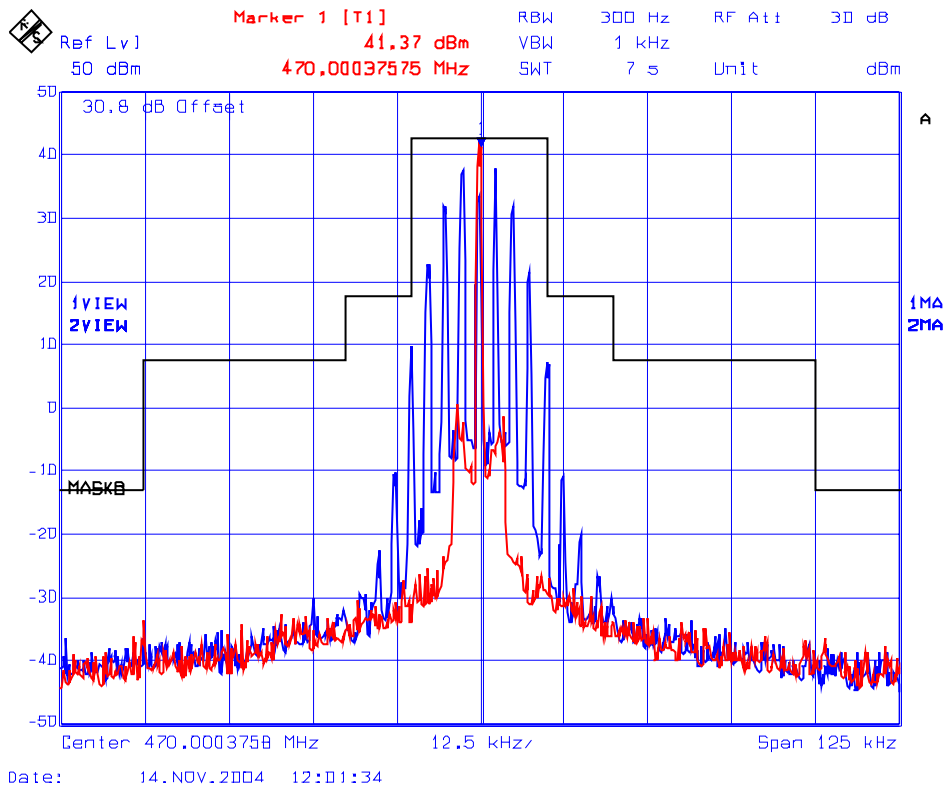

**PLOT # 27** Emission Mask B, *Transmitter Mode*  
Frequency: 406.1 MHz, 25 kHz Channel Spacing, Low Power  
Modulation: FM modulation with 2.5 kHz sine wave signal

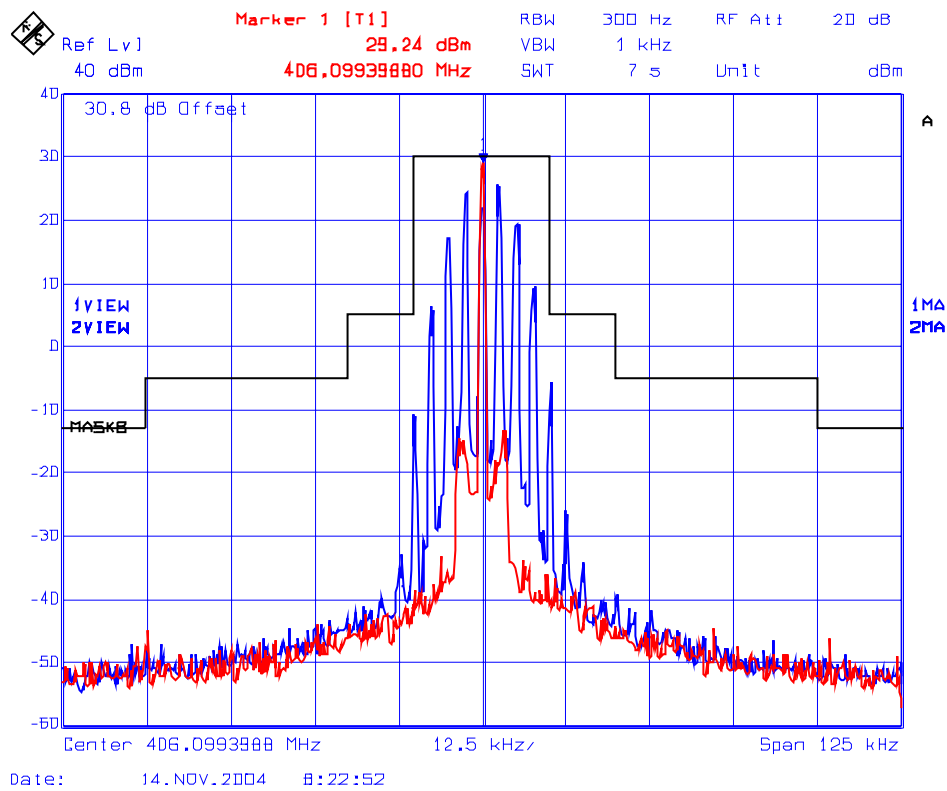

**ULTRATECH GROUP OF LABS**

3000 Bristol Circle, Oakville, Ontario, Canada L6H 6G4  
Tel. #: 905-829-1570, Fax. #: 905-829-8050, Email: [vic@ultratech-labs.com](mailto:vic@ultratech-labs.com), Website: <http://www.ultratech-labs.com>

File #: FSG-039FCC90

December 06, 2004

All test results contained in this engineering test report are traceable to National Institute of Standards and Technology (NIST)



**PLOT # 28**      **Emission Mask B, *Transmitter Mode***  
**Frequency: 450 MHz, 25 kHz Channel Spacing, Low Power**  
**Modulation: FM modulation with 2.5 kHz sine wave signal**

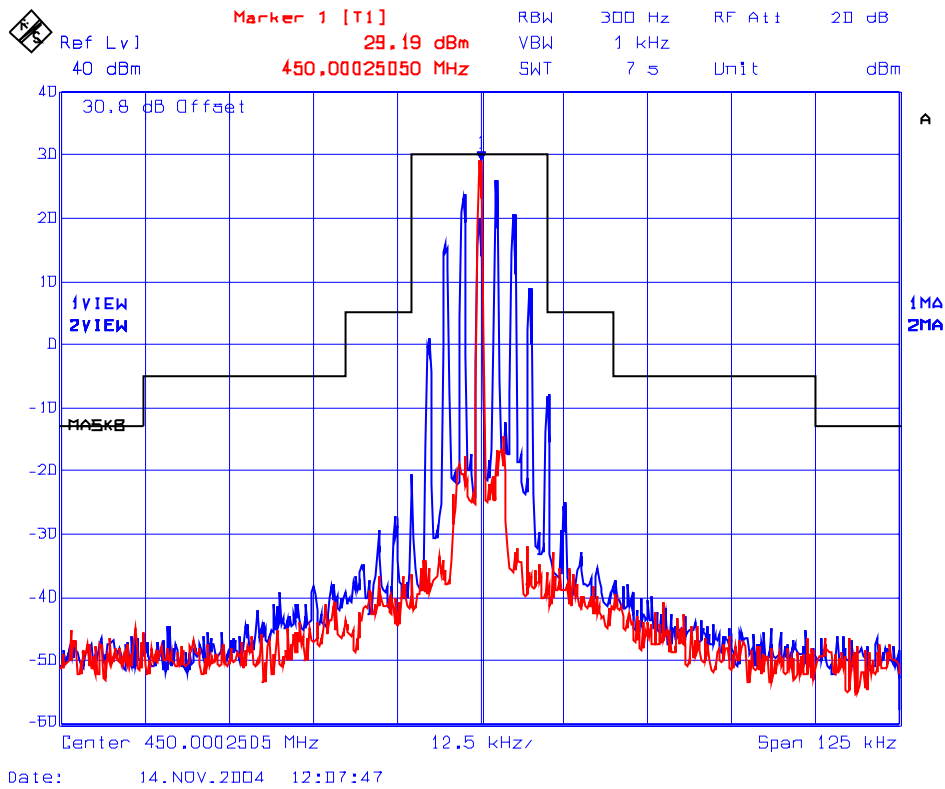

**PLOT # 29**      **Emission Mask B, *Transmitter Mode***  
**Frequency: 470 MHz, 25 kHz Channel Spacing, Low Power**  
**Modulation: FM modulation with 2.5 kHz sine wave signal**

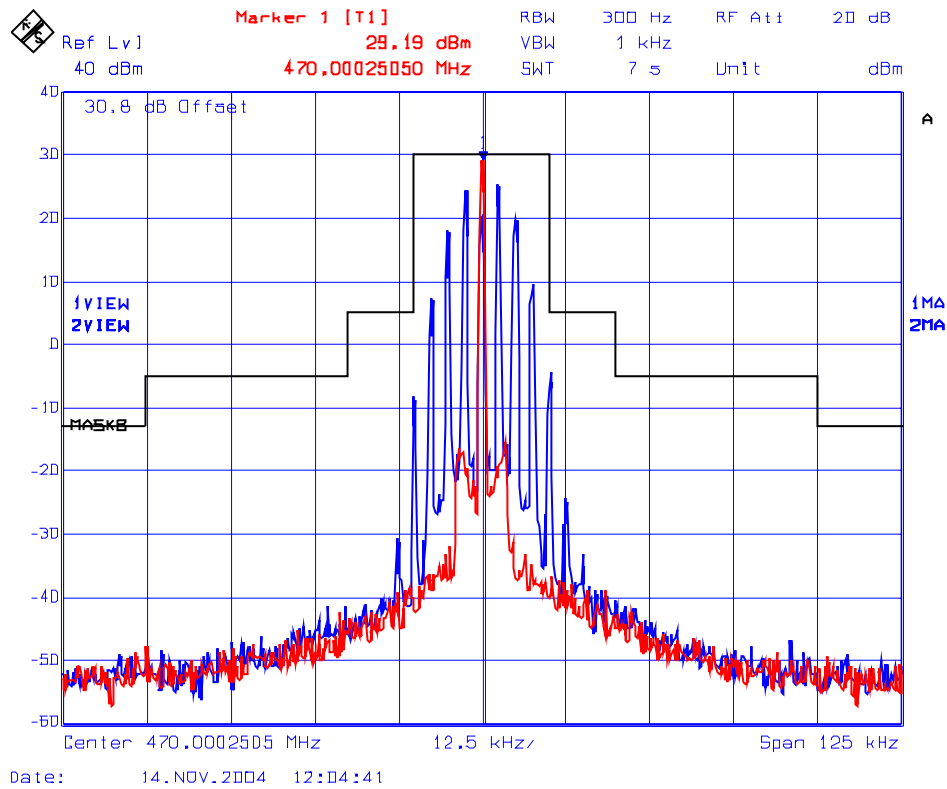

**PLOT # 30**      **Emission Mask D, *Transmitter Mode***  
**Frequency: 406.1 MHz, 12.5 kHz Channel Spacing, High Power**  
**Modulation: FM modulation with 2.5 kHz sine wave signal**

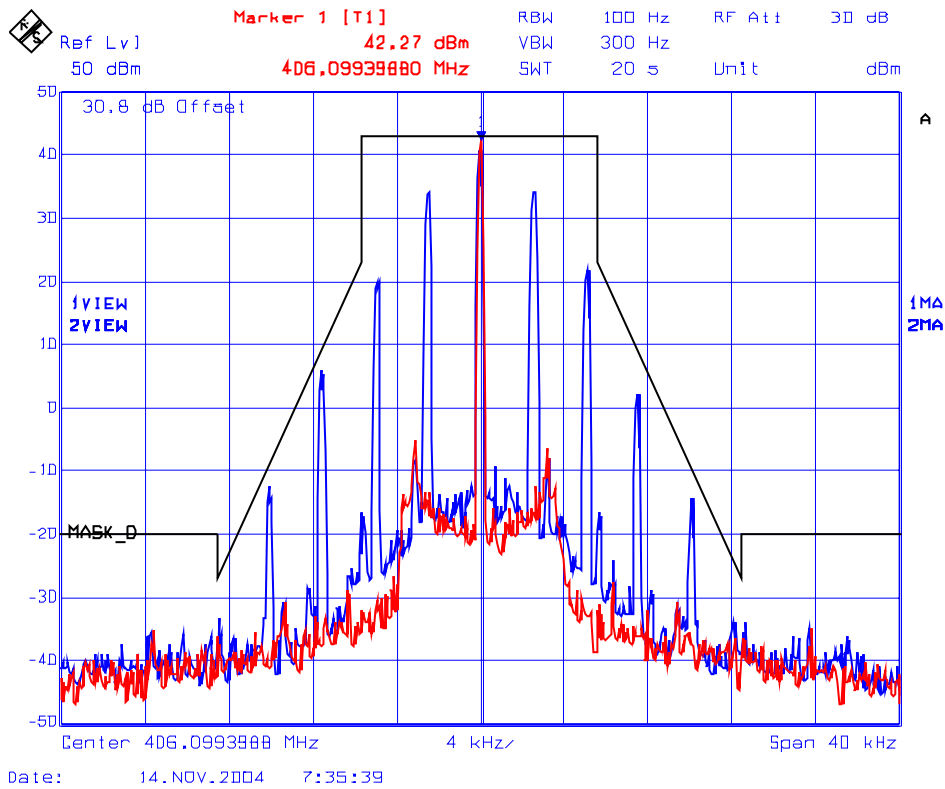

**PLOT # 31**      **Emission Mask D, *Transmitter Mode***  
**Frequency: 450 MHz, 12.5 kHz Channel Spacing, High Power**  
**Modulation: FM modulation with 2.5 kHz sine wave signal**

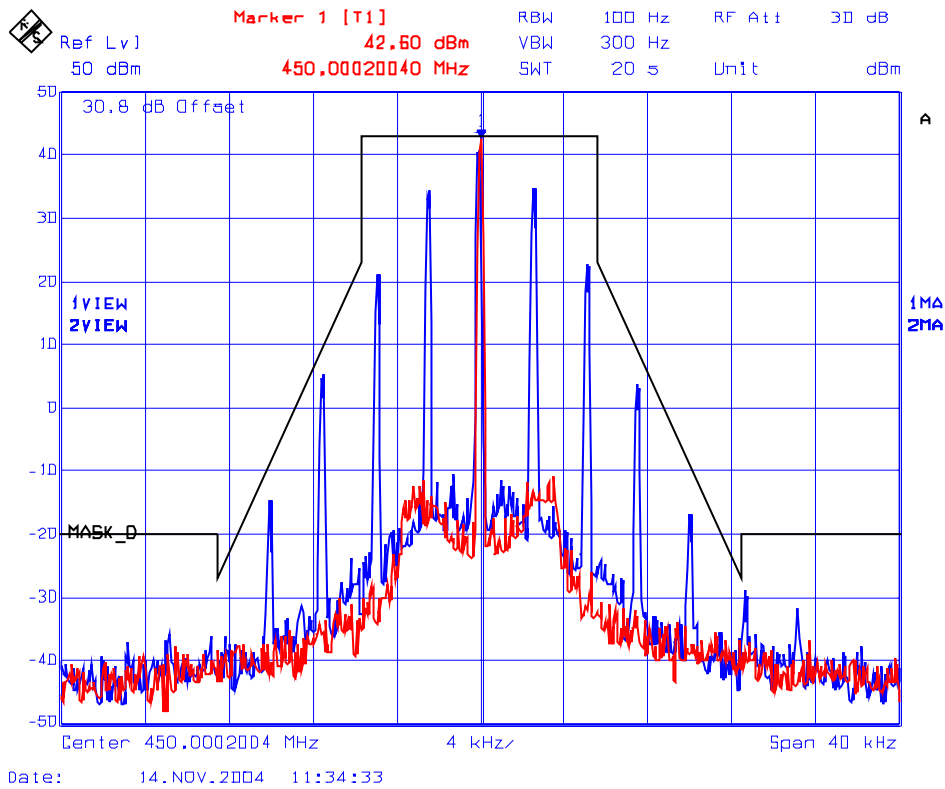

**PLOT # 32**      **Emission Mask D, *Transmitter Mode***  
**Frequency: 470 MHz, 12.5 kHz Channel Spacing, High Power**  
**Modulation: FM modulation with 2.5 kHz sine wave signal**

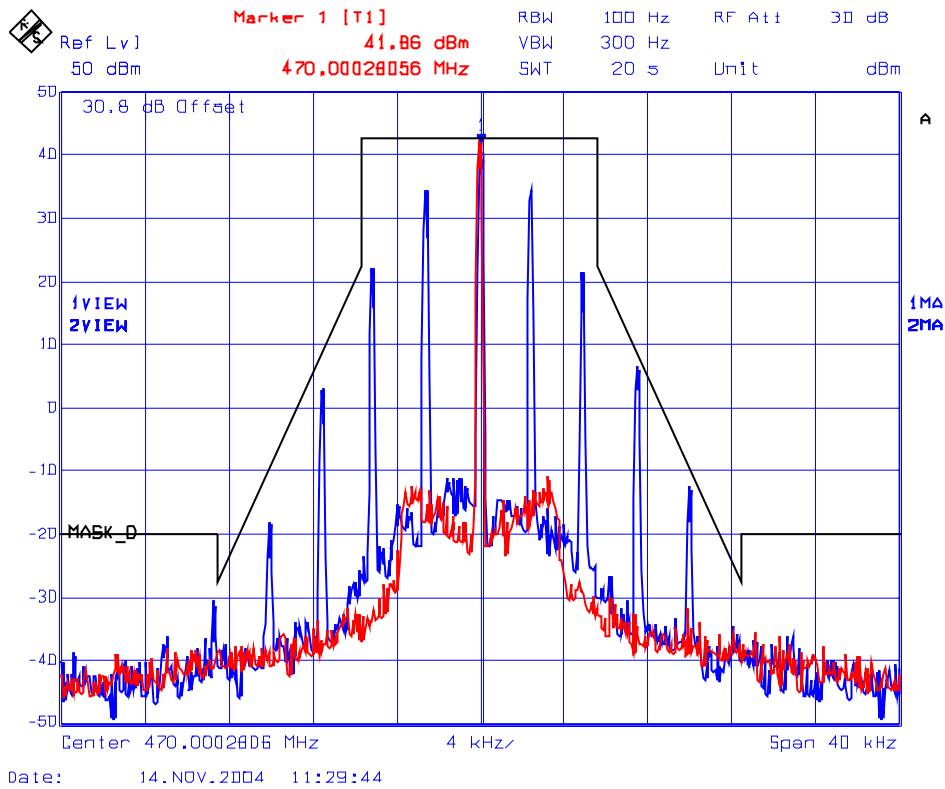

**PLOT # 33**      **Emission Mask D, *Transmitter Mode***  
**Frequency: 406.1 MHz, 12.5 kHz Channel Spacing, Low Power**  
**Modulation: FM modulation with 2.5 kHz sine wave signal**

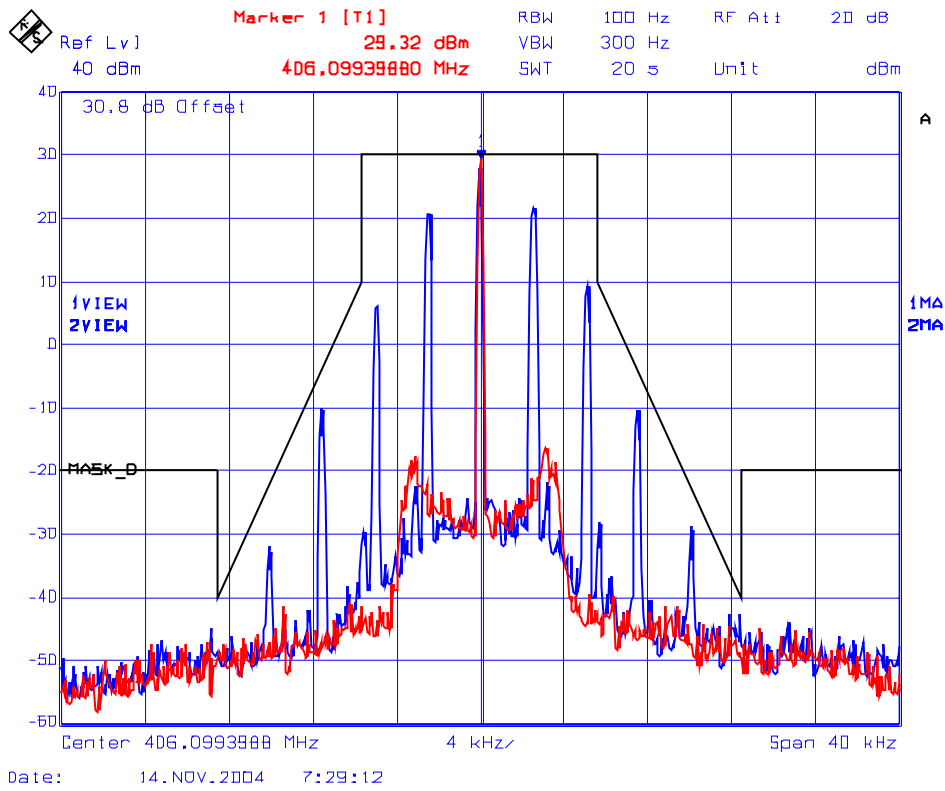

**PLOT # 34**      **Emission Mask D, *Transmitter Mode***  
**Frequency: 450 MHz, 12.5 kHz Channel Spacing, Low Power**  
**Modulation: FM modulation with 2.5 kHz sine wave signal**

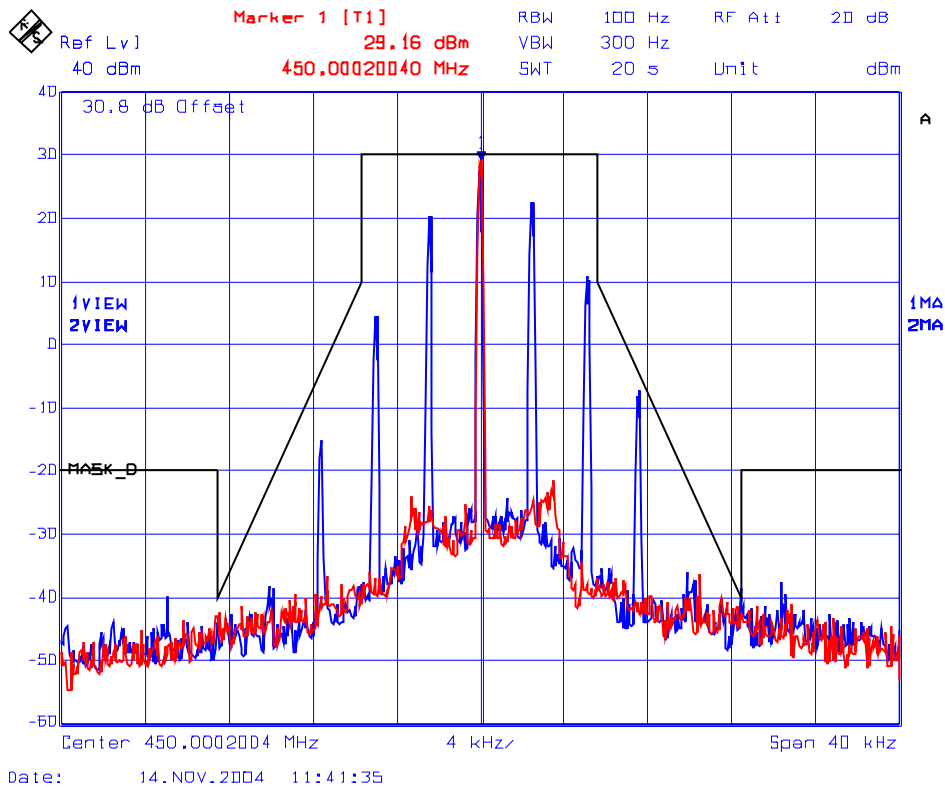

**PLOT # 35**      **Emission Mask D, *Transmitter Mode***  
**Frequency: 470 MHz, 12.5 kHz Channel Spacing, Low Power**  
**Modulation: FM modulation with 2.5 kHz sine wave signal**

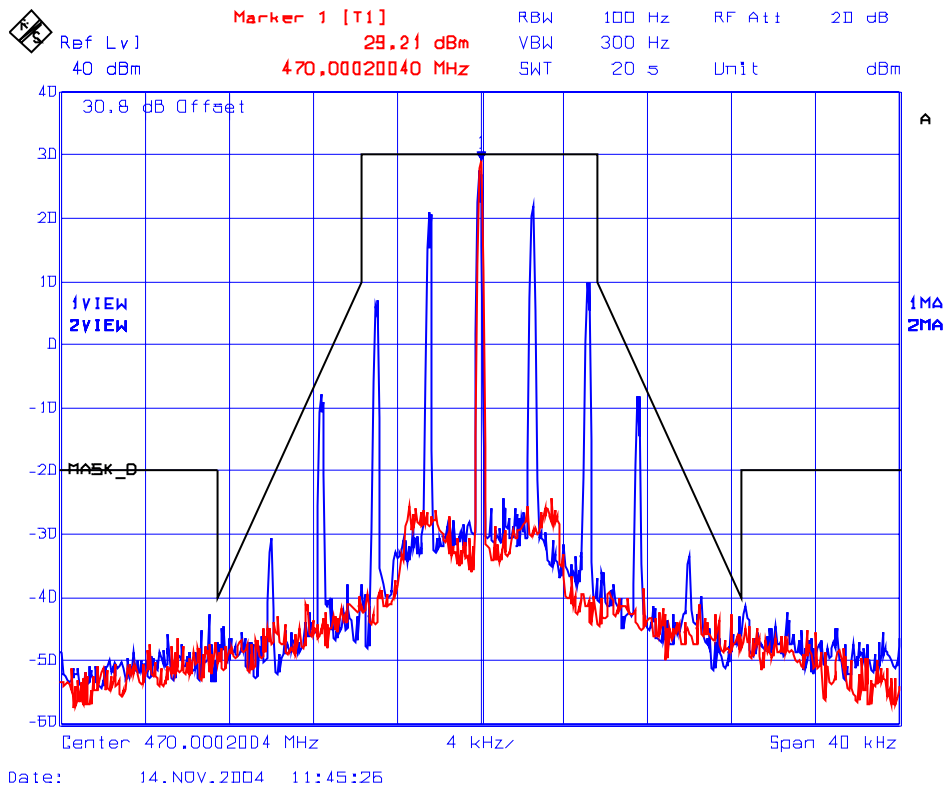



**PLOT # 36**      **Emission Mask D, *Transmitter Mode***  
**Frequency: 406.1 MHz, 12.5 kHz Channel Spacing, High Power**  
**Modulation: C4FM digital modulation**

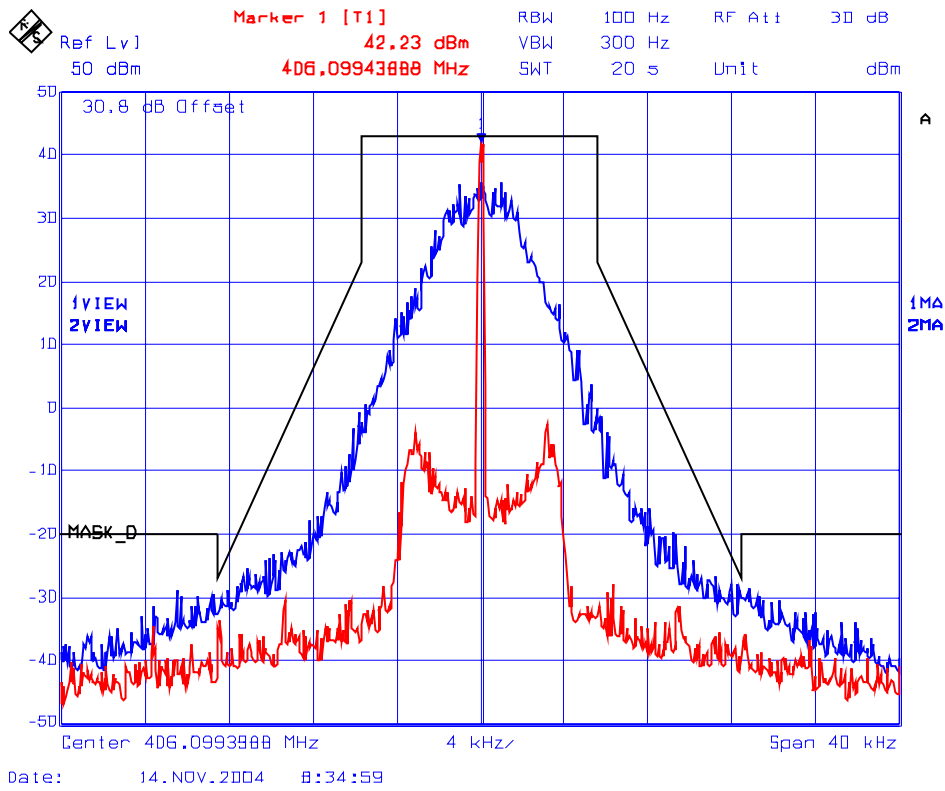

**PLOT # 37**    **Emission Mask D, *Transmitter Mode***  
**Frequency: 450 MHz, 12.5 kHz Channel Spacing, High Power**  
**Modulation: C4FM digital modulation**

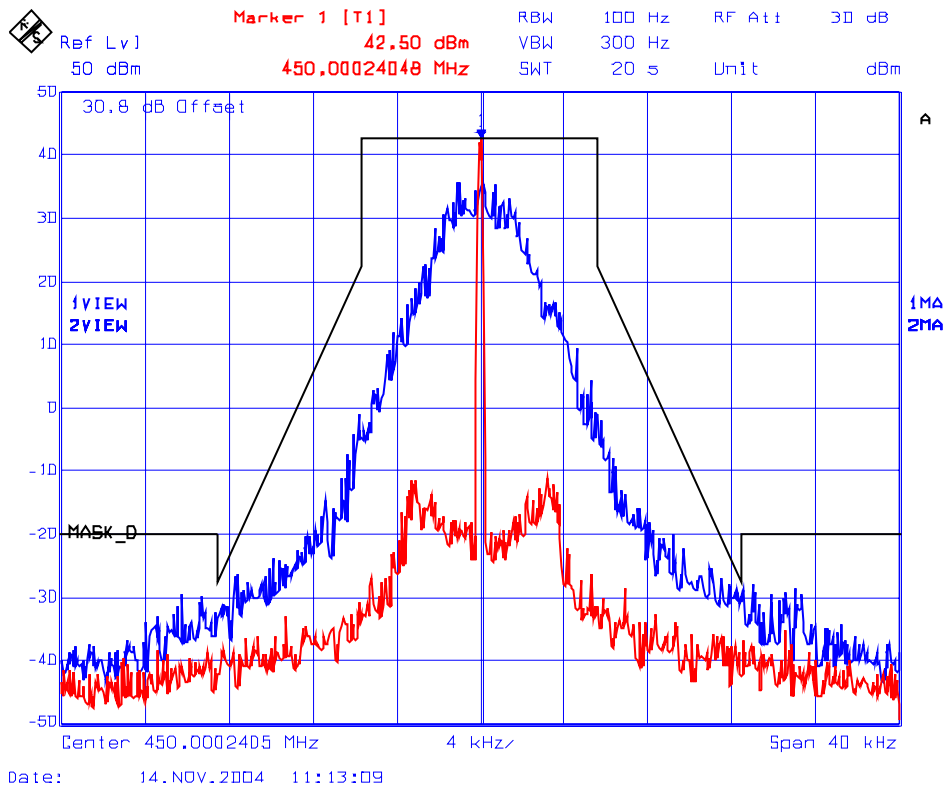

**PLOT # 38**      **Emission Mask D, *Transmitter Mode***  
**Frequency: 470 MHz, 12.5 kHz Channel Spacing, High Power**  
**Modulation: C4FM digital modulation**

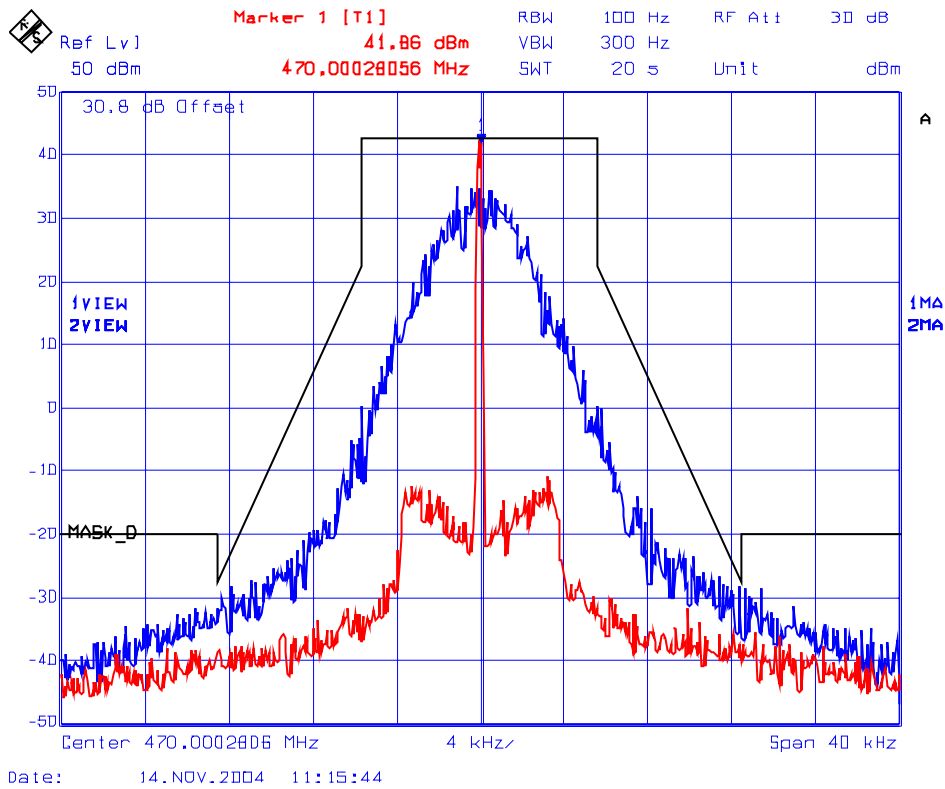

**PLOT # 39**      **Emission Mask D, *Transmitter Mode***  
**Frequency: 406.1 MHz, 12.5 kHz Channel Spacing, Low Power**  
**Modulation: C4FM digital modulation**

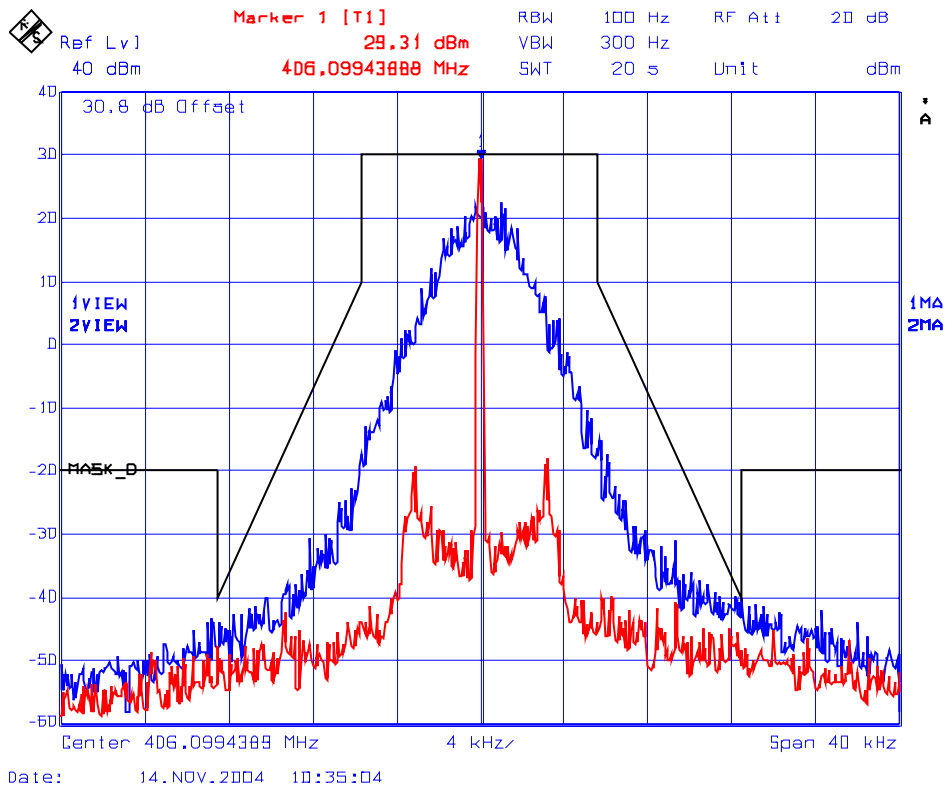

**PLOT # 40**      **Emission Mask D, *Transmitter Mode***  
**Frequency: 450 MHz, 12.5 kHz Channel Spacing, Low Power**  
**Modulation: C4FM digital modulation**

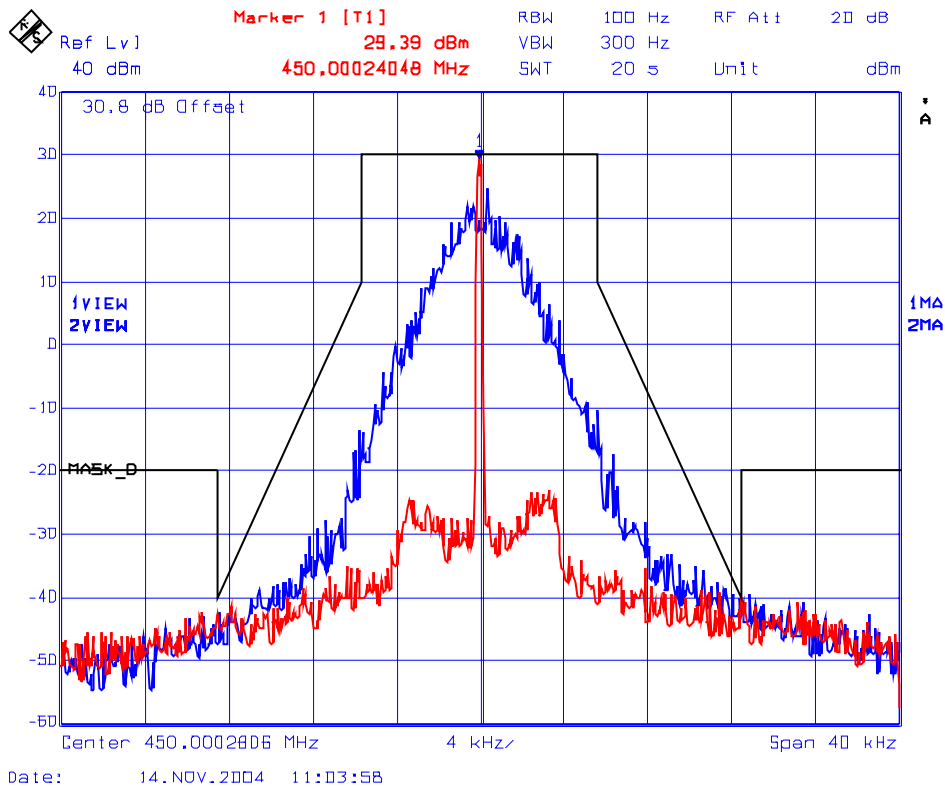

**PLOT # 41**      **Emission Mask D, *Transmitter Mode***  
**Frequency: 470 MHz, 12.5 kHz Channel Spacing, Low Power**  
**Modulation: C4FM digital modulation**

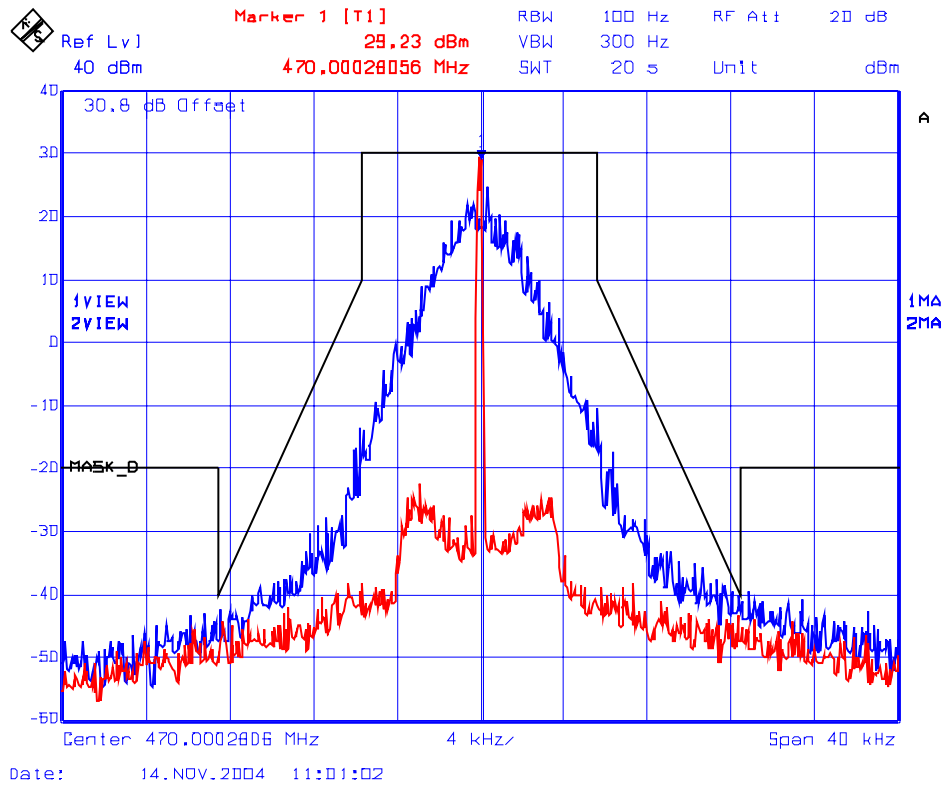

**ULTRATECH GROUP OF LABS**

3000 Bristol Circle, Oakville, Ontario, Canada L6H 6G4  
Tel. #: 905-829-1570, Fax. #: 905-829-8050, Email: [vic@ultratech-labs.com](mailto:vic@ultratech-labs.com), Website: <http://www.ultratech-labs.com>

**File #: FSG-039FCC90**

December 06, 2004

All test results contained in this engineering test report are traceable to National Institute of Standards and Technology (NIST)

## 6.11. TRANSMITTER ANTENNA POWER SPURIOUS/HARMONIC CONDUCTED EMISSIONS [§§ 2.1051, 90.209 & 90.210]

### 6.11.1. Limits

Emissions shall be attenuated below the mean output power of the transmitter as follows:

FCC Rules	Frequency Range	Attenuation Limit (dBc)
90.210(b)	10 MHz to Lowest frequency of the radio to 10 <sup>th</sup> harmonic of the highest frequency of the radio	43+10*log(P) or -13 dBm
90.210(d)	10 MHz to Lowest frequency of the radio to 10 <sup>th</sup> harmonic of the highest frequency of the radio	50+10*log(P) or -20 dBm or 70 dBc whichever is less

### 6.11.2. Method of Measurements

Refer to ULTRATECH Test Procedures, File # ULTR P001-2004 and Exhibit 8 of this report for measurement details.

### 6.11.3. Test Equipment List

Test Instruments	Manufacturer	Model No.	Serial No.	Frequency Range
Spectrum Analyzer	Rohde & Schwarz	FSEK20/B4/B21	834157/005	9 kHz – 40 GHz
Attenuator	Weinschel Corp	46-20-34	BM1347	DC - 18 GHz
High Pass Filter	Minicircuits	10425	2	2 - 18 GHz
Signal Generator	Gigatronic	6061A	5130586	10 kHz - 1050 MHz

### 6.11.4. Test Arrangement

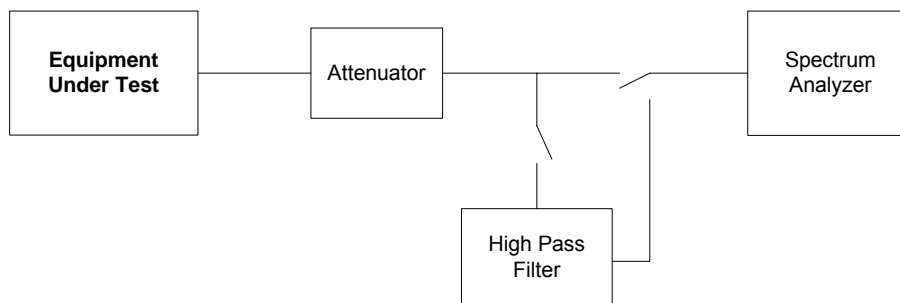

### 6.11.5. Test Data

#### Remarks:

- There was no difference in spurious/harmonic emissions on pre-scans for all different modulations and also for narrow band operation and wide band operation. Therefore, the rf spurious/harmonic emissions in this section would be performed without modulation for 12.5 kHz Channel Spacing and the more stringent limit of  $50 + 10 \cdot \log(P)$  would be applied for worst case.
- The emissions were scanned from 10 MHz to 5 GHz.

#### 6.11.5.1. Near Lowest Frequency (406.1 MHz)

Fundamental Frequency: 406.1 MHz  
RF Output Power: 20 W (conducted)  
Modulation: Unmodulated

See the following plots (42 to 43) for details:

#### PLOT # 42 Transmitter Conducted Spurious Emissions, High Power Fc: 406.1 MHz

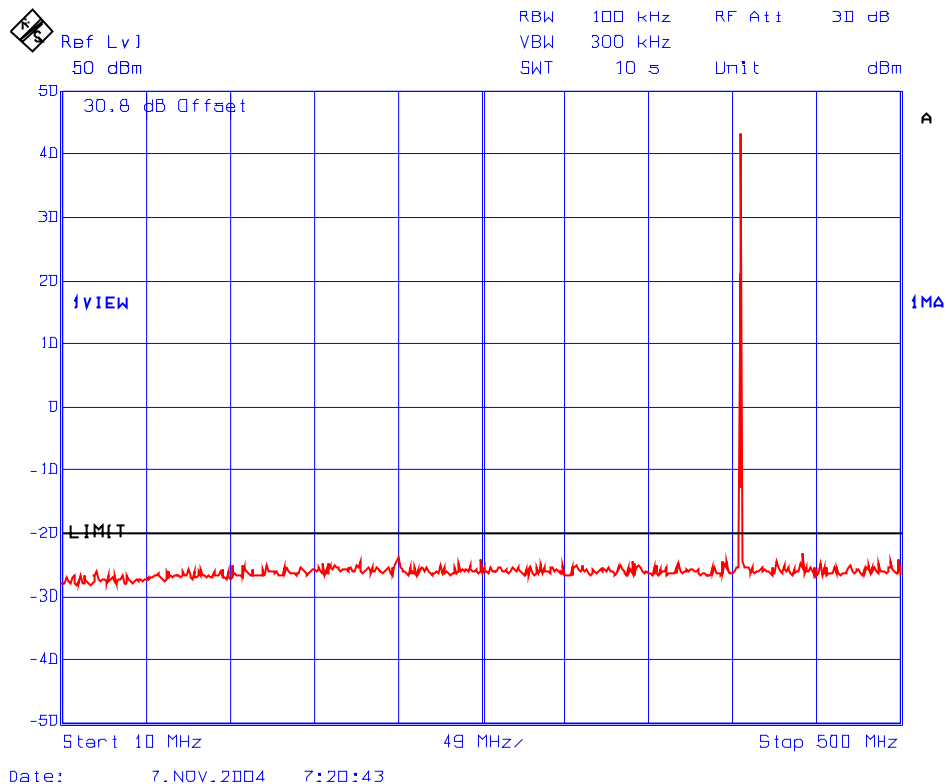

#### ULTRATECH GROUP OF LABS

3000 Bristol Circle, Oakville, Ontario, Canada L6H 6G4  
Tel. #: 905-829-1570, Fax. #: 905-829-8050, Email: [vic@ultratech-labs.com](mailto:vic@ultratech-labs.com), Website: <http://www.ultratech-labs.com>

File #: FSG-039FCC90  
December 06, 2004

All test results contained in this engineering test report are traceable to National Institute of Standards and Technology (NIST)



**PLOT # 43** Transmitter Conducted Spurious Emissions, High Power  
Fc: 406.1 MHz

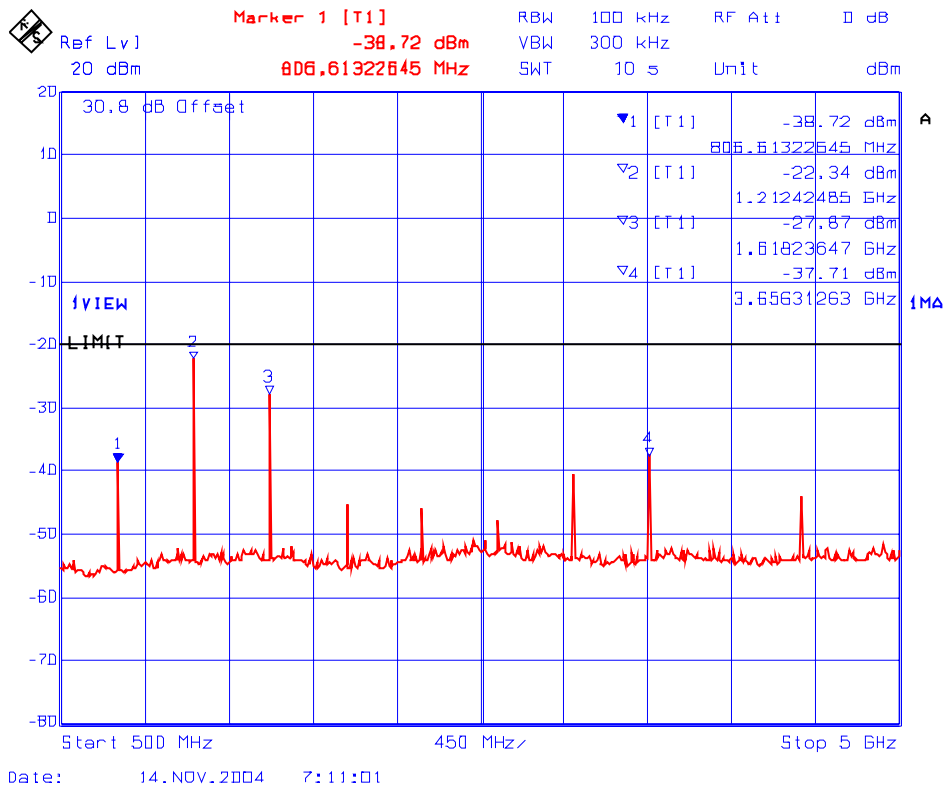

Fundamental Frequency: 406.1 MHz  
RF Output Power: 1 W (conducted)  
Modulation: Unmodulated

See the following plots (44 to 45) for details:

**PLOT # 44 Transmitter Conducted Spurious Emissions, Low Power**  
**Fc: 406.1 MHz**

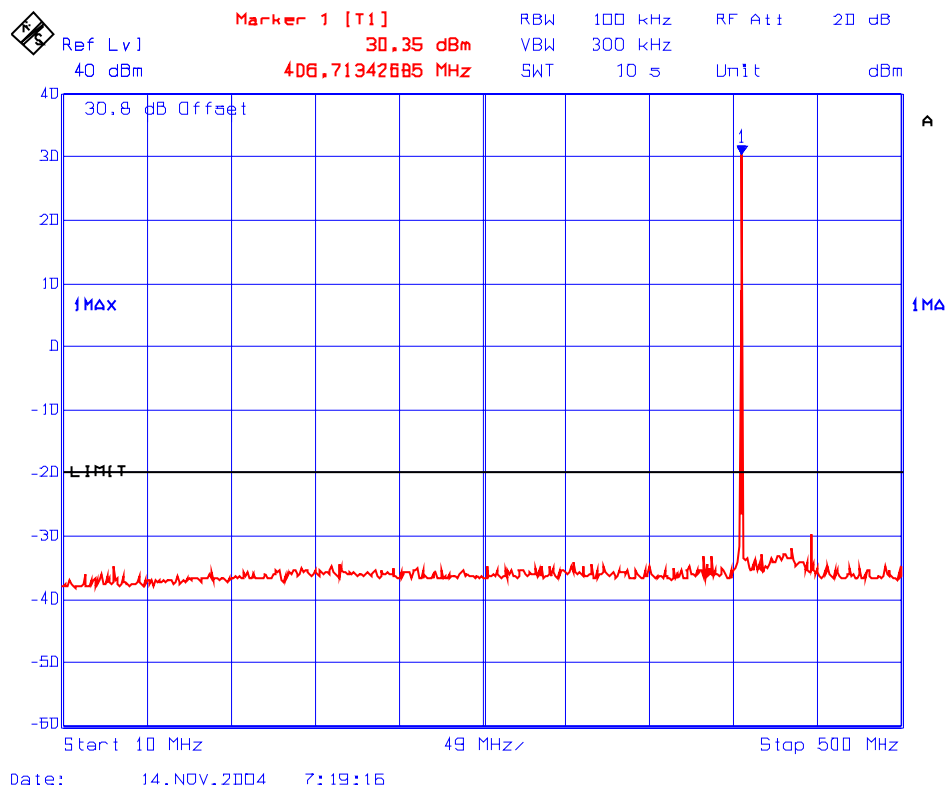

**ULTRATECH GROUP OF LABS**

3000 Bristol Circle, Oakville, Ontario, Canada L6H 6G4  
Tel. #: 905-829-1570, Fax. #: 905-829-8050, Email: [vic@ultratech-labs.com](mailto:vic@ultratech-labs.com), Website: <http://www.ultratech-labs.com>

File #: FSG-039FCC90

December 06, 2004

All test results contained in this engineering test report are traceable to National Institute of Standards and Technology (NIST)

**PLOT # 45 Transmitter Conducted Spurious Emissions, Low Power  
 Fc: 406.1 MHz**

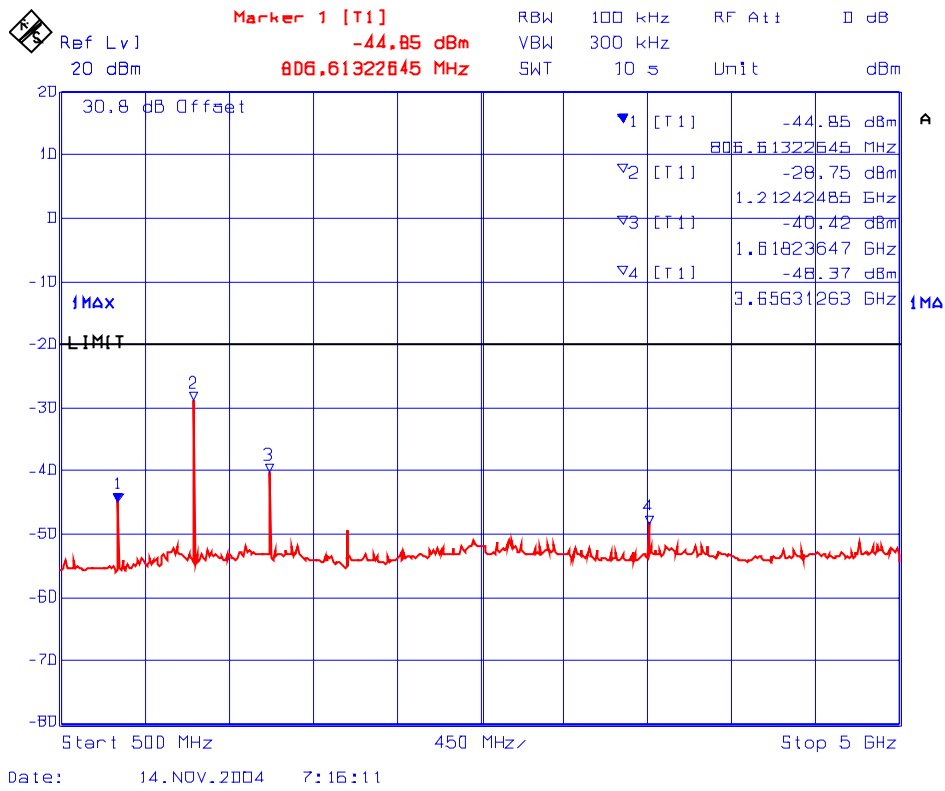

6.11.5.2. Near Middle Frequency (450 MHz)

Fundamental Frequency: 450 MHz  
RF Output Power: 20 W (conducted)  
Modulation: Unmodulated

See the following plots (46 to 47) for details:

**PLOT # 46 Transmitter Conducted Spurious Emissions, High Power**  
**Fc: 450 MHz**

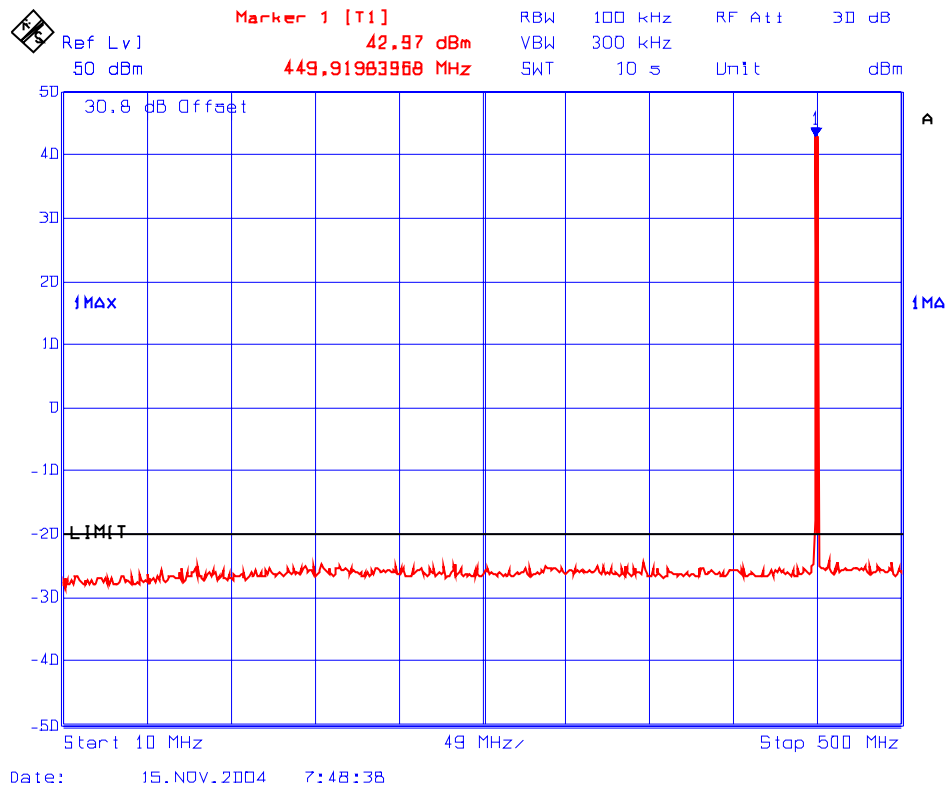

**PLOT # 47 Transmitter Conducted Spurious Emissions, High Power  
 Fc: 450 MHz**

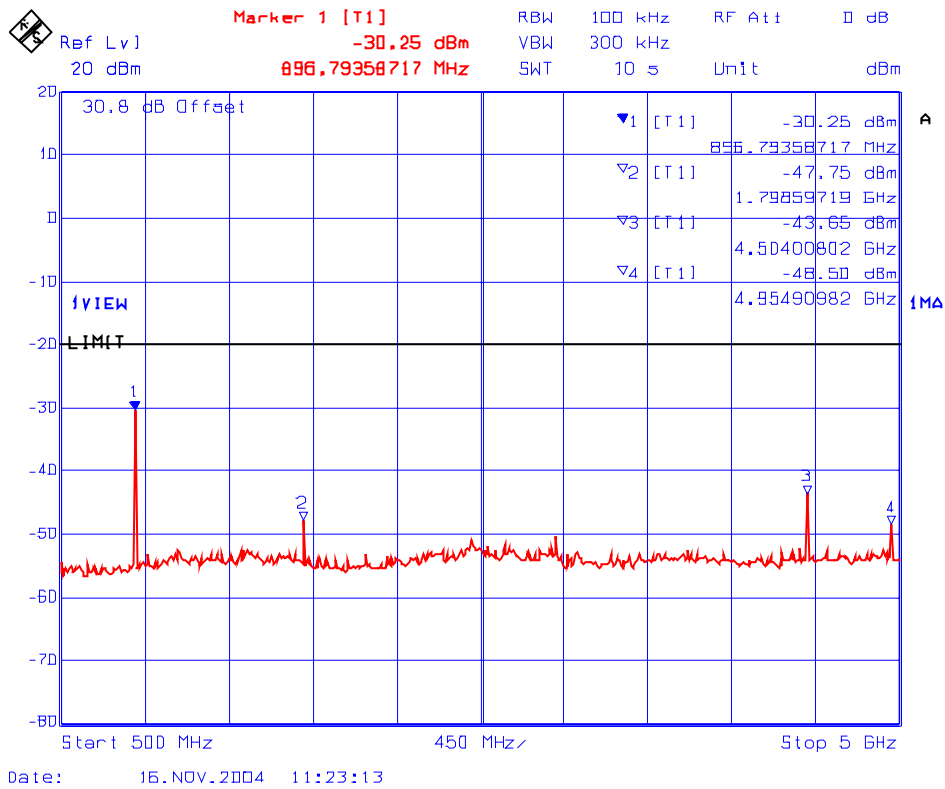

Fundamental Frequency: 450 MHz  
RF Output Power: 1 W (conducted)  
Modulation: Unmodulated

See the following plots (48 to 49) for details:

**PLOT # 48 Transmitter Conducted Spurious Emissions, Low Power  
Fc: 450 MHz**

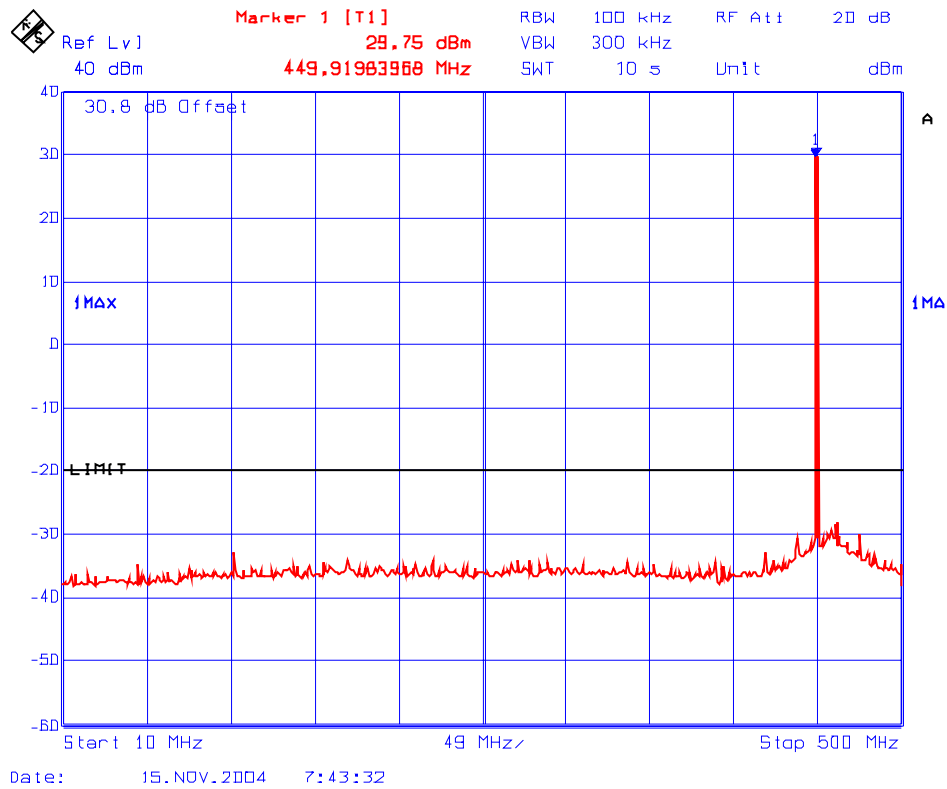

**ULTRATECH GROUP OF LABS**

3000 Bristol Circle, Oakville, Ontario, Canada L6H 6G4  
Tel. #: 905-829-1570, Fax. #: 905-829-8050, Email: [vic@ultratech-labs.com](mailto:vic@ultratech-labs.com), Website: <http://www.ultratech-labs.com>

File #: FSG-039FCC90  
December 06, 2004

All test results contained in this engineering test report are traceable to National Institute of Standards and Technology (NIST)

**PLOT # 49 Transmitter Conducted Spurious Emissions, Low Power  
 Fc: 450 MHz**

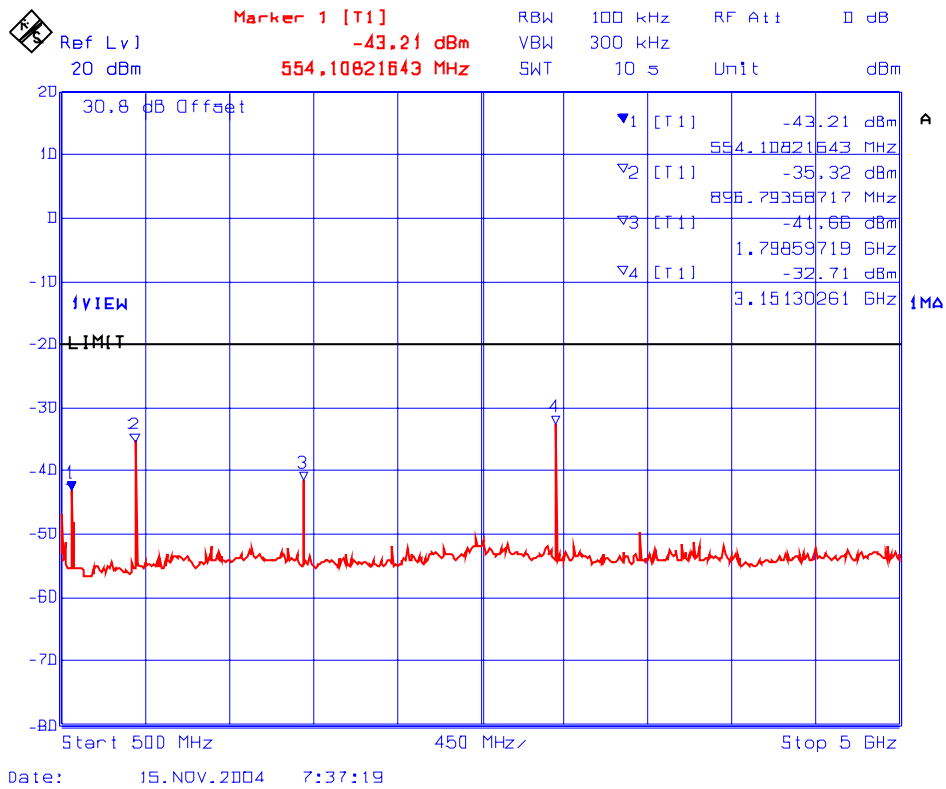

**ULTRATECH GROUP OF LABS**

3000 Bristol Circle, Oakville, Ontario, Canada L6H 6G4  
 Tel. #: 905-829-1570, Fax. #: 905-829-8050, Email: [vic@ultratech-labs.com](mailto:vic@ultratech-labs.com), Website: <http://www.ultratech-labs.com>

File #: FSG-039FCC90

December 06, 2004

All test results contained in this engineering test report are traceable to National Institute of Standards and Technology (NIST)

6.11.5.3. Near Highest Frequency (470 MHz)

Fundamental Frequency: 470 MHz  
RF Output Power: 20 W (conducted)  
Modulation: Unmodulated

See the following plots (50 to 51) for details:

**PLOT # 50** Transmitter Conducted Spurious Emissions, High Power  
Fc: 470 MHz

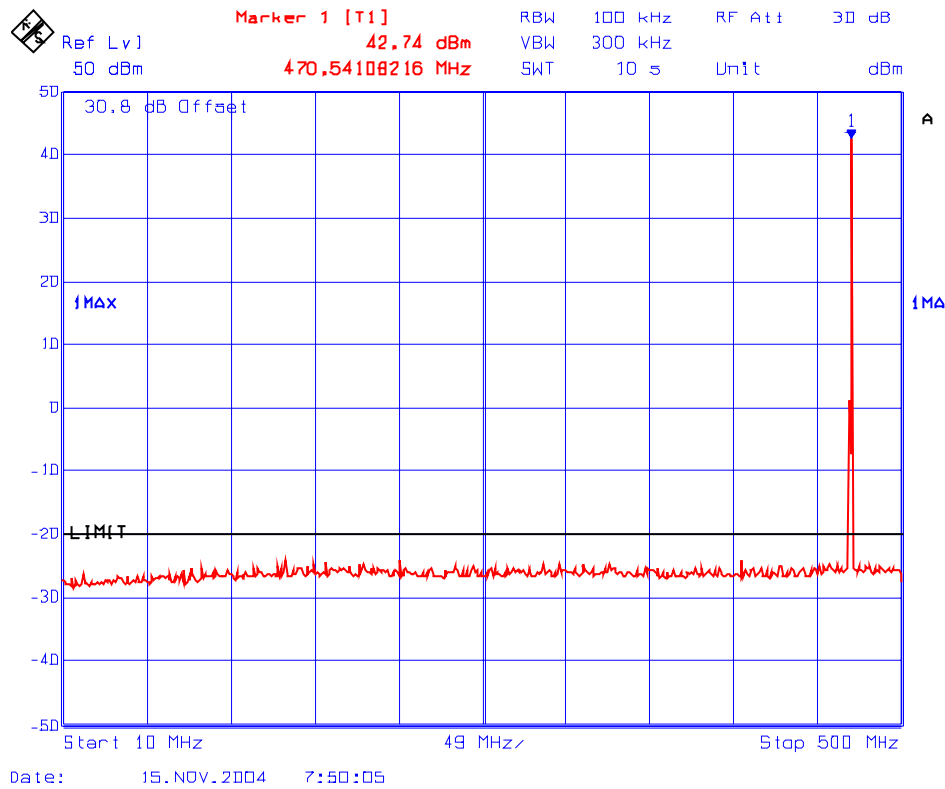



**PLOT # 51 Transmitter Spurious Emissions, High Power  
 Fc: 470 MHz**

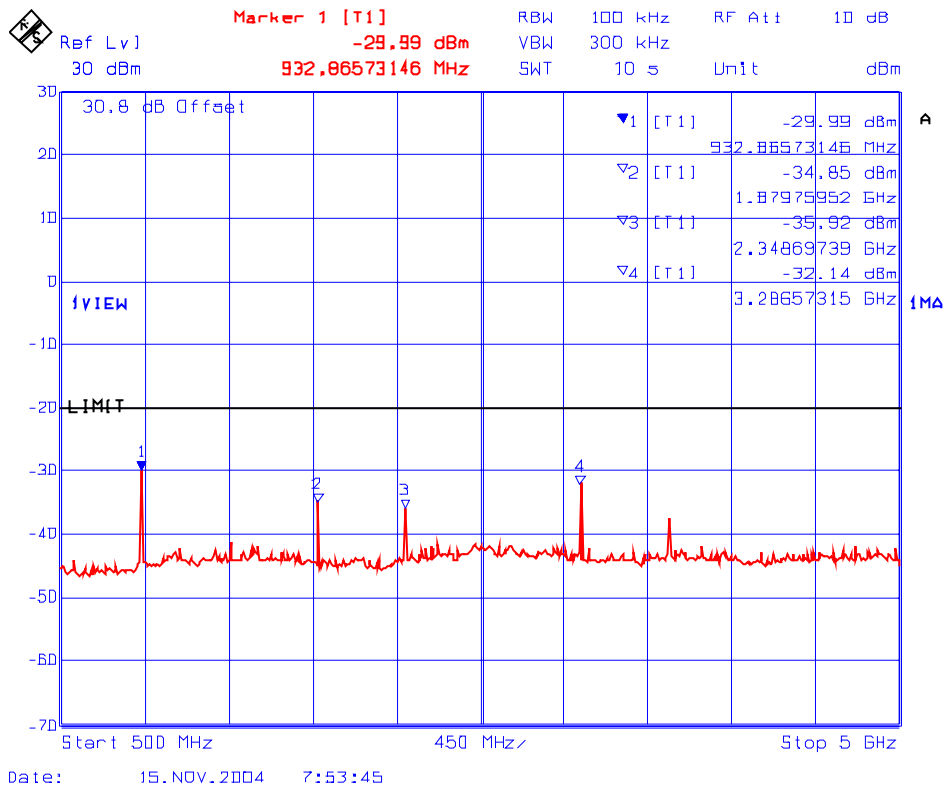

Fundamental Frequency: 470 MHz  
RF Output Power: 1 W (conducted)  
Modulation: Unmodulated

See the following plots (52 to 53) for details:

**PLOT # 52 Transmitter Conducted Spurious Emissions, Low Power  
Fc: 470 MHz**

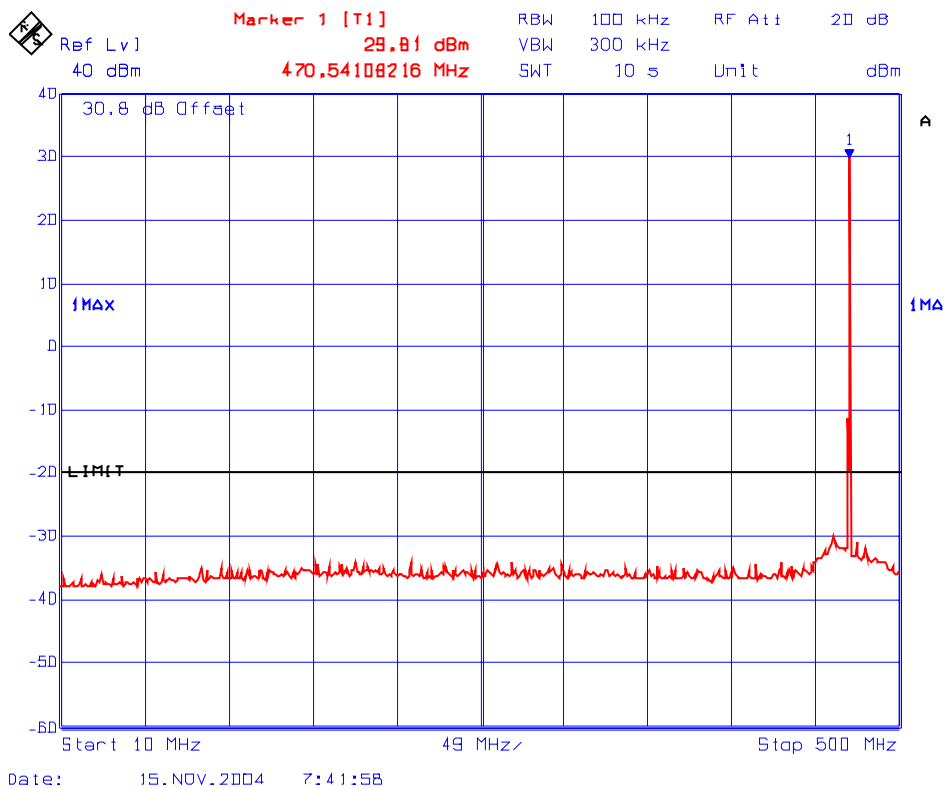

**ULTRATECH GROUP OF LABS**

3000 Bristol Circle, Oakville, Ontario, Canada L6H 6G4  
Tel. #: 905-829-1570, Fax. #: 905-829-8050, Email: [vic@ultratech-labs.com](mailto:vic@ultratech-labs.com), Website: <http://www.ultratech-labs.com>

File #: FSG-039FCC90  
December 06, 2004

All test results contained in this engineering test report are traceable to National Institute of Standards and Technology (NIST)

**PLOT # 53 Transmitter Conducted Spurious Emissions, Low Power  
 Fc: 470 MHz**

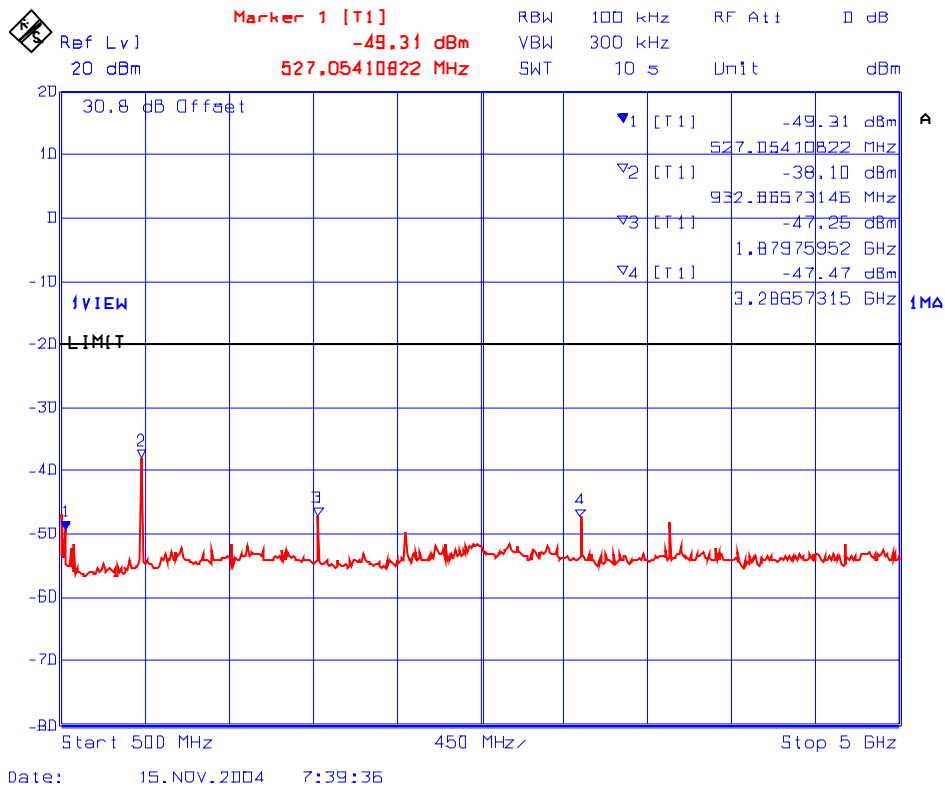

## 6.12. TRANSMITTER SPURIOUS/HARMONIC RADIATED EMISSIONS [§§ 90.208 & 90.210]

### 6.12.1. Limits

Emissions shall be attenuated below the mean output power of the transmitter as follows:

FCC Rules	Frequency Range	Attenuation Limit (dBc)
90.210(b)	10 MHz to Lowest frequency of the radio to 10 <sup>th</sup> harmonic of the highest frequency of the radio	43+10*log(P) or -13 dBm
90.210(d)	10 MHz to Lowest frequency of the radio to 10 <sup>th</sup> harmonic of the highest frequency of the radio	50+10*log(P) or -20 dBm or 70 dBc whichever is less

### 6.12.2. Method of Measurements

The spurious/harmonic ERP measurements are using substitution method specified in Exhibit 8, Section 8.2 of this report and its value in dBc is calculated as follows:

- (1) If the transmitter's antenna is an integral part of the EUT, the ERP is measured using substitution method.
- (2) If the transmitter's antenna is non-integral and diverse, the lowest ERP of the carrier with 0 dBi antenna gain is used for calculation of the spurious/harmonic emissions in dBc:  
 Lowest ERP of the carrier = EIRP – 2.15 dB = Pc + G - 2.15 dB = Pc dBm (conducted) + 0 dBi – 2.15 dB
- (3) Spurious /harmonic emissions levels expressed in dBc (dB below carrier) are as follows:

$$\text{ERP of spurious/harmonic (dBc)} = \text{ERP of carrier (dBm)} - \text{ERP of spurious/harmonic emission (dBm)}$$

### 6.12.3. Test Equipment List

Test Instruments	Manufacturer	Model No.	Serial No.	Frequency Range
Spectrum Analyzer	Rohde & Schwarz	FSEK20/B4/B21	834157/005	9 kHz – 40 GHz
RF Amplifier	Com-Power	PA-102		1 MHz to 1 GHz, 30 dB gain nominal
Microwave Amplifier	Hewlett Packard	HP 83017A		1 GHz to 26.5 GHz, 30 dB nominal
Biconilog Antenna	EMCO	3142	10005	30 MHz to 2 GHz
Dipole Antenna	EMCO	3121C	8907-434	30 GHz – 1 GHz
Dipole Antenna	EMCO	3121C	8907-440	30 GHz – 1 GHz
Horn Antenna	EMCO	3155	9701-5061	1 GHz – 18 GHz
Horn Antenna	EMCO	3155	9911-5955	1 GHz – 18 GHz
RF Signal Generator	Hewlett Packard	HP 83752B	3610A00457	0.01 – 20 GHz

**6.12.4. Test Data**

**Remarks:**

- There was no difference in spurious/harmonic emissions on pre-scans for all different modulations. Therefore, the rf spurious/harmonic emissions in this section would be performed without modulation and it shall represent for all different modulations required.
- The RF spurious/harmonic emission characteristics for narrow band and wide band operation are indistinguishable. Therefore, the following radiated emissions were performed at 12.5 kHz channel spacing (narrow band) operation, and the results were compared with the more stringent limit of  $50+10*\log(P \text{ in Watts})$  for the worst-case.
- The radiated emissions were performed with high power setting at 3 meters distance to represents the worst-case test configuration.
- The emissions were scanned from 30 MHz to 5 GHz.

**6.12.4.1. Lowest Frequency (406.1 MHz)**

Fundamental Frequency: 406.1 MHz  
 RF Output Power: 43.05 dBm  
 Limit:  $-(50+10*\log(20)) = -63.05 \text{ dBc}$   
 Frequency Test Range: 30 MHz – 5 GHz

Frequency (MHz)	E-Field @3m (dBμV/m)	ERP measured by Substitution Method		EMI Detector (Peak/QP)	Antenna Polarization (H/V)	Limit (dBc)	Margin (dB)	Pass/Fail
		(dBm)	(dBc)					
1218.3	64.35	-38.78	-81.8	Peak	V	-63.05	-18.8	Pass

The emissions were scanned from 30 MHz to 5 GHz at 3 meters distance and all emissions within 20 dB below the limits were recorded.

**6.12.4.2. Middle Frequency (450 MHz)**

Fundamental Frequency: 450 MHz  
 RF Output Power: 43.05 dBm  
 Limit:  $-(50+10*\log(20)) = -63.05 \text{ dBc}$   
 Frequency Test Range: 30 MHz – 5 GHz

Frequency (MHz)	E-Field @3m (dBμV/m)	ERP measured by Substitution Method		EMI Detector (Peak/QP)	Antenna Polarization (H/V)	Limit (dBc)	Margin (dB)	Pass/Fail
		(dBm)	(dBc)					
900	61.50	-33.49	-76.5	Peak	V	-63.05	-13.5	Pass
900	62.56	-31.33	-74.4	Peak	H	-63.05	-11.3	Pass
1800	66.64	-35.20	-78.3	Peak	V	-63.05	-15.2	Pass
1800	63.96	-39.30	-82.4	Peak	H	-63.05	-19.3	Pass

The emissions were scanned from 30 MHz to 5 GHz at 3 meters distance and all emissions within 20 dB below the limits were recorded.

**6.12.4.3. Highest Frequency (470 MHz)**

Fundamental Frequency: 470 MHz  
 RF Output Power: 43.05 dBm  
 Limit:  $-(50+10*\log(20)) = - 63.05$  dBc  
 Frequency Test Range: 30 MHz – 5 GHz

Frequency (MHz)	E-Field @3m (dBμV/m)	ERP measured by Substitution Method		EMI Detector (Peak/QP)	Antenna Polarization (H/V)	Limit (dBc)	Margin (dB)	Pass/Fail
		(dBm)	(dBc)					
940	59.29	-35.70	- 78.8	Peak	V	- 63.05	- 15.7	Pass
940	61.03	-32.86	- 75.9	Peak	H	- 63.05	- 12.9	Pass
1410	64.45	-39.69	-82.7	Peak	V	- 63.05	- 19.7	Pass

The emissions were scanned from 30 MHz to 5 GHz at 3 meters distance and all emissions within 20 dB below the limits were recorded.

### 6.13. TRANSIENT FREQUENCY BEHAVIOR [§ 90.214]

#### 6.13.1. Limits

Transient frequencies must be within the maximum frequency difference limits during the time intervals indicated:

Time intervals <sup>1, 2</sup>	Maximum frequency difference <sup>3</sup>	All equipment	
		150 to 174 MHz	421 to 512MHz
Transient Frequency Behavior for Equipment Designed to Operate on 25 kHz Channels			
t <sub>1</sub> <sup>4</sup> .....	± 25.0 kHz	5.0 ms	10.0 ms
t <sub>2</sub> .....	± 12.5 kHz	20.0 ms	25.0 ms
t <sub>3</sub> <sup>4</sup> .....	± 25.0 kHz	5.0 ms	10.0 ms
Transient Frequency Behavior for Equipment Designed to Operate on 12.5 kHz Channels			
t <sub>1</sub> <sup>4</sup> .....	± 12.5 kHz	5.0 ms	10.0 ms
t <sub>2</sub> .....	± 6.25 kHz	20.0 ms	25.0 ms
t <sub>3</sub> <sup>4</sup> .....	± 12.5 kHz	5.0 ms	10.0 ms

- t<sub>on</sub> is the instant when a 1 kHz test signal is completely suppressed, including any capture time due to phasing.  
 t<sub>1</sub> is the time period immediately following t<sub>on</sub>.  
 t<sub>2</sub> is the time period immediately following t<sub>1</sub>.  
 t<sub>3</sub> is the time period from the instant when the transmitter is turned off until t<sub>off</sub>.  
 t<sub>off</sub> is the instant when the 1 kHz test signal starts to rise.
- During the time from the end of t<sub>2</sub> to the beginning of t<sub>3</sub>, the frequency difference must not exceed the limits specified in § 90.213.
- Difference between the actual transmitter frequency and the assigned transmitter frequency.
- If the transmitter carrier output power rating is 6 watts or less, the frequency difference during this time period may exceed the maximum frequency difference for this time period.

#### 6.13.2. Method of Measurements

Refer to ULTRATECH Test Procedures, File # ULTR P001-2004, Exhibit 8 of this test report and ANSI/TIA/EIA-603-B-2002, Section 2.2.19.

**6.13.3. Test Equipment List**

Test Instruments	Manufacturer	Model No.	Serial No.	Frequency Range
Radio Communication	Marconi	2955	132037/226	20Hz – 20kHz
RF Synthesized Signal Generator	Gigatronic	6061A	5130408	10kHz – 1050 MHz
Network Combiner	Mini-Circuit	15542	--	DC - 32 GHz
Infinium Digitizing Oscilloscope	Hewlett Packard	54810A	US38380192	DC - 500 MHz, 1 Gsa/s
RF Detector	Amphenol	UG-1094/U1050	--	--
Attenuator	Weinschel Corp	23-20-34	BH7876	DC - 18GHz
Modulation Analyzer	Hewlett Packard	8901B	3226A04606	150 kHz – 1300 MHz
Digital Multimeter	Rohde & Schwartz	UDS5	872984/067	DC-100kHz

**6.13.4. Test Arrangement**

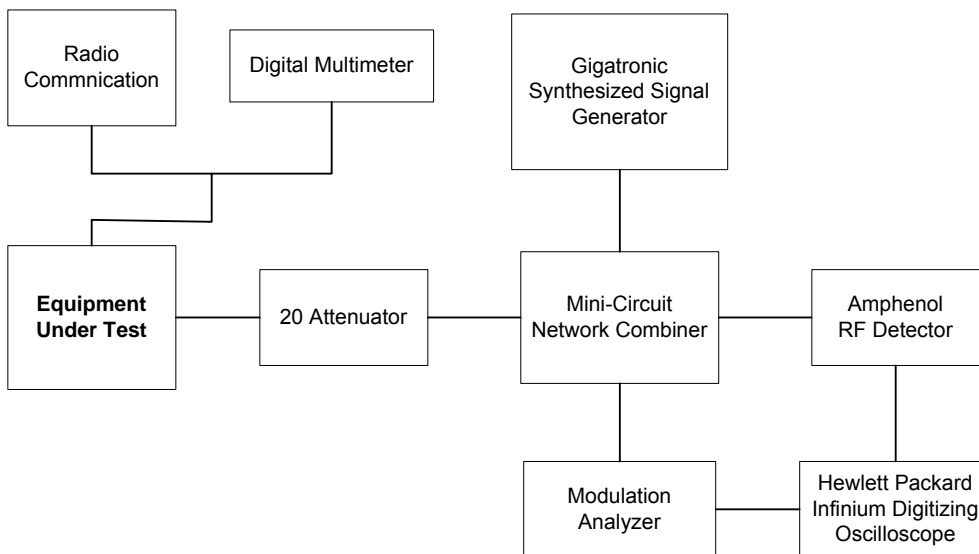



### 6.13.5. Test Data

#### 6.13.5.1. 12.5 Channel Spacing Operation

Plot # 54:

Transient Frequency Behavior

Carrier Frequency: 406.1 MHz

Channel Spacing: 12.5 kHz

Power: 20 W

Modulation: Unmodulated

Description: Switch on condition  $t_{on}$ ,  $t_1$ , and  $t_2$

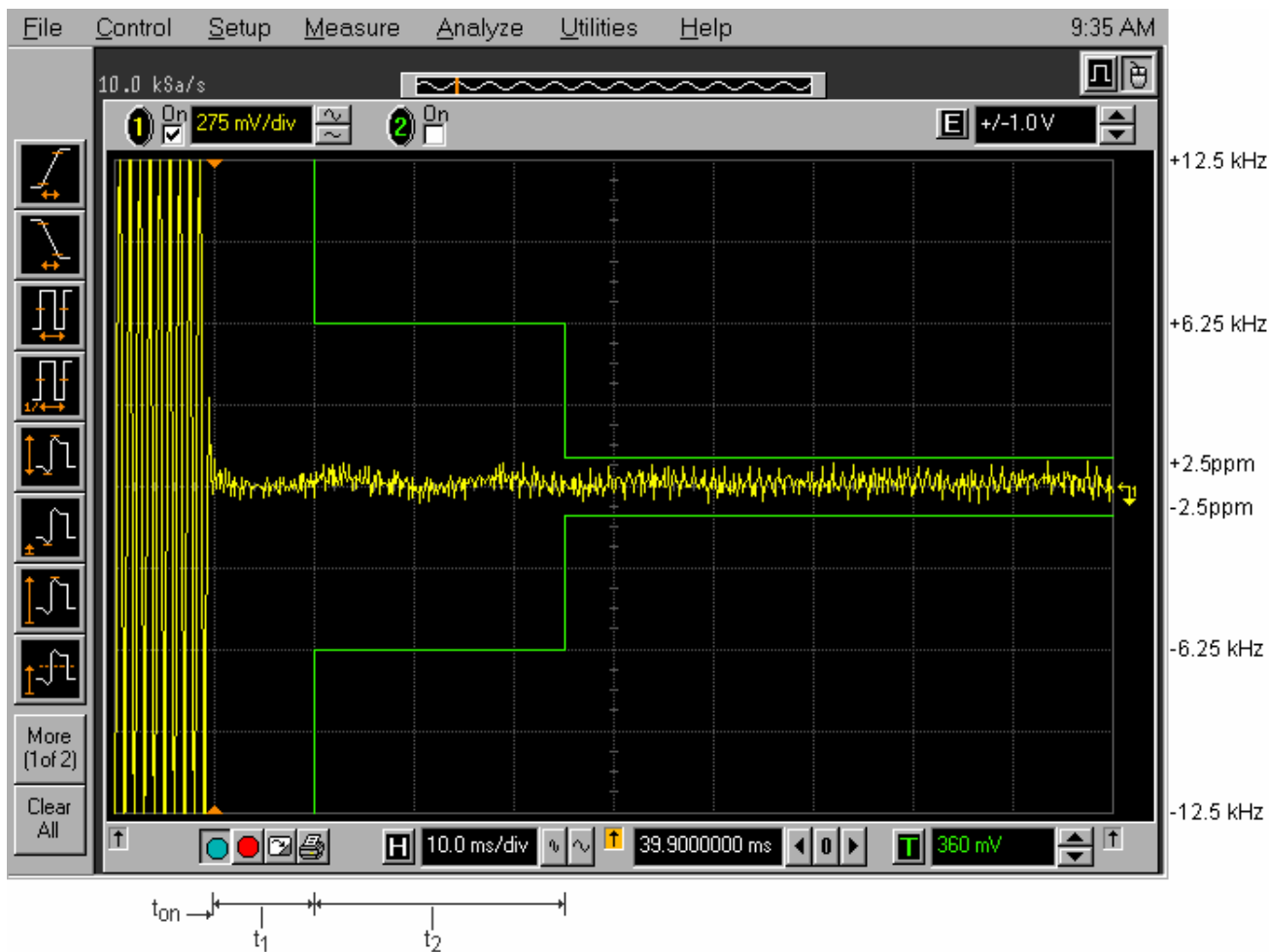

Plot # 55:  
Transient Frequency Behavior  
Carrier Frequency: 406.1 MHz  
Channel Spacing: 12.5 kHz  
Power: 20 W  
Modulation: Unmodulated  
Description: Switch off condition  $t_3$ ,  $t_{off}$

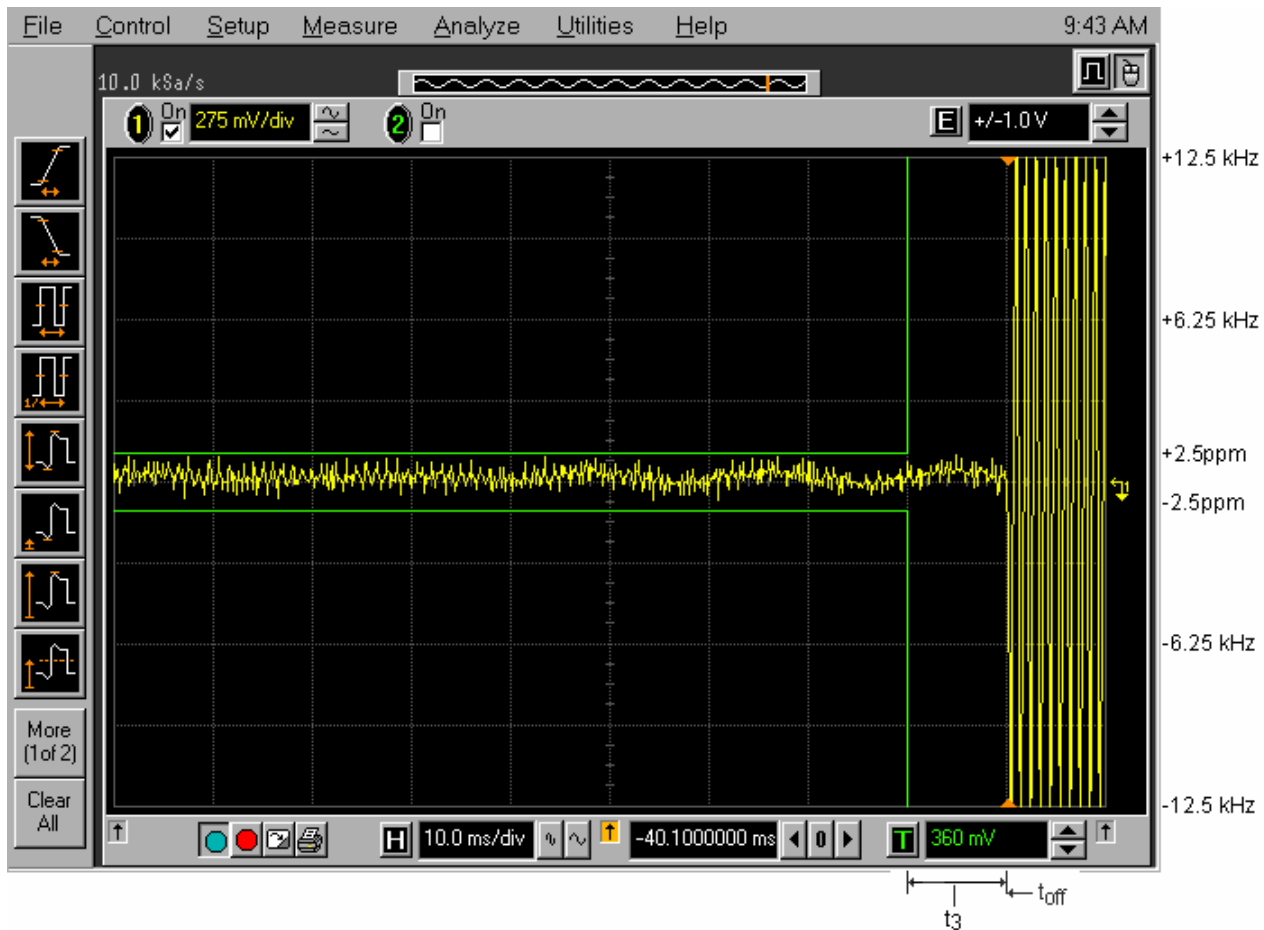

### 6.13.5.2. 25 Channel Spacing Operation

Plot # 56:

Transient Frequency Behavior

Carrier Frequency: 406.1 MHz

Channel Spacing: 25 kHz

Power: 20 W

Modulation: Unmodulated

Description: Switch on condition  $t_{on}$ ,  $t_1$ , and  $t_2$



Plot # 57:  
Transient Frequency Behavior  
Carrier Frequency: 406.1 MHz  
Channel Spacing: 25 kHz  
Power: 20 W  
Modulation: Unmodulated  
Description: Switch off condition  $t_3$ ,  $t_{off}$

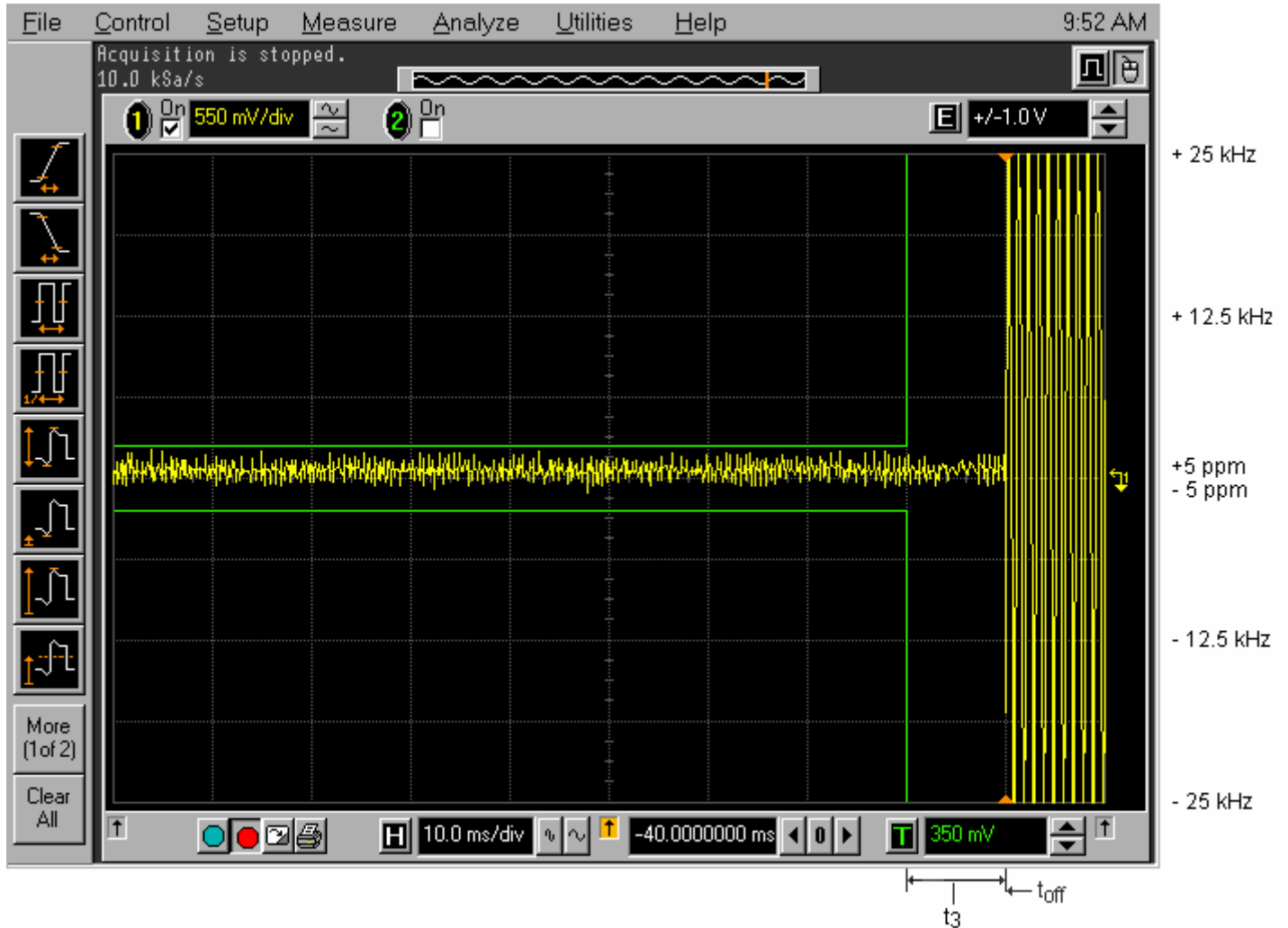

**ULTRATECH GROUP OF LABS**

3000 Bristol Circle, Oakville, Ontario, Canada L6H 6G4  
Tel. #: 905-829-1570, Fax. #: 905-829-8050, Email: [vic@ultratech-labs.com](mailto:vic@ultratech-labs.com), Website: <http://www.ultratech-labs.com>

File #: FSG-039FCC90  
December 06, 2004

All test results contained in this engineering test report are traceable to National Institute of Standards and Technology (NIST)

## EXHIBIT 7. MEASUREMENT UNCERTAINTY

The measurement uncertainties stated were calculated in accordance with the requirements of NIST Technical Note 1297 and NIS 81 (1994)

### 7.1. RADIATED EMISSION MEASUREMENT UNCERTAINTY

CONTRIBUTION (Radiated Emissions)	PROBABILITY DISTRIBUTION	UNCERTAINTY (+ dB)	
		3 m	10 m
Antenna Factor Calibration	Normal (k=2)	$\pm 1.0$	$\pm 1.0$
Cable Loss Calibration	Normal (k=2)	$\pm 0.3$	$\pm 0.5$
EMI Receiver specification	Rectangular	$\pm 1.5$	$\pm 1.5$
Antenna Directivit	Rectangular	+0.5	+0.5
Antenna factor variation with height	Rectangular	$\pm 2.0$	$\pm 0.5$
Antenna phase center variation	Rectangular	0.0	$\pm 0.2$
Antenna factor frequency interpolation	Rectangular	$\pm 0.25$	$\pm 0.25$
Measurement distance variation	Rectangular	$\pm 0.6$	$\pm 0.4$
Site imperfections	Rectangular	$\pm 2.0$	$\pm 2.0$
Mismatch: Receiver VRC $\Gamma_1 = 0.2$ Antenna VRC $\Gamma_R = 0.67(Bi) 0.3 (Lp)$ Uncertainty limits $20\text{Log}(1 \pm \Gamma_1 \Gamma_R)$	U-Shaped	+1.1 -1.25	$\pm 0.5$
System repeatability	Std. Deviation	$\pm 0.5$	$\pm 0.5$
Repeatability of EUT		-	-
Combined standard uncertainty	Normal	+2.19 / -2.21	+1.74 / -1.72
Expanded uncertainty U	Normal (k=2)	+4.38 / -4.42	+3.48 / -3.44

Calculation for maximum uncertainty when 3m biconical antenna including a factor of k = 2 is used:

$$U = 2u_c(y) = 2x(+2.19) = +4.38 \text{ dB} \quad \text{And} \quad U = 2u_c(y) = 2x(-2.21) = -4.42 \text{ dB}$$

## EXHIBIT 8. MEASUREMENT METHODS

### 8.1. CONDUCTED POWER MEASUREMENTS

- The following shall be applied to the combination(s) of the radio device and its intended antenna(e).
- If the RF level is user adjustable, all measurements shall be made with the highest power level available to the user for that combination.
- The following method of measurement shall apply to both conducted and radiated measurements.
- The radiated measurements are performed at the Ultratech Calibrated Open Field Test Site.
- The measurement shall be performed using normal operation of the equipment with modulation.

Test procedure shall be as follows:

**Step 1:** Duty Cycle measurements if the transmitter's transmission is transient

- Using a EMI Receiver with the frequency span set to 0 Hz and the sweep time set at a suitable value to capture the envelope peaks and the duty cycle of the transmitter output signal;
- The duty cycle of the transmitter,  $x = T_x \text{ on} / (T_x \text{ on} + T_x \text{ off})$  with  $0 < x < 1$ , is measure and recorded in the test report. For the purpose of testing, the equipment shall be operated with a duty cycle that is equal or more than 0.1.

**Step 2:** Calculation of Average EIRP. See Figure 1

- The average output power of the transmitter shall be determined using a wideband, calibrated RF average power meter with the power sensor with an integration period that exceeds the repetition period of the transmitter by a factor 5 or more. The observed value shall be recorded as "A" (in dBm);
- The e.i.r.p. shall be calculated from the above measured power output "A", the observed duty cycle x, and the applicable antenna assembly gain "G" in dBi, according to the formula:

$$\text{EIRP} = \text{A} + \text{G} + 10\log(1/x)$$

{ X = 1 for continuous transmission =>  $10\log(1/x) = 0 \text{ dB}$  }

**Figure 1.**

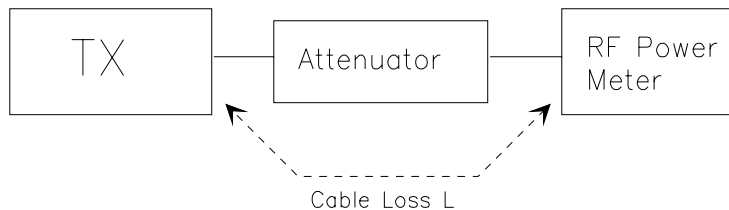

## 8.2. RADIATED POWER MEASUREMENTS (ERP & EIRP) USING SUBSTITUTION METHOD

### 8.2.1. Maximizing RF Emission Level (E-Field)

- (a) The measurements was performed with full rf output power and modulation.
- (b) Test was performed at listed 3m open area test site (listed with FCC, IC, ITI, NVLAP, ACA & VCCI).
- (c) The transmitter under test was placed at the specified height on a non-conducting turntable (80 cm height)
- (d) The BICONILOG antenna (20 MHz to 1 GHz) or HORN antenna (1 GHz to 18 GHz) was used for measuring.
- (e) Load an appropriate correction factors file in EMI Receiver for correcting the field strength reading level

Total Correction Factor recorded in the EMI Receiver = Cable Loss + Antenna Factor  
E (dBuV/m) = Reading (dBuV) + Total Correction Factor (dB/m)

- (f) Set the EMI Receiver and #2 as follows:

Center Frequency: test frequency  
Resolution BW: 100 kHz  
Video BW: same  
Detector Mode: positive  
Average: off  
Span: 3 x the signal bandwidth

- (g) The test antenna was lowered or raised from 1 to 4 meters until the maximum signal level was detected.
- (h) The transmitter was rotated through 360° about a vertical axis until a higher maximum signal was received.
- (i) The test antenna was lowered or raised again from 1 to 4 meters until a maximum was obtained. This level was recorded.
- (j) The recorded reading was corrected to the true field strength level by adding the antenna factor, cable loss and subtracting the pre-amplifier gain.
- (k) The above steps were repeated with both transmitters' antenna and test receiving antenna placed in vertical and horizontal polarization. Both readings with the antennas placed in vertical and horizontal polarization shall be recorded.
- (l) Repeat for all different test signal frequencies

### 8.2.2. Measuring the EIRP of Spurious/Harmonic Emissions using Substitution Method

(a) Set the EMI Receiver (for measuring E-Field) and Receiver #2 (for measuring EIRP) as follows:

Center Frequency: equal to the signal source  
Resolution BW: 10 kHz  
Video BW: same  
Detector Mode: positive  
Average: off  
Span: 3 x the signal bandwidth

(b) Load an appropriate correction factors file in EMI Receiver for correcting the field strength reading level

Total Correction Factor recorded in the EMI Receiver = Cable Loss + Antenna Factor  
 $E \text{ (dBuV/m)} = \text{Reading (dBuV)} + \text{Total Correction Factor (dB/m)}$

(c) Select the frequency and E-field levels obtained in the Section 8.2.1 for ERP/EIRP measurements.

(d) Substitute the EUT by a signal generator and one of the following transmitting antenna (substitution antenna):

- ◆ DIPOLE antenna for frequency from 30-1000 MHz or
- ◆ HORN antenna for frequency above 1 GHz }

(e) Mount the transmitting antenna at 1.5 meter high from the ground plane.

(f) Use one of the following antenna as a receiving antenna:

- ◆ DIPOLE antenna for frequency from 30-1000 MHz or
- ◆ HORN antenna for frequency above 1 GHz }

(g) If the DIPOLE antenna is used, tune it's elements to the frequency as specified in the calibration manual.

(h) Adjust both transmitting and receiving antenna in a VERTICAL polarization.

(i) Tune the EMI Receivers to the test frequency.

(j) Lower or raise the test antenna from 1 to 4 meters until the maximum signal level was detected.

(k) The transmitter was rotated through 360° about a vertical axis until a higher maximum signal was received.

(l) Lower or raise the test antenna from 1 to 4 meters until the maximum signal level was detected.

(m) Adjust input signal to the substitution antenna until an equal or a known related level to that detected from the transmitter was obtained in the test receiver.

(n) Record the power level read from the Average Power Meter and calculate the ERP/EIRP as follows:

$$P = P1 - L1 = (P2 + L2) - L1 = P3 + A + L2 - L1$$

$$EIRP = P + G1 = P3 + L2 - L1 + A + G1$$

$$ERP = EIRP - 2.15 \text{ dB}$$

$$\text{Total Correction factor in EMI Receiver \# 2} = L2 - L1 + G1$$

Where: P: Actual RF Power fed into the substitution antenna port after corrected.

P1: Power output from the signal generator

P2: Power measured at attenuator A input

P3: Power reading on the Average Power Meter

EIRP: EIRP after correction

ERP: ERP after correction

(o) Adjust both transmitting and receiving antenna in a HORIZONTAL polarization, then repeat step (k) to (o)

(p) Repeat step (d) to (o) for different test frequency

(q) Repeat steps (c) to (j) with the substitution antenna oriented in horizontal polarization.

(r) Actual gain of the EUT's antenna is the difference of the measured EIRP and measured RF power at the RF port. Correct the antenna gain if necessary.



Figure 2

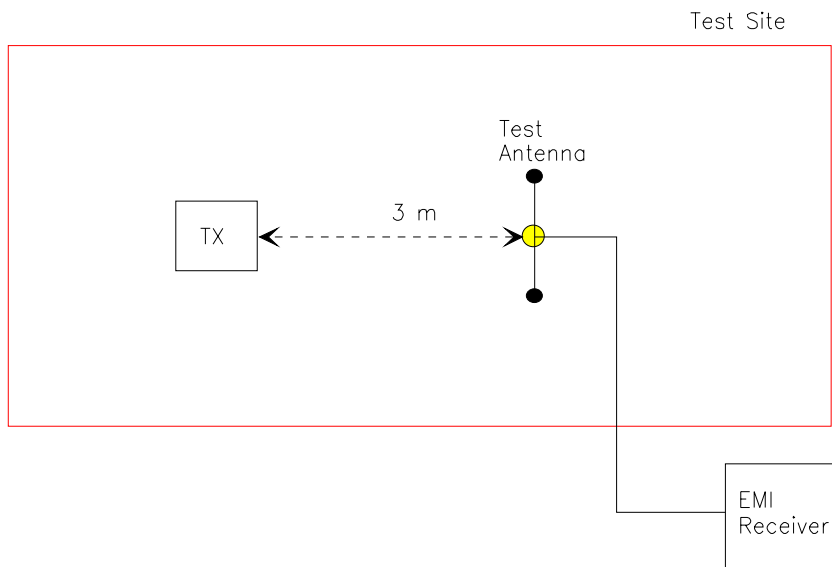
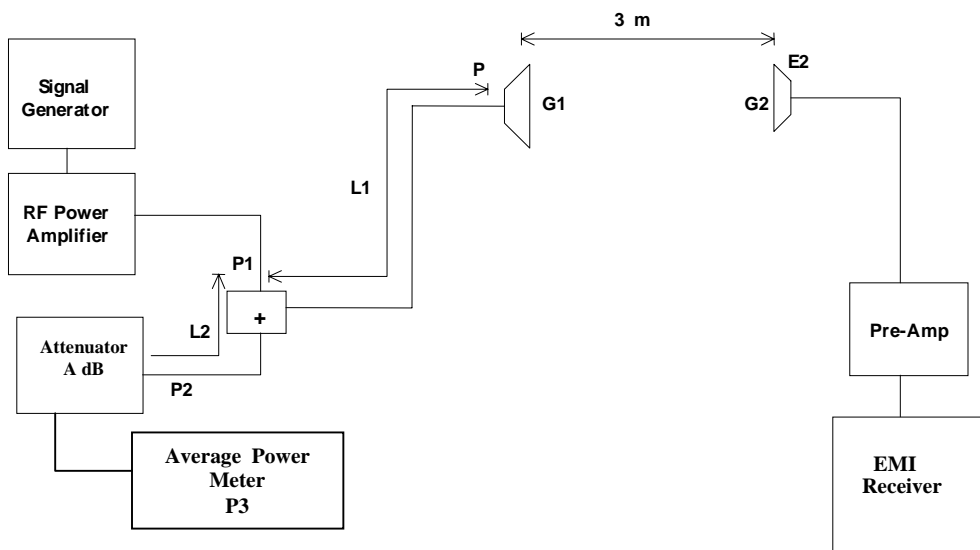

Figure 3



### 8.3. FREQUENCY STABILITY

Refer to FCC @ 2.1055.

- (a) The frequency stability shall be measured with variation of ambient temperature as follows: From -30 to +50 centigrade except that specified in subparagraph (2) & (3) of this paragraph.
- (b) Frequency measurements shall be made at extremes of the specified temperature range and at intervals of not more than 10 centigrade through the range. A period of time sufficient to stabilize all of the components of the oscillator circuit at each temperature level shall be allowed prior to frequency measurement. The short-term transient effects on the frequency of the transmitter due to keying (except for broadcast transmitters) and any heating element cycling normally occurring at each ambient temperature level also shall be shown. Only the portion or portions of the transmitter containing the frequency determining and stability circuitry need be subjected to the temperature variation test.
- (d) The frequency stability supply shall be measured with variation of primary supply voltage as follows:
  - (1) Vary primary supply voltage from 85 to 115 percent of the nominal value for other than hand carried battery equipment.
  - (2) For hand carried, battery powered equipment, reduce primary supply voltage to the battery operating end point which shall be specified by the manufacturer.
  - (3) The supply voltage shall be measured at the input to the cable normally provide with the equipment, or at the power supply terminals if cables are not normally provided. Effects on frequency of transmitter keying (except for broadcast transmitters) and any heating element cycling at the nominal supply voltage and at each extreme also shall be shown.
- (e) When deemed necessary, the Commission may require tests of frequency stability under conditions in addition to those specifically set out in paragraphs (a), (b), (c) and (d) of this section. (For example, measurements showing the effect of proximity to large metal objects, or of various types of antennas, may be required for portable equipment).

## 8.4. EMISSION MASK

**Voice or Digital Modulation Through a Voice Input Port @ 2.1049(c)(i):**- The transmitter was modulated by a 2.5 KHz tone signal at an input level 16 dB greater than that required to produce 50% modulation (e.g.:  $\pm 2.5$  KHz peak deviation at 1 KHz modulating frequency). The input level was established at the frequency of maximum response of the audio modulating circuit.

**Digital Modulation Through a Data Input Port @ 2.1049(h):**- Transmitters employing digital modulation techniques - when modulated by an input signal such that its amplitude and symbol rate represent the maximum rated conditions under which the equipment will be operated. The signal shall be applied through any filter networks, pseudo-random generators or other devices required in normal service. Additionally, the Emission Masks shall be shown for operation with any devices used for modifying the spectrum when such devices are operational at the discretion of the user.

The following EMI Receiver bandwidth shall be used for measurement of Emission Mask/Out-of-Band Emission Measurements:

- (1) For 25 kHz Channel Spacing: RBW = 300 Hz
- (2) For 12.5 kHz or 6.25 kHz Channel Spacings: RBW = 100 Hz

The all cases the Video Bandwidth shall be equal or greater than the measuring bandwidth.

## 8.5. SPURIOUS EMISSIONS (CONDUCTED)

With transmitter modulation characteristics described in Out-of-Band Emissions measurements @ 2.1049, the transmitter spurious and harmonic emissions were scanned. The spurious and harmonic emissions were measured with the EMI Receiver controls set as RBW = 30 kHz minimum , VBW  $\geq$  RBW and SWEEP TIME = AUTO). The transmitter was operated at a full rated power output, and modulated as follows:

**FCC CFR 47, Para. 2.1057 - Frequency spectrum to be investigated:** - The spectrum was investigated from the lowest radio generated in the equipment up to at least the 10<sup>th</sup> harmonic of the carrier frequency or to the highest frequency practicable in the present state of the art of measuring techniques, whichever is lower. Particular attention should be paid to harmonics and subharmonics of the carrier frequency. Radiation at the frequencies of multiplier stages should be checked. The amplitude of spurious emissions which are attenuated more than 20 dB below the permissible value need not be reported.

**FCC CFR 47, Para. 2.1051 - Spurious Emissions at Antenna Terminal:** - The radio frequency voltage or powers generated within the equipment and appearing on a spurious frequency shall be checked at the equipment output terminals when properly loaded with a suitable artificial antenna. Curves or equivalent data shall show the magnitude of the harmonic and other spurious emission that can be detected when the equipment is operated under the conditions specified in 2.1049 as appropriate. The magnitude of spurious emissions which are attenuated more than 20 dB below the permissible value need not be specified.

## 8.6. TRANSIENT FREQUENCY BEHAVIOR

1. Connect the transmitter under tests as shown in the above block diagram
2. Set the signal generator to the assigned frequency and modulate with a 1 kHz tone at  $\pm 12.5$  kHz deviation and its output level to be 50 dB below the transmitter rf output at the test receiver end.
3. Set the horizontal sweep rate on the storage scope to 10 milliseconds per division and adjust the display to continuously view the 1000 Hz tone from the Demodulator Output Port (DOP) of the Test Receiver. Adjust the vertical scale amplitude control of the scope to display the 1000 Hz at  $\pm 4$  divisions vertical Center at the display.
4. Adjust the scope so it will trigger on an increasing magnitude from the RF trigger signal of the transmitter under test when the transmitter was turned on. Set the controls to store the display.
5. The output at the DOP, due to the change in the ratio of the power between the signal generator input power and transmitter output power will, because of the capture effect of the test receiver, produce a change in display: For the first part of the sweep it will show the 1 kHz test signal. Then once the receiver's demodulator has been captured by the transmitter power, the display will show the frequency difference from the assigned frequency to the actual transmitter frequency versus time. The instant when the 1 kHz test signal is completely suppressed (including any capture time due to phasing) is considered to be  $t_{on}$ . The trace should be maintained within the allowed divisions during the period  $t_1$  and  $t_2$ .
6. During the time from the end of  $t_2$  to the beginning of  $t_3$  the frequency difference should not exceed the limits set by the FCC in Part 90.214 and the outlined in the Carrier Frequency Stability sections. The allowed limit is equal to FCC frequency tolerance limits specified in FCC 90.213.
7. Repeat the above steps when the transmitter was turned off for measuring  $t_3$ .